

MAKING MODERN LIVING POSSIBLE

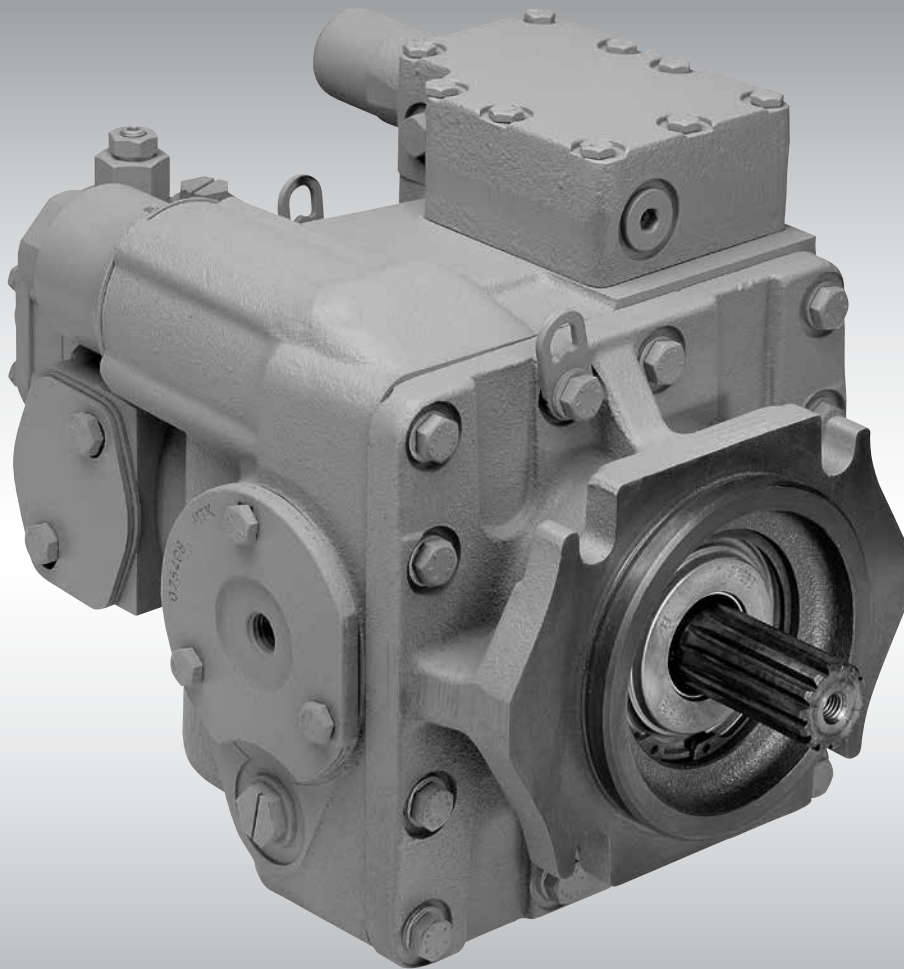

Service Manual and Repair Instructions  
**Axial Piston Pumps**  
**Series 20**



**General Description****Introduction**

The purpose of this manual is to provide you with the information necessary for the normal maintenance and servicing of the Danfoss hydrostatic series 20 units. This includes a description of the units and their components as well as troubleshooting, pressure setting and repair procedures. Minor repairs may be performed without affecting the warranty. Major repairs performed during the warranty time could eventually affect the warranty. To facilitate easy servicing, the unit has been designed with this in mind. Many of the individual parts and assemblies are interchangeable throughout the entire series 20 family. This includes such items as the servo valve, the charge pumps and the manifold components. In addition, many repairs and adjustments can be performed without having to remove the unit from the vehicle, provided that the unit is easily accessible and a thorough cleaning of the unit is possible before beginning with repairs. Dirt or other forms of contamination are in most cases the reason for the breakdown of a hydraulic unit. Please pay attention to cleanliness, not only when making repairs, but also when putting the unit into operation, changing the oil, changing filters or any other procedures. The following manual will provide you with comprehensive instructions for preventative maintenance and recognition of causes of failure of the axial-piston units.

**Description**

Danfoss axial piston variable displacement pumps are of swash plate design with variable flow capability suitable for hydrostatic transmissions with closed loop circuit. Tilting the swash plate to the opposite side of the neutral or zero displacement position reverses flow direction. The full-length shaft with a highly efficient tapered roller bearing arrangement offers a high loading capacity for external radical forces. The hydro-mechanical servo displacement control maintains the selected swash plate position and hence pumps displacement. Upon release of the control handle, the swash plate automatically returns to zero position and the flow reduces to zero. High case pressures can be achieved without leakage even at the lowest temperatures by using suitable shaft seals. The servo valve arrangement offers the facility to incorporate function regulators and remote control systems. Axial piston units are designed for easy servicing. Complete dismantling and reassembly can be carried out with standard hand tools, and all components or sub-assemblies are replaceable.

**Contents**

<b>Model Code</b>	Model Code.....	4
<b>Recommended Tools and Installation</b>	Tools for Minor Repairs and Unit Maintenance .....	5
	Additional Tools for Complete Stripping of Units.....	5
	Measurement Instruments.....	5
	Trouble Shooting, Gauge Installation and Information.....	6
<b>Start-up procedure</b>	Preconditions for Trouble-free Operation.....	7
	First-time Operation.....	8
	Plumbing Installation (Variable Displacement Pump - Fixed Displacement Motor) .....	10
	System circuit Description.....	10
<b>System Maintenance</b>	Inlet Filter .....	11
	Changing the oil.....	11
	Leak Test.....	11
	Cleanliness.....	11
	Checking the oil level.....	11
	Recommended oils.....	11
<b>Trouble Shooting</b>	Transmission Operates in one Direction Only.....	12
	System response is sluggish .....	12
	Neutral Difficult or Impossible to Find.....	13
	System will not Operate in either Direction.....	13
	Inspection Instructions .....	14
	Checking the servo valve (control valve) .....	15
<b>Disassembly and Assembly</b>	Sectional View.....	16
	Axial piston variable displacement pump.....	16
	Exploded View .....	17
	Minor repairs.....	18
	Mounting block .....	18
	Changing the shaft seal (disassembly).....	19
	Changing the shaft seal (assembly) .....	20
	Changing the charge pump and the charge check valves.....	21
	Changing the servo valve (control valve).....	23
	Major repairs.....	24
	Changing the valve- and bearing plate (disassembly) .....	24
	Changing the valve- and bearing plate (assembly) .....	25
	Changing the cylinder block kit (disassembly).....	27
	Changing the cylinder block kit (assembly).....	28
	Changing the swash plate and servo piston (disassembly) .....	29
	Changing the swash plate and servo piston (assembly) .....	31
	Changing the pump shaft .....	33
	Installation Torque Values.....	35



**Recommended Tools and  
Installation**
**Tools for Minor Repairs and  
Unit Maintenance**

- 1 Circlip pliers  $\varnothing$  2 to 2.5 mm
- 1 Screw driver 3 mm
- 1 Screw driver 6 mm
- 1 Screw driver 9 mm
- 1 Plastic hammer - small
- 1 Pointed pliers (can also be slightly bent)
- 1 Torque key to 14.9 Nm [132 lbf·inch]
- 1 Set of ring spanners  $\frac{5}{16}$  to  $1\frac{1}{4}$
- 1 Set of Allenkeys  $\frac{1}{4}$  to  $\frac{3}{8}$
- 1 Fixed spanner  $1\frac{5}{6}$  for high pressure relief valve
- 1 Puller retainer seal

**Additional Tools for  
Complete Stripping of Units**

(Major repairs should not be carried out during the warranty period.)

- 1 Right angle screw driver 16 mm
- 1 Set of drifts 2 to 10 mm
- 1 Plastic hammer - large
- 1 Bearing puller 80 x 120 mm
- 1 Bearing puller 200 x 250 mm
- 1 Each fixed spanner for servo cylinder 36, 41, 46, 50, 55, 60, 65 mm
- 1 Depth gauge 300 mm
- 1 Set of fixed or open ended spanners  $\frac{7}{16}$  to  $1\frac{1}{4}$
- 1 Fitting block - see *page 14*

**Measurement Instruments**

- At least 2 pressure gauges up to 60 bar damped (charge pressure - servo pressure)
- 1 Vacuum gauge to +1.0 ÷ -1.0 bar [14.5 ÷ -14.5 psi] (vacuum measurement at the charge pump)
  - 2 Pressure gauges to 600 bar [8700 psi] (high pressure measurement at the valve block)
  - 1 Pressure gauge to 8 bar [116 psi] (casing pressure measurement)
- Additional: Torque spanners, separate order!

**Recommended Tools and  
Installation**

**Trouble Shooting, Gauge  
Installation and Information**

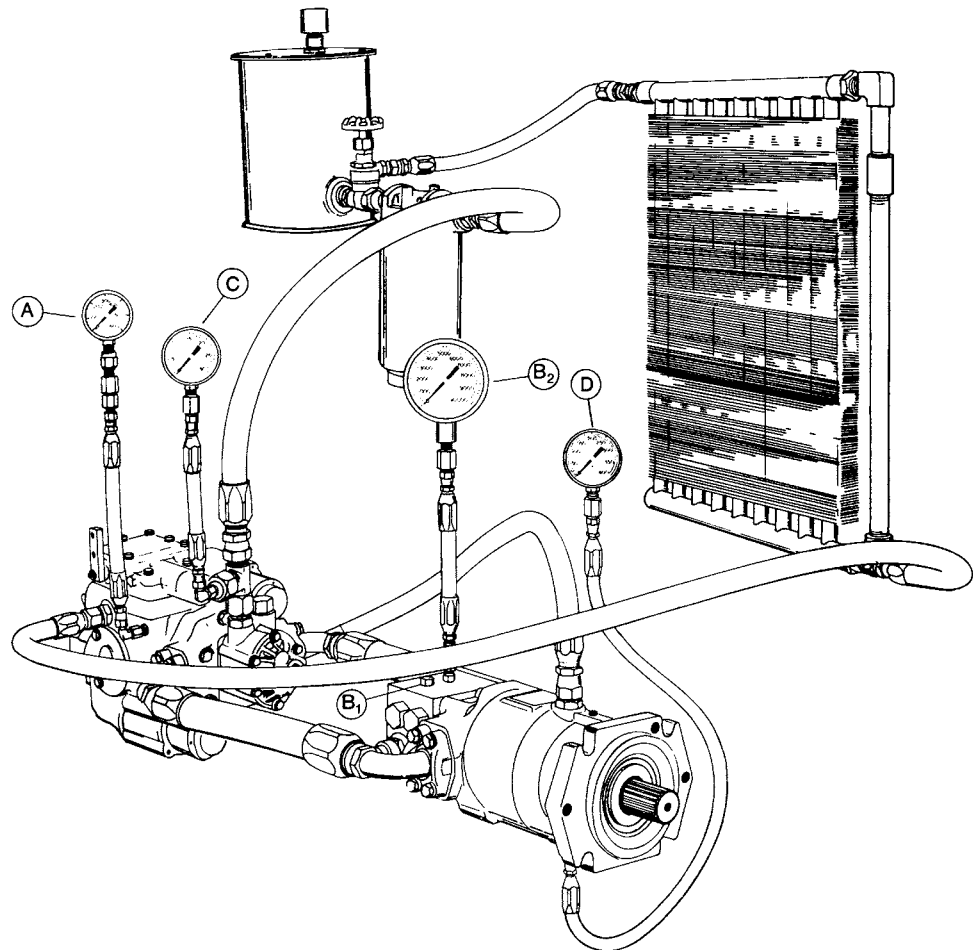

*Gauge Information*

<b>A</b>	<b>Charge Pressure</b>	60 bar [870 psi] - Gauge	7/16 - 20 UNF O-ring Fitting
<b>B</b>	<b>System pressure</b>	600 bar [8700 psi] - Gauge	7/16 - 20 UNF O-ring Fitting
<b>C</b>	<b>Inlet Vacuum</b>	Vacuum gauge	Tree Into Inlet Line
<b>D</b>	<b>Case pressure</b>	8 bar [116 psi] - Gauge	Adapt to Bottom Drain Port

**Start-up procedure****Preconditions for Trouble-free Operation**

**Cleanliness:** Ensure that the pipes, pipe connections and hoses as well as all other components are completely clean.

**Ventilation and venting of the oil reservoir** via an air filter.

**Operating fluid:** HLP fluid according to DIN 51524, ATF type A SUFFIX A, HD-SAE motor oils, see [Fluid Manufacturers, Technical Information](#).

**Oil level:** (The inlet pipe and return flow port must always be below the surface of the oil). No funnel-shaped eddying at the inlet connection pipe. No formation of foam at the return flow pipe. The inlet connection pipe must be substantially above the bottom of the reservoir. A partition plate should be located between the inlet and return flow connection pipes.

**Filtration**

Filtration grade = 10 µm [394 µinch] nominal.

**Inlet pressure of charge pump:** 0.85 bar [12.3 psi] absolute (- 0.15 bar [-2.2 psi]) with a new filter element and at an operating temperature of approx. 50 °C [122 °F].

A charge pump inlet pressure less than 0.75 bar [10.9 psi] absolute (-0.25 bar [-3.6 psi]) is permissible for a short time with a reservoir temperature of less than 50 °C [122 °F] on a cold start in order to warm up the system under no-load.

If frequent cold starts are to be made, the system should be warmed up by a reservoir heater. If the charge pump inlet pressure is less than 0.75 bar [10.9 psi] absolute (-0.25 bar [-3.6 psi]) on operating temperatures higher than 50 °C [122 °F], **the filters must be changed.**

A charge pump inlet pressure of less than 0.5 bar [7.3 psi] absolute (- 0.5 bar [-7.3 psi]) is not permissible.

**The filter requires changing or the operating temperature is too low.**

**Venting** the pump and motor housing as well as the connection lines and other components. The return flow to the oil reservoir must be free of bubbles. After venting the system, check the fluid level and fill to proper level if necessary.

**Carry out a leak test** on the transmission (inlet line, filter, pipe and hose lines, valves, control elements, pump and motor) giving due consideration to the service life of the transmission, environmental protection and the reduction of oil consumption. Tighten up any leaking joints and other connections while the system is not under pressure.

**Pressure fluid temperature range:** min. = -40 °C [-40 °F], max. = 95 °C [203 °F].

**Viscosity range:**

max. = 1000 mm<sup>2</sup>/s [4630 SUS\*] (cSt) (for a short time only on a cold start).

min. = 7 mm<sup>2</sup>/s [49 SUS\*] (cSt).

Recommended viscosity range: 12-60 mm<sup>2</sup>/s [66-278 SUS\*] (cSt).

\*SUS (Saybolt Universal Second)

**Changing the oil:** The oil should be changed after max. 80-100 hours of operation, but at the latest one year after first-time operation.

The second oil change should be after max. 500 hours of operation but at the latest one year after the first change of fluid.

Thereafter, the oil should be changed every 1000 hours of operation but at least once a year. It is not permissible to mix oil.

**Renew the inlet filter** each time the oil is changed or when the inlet pressure of the charge pump falls below the permissible tolerance.

**Clean the air filter** whenever too much dirt has accumulated.

**The max. speed** is as specified in the catalogue [Series 20 Axial Piston Pumps, Technical Information](#) or [Series 20 Axial Piston Motors, Technical Information](#).

**Start-up procedure**

**Preconditions for Trouble-free Operation (continued)**

**The charge pressure** measured at the charge pressure gauge connection port of the pump with the adjusting lever in the neutral position should be approx. 15 bar [217.6 psi] at a pump input speed  $n = 1500 \text{ min}^{-1}$  (rpm).

The charge pressure measured at the charge pressure gauge connection port of the pump with the adjusting lever engaged should be approx. 2 bar lower at a pump input speed  $n = 1500 \text{ min}^{-1}$  (rpm).

**First-time Operation**

1. After installing the transmission and the corresponding pipeline connections, remove the plug from the charge pressure gauge port of the variable displacement pump. Fit a gauge with a measuring range up to 60 bar [870 psi] to this port.  
The charge pressure gauge port has a straight 7/16-20 UNF-2 B SAE thread.
2. Disconnect the charge pump inlet line from the charge pump inlet connection pipe.
3. Fill the pump case and the motor case with the recommended oil through the drain port.
4. Fill the oil reservoir with fluid. As soon as oil emerges from the end of the disconnected charge pump inlet line tighten the pipe connector (see *table to page 35* for the correct tightening torque) and continue to fill the reservoir.  
Only use oil reservoirs that are fitted with air filters.
5. Disconnect the control linkage from the control handle.  
**The pump must be in the zero position.**
6. Allow the prime mover to turn for approx. 15 sec. by using the starter.  
If the prime mover is an electric motor: Switch on and off again.
7. Then start the prime mover and allow the pump to turn at idling speed (approx.  $750 \text{ min}^{-1}$ ) for approx. 5 minutes.  
In the case of electric prime mover: **Allow to turn for approx. 1 minute.**  
After initial fluctuations in pressure, the charge pressure should settle down to 10 bar [145 psi] or 12 bar [174 psi].
8. Check the pressure fluid level.
9. Raise the speed to approx.  $1500 \text{ min}^{-1}$  (rpm). The gauge should now indicate a pressure of approx. 15 bar [217.6 psi].
10. If the charge pressure falls to below 8 bar [116 psi], stop the prime mover, find the fault in accordance with the trouble-shooting guide and take the appropriate remedial action.



**Start-up procedure**
**First-time Operation  
(continued)**

11. Stop the prime mover and attach the control linkage to the control handle. Check the fluid level in the sight glass and fill to proper level if necessary.
12. Restart the prime mover and, under no-load, adjust the zero position by means of the control handle - or even better by the control linkage - so that in both directions final position of stroke per *Series 20 Axial Piston Pumps, Technical Information* is achieved.
13. Allow the prime mover to turn at  $1500 \text{ min}^{-1}$  (rpm). The charge pressure should now be 15 bar [217.6 psi].
14. Slowly move the control handle backwards and forwards. If the pump is working properly, the charge pressure drops by about 2 bar [29 psi] from the value stated in step 13 above as the control handle initiated.
15. Allow the system to work under full load with a pump speed of approx.  $1500 \text{ min}^{-1}$  (rpm). It must be possible to achieve the values stated in steps 13 and 14 above.
16. Check all joints and connections for leaks.
17. Stop the prime mover. Remove the gauge from the connection port. Replace the 7/16-20 UNF-2 B plug and tighten with the tightening torque stated in the table to page 35. Check the pressure fluid level in sight glass of the reservoir and fill to proper level if necessary.  
**The system is now ready for operation.**

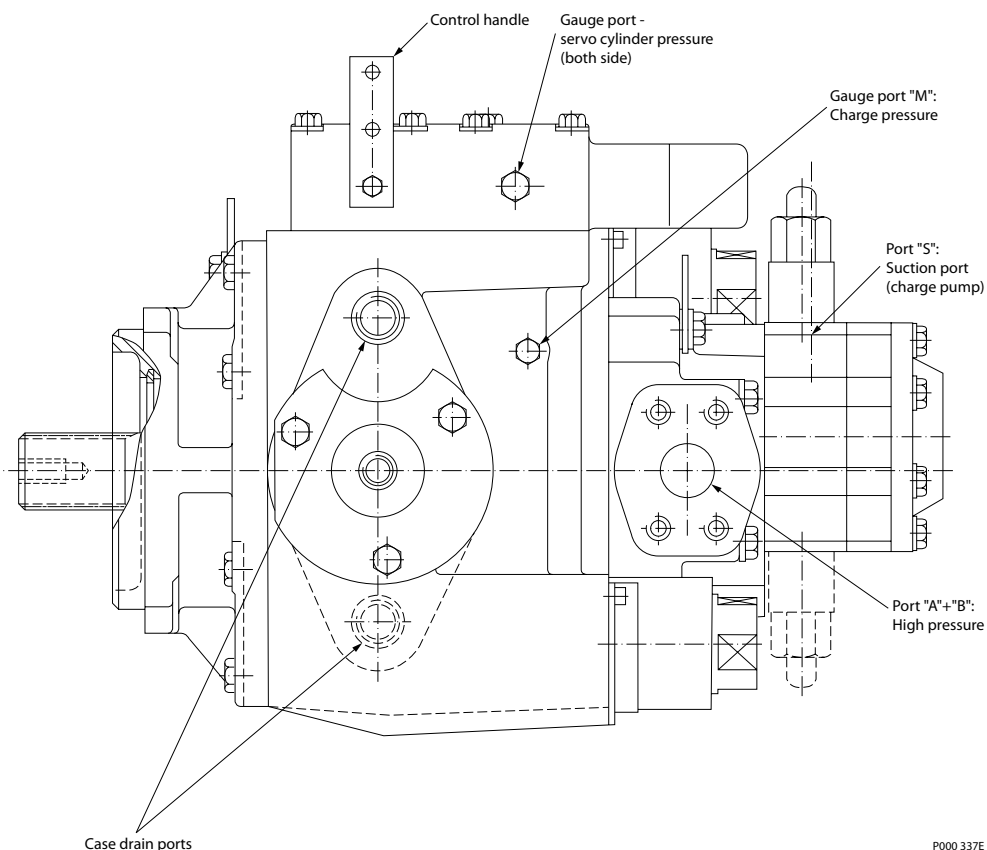

P000 337E

**Start-up procedure**

**Plumbing Installation  
(Variable Displacement  
Pump – Fixed Displacement  
Motor)**

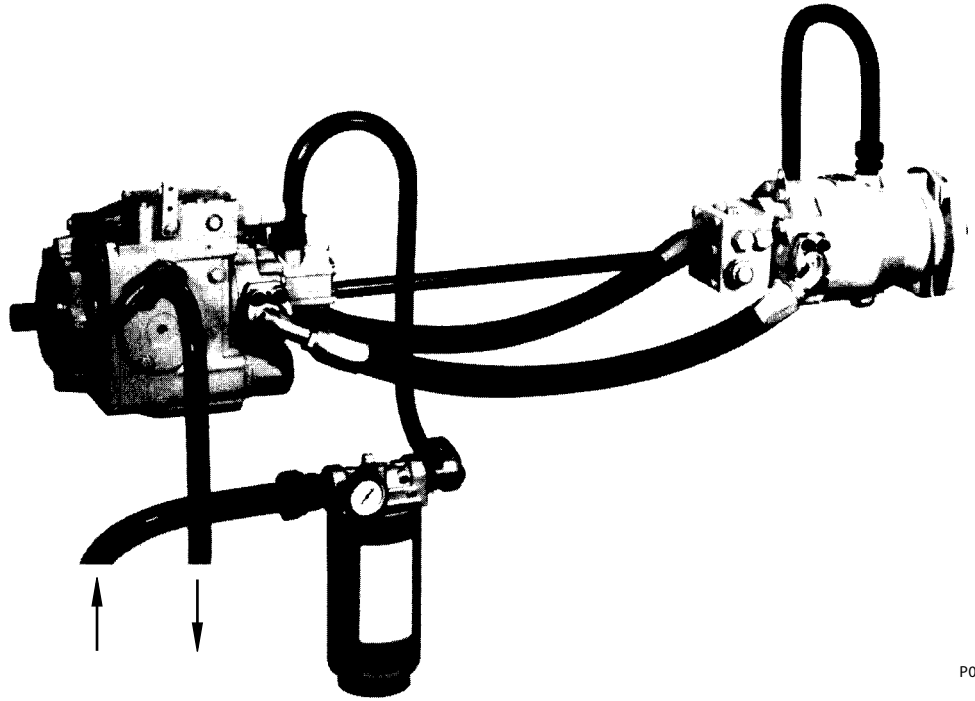

P000 341

**System circuit Description**

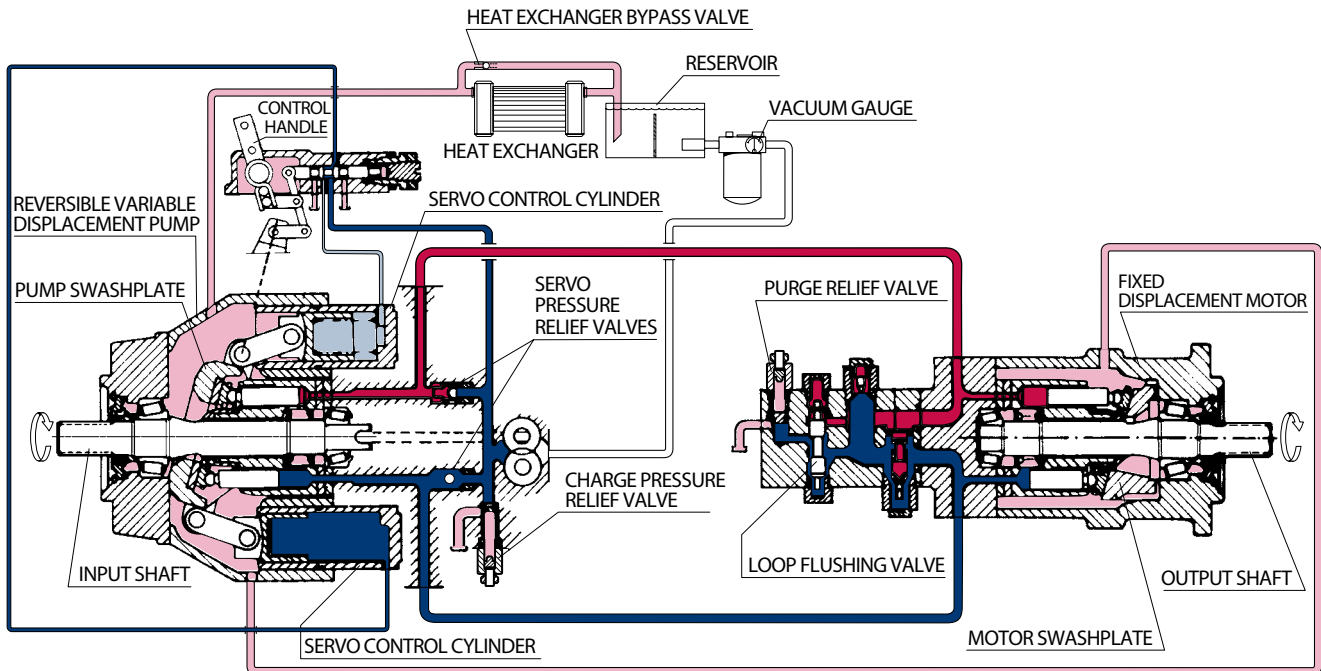

■ WORKING LOOP (HIGH PRESSURE)  
 ■ WORKING LOOP (LOW PRESSURE)  
 ■ CONTROL FLUID  
  SUCTION LINE  
 ■ CASE DRAIN FLUID

P000 027E

**System Maintenance****Inlet Filter**

The filter element must be exchanged as soon as the pressure drops below 0.75 bar [10.9 psi] absolute (-0.25 bar [-3.6 psi]) when the transmission is at normal operating temperature. The filter must also be exchanged each time the pressure fluid is changed. Filtration grade = 10 µm [394 µinch] nominal.

**Changing the oil**

Under normal operating conditions, the oil should be changed at the following intervals: The first oil change should be carried out after max. 80-100 hours of operation but at the latest one year after first-time operation. The second change should take place after max. 500 hours of operation but at the latest one year after the first change.

Thereafter, the oil should be changed at least every 1000 hours of operation or at least once a year. To change the oil, the used fluid must be drained off when the system is at operating temperature! Remove any residual dirt or sludge from the reservoir!

In extremely dusty atmospheres, the intervals between oil changes must be correspondingly shortened.

Oil samples should be taken every 500 hours of operation. To do this, take approx. 0.5l of oil from a point on a level with the inlet (suction) connection. Fill the sample into a closable container that is free of residues.

Have the oil examined for serviceability by Danfoss, by Oil Manufacturer or by an appropriate institution.

**Important:** Use only recommended oils! (See [Fluid Manufacturers, Technical Information](#).) It is not permissible to mix oils.

**Leak Test**

Carry out a leak test on the transmission (inlet line, filter, pipe and hose lines and connections, valves, control elements, pump and motor) giving due consideration to the service life of the transmission, environmental protection and reduction of oil consumption.

Tighten up any leaking joint and other connections while the system is not under pressure.

**Cleanliness**

Make certain that the air filter for ventilation of the oil reservoir is regularly cleaned, since the input pressure may be affected if it is dirty. If there is an oil cooler, the cooler surface should be kept free from contamination. On units which have hose couplings on the connecting pipes, contamination of any sort must be avoided. Cotton rags or lint cleaning cloths may not be used for cleaning. Use only lint-free materials.

When changing the oil, be sure the area around the filler cap is free from foreign objects. The oil, which can be kept clean by using a filter cloth, should be added by means of a clean funnel.

**Checking the oil level**

The level of the oil should be checked daily using the gauge glass. In case of loss of oil, the leak must be rectified.

**Important:** Use only recommended fluids! (See [Fluid Manufacturers, Technical Information](#).) It is not permissible to mix.

**Recommended oils**

HLP - hydraulic fluids according to DIN 51524  
ATF - automatic transmission fluids type A, SUFFIX A  
HD - SAE motor oils

**Troubleshooting**

**Transmission Operates in one Direction Only**

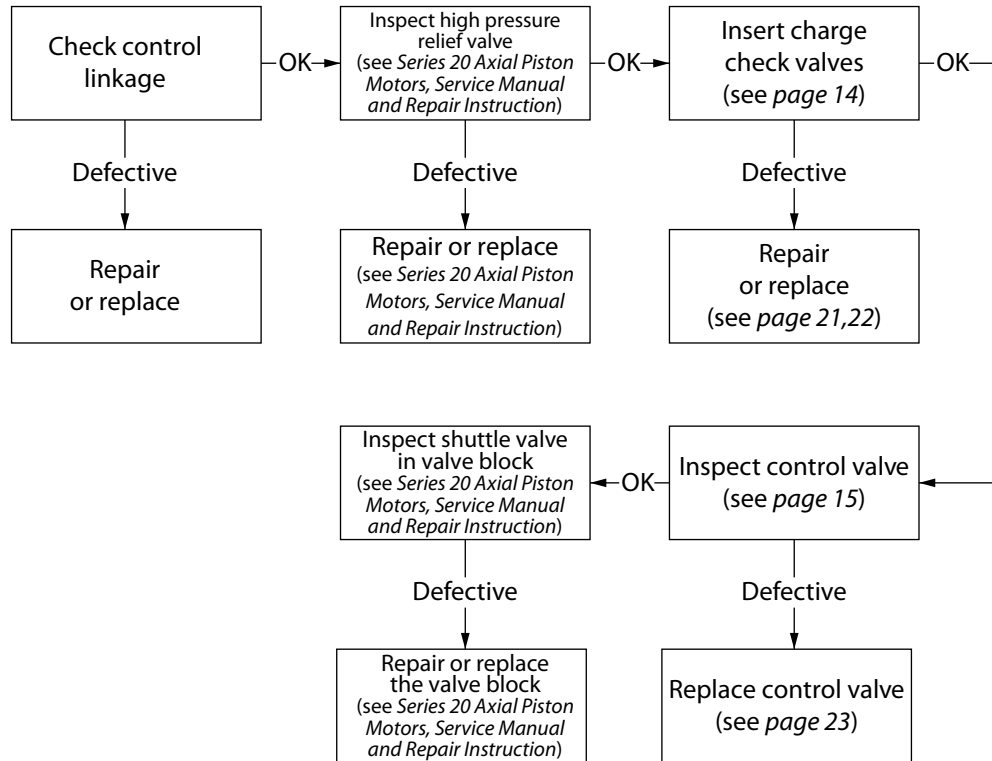

**System response is sluggish**

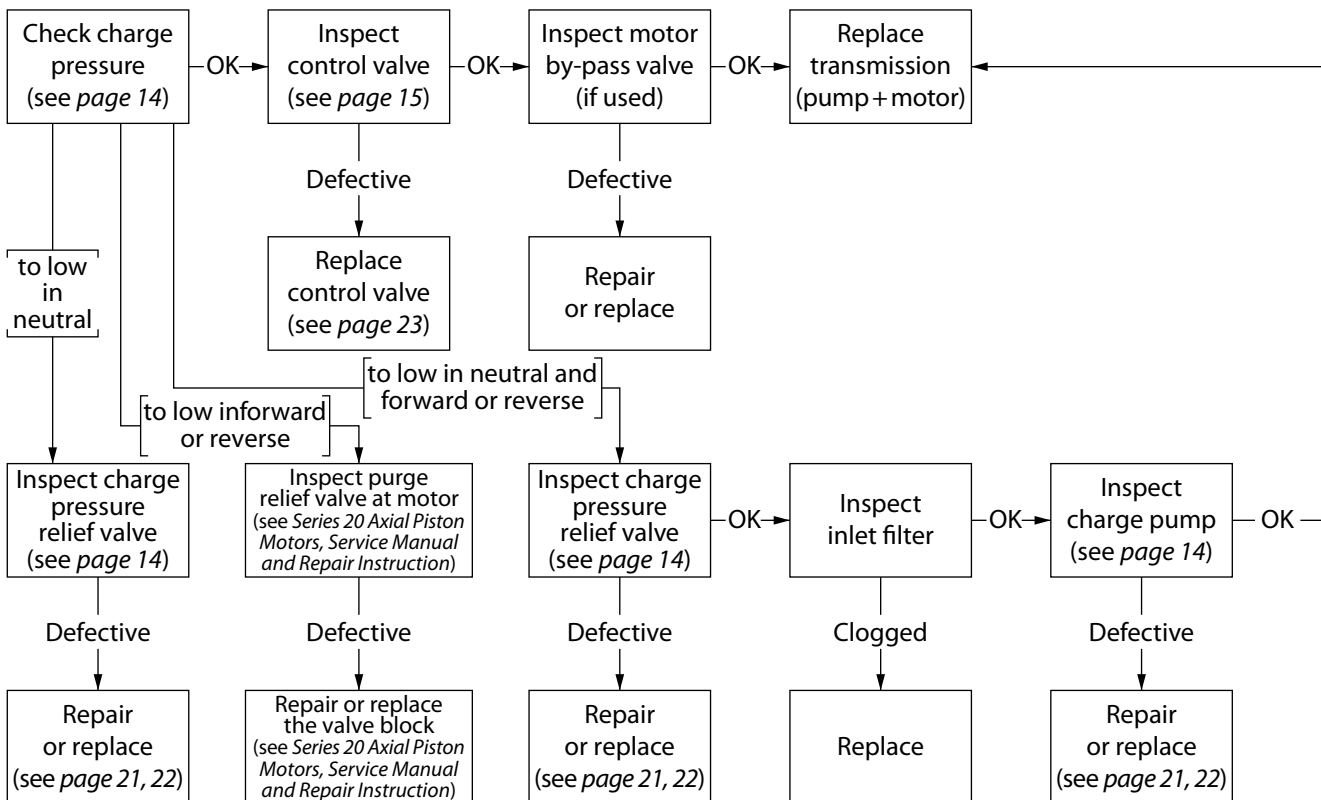

**Troubleshooting**

**Neutral Difficult or Impossible to Find**

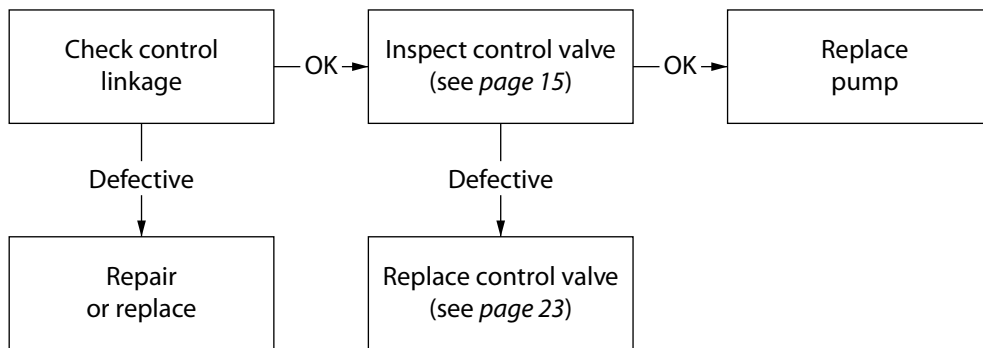

**System will not Operate in either Direction**

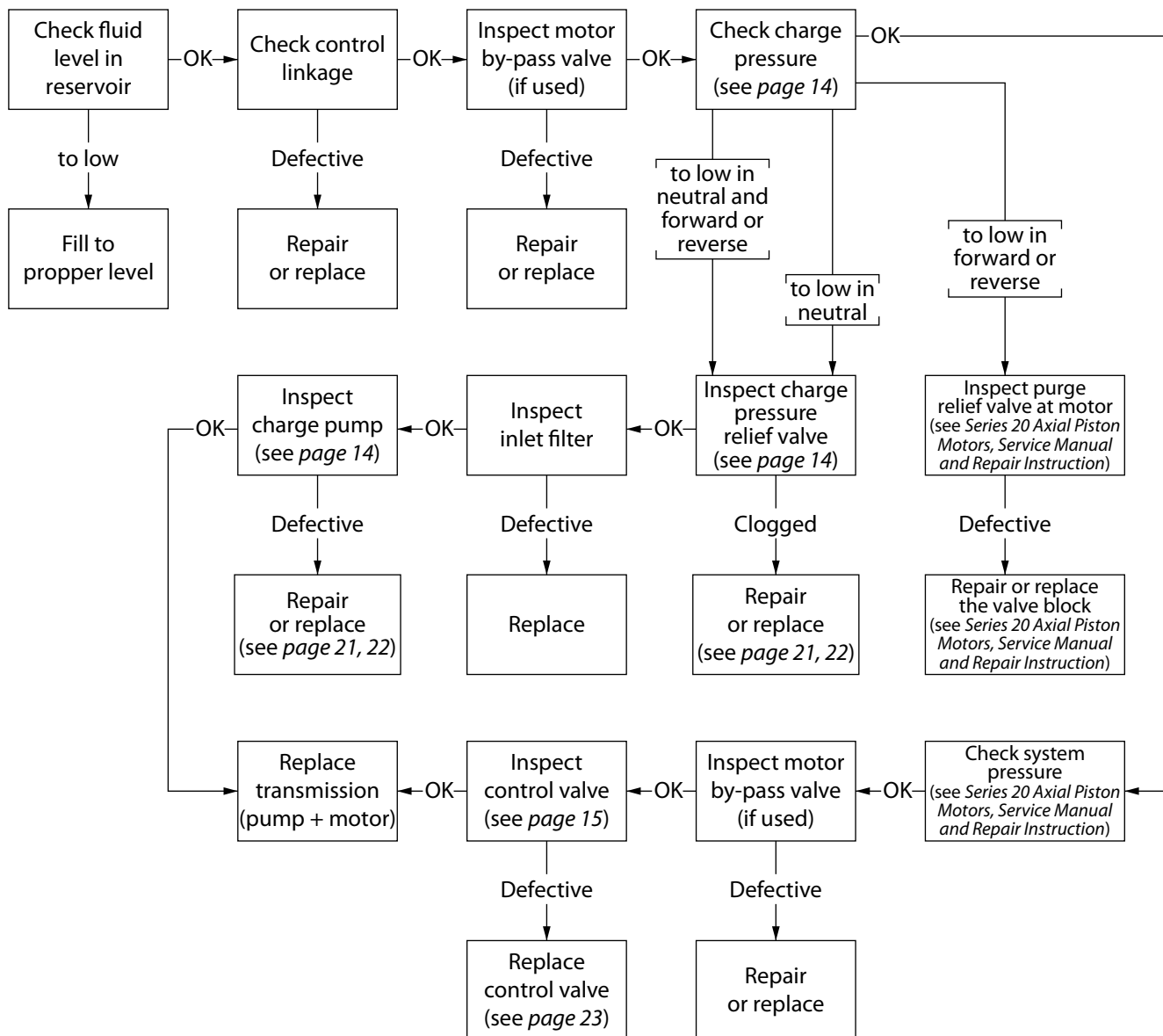

**Troubleshooting**

**Inspection Instructions**

**Checking the charge pressure**

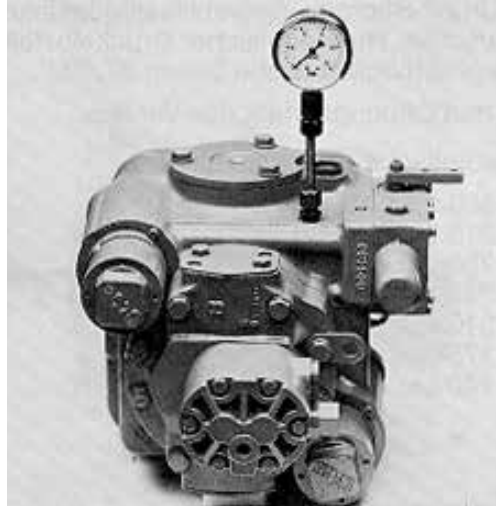

F000 077

1. Clean the charge pressure gauge connection on the pump.
2. Pressure gauge (see recommended measuring instruments) to be connected.
3. Set operating speed at 1500 min<sup>-1</sup>
4. Charge pressure with the pump in neutral ca. 15 - 18 bar [218 - 261 psi]. When the pump in forward or reverse the charge pressure should be at a two bar lower level (purge relief valve, motor).

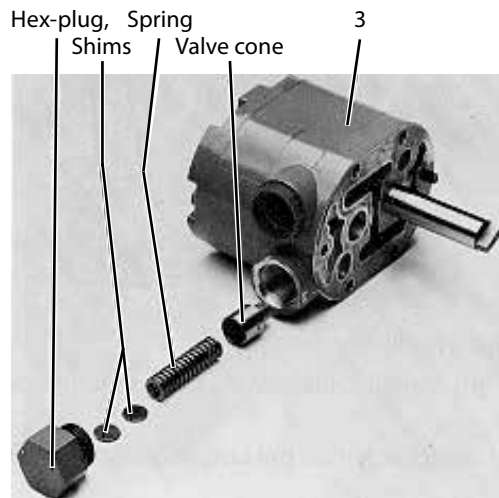

F000 078

1. Inspect if contamination is holding the valve open and for galling or wear on valve cone and seat and inspect for broken spring.
2. The shaft and gear teeth must work freely.
3. Further disassembly of the charge pump is not permitted.

**Checking the charge check valves**

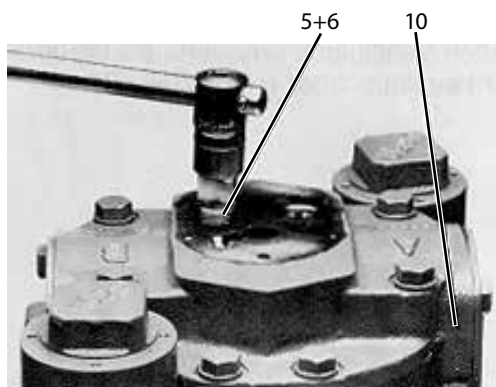

F000 079

1. Remove charge pump to examine check valves (see page 21).

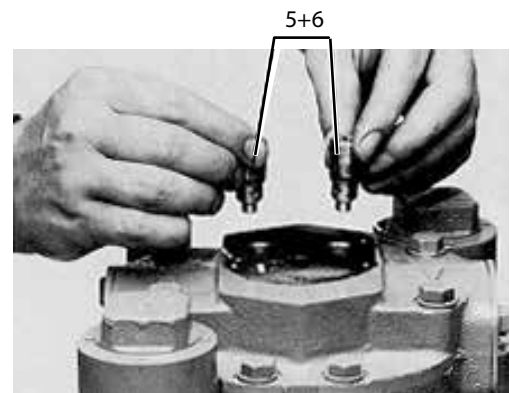

F000 080

2. Check the spring pressure and for correct operations. Check if contamination may be prohibiting free movement of the ball.

**Trouble Shooting**

**Inspection Instructions  
(continued)**

**Checking the servo valve (control valve)**

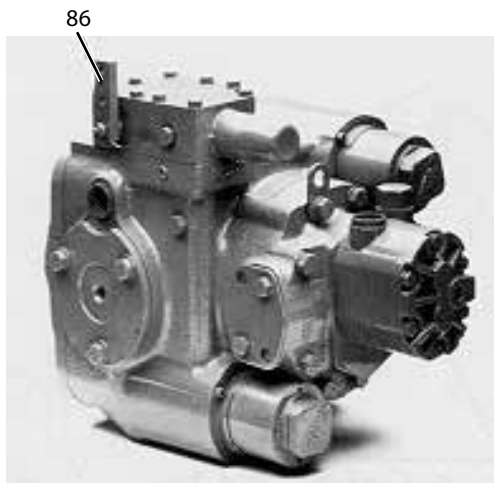

F000 082

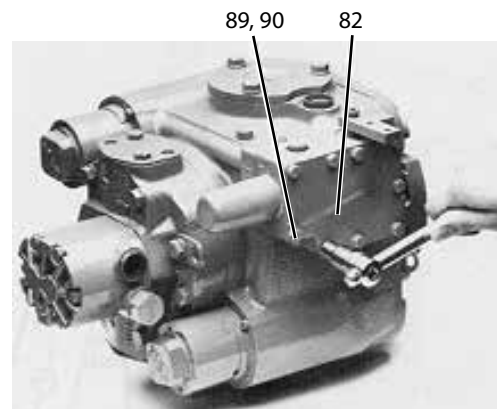

F000 083

1. Disconnect the external control linkage from the control handle and check for neutral operating with control handle. Releasing control handle should allow the pump to return to neutral. If operation is satisfactory with external control linkage disconnected, the problem is not in the hydrostatic transmission. If operation is not satisfactory with external control linkage disconnected from control handle, the control may be misadjusted.

2. Remove the cap screws (see page 22).

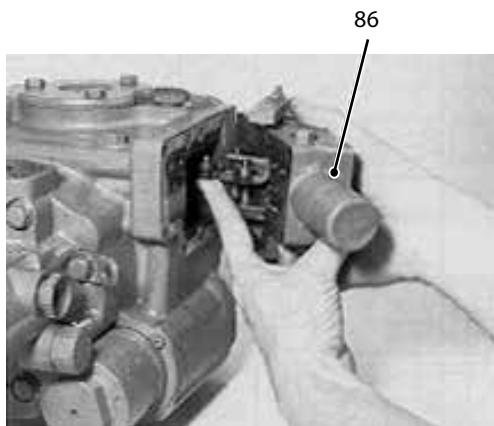

F000 046

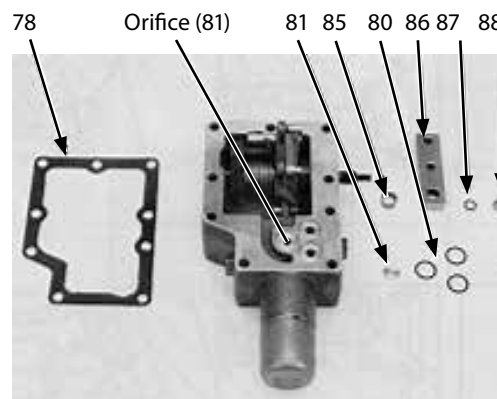

F000 062

3. Holding the control in place, and swing it away from housing and remove. Inspect visible linkages, torsion spring, and O-rings. Inspect for missing, plugged, or incorrect orifice.

4. Further disassembly of servo valve is not permitted.

**Disassembly and Assembly**

**Sectional View**

**Axial piston variable displacement pump**

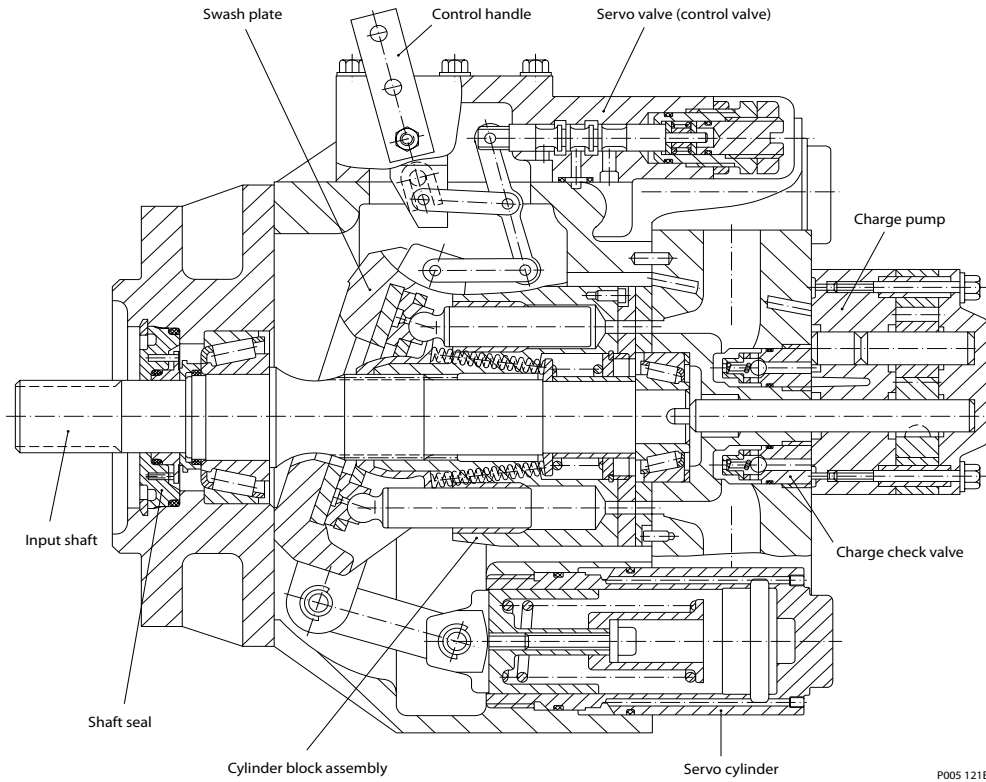



**Disassembly and Assembly**

**Exploded View**

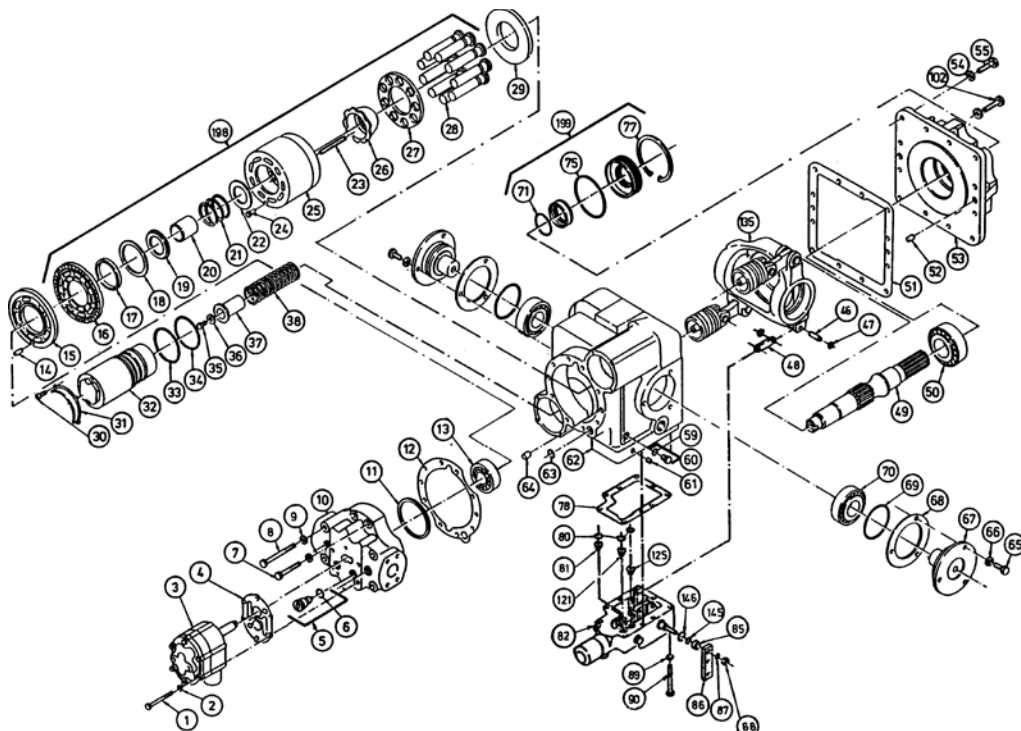

P005 113

**Description of parts:**

- |                             |                          |                          |
|-----------------------------|--------------------------|--------------------------|
| 1 Hexagonal screw           | 28 Piston assembly       | 65 Hexagonal screw       |
| 2 Washer                    | 29 Thrust plate          | 66 Washer                |
| 3 Charge pump assembly      | 30 Screw                 | 67 Trunnion              |
| 4 Gasket charge pump        | 31 Sleeve retainer       | 68 Shim pack             |
| 5 Valve check               | 32 Servo sleeve complete | 69 O-ring                |
| 6 O-ring                    | 33 O-ring                | 70 Bearing               |
| 7 Hexagonal screw           | 34 O-ring                | 71 O-ring                |
| 8 Hexagonal screw           | 35 Screw                 | 75 O-ring                |
| 9 Washer                    | 36 Washer                | 77 Ring retaining        |
| 10 End cap                  | 37 Spring guide          | 78 Gasket                |
| 11 Shim                     | 38 Servo spring          | 80 O-ring                |
| 12 Gasket                   | 46 Pin                   | 81 Orifice               |
| 13 Bearing                  | 47 Locking washer        | 82 Kit control valve     |
| 14 Cylindrical pin          | 48 Connecting link       | 85 Spacer control servo  |
| 15 Valve plate              | 49 Shaft                 | 86 Handle control handle |
| 16 Bearing plate            | 50 Bearing               | 87 Lock washer tooth     |
| 17 Bearing plate pilot ring | 51 Gasket                | 88 Nut hex               |
| 18 Ring retaining           | 52 Cylindrical pin       | 89 Washer                |
| 19 Retainer spring          | 53 Cover                 | 90 Hexagonal screw       |
| 20 Spring guide             | 54 Washer                | 102 Hexagonal screw      |
| 21 Spring                   | 55 Hexagonal screw       | 121 Orifice              |
| 22 Spring seat              | 59 O-ring                | 125 Orifice              |
| 23 Retainer spring          | 60 Plug                  | 135 Swash plate complete |
| 24 Cylindrical pin          | 61 Expander              | 145 O-ring               |
| 25 Cylinder block           | 62 Housing               | 146 O-ring               |
| 26 Retainer guide           | 63 O-ring                | 198 Cylinder block kit   |
| 27 Slipper retainer         | 64 Cylindrical pin       | 199 Shaft seal kit       |

**Disassembly and Assembly**

**Minor repairs**

The areas of repair indicated may be serviced, following the procedures in this manual, without invalidating the warranty.

**Preparation for assembly**

When using a lifting device, the hooks at the end of the slings, are to be fastened in the rings fitted at the front and rear of the motor body. It is recommended that an mounting block should be used in order to facilitate a professional operation.

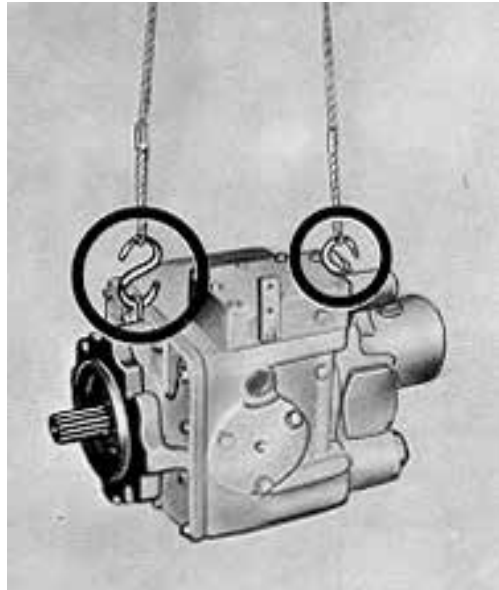

F000 085

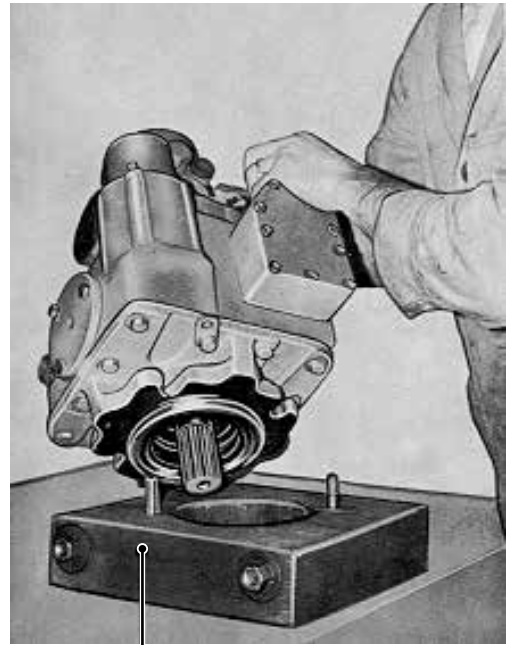

F000 084

**Mounting block**

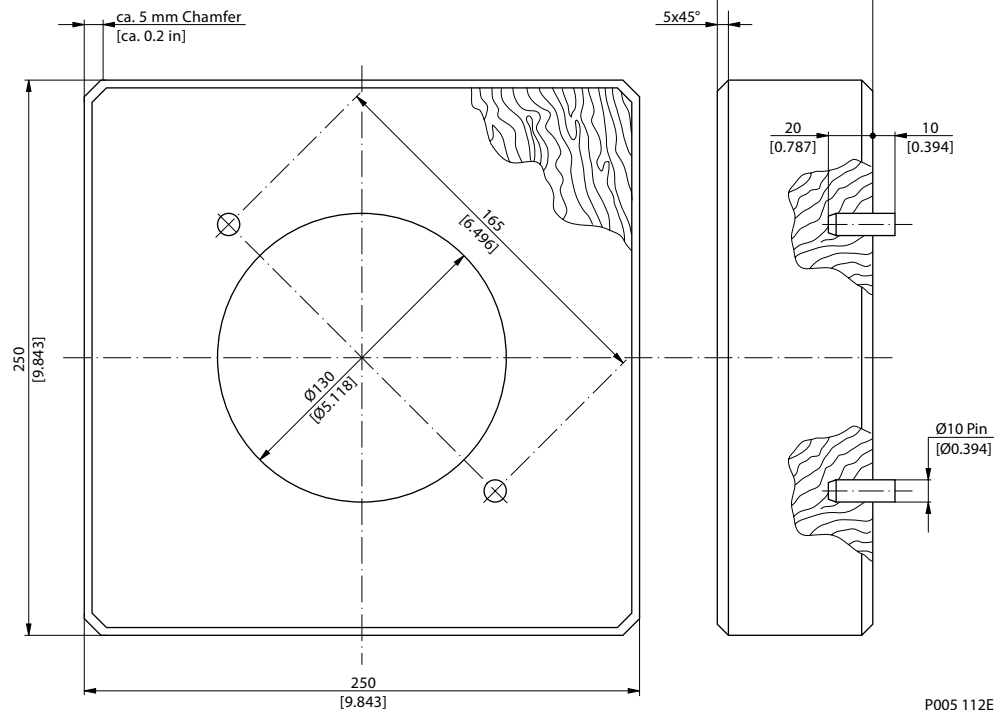

P005 112E

**Disassembly and Assembly**

**Minor repairs  
(continued)**

**Changing the shaft seal (disassembly)**

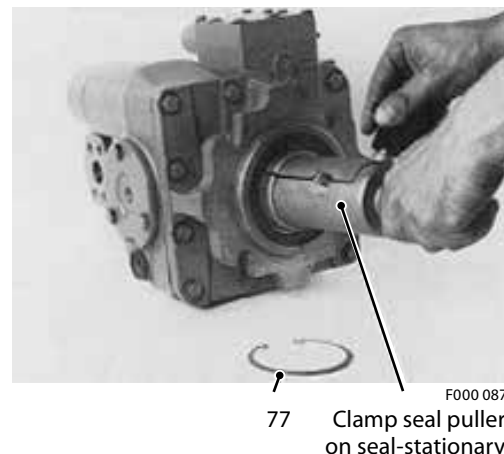
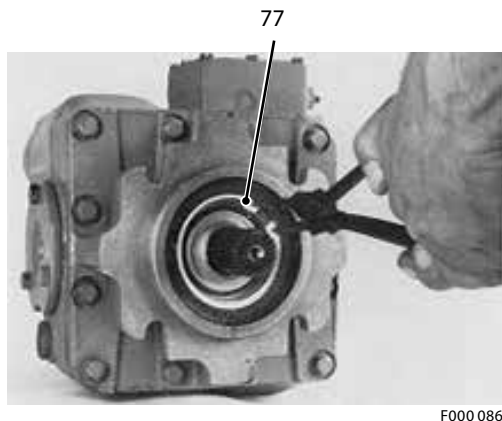

It is recommended that all shaft seal parts be replaced. If parts are to be reused, they must be protected from being damaged by the shaft during removal. Remove the large retaining ring located on the shaft end of the pump. Remove the side opposite the tangs from the groove first.

The seal-stationary is removed next. It is held in place by the friction of the O-ring on its O. D. Remove seal-stationary with the help of a seal puller to prevent damage to outer edge.

**⚠ CAUTION!**

These parts can be easily damaged. Use care in handling. Each part should be inspected separately if parts are to be reused. Always replace the O-rings. Lubricate the small O-ring with petroleum jelly and insert into the I. D. of the bronze rotating ring. Lubricate the large O-ring and place the O. D. of the seal-stationary.

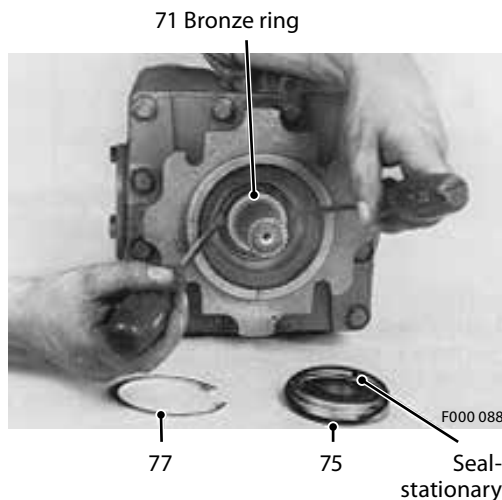

The rotating seal ring (bronze ring) is also held in its position by the O-ring. It can be removed with the help of two screw drivers.

**Disassembly and Assembly**

**Minor repairs  
(continued)**

**Changing the shaft seal (assembly)**

71 Bronze ring

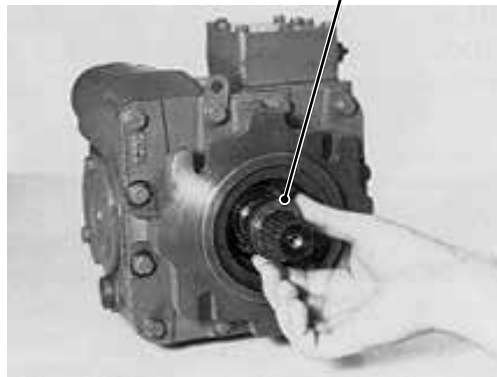

F000 089

Slide the bronze sealing ring over the shaft and onto the shaft pilot diameter with the O-ring facing the unit. Work the ring into place using hand force only.

**⚠ CAUTION!**

**Protect parts from damage by the shaft.**

Seal stationary

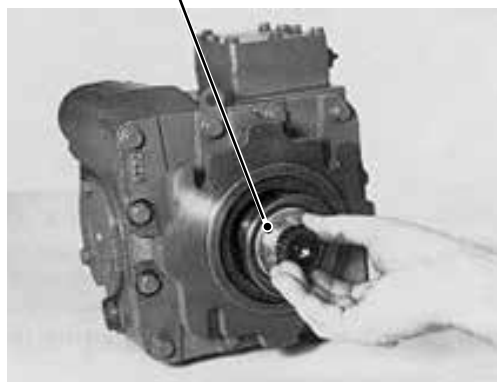

F000 213

Slide seal-stationary into place against the bronze sealing ring.

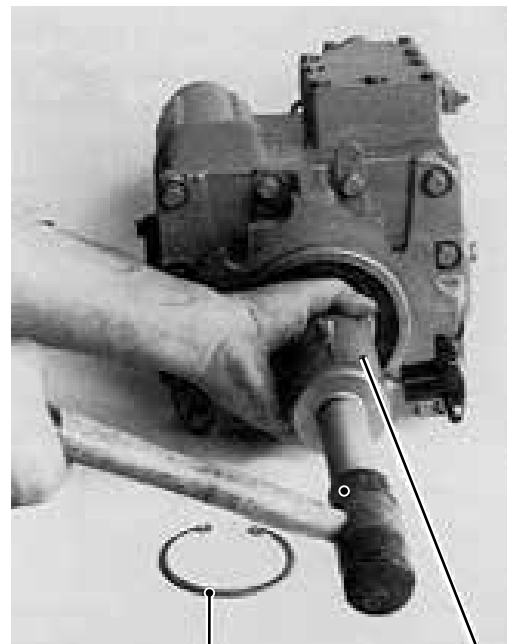

F000 090

77

Clamp seal puller on seal-stationary

77

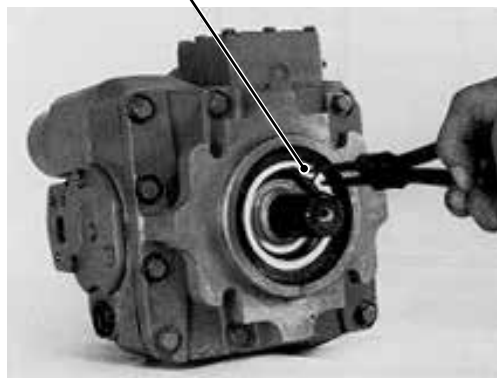

F000 091

Compress the seal-stationary to expose the retaining ring groove. Install the retaining ring with the beveled side out, putting the side opposite the tangs into the groove first. Be certain that the retaining ring has snapped into the groove completely.

**Disassembly and Assembly**

**Minor repairs  
(continued)**

**Changing the charge pump and the charge check valves**

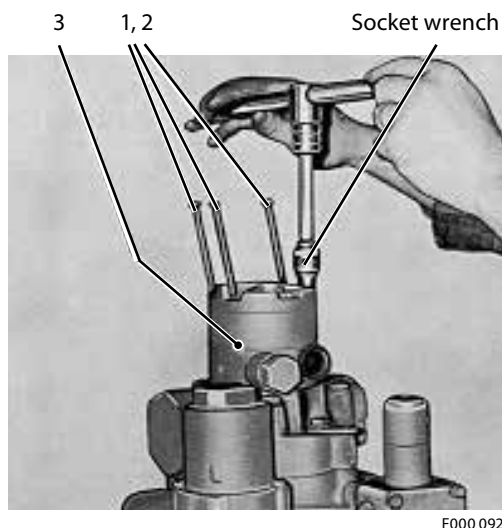

F000 092

To remove the charge pump, loosen the four (4) cap screws that form a rectangular pattern. Do not remove the screws at the top and bottom as these hold the segments of the pump together. Lift the charge pump off the pump end cap. There is a spacer in the idler shaft bore that can slip out as the pump is removed. Do not allow it to fall into the main pump. There is a gasket between the charge pump and end cap that should be discarded.

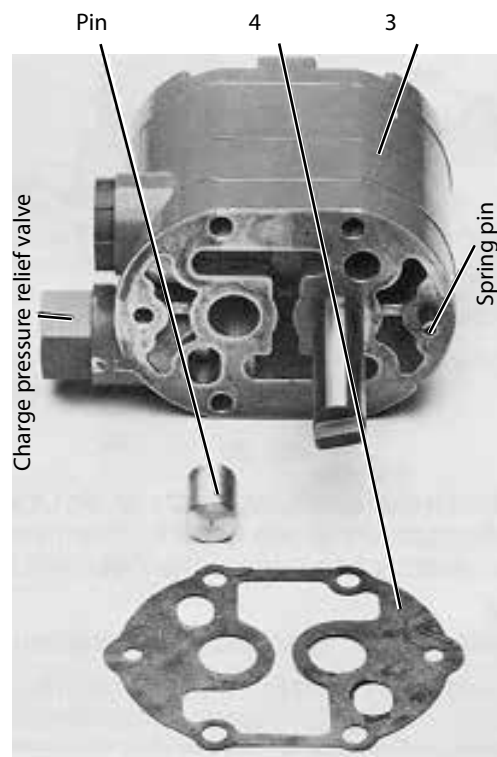

F000 093

When installing the charge pump, align the new gasket so that the small relief valve port is open. Be certain the port in the charge pump and the end cap are aligned. Rotate the charge pump shaft so its tang aligns approximately with the slot in the end of the main pump drive shaft. Hold the idler spacer in place and install the charge pump onto the end cap. Rotate the pump slightly until the tang and slot on the shafts engage and the pump is solidly on the end cap. Insert four (4) cap screws and torque as specified at the end of this manual.

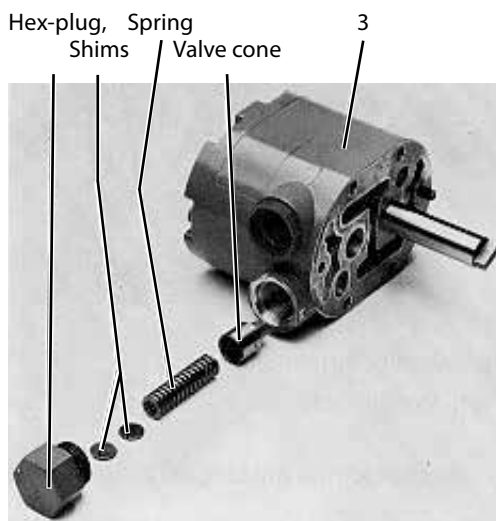

F000 078

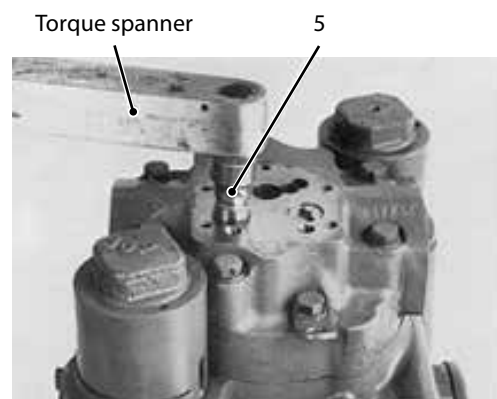

F000 063

**Disassembly and Assembly**

**Minor repairs  
(continued)**

To inspect or replace the charge relief valve, use a "1" wrench to remove the hex plug and the spring and valve cone. Remove the shims from the counter bore of the plug. Do not alter these shims unless new parts are used, in which case adjusting the valve setting, by shimming, is necessary. To install, insert valve cone, spring, shims and plug. Be certain shims are in place in plug. Torque to 22 - 24 Nm [195 - 212 lbf·in].

The removal of the charge check valves requires the use of a draglink socket. These check valves are cartridges which are threaded into the end cap.

The charge check valves are interchangeable with each other. It is suggested that they be replaced in pairs. Use caution when installing these valves to prevent damage to the O-ring on the cartridge as it is inserted past the threads in the end cap.

After assembly, be certain the check valves are below the surface of the end cap. Torque check valves as specified at the end of this manual.

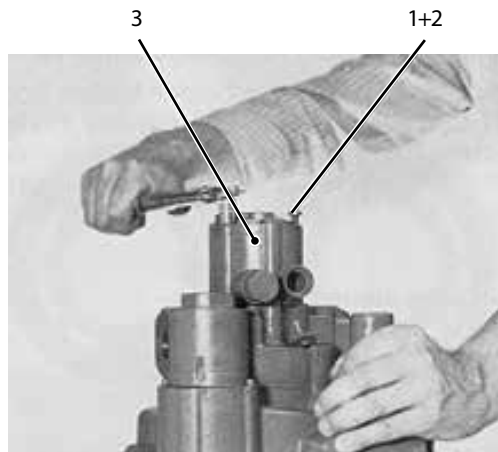

F000 064

**Disassembly and Assembly**

**Minor repairs  
(continued)**

**Changing the servo valve (control valve)**

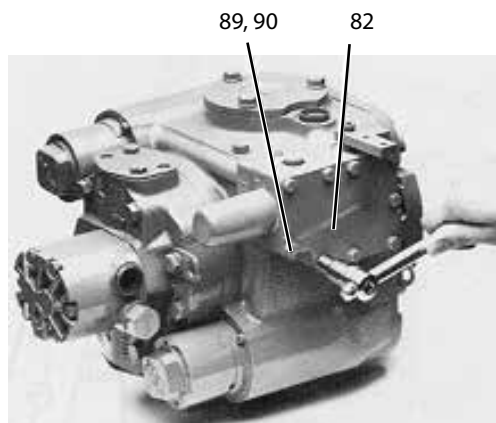

F000 083

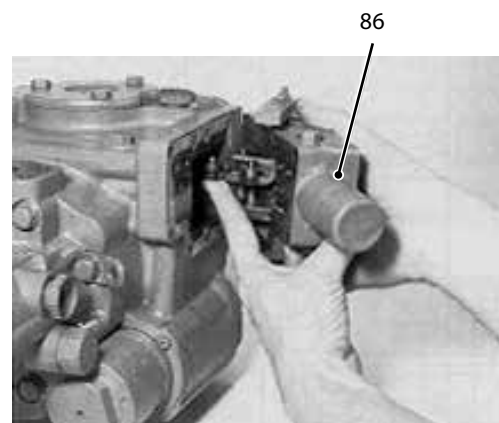

F000 046

Thoroughly clean external surfaces with steam or clean solvent and blow dry. Remove the nine (9) cap screws (using 7/16 wrench) and swing control away from housing.

**⚠ CAUTION:**

**Protect exposed surfaces and cavities from damage and foreign material. Use caution so that the rings and orifice plate remain in place and do not fall into the pump housing.**

Slip the pin on control linkage out of the link attached to the swash plate and remove control. The area is sealed with both a gasket and three (3) O-rings.

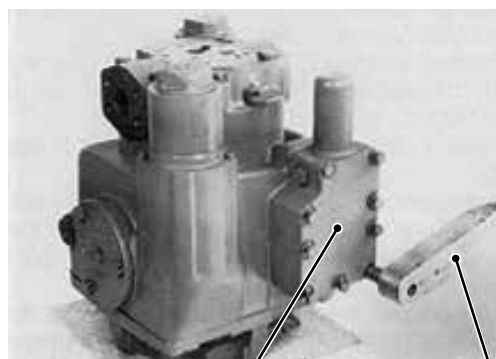

F000 064

89, 90

82

In preparation for installing the control, place a new gasket on the housing. Insert the orifice plate and three (3) O-rings into the control ports. Engage the pin on the control linkage in the mating hole in the link attached to the swash plate. Use caution so that the O-rings and orifice plate remain in place and do not fall into the pump housing. Swing the control into place against the pump housing. Install cap screws and torque to 12 - 14 Nm [106 - 124 lbf-in].

**Disassembly and Assembly**

**Minor repairs  
(continued)**

**Changing the valve- and bearing plate (disassembly)**

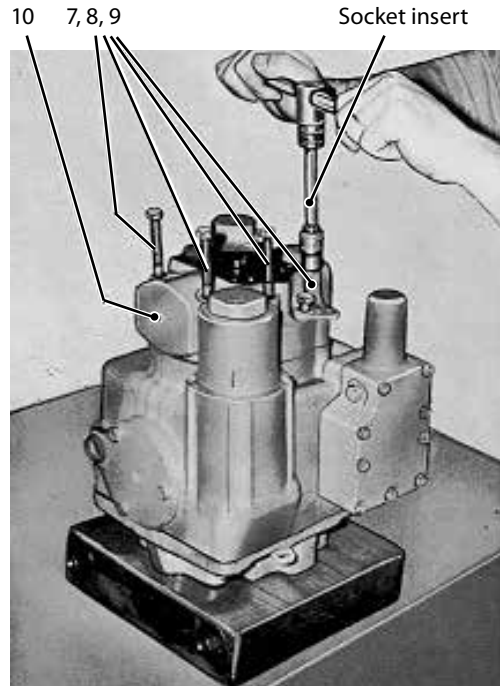

F000 096

1. Disassembly the charge pump (see *pages 21, 22*).
2. The end-cap screws may not be loosened until the shaft seal has been removed (see *page 19*). Remove all but two of the screws which hold the end cap to the pump casing. There is an internal spring loading on the end cap and as the last two screws are loosened the end cap should separate from the housing. Loosen these screws alternately until the loading has been released.

**⚠ CAUTION:**

Major repairs may affect the unit warranty, therefore equipment manufacturer should be consulted prior to undertaking such repairs.

3. The end cap can now be removed from the pump body. In order to avoid the valve plate being damaged by dropping down when the end cover is removed, it must be held firmly as the cover is removed, as shown in the illustration. Should the valve plate stick to the bearing plate, it can then be lifted out separately.



F000 097

All surfaces must be treated with the greatest care. Any damage to the surfaces must be avoided.

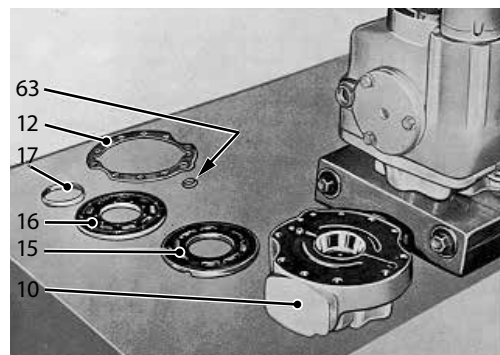

F000 098



**Disassembly and Assembly**

**Minor repairs  
(continued)**

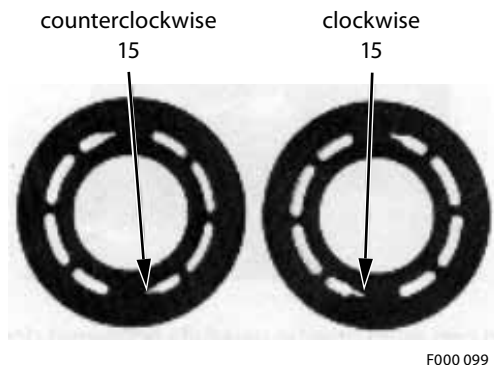

The pump valve plate has two tapered slots running in opposite directions. The valve plate illustrated on the left is for left handed (counter clockwise) operation, and the valve plate illustrated on the right is for right handed operation (clockwise).

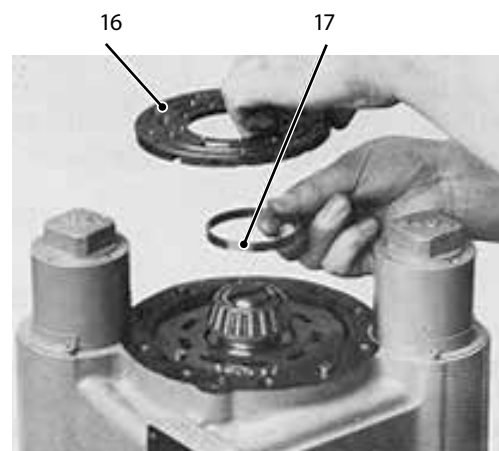

Remove the bearing plate and the bearing plate pilot ring from the cylinder block. Any damaged bearings or valve plates must be replaced. Gaskets and O-rings must in any event always be exchanged. Protect all exposed sealing surfaces and open cavities from damage and foreign material.

**Changing the valve- and bearing plate (assembly)**

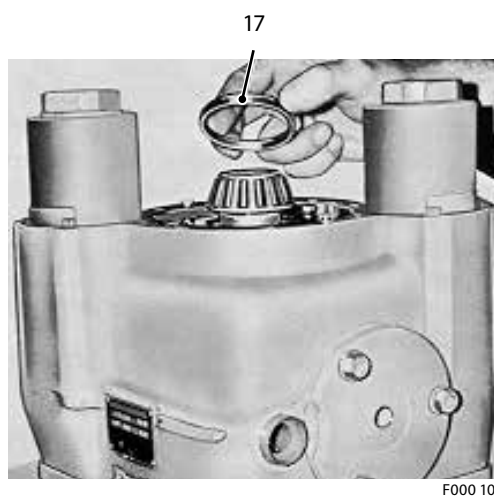

When reassembling, begin by replacing the bearing plate pilot ring in the cylinder block.



Next place the bearing plate on the cylinder block, ensuring that the bearing plate slots lie beneath the positioning pin of the cylinder block. In this way the bearing plate will be retained. Now lubricate the bearing plate with clean oil.

**Disassembly and Assembly**

**Minor repairs  
(continued)**

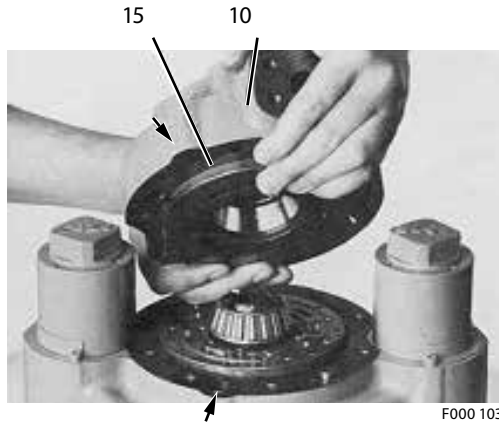

Mount the end cap and the valve plate, ensuring that the valve plate is held in such a way that it cannot be dropped during assembly. The end cap must be turned so that the two dowel pins of the pump housing are positioned over the locating holes.

The valve plate must be positioned with the slot in the valve plate on the dowel pin of the end cap housing.

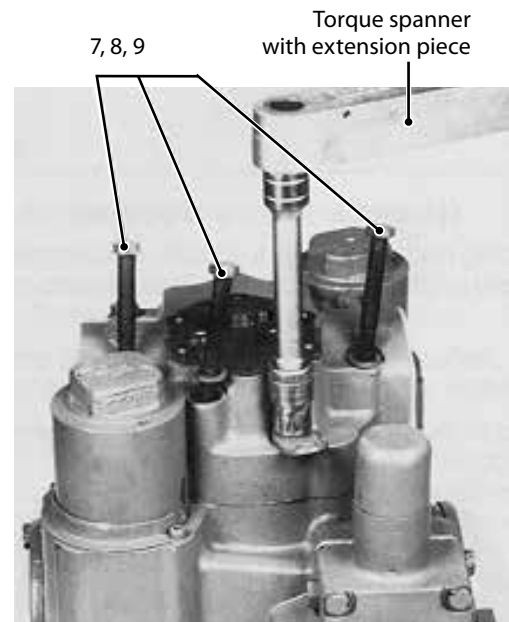

The end cap must now be carefully tightened down with two opposing fixing screws, ensuring that the two dowel pins fit into the holes in the end cap. The remaining screws can then be inserted and tightened up. Install the remaining shaft seal and charge pump as outlined in the minor repair procedure.

**Disassembly and Assembly**

**Minor repairs  
(continued)**

**Changing the cylinder block kit (disassembly)**

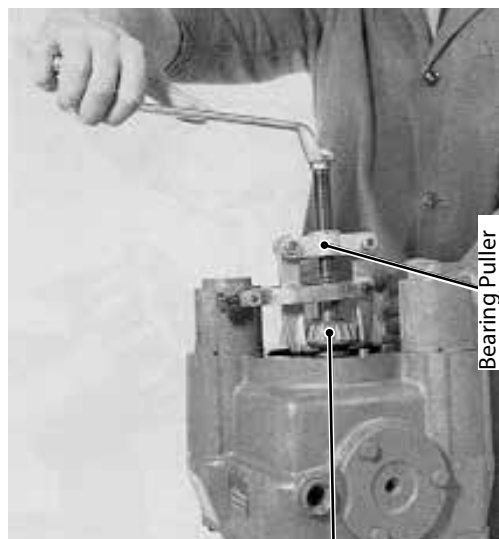

13  
Cone bearing

F000 066

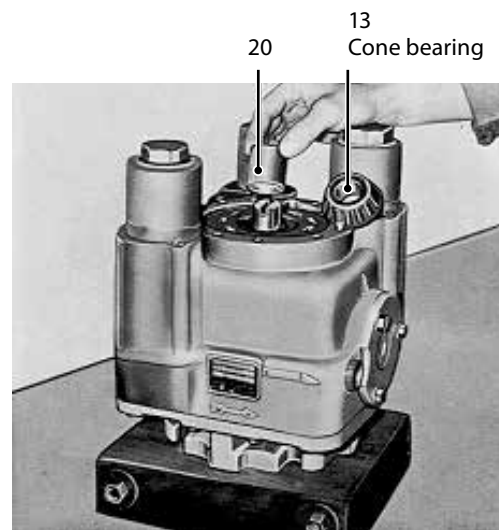

F000 104

After removal of the bearing, slip the spacer out of the bore of the cylinder block.

In order to change the cylinder block assembly, the shaft seal must first be removed (*page 19*) as well as the charge pump (*page 21 and 22*) and the end cap (*page 24 and 25*). The bearing can then be removed from the shaft with a bearing puller. A spacer is required to protect the slot in the end of the pump shaft from the puller screw. When doing this, great care must be exercised to ensure that the bearing casing is not damaged. The cylinder block surfaces must be protected.

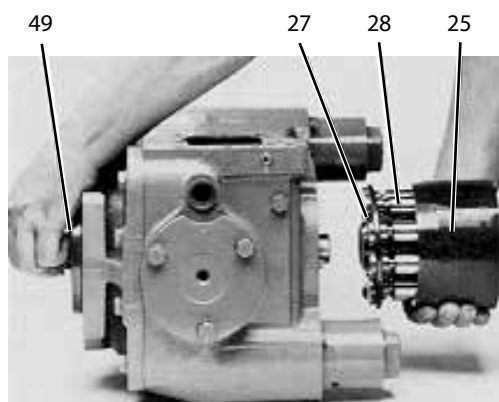

F000 105

Place the pump horizontally in preparation for removal of the cylinder block assembly. Slide the cylinder block assembly off the shaft while holding the external end of the shaft.

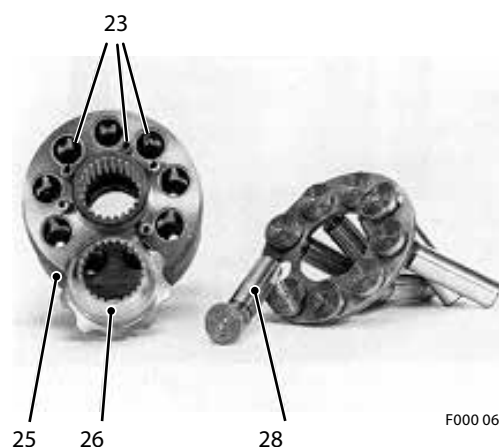

F000 067

Depending upon the extent of damage, the cylinder block assembly should be either completely, or partly, replaced. Any individual part can be changed as may be necessary.

**Disassembly and Assembly**

**Minor repairs  
(continued)**

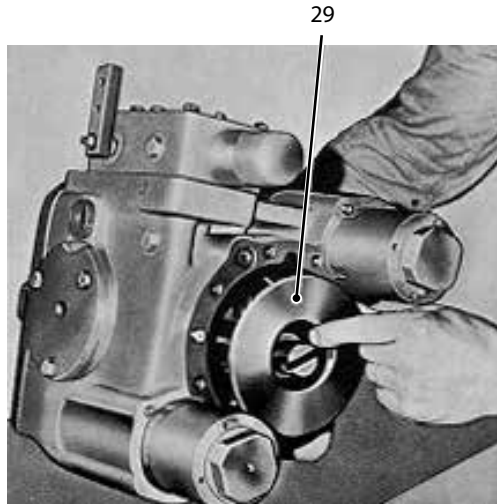

F000 106

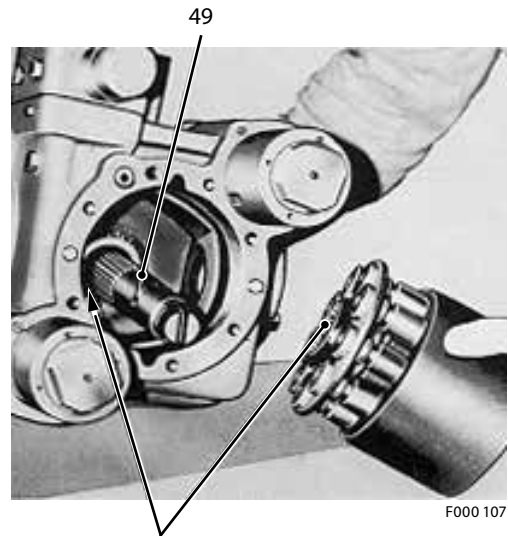

F000 107

Before reassembling the cylinder block assembly, the thrust plate must be withdrawn from the swash plate, and be tested to ensure that it has a perfect surface. If there is any damage to the surface, the plate must be replaced. When the thrust plate is replaced, care must be taken that the side with the chamfer is placed next to the swash plate.

The cylinder block assembly should be installed next. It is necessary to check alignment of the ball guide and cylinder block splines. The undersized tooth in the spline of the cylinder block must line up with the missing tooth in the ball guide spline. These in turn line up with a missing tooth on the shaft spline. Lubricate the thrust plate, slippers, pistons, and bores with clean oil. Slide the cylinder block assembly onto the shaft and against the thrust plate.

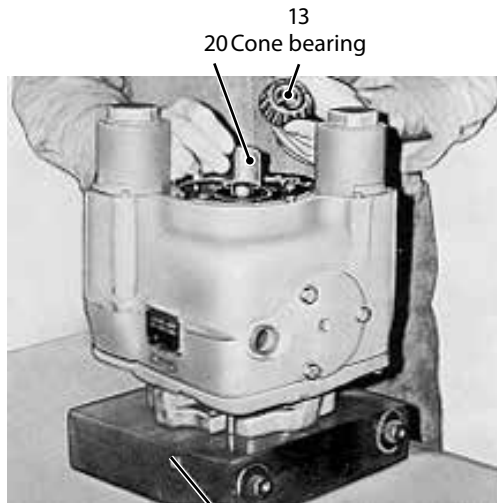

F000 108

see page 18

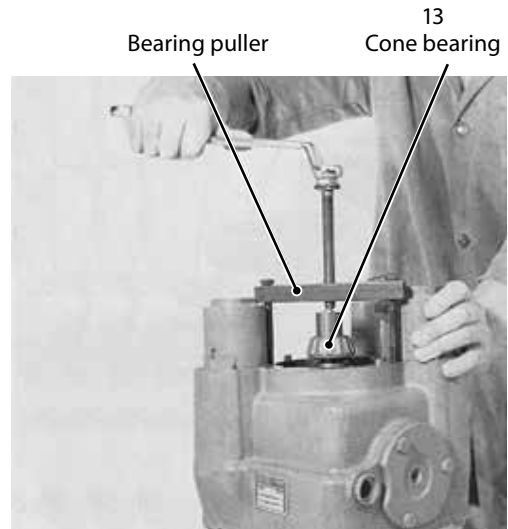

F000 068

The pump should then be moved from the horizontal to a vertical position. The spring guide can now be pushed over the shaft.

Before fitting the tapered bearing, the shaft must be supported underneath so that the spring guide is not compressed by the bearing. A spacer is required to protect the slot in the end of the end of the pump shaft from the puller screw.

**Disassembly and Assembly**

**Minor repairs  
(continued)**

**Changing the swash plate and servo piston (disassembly)**

In order to be able to replace the swash plate and the servo pistons, the operations previously described on the pages 19, 21, 22, 23 and 25 must be carried out.

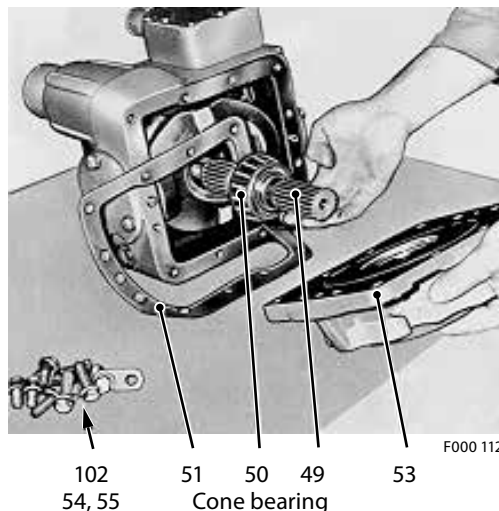

Loosen the front cover screws and remove the front cover with gasket. The shaft with bearing can then be removed.

Next mark the depth to which the servo cylinder has been screwed in, so that reassembly of the swash plate can be correctly effected. Mark servo sleeve and housing-bore to show the relative position.

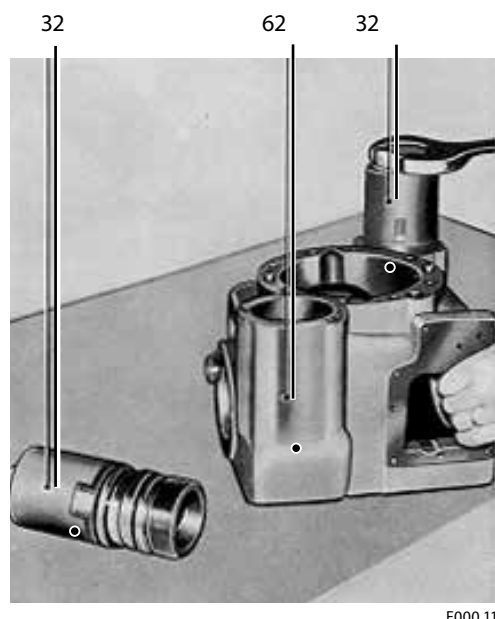
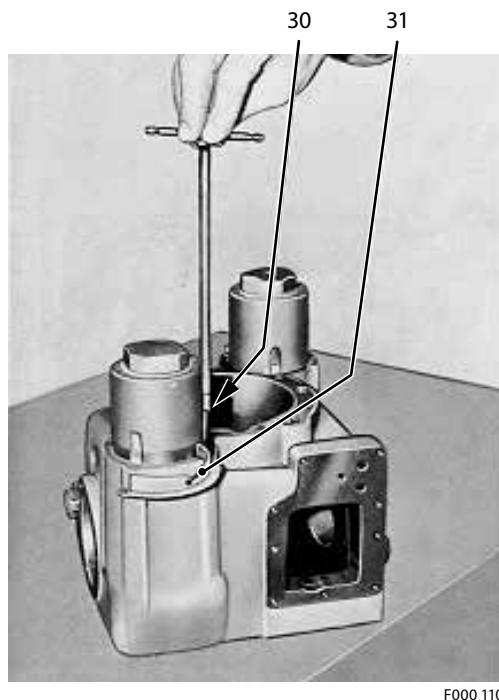

**Disassembly and Assembly**

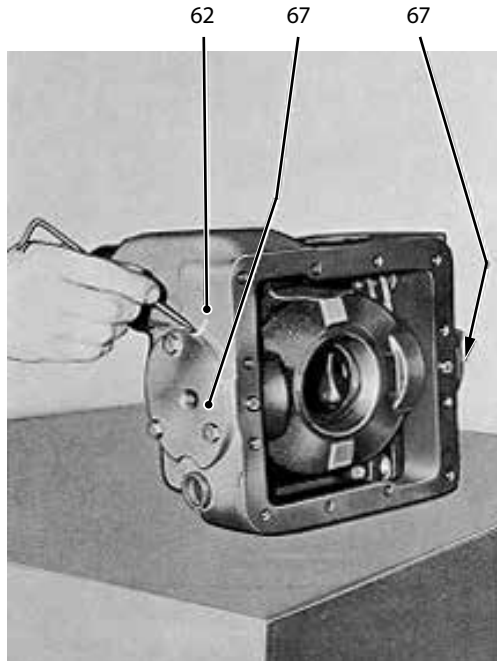

F000 113

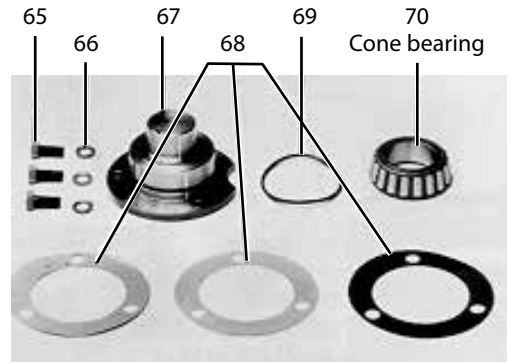

F000 114

Take care that the plastic shims are kept together with the respective trunnions.

Mark the trunnion to facilitate correct re-assembly later, and loosen the three screws on each trunnion. Then remove the trunnion.

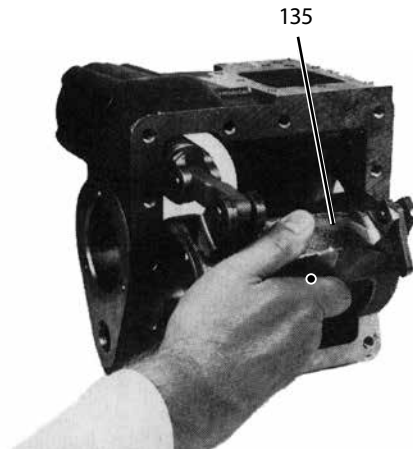

F000 245

Once the trunnions have been removed, the swash plate can be removed complete with servo piston.

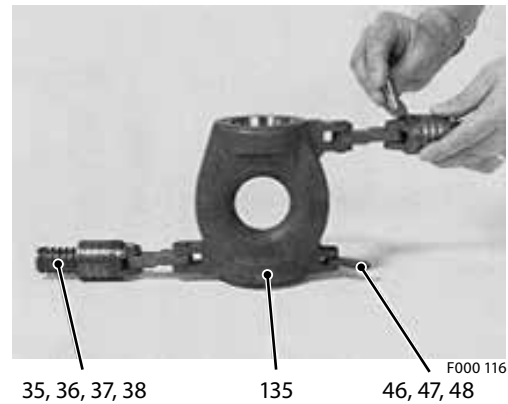

F000 116

Individual parts of the servo piston can if necessary, be replaced.

**Disassembly and Assembly**

**Major repairs  
(continued)**

**Changing the swash plate and servo piston (assembly)**

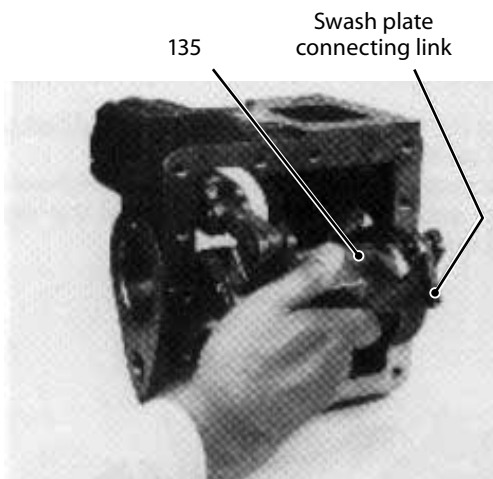

F000 245

Once several parts have been replaced as necessary lay the swash plate complete with servo piston, in the pump housing and bring the swash plate connecting link into the correct position.

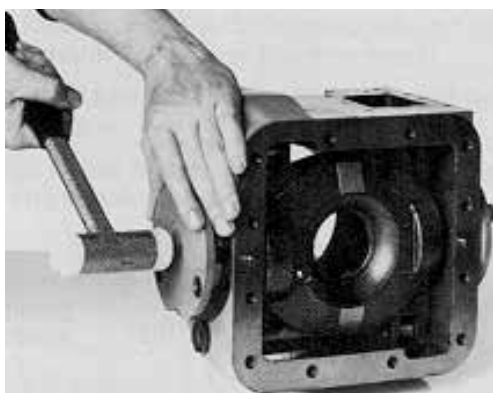

F000 118

Then fit the trunnions with new O-rings (69). Take care that the plastic shims are replaced in the same position as prior to dismantling.

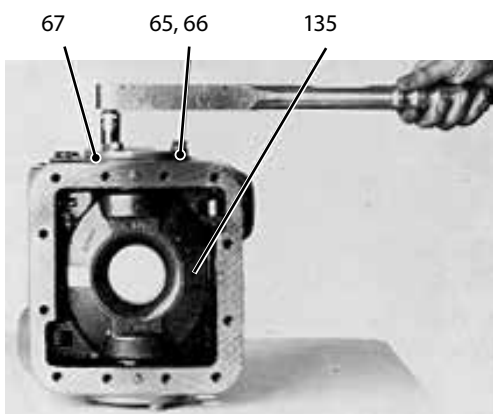

F000 118

Bring the reference marks on the trunnion in line with those on the housing.

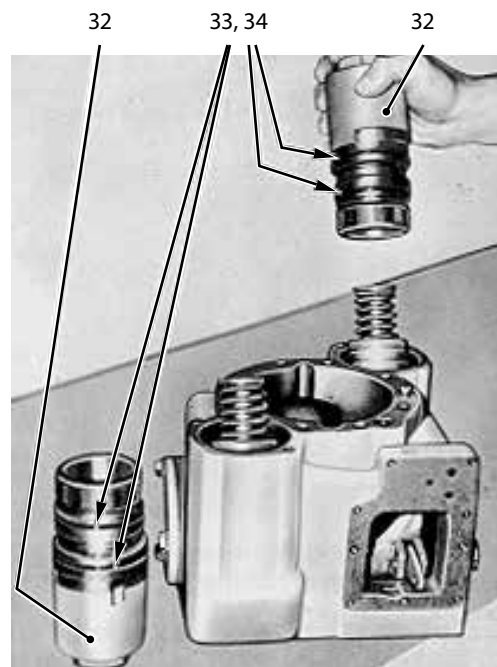

F000 116

Mount the servo cylinder with new O-rings (lubricate O-rings with petroleum jelly before assembly) and turn the servo cylinder to the marked position.

**Disassembly and Assembly**

**Major repairs  
(continued)**

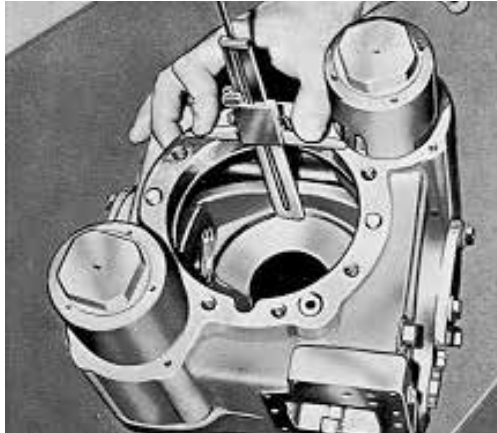

F000 121

The neutral (zero angle) position of the swash plate must now be checked using a depth micrometer. The thrust plate must be installed on the swash plate for this measurement. Measure the distance from the end cap mounting face of the pump housing to the face of the thrust plate 90° to the trunnions, at the outer edge of the thrust plate. Take the same measurement at a point 180° (opposite edge of the thrust plate) from the first. These measurements must not vary more than 0.03 from each other.

- If adjustment required follow these steps.
- Back out both servo housings until the spring load is released on the swash plate (check by rocking swash plate).
  - Thread in each housing until spring load just starts to be felt on the swash plate.
  - Check measurement as described previously.
  - Thread each housing farther in until the measurements are within 0.03 of each other.

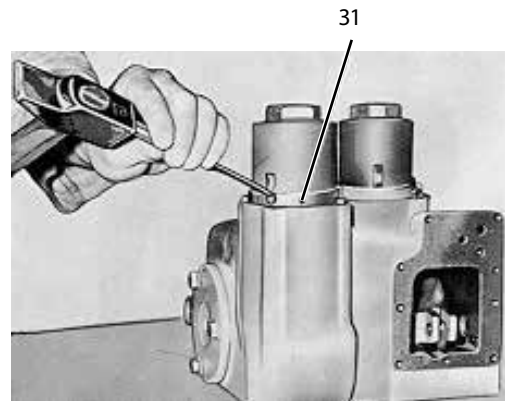

F000 122

Secure the servo cylinder with the retaining plate. After adjustment has been completed, the retainers can be installed and peened into the locking slot on the housing.



**Disassembly and Assembly**

**Major repairs  
(continued)**

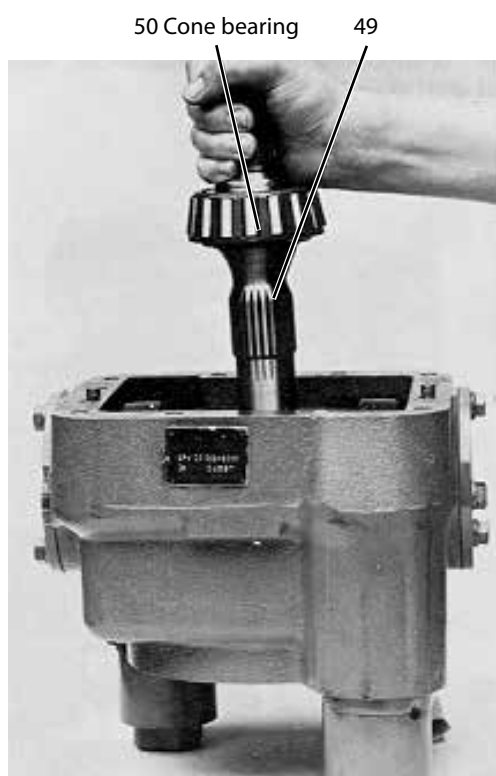

F000 123

Remove the thrust plate and set the pump on the servo housings.  
Insert the shaft and bearing assembly through the cast hole in the swash plate, allowing the bearing to rest on the cast leveled edge.

**Changing the pump shaft**

In order to replace the pump shaft, the stripping operations given under *pages 19, 21, 22, 23, 24, 25, 27* must be carried out.

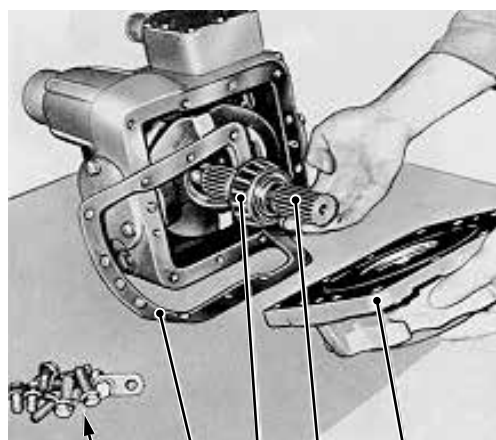

F000 112

102  
54, 55  
51  
50  
Cone bearing  
49  
53

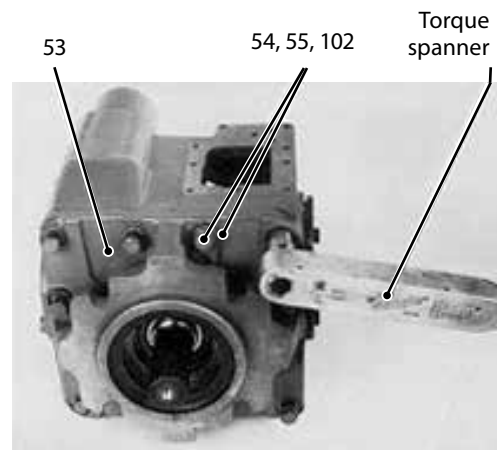

F000 069

Take care that the shaft seal is only fitted after the end cap has been screwed down. If any of those parts are replaced, the shaft end play must be checked:

drive shaft - bearings - housing - front cover - end cap.

To check the shaft end play, assemble the above parts plus the gaskets. The shaft end play should be from 0.08 to 0.18 mm [0.003 - 0.007 in] for frame sizes 033 - 089 and from 0.15 to 0.3 mm [0.006 - 0.012 in] for frame sizes 119 - 334. If adjustment is necessary, a shim can be placed under the bearing race in the end cap.

Disassemble these parts and resume reassembly procedure.



F000 124

The tapered bearing can be pressed off the shaft if required. Be careful not to damage the seal diameter of the shaft while removing the bearing.

**Disassembly and Assembly**

**Major repairs  
(continued)**

Next loosen the front cover screws and remove the front cover together with the gasket. The shaft with bearing can then be removed.  
Should the bearings be damaged, the bearing cup in the front cover must also be replaced.  
Remove the thrust plate and set the pump on the servo housings.

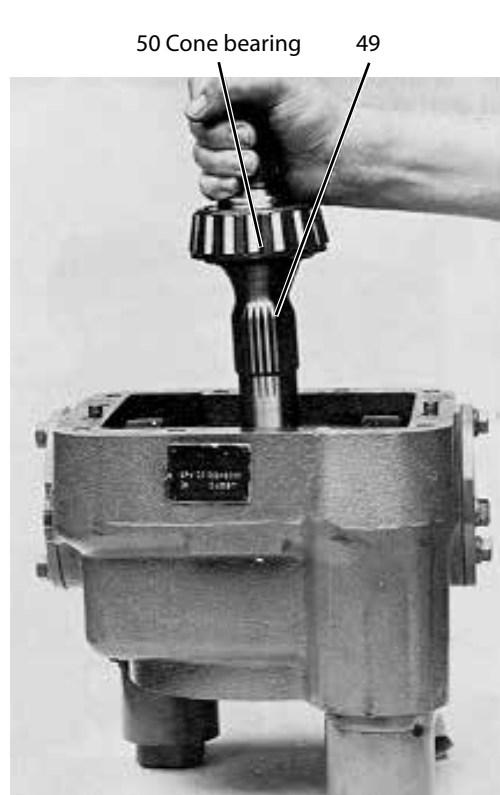

F000 123

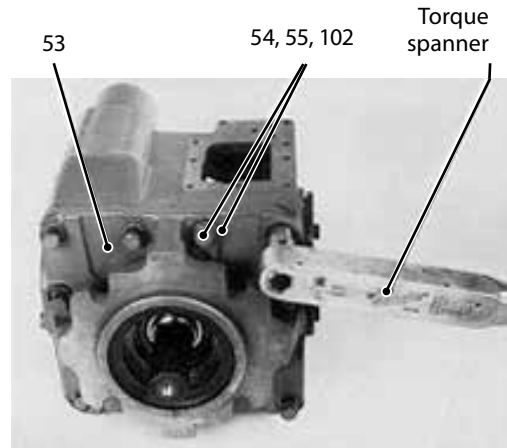

F000 069

Install the front cover and gasket, being certain that the locating pins are in place in the housing. These parts will go on only one way and have all the mounting holes align with the housing. Resume reassembly procedure.

Insert the shaft and the bearing assembly through the cast hole in the swash plate, allowing the bearing to rest on the cast leveled edge.

**Installation Torque Values**

Installation torque values Nm [lbf·in], series 20				
	Frame size			
	033	052	070	089
End cap	36.6 [324] - 50.2 [444]	36.6 [324] - 50.2 [444]	36.6 [324] - 50.2 [444]	61.0 [540] - 73.2 [648]
Charge pump	13.6 [120] - 14.9 [132]	13.6 [120] - 14.9 [132]	13.6 [120] - 14.9 [132]	13.6 [120] - 14.9 [132]
Charge pump, suction port	18.6 [165] - 27.5 [243]	18.6 [165] - 27.5 [243]	18.6 [165] - 27.5 [243]	18.6 [165] - 27.5 [243]
Servo valve (control valve)	13.6 [120] - 14.9 [132]	13.6 [120] - 14.9 [132]	13.6 [120] - 14.9 [132]	13.6 [120] - 14.9 [132]
Charge check valve	40.7 [360] - 54.2 [480]	40.7 [360] - 54.2 [480]	40.7 [360] - 54.2 [480]	40.7 [360] - 54.2 [480]
Front cover	36.6 [324] - 50.2 [444]	36.6 [324] - 50.2 [444]	36.6 [324] - 50.2 [444]	61.0 [540] - 73.2 [648]
Spring assembly	13.6 [120] - 14.9 [132]	13.6 [120] - 14.9 [132]	13.6 [120] - 14.9 [132]	13.6 [120] - 14.9 [132]
Servo piston	18.6 [165]**	18.6 [165]**	18.6 [165]**	18.6 [165]**
	Frame size			
	119	166	227	334
End cap	90.9 [805] - 111.2 [984]	181.7 [1608] - 223.7 [1980]	325.4 [2880] - 393.2 [3480]	325.4 [2880] - 393.2 [3480]
Charge pump	36.6 [324] - 50.2 [444]	36.6 [324] - 50.2 [444]	36.6 [324] - 50.2 [444]	36.6 [324] - 50.2 [444]
Charge pump, suction port	20.6 [182] - 31.4 [278]	20.6 [182] - 31.4 [278]	20.6 [182] - 31.4 [278]	20.6 [182] - 31.4 [278]
Servo valve (control valve)	13.6 [120] - 14.9 [132]	13.6 [120] - 14.9 [132]	13.6 [120] - 14.9 [132]	13.6 [120] - 14.9 [132]
Charge check valve	108.5 [960] - 122.1 [1081]	108.5 [960] - 122.1 [1081]** 169.5 [1500] - 183.1 [1621]	108.5 [960] - 122.1 [1081]** 169.5 [1500] - 183.1 [1621]	108.5 [960] - 122.1 [1081]** 169.5 [1500] - 183.1 [1621]
Front cover	90.9 [805] - 111.2 [984]	90.9 [805] - 111.2 [984]	90.9 [805] - 111.2 [984]	90.9 [805] - 111.2 [984]
Spring assembly	21.7 [192] - 28.5 [252]	21.7 [192] - 28.5 [252]	36.6 [324] - 50.2 [444]	36.6 [324] - 50.2 [444]
Servo piston	40.2 [356]**	40.2 [356]**	40.2 [356]**	40.2 [356]**

\*\* for charge pump 32.8 cm<sup>3</sup> [2.00 inch<sup>3</sup>]

\*\*\* only for locking screw



**Products we offer:**

- Bent Axis Motors
- Closed Circuit Axial Piston Pumps and Motors
- Displays
- Electrohydraulic Power Steering
- Electrohydraulics
- Hydraulic Power Steering
- Integrated Systems
- Joysticks and Control Handles
- Microcontrollers and Software
- Open Circuit Axial Piston Pumps
- Orbital Motors
- PLUS+1® GUIDE
- Proportional Valves
- Sensors
- Steering
- Transit Mixer Drives

**Danfoss Power Solutions** is a global manufacturer and supplier of high-quality hydraulic and electronic components. We specialize in providing state-of-the-art technology and solutions that excel in the harsh operating conditions of the mobile off-highway market. Building on our extensive applications expertise, we work closely with our customers to ensure exceptional performance for a broad range of off-highway vehicles.

We help OEMs around the world speed up system development, reduce costs and bring vehicles to market faster.

Danfoss – Your Strongest Partner in Mobile Hydraulics.

**Go to [www.powersolutions.danfoss.com](http://www.powersolutions.danfoss.com) for further product information.**

Wherever off-highway vehicles are at work, so is Danfoss.

We offer expert worldwide support for our customers, ensuring the best possible solutions for outstanding performance. And with an extensive network of Global Service Partners, we also provide comprehensive global service for all of our components.

Please contact the Danfoss Power Solution representative nearest you.

**Comatrol**

[www.comatrol.com](http://www.comatrol.com)

**Schwarzmueller-Inverter**

[www.schwarzmueller-inverter.com](http://www.schwarzmueller-inverter.com)

**Turolla**

[www.turollaocg.com](http://www.turollaocg.com)

**Valmova**

[www.valmova.com](http://www.valmova.com)

**Hydro-Gear**

[www.hydro-gear.com](http://www.hydro-gear.com)

**Daikin-Sauer-Danfoss**

[www.daikin-sauer-danfoss.com](http://www.daikin-sauer-danfoss.com)

Local address:

**Danfoss Power Solutions (US) Company**  
2800 East 13th Street  
Ames, IA 50010, USA  
Phone: +1 515 239 6000

**Danfoss Power Solutions GmbH & Co. OHG**  
Krokamp 35  
D-24539 Neumünster, Germany  
Phone: +49 4321 871 0

**Danfoss Power Solutions ApS**  
Nordborgvej 81  
DK-6430 Nordborg, Denmark  
Phone: +45 7488 2222

**Danfoss Power Solutions Trading (Shanghai) Co., Ltd.**  
Building #22, No. 1000 Jin Hai Rd  
Jin Qiao, Pudong New District  
Shanghai, China 201206  
Phone: +86 21 3418 5200

Danfoss can accept no responsibility for possible errors in catalogues, brochures and other printed material. Danfoss reserves the right to alter its products without notice. This also applies to products already on order provided that such alterations can be made without changes being necessary in specifications already agreed. All trademarks in this material are property of the respective companies. Danfoss and the Danfoss logotype are trademarks of Danfoss A/S. All rights reserved.