

ENGINEERING  
TOMORROW

*Danfoss*

Electrical Heating

# Sports Field Heating

## Application manual





# Let Danfoss do the work

Danfoss Group is Denmark's largest industrial group. It is one of the world's leading companies within heating, cooling and air-conditioning. The Danfoss Group has more than 23000 employees and serves customers in more than 100 countries.

Danfoss is Europe's leading brand of electrical cable heating systems and electric pipe heating systems with over 70 years of experience. The production of heating cables takes place in France and Poland while the head office is situated in Denmark.

## Artificial and natural grass lawns

This design guide presents Danfoss's recommendations for design and installation of ice and snow melting systems for sport field heating application. It provides guidance for heating cable positioning, electrical data and system configurations.

Following Danfoss's recommendations will ensure energy efficient, reliable and maintenance free solution for constant wattage heating cables with 20 year warranty.

## Index

<b>1. Sports field heating</b>	<b>4</b>
<b>2. System Description</b>	<b>5</b>
<b>3. System Design</b>	<b>8</b>
<b>5. Installation</b>	<b>11</b>
<b>6. Cases References</b>	<b>15</b>
<b>7. Cases</b>	<b>16</b>

## Our quality management system **certifications and compliances**

✓ ISO 9001

✓ TS 16949

✓ ISO 14001

Along with full compliance with EU directives and product approvals

# 1. Sports field heating

For professional and international stadiums a very high standard of playing surface is required. Under these circumstances it is important to eliminate risks of poor playing conditions or cancellation, particularly associated with poor weather conditions, e.g. heavy rainfalls or ice and snow.

According to the FIFA's Technical recommendations and requirements, 5th edition (paragraph 4.2):  
“(..) In cold climates, the playing field should be equipped with an underground heating system to prevent it from freezing in extreme winter conditions. (..)”

In some leagues, the undersoil heating is already a standard, e.g. in the first and second Bundesliga (DFB) in Germany.

## Benefits

- **Keeps the pitch frost free** – prolonging pitch usage during the autumn season
- **Defreeze the pitch after a winter break** – increasing pitch quality and making it playable earlier
- **Reducing financial risks** – caused by postponing games due to poor weather conditions
- **Increasing safety** – helps to reduce injuries
- **Increasing usage** – helps to recover natural grass after heavy usage faster
- **International standards** – Danfoss heating system is bringing football pitch in line with FIFA's Technical recommendations and requirements
- **Affordable solution** - initial investment of 50% below cost of hydronic systems
- **Quick Installation time** of 4 weeks (or less), to make pitch playable again – all games meet the schedule and no need to close a stadium for long renovation
- **Maintenance free** – no need to change anything during the warranty period, vs. Glycol in hydronic systems which has to be replaced after 2 years (app. 8000 liters; depending on the field size)
- **Reliable system** – 20 years of warranty on Danfoss heating cables for natural grass pitches and 5 years on heating mats for artificial turf pitches
- **Experienced supplier** – Danfoss has been involved in football field heating since 1995. Danfoss electric heating solutions installed in football fields, golf courses, cricket fields both under Natural and Artificial grass fields. Within the past 20 years our systems have been installed in over 40 playing fields.

## 2. System Description

Pitch heating is keeping the ground temperature at appropriate level and helps to maintain good quality of pitch during the whole season.

Danfoss offers a wide variety of heating cables/mats and thermostats for installation in football fields, golf courses, cricket fields, and other play grounds where any kind of sport activities takes place. Products can be used for both natural and artificial grass.

Installation of Danfoss heating cables in natural turf ensures grass growth and helps to prolong pitch usage by several months.

For artificial fields the system ensures frost removing and allows field usage almost year around.

For bigger stadiums the appropriate power needed to operate cables can be easily achieved. Normally the night light systems are operated only when the field is in use. It is simple to modify the wiring to provide the desired power for heating cables at the moment when the night light system is switched off.

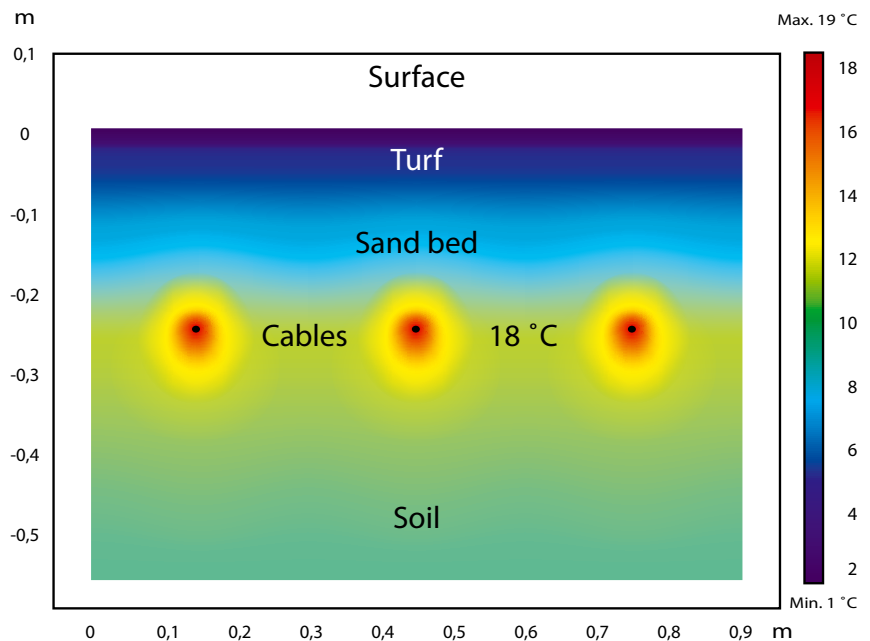

### Steady state at -5 °C ambient air temperature:

- +3 °C is evenly distributed in turf
- 89% of heat is going up
- Cable temperature is approx. 20 °C

## Benefits

- For new construction and renovation of pitches
- Approx. 2 weeks from installation start to make the pitch playable again
- Keeps the pitch frost free during winter
- Defreezes the pitch after a winter break
- Stimulates grass growth in cold weather conditions

## 2.1 Frost heave prevention system

The heating elements installed just below the grass root zone together with temperature sensors must be controlled by a thermostat. The root zone's temperature should be maintained in the range of 10...18 °C (in each case the temperature level should be determined by an agricultural engineer of the sport field in question).

Temperature maintenance of the soil around the grass roots ensures grass growth and prolongs the field usage by 3-4 months per year. In spring the pitch will be ready up to two months earlier than usual. Furthermore, the playing season can be prolonged in autumn when the period, until the grass stops growing, can be extended by means of roots heating regardless the geographic location.

Danfoss heating cables can be installed both when the grass is placed and when the grass is renewed. The latter takes place by laying heating cables directly in the ground. The grass area must be levelled and appropriate drainage is ensured.

## 2.2. Artificial grass

Artificial grass has become an acceptable playing surface and an alternative solution to natural grass allowing the field usage all year round in any weather conditions. Still, in winter pitch freezes up becoming inapplicable, and the expected lifetime of the artificial grass decreases when using the pitch in inappropriate conditions.

Different fields and projects also require different solutions. Not all types of shock pads can be used together with heating systems and are subject to Danfoss's confirmation prior to installation.

To keep the pitch frost free during winter Danfoss electric heating cables can be installed between a shock pad and artificial turf.

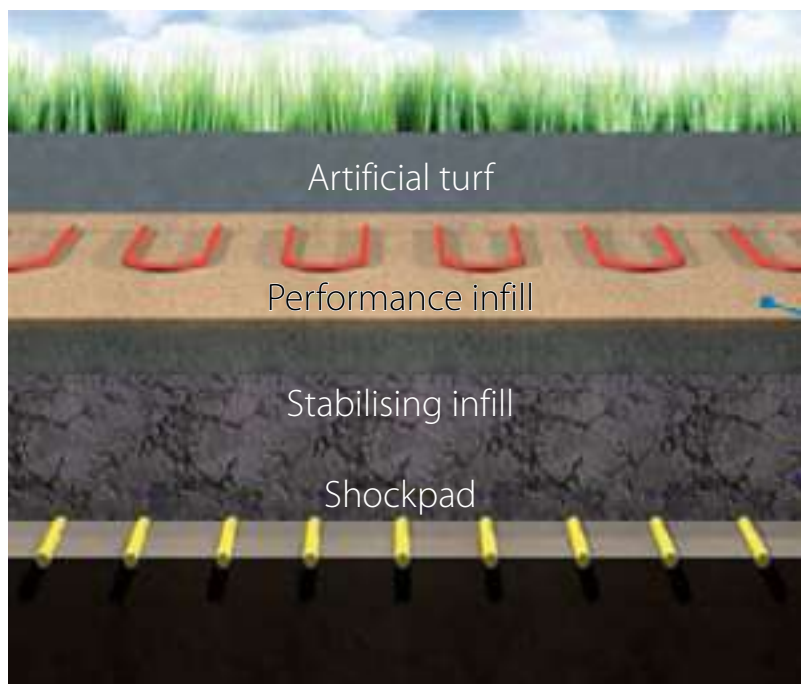
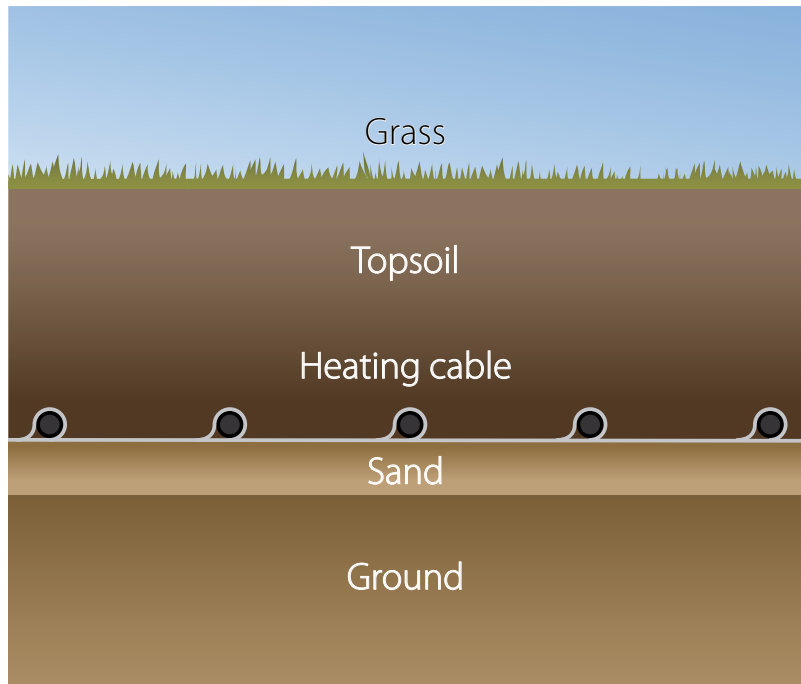

## 2.3. Product Selection

### Heating cables

DSM3 (DEVI<sup>SPORT</sup>™) for natural grass field. Robust cable and resistive heating cable can be also used for plough installations. Danfoss provides 20 year warranty. Manufactured in EU.

The DSM3 (DEVI<sup>SPORT</sup>™) single conductor heating cable of high mechanical strength against both pulling and deformation (1500 N) making it ideal for installation with specialized cable ploughs.

The DSM3 (DEVI<sup>SPORT</sup>™) can be customized to any specific project, with regards to the pitch size, voltage level, required output and length of cold leads.

For a new pitch construction the heating system may include the following resistive heating cables:

- Single conductor ECbasic 20S, ECbasic on drum,
- Twin conductor ECsnow 20T.



### Heating mats

The DSVF-90 (DEVI<sup>HEAT</sup>™ 90S) is designed for installation under artificial grass to ensure frost protection of fields with output of 90 W/m<sup>2</sup> at 230 V.

DSVF-90 (DEVI<sup>HEAT</sup>™ 90S) is a high-quality, braided screen, self-adhesive all-in-one mat with FEP insulated conductors and a red PVDF outer sheath.

The round profile cable, very low mat height (only 3 mm) and robust construction ensure fast, simple and safe installation.

Standard length of the DSVF-90 (DEVI<sup>HEAT</sup>™ 90S) mat is 70,5 m (0,5 m width), and special care is taken so the length varies only a little to accommodate the specific dimensions of the field covered with artificial grass.



### Thermostats

Regulation can be provided by means of EFET 330 (5...45 °C) thermostats with an external sensor installed in the ground at the same depth as the heating element and as close to grass roots as possible.

Regulation can also be provided "on-site" by means of already existing temperature measuring devices.

EFET 330 (5...45 °C) thermostats have a full set of functions to control any heating system for natural or artificial grass, and allow for attachment of external sensors for ground temperature measuring.

**Accessories:** synthetic nails for mat fastening to the ground; ECfast Metal - galvanized metal band for cable.



### Products - general overview of Sport fields heating

Product	Options	Description
Resistive heating cable DSM3 (DEVI <sup>SPORT</sup> ™)	DSM3 (DEVI <sup>SPORT</sup> ™) on drum 400 V, 0,04-8 Ohm/m	Single conductor, screen, black. Max. 30 W/m, max. 400 V. IEC60800:1992 C, NF-C 32-330.
Resistive heating mat DSVF-90 (DEVI <sup>HEAT</sup> ™ 90S)	DSVF-90 (DEVI <sup>HEAT</sup> ™ 90S), 230 V	Single conductor, screen. 90 W/m <sup>2</sup> , 0,5 x 70,5 m. Cold tail - 15 m.
Resistive heating cable ECbasic 20S	ECbasic 20S, 230 V DEVI <sup>BASIC</sup> ™ 20S, 400 V	Single conductor, wire screen. 20 W/m (230 V/400 V). DIN IEC 60800:1992 C
Resistive heating cable DEVI <sup>BASIC</sup> ™	DEVI <sup>BASIC</sup> ™ on drum; 0,0134-34,1 Ohm/m	Single conductor, wire screen. Max 20 W/m; max. 400 V. DIN IEC 60800:1992 C
Constant wattage cable ECsnow	ECsnow 20T 230V & 400V program	Twin conductor, 100% screen, UV stabilized, black. 20 W/m, (230 V/400 V), DIN IEC 60800: 2009 M2
Thermostat	EFET 330 (5...45 °C)	5...45 °C, 16 A, IP20, DIN rail
Fixing	ECfast Metal Synthetic nails	25 m pack; galvanized metal, fixings every 2,5 cm. 100 pcs pack; fixing DEVI <sup>HEAT</sup> ™ 90S to the ground

For details please refer to the Danfoss Catalogue or Data sheets.

# 3. System Design

Considerations prior to design of a heating system

- Field type – Artificial or Natural
- Project type – new construction or renovation
- Power supply availability – new or existing power supply from power transformers of the stadium lighting system
- Supply power – max. kW for heating and calculated max. output. W/m<sup>2</sup>
- Operating strategy – climatic conditions and possibility of operation during periods with low tariffs
- Drainage – no underground heating without drainage, as less water means less heating
- Size of the field – maximum size of grass areas
- Area conditions – permanently shadowed areas and a required number of zones
- Timing for installation – time available for installation
- Testing – especially important for Artificial grass

### Installed output

Normally the recommended installed output for heating natural grass fields is 80-100 W/m<sup>2</sup> with maximum limit of 120 W/m<sup>2</sup> depending on the geographic location.

The installed output for artificial fields can be bigger and shall correspond the limits of artificial grass producers. But it is usually the same as for the natural grass.

In most cases for sport field heating it is used the power supply from existing transformers of the stadium lighting system. Maximum possible output of transformers of the lighting system is typically 400-800 kW and should be

used as a limit for calculation of the field heating system.

For example, the transformers power of the lighting system is 600 kW. The football field size is 70 x 100 m or 7000 m<sup>2</sup>. The max. possible output of the cable heating system per m<sup>2</sup> can be determined as follows:  
 $600 \text{ kW} / 7000 \text{ m}^2 = 85 \text{ W/m}^2$ .

Additionally for natural grass the maximum possible temperature of the root zone should be taken into account. Max. cable linear output and/or maximum heating system output can cause burning of grass roots. One of the alternative solution to avoid this problem is to install cable below the root zone, e.g. at a 30-35 cm depth.

Based on the above the recommended maximum output for the cable is 25 W/m and system output is up to 80-100 W/m<sup>2</sup>.

**Note.** Output for sport field heating systems should be designed in accordance with the recommended values where possible.

### Possible minimum working temperature

One of the main tasks of sport field heating systems is to defreeze the pitch just for an individual football game or support min +1 °C on the surface. When calculating rated output the lowest ambient air temperature at which the heating system ensures +1 °C on the surface shall be taken into account.

All in all for medium weather conditions in order to heat a 1 m<sup>2</sup> surface outside up to 1 °C approx. power of 23 Watt (see e.g. "Asphalt application. Ice and Snow Melting" Application manual) is needed. Otherwise the heat exchange coefficient - approx. 23 W/(m<sup>2</sup>·K) should be used for calculation.

The possible temperature difference between the surface and the air e.g. for installed 100 W/m<sup>2</sup> can be determined as follows:

$$100 \text{ W/m}^2 / 23 \text{ W/(m}^2\cdot\text{K)} \approx 4 \text{ }^\circ\text{C}.$$

To summarize - 100 W/m<sup>2</sup> ensures defreezing the pitch

surface under conditions of minimum air temperature up to minus 3 degrees: +1 °C - (+4 °C) = -3 °C.

### Heating zones

The heating system and the field should be split in zones. Size and direction of the field areas which are permanently shadowed during winter are determined the required number of zones.



Minimum 4 zones are recommended. Application of more zones simplifies system design and control.

For each zone minimum one thermostat with a temperature sensor shall be used.

### Depth of cable installation

According to the FIFA's Technical recommendations and requirements, 5th edition (paragraph 4.3) the installation depth of heating cables should be not less than 250 mm.

The heating cables should be installed 25-30 cm (up till 35 cm) below the surface to avoid cable damage due to the use of e.g. javelins.





The above output values ensure 6...10 °C temperature in the root zone, approx. 10 cm below the surface

In order to keep the soil warm and moist the area should be covered with plastic or a similar material when it is not in use.

Local requirements for installation depth and possible mechanical protection for cold leads should be observed.

Insertion depth of objects like lawn aerators, vertidrain, spades, javelins, pegs, anchor bolts etc. should be taken into account.

### Cable/mat output and C-C distance

The DSVF-90 (DEVIheat™ 90S) is specially designed for installation under artificial grass fields with output of 90 W/m<sup>2</sup> at 230 V.

The heating cables with 15-25 W/m output, 230/400 V should be used for applications in grass areas.

The distance between the cables (C-C distance) naturally depends on the output per meter and the desired output per m<sup>2</sup>, and is typically 15-25 cm.

Additionally to avoid cold gaps between heating cables the C-C distance should be equal or less than the cable installation depth.

Two formulas can be used for the C-C distance calculation:

$$C - C [cm] = \frac{\text{Area [m}^2]}{\text{Cable length [m]}} \cdot 100 \quad (1)$$

or

$$C - C [cm] = \frac{\text{Cable output [W/m]}}{\text{Heat density [W/m}^2]} \cdot 100 \quad (2)$$

The easiest way to calculate/evaluate the system output W/m<sup>2</sup> (heat density) is to multiply cable linear output by the number of cable lines per m<sup>2</sup>.

For example if C-C distance is 21 cm and the cable output is 20 W/m the heating system output is determined as follows:

$$20 \text{ W/m} \cdot (100 \text{ cm} / 21 \text{ cm}) \approx 95 \text{ W/m}^2.$$

The table shows the C-C distances and corresponding outputs per m<sup>2</sup>:

C-C, cm	Cable linear output, W/m				
	16	18	20	22	24
15	107	120	133	147	160
16	100	113	125	138	150
17	94	106	118	129	141
18	89	100	111	122	133
19	84	95	105	116	126
20	80	90	100	110	120
21	76	86	95	105	114
22	73	82	91	100	109
23	70	78	87	96	104
24	67	75	83	92	100
25	64	72	80	88	96
26	62	69	77	85	92
27	59	67	74	81	89
28	57	64	71	79	86
29	55	62	69	76	83
30	53	60	67	73	80

**Note.** The recommended output range is 80-120 W/m<sup>2</sup> (black values in the table).

### Cable length

For cable/mat length calculation the position of an electrical connection box and the location of cable channel(s) – either along or across the field should be evaluated.

The DSVF-90 (DEVIheat™ 90S) heating mat is specially designed with 70,5 m length. The mat length can vary very little (on special order), to accommodate the specific dimensions of the field covered with artificial grass.

The DSM3 (DEVI sport™) heating cable on drum can be supplied with a specific Ohm/m value with regards to the pitch size, voltage, desired output, number of cable lines and length of cold leads.

Accurate calculation of the cable length is required to supply cable cold lead(s) to the end on the same side of the field and to optimize the electrical connection. Hence the number of lines of each cable should be even.

Most usual installation is 4 cable lines for each heating cable.

For example, if cables are supposed to be installed in 4 lines along the short side of 70 x 110 m football field, than the cable length should be 4 · 70 = 280 m. In case of cable installation along the long side of the field the cable length is 4 · 110 = 440 m. Please note that the designed cable length shall provide the required Ohm/m value. If it is not possible - 2 cable lines should be chosen.

### Sensor place

The sensor should be installed at the same level with the grass roots (in case of natural grass field) to ensure appropriate temperature. In case of artificial grass the sensor should be installed as close as possible to the surface and just above the heating cables.

It is recommended to use 2 sensors or 1 additional sensor for measuring average top soil temperature.

### Cable trench

A special cable trench shall be designed.

Cold leads in a cable trench shall be designed with installation in 1 layer only (no bundling, no pipes).

It is recommended connection of cold leads and sensors in sealed junction boxes or cable wells, max. 20 m from each zone.

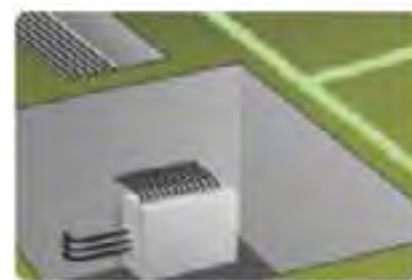

**Note!** Single conductor heating mat DSVF-90 (DEVIheat™ 90S) has to be connected to power supply from both sides of the mat/field.

To avoid connection of one mat on both sides, a heating mat should be rolled in from the side up to middle of the playground and then return. Thereby supply leads are together.

## Start of heating

The heating system for Natural grass should be operated during 3-6 weeks before the start of the field use in spring.

This is required to ensure that the grass starts growing before the first match or training takes place. Failure to do so will result in fast destruction of the playing surface.

## Calculation of cables on drum

A single conductor DSM3 (DEVI sport™) and DEVI basic™ heating cables are available on drums. In this case heating cables can be selected and calculated with any linear output (W/m), but not exceeding the max. value. As a result the length of a separate heating cable can be calculated based on the field size.

For example, standard Ohm/m values that are used for cables on drum for football fields are as follows:

DSM3 (DEVI sport™) - 0,04, 0,06, 0,085, 0,1, 0,15, 0,177 Ohm/m;  
DEVI basic™ - 0,032, 0,05, 0,07, 0,1, 0,15, 0,187, 0,21 Ohm/m.

For details concerning Ohm/m values for cables on drum please refer to the Danfoss/DEVI Catalogue.

One more advantage is that the accurate length of heating cables can be ensured during installation. But it should be noted that cold tail joints and terminal connections should be performed by qualified personnel only. Ensure that proper type and size of cold tail and joints are selected.

For calculation of heating cables on drums the following formulas can be used:

$$L = U / \sqrt{p \cdot r}, \quad (3)$$

$$p = U^2 / (L^2 \cdot r), \quad (4)$$

$$r = U^2 / (L^2 \cdot p), \quad (5)$$

where

$L$  – length of heating cable (m);

$U$  – supply voltage (V);

$p$  – linear output (W/m);

$r$  – linear resistance (Ohm/m).

## Example 1. Calculation cable on drum

Football field size: 70 x 110 m, power supply: 380 V, max. power of the lighting system transformers: 800 kW. Field renovation with cable installation by plough.



Max. heating system output is  $800 \text{ kW} / (70 \cdot 110) \text{ m}^2 = 103 \text{ W/m}^2$ .

The cable trench is supposed to be arranged along the long side of the pitch and cable lines along the short side accordingly. Area for cable installation is e.g. 69,4 x 109,4 m (without 30 cm indents from the edges). A single conductor cable is supposed to be installed – in 4 lines with the C-C distance of 20 cm, the preliminary cable output is 20 W/m and the heating system output is  $100/20 \cdot 20 \text{ W/m} = 100 \text{ W/m}^2$ .

Cable length is  $69,4 \text{ m} \cdot 4 = 277,6 \text{ m}$ .

DEVI sport™ on drum is considered and an appropriate Ohm/m value should be chosen. According to formula (5) the calculated Ohm/m is determined as follows:  
 $r = U^2 / (L^2 \cdot p) = 380^2 / (277,6^2 \cdot 20) = 0,094 \text{ Ohm/m}$ .

According to the calculated 0,094 Ohm/m DSM3 (DEVI sport™) with 0,085 Ohm/m should be chosen (see data in the Danfoss/DEVI Catalogue).

Cable linear output in W/m should be checked with max. values for the chosen 0,085 Ohm/m.

Cable linear output according to formula (4) is determined as:  
 $p = U^2 / (L^2 \cdot r) = 380^2 / (277,6^2 \cdot 0,085) = 22 \text{ W/m}$ .

Maximum W/m for DSM3 (DEVI sport™) is 30 W/m. So the chosen 277,6 m cable with 0,085 Ohm/m and 22 W/m output is correct.

For specified  $100 \text{ W/m}^2$  C-C distance should be (formula (2)):  
 $\text{C-C} = (22 \text{ W/m} / 100 \text{ W/m}^2) \cdot 100 \text{ cm} = 22 \text{ cm}$

Cable with 22 W/m is correct for possible maximum of  $104 \text{ W/m}^2$ .

Number of heating cables:  
 $109,4 \text{ m} / (0,22 \text{ m} \cdot 4) = 124 \text{ pcs}$ .  
Cable output:  
 $109,4 \text{ m} \cdot 22 \text{ W/m} = 5552 \text{ W}$ .

The calculation results are as follows:

- DEVI sport™ heating cable on drum;
- 277,6 m;
- 0,085 Ohm/m;
- 22 W/m;
- 124 pcs.;
- $100 \text{ W/m}^2$ ;
- system output 688,5 kW;
- installation with 4 lines per cable;
- installation along the short side of the field.

## Example 2. Football field

A football field of 70 x 110 m is to be covered with new grass, and at the same time renewed to be playable during extra 2-3 months per year.

The artificial grass is chosen and the heating solution is offered with DEVI heat™ 90S heating mats (70,5 m length, 3245 W at 230 V).

A mat covers 0,5 m width. Considering the size of the field that is 110 m,  $110 / 0,5 = 220$  pieces of 70,5 m long mat are selected.

220 pcs. mats of 3245 W are installed amounting to a total of  $3245 \cdot 220 = 713,9 \text{ kW}$ .

## Example 3. Golf field

On a golf course a number of greens with a total area of  $975 \text{ m}^2$  are to be heated with DSM3 (DEVI sport™) heating cable. An output of  $80 \text{ W/m}^2$  is installed amounting to a total of 78 kW.

As taking the course out of commission is not possible, specially constructed plough is utilized.

Field is playable the next day.



# 5. Installation

Heating cables can be laid during the construction of a new or remodeling of an existing grass surface. Distance between the wires depends on the required heating power per square meter, and typically is about 15-25 cm.

Danfoss is recommending installation on the depth of 25-30 cm (up to 35 cm), which protects the cable from damage by equipment used for reclamation of turf, posts and other.

Measure, verify and record element and insulation resistances during installation.

- After unpacking
- After fastening the elements
- After the installation is finalized.

## 5.1 Plowing in cables under natural grass

There is also the possibility of laying heating cables in the existing playing surface (turf). The installation is done using a special plough, on which there is a drum with a cable, which simultaneously cuts furrow and places in the heating cable at a required depth. Using the pitch is possible after about 10-12 days of laying the heating cable when the new grass cover traces of the passing plow.

For plough installation special heating cable with high level of pulling strength has to be used. DSM3 (DEVIsport™) is the only possibly choice for plowing in cables under natural grass.

Before installation of cable, field opposite edges are marked with paint showing distance between cable lines. After that a cord serving driver a checkpoint is pulled and fixed between marking.

A cable drum is placed on handling device. Cold lead (supply cord provided with the heating cable) unwinded manually from the drum, while heating cable is led to guiding mechanism. Tractor starts moving from the edge of the field simultaneously lowering handling device and mechanism of cable installation. When reaching the field's opposite side, the handling device rises, tractor turns around and process is repeated. While tractor's turning around, it's necessary to unwind cable from drum manually and rewind it on drum after the maneuver is performed.

with a road roller.

Time required for installation of one cable's 4 coils - 20 minutes. Thus, it will take approximately 2 weeks to install all the cables, for a standard size football field (disregarding days of bad, rainy weather).

Remained on the surface heating cable which wasn't embedded with handling device is placed into the necessary depth together with cold tails, manually.

After the ploughing prepare, cultivate the grass and make soil restoration



After the ploughing prepare, cultivate the grass and make soil restoration with a road roller.



## 5.2 Laying out (natural or artificial grass)

There are several possibilities of buildup of under-layers for football field. It's important to follow the instructions given by the manufacturer of the artificial grass.

A system has typically following layers (bottom to top):

- At the bottom hard and frost-free ground / soil / sand
- Shock pad (for absorbing of jumps and etc., performed during play)
- Heating element, e.g. DSVF-90 (DEVIheat™ 90S) mat
- Artificial turf
- 4-5 cm infill in the grass (if necessary, depending on type of artificial grass)

Single conductor heating mat DSVF-90 (DEVIheat™ 90S) for installation under artificial grass is usually used.

Though it is small, the sturdy heating element resists the continuous stress from players and vehicles.

Fix the mat using the special synthetic nails, and stretch the mat towards the sideline.



Drainage mat, directly on soil.



Shock pad, laying out



DSVF-90 (DEVIheat™ 90S) mat is laid out.



When reaching the sideline, secure the heating mat to the surface with special synthetic nails for every 30 cm.

Provide artificial fill, if necessary.

Slice the cold leads in the shock pad. Be careful not to slice the cold lead too deep in the shock-pad.

The cold leads are sliced to nearest cable vault towards the power supply.



## 5.3 Electrical connection

To control the heating system recommended thermostats are EFET 330 (5...45 °C) cooperating with the temperature sensor placed in the rooting zone of grass, about 25 cm below the surface.

It is recommended to divide the playing surface into several zones controlled by separate thermostats and sensors. It gives a possibility for division of connected power and optimizes the energy consumption, since the grass field is often subject to varied weather conditions like sun and cold temperature.

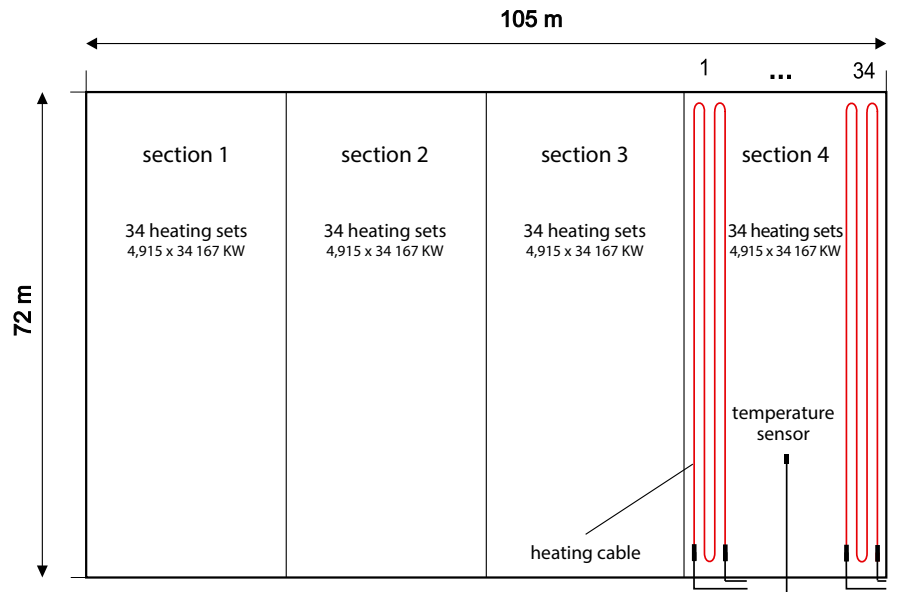

Example of installation of heating cables across a football field

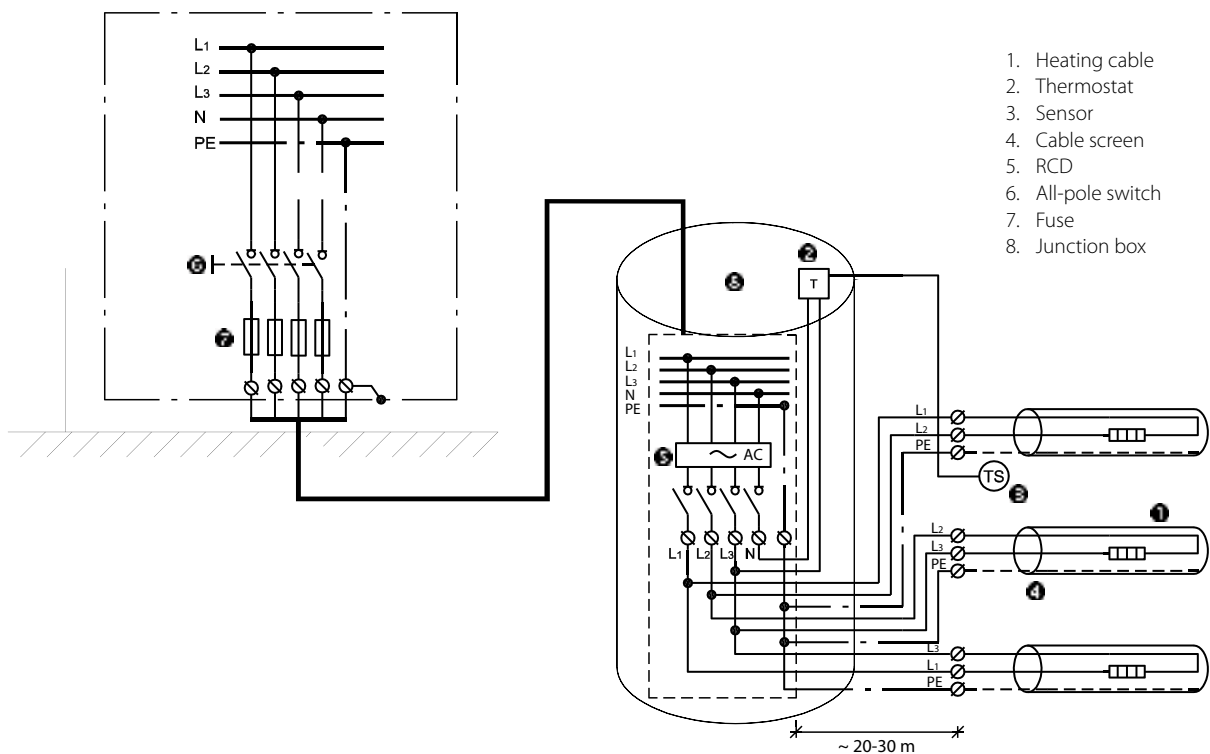

## 5.4. Note when installing cables

Please refer to the installation manual for outdoor heating applications to comply with the relevant rules and regulations.

It is not recommended to install heating elements at temperatures below -5 °C. At low temperatures, heating elements can become rigid.

For safety reasons:

- Heating system should always be turned off, when the field is in use;
- Heating systems for sports fields must be made using screened electrical cables, and must have a power supply protected by a differential switch / residual current device (RCD) connected at all times.

- The screen of all heating elements must be grounded in accordance with applicable regulations.
- Do not place heavy gear, like a scene, lift or crane on the surface of artificial field.
- Max. tyre pressure on the surface not more than 1 kg/cm<sup>2</sup>. If you have any doubts or questions regarding the installation or use of the application please contact Danfoss for further information.



## 6. Cases References

**Lokomotiv**, Nizhniy Novgorod, Russia, 1996

**Metalurg**, Kryvyi Rig, Ukraine, 1999

**Locomotive**, Donetsk, Ukraine, 2003

**FC "Vitebsk"**, Vitebsk, Belorussia, 2006

**AC "Steaua Bucuresti"**, Ghencea, Romania, 2007

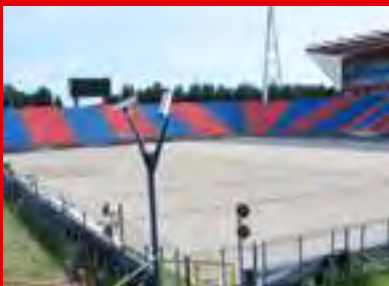

**Stadion Most**, Czech Republic, 2007

**Amica Wronki**, Poland, 2007



**LKS**, Łódź, Poland, 2007

**Widzew Łódź**, Poland, 2007

**Odra Wodzisław Slaski**, Poland, 2007

**Ioan Moina**, Romania, 2008

**Municipal Stadium**, Romania, 2008

**Tehelné Pole Stadion**, Slovakia, 2008

**Stadion in Bratislava**, Slovakia, 2008

**Training pitch FC "Werder Bremen"**, Bremen, Germany, 2009

**Constant Vanden Stock**, Anderlecht, Belgium, 2009

**Rhein Energie Stadion**, Köln, Germany, 2010



**Helsingin Olympiastadion**, Helsinki, Finland, 2010

**Silkeborg**, Denmark, 2011

**Otelul Stadium**, Galati, Romania, 2011

**Municipal Stadium "Gaz Metan"**, Medias, Romania, 2011

**Ilie Oana Stadium**, Ploiesti, Romania, 2011

**Fredrikstad Stadium**, Norway, 2011

**Atatürk Stadium**, Istanbul, Turkey, 2011

**Municipal Stadium Vaslui**, Romania, 2012

**Nicolae Dobrin Stadium**, Pitesti, Romania, 2012

**Marin Anastasovici Stadium**, Giurgiu, Romania, 2012

**Bilino polje Zenica**, Bosnia and Hercegovina, 2012

**Stavanger Gjesdal**, Norway, 2013

**Debrecen**, Hungary, 2013

**Telki**, Hungary, 2013

**Dacia Stadium**, Mioveni, Romania, 2014

**Municipal Stadium Botasani**, Botosani, Romania, 2014

**Ústí nad Labem**, Czech Republic, 2014

**Farum Park**, Denmark, 2012

**Zhetisu**, Kazakhstan, 2012

**Tineretului Stadium**, Brasov, Romania, 2012

**Municipal Stadium**, Vaslui, Romania, 2012

**Nicolae Dobrin Stadium**, Pitesti, Romania, 2012

**Marin Anastasovici Stadium**, Giurgiu, Romania, 2012

**Bilino polje Zenica**, Bosnia and Hercegovina, 2012

**Stavanger Gjesdal**, Norway, 2013

**Debrecen**, Hungary, 2013

**Telki**, Hungary, 2013

**Dacia Stadium**, Mioveni, Romania, 2014

**Municipal Stadium Botasani**, Botosani, Romania, 2014

**Ústí nad Labem**, Czech Republic, 2014

**Atatürk Stadium**, Konya, Turkey, 2014



**Fredrikstad Stadium**, Norway, 2015

**Atatürk Olympic Stadium**, Istanbul, Turkey, 2015

## 7. Cases

### FARUM PARK STADIUM, Farum, Denmark.

Cables were installed together with Limonta SoccerPro turf.  
The size of the field is 105 x 68 m.  
Heating area is 7140 m<sup>2</sup>.  
Heating element used: DEVIheat™ 90S.

Electric heating was installed between shockpad and artificial turf.

Installation was done in principal like a standard mat installation.

Special carbon nails were used in the installation to secure mat into under layer/shock pad.

Heating was split into eight zones due to limitation in supply. Only one zone is heating at the time.

- Zones are controlled by PLC individually.
- Each zone has two temperature sensors.



### RSCA ANDERLECHT STADIUM, Brussels, Belgium

Seed Beed Heating becomes mandatory in 2010 for stadiums in the Belgian First Division.

The RSC Anderlecht pitch is a semi synthetic field constructed in 2007. It is based on 90% sand and reinforced with 40 million PE fibers. The

investment at that time for RSCA was already about 500 k€ so making a whole new pitch was not an option.

The electrical system was chosen as

- The cables could be installed retrofit with a special machine without damaging more than 3% of the PE fibers and the field was playable after 4 weeks.

- The power supply was already available, thus saving the cost, approval and operation of a 720 kW gasfired boiler.

- The control of the heating cables was included in the existing PLC control SMART EYE for irrigation and draining.



**Danfoss A/S** · Heating Segment · Ulvehavevej 61 · 7100 Vejle · Denmark  
Tel.: +45 7488 8500 · Email: [heating@danfoss.com](mailto:heating@danfoss.com) · [www.heating.danfoss.com](http://www.heating.danfoss.com)

Danfoss can accept no responsibility for possible errors in catalogues, brochures and other printed material. Danfoss reserves the right to alter its products without notice. This also applies to products already on order provided that such alterations can be made without sub sequential changes being necessary in specifications already agreed. All trademarks in this material are property of the respective companies. Danfoss and the Danfoss logotype are trademarks of Danfoss A/S. All rights reserved.