



# Solenoid Valves Technical Information

## 4-Way, 2-Position Spool

### SV09-24-01



### OPERATION

This is a direct-acting, 4-way, 2-position, spool-type solenoid valve. Recommend the following connections: port 3 to inlet, ports 2 & 4 to actuator(s) and port 1 to drain. Follow the "Operating Envelope" limits to ensure shifting of the valve during operation. The 09 Series valve uses a 10 size cavity with an 08 size tube and coil, providing an optimal product for high flow and low pressure, while minimizing pressure drop in the system.



Shown with Standard Coil and Filter

### APPLICATIONS

Common applications include low-pressure on-off control of dual clutch systems or pressure-assist brakes. It can also be used for low pressure bi-directional control of motors. Refer to example circuits. Use the optional screen to help protect the actuator from large particles. Select the robust coil for those extreme environmental conditions – voltage extremes, high temperature, shock & vibration, chemicals, and/or water ingress.



Shown with Robust Coil and Filter

### SPECIFICATIONS

Rated pressure*	100 bar [1450 psi]
Maximum flow at 7 bar [100 psi]	20 l/min [5.33 US gal/min]
Leakage	75 ml/min [5.6 In <sup>3</sup> /min]
Weight including coil	0.37 kg [0.78 lb]
Cavity	<b>SDC10-4</b>
Standard Coil	<b>M13</b> 20 Watt
Robust Coil	<b>R13</b> 16 Watt Robust Nut P/N <b>173800539</b> (no coil O-rings needed)

\* Rated Pressure based on NFPA fatigue test standards (at 1 Million Cycles).

### SCHEMATIC

No Filter Option

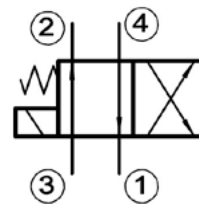

Filter Option

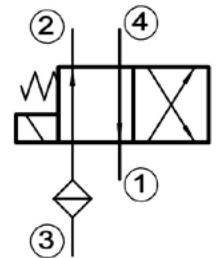

### PERFORMANCE CURVES

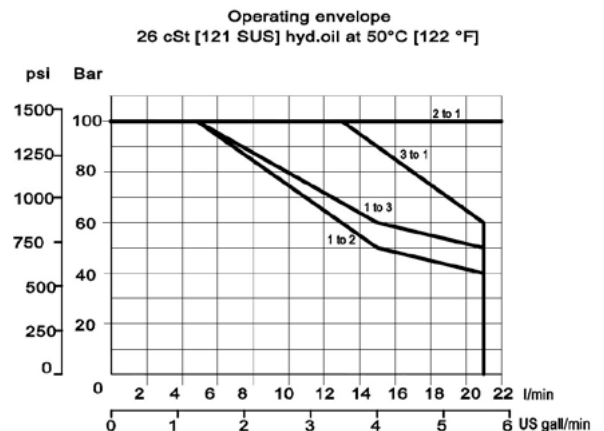
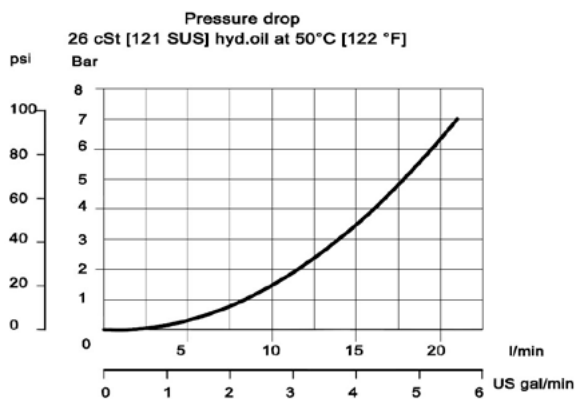



# Solenoid Valves Technical Information

## 4-Way, 2-Position Spool

### SV09-24-01



### DIMENSIONS

mm [in]

### Cross-sectional view

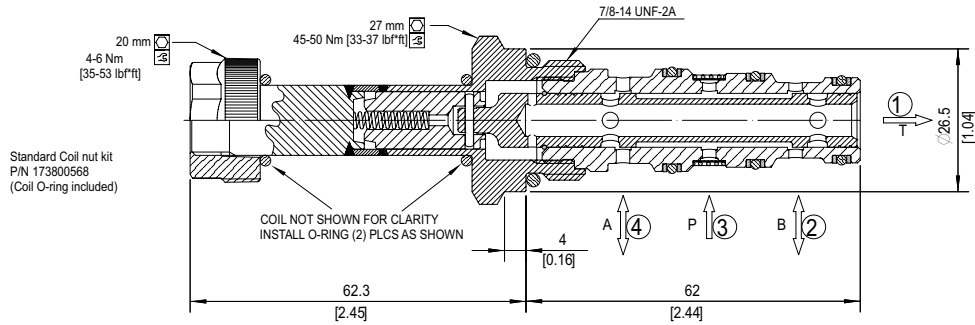

### EXAMPLE CIRCUITS

Bi-Directional Control of Motors - Low Pressure

Dual Clutch System Using Pressure Reducing Valve and 2-Position, 4-Way Solenoid

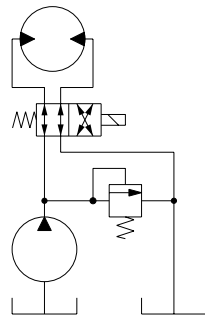

P103 114

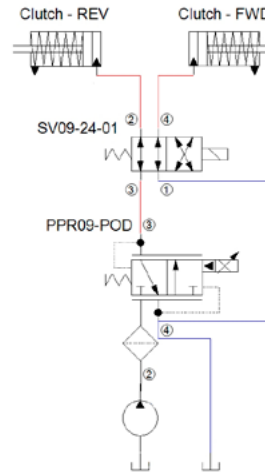

### ORDERING INFORMATION

**SV09 - 24 - 01 - 12D - DE - B - F - 00**

Solenoid Valve, Spool Type, 10 Size Cavity

24: 2 Position, 4 Way

01: Normally Open Schematic

Filter: No Filter 500 µm Omit F

Code	Body and Ports	Body Nomenclature
00	Cartridge Only	No Body
4S	#4 SAE, AL	CP08-3-4S
6S	#6 SAE, AL	CP08-3-6S
SE2B	1/4 BSP, AL	SDC08-3-SE2B
SE3B	3/8 BSP, AL	SDC08-3-SE3B

Seal Code	Material	Seal Kits
B	Buna-N	354001919
V	Viton	354002019

Coil Voltage	Standard Coil Code	Robust Coil Code
No Coil, with nut*	00	R00
10 VDC	10D	R10D
12 VDC	12D	R12D
20 VDC	20D	R20D
24 VDC	24D	R24D
110 VAC**	110A	-
220 VAC**	220A	-

\* Standard coil – plastic nut and O-rings  
R-coil – steel nut P/N 173800539 (no coil O-rings needed)  
\*\* DIN only - external rectifier needed

Coil Termination	Standard Coil Code	IP Rating	Robust Coil Code	IP Rating
No Coil	00	-	00	-
Amp Junior	AJ	IP67	-	-
Amp Junior with Diode	AJD	IP67	-	-
AMP SuperSeal 1.5	AS	IP67	AS	IP69K
AMP SuperSeal with Diode	ASD	IP67	ASDB	IP69K
Deutsch	DE	IP67	DE	IP69K
Deutsch with Diode	DED	IP67	DEDB	IP69K
Flying Leads	FL	IP65	FL	IP65
Flying Leads with Diode	FLD	IP65	FLDB	IP65
DIN 43650	DN	IP65	-	-
Metri-Pack 150, Type 2	-	-	M3	IP69K
Metri-Pack 150 with Diode	-	-	M3DB	IP69K