

## Operating Guide

# ECL Comfort 310, application A361



## 1.0 Table of Contents

<b>1.0 Table of Contents</b> .....	<b>1</b>	<b>6.0 Common controller settings</b> .....	<b>89</b>
1.1 Important safety and product information.....	2	6.1 Introduction to 'Common controller settings' .....	89
<b>2.0 Installation</b> .....	<b>5</b>	6.2 Time & Date.....	90
2.1 Before you start .....	5	6.3 Holiday .....	91
2.2 Identifying the system type.....	9	6.4 Input overview .....	93
2.3 Mounting .....	10	6.5 Log .....	94
2.4 Placing the temperature sensors.....	14	6.6 Output override.....	95
2.5 Electrical connections.....	16	6.7 Key functions.....	96
2.6 Inserting the ECL Application Key .....	25	6.8 System.....	98
2.7 Check list .....	32	<b>7.0 Miscellaneous</b> .....	<b>105</b>
2.8 Navigation, ECL Application Key A361 .....	33	7.1 ECA 30 / 31 setup procedures .....	105
<b>3.0 Daily use</b> .....	<b>36</b>	7.2 Override function.....	113
3.1 How to navigate .....	36	7.3 Several controllers in the same system .....	116
3.2 Understanding the controller display .....	37	7.4 Frequently asked questions.....	119
3.3 A general overview: What do the symbols mean? .....	40	7.5 Definitions .....	122
3.4 Monitoring temperatures and system components .....	41	7.6 Type (ID 6001), overview .....	126
3.5 Influence overview .....	42	7.7 Automatic / manual update of firmware.....	127
3.6 Manual control.....	43	7.8 Parameter ID overview.....	128
3.7 Schedule .....	44		
<b>4.0 Settings overview</b> .....	<b>45</b>		
<b>5.0 Settings</b> .....	<b>47</b>		
5.1 Introduction to Settings .....	47		
5.2 Flow temperature.....	48		
5.3 Return limit .....	53		
5.4 Flow / power limit .....	57		
5.5 Optimization.....	61		
5.6 Control parameters.....	67		
5.7 Pump control.....	71		
5.8 Refill water .....	74		
5.9 Application .....	79		
5.10 Alarm .....	84		
5.11 Alarm overview .....	88		

## Operating Guide ECL Comfort 310, application A361

### 1.1 Important safety and product information

#### 1.1.1 Important safety and product information

This Installation Guide is associated with ECL Application Key A361 (order code no. 087H3804).

The functions can be realized with ECL Comfort 310.

The application A361 complies with ECL Comfort controller 310 as of software version 1.10 (visible at start-up of the controller and in 'Common controller settings' in 'System').

Additional documentation for ECL Comfort 210 and 310, modules and accessories is available on <http://heating.danfoss.com/>.



Application keys might be released before all display texts are translated. In this case the text is in English.



#### **Automatic update of controller software (firmware):**

The software of the controller is updated automatically when the key is inserted (as of controller version 1.11 (ECL 210 / 310) and version 1.58 (ECL 296)). The following animation will be shown when the software is being updated:

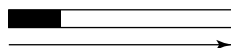

*Progress bar*

During update:

- Do not remove the KEY  
If the key is removed before the hour-glass is shown, you have to start afresh.
- Do not disconnect the power  
If the power is interrupted when the hour-glass is shown, the controller will not work.
- Manual update of controller software (firmware):  
See the section "Automatic / manual update of firmware"



**Safety Note**

To avoid injury of persons and damages to the device, it is absolutely necessary to read and observe these instructions carefully.

Necessary assembly, start-up, and maintenance work must be performed by qualified and authorized personnel only.

Local legislations must be respected. This comprises also cable dimensions and type of isolation (double isolated at 230 V).

A fuse for the ECL Comfort installation is max. 10 A typically.

The ambient temperature ranges for ECL Comfort in operation are:

ECL Comfort 210 / 310: 0 - 55 °C

ECL Comfort 296: 0 - 45 °C.

Exceeding the temperature range can result in malfunctions.

Installation must be avoided if there is a risk for condensation (dew).

The warning sign is used to emphasize special conditions that should be taken into consideration.



This symbol indicates that this particular piece of information should be read with special attention.



As this Operating Guide covers several system types, special system settings will be marked with a system type. All system types are shown in the chapter: 'Identifying your system type'.



°C (degrees Celsius) is a measured temperature value whereas K (Kelvin) often is used for temperature differences.



The ID no. is unique for the selected parameter.

Example	First digit	Second digit	Last three digits
11174	1	1	174
	-	Circuit 1	Parameter no.
12174	1	2	174
	-	Circuit 2	Parameter no.

If an ID description is mentioned more than once, it means that there are special settings for one or more system types. It will be marked with the system type in question (e.g. 12174 - A266.9).



Parameters indicated with an ID no. like "1x607" mean a universal parameter.  
x stands for circuit / parameter group.



**Disposal Note**

This symbol on the product indicates that it may not be disposed of as household waste.  
It must be handed over to the applicable take-back scheme for the recycling of electrical and electronic equipment.

- Dispose of the product through channels provided for this purpose.
- Comply with all local and currently applicable laws and regulations.

## Operating Guide ECL Comfort 310, application A361

### 2.0 Installation

#### 2.1 Before you start

The application **A361.1** is very flexible. These are the basic principles:

##### Heating (circuit 1 and 2):

Typically, the flow temperature is adjusted according to your requirements. The flow temperature sensor S3 (circuit 1) and S4 (circuit 2) are the most important sensors. The desired flow temperatures at S3 and S4 are calculated in the ECL controller, based on the outdoor temperature (S1). The lower the outdoor temperature, the higher the desired flow temperature.

By means of a week schedule, the heating circuit can be in 'Comfort' or 'Saving' mode (two different temperature values for desired room temperature).

The motorized control valves M1 (circuit 1) and M2 (circuit 2) are opened gradually when the flow temperature is lower than the desired flow temperature and vice versa.

The return temperatures S5 (circuit 1) and S6 (circuit 2) to the district heating supply should not be too high. If so, the desired flow temperature can be adjusted (typically to a lower value), thus resulting in a gradual closing of the motorized control valves.

In boiler-based heating supply the return temperature should not be too low (same adjustment procedure as above).

Furthermore, the return temperature limitation can be dependent of the outdoor temperature. Typically, the lower the outdoor temperature, the higher the accepted return temperature.

The circulation pump in question is ON at heat demand or at frost protection.

The heating can be switched OFF when the outdoor temperature is higher than a selectable value.

The static pressure on the secondary side (consumer side) can 1) be measured as a 0 - 10 V signal (from a pressure transmitter) or 2) be a switch signal from a pressure switch. In case of a too low pressure, the refill water function will supplement with water from the supply side.

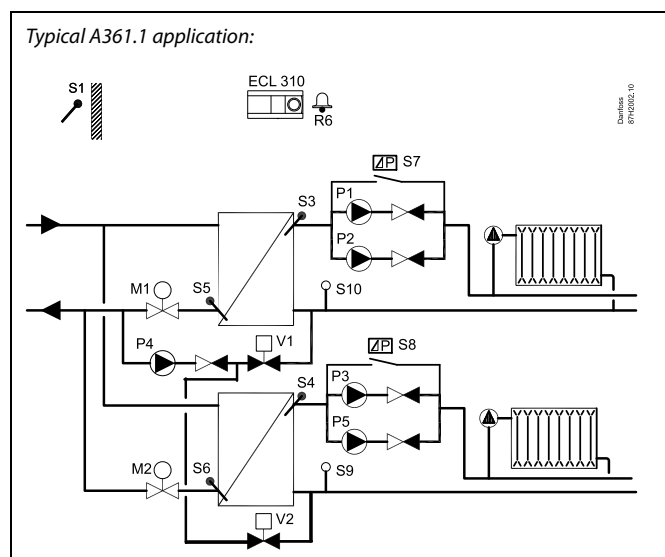

The shown diagram is a fundamental and simplified example and does not contain all components that are necessary in a system.

All named components are connected to the ECL Comfort controller.

##### List of components:

- S1 Outdoor temperature sensor
- S3 Flow temperature sensor, circuit 1
- S4 Flow temperature sensor, circuit 2
- S5 Return temperature sensor, circuit 1
- S6 Return temperature sensor, circuit 2
- S7 Differential pressure switch, circuit 1
- S8 Differential pressure switch, circuit 2
- S9 Pressure transmitter or pressure switch, circuit 2
- S10 Pressure transmitter or pressure switch, circuit 1
- P1 Circulation pump, circuit 1
- P2 Circulation pump, circuit 1
- P3 Circulation pump, circuit 2
- P4 Refill water pump
- P5 Circulation pump, circuit 2
- M1 Motorized control valve, circuit 1
- M2 Motorized control valve, circuit 2
- V1 Solenoid valve, circuit 1, refill water valve
- V2 Solenoid valve, circuit 2, refill water valve
- R6 Relay output, alarm

## Operating Guide ECL Comfort 310, application A361

### Application A361.1 in general:

The circulation pumps P1 and P2 (circuit 1) / P3 and P5 ( circuit 2) work in shift according to a schedule. One pump is used as spare pump and the other pump is working. In case of malfunction (missing differential pressure) of one pump, the other pump will take over. An alarm will be generated and the defective pump can be inspected / repaired.

Alarm (relay 6) can be activated if:

- The actual flow temperature differs from the desired flow temperature.
- The activated circulation pump does not generate a pressure difference.
- The refill water function does not generate a pressure within a preset time.

Modbus communication to a SCADA system can be established.

M-bus communication enables connection to flow or energy meter. The controller can limit the flow or energy to a set maximum but also in relation to the outdoor temperature.

Furthermore, the M-bus data can be transferred to the Modbus communication.

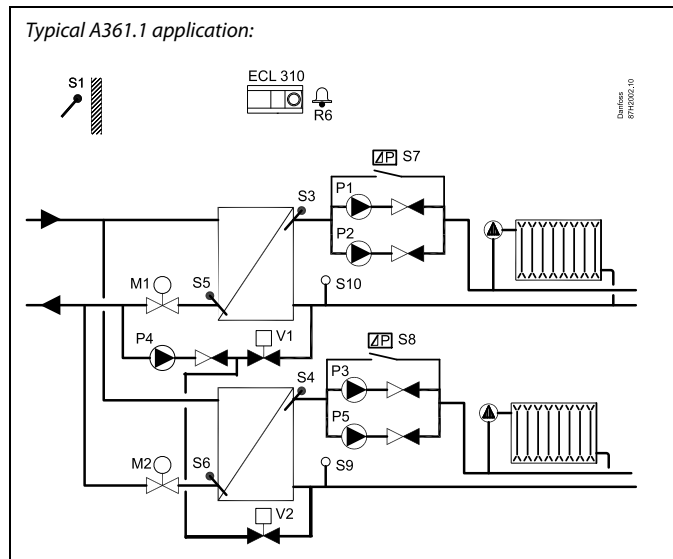

## Operating Guide ECL Comfort 310, application A361

The application **A361.2** is very flexible. These are the basic principles:

### Heating (circuit 1 and 2):

Typically, the flow temperature is adjusted according to your requirements. The flow temperature sensor S3 (circuit 1) and S4 (circuit 2) are the most important sensors. The desired flow temperatures at S3 and S4 are calculated in the ECL controller, based on the outdoor temperature (S1). The lower the outdoor temperature, the higher the desired flow temperature.

The supply temperature (S2) is used to 1) control the S3 and S4 temperatures in relation to the S2 temperature or 2) maximize the limit of the desired flow temperature.

The factory setting, where the supply temperature (S2) determines the desired flow temperature, does not change the desired flow temperature according to 'Comfort' or 'Saving' mode.

However, if the supply temperature (S2) determines a max. limitation of the desired flow temperature, the 'Comfort' and 'Saving' mode will have two different temperature values for desired room temperature.

The motorized control valves M1 (circuit 1) and M2 (circuit 2) are opened gradually when the flow temperature is lower than the desired flow temperature and vice versa.

The return temperatures S5 (circuit 1) and S6 (circuit 2) to the district heating supply should not be too high. If so, the desired flow temperature can be adjusted (typically to a lower value), thus resulting in a gradual closing of the motorized control valves.

In boiler-based heating supply the return temperature should not be too low (same adjustment procedure as above).

Furthermore, the return temperature limitation can be dependent of the outdoor temperature. Typically, the lower the outdoor temperature, the higher the accepted return temperature.

The circulation pump in question is ON at heat demand or at frost protection.

The heating can be switched OFF when the outdoor temperature is higher than a selectable value.

The static pressure on the secondary side (consumer side) can 1) be measured as a 0 - 10 V signal (from a pressure transmitter) or 2) be a switch signal from a pressure switch. In case of a too low pressure, the refill water function will supplement with water from the supply side.

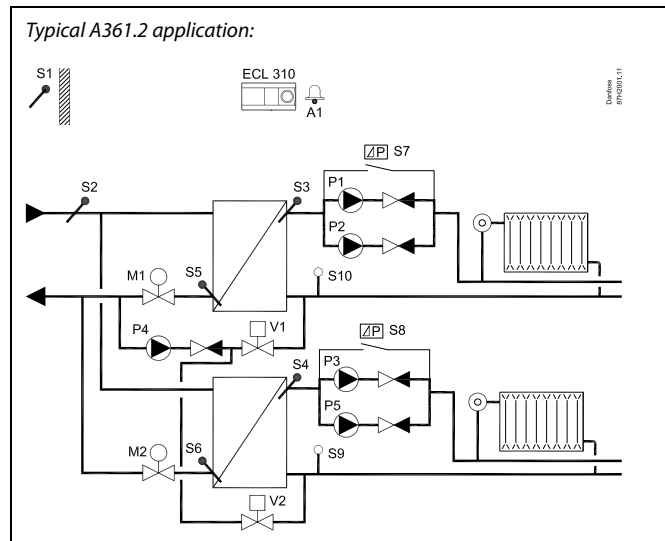

The shown diagram is a fundamental and simplified example and does not contain all components that are necessary in a system.

All named components are connected to the ECL Comfort controller.

### List of components:

- S1 Outdoor temperature sensor
- S2 Supply flow temperature sensor
- S3 Flow temperature sensor, circuit 1
- S4 Flow temperature sensor, circuit 2
- S5 Return temperature sensor, circuit 1
- S6 Return temperature sensor, circuit 2
- S7 Differential pressure switch, circuit 1
- S8 Differential pressure switch, circuit 2
- S9 Pressure transmitter or pressure switch, circuit 2
- S10 Pressure transmitter or pressure switch, circuit 1
- P1 Circulation pump, circuit 1
- P2 Circulation pump, circuit 1
- P3 Circulation pump, circuit 2
- P4 Refill water pump
- P5 Circulation pump, circuit 2
- M1 Motorized control valve, circuit 1
- M2 Motorized control valve, circuit 2
- V1 Solenoid valve, circuit 1, refill water valve
- V2 Solenoid valve, circuit 2, refill water valve
- R6 Relay output, alarm

## Operating Guide ECL Comfort 310, application A361

### Application A361.2 in general:

The circulation pumps P1 and P2 ( circuit 1) / P3 and P5 ( circuit 2) work in shift according to a schedule. One pump is used as spare pump and the other pump is working. In case of malfunction (missing differential pressure) of one pump, the other pump will take over. An alarm will be generated and the defective pump can be inspected / repaired.

Alarm (relay 6) can be activated if:

- The actual flow temperature differs from the desired flow temperature.
- The activated circulation pump does not generate a pressure difference.
- The refill water function does not generate a pressure within a preset time.

Modbus communication to a SCADA system can be established.

M-bus communication enables connection to flow or energy meter. The controller can limit the flow or energy to a set maximum but also in relation to the outdoor temperature.

Furthermore, the M-bus data can be transferred to the Modbus communication.

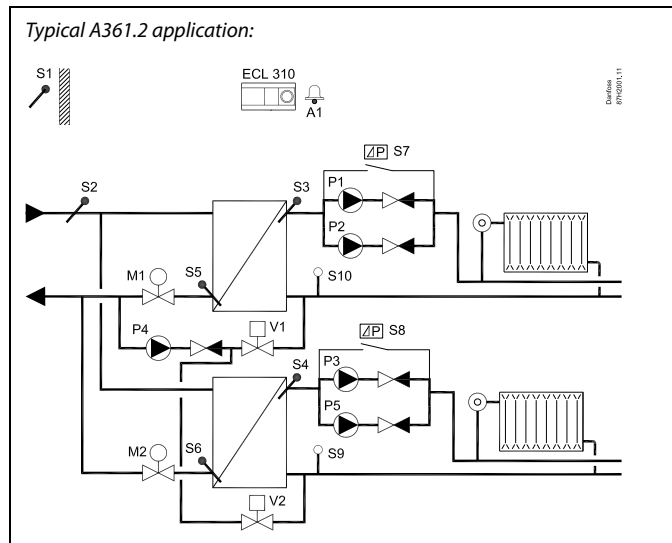

The controller is pre-programmed with factory settings that are shown in the 'Parameter ID overview' appendix.



## Operating Guide ECL Comfort 310, application A361

### 2.2 Identifying the system type

#### Sketch your application

The ECL Comfort controller series is designed for a wide range of heating, domestic hot-water (DHW) and cooling systems with different configurations and capacities. If your system differs from the diagrams shown here, you may want to make a sketch of the system about to be installed. This makes it easier to use the Operating Guide, which will guide you step-by-step from installation to final adjustments before the end-user takes over.

The ECL Comfort controller is a universal controller that can be used for various systems. Based on the shown standard systems, it is possible to configure additional systems. In this chapter you find the most frequently used systems. If your system is not quite as shown below, find the diagram which has the best resemblance with your system and make your own combinations.

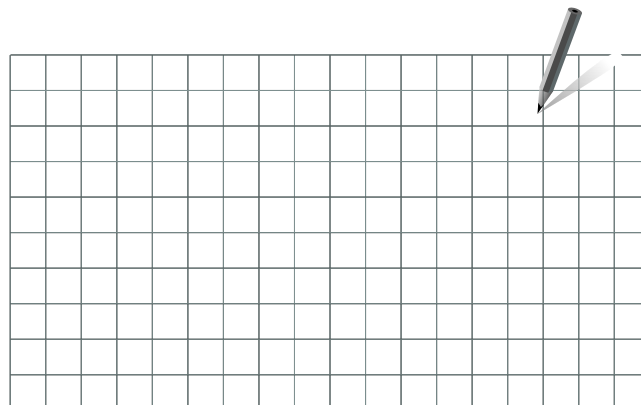

See the Installation Guide (delivered with the application key) for application types / sub-types.



The circulation pump(s) in heating circuit(s) can be placed in the flow as well as the return. Place the pump according to the manufacturer's specification.

## Operating Guide ECL Comfort 310, application A361

### 2.3 Mounting

#### 2.3.1 Mounting the ECL Comfort controller

See the Installation Guide which is delivered together with the ECL Comfort controller.

For easy access, you should mount the ECL Comfort controller near the system.

ECL Comfort 210 / 296 / 310 can be mounted

- on a wall
- on a DIN rail (35 mm)

ECL Comfort 296 can be mounted

- in a panel cut-out

ECL Comfort 210 can be mounted in an ECL Comfort 310 base part (for future upgrade).

Screws, PG cable glands and rawlplugs are not supplied.

#### Locking the ECL Comfort 210 / 310 controller

In order to fasten the ECL Comfort controller to its base part, secure the controller with the locking pin.



To prevent injuries to persons or the controller, the controller has to be securely locked into the base. For this purpose, press the locking pin into the base until a click is heard and the controller no longer can be removed from the base.



If the controller is not securely locked into the base part, there is a risk that the controller during operation can unlock from the base and the base with terminals (and also the 230 V a.c. connections) are exposed. To prevent injuries to persons, always make sure that the controller is securely locked into its base. If this is not the case, the controller should not be operated!



The easy way to lock the controller to its base or unlock it is to use a screw driver as lever.

### Mounting on a wall

Mount the base part on a wall with a smooth surface. Establish the electrical connections and position the controller in the base part. Secure the controller with the locking pin.

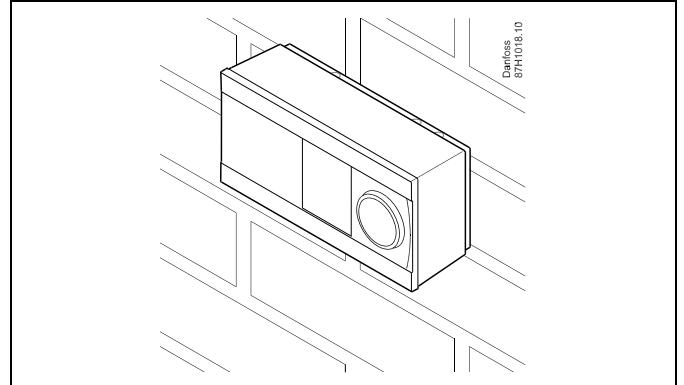

### Mounting on a DIN rail (35 mm)

Mount the base part on a DIN rail. Establish the electrical connections and position the controller in the base part. Secure the controller with the locking pin.

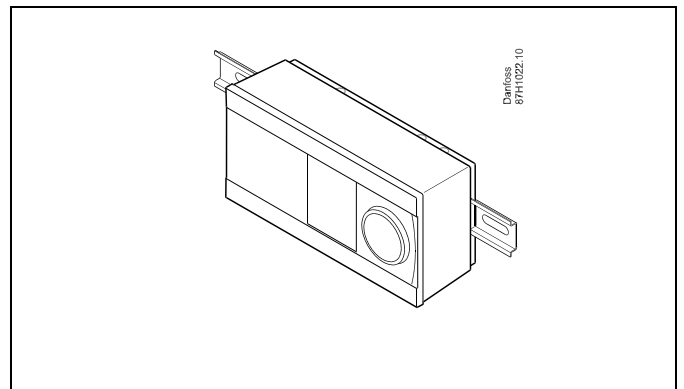

### Dismounting the ECL Comfort controller

In order to remove the controller from the base part, pull out the locking pin by means of a screwdriver. The controller can now be removed from the base part.

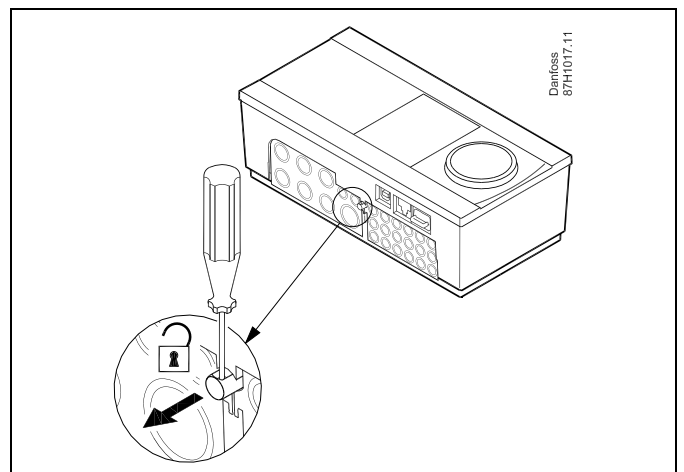

The easy way to lock the controller to its base or unlock it is to use a screw driver as lever.



Before removing the ECL Comfort controller from the base part, ensure that the supply voltage is disconnected.

### 2.3.2 Mounting the Remote Control Units ECA 30 / 31

Select one of the following methods:

- Mounting on a wall, ECA 30 / 31
- Mounting in a panel, ECA 30

Screws and rawlplugs are not supplied.

#### Mounting on a wall

Mount the base part of the ECA 30 / 31 on a wall with a smooth surface. Establish the electrical connections. Place the ECA 30 / 31 in the base part.

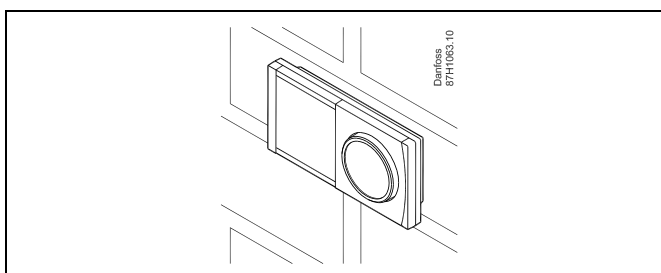

#### Mounting in a panel

Mount the ECA 30 in a panel using the ECA 30 frame kit (order code no. 087H3236). Establish the electrical connections. Secure the frame with the clamp. Place the ECA 30 in the base part. The ECA 30 can be connected to an external room temperature sensor.

The ECA 31 must not be mounted in a panel if the humidity function is to be used.

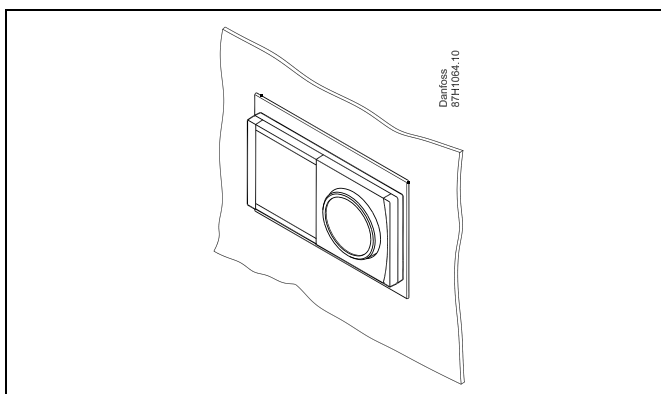

## Operating Guide ECL Comfort 310, application A361

### 2.3.3 Mounting the internal I/O module ECA 32

#### Mounting of the internal I/O module ECA 32

The ECA 32 module (order code no. 087H3202) must be inserted into the ECL Comfort 310 / 310B base part for additional input and output signals in relevant applications.

The connection between the ECL Comfort 310 / 310B and ECA 32 is a 10-pole (2 x 5) connector. The connection is automatically established when the ECL Comfort 310 / 310B is placed on the base part.

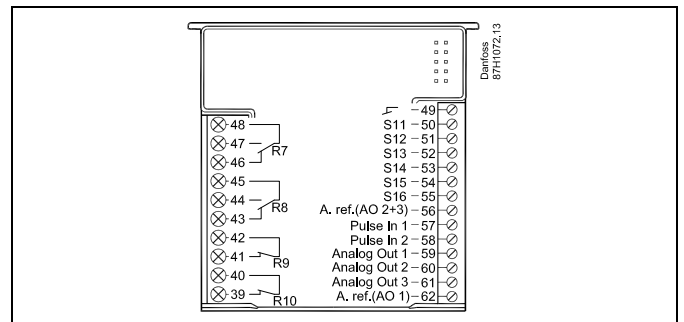
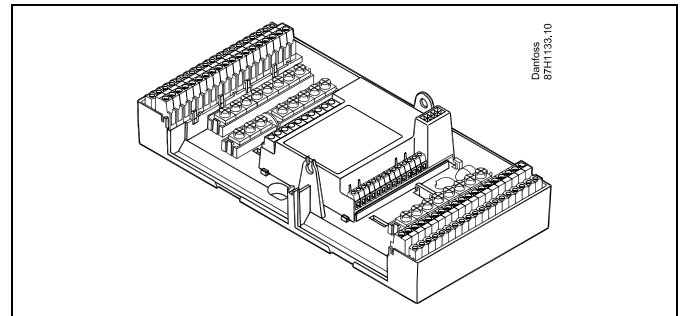

## Operating Guide ECL Comfort 310, application A361

### 2.4 Placing the temperature sensors

#### 2.4.1 Placing the temperature sensors

It is important that the sensors are mounted in the correct position in your system.

The temperature sensor mentioned below are sensors used for the ECL Comfort 210 / 296 / 310 series which not all will be needed for your application!

#### Outdoor temperature sensor (ESMT)

The outdoor sensor should be mounted on that side of the building where it is less likely to be exposed to direct sunshine. It should not be placed close to doors, windows or air outlets.

#### Flow temperature sensor (ESMU, ESM-11 or ESMC)

Place the sensor max. 15 cm from the mixing point. In systems with heat exchanger, Danfoss recommends that the ESMU-type to be inserted into the exchanger flow outlet.

Make sure that the surface of the pipe is clean and even where the sensor is mounted.

#### Return temperature sensor (ESMU, ESM-11 or ESMC)

The return temperature sensor should always be placed so that it measures a representative return temperature.

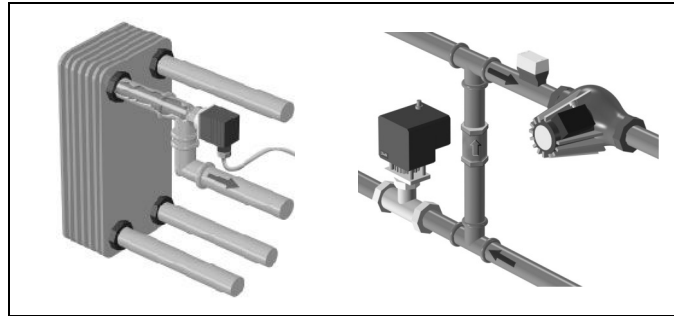

#### Room temperature sensor (ESM-10, ECA 30 / 31 Remote Control Unit)

Place the room sensor in the room where the temperature is to be controlled. Do not place it on outside walls or close to radiators, windows or doors.

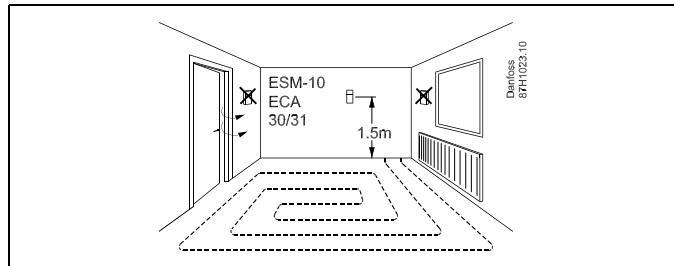

#### Boiler temperature sensor (ESMU, ESM-11 or ESMC)

Place the sensor according to the boiler manufacturer's specification.

#### Air duct temperature sensor (ESMB-12 or ESMU types)

Place the sensor so that it measures a representative temperature.

#### DHW temperature sensor (ESMU or ESMB-12)

Place the DHW temperature sensor according to the manufacturer's specification.

#### Slab temperature sensor (ESMB-12)

Place the sensor in a protection tube in the slab.



ESM-11: Do not move the sensor after it has been fastened in order to avoid damage to the sensor element.



ESM-11, ESMC and ESMB-12: Use heat conducting paste for quick measurement of the temperature.



ESMU and ESMB-12: Using a sensor pocket to protect the sensor will, however, result in a slower temperature measurement.

# Operating Guide ECL Comfort 310, application A361

Pt 1000 temperature sensor (IEC 751B, 1000  $\Omega$  / 0  $^{\circ}\text{C}$ )

Relationship between temperature and ohmic value:

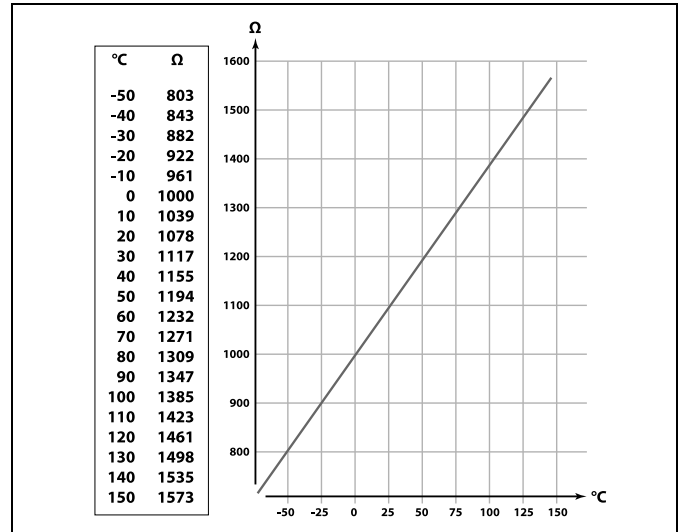

## Operating Guide ECL Comfort 310, application A361

---

### 2.5 Electrical connections

#### 2.5.1 Electrical connections 230 V a.c.

**Warning**

Electric conductors on PCB (**P**rinted **C**ircuit **B**oard) for supply voltage, relay contacts and triac outputs do not have mutual safety distance of minimum 6 mm. The outputs are not allowed to be used as galvanic separated (voltage free) outputs.

If a galvanic separated output is needed, an auxiliary relay is recommended.

24 Volt controlled units, for example actuators, are to be controlled by means of ECL Comfort 310, 24 Volt version.

**Safety Note**

Necessary assembly, start-up, and maintenance work must be performed by qualified and authorized personnel only.

Local legislations must be respected. This comprises also cable size and isolation (reinforced type).

A fuse for the ECL Comfort installation is max. 10 A typically.

The ambient temperature range for the ECL Comfort in operation is 0 - 55 °C. Exceeding this temperature range can result in malfunctions.

Installation must be avoided if there is a risk for condensation (dew).



## Operating Guide ECL Comfort 310, application A361

The common ground terminal is used for connection of relevant components (pumps, motorized control valves).

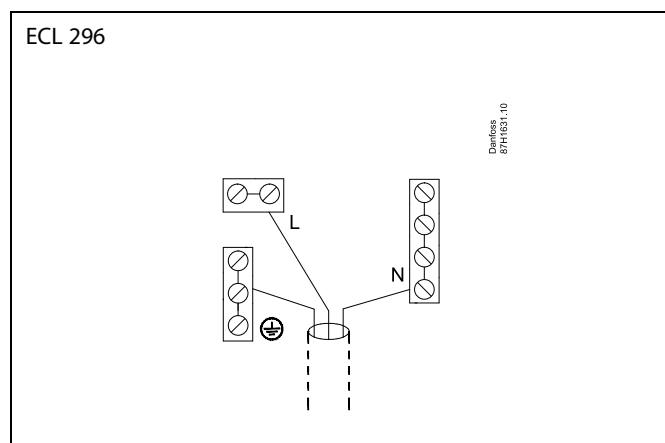
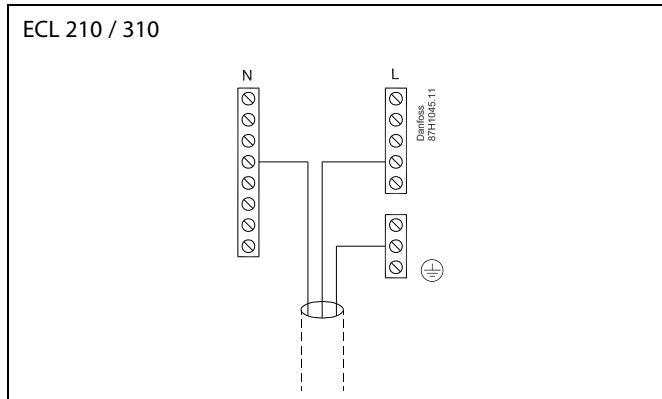

See also the Installation Guide (delivered with the application key) for application specific connections.



Wire cross section: 0.5 - 1.5 mm<sup>2</sup>  
 Incorrect connection can damage the electronic outputs.  
 Max. 2 x 1.5 mm<sup>2</sup> wires can be inserted into each screw terminal.

### Maximum load ratings:

R	Relay terminals	4 (2) A / 230 V a.c. (4 A for ohmic load, 2 A for inductive load)
Tr	Triac (= electronic relay) terminals	0,2 A / 230 V a.c.

## Operating Guide ECL Comfort 310, application A361

### 2.5.2 Electrical connections 24 V a.c.

See also the Installation Guide (delivered with the application key) for application specific connections.

#### Maximum load ratings:

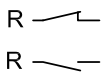
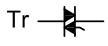
	Relay terminals	4 (2) A / 24 V a.c. (4 A for ohmic load, 2 A for inductive load)
	Triac (= electronic relay) terminals	1 A / 24 V a.c.



Do not connect 230 V a.c. powered components to a 24 V a.c. power supplied controller directly. Use auxiliary relays (K) to separate 230 V a.c. from 24 V a.c.

## Operating Guide ECL Comfort 310, application A361

---

### 2.5.3 Electrical connections, safety thermostats, in general

See also the Installation Guide (delivered with the application key) for application specific connections.



When ST is activated by a high temperature, the safety circuit in the motorized control valve closes the valve immediately.



When ST1 is activated by a high temperature (the TR temperature), the motorized control valve is closed gradually. At a higher temperature (the ST temperature), the safety circuit in the motorized control valve closes the valve immediately.

## Operating Guide ECL Comfort 310, application A361

### 2.5.4 Electrical connections, Pt 1000 temperature sensors and signals

See the Installation Guide (delivered with the application key) for sensor and input connections.

#### A361.1 / A361.2:

Sensor	Description	Recommended type
S1	Outdoor temperature sensor*	ESMT
S2	Supply flow temperature sensor**	ESM-11 / ESMB / ESMC / ESMU
S3	Flow temperature sensor***, circuit 1	ESM-11 / ESMB / ESMC / ESMU
S4	Flow temperature sensor***, circuit 2	ESM-11 / ESMB / ESMC / ESMU
S5	Return temperature sensor, circuit 1	ESM-11 / ESMB / ESMC / ESMU
S6	Return temperature sensor, circuit 2	ESM-11 / ESMB / ESMC / ESMU
S7	Differential pressure switch, circuit 1	
S8	Differential pressure switch, circuit 2	
S9	Pressure transmitter (0–10 V or 4–20 mA) or pressure switch, circuit 2	
S10	Pressure transmitter (0–10 V or 4–20 mA) or pressure switch, circuit 1	

\* If the outdoor temperature sensor is not connected or the cable is short-circuited, the controller assumes that the outdoor temperature is 0 (zero) °C.

\*\* Only for application A361.2.

\*\*\* The flow temperature sensor must always be connected in order to have the desired functionality. If the sensor is not connected or the cable is short-circuited, the motorized control valve closes (safety function).

#### Connection of 2 differential pressure switches

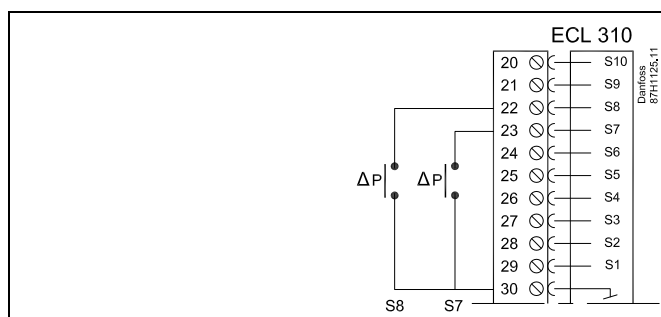

## Operating Guide ECL Comfort 310, application A361

### Connection of a pressure transmitter with 0-10 V output

Example of a pressure transmitter connection to S10. Pressure transmitter can be connected in the same way to S9.

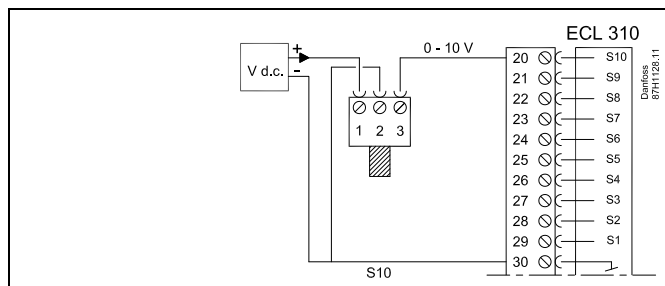

### Connection of a pressure transmitter with 4-20 mA output

The 4-20 mA signal is converted to a 2-10 V signal by means of the 500 ohm resistor.

Example of a pressure transmitter connection to S10. Pressure transmitter can be connected in the same way to S9.

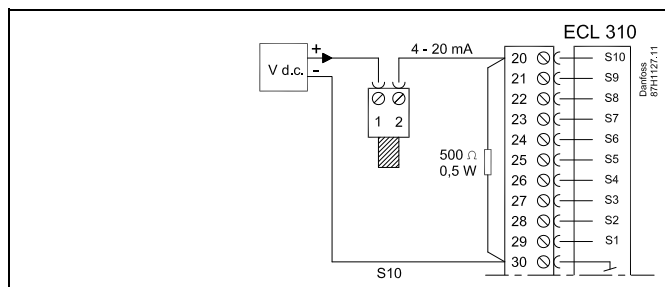

### Connection of 2 pressure switches

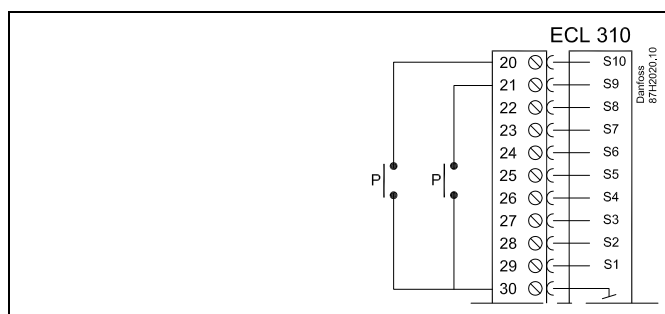

Wire cross section for sensor connections: Min. 0.4 mm<sup>2</sup>.  
Total cable length: Max. 200 m (all sensors incl. internal ECL 485 communication bus)  
Cable lengths of more than 200 m may cause noise sensibility (EMC).



Wire cross section for sensor connections: Min. 0.4 mm<sup>2</sup>.  
Total cable length: Max. 200 m (all sensors incl. internal ECL 485 communication bus).  
Cable lengths of more than 200 m may cause noise sensibility (EMC).

## Operating Guide ECL Comfort 310, application A361

### 2.5.5 Electrical connections, ECA 30 / 31

Terminal ECL	Terminal ECA 30 / 31	Description	Type (recomm.)
30	4	Twisted pair	Cable 2 x twisted pair
31	1		
32	2	Twisted pair	
33	3		
	4	Ext. room temperature sensor*	ESM-10
	5		

\* After an external room temperature sensor has been connected, ECA 30 / 31 must be repowered.

The communication to the ECA 30 / 31 must be set up in the ECL Comfort controller in 'ECA addr.'

The ECA 30 / 31 must be set up accordingly.

After application setup the ECA 30 / 31 is ready after 2–5 min. A progress bar in the ECA 30 / 31 is displayed.



If the actual application contains two heating circuits, it is possible to connect an ECA 30 / 31 to each circuit. The electrical connections are done in parallel.



Max. 2 ECA 30 / 31 can be connected to an ECL Comfort 310 controller or to ECL Comfort 210 / 296 / 310 controllers in a master-slave system.



Setup procedures for ECA 30 / 31: See section 'Miscellaneous'.



ECA information message:  
'Application req. newer ECA':  
The software (firmware) of your ECA does not comply with the software (firmware) of your ECL Comfort controller. Please contact your Danfoss sales office.



Some applications do not contain functions related to actual room temperature. The connected ECA 30 / 31 will only function as remote control.

## Operating Guide ECL Comfort 310, application A361



Total cable length: Max. 200 m (all sensors incl. internal ECL 485 communication bus).  
Cable lengths of more than 200 m may cause noise sensibility (EMC).

### 2.5.6 Electrical connections, master / slave systems

The controller can be used as master or slave in master / slave systems via the internal ECL 485 communication bus (2 x twisted pair cable).

The ECL 485 communication bus is not compatible with the ECL bus in ECL Comfort 110, 200, 300 and 301!

Terminal	Description	Type (recomm.)
30	Common terminal	Cable 2 x twisted pair
31	+12 V*, ECL 485 communication bus * Only for ECA 30 / 31 and master / slave communication	
32	B, ECL 485 communication bus	
33	A, ECL 485 communication bus	



#### ECL 485 bus cable

Maximum recommended length of the ECL 485 bus is calculated like this:

Subtract "Total length of all input cables of all ECL controllers in the master - slave system" from 200 m.

Simple example for total length of all input cables, 3 x ECL:

1 x ECL	Outdoor temp. sensor:	15 m
3 x ECL	Flow temp. sensor:	18 m
3 x ECL	Return temp. sensor:	18 m
3 x ECL	Room temp. sensor:	30 m
Total:		81 m

Maximum recommended length of the ECL 485 bus:  
 $200 - 81 \text{ m} = 119 \text{ m}$

### 2.5.7 Electrical connections, communication

#### Electrical connections, Modbus

ECL Comfort 210: Non-galvanic isolated Modbus connections  
ECL Comfort 296: Galvanic isolated Modbus connections  
ECL Comfort 310: Galvanic isolated Modbus connections

### 2.5.8 Electrical connections, communication

#### Electrical connections, M-bus

ECL Comfort 210: Not implemented

ECL Comfort 296: On board, non-galvanic isolated. Max. cable length 50 m.

ECL Comfort 310: On board, non-galvanic isolated. Max. cable length 50 m.



## Operating Guide ECL Comfort 310, application A361

### 2.6 Inserting the ECL Application Key

#### 2.6.1 Inserting the ECL Application Key

The ECL Application Key contains

- the application and its subtypes,
- currently available languages,
- factory settings: e.g. schedules, desired temperatures, limitation values etc. It is always possible to recover the factory settings,
- memory for user settings: special user / system settings.

After having powered-up the controller, different situations might be existing:

1. The controller is new from the factory, the ECL Application Key is not inserted.
2. The controller already runs an application. The ECL Application Key is inserted, but the application needs to be changed.
3. A copy of the controllers settings is needed for configuring another controller.

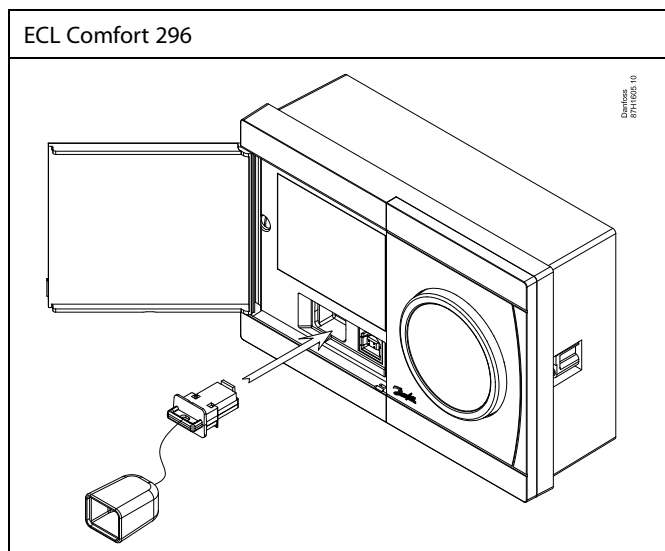
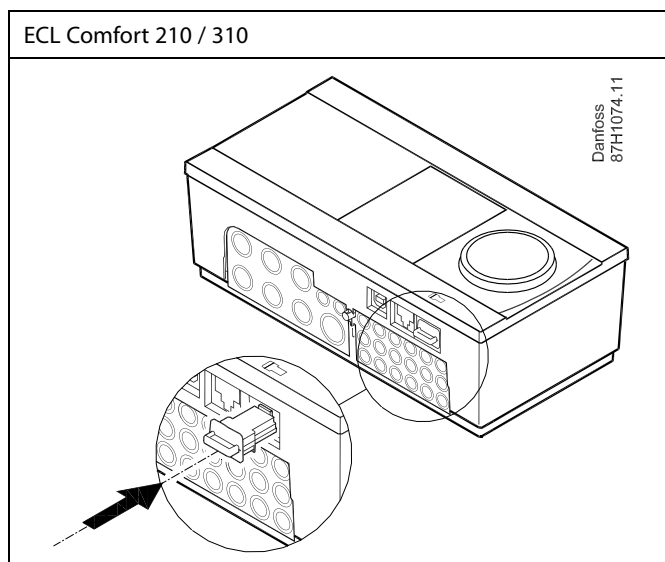
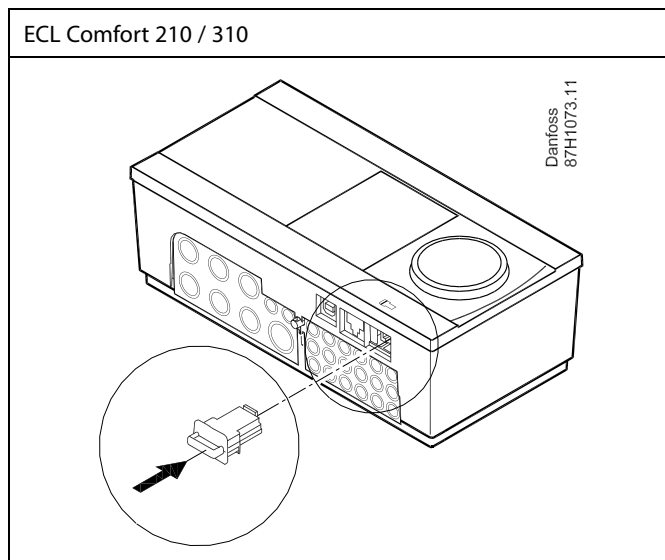

User settings are, among others, desired room temperature, desired DHW temperature, schedules, heat curve, limitation values etc.

System settings are, among others, communication set-up, display brightness etc.



**Automatic update of controller software (firmware):**

The software of the controller is updated automatically when the key is inserted (as of controller version 1.11 (ECL 210 / 310) and version 1.58 (ECL 296)). The following animation will be shown when the software is being updated:

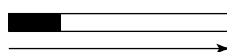

Progress bar

During update:

- Do not remove the KEY  
If the key is removed before the hour-glass is shown, you have to start afresh.
- Do not disconnect the power  
If the power is interrupted when the hour-glass is shown, the controller will not work.
- Manual update of controller software (firmware):  
See the section "Automatic / manual update of firmware"



The "Key overview" does not inform — through ECA 30 / 31 — about the subtypes of the application key.



**Key inserted / not inserted, description:**

ECL Comfort 210 / 310, controller versions lower than 1.36:

- Take out the application key; for 20 minutes settings can be changed.
- Power up the controller **without** the application key inserted; for 20 minutes settings can be changed.

ECL Comfort 210 / 310, controller versions 1.36 and up:

- Take out the application key; for 20 minutes settings can be changed.
- Power up the controller **without** the application key inserted; settings cannot be changed.

ECL Comfort 296 , controller versions 1.58 and up:

- Take out the application key; for 20 minutes settings can be changed.
- Power up the controller **without** the application key inserted; settings cannot be changed.

## Operating Guide ECL Comfort 310, application A361

### Application Key: Situation 1

The controller is new from the factory, the ECL Application Key is not inserted.

An animation for the ECL Application Key insertion is displayed. Insert the Application Key .

Application Key name and Version is indicated (example: A266 Ver. 1.03).

If the ECL Application Key is not suitable for the controller, a "cross" is displayed over the ECL Application Key-symbol.

Action:	Purpose:	Examples:
	Select language	
	Confirm	
	Select application (subtype)	
	Some keys have only one application.	
	Confirm with 'Yes'	
	Set 'Time & Date'	
	Turn and push the dial to select and change 'Hours', 'Minutes', 'Date', 'Month' and 'Year'.	
	Choose "Next"	
	Confirm with 'Yes'	
	Go to 'Aut. daylight'	
	Choose whether 'Aut. daylight' * should be active or not	YES or NO

\* 'Aut. daylight' is the automatic changeover between summer and winter time.

Depending on the contents of the ECL Application Key, procedure A or B is taking place:

#### A

##### The ECL Application key contains factory settings:

The controller reads / transfers data from the ECL Application Key to ECL controller.

The application is installed, and the controller resets and starts up.

#### B

##### The ECL Application key contains changed system settings:

Push the dial repeatedly.

'NO': Only factory settings from the ECL Application Key will be copied to the controller.

'YES\*': Special system settings (differing from the factory settings) will be copied to the controller.

##### If the key contains user settings:

Push the dial repeatedly.

'NO': Only factory settings from the ECL Application Key will be copied to the controller.

'YES\*': Special user settings (differing from the factory settings) will be copied to the controller.

\* If 'YES' cannot be chosen, the ECL Application Key does not contain any special settings.

Choose 'Start copying' and confirm with 'Yes'.

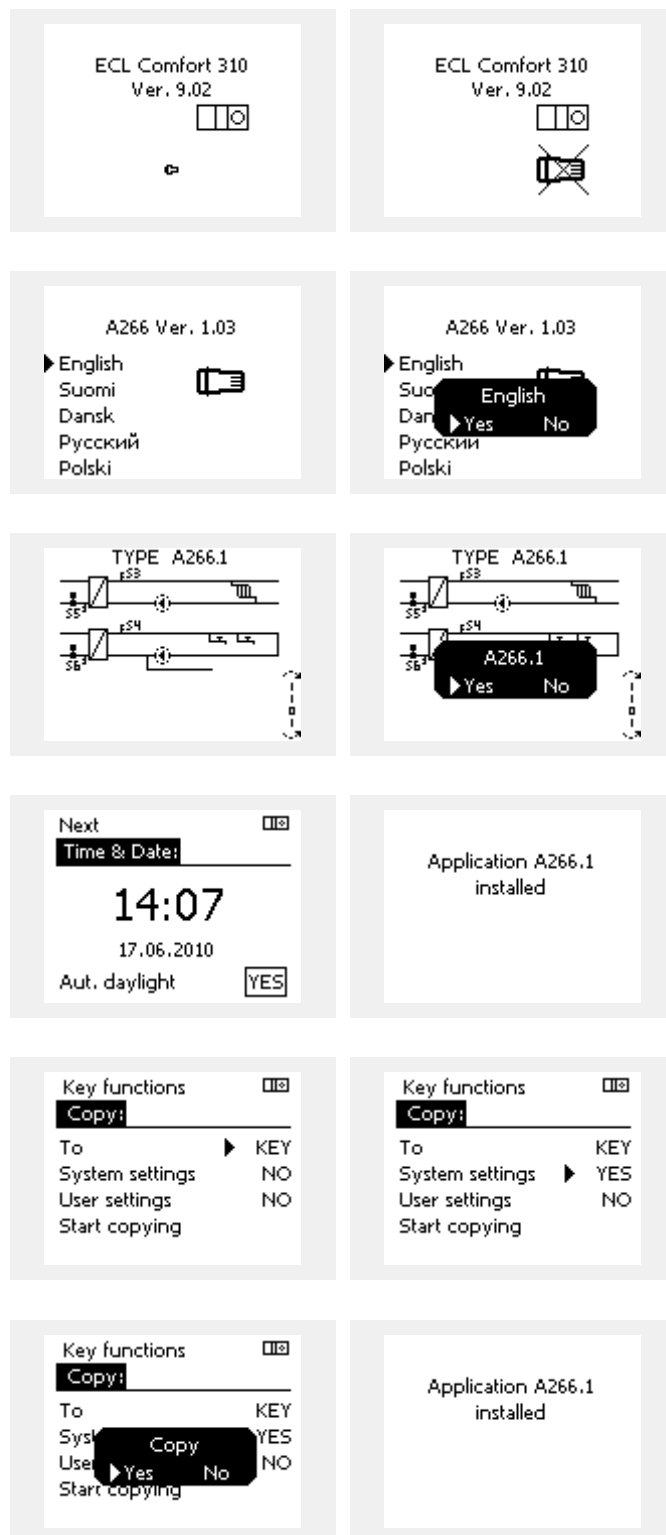

## Operating Guide ECL Comfort 310, application A361

### (Example):

The "i" in the upper right corner indicates that - besides the factory settings - the subtype also contains special user / systems settings.

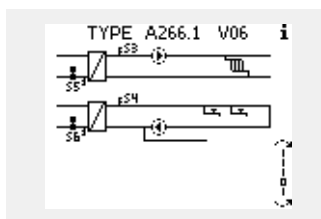

### Application Key: Situation 2

The controller already runs an application. The ECL Application Key is inserted, but the application needs to be changed.

To change to another application on the ECL Application Key, the current application in the controller must be erased (deleted).

Be aware that the Application Key must be inserted.

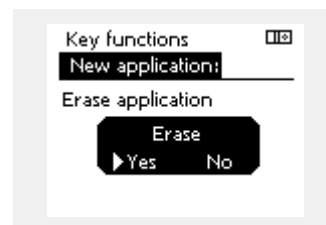
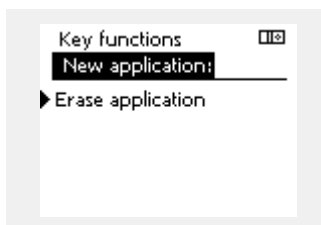
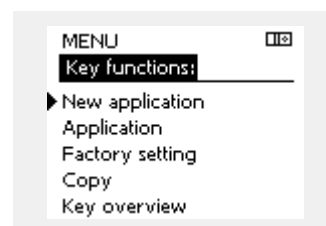
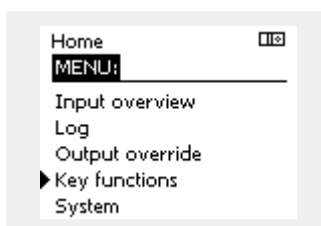

Action:	Purpose:	Examples:
	Choose 'MENU' in any circuit	MENU
	Confirm	
	Choose the circuit selector at the top right corner in the display	
	Confirm	
	Choose 'Common controller settings'	
	Confirm	
	Choose 'Key functions'	
	Confirm	
	Choose 'Erase application'	
	Confirm with 'Yes'	

The controller resets and is ready to be configured.

Follow the procedure described in situation 1.

## Operating Guide ECL Comfort 310, application A361

### Application Key: Situation 3

A copy of the controllers settings is needed for configuring another controller.

This function is used

- for saving (backup) of special user and system settings
- when another ECL Comfort controller of the same type (210, 296 or 310) must be configured with the same application but user / system settings differ from the factory settings.

How to copy to another ECL Comfort controller:

Action:	Purpose:	Examples:
	Choose 'MENU'	MENU
	Confirm	
	Choose the circuit selector at the top right corner in the display	
	Confirm	
	Choose 'Common controller settings'	
	Confirm	
	Go to 'Key functions'	
	Confirm	
	Choose 'Copy'	
	Confirm	
	Choose 'To: 'ECL' or 'KEY' will be indicated. Choose 'ECL' or 'KEY'	* 'ECL' or 'KEY'
	Push the dial repeatedly to choose copy direction	
	Choose 'System settings' or 'User settings'	** 'NO' or 'YES'
	Push the dial repeatedly to choose 'Yes' or 'No' in 'Copy'. Push to confirm.	
	Choose 'Start copying'	
	The Application Key or the controller is updated with special system or user settings.	

\*

'ECL': Data will be copied from the Application Key to the ECL Controller.

'KEY': Data will be copied from the ECL Controller to the Application Key.

\*\*

'NO': The settings from the ECL controller will not be copied to the Application Key or to the ECL Comfort controller.

'YES': Special settings (differing from the factory settings) will be copied to the Application Key or to the ECL Comfort controller. If YES can not be chosen, there are no special settings to be copied.

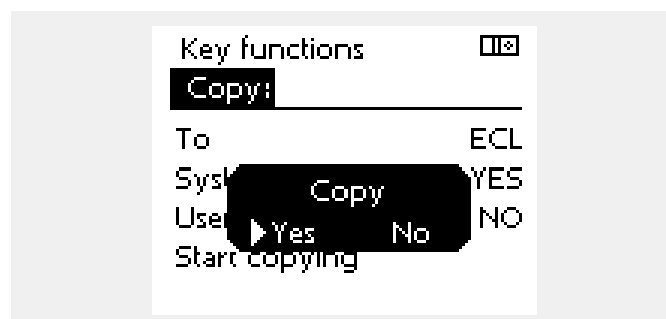
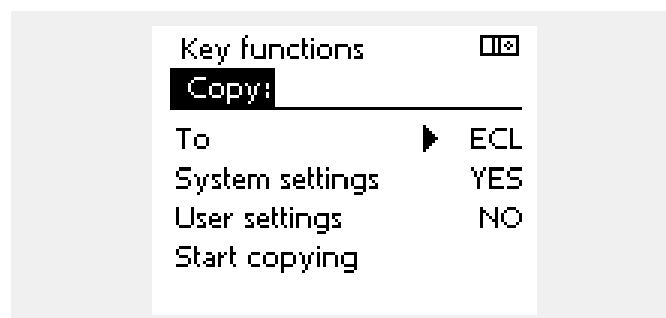
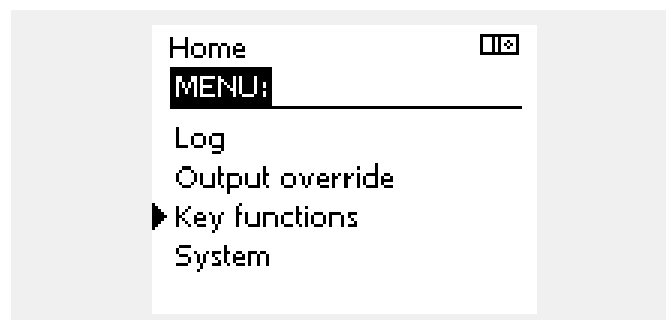

## Operating Guide ECL Comfort 310, application A361

### Language

At application upload, a language must be selected.\*  
 If another language than English is selected, the selected language **AND** English will be uploaded into the ECL controller.  
 This makes service easy for English speaking service people, just because the English language menus can be visible by changing the actual set language into English.  
 (Navigation: MENU > Common controller > System > Language)

If the uploaded language is not suitable, the application must be erased. User and System settings can be saved on the application key before erasing.  
 After new upload with preferred language, the existing User and System settings can be uploaded.

\*)  
 (ECL Comfort 310, 24 Volt) If language cannot be selected, the power supply is not a.c. (alternating current).

### 2.6.2 ECL Application Key, copying data

#### General principles

When the controller is connected and operating, you can check and adjust all or some of the basic settings. The new settings can be stored on the Key.

#### How to update the ECL Application Key after settings have been changed?

All new settings can be stored on the ECL Application Key.

#### How to store factory setting in the controller from the Application Key?

Please read the paragraph concerning Application Key, Situation 1: The controller is new from the factory, the ECL Application Key is not inserted.

#### How to store personal settings from the controller to the Key?

Please read the paragraph concerning Application Key, Situation 3: A copy of the controllers settings is needed for configuring another controller

As a main rule, the ECL Application Key should always remain in the controller. If the Key is removed, it is not possible to change settings.



Factory settings can always be restored.



Make a note of new settings in the 'Settings overview' table.



Do not remove the ECL Application Key while copying. The data on the ECL Application Key can be damaged!



It is possible to copy settings from one ECL Comfort controller to another controller provided that the two controllers are from the same series (210 or 310).  
 Furthermore, when the ECL Comfort controller has been uploaded with an application key, minimum version 2.44, it is possible to upload personal settings from application keys, minimum version 2.14.



The "Key overview" does not inform — through ECA 30 / 31 — about the subtypes of the application key.



**Key inserted / not inserted, description:**

ECL Comfort 210 / 310, controller versions lower than 1.36:

- Take out the application key; for 20 minutes settings can be changed.
- Power up the controller **without** the application key inserted; for 20 minutes settings can be changed.

ECL Comfort 210 / 310, controller versions 1.36 and up:

- Take out the application key; for 20 minutes settings can be changed.
- Power up the controller **without** the application key inserted; settings cannot be changed.

ECL Comfort 296 , controller versions 1.58 and up:

- Take out the application key; for 20 minutes settings can be changed.
- Power up the controller **without** the application key inserted; settings cannot be changed.

### 2.7 Check list



#### Is the ECL Comfort controller ready for use?

- Make sure that the correct power supply is connected to terminals 9 and 10 (230 V or 24 V).
- Make sure the correct phase conditions are connected:  
230 V: Live = terminal 9 and Neutral = terminal 10  
24 V: SP = terminal 9 and SN = terminal 10
- Check that the required controlled components (actuator, pump etc.) are connected to the correct terminals.
- Check that all sensors / signals are connected to the correct terminals (see 'Electrical connections').
- Mount the controller and switch on the power.
- Is the ECL Application Key inserted (see 'Inserting the Application Key').
- Does the ECL Comfort controller contain an existing application (see 'Inserting the Application Key').
- Is the correct language chosen (see 'Language' in 'Common controller settings').
- Is the time & date set correctly (see 'Time & Date' in 'Common controller settings').
- Is the right application chosen (see 'Identifying the system type').
- Check that all settings in the controller (see 'Settings overview') are set or that the factory settings comply with your requirements.
- Choose manual operation (see 'Manual control'). Check that valves open and close, and that required controlled components (pump etc.) start and stop when operated manually.
- Check that the temperatures / signals shown in the display match the actual connected components.
- Having completed the manual operation check, choose controller mode (scheduled, comfort, saving or frost protection).



## Operating Guide ECL Comfort 310, application A361

### 2.8 Navigation, ECL Application Key A361

Navigation, applications A361, circuit 1 and 2 (\* application 361.2 only)

Home		Circuit 1, Heating		Circuit 2, Heating	
		ID no.	Function	ID no.	Function
MENU					
Schedule		Selectable		Selectable	
Settings	Flow temperature		Heat curve		Heat curve
		11178	Temp. max.	11178	Temp. max.
		11177	Temp. min.	12177	Temp. min.
		11300	High supp. T X2*	12300	High supp. T X2*
		11301	High T max Y2*	12301	High T max Y2*
		11302	Low supply T X1*	12302	Low supply T X1*
		11303	Low T max Y1*	12303	Low T max Y1*
	Return limit		High T out X1	12031	High T out X1
		11032	Low limit Y1	12032	Low limit Y1
		11033	Low T out X2	12033	Low T out X2
		11034	High limit Y2	12034	High limit Y2
		11035	Infl. - max.	12035	Infl. - max.
		11036	Infl. - min.	12036	Infl. - min.
		11037	Adapt. time	12037	Adapt. time
		11085	Priority	12085	Priority
	Flow / power limit		Actual		Actual
			Limit		Limit
		11119	High T out X1	12119	High T out X1
		11117	Low limit Y1	12117	Low limit Y1
		11118	Low T out X2	12118	Low T out X2
		11116	High limit Y2	12116	High limit Y2
		11112	Adapt. time	12112	Adapt. time
		11113	Filter constant	12113	Filter constant
		11109	Input type	12109	Input type
		11115	Units	12115	Units
	Optimization	11011	Auto saving	12011	Auto saving
		11012	Boost	12012	Boost
		11013	Ramp	12013	Ramp
		11014	Optimizer	12014	Optimizer
		11026	Pre stop	12026	Pre stop
		11021	Total stop	12021	Total stop
		11179	Cut-out	12179	Cut-out
	Control par.	11174	Motor pr.	12174	Motor pr.
		11184	Xp	12184	Xp
		11185	Tn	12185	Tn
		11186	M run	12186	M run
		11187	Nz	12187	Nz

## Operating Guide ECL Comfort 310, application A361

### Navigation, application A361, circuit 1 and circuit 2 continued

Home MENU		Circuit 1, Heating		Circuit 2, Heating		
		ID no.	Function	ID no.	Function	
Settings	Pump control	11314	Chan.-over time	12314	Chan.-over time	
		11310	Retry time	12310	Retry time	
		11313	Stab. time	12313	Stab. time	
		11311	Change, duration	12311	Change, duration	
		11312	Change time	12312	Change time	
		11022	P exercise	12022	P exercise	
	Refill water			Pressure		Pressure
		11327	Input type	12327	Input type	
		11323	Time-out	12323	Time-out	
		11321	Pressure, des.	12321	Pressure, des.	
		11322	Pressure, diff.	12322	Pressure, diff.	
		11320	P exercise	12320	P exercise	
		11325	Valve delay	12325	Valve delay	
		11326	No. of pumps	12326	No. of pumps	
Application		11017	Demand offset			
		11023	M exercise	12023	M exercise	
		11052	DHW priority	12052	DHW priority	
		11077	P frost T	12077	P frost T	
		11078	P heat T	12078	P heat T	
		11093	Frost pr. T	12093	Frost pr. T	
		11141	Ext. input	12141	Ext. input	
		11142	Ext. mode	12142	Ext. mode	
		11189	Min. act. time	12189	Min. act. time	
<b>Holiday</b>			Selectable		Selectable	
<b>Alarm</b>	Temp. monitor.	11147	Upper difference	12147	Upper difference	
		11148	Lower difference	12148	Lower difference	
		11149	Delay	12149	Delay	
		11150	Lowest temp.	12150	Lowest temp.	
	Clear alarm	11315	Circ. pumps	12315	Circ. pumps	
		11324	Refill water	12324	Refill water	
Alarm overview		Selectable		Selectable		
<b>Influence overview</b>	Des. flow T		Return lim. Flow / power lim. Holiday Ext. override Boost Ramp Slave, demand Heating cut-out DHW priority		Return lim. Flow / power lim. Holiday Ext. override Boost Ramp  Heating cut-out DHW priority	

## Operating Guide ECL Comfort 310, application A361

### Navigation, application A361, Common controller settings (\* application A361.2 only)

Home MENU		Common controller settings	
		ID no.	Function
Time & Date			Selectable
Holiday			Selectable
Input overview 1			Outdoor T Supply T* Heat flow T Heat return T Static pressure S7 status
Input overview 2			Outdoor T Supply T* Heat flow T Heat return T Static pressure S8 status
Log 1 (sensors)	Outdoor T Supply T* Heating flow & des. Heat return T & limit Static pressure		Log today Log yesterday Log 2 days Log 4 days
Log 2 (sensors)	Outdoor T Supply T* Heating flow & des. Heat return T & limit Static pressure		Log today Log yesterday Log 2 days Log 4 days
Output override			M1, P1, P2, M2, P3, P5, V1, V2, P4, A1
Key functions	New application		Erase application
	Application		
	Factory setting		System settings User settings Go to factory
	Copy		To System settings User settings Start copying
	Key overview		
System	ECL version		Code no. Hardware Software Build no. Serial no. MAC Production week
	Extension		
	Ethernet		
	M-bus config		Selectable
	Energy Meters		Selectable
	Display		60058 Backlight 60059 Contrast
	Communication		38 Modbus addr. 2048 ECL 485 addr. 2150 Service pin 2151 Ext. reset
	Language		2050 Language

## Operating Guide ECL Comfort 310, application A361

### 3.0 Daily use

#### 3.1 How to navigate

You navigate in the controller by turning the dial left or right to the desired position (◂/▸).

The dial has a built-in accelerator. The faster you turn the dial, the faster it reaches the limits of any wide setting range.

The position indicator in the display (▶) will always show you where you are.

Push the dial to confirm your choices (Ⓜ).

The display examples are from a two-circuit application: One heating circuit (▣) and one domestic hot-water (DHW) circuit (⚡). The examples might differ from your application.

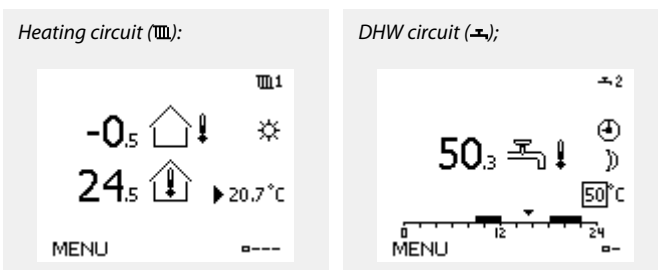
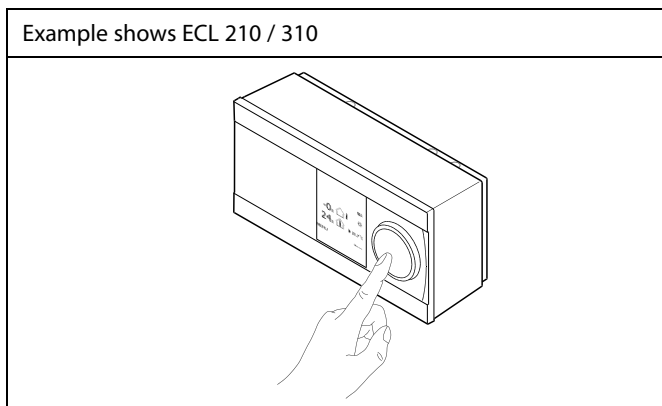

Some general settings which apply to the entire controller are located in a specific part of the controller.

To enter 'Common controller settings':

Action:	Purpose:	Examples:
	Choose 'MENU' in any circuit	MENU
	Confirm	
	Choose the circuit selector at the top right corner in the display	
	Confirm	
	Choose 'Common controller settings'	
	Confirm	

Circuit selector



## Operating Guide ECL Comfort 310, application A361

### 3.2 Understanding the controller display

This section describes the function in general for the ECL Comfort 210 / 296 / 310 series. The shown displays are typical and not application related. They might differ from the displays in your application.

#### Choosing a favorite display

Your favorite display is the display you have chosen as the default display. The favorite display will give you a quick overview of the temperatures or units that you want to monitor in general.

If the dial has not been activated for 20 min., the controller will revert to the overview display you have chosen as favorite.



To shift between displays: Turn the dial until you reach the display selector (=---) at the bottom right side of the display. Push the dial and turn to choose your favorite overview display. Push the dial again.

#### Heating circuit

Overview display 1 informs about:  
actual outdoor temperature, controller mode,  
actual room temperature, desired room temperature.

Overview display 2 informs about:  
actual outdoor temperature, trend in outdoor temperature,  
controller mode, max. and min. outdoor temperatures since  
midnight as well as desired room temperature.

Overview display 3 informs about:  
date, actual outdoor temperature, controller mode, time, desired  
room temperature as well as shows the comfort schedule of the  
current day.

Overview display 4 informs about:  
state of the controlled components, actual flow temperature,  
(desired flow temperature), controller mode, return temperature  
(limitation value), influence on desired flow temperature.

The value above the V2 symbol indicates 0–100% of the analogue  
signal (0–10 V).

#### Note:

An actual flow temperature value must be present, otherwise the  
circuit's control valve will close.

Dependent on the chosen display, the overview displays for the  
heating circuit inform you about:

- actual outdoor temperature (-0.5)
- controller mode (☼)
- actual room temperature (24.5)
- desired room temperature (20.7 °C)
- trend in outdoor temperature (↗ → ↘)
- min. and max. outdoor temperatures since midnight (↕)
- date (23.02.2010)
- time (7:43)
- comfort schedule of the current day (0 - 12 - 24)
- state of the controlled components (M2, P2)
- actual flow temperature (49 °C), (desired flow temperature (31))
- return temperature (24 °C) (limitation temperature (50))

Overview display 1:

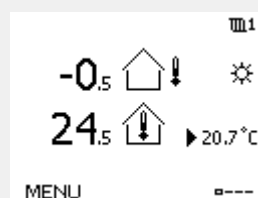

Overview display 2:

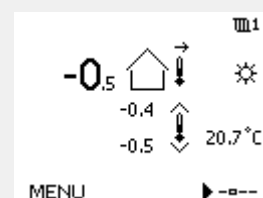

Overview display 3:

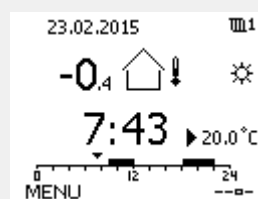

Overview display 4:

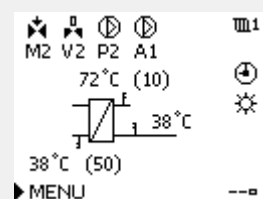

Example of overview display with  
Influence indication:

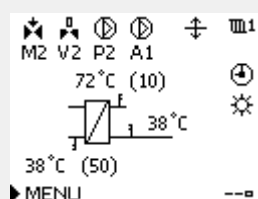

Example, favorite display 1 in  
A230.3, where min. desired room  
temperature is indicated (22.7):

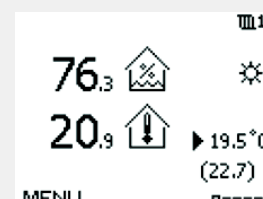



The setting of the desired room temperature is important even if a room temperature sensor / Remote Control Unit is not connected.



If the temperature value is displayed as

"- -" the sensor in question is not connected.

"- - -" the sensor connection is short-circuited.

## Setting the desired temperature

Depending on the chosen circuit and mode, it is possible to enter all daily settings directly from the overview displays (see also the next page concerning symbols).

## Setting the desired room temperature

The desired room temperature can easily be adjusted in the overview displays for the heating circuit.

Action:	Purpose:	Examples:
	Desired room temperature	20.5
	Confirm	
	Adjust the desired room temperature	21.0
	Confirm	

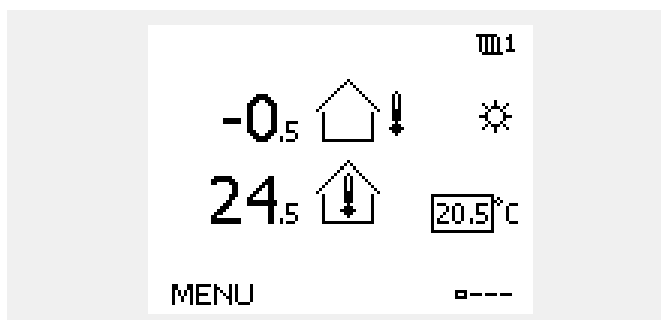

This overview display informs about outdoor temperature, actual room temperature as well as desired room temperature.

The display example is for comfort mode. If you want to change the desired room temperature for saving mode, choose the mode selector and select saving.



The setting of the desired room temperature is important even if a room temperature sensor / Remote Control Unit is not connected.

## Operating Guide ECL Comfort 310, application A361

---

### Setting the desired room temperature, ECA 30 / ECA 31

The desired room temperature can be set exactly as in the controller. However, other symbols can be present in the display (please see 'What do the symbols mean?').



With the ECA 30 / ECA 31 you can override the desired room temperature set in the controller temporarily by means of the override functions: 

## Operating Guide ECL Comfort 310, application A361

### 3.3 A general overview: What do the symbols mean?

Symbol	Description	
	Outdoor temp.	Temperature
	Relative humidity indoor	
	Room temp.	
	DHW temp.	
	Position indicator	
	Scheduled mode	Mode
	Comfort mode	
	Saving mode	
	Frost protection mode	
	Manual mode	
	Standby	
	Cooling mode	
	Active output override	
	Optimized start or stop time	
	Heating	Circuit
	Cooling	
	DHW	
	Common controller settings	
	Pump ON	Controlled component
	Pump OFF	
	Fan ON	
	Fan OFF	
	Actuator opens	
	Actuator closes	
	Actuator, analogue control signal	
	Pump / fan speed	
	Damper ON	
	Damper OFF	

Symbol	Description
	Alarm
	Letter
	Event
	Monitoring temperature sensor connection
	Display selector
	Max. and min. value
	Trend in outdoor temperature
	Wind speed sensor
	Sensor not connected or not used
	Sensor connection short-circuited
	Fixed comfort day (holiday)
	Active influence
	Heating active (+) Cooling active (-)
	Number of heat exchangers

#### Additional symbols, ECA 30 / 31:

Symbol	Description
	ECA Remote Control Unit
	15 Connection address (master: 15, slaves: 1 - 9)
	Day off
	Holiday
	Relaxing (extended comfort period)
	Going out (extended saving period)

In ECA 30 / 31 only the symbols that are relevant to the application in the controller are displayed.



## Operating Guide ECL Comfort 310, application A361

### 3.4 Monitoring temperatures and system components

This section describes the function in general for the ECL Comfort 210 / 296 / 310 series. The shown displays are typical and not application related. They might differ from the displays in your application.

#### Heating circuit

The overview display in the heating circuit ensures a quick overview of the actual and (desired) temperatures as well as the actual state of the system components.

Display example:

49 °C	Flow temperature
(31)	Desired flow temperature
24 °C	Return temperature
(50)	Return temperature limitation

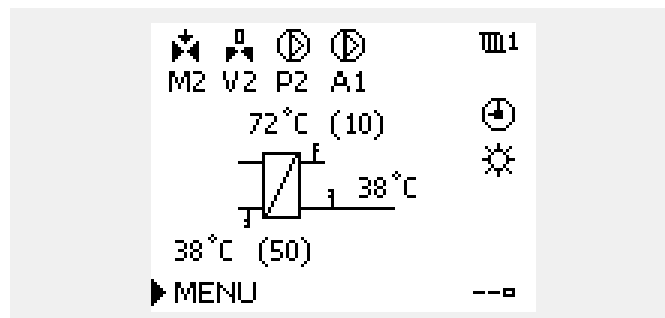

#### Input overview

Another option to get a quick overview of measured temperatures is the 'Input overview' which is visible in the common controller settings (how to enter the common controller settings, see 'Introduction to common controller settings:')

As this overview (see display example) only states the measured actual temperatures, it is read-only.

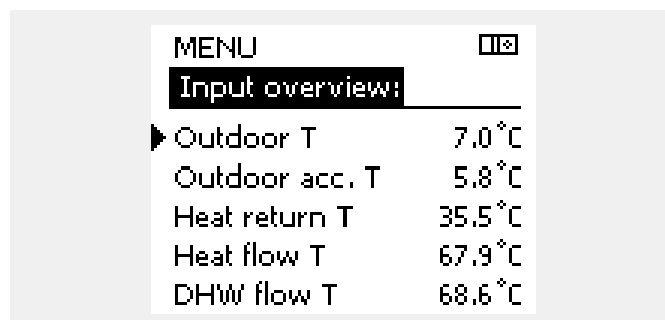

## Operating Guide ECL Comfort 310, application A361

### 3.5 Influence overview

This section describes the function in general for the ECL Comfort 210 / 296 / 310 series. The shown displays are typical and not application related. They might differ from the displays in your application.

The menu gives an overview of the influences on the desired flow temperature. It differs from application to application which parameters are listed. It can be helpful in a service situation to explain unexpected conditions or temperatures among others.

If the desired flow temperature is influenced (corrected) by one or more parameters, it is indicated by a small line with arrow-down, arrow-up or double-arrow:

Arrow-down:

The parameter in question reduces the desired flow temperature.

Arrow-up:

The parameter in question increases the desired flow temperature.

Double-arrow:

The parameter in question creates an override (e.g. Holiday).

Straight line:

No active influence.

In the example, the arrow in the symbol points downwards for 'Room lim.'. This means that the actual room temperature is higher than the desired room temperature which again results in a decrease of the desired flow temperature.

Example of overview display with Influence indication:

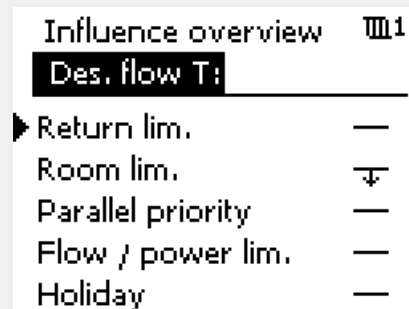
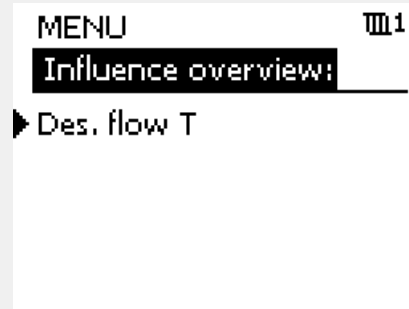
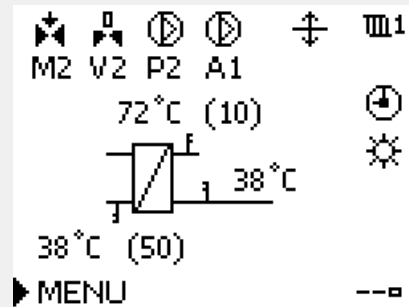

## Operating Guide ECL Comfort 310, application A361

### 3.6 Manual control

This section describes the function in general for the ECL Comfort 210 / 296 / 310 series. The shown displays are typical and not application related. They might differ from the displays in your application.

It is possible to manually control the installed components.

Manual control can only be selected in favorite displays in which the symbols for the controlled components (valve, pump etc.) are visible.

Action:	Purpose:	Examples:
	Choose mode selector	
	Confirm	
	Choose manual mode	
	Confirm	
	Choose pump	
	Confirm	
	Switch ON the pump	
	Switch OFF the pump.	
	Confirm pump mode	
	Choose motorized control valve	
	Confirm	
	Open the valve	
	Stop opening the valve	
	Close the valve	
	Stop closing the valve	
	Confirm valve mode	

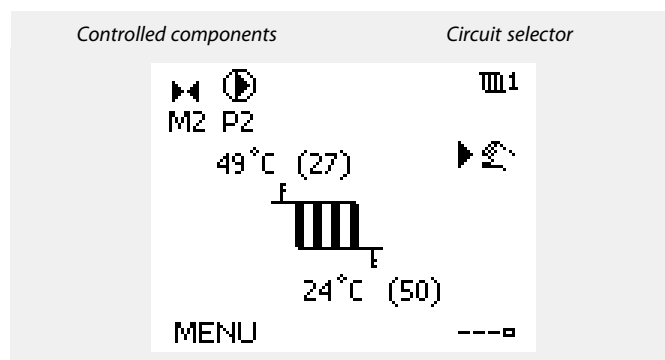

During manual operation:

- All control functions are deactivated
- Output override is not possible
- Frost protection is not active



When manual control is selected for one circuit, it is automatically selected for all circuits!

To leave manual control, use the mode selector to select the desired mode. Push the dial.

Manual control is typically used when commissioning the installation. The controlled components, valve, pump etc., can be controlled for correct function.

# Operating Guide ECL Comfort 310, application A361

## 3.7 Schedule

### 3.7.1 Set your schedule

This section describes the schedule in general for the ECL Comfort 210 / 296 / 310 series. The shown displays are typical and not application related. They might differ from the displays in your application. In some applications, however, there might be more than one schedule. Additional schedules can be found in 'Common controller settings'.

The schedule consists of a 7-day week:

- M = Monday
- T = Tuesday
- W = Wednesday
- T = Thursday
- F = Friday
- S = Saturday
- S = Sunday

The schedule will day-by-day show you the start and stop times of your comfort periods (heating / DHW circuits).

Changing your schedule:

- |         |   |           |
|---------|---|-----------|
| Action: | Purpose:                                      | Examples: |
|         | Choose 'MENU' in any of the overview displays | MENU      |
|         | Confirm                                       |           |
|         | Confirm the choice 'Schedule'                 |           |
|         | Choose the day to change                      | ▶         |
|         | Confirm*                                      | T         |
|         | Go to Start1                                  |           |
|         | Confirm                                       |           |
|         | Adjust the time                               |           |
|         | Confirm                                       |           |
|         | Go to Stop1, Start2 etc. etc.                 |           |
|         | Return to 'MENU'                              | MENU      |
|         | Confirm                                       |           |
|         | Choose 'Yes' or 'No' in 'Save'                |           |
|         | Confirm                                       |           |

\* Several days can be marked

The chosen start and stop times will be valid for all the chosen days (in this example Thursday and Saturday).

You can set max. 3 comfort periods a day. You can delete a comfort period by setting start and stop times to the same value.

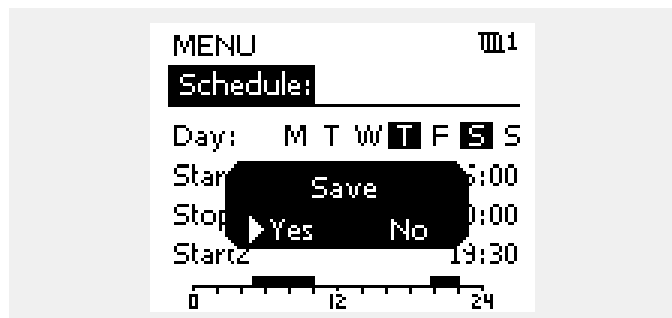
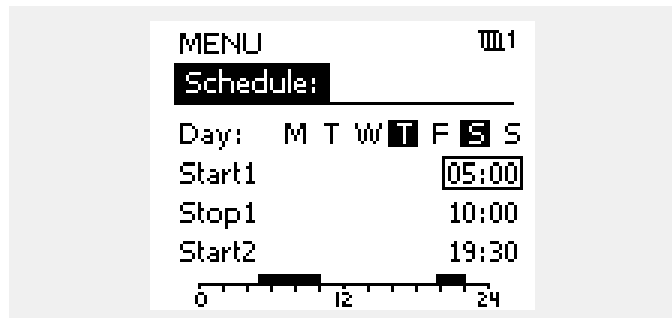
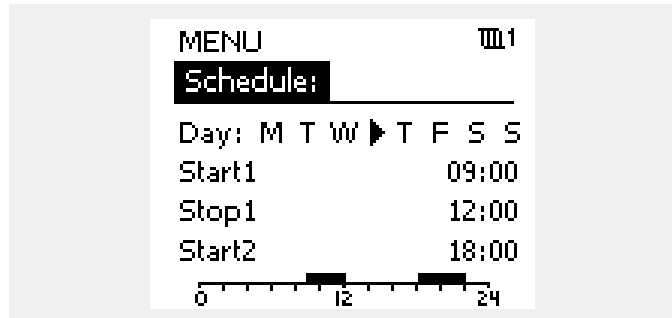

Each circuit has its own schedule. To change to another circuit, go to 'Home', turn the dial and choose the desired circuit.

The start and stop times can be set in half-hourly (30 min. ) intervals.

## Operating Guide ECL Comfort 310, application A361

### 4.0 Settings overview

For factory settings and setting range, see appendix "Parameter ID overview".

Parameters indicated with an ID no. like "1x607" mean a universal parameter. x stands for circuit / parameter group.

Setting	ID	Page	Factory settings in circuit(s)		
			1	2	3
Heat curve		<a href="#">48</a>			
Heat curve		<a href="#">50</a>			
Actual (actual flow or power)		<a href="#">58</a>			
Pressure		<a href="#">74</a>			
Pressure, des. (desired pressure)		<a href="#">75</a>			
Auto saving (saving temp. dependent on outdoor temp.)	1x011	<a href="#">61</a>			
Boost	1x012	<a href="#">62</a>			
Ramp (reference ramping)	1x013	<a href="#">63</a>			
Optimizer (optimizing time constant)	1x014	<a href="#">63</a>			
Demand offset	1x017	<a href="#">79</a>			
Total stop	1x021	<a href="#">64</a>			
P exercise (pump exercise)	1x022	<a href="#">71</a>			
M exercise (valve exercise)	1x023	<a href="#">79</a>			
Pre-stop (optimized stop time)	1x026	<a href="#">65</a>			
High T out X1 (return temp. limitation, high limit, X-axis)	1x031	<a href="#">54</a>			
Low limit Y1 (return temp. limitation, low limit, Y-axis)	1x032	<a href="#">54</a>			
Low T out X2 (return temp. limitation, low limit, X-axis)	1x033	<a href="#">54</a>			
High limit Y2 (return temp. limitation, high limit, Y-axis)	1x034	<a href="#">55</a>			
Infl. - max. (return temp. limitation - max. influence)	1x035	<a href="#">55</a>			
Infl. - min. (return temp. limitation - min. influence)	1x036	<a href="#">55</a>			
Adapt. time (adaptation time)	1x037	<a href="#">55</a>			
DHW priority (closed valve / normal operation)	1x052	<a href="#">79</a>			
P frost T (circulation pump, frost protection temp.)	1x077	<a href="#">80</a>			
P heat T (heat demand)	1x078	<a href="#">80</a>			
Priority (priority for return temp. limitation)	1x085	<a href="#">56</a>			
Frost pr. T (frost protection temp.)	1x093	<a href="#">80</a>			
Input type	1x109	<a href="#">58</a>			
Limit (limitation value)	1x111	<a href="#">58</a>			
Adapt. time (adaptation time)	1x112	<a href="#">58</a>			
Filter constant	1x113	<a href="#">59</a>			
Units	1x115	<a href="#">59</a>			
High limit Y2 (flow / power limitation, high limit, Y-axis)	1x116	<a href="#">59</a>			
Low limit Y1 (flow / power limitation, low limit, Y-axis)	1x117	<a href="#">60</a>			
Low T out X2 (flow / power limitation, low limit, X-axis)	1x118	<a href="#">60</a>			
High T out X1 (flow / power limitation, high limit, X-axis)	1x119	<a href="#">60</a>			
Ext. input (external override)	1x141	<a href="#">80</a>			
Ext. mode (external override mode)	1x142	<a href="#">81</a>			
Upper difference	1x147	<a href="#">85</a>			

## Operating Guide ECL Comfort 310, application A361

Setting	ID	Page	Factory settings in circuit(s)		
			1	2	3
Lower difference	1x148	<a href="#">85</a>			
Delay, example	1x149	<a href="#">85</a>			
Lowest temp.	1x150	<a href="#">86</a>			
Motor pr. (motor protection)	1x174	<a href="#">68</a>			
Temp. min.	1x177	<a href="#">51</a>			
Temp. max.	1x178	<a href="#">51</a>			
Summer, cut-out (limit for heating cut-out)	1x179	<a href="#">66</a>			
Xp (proportional band)	1x184	<a href="#">68</a>			
Tn (integration time constant)	1x185	<a href="#">69</a>			
M run (running time of the motorized control valve)	1x186	<a href="#">69</a>			
Nz (neutral zone)	1x187	<a href="#">69</a>			
Min. act. time (min. activation time gear motor)	1x189	<a href="#">83</a>			
High supp. T X2 (high value of supply temp.)	1x300	<a href="#">51</a>			
High T max Y2 (high value of max limitation)	1x301	<a href="#">51</a>			
Low supply T X1 (low value of supply temp.)	1x302	<a href="#">51</a>			
Low T max Y1 (low value of max limitation)	1x303	<a href="#">52</a>			
Retry time	1x310	<a href="#">71</a>			
Change, duration	1x311	<a href="#">71</a>			
Change time (changeover time)	1x312	<a href="#">72</a>			
Stab. time (stabilization time)	1x313	<a href="#">72</a>			
Chan.-over time (change-over time)	1x314	<a href="#">72</a>			
Circ. pumps	1x315	<a href="#">86</a>			
P exercise (pump exercise)	1x320	<a href="#">75</a>			
Pressure, diff. (switching difference)	1x322	<a href="#">75</a>			
Time-out	1x323	<a href="#">75</a>			
Refill water	1x324	<a href="#">86</a>			
Valve delay	1x325	<a href="#">76</a>			
No. of pumps	1x326	<a href="#">77</a>			
Input type	1x327	<a href="#">77</a>			

### 5.0 Settings

---

#### 5.1 Introduction to Settings

Descriptions of settings (parameter's functions) are divided into groups as used in the ECL Comfort 210 / 296 / 310 controller's menu structure. Examples: "Flow temperature", "Room limit" and so on. Each group starts with a general explanation.

The descriptions of each parameter are in numeric order, related to the parameter's ID numbers. You might come across differences between the order in this Operating Guide and the ECL Comfort 210 / 296 / 310 controllers.

Some parameter descriptions are related to specific application subtypes. This means that you might not see the related parameter in the actual subtype in the ECL controller.

The note "See Appendix ..." refers to the Appendix at the end of this Operating Guide, where parameter's setting ranges and factory settings are listed.

The navigation hints (for example MENU > Settings > Return limit ... ) cover multiple subtypes.

## Operating Guide ECL Comfort 310, application A361

### 5.2 Flow temperature

The ECL Comfort controller determines and controls the flow temperature related to the outdoor temperature. This relationship is called the heat curve.

The heat curve is set by means of 6 coordinate points. The desired flow temperature is set at 6 pre-defined outdoor temperature values.

The shown value for the heat curve is an average value (slope), based on the actual settings.

Outdoor temp.	Desired flow temp.			Your settings
	A	B	C	
-30 °C	45 °C	75 °C	95 °C	
-15 °C	40 °C	60 °C	90 °C	
-5 °C	35 °C	50 °C	80 °C	
0 °C	32 °C	45 °C	70 °C	
5 °C	30 °C	40 °C	60 °C	
15 °C	25 °C	28 °C	35 °C	

**A:** Example for floor heating

**B:** Factory settings

**C:** Example for radiator heating (high demand)

#### MENU > Settings > Flow temperature

Heat curve		
1	0.1 ... 4.0	1.0

The heat curve can be changed in two ways:

1. The value of the slope is changed (see heat curve examples on next page)
2. The coordinates of the heat curve are changed

#### Change the value of the slope:

Push the dial to enter / change the slope value of the heat curve (example: 1.0).

When the slope of the heat curve is changed by means of the slope value, the common point for all heat curves will be a desired flow temperature = 24.6 °C at an outdoor temperature = 20 °C and a desired room temperature = 20.0 °C.

#### Change the coordinates:

Push the dial to enter / change the coordinates of the heat curve (example: -30,75).

The heat curve represents the desired flow temperatures at different outdoor temperatures and at a desired room temperature of 20 °C.

If the desired room temperature is changed, the desired flow temperature also changes:

$(\text{Desired room T} - 20) \times \text{HC} \times 2.5$

where "HC" is the Heat Curve slope and "2.5" is a constant.

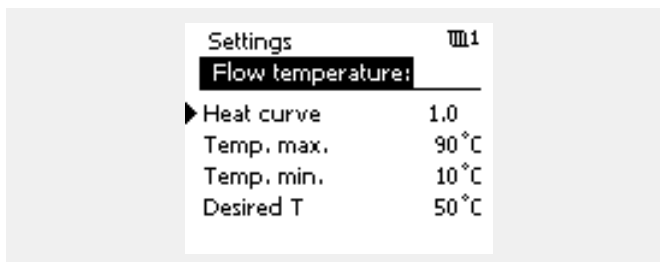
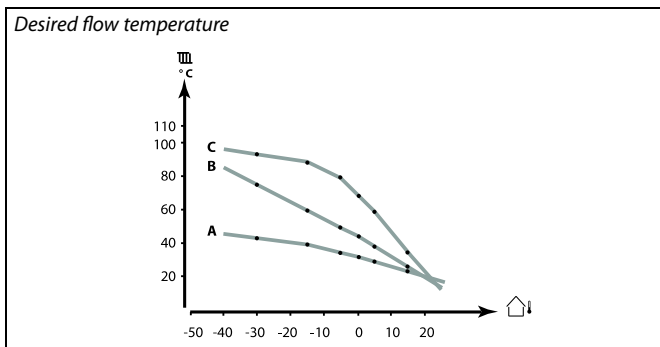

#### Slope changes

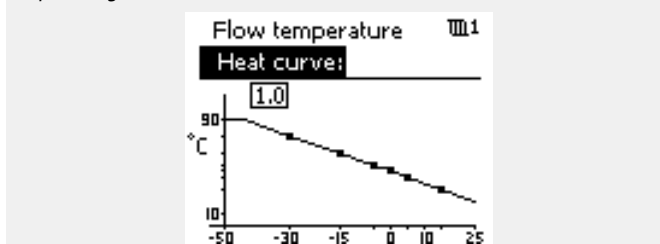

#### Coordinate changes

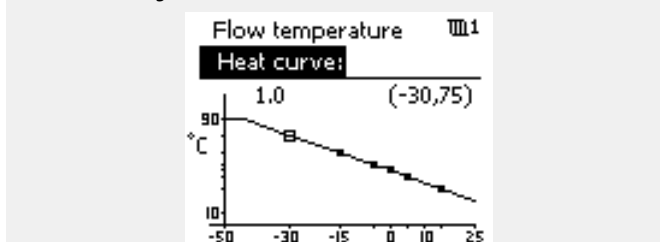

The calculated flow temperature can be influenced by the 'Boost' and 'Ramp' functions etc.

**Example:**

Heat curve: 1.0

Desired flow temp.: 50 °C

Desired room temp.: 22 °C

Calculation  $(22 - 20) \times 1.0 \times 2.5 = 5$

Result:

The desired flow temperature will be corrected from 50 °C to 55 °C.



## Operating Guide ECL Comfort 310, application A361

### Choosing a heat curve slope

The heat curves represent the desired flow temperature at different outdoor temperatures and at a desired room temperature of 20 °C.

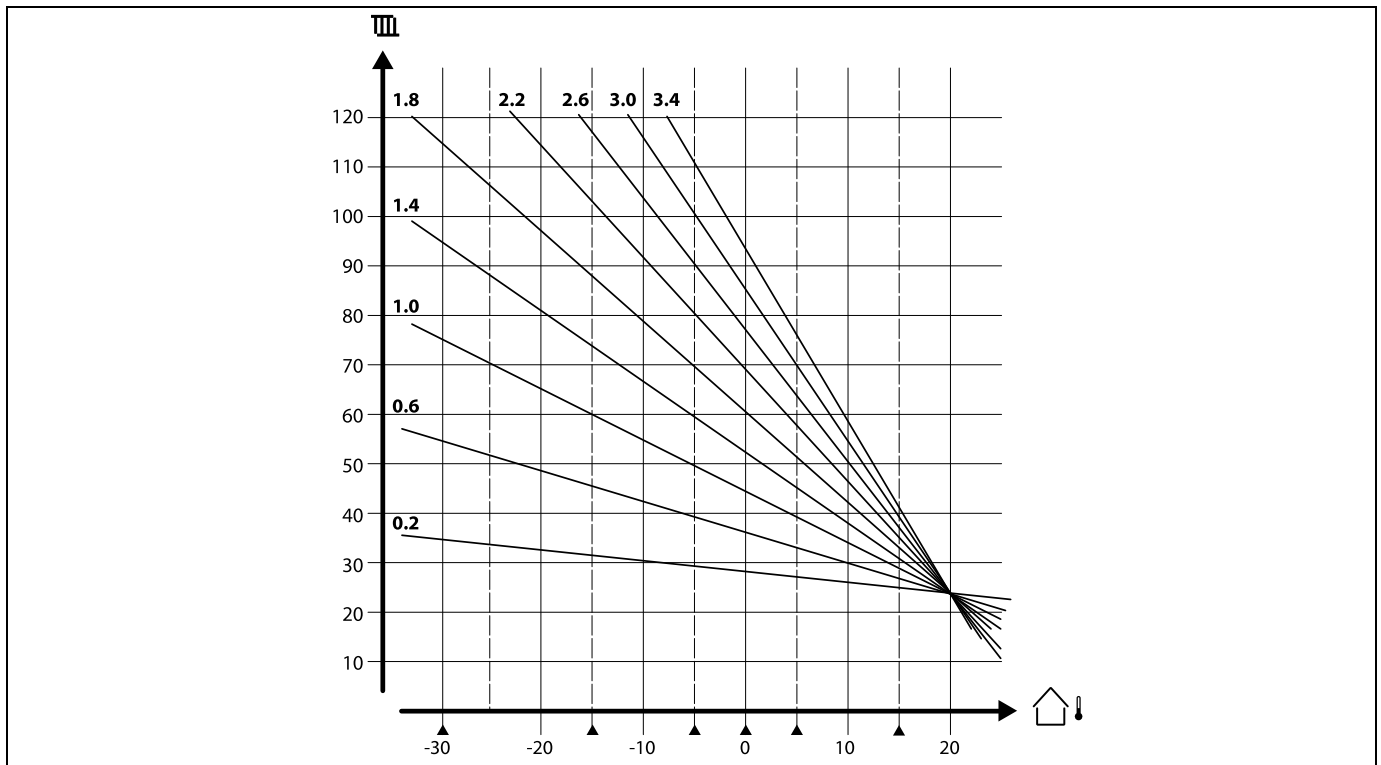

The small arrows (▲) indicate 6 different outdoor temperature values at which you can change the heat curve.

#### Max. limitation of the desired flow temperature:

In the application A361.1 the max. limitation value is selectable in 'Temp. max.'

#### Max. limitation of the desired flow temperature:

In the application A361.2 the desired flow temperature or max. limitation value depends on the supply temperature (S2). The relationship is set in the four settings 'High supp. T X2', 'High T max Y2', 'Low supply T X1' and 'Low T max Y1'.

When setting the heat curve coordinates as described in the section 'A361.1', the desired flow temperature can be limited to a maximum according to the supply temperature (S2).

## Operating Guide ECL Comfort 310, application A361

### 5.2.1 A361.2

The ECL Comfort controller determines and controls the flow temperature related to the supply temperature (S2). This relationship is set in the controller.

The heat curve is set in all coordinate points to the max. desired flow temperature (150 °C). The desired flow temperature will always be in relation to the supply temperature (S2).

The shown value for the heat curve is an average value (slope), based on the actual settings.

Outdoor temp.	Factory setting	Your settings
-30 °C	150 °C	
-15 °C	150 °C	
-5 °C	150 °C	
0 °C	150 °C	
5 °C	150 °C	
15 °C	150 °C	

Adjust the desired flow temperature at -30, -15, -5, 0, 5, and 15 °C, if required.

#### MENU > Settings > Flow temperature

Heat curve		
Circuit	Setting range	Factory setting
1	Read-out only	

The factory setting (a general desired flow temperature of 150 °C) is limited to a max. value based on the supply temperature (S2) and the settings in parameters 'High supp. T X2', 'High T max Y2', 'Low supply T X1' and 'Low T max Y1'.

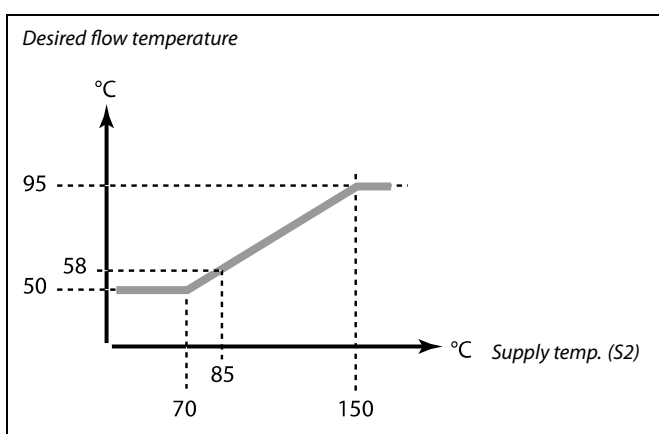
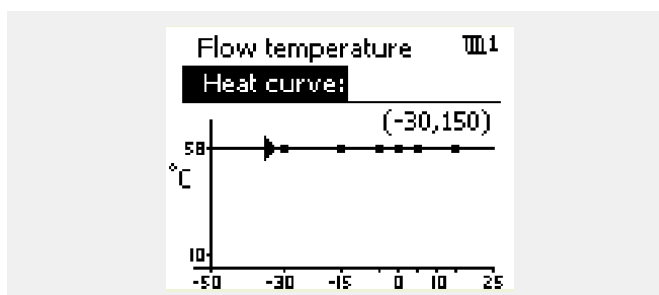
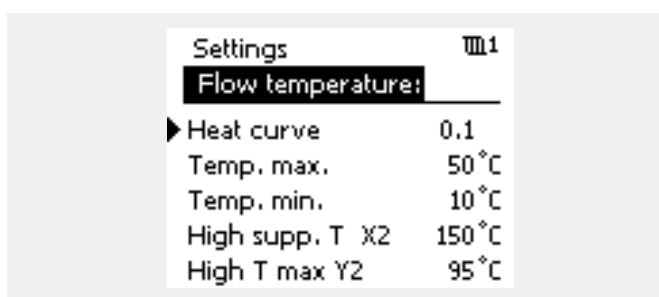
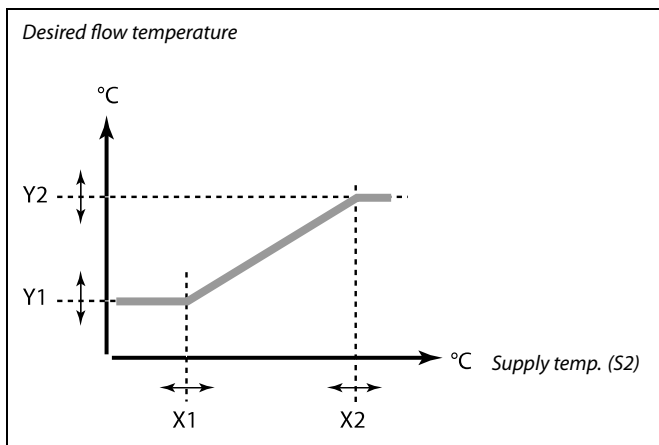

The above heat curve is an example of a supply temperature (S2) of 85 °C. The desired flow temperature (58 °C) is based on the set-up of the relationship between the supply temperature (S2) and the desired flow temperature.

## Operating Guide ECL Comfort 310, application A361



Parameters indicated with an ID no. like "1x607" mean a universal parameter.  
x stands for circuit / parameter group.

### MENU > Settings > Flow temperature

<b>Temp. min.</b>	<b>1x177</b>
-------------------	--------------

See Appendix "Parameter ID overview"

Set the min. flow temperature for the system. The desired flow temperature will not be lower than this setting. Adjust the factory setting, if required.



'Temp. min.' is overruled if 'Total stop' is active in Saving mode or 'Cut-out' is active.

'Temp. min.' can be overruled by the influence from the return temperature limitation (see 'Priority').



The setting for 'Temp. max.' has higher priority than 'Temp. min.'.

### MENU > Settings > Flow temperature

<b>Temp. max.</b>	<b>1x178</b>
-------------------	--------------

See Appendix "Parameter ID overview"

Set the max. flow temperature for the system. The desired temperature will not be higher than this setting. Adjust the factory setting, if required.



The setting of 'heat curve' is possible for heating circuits only.



The setting for 'Temp. max.' has higher priority than 'Temp. min.'.

### MENU > Settings > Flow temperature

<b>High supp. T X2 (high value of supply temp.)</b>	<b>1x300</b>
---	--------------

See Appendix "Parameter ID overview"

Set the high value for the supply temperature in relation to the desired max. flow temperature. When the supply temperature is above the set value, the max. limitation of the flow temperature is the Y2 value. When the supply temperature is below the set value, the max. limitation of the flow temperature will be lower.

### MENU > Settings > Flow temperature

<b>High T max Y2 (high value of max limitation)</b>	<b>1x301</b>
---	--------------

See Appendix "Parameter ID overview"

Set the high value for the max. limitation of the desired flow temperature.

## Operating Guide ECL Comfort 310, application A361

---

### MENU > Settings > Flow temperature

Low supply T X1 (low value of supply temp.)	1x302
---	-------

See Appendix "Parameter ID overview"

Set the low value for the supply temperature in relation to the desired max. flow temperature. When the supply temperature is below the set value, the max. limitation of the flow temperature is the Y1 value. When the supply temperature is above the set value, the max. limitation of the flow temperature will be higher.

### MENU > Settings > Flow temperature

Low T max Y1 (low value of max limitation)	1x303
--	-------

See Appendix "Parameter ID overview"

Set the low value for the max. limitation of the desired flow temperature.

## Operating Guide ECL Comfort 310, application A361

### 5.3 Return limit

The return temperature limitation is based on the outdoor temperature. Typically in district heating systems a higher return temperature is accepted at a decrease in outdoor temperature. The relationship between the return temperature limits and outdoor temperature is set in two coordinates.

The outdoor temperature coordinates are set in 'High T out X1' and 'Low T out X2'. The return temperature coordinates are set in 'High limit Y2' and 'Low limit Y1'.

The controller automatically changes the desired flow temperature to obtain an acceptable return temperature when the return temperature falls below or gets higher than the calculated limit. This limitation is based on a PI regulation where P ('Infl.' factor) responds quickly to deviations and I ('Adapt. time') responds slower and over time removes the small offsets between the desired and actual values. This is done by changing the desired flow temperature.

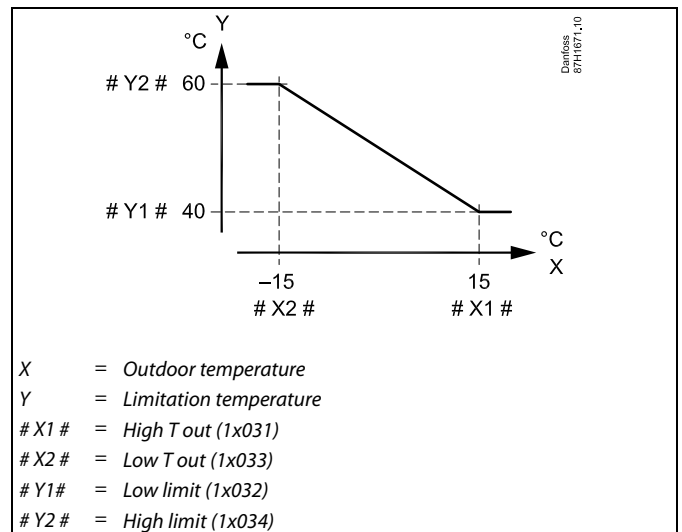

The calculated limit is shown in brackets ( ) in the monitoring display. See the section "Monitoring temperatures and system components".

Example, maximum return temperature limitation; return temperature gets higher than limit

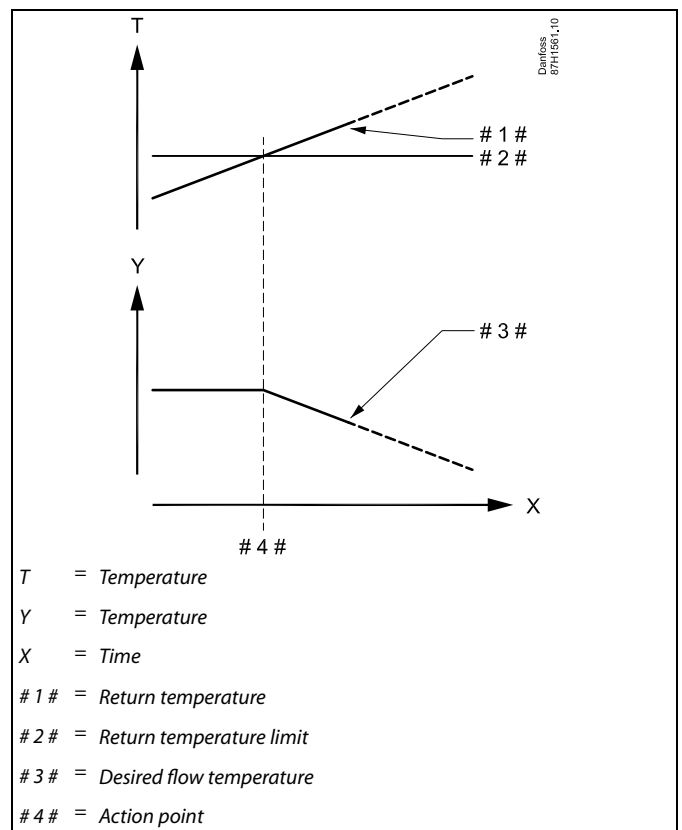

## Operating Guide ECL Comfort 310, application A361

Example, minimum return temperature limitation;  
return temperature gets lower than limit

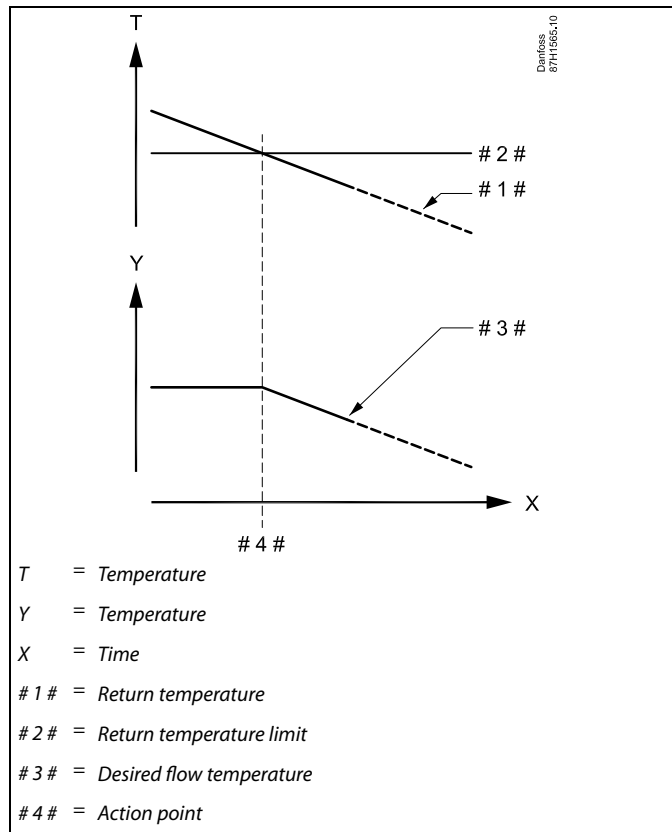

Parameters indicated with an ID no. like "1x607" mean a universal parameter.  
x stands for circuit / parameter group.

### MENU > Settings > Return limit

<b>High T out X1 (return temp. limitation, high limit, X-axis)</b>	<b>1x031</b>
--	--------------

*Set the outdoor temperature value for the low return temperature limitation.*

See Appendix "Parameter ID overview"

The corresponding Y coordinate is set in 'Low limit Y1'.

### MENU > Settings > Return limit

<b>Low limit Y1 (return temp. limitation, low limit, Y-axis)</b>	<b>1x032</b>
--	--------------

*Set the return temperature limitation referring to the outdoor temperature value set in 'High T out X1'.*

See Appendix "Parameter ID overview"

The corresponding X coordinate is set in 'High T out X1'.

## Operating Guide ECL Comfort 310, application A361

### MENU > Settings > Return limit

<b>Low T out X2 (return temp. limitation, low limit, X-axis)</b>	<b>1x033</b>
<i>Set the outdoor temperature value for the high return temperature limitation.</i>	

See Appendix "Parameter ID overview"

The corresponding Y coordinate is set in 'High limit Y2'.

### MENU > Settings > Return limit

<b>High limit Y2 (return temp. limitation, high limit, Y-axis)</b>	<b>1x034</b>
<i>Set the return temperature limitation referring to the outdoor temperature value set in 'Low T out X2'.</i>	

See Appendix "Parameter ID overview"

The corresponding X coordinate is set in 'Low T out X2'.

### MENU > Settings > Return limit

<b>Infl. - max. (return temp. limitation - max. influence)</b>	<b>1x035</b>
<i>Determines how much the desired flow temperature will be influenced if the return temperature is higher than the set limit.</i>	

See Appendix "Parameter ID overview"

#### *Influence higher than 0:*

The desired flow temperature is increased, when the return temperature gets higher than the set limit.

#### *Influence lower than 0:*

The desired flow temperature is decreased, when the return temperature gets higher than the set limit.

#### **Example**

The return limit is active above 50 °C.  
 The influence is set to 0.5.  
 The actual return temperature is 2 degrees too high.  
 Result:  
 The desired flow temperature is changed by  $0.5 \times 2 = 1.0$  degree.

### MENU > Settings > Return limit

<b>Infl. - min. (return temp. limitation - min. influence)</b>	<b>1x036</b>
<i>Determines how much the desired flow temperature will be influenced if the return temperature is lower than the calculated limit.</i>	

See Appendix "Parameter ID overview"

#### *Influence higher than 0:*

The desired flow temperature is increased, when the return temperature gets below the calculated limit.

#### *Influence lower than 0:*

The desired flow temperature is decreased, when the return temperature gets below the calculated limit.

#### **Example**

The return limit is active below 50 °C.  
 The influence is set to -3.0.  
 The actual return temperature is 2 degrees too low.  
 Result:  
 The desired flow temperature is changed by  $-3.0 \times 2 = -6.0$  degrees.



Normally, this setting is 0 in district heating systems because a lower return temperature is acceptable.  
 Typically, this setting is higher than 0 in boiler systems to avoid a too low return temperature (see also 'Infl. - max!').

## Operating Guide ECL Comfort 310, application A361

### MENU > Settings > Return limit

<b>Adapt. time (adaptation time)</b>	<b>1x037</b>
<i>Controls how fast the return temperature adapts to the desired return temperature limit (Integration control).</i>	



The adaptation function can correct the desired flow temperature with max. 8 K.

See Appendix "Parameter ID overview"

**OFF:** The control function is not influenced by the 'Adapt. time'.

**Minor value:** The desired temperature is adapted quickly.

**Major value:** The desired temperature is adapted slowly.

### MENU > Settings > Return limit

<b>Priority (priority for return temp. limitation)</b>	<b>1x085</b>
<i>Choose whether the return temperature limitation should overrule the set min. flow temperature 'Temp. min.'.</i>	



If you have a DHW application:  
Please also see 'Parallel operation' (ID 11043).

See Appendix "Parameter ID overview"

**OFF:** The min. flow temperature limit is not overruled.

**ON:** The min. flow temperature limit is overruled.



If you have a DHW application:  
When dependent parallel operation is in function:

- Desired flow temperature for the heating circuit will be minimum limited, when "Priority for return temperature" (ID 1x085) is set to OFF.
- Desired flow temperature for the heating circuit will not be minimum limited, when "Priority for return temperature" (ID 1x085) is set to ON.



## Operating Guide ECL Comfort 310, application A361

### 5.4 Flow / power limit

#### Heating circuit

A flow or energy meter can be connected to the ECL controller in order to limit the flow or consumed power. The signal from the flow or energy meter is a pulse signal.

When the application runs in an ECL Comfort 296 / 310 controller, the flow / power signal can be obtained from a flow / energy meter via the M-bus connection.

The flow / power limitation can be based on the outdoor temperature. Typically, in district heating systems a higher flow or power is accepted at lower outdoor temperatures.

The relationship between the flow or power limits and the outdoor temperature is set in two coordinates.

The outdoor temperature coordinates are set in 'High T out X1' and 'Low T out X2'.

The flow or power coordinates are set in 'Low limit Y1' and 'High limit Y2'. Based on these settings, the controller calculates the limitation value.

When the flow / power gets higher than the calculated limit, the controller gradually reduces the desired flow temperature to obtain an acceptable max. flow or power consumption.

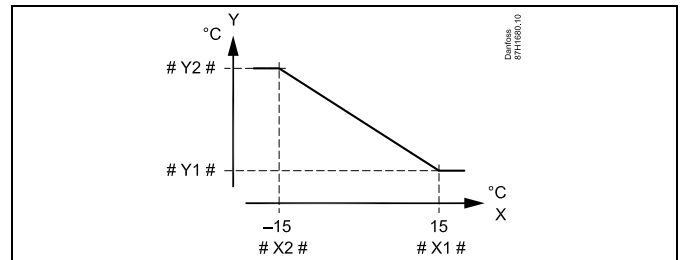

- X = Outdoor temperature
- Y = Limitation, flow or power
- # X1 # = High T out (1x119)
- # X2 # = Low T out (1x118)
- # Y1 # = Low limit (1x117)
- # Y2 # = High limit (1x116)

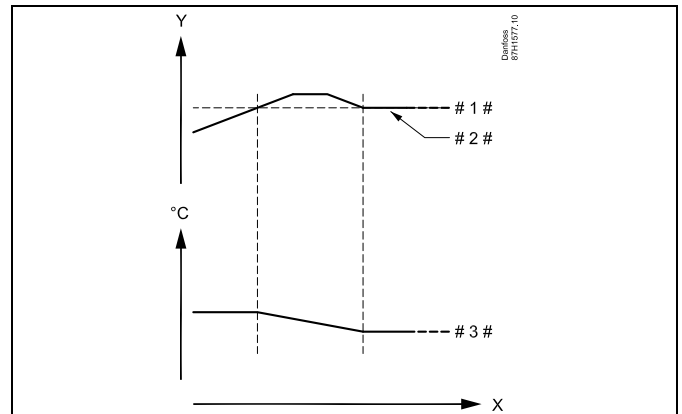

- X = Time
- Y = Flow or power
- # 1 # = Flow or power limit
- # 2 # = Actual flow or energy
- # 3 # = Desired flow temperature



If the 'Adapt. time' is too high, there is a risk of unstable control.

The parameter 'Units' (ID 1x115) has a reduced setting range when the flow / energy signal comes via M-bus.



### Pulse based signal for flow / power, applied to input S7

For monitoring:  
Frequency range is 0.01 - 200 Hz

For limitation:  
Minimum frequency is recommended to be 1 Hz in order to have a stable control. Furthermore, the pulses must appear regularly.



Parameters indicated with an ID no. like "1x607" mean a universal parameter.  
x stands for circuit / parameter group.

## MENU > Settings > Flow / power limit

<b>Input type</b>	<b>1x109</b>
<i>Choice of input type from flow / energy meter</i>	



The setting range for IM and EM depends on chosen subtype.

See Appendix "Parameter ID overview"

**OFF:** No input

**IM1 -** Flow / energy meter signal based on pulses.

**IM5:**

**EM1 -** Flow / energy meter signal from M-bus.

**EM5:**

## MENU > Settings > Flow / power limit

<b>Actual (actual flow or power)</b>
<i>The value is the actual flow or power based on the signal from flow / energy meter.</i>

## MENU > Settings > Flow / power limit

<b>Limit (limitation value)</b>	<b>1x111</b>
<i>This value is in some applications a calculated limitation value, based on the actual outdoor temperature. In other applications the value is a selectable limitation value.</i>	

See Appendix "Parameter ID overview"

## Operating Guide ECL Comfort 310, application A361

### MENU > Settings > Flow / power limit

<b>Adapt. time (adaptation time)</b>	<b>1x112</b>
<i>Controls how fast the flow / power limitation adapts to the desired limitation.</i>	



If the 'Adapt. time' is too low, there is a risk of unstable control.

See Appendix "Parameter ID overview"

**OFF:** The control function is not influenced by the 'Adapt. time'.

**Minor value:** The desired temperature is adapted quickly.

**Major value:** The desired temperature is adapted slowly.

### MENU > Settings > Flow / power limit

<b>Filter constant</b>	<b>1x113</b>
<i>The value of the filter constant determines the dampening of the measured value. The higher the value, the more dampening. By this, a too quick change of the measured value can be avoided.</i>	

See Appendix "Parameter ID overview"

**Minor value:** Lower dampening

**Major value:** Higher dampening

### MENU > Settings > Flow / power limit

<b>Units</b>	<b>1x115</b>
<i>Choice of units for measured values.</i>	



List for setting range of 'Units':

ml, l/h  
l, l/h  
ml, m<sup>3</sup>/h  
l, m<sup>3</sup>/h  
Wh, kW  
kWh, kW  
kWh, MW  
MWh, MW  
MWh, GW  
GWh, GW

See Appendix "Parameter ID overview"

Units to the left: pulse value.

Units to the right: actual and limitation values.

The value from the flow meter is expressed as ml or l.

The value from the energy meter is expressed as Wh, kWh, MWh or GWh.

The values for the actual flow and the flow limitation are expressed as l/h or m<sup>3</sup>/h.

The values for the actual power and the power limitation are expressed as kW, MW or GW.

#### Example 1:

'Units' (11115): l, m<sup>3</sup>/h

'Pulse' (11114): 10

Each pulse represents 10 litres and the flow is expressed as cubic meters (m<sup>3</sup>) per hour.

#### Example 2:

'Units' (11115): kWh, kW (= kilo Watt hour, kilo Watt)

'Pulse' (11114): 1

Each pulse represents 1 kilo Watt hour and the power is expressed in kilo Watt.

## Operating Guide ECL Comfort 310, application A361

### MENU > Settings > Flow / power limit

<b>High limit Y2 (flow / power limitation, high limit, Y-axis)</b>	<b>1x116</b>
--	--------------

<i>Set the flow / power limitation referring to the outdoor temperature set in 'Low T out X2'.</i>	
--	--

See Appendix "Parameter ID overview"

The corresponding X coordinate is set in 'Low T out X2'.

### MENU > Settings > Flow / power limit

<b>Low limit Y1 (flow / power limitation, low limit, Y-axis)</b>	<b>1x117</b>
--	--------------

<i>Set the flow / power limitation referring to the outdoor temperature set in 'High T out X1'.</i>	
---	--



The limitation function can overrule the set 'Temp. min' of the desired flow temperature.

See Appendix "Parameter ID overview"

The corresponding X coordinate is set in 'High T out X1'.

### MENU > Settings > Flow / power limit

<b>Low T out X2 (flow / power limitation, low limit, X-axis)</b>	<b>1x118</b>
--	--------------

<i>Set the outdoor temperature value for the high flow / power limitation.</i>	
--	--

See Appendix "Parameter ID overview"

The corresponding Y coordinate is set in 'High limit Y2'.

### MENU > Settings > Flow / power limit

<b>High T out X1 (flow / power limitation, high limit, X-axis)</b>	<b>1x119</b>
--	--------------

<i>Set the outdoor temperature value for the low flow / power limitation.</i>	
---	--

See Appendix "Parameter ID overview"

The corresponding Y coordinate is set in 'Low limit Y1'.

### 5.5 Optimization

The section "Optimization" describes specific application related issues.

The parameters 'Auto saving', 'Boost', 'Optimizer', 'Total stop' are all related to heating mode only.

'Summer, cut-out' determine, at rising outdoor temperature, the stop of heating.



Parameters indicated with an ID no. like "1x607" mean a universal parameter.  
x stands for circuit / parameter group.

## Operating Guide ECL Comfort 310, application A361

### MENU > Settings > Optimization

#### Auto saving (saving temp. dependent on outdoor temp.) 1x011

Below the set value for the outdoor temperature, the saving temperature setting has no influence. Above the set value for the outdoor temperature, the saving temperature relates to the actual outdoor temperature. The function is relevant in district heating installations in order to avoid a big change in the desired flow temperature after a saving period.

See Appendix "Parameter ID overview"

**OFF:** The saving temperature does not depend on the outdoor temperature; the reduction is 100%.

**Value:** The saving temperature depends on the outdoor temperature. When the outdoor temperature is above 10 °C, the reduction is 100%. The lower the outdoor temperature, the less the temperature reduction. Below the set value, the saving temperature setting has no influence.

**Comfort temperature:** The desired room temperature in Comfort mode

**Saving temperature:** The desired room temperature in Saving mode

The desired room temperatures for Comfort and Saving modes are set in the display overviews.

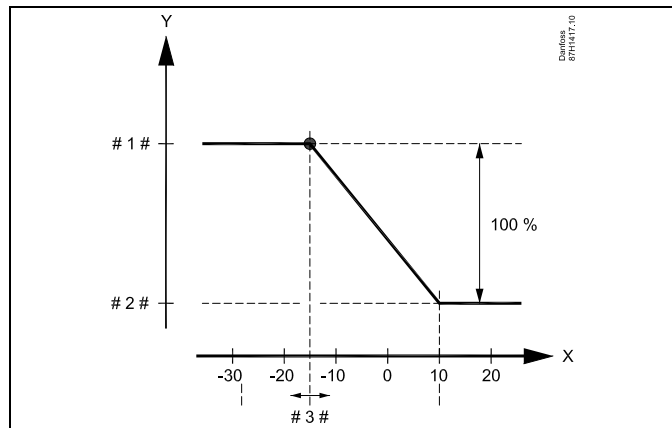

X = Outdoor temperature (°C)  
 Y = Desired room temperature (°C)  
 # 1 # = Desired room temperature (°C), Comfort mode  
 # 2 # = Desired room temperature (°C), Saving mode  
 # 3 # = Auto saving temperature (°C), ID 11011

#### Example:

Actual outdoor temperature (T.out): -5 °C  
 Desired room temperature setting in Comfort mode: 22 °C  
 Desired room temperature setting in Saving mode: 16 °C  
 Setting in 'Auto saving': -15 °C

The condition for the outdoor temperature influence:

$$\text{T.out.influence} = \frac{(10 - \text{T.out})}{(10 - \text{setting})} = \frac{(10 - (-5))}{(10 - (-15))} = \frac{15}{25} = 0,6$$

The corrected desired room temperature in Saving mode:

$$\text{T.room.ref.Saving} + (\text{T.out.influence} \times (\text{T.room.ref.Comfort} - \text{T.room.ref.Saving}))$$

$$16 + (0,6 \times (22 - 16)) = 19,6 \text{ °C}$$

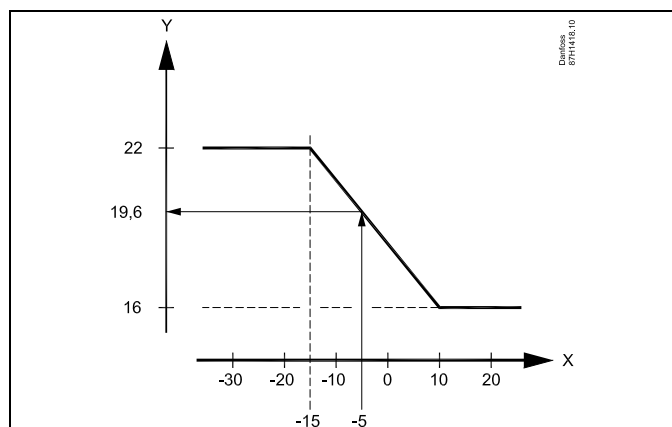

X = Outdoor temperature (°C)  
 Y = Desired room temperature (°C)

## Operating Guide ECL Comfort 310, application A361

### MENU > Settings > Optimization

<b>Boost</b>	<b>1x012</b>
<i>Shortens the heating-up period by increasing the desired flow temperature by the percentage you set.</i>	

See Appendix "Parameter ID overview"

**OFF:** The boost function is not active.

**Value:** The desired flow temperature is increased temporarily with the set percentage.

In order to shorten the heating-up period after a saving temperature period, the desired flow temperature can be increased temporarily (max. 1 hour). At optimizing the boost is active in the optimization period ('Optimizer').  
If a room temperature sensor or an ECA 30 / 31 is connected, the boost stops when the room temperature is reached.

### MENU > Settings > Optimization

<b>Ramp (reference ramping)</b>	<b>1x013</b>
<i>The time (minutes) in which the desired flow temperature increases gradually to avoid load peaks in the heat supply.</i>	

See Appendix "Parameter ID overview"

**OFF:** The ramping function is not active.

**Value:** The desired flow temperature is increased gradually with the set minutes.

In order to avoid load peaks in the supply network, the flow temperature can be set to increase gradually after a period with saving temperature. This causes the valve to open gradually.

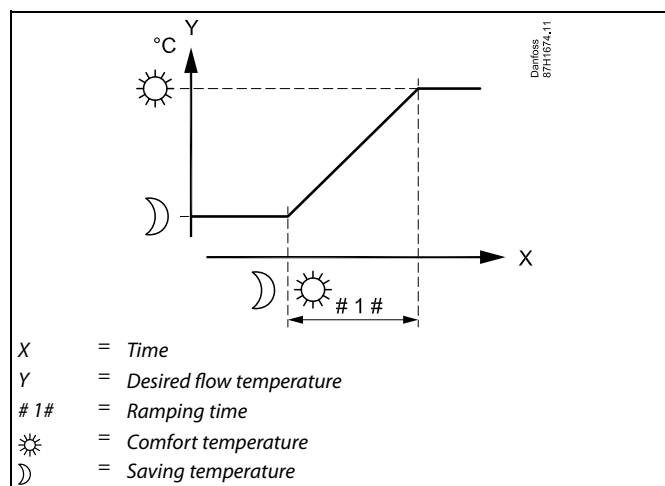

## Operating Guide ECL Comfort 310, application A361

### MENU > Settings > Optimization

Optimizer (optimizing time constant)	1x014
<p>Optimizes the start and stop times for the comfort temperature period to obtain the best comfort at the lowest energy consumption.            The lower the outdoor temperature, the earlier the heating cut-in. The lower the outdoor temperature, the later the heating cut-out.            The optimized heating cut-out time can be automatic or disabled. The calculated start and stop times are based on the setting of the optimizing time constant.</p>	

See Appendix "Parameter ID overview"

Adjust the optimizing time constant.

The value consists of a two digit number. The two digits have the following meaning (digit 1 = Table I, digit 2 = Table II).

**OFF:** No optimization. The heating starts and stops at the times set in the schedule.

**10 ... 59:** See tables I and II.

Table I:

Left digit	Heat accumulation of the building	System type
1-	light	Radiator systems
2-	medium	
3-	heavy	
4-	medium	Floor heating systems
5-	heavy	

Table II:

Right digit	Dimensioning temperature	Capacity
-0	-50 °C	large
-1	-45 °C	.
.	.	.
-5	-25 °C	normal
.	.	.
-9	-5 °C	small

#### Dimensioning temperature:

The lowest outdoor temperature (usually determined by your system designer in connection with the design of the heating system) at which the heating system can maintain the designed room temperature.

#### Example

The system type is radiator, and the heat accumulation of the building is medium.

The left digit is 2.

The dimensioning temperature is -25 °C, and the capacity is normal.

The right digit is 5.

Result:

The setting is to be changed to 25.



## Operating Guide ECL Comfort 310, application A361

### MENU > Settings > Optimization

<b>Total stop</b>	<b>1x021</b>
Setting the 'Total stop' to OFF or ON gives different results, depending on the actual application. The conditions are: - Room temperature controlled applications - Total stop during the saving temperature period	

See Appendix "Parameter ID overview"

#### OFF: No total stop.

Heating applications in general:

**Saving mode:** The desired flow / duct temperature is reduced according to desired duct / room temperature.

**Comfort mode:** If the room temperature gets higher than desired room temperature, the heating switches OFF.

See also the heating related examples.

Cooling applications:

**Saving mode:** The motorized control valve closes.

#### ON: Total stop.

Heating applications with desired duct temperature:

**Saving mode:** The desired flow temperature is set to 'Frost pr. T' (Frost protection temperature).

Heating applications with desired room temperature:

**Saving mode:** The heating is stopped as long as the room temperature is higher than the desired room temperature.

See also the heating related examples.

Cooling applications:

**Saving mode:** The motorized control valve closes.

In general, when total stop is ON, the heating or cooling closes totally when the controller goes into saving mode. However, when 'Total stop' is ON, the controller has room temperature related functions also in comfort mode.

The examples below are related to heating applications:

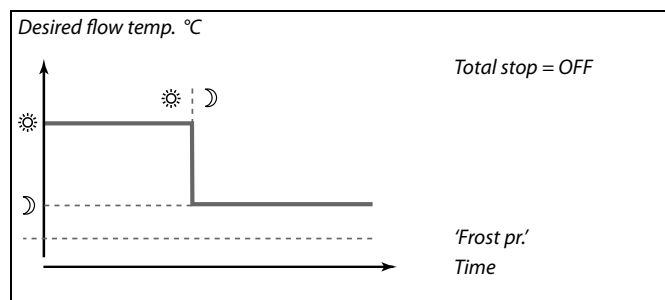
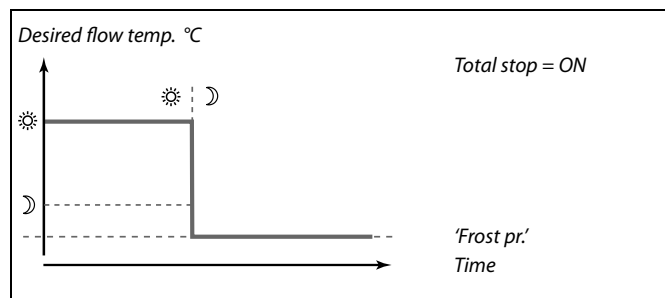

The min. flow temperature limitation ('Temp. min.') is overruled when 'Total stop' is ON.

## Operating Guide ECL Comfort 310, application A361

### MENU > Settings > Optimization

**Pre-stop (optimized stop time)** 1x026

Disable the optimized stop time.

See Appendix "Parameter ID overview"

**OFF:** The optimized stop time is disabled.

**ON:** The optimized stop time is enabled.

Example: Optimization of Comfort from 07:00 - 22:00

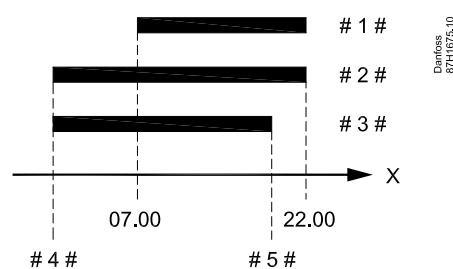

X = Time  
 # 1# = Schedule  
 # 2# = Prestop = OFF  
 # 3# = Prestop = ON  
 # 4# = Optimized start  
 # 5# = Optimized stop

### MENU > Settings > Optimization

**Summer, cut-out (limit for heating cut-out)** 1x179

See Appendix "Parameter ID overview"

The heating can be switched OFF when the outdoor temperature is higher than the set value. The valve closes and after the post-run time, the heating circulation pump stops. 'Temp. min.' will be overruled.

The heating system switches ON again when the outdoor temperature and the accumulated (filtered) outdoor temperature become lower than the set limit.

This function can save energy.

Set the value for outdoor temperature at which you want the heating system to switch OFF.

Summer, cut-out

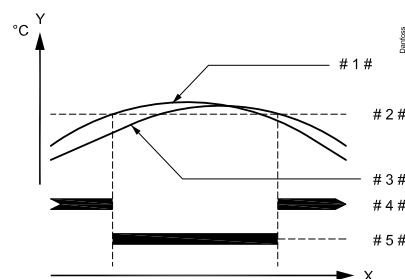

X = Time  
 Y = Temperature  
 # 1# = Actual outdoor temperature  
 # 2# = Cut-out temperature (1x179)  
 # 3# = Accumulated (filtered) outdoor temperature  
 # 4# = Heating enabled  
 # 5# = Heating disabled



The heating cut-out is only active when the controller mode is in scheduled operation. When the cut-out value is set to OFF, there is no heating cut-out.

### 5.6 Control parameters

#### Control of valves

The motorized control valves are controlled by means of 3-point control signal.

##### Valve control:

The motorized control valve is opened gradually when the flow temperature is lower than the desired flow temperature and vice versa.

The water flow through the control valve is managed by means of an electric actuator. The combination "actuator" and "control valve" is also called motorized control valve. The actuator can in this way gradually increase or decrease the flow in order to change the supplied energy. Different types of actuators are available.

##### 3-point controlled actuator:

The electric actuator contains a reversible gear-motor. Electric "open" and "close" signals come from the electronic outputs of the ECL Comfort controller in order to manage the control valve. The signals are in the ECL Comfort controller expressed as "Arrow-up" (open) and "Arrow-down" (close) and displayed at the valve symbol. When the flow temperature (for example at S3) is lower than the desired flow temperature, short open-signals come from the ECL Comfort controller in order to gradually increase the flow. By this, the flow temperature will align with the desired temperature. Oppositely, when the flow temperature is higher than the desired flow temperature, short close-signals come from the ECL Comfort controller in order to gradually reduce the flow. Again, the flow temperature aligns with the desired temperature. Neither open-signals nor close-signals will come as long as the flow temperature corresponds to the desired temperature.

## Operating Guide ECL Comfort 310, application A361

### Thermo-hydraulic actuator, ABV

Danfoss thermo-actuator type ABV is a slow acting valve actuator. Inside the ABV an electric heat coil will heat a thermostatic element when an electric signal is applied. When heating the thermostatic element it expands in order to manage the control valve.

Two basic types are available: ABV NC (Normal Closed) and ABV NO (normal open). For example, ABV NC keeps a 2-port control valve closed when no open-signals are applied.

Electric open-signals come from the electronic output of the ECL Comfort controller in order to manage the control valve. When open-signals are applied to the ABV NC, the valve gradually opens.

Open-signals are in the ECL Comfort controller expressed as "Arrow-up" (open) and displayed at the valve symbol.

When the flow temperature (for example at S3) is lower than the desired flow temperature, relatively long open-signals come from the ECL Comfort controller in order to increase the flow. By this, the flow temperature will over time be aligned with the desired temperature.

Oppositely, when the flow temperature is higher than the desired flow temperature, relatively short open-signals come from the ECL Comfort controller in order to reduce the flow. Again, the flow temperature aligns, over time, with the desired temperature.

The control of the Danfoss thermo-actuator type ABV uses a unique designed algorithm and is based on the PWM principle (Pulse Width Modulation), where the duration of the pulse determines the management of the control valve. The pulses are repeated each 10 sec.

As long as the flow temperature corresponds to the desired temperature, the duration of the open-signals will remain constant.



Parameters indicated with an ID no. like "1x607" mean a universal parameter.  
x stands for circuit / parameter group.

### MENU > Settings > Control parameters

<b>Motor pr. (motor protection)</b>	<b>1x174</b>
-------------------------------------	--------------

*Prevents the controller from unstable temperature control (and resulting actuator oscillations). This can occur at very low load. The motor protection increases the lifetime of all involved components.*



Recommended for duct systems with variable load.

See Appendix "Parameter ID overview"

**OFF:** Motor protection is not activated.

**Value:** Motor protection is activated after the set activation delay in minutes.

## Operating Guide ECL Comfort 310, application A361

### MENU > Settings > Control parameters

<b>Xp (proportional band)</b>	<b>1x184</b>
-------------------------------	--------------

See Appendix "Parameter ID overview"

Set the proportional band. A higher value will result in a stable but slow control of the flow temperature.

### MENU > Settings > Control parameters

<b>Tn (integration time constant)</b>	<b>1x185</b>
---------------------------------------	--------------

See Appendix "Parameter ID overview"

Set a high integration time constant (in seconds) to obtain a slow but stable reaction to deviations.

A low integration time constant will make the controller react fast but with less stability.

### MENU > Settings > Control parameters

<b>M run (running time of the motorized control valve)</b>	<b>1x186</b>
<i>'M run' is the time in seconds it takes the controlled component to move from fully closed to fully open position.</i>	

See Appendix "Parameter ID overview"

Set the 'M run' according to the examples or measure the running time by means of a stop watch.

**How to calculate the running time of a motorized control valve**  
The running time of the motorized control valve is calculated using the following methods:

**Seated valves**

Running time = Valve stroke (mm) x actuator speed (sec. / mm)

*Example: 5.0 mm x 15 sec. / mm = 75 sec.*

**Rotating valves**

Running time = Turning degrees x actuator speed (sec. / degr.)

*Example: 90 degr. x 2 sec. / degr. = 180 sec.*

### MENU > Settings > Control parameters

<b>Nz (neutral zone)</b>	<b>1x187</b>
<i>When the actual flow temperature is within the neutral zone, the controller does not activate the motorized control valve.</i>	



The neutral zone is symmetrical around the desired flow temperature value, i.e. half the value is above and half the value is below this temperature.

See Appendix "Parameter ID overview"

Set the acceptable flow temperature deviation.

Set the neutral zone to a high value if you can accept a high variation in flow temperature.

If you want to tune the PI regulation precisely, you can use the following method:

- Set the 'Tn' (integration time constant) to its max. value (999 sec.).
- Decrease the value for the 'Xp' (proportional band) until the system starts hunting (i.e. gets unstable) with a constant amplitude (it might be necessary to force the system by setting an extreme low value).
- Find the critical time period on the temperature recorder or use a stop watch.

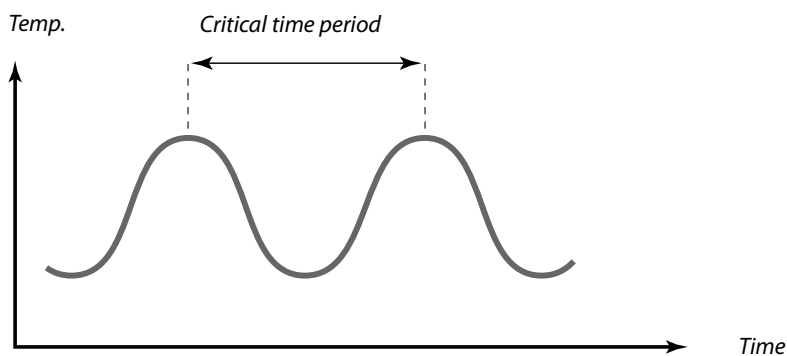

This critical time period will be characteristic for the system, and you can evaluate the settings from this critical period.

$$'Tn' = 0.85 \times \text{critical time period}$$

$$'Xp' = 2.2 \times \text{proportional band value in the critical time period}$$

If the regulation seems to be too slow, you can decrease the proportional band value by 10%. Make sure there is a consumption when you set the parameters.

## Operating Guide ECL Comfort 310, application A361

### 5.7 Pump control

This application can operate with one or two circulation pumps. When operating with two circulation pumps, the pumps are controlled alternately, according to a time set-up. When a pump is switched ON the controller is waiting for differential pressure (S7 for heating circuit, S8 for DHW circuit) to build up. If differential pressure is not achieved, an alarm is generated and the ECL Comfort controller switches ON the other pump.

If none of the pumps can come into operation (detected by means of the differential pressure switch), the alarm is activated and the motorized control valve closes (a safety function).



Parameters indicated with an ID no. like "1x607" mean a universal parameter.  
x stands for circuit / parameter group.

#### MENU > Settings > Pump control

<b>P exercise (pump exercise)</b>	<b>1x022</b>
<i>Exercises the pump to avoid blocking in periods without heat demand.</i>	

See Appendix "Parameter ID overview"

**OFF:** The pump exercise is not active.

**ON:** The pump is switched ON for 1 minute every third day at noon (12:14 hours).

#### MENU > Settings > Pump control

<b>Retry time</b>	<b>1x310</b>
<i>If an alarm has been generated for the pump or alarms have been generated for both pumps, this setting will determine the time between the time of the alarm and the retry time for repeated pump start.</i>	

See Appendix "Parameter ID overview"

**OFF:** No retry time required after an alarm. The pump or pumps in question will not be restarted.

**1 ... 99:** After an alarm, the pump or pumps will be restarted after the set time.

## Operating Guide ECL Comfort 310, application A361

### MENU > Settings > Pump control

<b>Change, duration</b>	<b>1x311</b>
-------------------------	--------------

The number of days between shift of circulation pumps. The shift takes place at the time set in 'Change time'.

See Appendix "Parameter ID overview"

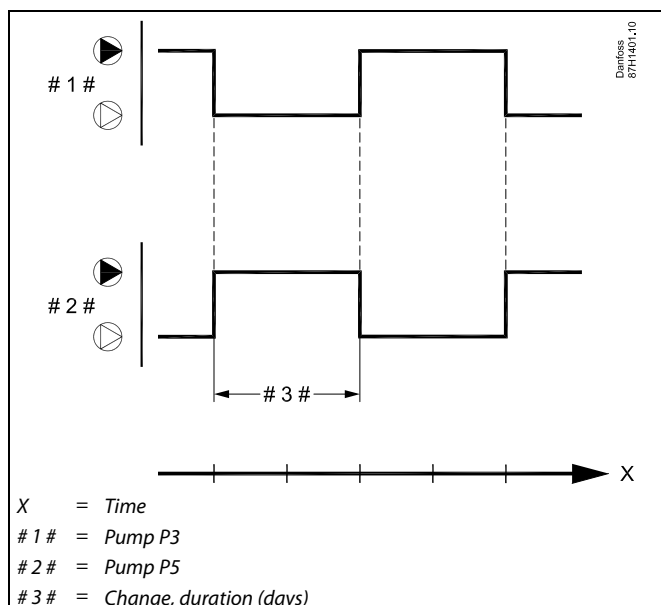

### MENU > Settings > Pump control

<b>Change time (changeover time)</b>	<b>1x312</b>
--------------------------------------	--------------

The exact time of the day, where the shift must take place. The day is divided into 24 hours. The factory setting here is 12 which means 12:00 (noon).

See Appendix "Parameter ID overview"

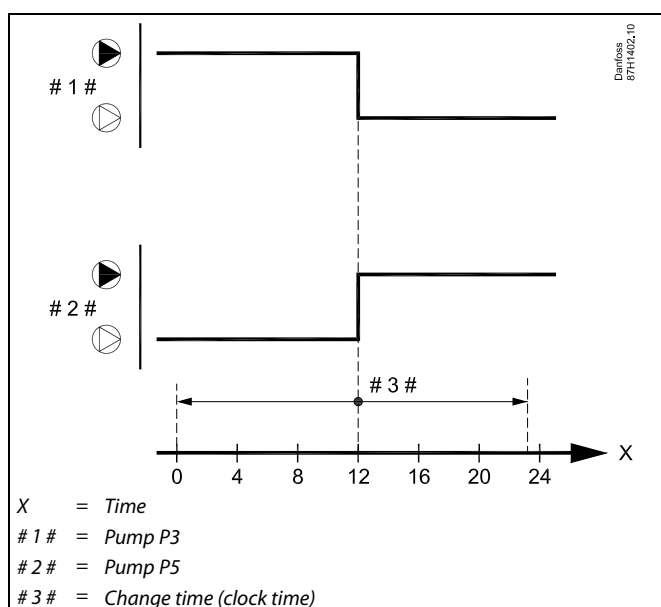

### MENU > Settings > Pump control

<b>Stab. time (stabilization time)</b>	<b>1x313</b>
--	--------------

Setting of max. time to elapse between pump start command and feedback from differential pressure switch. If the differential pressure switch does not give feedback within the set time, the alarm will be activated and the other pump will get a start command.

See Appendix "Parameter ID overview"

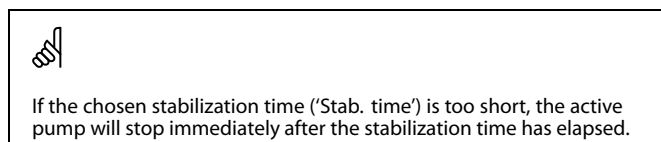



## Operating Guide ECL Comfort 310, application A361

### MENU > Settings > Pump control

<b>Chan.-over time (change-over time)</b>	<b>1x314</b>
<i>Setting of time to elapse between the pump stop command for one pump and the start command for the other pump. The change-over time can ensure that a pump is stopped efficiently before the other pump starts.</i>	

See Appendix "Parameter ID overview"

**OFF:** One circulation pump in the application.

**1 ... 99:** Time for change-over.

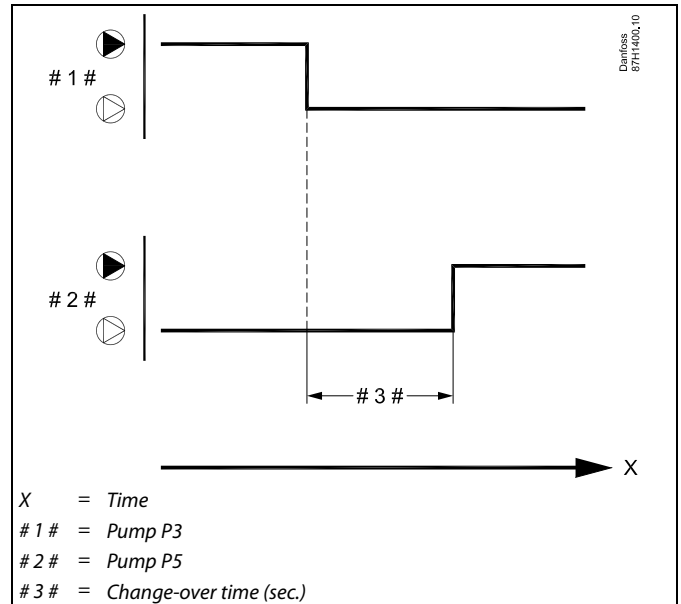

'Chan.-over time' has to be chosen in systems with two pumps.



The status of the differential pressure switch is shown in 'Input overview'.  
(Navigation: MENU > Common controller > Input overview).

**Example:**

S7 status . . . OFF / ON

**OFF:** The differential pressure switch is closed (differential pressure is OK)

**ON:** The differential pressure switch is open (differential pressure is not OK)



## Operating Guide ECL Comfort 310, application A361



Parameters indicated with an ID no. like "1x607" mean a universal parameter.  
x stands for circuit / parameter group.

### MENU > Settings > Refill water

<b>P exercise (pump exercise)</b>	<b>1x320</b>
<i>The time the pump is activated during exercise. Exercise takes place every day (at 12:00).</i>	

See Appendix "Parameter ID overview"

**OFF:** No pump exercise.

**1 ... 200:** Activation time during exercise.

### MENU > Settings > Refill water

<b>Pressure, des. (desired pressure)</b>
<i>Read out of the calculated desired pressure at the inlet / outlet. Access to conversion (scale) settings: Push dial.</i>

See Appendix "Parameter ID overview"

Set the relationship between outdoor temperature and desired pressure.

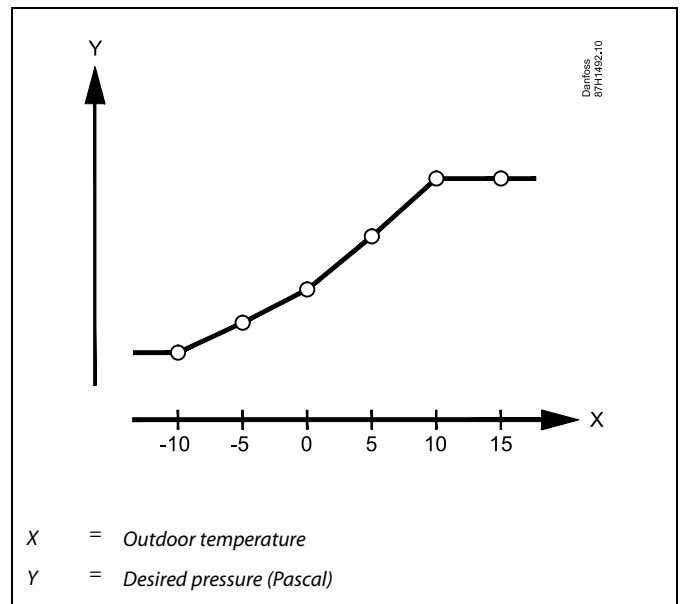

### MENU > Settings > Refill water

<b>Pressure, diff. (switching difference)</b>	<b>1x322</b>
<i>Setting of the switching difference for measured static pressure (pressure transmitter). The difference is symmetrical around the 'Pressure des.' See also 'Pressure des.'</i>	



The settings in 'Pressure, des.' and 'Pressure, diff.' have no influence when a pressure switch is used.

See Appendix "Parameter ID overview"

# Operating Guide ECL Comfort 310, application A361

## MENU > Settings > Refill water

<b>Time-out</b>	<b>1x323</b>
Setting of the max. time for refill. The pressure, measured by S10, must be OK within the set time. If not, the refill water function stops and an alarm is activated.	

See Appendix "Parameter ID overview"

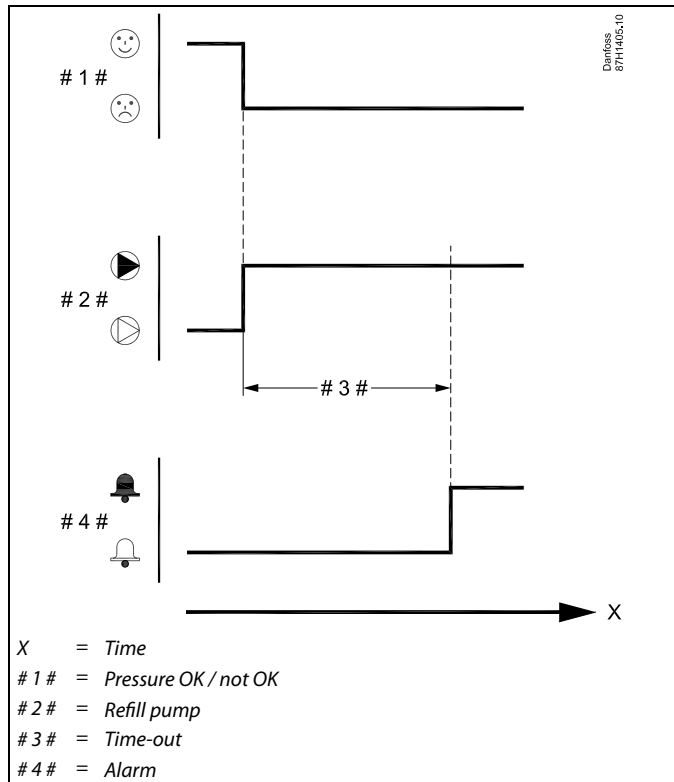
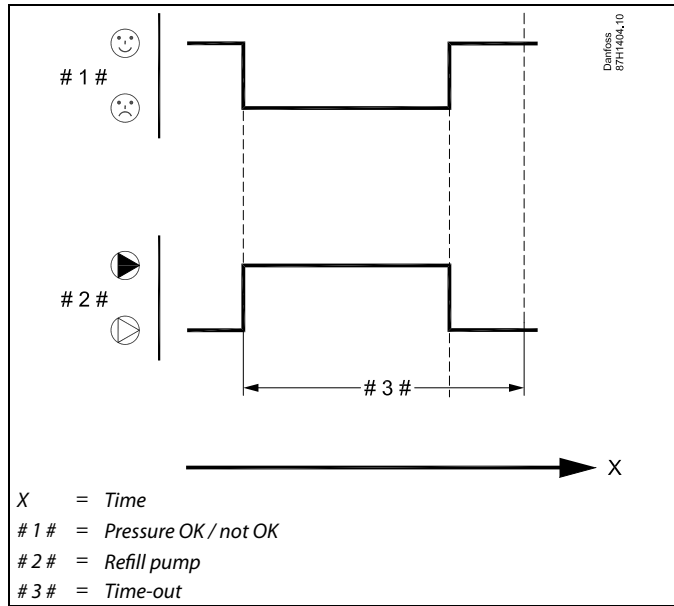

## Operating Guide ECL Comfort 310, application A361

### MENU > Settings > Refill water

<b>Valve delay</b>	<b>1x325</b>
Setting of the time for activation of the ON/OFF valve after start of the refill water pump.	

See Appendix "Parameter ID overview"

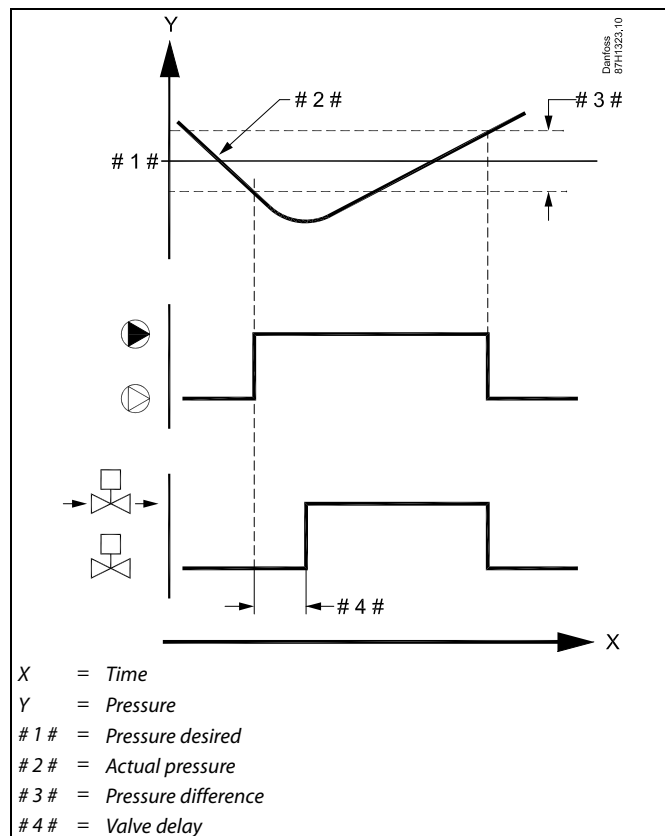

### MENU > Settings > Refill water

<b>No. of pumps</b>	<b>1x326</b>
Setting of the number of pumps in the refill water circuit.	

See Appendix "Parameter ID overview"

**OFF:** The refill water pump function is controlled by the master controller.

**1 ... 2:** The refill water function has one or two pumps.

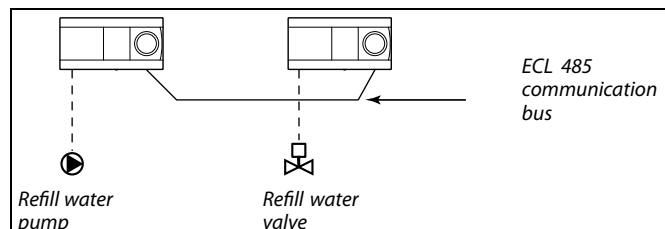

When selecting OFF and a demand for refill occurs, the controller for the actual circuit sends the requirement via the ECL 485 communication bus to the master controller.

The master must be running an application with refill water function. The master starts the refill water pump and sends, via the ECL 485 communication bus, a message that the refill water pump is started. The refill water valve then opens.

The slave must have an address 1 ... 9.

## Operating Guide ECL Comfort 310, application A361

### MENU > Settings > Refill water

<b>Input type</b>	<b>1x327</b>
<i>Choice of pressure input signal.</i>	



When selecting 'OFF', the refill water system could be self-acting.

See Appendix "Parameter ID overview"

**OFF:** Pressure signal is not required. The refill water function is disabled.

**AI:** The input signal is an analog signal (0 - 10 V).

**DI:** The input signal is a digital signal (switch OFF or ON).



The static pressure is shown in 'Input overview' as a value in bar or OFF / ON.

**Example:**

**OFF:** The pressure switch is open (pressure is not OK)

**ON:** The pressure switch is closed (pressure is OK)

## Operating Guide ECL Comfort 310, application A361

### 5.9 Application

The section "Application" describes specific application related issues.

Some of the parameter descriptions are universal for different application keys.



Parameters indicated with an ID no. like "1x607" mean a universal parameter.  
x stands for circuit / parameter group.

#### MENU > Settings > Application

<b>Demand offset</b>	<b>1x017</b>
<i>The desired flow temperature in heating circuit 1 can be influenced by the demand for a desired flow temperature from another controller (slave) or another circuit.</i>	

See Appendix "Parameter ID overview"

**OFF:** The desired flow temperature in circuit 1 is not influenced by the demand of any other controller (slave or circuit 2).

**Value:** The desired flow temperature is increased by the set value in 'Demand offset', if the demand of the slave / circuit 2 is higher.

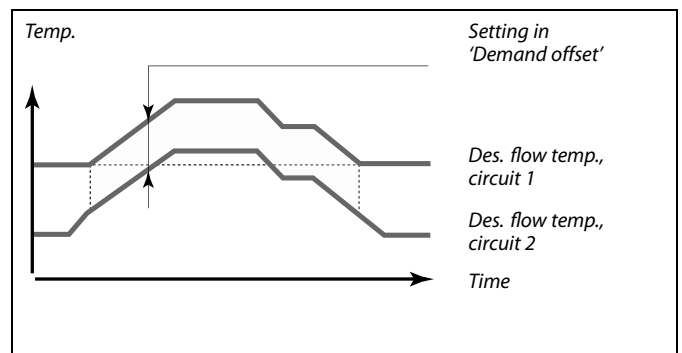

The function of 'Demand offset' can compensate for heat losses between master and slave controlled systems.

#### MENU > Settings > Application

<b>M exercise (valve exercise)</b>	<b>1x023</b>
<i>Exercises the valve to avoid blocking in periods without heat demand.</i>	

See Appendix "Parameter ID overview"

**OFF:** The valve exercise is not active.

**ON:** The valve opens for 7 minutes and closes for 7 minutes every third day at noon (12:00 hours).

## Operating Guide ECL Comfort 310, application A361

### MENU > Settings > Application

<b>DHW priority (closed valve / normal operation)</b>	<b>1x052</b>
---	--------------

*The heating circuit can be closed when the controller acts as slave and when DHW heating / charging is active in the master.*



This setting must be considered if this controller is a slave.

See Appendix "Parameter ID overview"

**OFF:** The flow temperature control remains unchanged during active DHW heating / charging in the master controller.

**ON:** The valve in the heating circuit is closed\* during active DHW heating / charging in the master controller.

\* *The desired flow temperature is set to the value set in 'Frost pr. T'*

### MENU > Settings > Application

<b>P frost T (circulation pump, frost protection temp.)</b>	<b>1x077</b>
---	--------------

*Frost protection, based on the outdoor temperature. When the outdoor temperature gets below the set temperature value in 'P frost T', the controller automatically switches ON the circulation pump (for example P1 or X3) to protect the system.*



Under normal conditions, your system is not frost protected if your setting is below 0 °C or OFF. For water-based systems, a setting of 2 °C is recommended.

See Appendix "Parameter ID overview"

**OFF:** No frost protection.

**Value:** Circulation pump is ON when the outdoor temperature is below the set value.



If the outdoor temperature sensor is not connected and the factory setting has not been changed to 'OFF', the circulation pump is always ON.

### MENU > Settings > Application

<b>P heat T (heat demand)</b>	<b>1x078</b>
-------------------------------	--------------

*When the desired flow temperature is above the set temperature in 'P heat T', the controller automatically switches ON the circulation pump.*



The valve is fully closed as long as the pump is not switched on.

See Appendix "Parameter ID overview"

**Value:** The circulation pump is switched ON when the desired flow temperature is above the set value.

### MENU > Settings > Application

<b>Frost pr. T (frost protection temp.)</b>	<b>1x093</b>
---	--------------

*Set the desired flow temperature at temperature sensor S3 to protect the system against frost (at heating cut-out, total stop etc.). When the temperature at S3 gets lower than the setting, the motorized control valve opens gradually.*



The frost protection temperature can also be set in your favorite display when the mode selector is in frost protection mode.

See Appendix "Parameter ID overview"



## Operating Guide ECL Comfort 310, application A361

### Override mode functions:

The following settings describe the function in general for the ECL Comfort 210 / 296 / 310 series. The explained modes are typical and not application related. They might differ from the override modes in your application.

### MENU > Settings > Application

<b>Ext. input (external override)</b>	<b>1x141</b>
Choose the input for 'Ext. input' (external override). By means of a switch the controller can be overridden to 'Comfort', 'Saving', 'Frost protection' or 'Constant temperature' mode.	

See Appendix "Parameter ID overview"

**OFF:** No inputs have been selected for external override.

**S1 ... S16:** Input selected for external override.

If S1... S6 is chosen as override input, the override switch must have gold-plated contacts.

If S7 ... S16 is chosen as override input, the override switch can be a standard contact.

See the drawings for connection examples of override switch and override relay to input S8.

S7...S16 are recommended for override switch.

If ECA 32 is mounted, also S11... S16 can be used.

If ECA 35 is mounted, also S11 or S12 can be used.

Example: Connection of an override switch

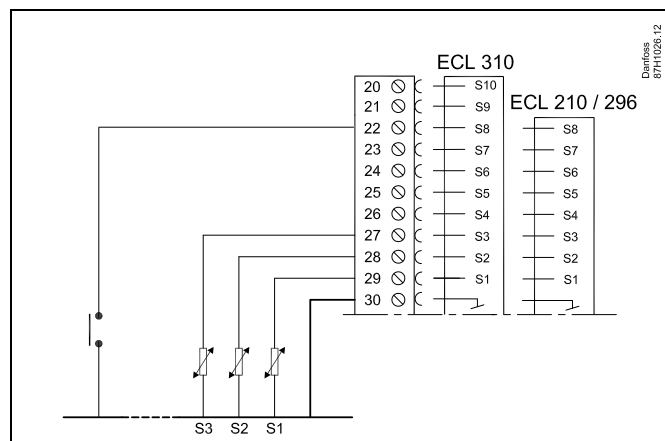

Example: Connection of an override relay

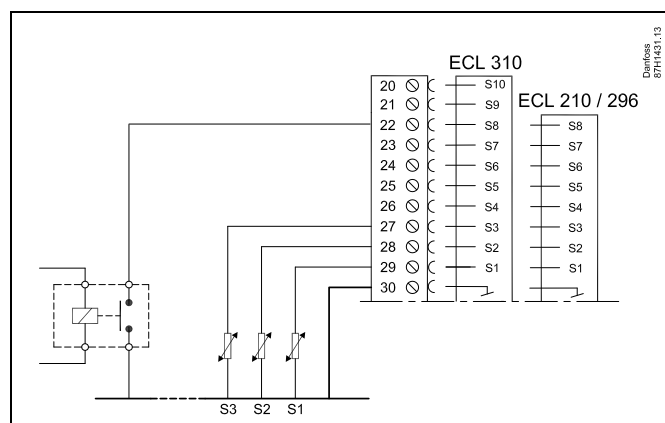

Choose only an unused input for override. If an already used input is applied for override, the functionality of this input is also neglected.



See also 'Ext. mode'.

## Operating Guide ECL Comfort 310, application A361

### MENU > Settings > Application

**Ext. mode (external override mode)** 1x142

The mode override can be activated for Saving, Comfort, Frost pr. or Constant T mode.  
For override, the controller mode must be in scheduled mode.

See Appendix "Parameter ID overview"

Choose an override mode:

- SAVING:** The circuit in question is in saving mode when the override switch is closed.
- COMFORT:** The circuit in question is in comfort mode when the override switch is closed.
- FROST PR.:** The heating or DHW circuit closes, but is still frost protected.
- CONSTANT T:** The circuit in question controls a constant temperature \*)

\*) See also 'Desired T' (1x004), setting of desired flow temperature (MENU > Settings > Flow temperature)  
See also 'Con. T, ret. T lim.' (1x028), setting of return temperature limitation (MENU > Settings > Return limit)

The process diagrams show the functionality.



Example: Override to Comfort mode

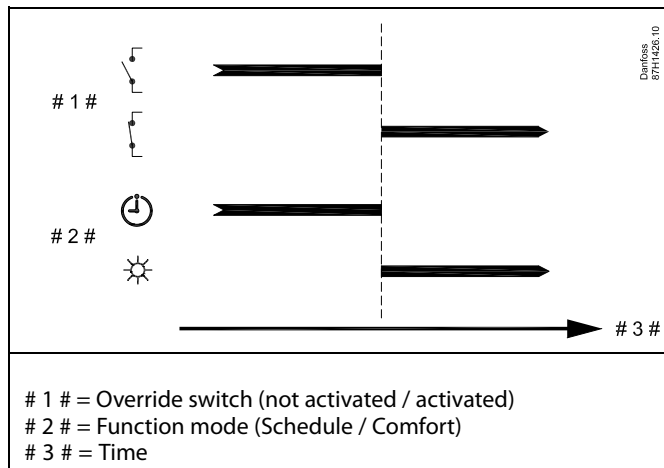

Example: Override to Saving mode

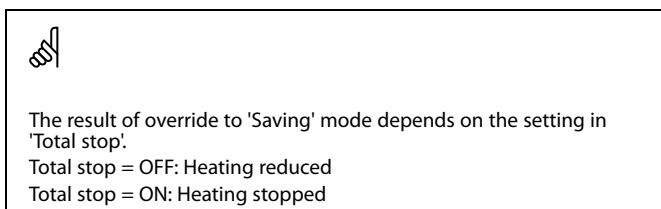
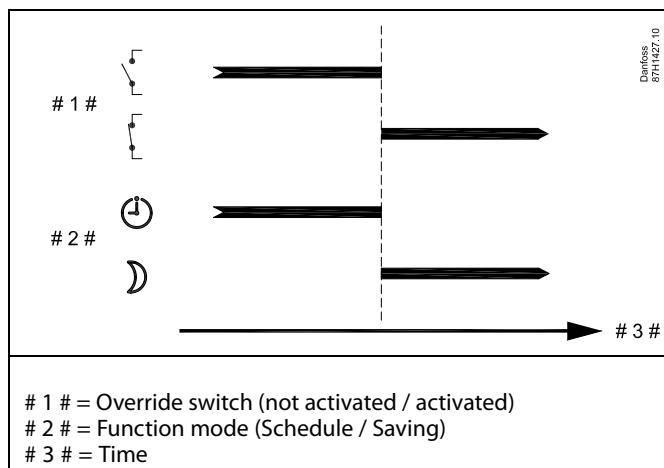

Example: Override to Frost protection mode

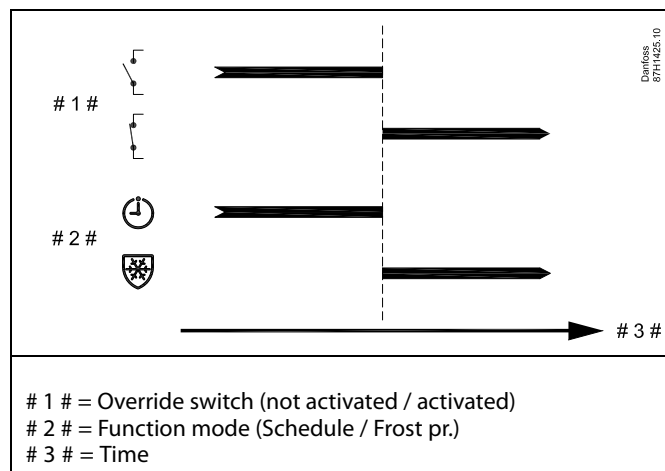

Example: Override to Constant temperature mode

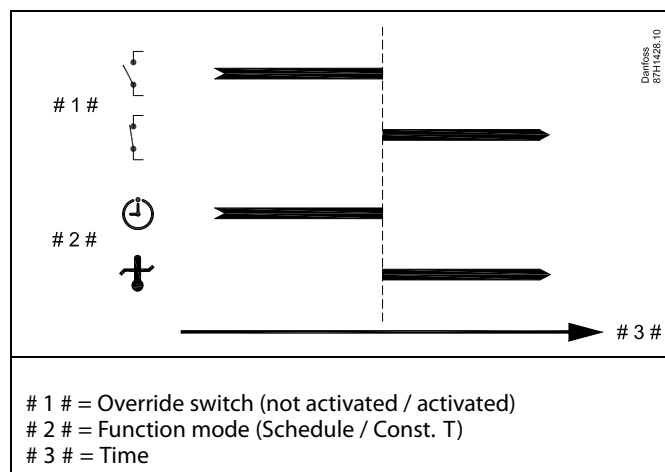

The "Const. T" value can be influenced by:

- temp. max.
- temp. min.
- room temp. limit
- return temp. limit
- flow / power limit

## MENU > Settings > Application

<b>Min. act. time (min. activation time gear motor)</b>	<b>1x189</b>
<i>The min. pulse period of 20 ms (milliseconds) for activation of the gear motor.</i>	

Setting example	Value x 20 ms
2	40 ms
10	200 ms
50	1000 ms

See Appendix "Parameter ID overview"



The setting should be kept as high as acceptable to increase the lifetime of the actuator (gear motor).

## Operating Guide ECL Comfort 310, application A361

### 5.10 Alarm

The section "Alarm" describes specific application related issues. Application A231 offers two types of alarms:

Type:	Description:
1	Actual flow temperature differs from the desired flow temperature
1	A331.1, A331.2: The universal alarm input S9 is activated
2	An activated circulation pump does not generate a pressure difference
2	The refill water function does not generate a pressure within set time

The alarm functions activate the alarm bell symbol. The alarm functions activate A1 (Relay 4).

The alarm relay can activate a lamp, a horn, an input to an alarm transmitting device etc.

The alarm symbol / relay is activated:

- (type 1) as long as the alarm reason is present (automatic reset).
- (type 2) even if the alarm reason disappears again (manual reset).

Alarm type 1:

- If the flow temperature deviates more than the set differences from the desired flow temperature, the alarm symbol / relay will be activated.

If the flow temperature becomes acceptable, the alarm symbol / relay will be de-activated.

- If the universal alarm input S9 is activated.

If the universal alarm input S9 is de-activated, the alarm symbol / relay will be de-activated.

Alarm type 2:

- If pump differential pressure S7 is not registered, the alarm symbol / relay will be activated. Furthermore, the control valve will close.

This alarm must be manually reset.

- If Refill water function has not generated acceptable pressure, the alarm symbol / relay will be activated.

This alarm must be manually reset.



Parameters indicated with an ID no. like "1x607" mean a universal parameter.  
x stands for circuit / parameter group.

## Operating Guide ECL Comfort 310, application A361

### 5.10.1 Temp. monitor.

#### MENU > Settings > Alarm

<b>Upper difference</b>	<b>1x147</b>
<i>The alarm is activated if the actual flow temperature increases more than the set difference (acceptable temperature difference above the desired flow temperature). See also 'Delay'.</i>	

See Appendix "Parameter ID overview"

**OFF:** The related alarm function is not active.

**Value:** The alarm function is active if the actual temperature gets above the acceptable difference.

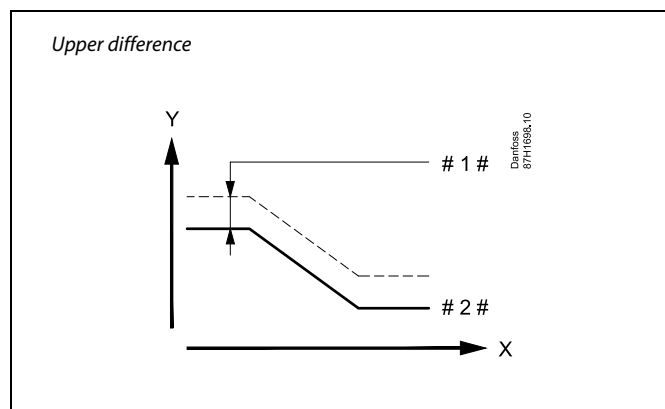

X = Time  
 Y = Temperature  
 # 1 # = Upper difference  
 # 2 # = Desired flow temperature

#### MENU > Settings > Alarm

<b>Lower difference</b>	<b>1x148</b>
<i>The alarm is activated if the actual flow temperature decreases more than the set difference (acceptable temperature difference below the desired flow temperature). See also 'Delay'.</i>	

See Appendix "Parameter ID overview"

**OFF:** The related alarm function is not active.

**Value:** The alarm function is active if the actual temperature gets below the acceptable difference.

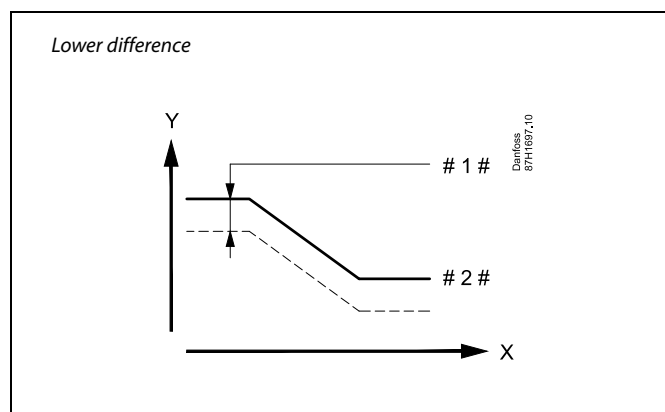

X = Time  
 Y = Temperature  
 # 1 # = Lower difference  
 # 2 # = Desired flow temperature

## Operating Guide ECL Comfort 310, application A361

### MENU > Settings > Alarm

<b>Delay, example</b>	<b>1x149</b>
-----------------------	--------------

If an alarm condition from either 'Upper difference' or 'Lower difference' is present for a longer time than the set delay (in minutes), the alarm function is activated.

See Appendix "Parameter ID overview"

**Value:** The alarm function will be activated if the alarm condition remains after the set delay.

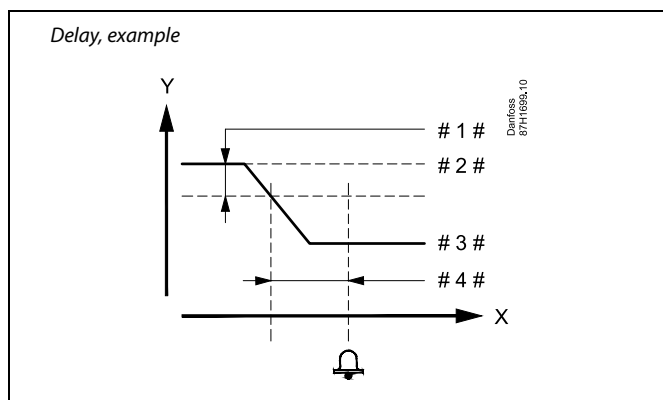

X = Time  
 Y = Temperature  
 # 1 # = Lower difference  
 # 2 # = Desired flow temperature  
 # 3 # = Actual flow temperature  
 # 4 # = Delay (ID 1x149)

### MENU > Settings > Alarm

<b>Lowest temp.</b>	<b>1x150</b>
---------------------	--------------

The alarm function will not be activated if the desired flow temperature is lower than the set value.

See Appendix "Parameter ID overview"



If the cause of the alarm disappears, the alarm indication and output also disappear.

### 5.10.2 Clear alarm

#### Clear alarm

If an alarm has been generated, a bell is shown in one of the favorite display (see 'Monitoring temperatures and system components') or in an overview display (see 'Understanding the controller display'). The following menus are used to locate the alarm cause and reset (clear) the alarm signal. Even when the cause of the alarm has disappeared, the indication will still be active until the clear alarm procedure has been carried out.

### MENU > Settings > Alarm

<b>Circ. pumps</b>	<b>1x315</b>
--------------------	--------------

Choose whether the alarm should be cleared or not.

See Appendix "Parameter ID overview"

**OFF:** The alarm has not been activated.

**ON:** The alarm has been activated.

Clear alarm procedure:

If the status is 'ON': Change 'ON' to 'OFF'.

If the status is 'OFF': It is not possible to change it to 'ON'.

## Operating Guide ECL Comfort 310, application A361

---

### MENU > Settings > Alarm

<b>Refill water</b>	<b>1x324</b>
<i>Choose whether the alarm should be cleared or not.</i>	

See Appendix "Parameter ID overview"

**OFF:** The alarm has not been activated.

**ON:** The alarm has been activated.

Clear alarm procedure:

If the status is 'ON': Change 'ON' to 'OFF'.

If the status is 'OFF': It is not possible to change it to 'ON'.

## Operating Guide ECL Comfort 310, application A361

### 5.11 Alarm overview

#### MENU > Alarm > Alarm overview

This menu shows the alarm types, for example:

- "2: Temp. monitor"
- "32: T sensor defect"

The alarm has been activated if the alarm symbol (a bell) (🔔) is present to the right of the alarm type.



#### Resetting an alarm, in general:

MENU > Alarm > Alarm overview:  
Look for alarm symbol in specific line.

(Example: "2: Temp. monitor")  
Move cursor to the line in question.  
Push dial.



#### Alarm overview:

Alarm sources are listed in this overview menu.

Some examples:  
"2: Temp. monitor"  
"5: Pump 1"  
"10: Digital S12"  
"32: T sensor defect"

Related to the examples, the numbers 2, 5 and 10 are used in the alarm communication to the BMS / SCADA system.

Related to the examples, "Temp. monitor", "Pump 1" and "Digital S12" are the alarm points.

Related to the examples, "32: T sensor defect" indicates the monitoring of connected sensors.

Alarm numbers and alarm points might differ depending on actual application.

The alarm overview lists the components or functions that could cause an alarm.

The number to the left (i.e. 1, 5, 6, 7) relates to the alarm number which is sent by Modbus communication to a SCADA system.

Two alarm types can be present, i.e. the alarms that are logged and the alarms that are not logged.

Example:

The alarm type for 'Refill water', 'Pump 3' and 'Pump 5' are logged alarms. This means that the alarm symbol will remain until the alarm has been cleared even if the cause of the alarm has disappeared.

The alarm type for 'Temp. monitor' e.g. is not a logged alarm which means that the alarm symbol will only be present as long as the alarm cause exists.

Alarm 1

**Alarm overview:**

- ▶ 1: Refill water
- 5: Pump 3
- 6: Pump 5 🔔
- 7: Temp. monitor.

*Example:*  
'Pump P5' has caused an alarm.



The alarm overview will only list components or functions that could cause an alarm.









## 6.0 Common controller settings

### 6.1 Introduction to 'Common controller settings'

Some general settings which apply to the entire controller are located in a specific part of the controller.

To enter 'Common controller settings':

Action:	Purpose:	Examples:
	Choose 'MENU' in any circuit	MENU
	Confirm	
	Choose the circuit selector at the top right corner in the display	
	Confirm	
	Choose 'Common controller settings'	
	Confirm	

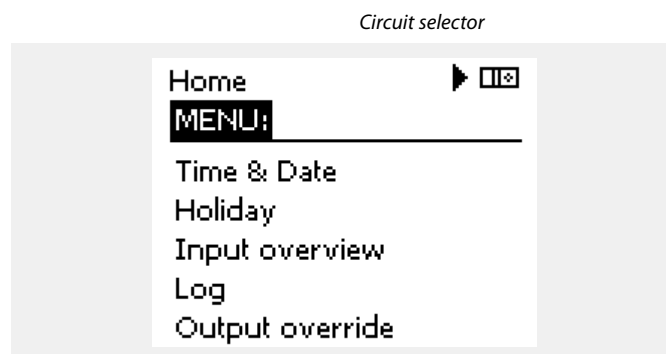

## Operating Guide ECL Comfort 310, application A361

### 6.2 Time & Date

It is only necessary to set the correct date and time in connection with the first use of the ECL Comfort controller or after a power break of more than 72 hours.

The controller has a 24 hour clock.

#### Aut. daylight (Daylight saving time changeover)





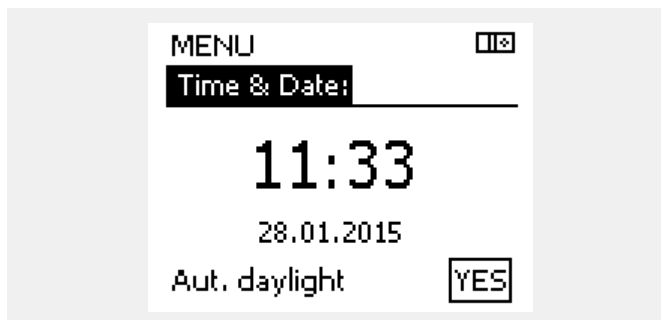













**YES:** The controller's built-in clock automatically changes + / - one hour on the standardized days for daylight saving time changeover for Central Europe.

**NO:** You change manually between summer and winter time by setting the clock backward or forward.



 When controllers are connected as slaves in a master / slave system (via ECL 485 communication bus), they will receive 'Time & Date' from the master.

How to set time and date:

Action:	Purpose:	Examples:
	Choose 'MENU'	MENU
	Confirm	
	Choose the circuit selector at the top right corner in the display	
	Confirm	
	Choose 'Common controller settings'	
	Confirm	
	Go to 'Time & Date'	
	Confirm	
	Place the cursor at the position to be changed	
	Confirm	
	Enter the desired value	
	Confirm	
	Move the cursor to the next position to be changed. Continue until 'Time & Date' has been set.	
	Finally move the cursor to 'MENU'	
	Confirm	
	Move the cursor to 'HOME'	
	Confirm	

## Operating Guide ECL Comfort 310, application A361

### 6.3 Holiday

This section describes the function in general for the ECL Comfort 210 / 296 / 310 series. The shown displays are typical and not application related. They might differ from the displays in your application.

There is a holiday program for each circuit and a holiday program for the common controller.

Each holiday program contains one or more schedules. Each schedule can be set to a start date and an end date. The set period starts on the start date at 00.00 and stops on the end date at 00.00.

Selectable modes are Comfort, Saving, Frost protection or Comfort 7-23 (before 7 and after 23, the mode is scheduled).

How to set your holiday schedule:

Action:	Purpose:	Examples:
	Choose 'MENU'	MENU
	Confirm	
	Choose the circuit selector at the top right corner in the display	
	Confirm	
	Choose a circuit or 'Common controller settings'	
	Heating	
	DHW	
	Common controller settings	
	Confirm	
	Go to 'Holiday'	
	Confirm	
	Choose a schedule	
	Confirm	
	Confirm choice of mode selector	
	Choose mode	
	· Comfort	
	· Comfort 7-23	
	· Saving	
	· Frost protection	
	Confirm	
	Enter the start time first and then the end time	
	Confirm	
	Go to 'Menu'	
	Confirm	
	Choose 'Yes' or 'No' in 'Save'. Choose the next schedule, if required	



The holiday program in the 'Common controller settings' is valid for all circuits. The holiday program can also be set individually in the heating or DHW circuits.



The end date must be at least be one day later than the start date.

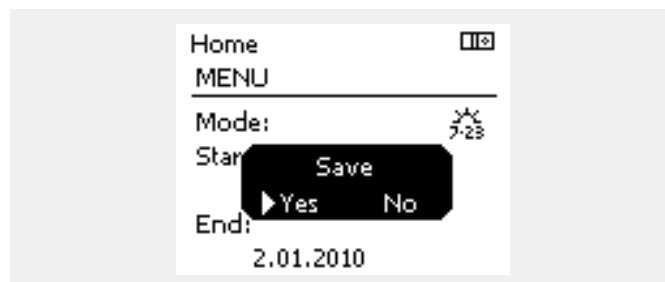
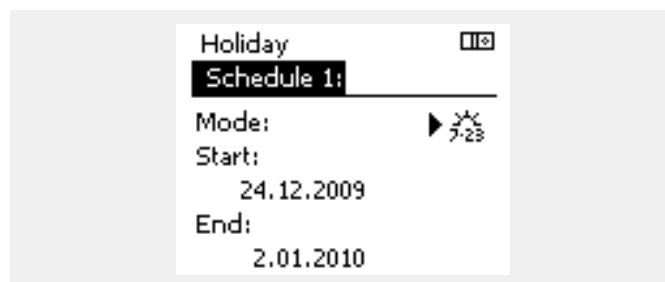
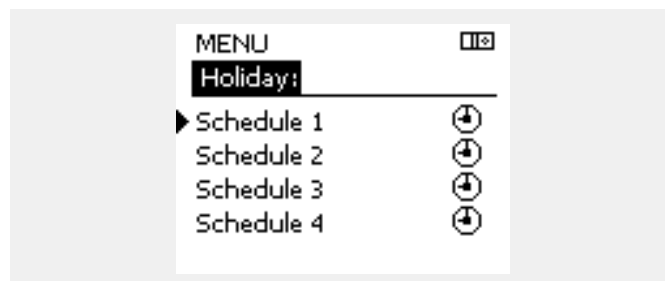

## Operating Guide ECL Comfort 310, application A361

### Holiday, specific circuit / Common Controller

When setting one holiday program in specific circuit and another holiday program in Common Controller, a priority will be taken into account:

1. Comfort
2. Comfort 7 - 23
3. Saving
4. Frost protection

Holiday, deleting a set period:

- Choose the Schedule in question
- Change the mode to "Clock"
- Confirm

#### Example 1:

Circuit 1:  
Holiday set to "Saving"

Common Controller:  
Holiday set to "Comfort"

Result:  
As long as "Comfort" is active in Common Controller, circuit 1 will be in "Comfort".

#### Example 2:

Circuit 1:  
Holiday set to "Comfort"

Common Controller:  
Holiday set to "Saving"

Result:  
As long as "Comfort" is active in circuit 1, it will be in "Comfort".

#### Example 3:





Circuit 1:  
Holiday set to "Frost protection"

Common Controller:  
Holiday set to "Saving"

Result:  
As long as "Saving" is active in Common Controller, circuit 1 will be in "Saving".

The ECA 30 / 31 cannot override the holiday schedule of the controller temporarily.

However, it is possible to make use of the following options from the ECA 30 / 31 when the controller is in scheduled mode:

-  Day off
-  Holiday
-  Relaxing (extended comfort period)
-  Going out (extended saving period)



Energy-saving trick:  
Use 'Going out' (the extended saving period) for airing purposes (e.g. for ventilating the rooms by means of fresh air from open windows).



Connections and setup procedures for ECA 30 / 31:  
See section 'Miscellaneous'.



Quick guide "ECA 30 / 31 to override mode":

1. Go to ECA MENU
2. Move cursor to "Clock" symbol
3. Select the "Clock" symbol
4. Choose and select one of 4 override functions
5. Below the override symbol: Set hours or date
6. Below hours / date: Set desired room temperature for the override period

## Operating Guide ECL Comfort 310, application A361

### 6.4 Input overview

This section describes the function in general for the ECL Comfort 210 / 296 / 310 series. The shown displays are typical and not application related. They might differ from the displays in your application.

The input overview is located in the common controller settings.

This overview will always show you the actual temperatures in the system (read-only).

MENU <span style="float: right;">□ ⊗</span>	
<b>Input overview:</b>	
▶ Outdoor T	7.0 °C
Outdoor acc. T	5.8 °C
Heat return T	35.5 °C
Heat flow T	67.9 °C
DHW flow T	68.6 °C



"Outdoor acc. T" means "Accumulated outdoor temperature" and is a calculated value in the ECL Comfort controller.

## Operating Guide ECL Comfort 310, application A361

### 6.5 Log

This section describes the function in general for the ECL Comfort 210 / 296 / 310 series. The shown displays are typical and not application related. They might differ from the displays in your application.

The log function (temperature history) allows you to monitor the logs of today, yesterday, the past 2 days as well as the past 4 days for the connected sensors.

There is a log display for the relevant sensor, showing the measured temperature.

The log function is only available in the 'Common controller settings'.

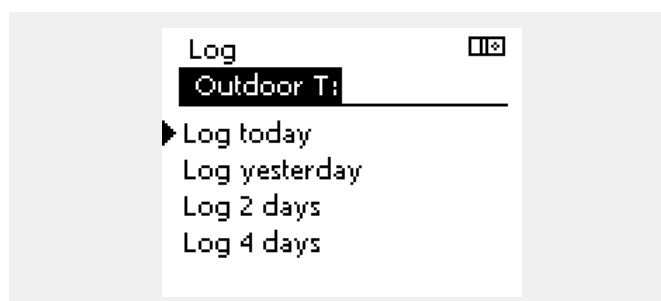
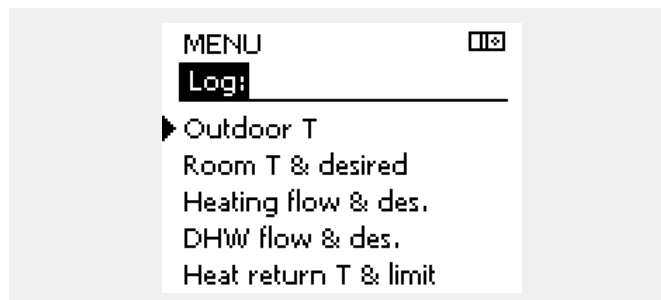

#### Example 1:

1 day log for yesterday showing the development in outdoor temperature during the past 24 hours.

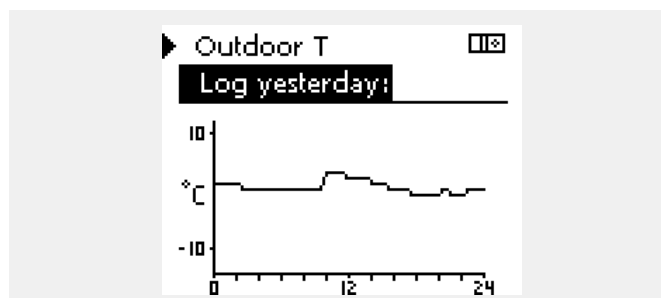

#### Example 2:

Today's log for the actual heating flow temperature as well as the desired temperature.

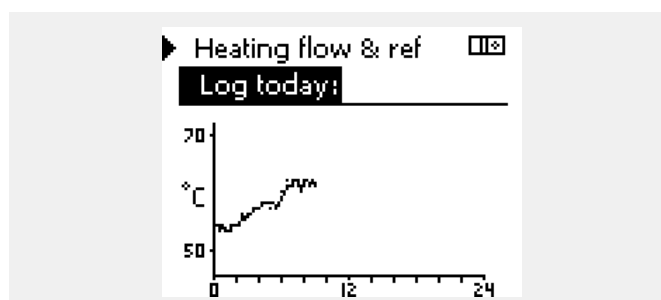

#### Example 3:

Yesterday's log for the DHW flow temperature as well as the desired temperature.

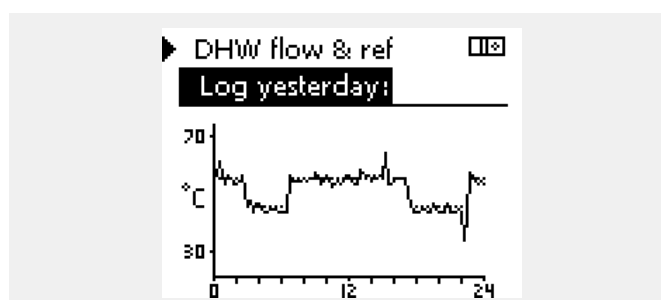

## Operating Guide ECL Comfort 310, application A361

### 6.6 Output override

This section describes the function in general for the ECL Comfort 210 / 296 / 310 series. The shown displays are typical and not application related. They might differ from the displays in your application.

The output override is used to disable one or more of the controlled components. This could among others be useful in a service situation.

Action:	Purpose:	Examples:
	Choose 'MENU' in any of the overview displays	MENU
	Confirm	
	Choose the circuit selector at the top right corner in the display	
	Confirm	
	Choose common controller settings	
	Confirm	
	Choose 'Output override'	
	Confirm	
	Choose a controlled component	M1, P1 etc.
	Confirm	
	Adjust the status of the controlled component: Motorized control valve: AUTO, STOP, CLOSE, OPEN Pump: AUTO, OFF, ON	
	Confirm status change	

Remember to change the status back again as soon as an override is not required any longer.

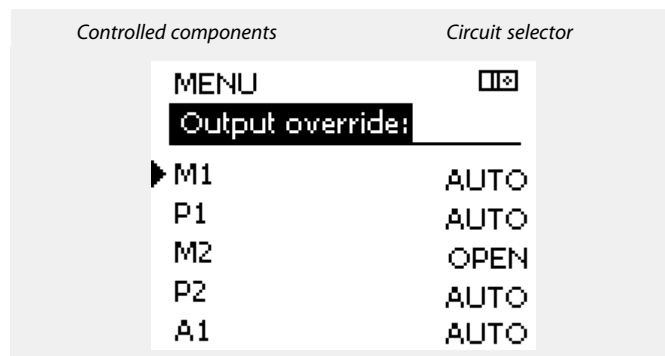

"Manual control" has higher priority than "Output override".



When the selected controlled component (output) is not 'AUTO', the ECL Comfort controller does not control the component in question (pump or motorized control valve e.g.). Frost protection is not active.



When output override of a controlled component is active the symbol '!' is shown to the right of the mode indicator in the enduser displays.

### 6.7 Key functions

<b>New application</b>	<p><b>Erase application:</b> Removes the existing application. As soon as the ECL key is inserted, another application can be chosen.</p>
<b>Application</b>	<p>Gives an overview over the actual application in the ECL controller. Push the dial again to exit the overview.</p>
<b>Factory setting</b>	<p><b>System settings:</b> System settings are, among others, communication set-up, display brightness etc.</p> <p><b>User settings:</b> User settings are, among others, desired room temperature, desired DHW temperature, schedules, heat curve, limitation values etc.</p> <p><b>Go to factory:</b> Restores the factory settings.</p>
<b>Copy</b>	<p><b>To:</b> Copy direction</p> <p><b>System settings</b></p> <p><b>User settings</b></p> <p><b>Start copying</b></p>
<b>Key overview</b>	<p>Gives an overview over the inserted ECL key. (Example: A266 Ver. 2.30). Turn the dial to see the subtypes. Push the dial again to exit the overview.</p>

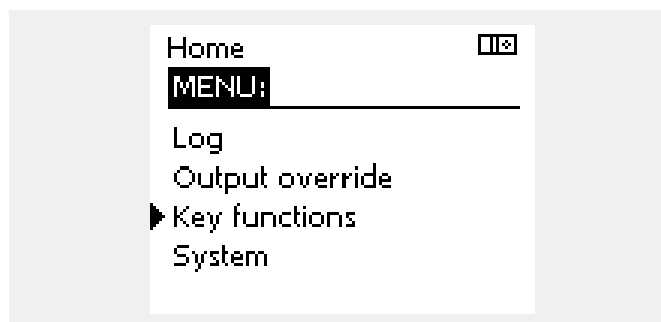

A more detailed description of how to use the individual 'Key functions' can also be seen in 'Inserting the ECL application key'.





The "Key overview" does not inform — through ECA 30 / 31 — about the subtypes of the application key.



**Key inserted / not inserted, description:**

ECL Comfort 210 / 310, controller versions lower than 1.36:

- Take out the application key; for 20 minutes settings can be changed.
- Power up the controller **without** the application key inserted; for 20 minutes settings can be changed.

ECL Comfort 210 / 310, controller versions 1.36 and up:

- Take out the application key; for 20 minutes settings can be changed.
- Power up the controller **without** the application key inserted; settings cannot be changed.

ECL Comfort 296 , controller versions 1.58 and up:

- Take out the application key; for 20 minutes settings can be changed.
- Power up the controller **without** the application key inserted; settings cannot be changed.

## Operating Guide ECL Comfort 310, application A361

### 6.8 System

#### 6.8.1 ECL version

In 'ECL version' you will always be able to find an overview of the data related to your electronic controller.

Please have this information available if you need to contact your Danfoss sales organization concerning the controller.

Information about your ECL Application Key can be found in 'Key functions' and 'Key overview'.

<b>Code no.:</b>	The Danfoss sales and order no. for the controller
<b>Hardware:</b>	Hardware version of the controller
<b>Software:</b>	Software (firmware) version of the controller
<b>Serial no.:</b>	Unique number for the individual controller
<b>Production week:</b>	Week no. and year (WW.YYYY)

Example, ECL version

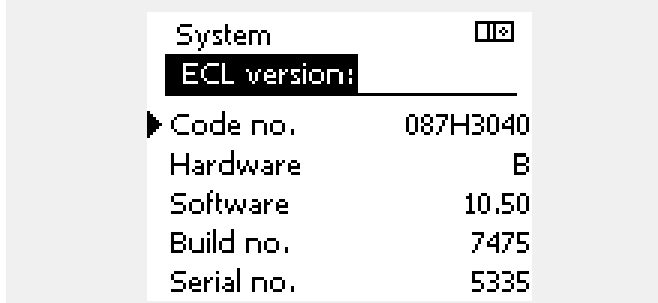

System	☐☒
ECL version:	
▶ Code no.	087H3040
Hardware	B
Software	10.50
Build no.	7475
Serial no.	5335

#### 6.8.2 Extension

ECL Comfort 310 / 310B:  
'Extension' will offer you information about additional modules, if any. An example could be the ECA 32 module.

#### 6.8.3 Ethernet

ECL Comfort 296 / 310 / 310B have a Modbus/TCP communication interface that allows the ECL controller to be connected to an Ethernet network. This allows remote access to the ECL 296 / 310 / 310B controller based on standard communication infrastructures.

In 'Ethernet' it is possible to set up the required IP addresses.

#### 6.8.4 Portal config

ECL Comfort 296 / 310 / 310B have a Modbus/TCP communication interface that allows the ECL controller to be monitored and controlled via the ECL Portal.

ECL Portal related parameters are set here.

Documentation for ECL Portal: See <https://ecl.portal.danfoss.com>

#### 6.8.5 M-bus config

ECL Comfort 296 / 310 / 310B have an M-bus communication interface that allows energy meters to be connected as slaves.

M-bus related parameters are set here.

## Operating Guide ECL Comfort 310, application A361

### 6.8.6 Energy meter and M-bus, general information

#### ECL Comfort 296 / 310 / 310B only

When using the Application Key in the ECL Comfort 296 / 310 / 310B, up to 5 energy meters can be connected to the M-bus connections.

Connection of energy meter can:

- limit the flow
- limit the power
- transfer energy meter data to the ECL Portal, via Ethernet, and / or a SCADA system, via Modbus.

Many applications with control of heating, DHW or cooling circuit have the possibility to react on energy meter data.

To verify if actual application key can be set to react on energy meter data:

See Circuit > MENU > Settings > Flow / power.

The ECL Comfort 296 / 310 / 310B can always be used for monitoring purpose of up to 5 energy meters.

The ECL Comfort 296 / 310 / 310B act as an M-bus master and must be set to communicate with connected energy meter(s).

See MENU > Common controller > System > M-bus config.

#### Technical info:

- The M-bus data are based on standard EN-1434.
- Danfoss recommends AC supplied energy meters in order to avoid battery draining.



Energy meter data acquisition from ECL Portal is possible without setting up the M-bus configuration.

#### MENU > Common controller > System > M-bus config.

State		Read-out	
Circuit	Setting range	Factory setting	
-	-	-	
<i>Information about the current M-bus activity.</i>			



The ECL Comfort 296 / 310 / 310B will return to IDLE when commands have been completed.  
Gateway is used for read-out of energy meter via ECL Portal.

**IDLE:** Normal state

**INIT:** The command for initialization has been activated

**SCAN:** The command for scanning has been activated

**GATEW:** The command Gateway has been activated

#### MENU > Common controller > System > M-bus config.

Baud (bits per second)		5997	
Circuit	Setting range	Factory setting	
-	300 / 600 / 1200 / 2400	300	
<i>The communication speed between ECL Comfort 296 / 310 / 310B and the connected energy meter(s).</i>			



Typically, 300 or 2400 baud is used.  
If ECL Comfort 296 / 310 / 310B are connected to the ECL Portal, a baud rate of 2400 is recommendable, provided the energy meter allows this.

## Operating Guide ECL Comfort 310, application A361

### MENU > Common controller > System > M-bus config.

Command		5998
Circuit	Setting range	Factory setting
-	NONE / INIT / SCAN / GATEW	NONE

*The ECL Comfort 296 / 310 / 310B are M-bus masters. In order to verify connected energy meters, different commands can be activated.*

**NONE:** No command activated

**INIT:** Initialization is activated

**SCAN:** Scanning is activated in order to search for connected energy meters. The ECL Comfort 296 / 310 / 310B detect the M-bus addresses of up to 5 connected energy meters and place these automatically in the "Energy meters" section. The verified address is placed after "Energy meter 1 (2, 3, 4, 5)"

**GATEW:** The ECL Comfort 296 / 310 / 310B act as a gateway between energy meters and ECL Portal. Used only for service.



Scan time can take up to 12 minutes. When all energy meters are found, the command can be changed to INIT or NONE.

### MENU > Common controller > System > M-bus config.

M-bus address		6000
Energy meter 1 (2, 3, 4, 5)		
Circuit	Setting range	Factory setting
-	0 - 255	255

*The set or verified address of energy meter 1 (2, 3, 4, 5).*

**0:** Normally not used

**1 - 250:** Valid M-bus addresses

**251 - 254:** Special functions. Use only M-bus address 254 when one energy meter is connected.

**255:** Not used

### MENU > Common controller > System > M-bus config.

Type		6001
Energy meter 1 (2, 3, 4, 5)		
Circuit	Setting range	Factory setting
-	0 - 4	0

*Selecting data range from the M-bus telegram..*

**0:** Small data set, small units

**1:** Small data set, large units

**2:** Large data set, small units

**3:** Large data set, large units

**4:** Volume and energy data only (example: HydroPort Pulse)



#### Data examples:

**0:** Flow temp., return temp., flow, power, acc. volume, acc. energy.

**3:** Flow temp., return temp., flow, power, acc. volume, acc. energy, tariff 1, tariff 2.

See also the "Instructions, ECL Comfort 210 / 310, communication description" for further details.

See also Appendix for detailed description of "Type".

## Operating Guide ECL Comfort 310, application A361

### MENU > Common controller > System > M-bus config.

Scan time		6002
Energy meter 1 (2, 3, 4, 5)		
Circuit	Setting range	Factory setting
-	1 - 3600 sec	60 sec

Setting the scanning time for acquiring data of connected energy meter(s).



If the energy meter is battery powered, the scan time should be set to a high value to prevent a too fast battery draining. Oppositely, if the flow / power limitation function is used in the ECL Comfort 310, the scan time should be set to a low value in order to have quick limitation.

### MENU > Common controller > System > M-bus config.

ID		Read-out
Energy meter 1 (2, 3, 4, 5)		
Circuit	Setting range	Factory setting
-	-	-

Information about the energy meter's serial no.

### MENU > Common controller > System > Energy meters

Energy meter 1 (2, 3, 4, 5)		Read-out
Circuit	Setting range	Factory setting
-	0 - 4	0

Information from actual energy meter about, for example, ID, temperatures, flow / volume, power / energy. The shown information depends on the settings made in the "M-bus config." menu.

### 6.8.7 Raw input overview

Measured temperatures, input status and voltages are displayed.

In addition, a detection of malfunctions can be chosen for activated temperature inputs.

Monitoring the sensors:

Choose the sensor which measures a temperature, for example the S5. When the dial is pressed, a magnifying glass appears in the selected line. The S5 temperature is now being monitored.

Alarm indication:

Should the connection to the temperature sensor be disconnected, short-circuited or the sensor itself be defective, the alarm function is activated.

In the "Raw input overview" an alarm symbol is shown at the defective temperature sensor in question.

Resetting the alarm:

Choose the sensor (S number) for which you want to clear the alarm. Press the dial. The magnifying glass and alarm symbols disappear.

When the dial is pressed again, the monitoring function is reactivated.



The temperature sensor inputs have a measuring range from -60 ... 150 °C.

If a temperature sensor or its connection breaks, the value indication is " - - ".

If a temperature sensor or its connection is short-circuited, the value indication is " - - - ".

## Operating Guide ECL Comfort 310, application A361

### 6.8.8 Sensor offset (new functionality as from firmware 1.59)

The measured temperature can be offset adjusted in order to compensate for cable resistance or a not-optimum place for the temperature sensor. The adjusted temperature can be seen in "Raw input overview" and "Input overview".

#### Common controller > System > Sensor offset

Sensor 1 . . . (temperature sensor)		
Circuit	Setting range	Factory setting
□□□	*	*
Setting the offset of the measured temperature.		

**Positive offset value:** The temperature value is increased

**Negative offset value:** The temperature value is decreased

### 6.8.9 Display

Backlight (display brightness)		60058
Circuit	Setting range	Factory setting
□□□	0 ... 10	5
Adjust the brightness of the display.		

**0:** Weak backlight.

**10:** Strong backlight.

Contrast (display contrast)		60059
Circuit	Setting range	Factory setting
□□□	0 ... 10	3
Adjust the contrast of the display.		

**0:** Low contrast.

**10:** High contrast.

### 6.8.10 Communication

Modbus addr.		38
Circuit	Setting range	Factory setting
□□□	1 ... 247	1
Set the Modbus address if the controller is part of a Modbus network.		

**1 ... 247:** Assign the Modbus address within the stated setting range.

## Operating Guide ECL Comfort 310, application A361

ECL 485 addr. (master / slave address)		2048
Circuit	Setting range	Factory setting
<input type="checkbox"/> 0	0 ... 15	15
<i>This setting is relevant if more controllers are working in the same ECL Comfort system (connected via the ECL 485 communication bus) and / or Remote Control Units (ECA 30 / 31) are connected.</i>		

- 0:** The controller works as slave.  
The slave receives information about the outdoor temperature (S1), system time, and signal for DHW demand in the master.
- 1 ... 9:** The controller works as slave.  
The slave receives information about the outdoor temperature (S1), system time, and signal for DHW demand in the master. The slave sends information about the desired flow temperature to the master.
- 10 ... 14:** Reserved.
- 15:** The ECL 485 communication bus is active.  
The controller is master. The master sends information about the outdoor temperature (S1) and system time. Connected Remote Control Units (ECA 30 / 31) are powered.

The ECL Comfort controllers can be connected via the ECL 485 communication bus to perform a larger system (the ECL 485 communication bus can connect to max. 16 devices).

Each slave must be configured with its own address (1 ... 9).

However, more slaves can have the address 0 if they only have to receive information about outdoor temperature and system time (listeners).

The total cable length of max. 200 m (all devices incl. the internal ECL 485 communication bus) should not be exceeded.  
Cable lengths of more than 200 m may cause noise sensibility (EMC).

In a system with MASTER / SLAVE controllers, only one MASTER controller with address 15 is allowed.  
  
If by mistake more MASTER controllers are present in an ECL 485 communication bus system, decide which controller is to be MASTER. Change the address in the remaining controllers. However, the system will operate but not be stable with more than one MASTER controller.

In the MASTER controller, the address in 'ECL 485 addr. (master / slave address)'; ID no. 2048, must always be 15.

Service Pin		2150
Circuit	Setting range	Factory setting
<input type="checkbox"/> 0	0 / 1	0
<i>This setting is only used in connection with set-up of Modbus communication.</i>		
<b>Not applicable for the time being and reserved for future use!</b>		

Ext. reset		2151
Circuit	Setting range	Factory setting
<input type="checkbox"/> 0	0 / 1	0
<i>This setting is only used in connection with set-up of Modbus communication.</i>		

- 0:** Reset not activated.
- 1:** Reset.

**6.8.11 Language**

<b>Language</b>		<b>2050</b>
<i>Circuit</i>	<i>Setting range</i>	<i>Factory setting</i>
	English / 'Local'	English
<i>Choose your language.</i>		



Local language is selected during installation. If you want to change to another local language, the application must be reinstalled. However, it is always possible to change between the local language and English.



## Operating Guide ECL Comfort 310, application A361

### 7.0 Miscellaneous

#### 7.1 ECA 30 / 31 setup procedures

ECA 30 (code no. 087H3200) is a remote control unit with built-in room temperature sensor.

ECA 31 (code no. 087H3201) is a remote control unit with built-in room temperature sensor and humidity sensor (relative humidity).

An external room temperature sensor can be connected to both types to substitute the built-in sensor.

An external room temperature sensor will be recognized at ECA 30 / 31 power-up.

Connections: See the section 'Electrical connections'.

Max. two ECA 30 / 31 can be connected to one ECL controller or a system (master-slave) consisting of several ECL controllers connected on the same ECL 485 bus. In the master-slave system only one of the ECL controllers is master. The ECA 30 / 31 can, among others, be set to:

- monitor and set the ECL controller remotely
- measure the room temperature and (ECA 31) humidity
- extend comfort / saving period temporarily

After application upload in the ECL Comfort controller, the remote control unit ECA 30 / 31 will after approx. one minute ask to 'Copy application'.

Confirm this in order to upload the application to the ECA 30 / 31.

#### Menu structure

The menu structure of ECA 30 / 31 is an "ECA MENU" and the ECL menu, copied from the ECL Comfort controller.

The ECA MENU contains:

- ECA settings
- ECA system
- ECA factory

ECA settings: Offset adjustment of the measured room temperature.

Offset adjustment of relative humidity (ECA 31 only).

ECA system: Display, communication, override settings and version info.

ECA factory: Erase of all applications in the ECA 30 / 31, restore to factory settings, reset of ECL address and firmware update.

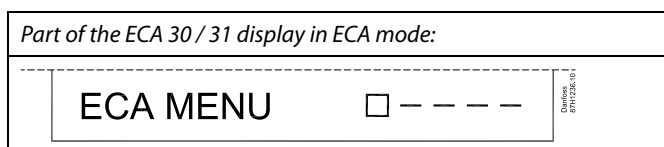
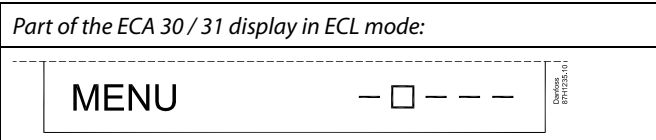

If only the "ECA MENU" is shown, it can indicate that the ECA 30 / 31 is not having correct communication address.  
See ECA MENU > ECA system > ECA communication: ECL address.  
In most cases the ECL address setting must be "15".



Regarding ECA settings:  
When ECA 30 / 31 is not used as remote unit, the offset adjustments menu(s) are not present.

## Operating Guide ECL Comfort 310, application A361

The ECL menus are as described for the ECL controller.

Most of the settings done directly in the ECL controller can be done via the ECA 30 / 31 too.



All settings can be seen even if the application key is not inserted in the ECL controller.  
For changing settings, the application key must be inserted.

The Key overview (MENU > 'Common controller settings' > 'Key functions') does not show the applications of the key.



The ECA 30 / 31 will display this information (an X on the ECA 30 / 31 symbol) if the application in the ECL controller does not comply with the ECA 30 / 31:

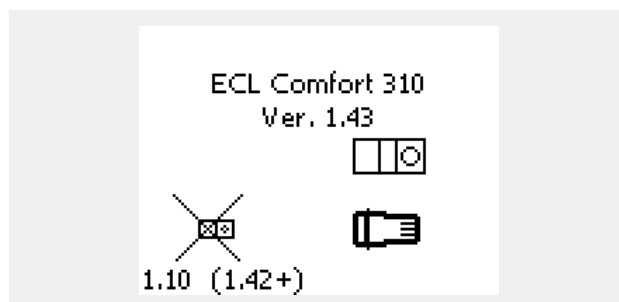

In the example 1.10 is current version and 1.42 is desired version.



Display part of ECA 30 / 31:

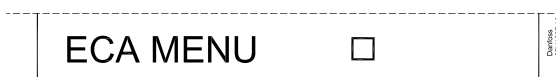

This display indicates that an application has not been uploaded or the communication to the ECL controller (master) is not working properly. An X on the ECL controller symbol indicates wrong setup of communication addresses.



Display part of ECA 30 / 31:



Newer versions of ECA 30 / 31 indicate the address number of the connected ECL Comfort controller.

Address number can be changed in the ECA MENU.

A stand-alone ECL Controller has the address 15.

## Operating Guide ECL Comfort 310, application A361

When ECA 30 / 31 is in ECA MENU mode, the date and measured room temperature is displayed.

### ECA MENU > ECA settings > ECA sensor

Room T Offset	
Setting range	Factory setting
-10.0 ... 10.0 K	0.0 K
<i>The measured room temperature can be corrected with a number of Kelvin. The corrected value is used by the heating circuit in the ECL controller.</i>	

#### Example:

Room T offset:	0.0 K
Displayed room temperature:	21.9 °C
Room T offset:	1.5 K
Displayed room temperature:	23.4 °C

#### Minus

**value:** The indicated room temperature is lower.

**0.0 K:** No correction of the measured room temperature.

**Plus** The indicated room temperature is higher.

#### value:

### ECA MENU > ECA settings > ECA sensor

RH offset (ECA 31 only)	
Setting range	Factory setting
-10.0 ... 10.0 %	0.0 %
<i>The measured relative humidity can be corrected with a number of %-values. The corrected value is used by the application in the ECL controller.</i>	

#### Example:

RH offset:	0.0 %
Displayed relative humidity:	43.4 %
RH offset:	3.5 %
Displayed relative humidity:	46.9 %

#### Minus

**value:** The indicated relative humidity is lower.

**0.0 %:** No correction of the measured relative humidity.

**Plus** The indicated relative humidity is higher.

#### value:

### ECA MENU > ECA system > ECA display

Backlight (display brightness)	
Setting range	Factory setting
0 ... 10	5
<i>Adjust the brightness of the display.</i>	

**0:** Weak backlight.

**10:** Strong backlight.

## Operating Guide ECL Comfort 310, application A361

### ECA MENU > ECA system > ECA display

Contrast (display contrast)	
Setting range	Factory setting
0 ... 10	3
<i>Adjust the contrast of the display.</i>	

**0:** Low contrast.

**10:** High contrast.

### ECA MENU > ECA system > ECA display

Use as remote	
Setting range	Factory setting
OFF / ON	*)
<i>ECA 30 / 31 can act as a simple or normal remote control for the ECL controller.</i>	

**OFF:** Simple remote control, no room temperature signal.

**ON:** Remote control, room temperature signal is available.

**\*):** Differently, depending on chosen application.



When set to OFF: The ECA menu shows date and time.

When set to ON: The ECA menu shows date and room temperature (and for ECA 31 relative humidity).

### ECA MENU > ECA system > ECA communication

Slave addr. (Slave address)	
Setting range	Factory setting
A / B	A
<i>The setting of 'Slave addr.' is related to the setting 'ECA address' in the ECL controller. In the ECL controller it is selected from which ECA 30 / 31 unit the room temperature signal is received.</i>	

**A:** The ECA 30 / 31 has the address A.

**B:** The ECA 30 / 31 has the address B.



For installation of an application in an ECL Comfort 210 / 296 / 310 controller the 'Slave addr.' must be A.



If two ECA 30 / 31 are connected in the same ECL 485 bus system, the 'Slave addr.' must be "A" in the one ECA 30 / 31 unit and "B" in the other.

## Operating Guide ECL Comfort 310, application A361

### ECA MENU > ECA system > ECA communication

Connection addr. (Connection address)	
Setting range	Factory setting
1 ... 9 / 15	15
Setting of the address to which ECL controller the communication must run.	

**1 .. 9:** Slave controllers.

**15:** Master controller.



An ECA 30 / 31 can in an ECL 485 bus system (master – slave) be set to communicate, one by one, with all addressed ECL controllers.



#### Example:

Connection addr. = 15:	The ECA 30 / 31 communicates with the ECL master controller.
Connection addr. = 2:	The ECA 30 / 31 communicates with the ECL controller with address 2.



There must be a master controller present in order to broadcast time and date information.



An ECL Comfort controller 210 / 310, type B (without display and dial) cannot be assigned to the address 0 (zero).

### ECA MENU > ECA system > ECA override

Override addr. (Override address)	
Setting range	Factory setting
OFF / 1 ... 9 / 15	OFF
The feature 'Override' (to extended comfort or saving period or holiday) must be addressed to the ECL controller in question.	

**OFF:** Override not possible.

**1 .. 9:** Address of slave controller for override.

**15:** Address of master controller for override.



Override functions:	Extended saving mode:	
	Extended comfort mode:	
	Holiday away from home:	
	Holiday at home:	



Override by means of settings in ECA 30 / 31 are cancelled if the ECL Comfort controller goes into holiday mode or is changed to another mode than scheduled mode.



The circuit in question for override in the ECL controller must be in scheduled mode.  
See also the parameter 'Override circuit'.

## Operating Guide ECL Comfort 310, application A361

### ECA MENU > ECA system > ECA override

Override circuit	
Setting range	Factory setting
OFF / 1 ... 4	OFF
<i>The feature 'Override' (to extended comfort or saving period or holiday) must be addressed to the heating circuit in question.</i>	

**OFF:** No heating circuit is selected for override.

**1 ... 4:** The heating circuit number in question.



The circuit in question for override in the ECL controller must be in scheduled mode.  
See also the parameter 'Override addr.'.



#### Example 1:

(One ECL controller and one ECA 30 / 31)		
Override of heating circuit 2:	Set 'Connection addr.' to 15	Set 'Override circuit' to 2

#### Example 2:

(Several ECL controllers and one ECA 30 / 31)		
Override of heating circuit 1 in ECL controller with the address 6:	Set 'Connection addr.' to 6	Set 'Override circuit' to 1



Quick guide "ECA 30 / 31 to override mode":

1. Go to ECA MENU
2. Move cursor to "Clock" symbol
3. Select the "Clock" symbol
4. Choose and select one of 4 override functions
5. Below the override symbol: Set hours or date
6. Below hours / date: Set desired room temperature for the override period

### ECA MENU > ECA system > ECA version

ECA version (read-out only), examples	
Code no.	087H3200
Hardware	A
Software	1.42
Build no.	5927
Serial no.	13579
Production week	23.2012



#### ECA 30 / 31:

15	Connection address (master: 15, slaves: 1 - 9)
----	--

The ECA version information is useful in service situations.

## Operating Guide ECL Comfort 310, application A361

### ECA MENU > ECA factory > ECA clear apps.

#### Erase all apps. (Erase all applications)

*Erase all applications which are in the ECA 30 / 31.  
After erasing, the application can be uploaded again.*

**NO:** The erase procedure is not done.

**YES:** The erase procedure is done (await 5 sec.).



After the erase procedure, a pop-up in the display indicates "Copy application". Choose "Yes". Hereafter the application is uploaded from the ECL controller. An upload bar is shown.

### ECA MENU > ECA factory > ECA default

#### Restore factory

*The ECA 30 / 31 is set back to factory settings.*

Affected settings by the restore procedure:

- Room T offset
- RH offset (ECA 31)
- Backlight
- Contrast
- Use as remote
- Slave addr.
- Connection addr.
- Override addr.
- Override circuit
- Override mode
- Override mode end time

**NO:** The restore procedure is not done.

**YES:** The restore procedure is done.

## Operating Guide ECL Comfort 310, application A361

### ECA MENU > ECA factory > Reset ECL addr.

#### Reset ECL addr. (Reset ECL address)

*If none of the connected ECL Comfort controllers has the address 15, the ECA 30 / 31 can set all connected ECL controllers on the ECL 485 bus back to address 15.*

**NO:** The reset procedure is not done.

**YES:** The reset procedure is done (await 10 sec.).



The ECL 485 bus related address of the ECL controller is found:  
MENU > 'Common controller settings' > 'System' > 'Communication' > 'ECL 485 addr:'



The "Reset ECL addr." cannot be activated if one or more of the connected ECL Comfort controllers has the address 15.



In a system with MASTER / SLAVE controllers, only one MASTER controller with address 15 is allowed.

If by mistake more MASTER controllers are present in an ECL 485 communication bus system, decide which controller is to be MASTER. Change the address in the remaining controllers. However, the system will operate but not be stable with more than one MASTER controller.

### ECA MENU > ECA factory > Update firmware

#### Update firmware

*The ECA 30 / 31 can be updated with new firmware (software). The firmware comes with the ECL application key, when the key version is at least 2.xx. If no new firmware is available, a symbol of the application key is displayed with an X.*

**NO:** The updating procedure is not done.

**YES:** The updating procedure is done.



The ECA 30 / 31 automatically verifies if a new firmware is present on the application key in the ECL Comfort controller.  
The ECA 30 / 31 is automatically updated at new application upload in the ECL Comfort controller.

The ECA 30 / 31 is not automatically updated when connected to an ECL Comfort controller with uploaded application. A manual update is always possible.



Quick guide "ECA 30 / 31 to override mode":

1. Go to ECA MENU
2. Move cursor to "Clock" symbol
3. Select the "Clock" symbol
4. Choose and select one of 4 override functions
5. Below the override symbol: Set hours or date
6. Below hours / date: Set desired room temperature for the override period



## Operating Guide ECL Comfort 310, application A361

### 7.2 Override function

The ECL 210 / 296 / 310 controllers can receive a signal in order to override the existing schedule. The override signal can be a switch or a relay contact.

Different override modes can be selected, depending on application key type.

Override modes: Comfort, Saving, Constant temperature and Frost protection.

"Comfort" is also called normal heating temperature.

"Saving" can be reduced heating or heating stopped.

"Constant temperature" is a desired flow temperature, set in the menu "Flow temperature".

"Frost protection" stops the heating totally.

Override by means of override switch or relay contact is possible when the ECL 210 / 296 / 310 is in scheduled mode (clock).

Example, override switch connected to S8:

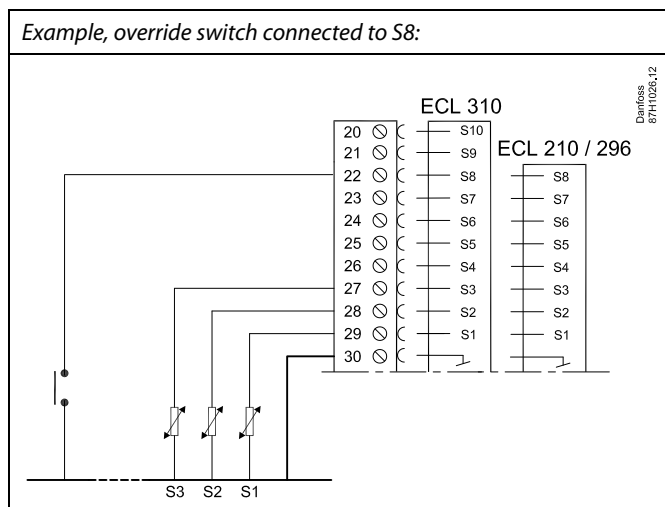

Example, override relay connected to S8:

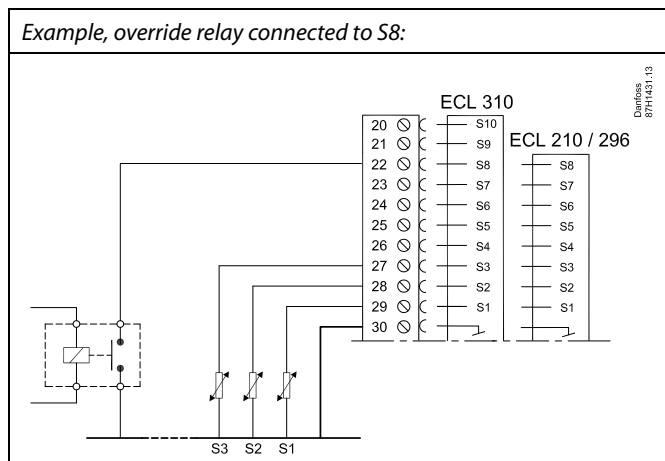

## Operating Guide ECL Comfort 310, application A361

### Example 1

ECL in Saving mode, but in Comfort mode at override.

Choose an unused input, for example S8. Connect the override switch or override relay contact.

Settings in ECL:

1. Select circuit > MENU > Settings > Application > Ext. input:  
Select the input S8 (the wiring example)
2. Select circuit > MENU > Settings > Application > Ext. mode:  
Select COMFORT
3. Select circuit > MENU > Schedule:  
Select all weekdays  
Set "Start1" to 24.00 (this disables Comfort mode)  
Exit menu and confirm by "Save"
4. Remember to set the circuit in question in scheduled mode ("clock").

Result: When the override switch (or the relay contact) is ON, the ECL 210 / 296 / 310 will operate in Comfort mode.

When the override switch (or the relay contact) is OFF, the ECL 210 / 296 / 310 will operate in Saving mode.

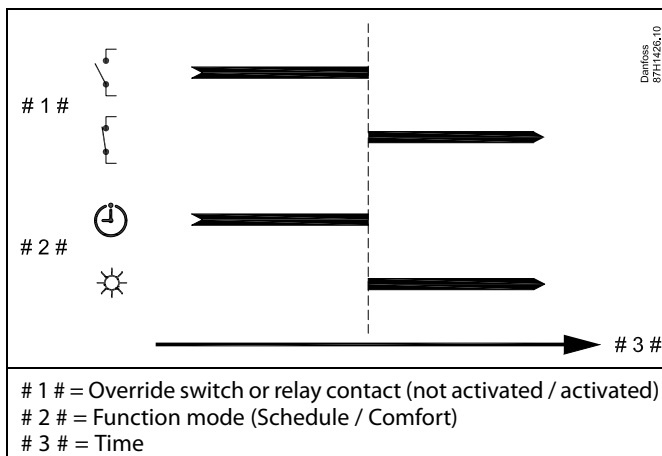

### Example 2

ECL in Comfort mode, but in Saving mode at override.

Choose an unused input, for example S8. Connect the override switch or override relay contact.

Settings in ECL:

1. Select circuit > MENU > Settings > Application > Ext. input:  
Select the input S8 (the wiring example)
2. Select circuit > MENU > Settings > Application > Ext. mode:  
Select SAVING
3. Select circuit > MENU > Schedule:  
Select all weekdays  
Set "Start1" to 00.00  
Set "Stop1" to 24.00  
Exit menu and confirm by "Save"
4. Remember to set the circuit in question in scheduled mode ("clock").

Result: When the override switch (or the relay contact) is ON, the ECL 210 / 296 / 310 will operate in Saving mode.

When the override switch (or the relay contact) is OFF, the ECL 210 / 296 / 310 will operate in Comfort mode.

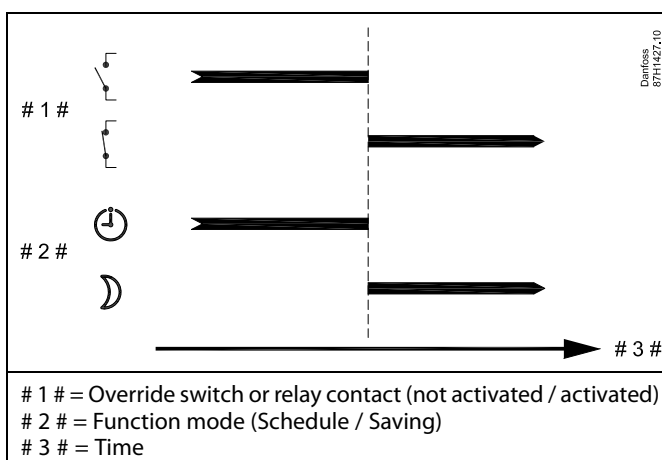

## Operating Guide ECL Comfort 310, application A361

### Example 3

The week schedule for the building is set with comfort periods Monday - Friday: 07.00 - 17.30. Sometimes, a team meeting takes place in the evening or in the week-end.

An override switch is installed and heating must be ON (Comfort mode) as long as the switch is ON.

Choose an unused input, for example S8. Connect the override switch.

Settings in ECL:

1. Select circuit > MENU > Settings > Application > Ext. input:  
Select the input S8 (the wiring example)
2. Select circuit > MENU > Settings > Application > Ext. mode:  
Select COMFORT
3. Remember to set the circuit in question in scheduled mode ("clock").

Result: When the override switch (or a relay contact) is ON, the ECL 210 / 296 / 310 will operate in Comfort mode.

When the override switch is OFF, the ECL 210 / 296 / 310 will operate according to the schedule.

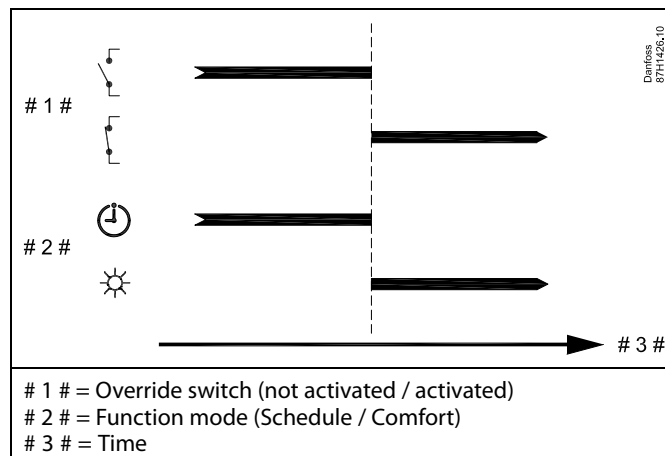

### Example 4

The week schedule for the building is set with comfort periods all weekdays: 06.00 - 20.00. Sometimes, the desired flow temperature must be constant on 65 °C.

An override relay is installed and the flow temperature must be 65 °C as long as the override relay is activated.

Choose an unused input, for example S8. Connect the contacts of the override relay.

Settings in ECL:

1. Select circuit > MENU > Settings > Application > Ext. input:  
Select the input S8 (the wiring example)
2. Select circuit > MENU > Settings > Application > Ext. mode:  
Select CONST. T
3. Select circuit > MENU > Settings > Flow temperature >  
Desired T (ID 1x004):  
Set to 65 °C
4. Remember to set the circuit in question in scheduled mode ("clock").

Result: When the override relay is activated, the ECL 210 / 296 / 310 will operate in Const. temp. mode and control a flow temperature of 65 °C.

When the override relay is not activated, the ECL 210 / 296 / 310 will operate according to the schedule.

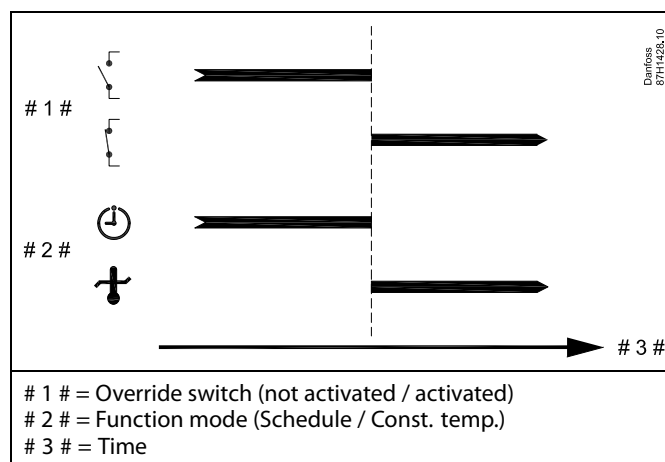

## Operating Guide ECL Comfort 310, application A361

### 7.3 Several controllers in the same system

When ECL Comfort controllers are interconnected by means of the ECL 485 communication bus (cable type: 2 x twisted pair), the master controller will broadcast the following signals to the slave controllers:

- Outdoor temperature (measured by S1)
- Time and date
- DHW tank heating / charging activity

Furthermore, the master controller can receive information about:

- the desired flow temperature (demand) from slave controllers
- and (as from ECL controller version 1.48) DHW tank heating / charging activity in slave controllers

Situation 1:

#### SLAVE controllers: How to make use of the outdoor temperature signal sent from the MASTER controller

The slave controllers only receive information about outdoor temperature and date / time.

SLAVE controllers:

Change the factory set address from 15 to address 0.

- In   , go to System > Communication > ECL 485 addr.

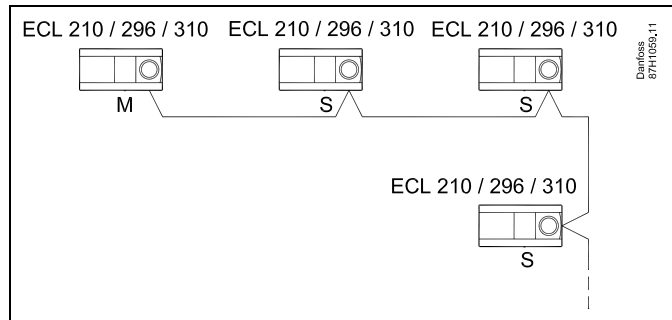

#### ECL 485 bus cable

Maximum recommended length of the ECL 485 bus is calculated like this:

Subtract "Total length of all input cables of all ECL controllers in the master - slave system" from 200 m.

Simple example for total length of all input cables, 3 x ECL:

1 x ECL	Outdoor temp. sensor:	15 m
3 x ECL	Flow temp. sensor:	18 m
3 x ECL	Return temp. sensor:	18 m
3 x ECL	Room temp. sensor:	30 m
Total:		81 m

Maximum recommended length of the ECL 485 bus:

$$200 - 81 \text{ m} = 119 \text{ m}$$



In a system with MASTER / SLAVE controllers, only one MASTER controller with address 15 is allowed.

If by mistake more MASTER controllers are present in an ECL 485 communication bus system, decide which controller is to be MASTER. Change the address in the remaining controllers. However, the system will operate but not be stable with more than one MASTER controller.



In the MASTER controller, the address in 'ECL 485 addr. (master / slave address)', ID no. 2048, must always be 15.

Navigation:

- In   , go to System > Communication > ECL 485 addr.

SLAVE controllers must be set to another address than 15:

Navigation:

- In   , go to System > Communication > ECL 485 addr.



'Demand offset' with a value is to be used in the Master controller only.

ECL 485 addr. (master / slave address)		2048
Circuit	Setting range	Choose
<input type="text"/> <input type="text"/> <input type="text"/>	0 ... 15	0

## Operating Guide ECL Comfort 310, application A361

Situation 2:

### **SLAVE controller: How to react on a DHW tank heating / charging activity sent from the MASTER controller**

The slave receives information about a DHW tank heating / charging activity in the master controller and can be set to close the selected heating circuit.

ECL controller versions 1.48 (as from August 2013):

The master receives information about DHW tank heating / charging activity in the master controller itself and also slaves in the system.

This status is broadcasted to all ECL controllers in the system and each heating circuit can be set to close the heating.

SLAVE controller:

Set the desired function:

- In circuit 1 / circuit 2, go to 'Settings' > 'Application' > 'DHW priority':

<b>DHW priority (closed valve / normal operation)</b>		<b>11052 / 12052</b>
Circuit	Setting range	<b>Choose</b>
1 / 2	OFF / ON	<b>OFF / ON</b>

**OFF:** The flow temperature control remains unchanged during active DHW heating / charging in the master / slave system.

**ON:** The valve in the heating circuit is closed during active DHW heating / charging in the master / slave system.

## Operating Guide ECL Comfort 310, application A361

Situation 3:

### SLAVE controller: How to make use of the outdoor temperature signal and send information about the desired flow temperature back to the MASTER controller

The slave controller receives information about outdoor temperature and date / time. The master controller receives information about the desired flow temperature from slave controllers with an address from 1 ... 9:

SLAVE controller:

- In , go to System > Communication > ECL 485 addr.
- Change the factory set address from 15 to an address (1 ... 9). Each slave must be configured with its own address.

ECL 485 addr. (master / slave address)		2048
Circuit	Setting range	Choose
<input type="checkbox"/>	0 ... 15	1 ... 9

Furthermore, each slave can send information about the desired flow temperature (demand) in each circuit back to the master controller.

SLAVE controller:

- In the circuit in question, go to Settings > Application > Send desired T
- Choose ON or OFF.

Send desired T		11500 / 12500
Circuit	Setting range	Choose
1 / 2	OFF / ON	ON or OFF

**OFF:** Information about the desired flow temperature is not sent to the master controller.

**ON:** Information about the desired flow temperature is sent to the master controller.



In the MASTER controller, the address in 'ECL 485 addr. (master / slave address)', ID no. 2048, must always be 15.

## Operating Guide ECL Comfort 310, application A361

### 7.4 Frequently asked questions



The definitions apply to the ECL Comfort 210 / 296 / 310 series. Consequently, you might come across expressions that are not mentioned in your guide.

#### **Circulation pump (heating) does not stop as expected**

It is in operation at frost protection (outdoor temperature lower than "P frost T" value) and at heat demand (desired flow temperature higher than "P heat T" value)

#### **The time shown in the display is one hour off?**

See 'Time and Date'.

#### **The time shown in the display is not correct?**

The internal clock may have been reset, if there has been a power break for more than 72 hours.

Go to the 'Common controller settings' and 'Time & Date' to set the correct time.

#### **The ECL Application Key is lost?**

Switch the power off and on again to see the ECL controller type, version code (e.g. 1.52), code no. and application (e.g. A266.1) or go to 'Common controller settings' > 'Key functions' > 'Application'. The system type (e.g. TYPE A266.1) and the system diagram is displayed.

Order a replacement from your Danfoss representative (e.g. ECL Application Key A266).

Insert the new ECL Application Key and copy your personal settings from the controller to the new ECL Application Key, if required.

#### **The room temperature is too low?**

Make sure that the radiator thermostat does not limit the room temperature.

If you still cannot obtain the desired room temperature by adjusting the radiator thermostats, the flow temperature is too low. Increase the desired room temperature (display with desired room temperature). If this does not help, adjust the 'Heat curve' ('Flow temp').

#### **The room temperature is too high during saving periods?**

Make sure that the min. flow temperature limitation ('Temp. min.') is not too high.

#### **The temperature is unstable?**

Check that the flow temperature sensor is correctly connected and in the right place. Adjust the control parameters ('Control par').

If the controller has a room temperature signal, see 'Room limit'.

#### **The controller does not operate and the control valve is closed?**

Check that the flow temperature sensor is measuring the correct value, see 'Daily use' or 'Input overview'.

Check the influence from other measured temperatures.

#### **How to make an extra comfort period in the schedule?**

You can set an additional comfort period by adding new 'Start' and 'Stop' times in 'Schedule'.

#### **How to remove a comfort period in the schedule?**

You can remove a comfort period by setting start and stop times to the same value.

#### **How to restore your personal settings?**

Please read the chapter concerning 'Inserting the ECL Application Key'.

## Operating Guide ECL Comfort 310, application A361

---

### **How to restore the factory settings?**

Please read the chapter concerning 'Inserting the ECL Application Key'.

### **Why can't the settings be changed?**

The ECL Application Key has been removed.

### **Why can't an application be selected when inserting the ECL application key into the controller?**

The actual application in the ECL Comfort controller must be deleted before a new application (subtype) can be selected.

### **How to react on alarms?**

An alarm indicates that the system is not operating satisfactorily. Please contact your installer.

### **What does P and PI control mean?**

P control: Proportional control.

By using a P control, the controller will change the flow temperature proportional to the difference between a desired and an actual temperature, e.g. a room temperature.

A P control will always have an offset which not will disappear over time.

PI control: Proportional and Integrating control.

A PI control does the same as a P control, but the offset will disappear over time.

A long 'Tn' will give a slow but stable control, and a short 'Tn' will result in a fast control but with a higher risk of instability.

### **What does the "i" in the upper right corner of the display mean?**

When uploading an application (subtype) from the application key into the ECL Comfort controller, the "i" in the upper right corner indicates that - besides the factory settings - the subtype also contains special user / systems settings.

### **Why can't the ECL 485 Bus (used in ECL 210 / 296 / 310) and the ECL Bus (used in ECL 100 / 110 / 200 / 300) communicate?**

These two communication busses (Danfoss proprietary) are different in connection form, telegram form and speed.

### **Why can't I select a language when uploading an application?**

Reason can be that the ECL 310 is powered with 24 Volt d.c.

## **Language**

At application upload, a language must be selected.\*

If another language than English is selected, the selected language

**AND** English will be uploaded into the ECL controller.

This makes service easy for English speaking service people, just because the English language menus can be visible by changing the actual set language into English.

(Navigation: MENU > Common controller > System > Language)

If the uploaded language is not suitable, the application must be erased. User and System settings can be saved on the application key before erasing.

After new upload with preferred language, the existing User and System settings can be uploaded.

\*)

(ECL Comfort 310, 24 Volt) If language cannot be selected, the power supply is not a.c. (alternating current).



## Operating Guide ECL Comfort 310, application A361

### How to set a correct heat curve?

#### Short answer:

Set the heat curve to the lowest possible value, but still having comfortable room temperature.

The table shows some recommendations:

House with radiators:	Needed flow temp. when the outdoor temp. is -10 °C:	Recommended heat curve value:
Older than 20 years:	65 °C	1.4
Between 10 and 20 years old:	60 °C	1.2
Rather new:	50 °C	0.8
Floor heating systems need, in general, a lower heat curve value		

#### Technical answer:

In order to save energy, the flow temperature should be as low as possible, but still considering a comfortable room temperature. This means the heat curve slope should have a low value.

See the heat curve slope diagram.

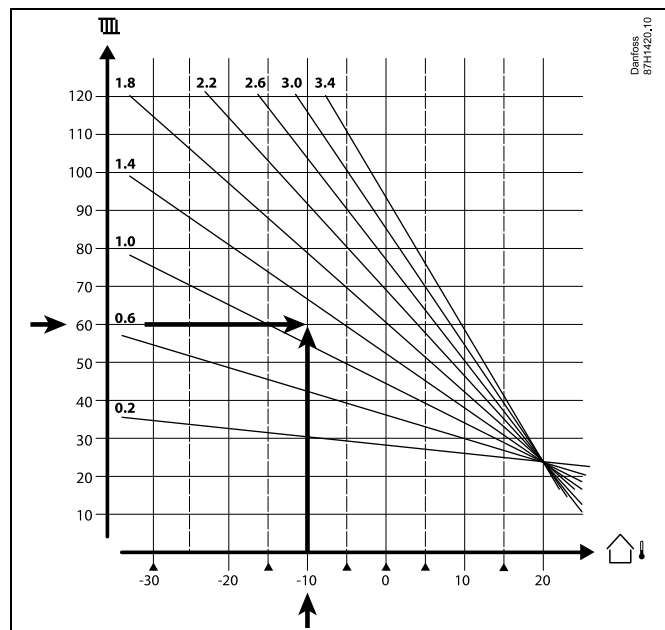

Choose the desired flow temperature (vertical axis) for your heating system at the expected lowest outdoor temperature (horizontal axis) for your area. Pick the heat curve closest to the common point of these two values.

Example: Desired flow temperature: 60 °C at outdoor temperature: -10 °C  
Result: Heat curve slope value = 1.2 (mid-way between 1.4 and 1.0).

#### In general:

- Smaller radiators in your heating system might require a higher heat curve slope. (Example: Desired flow temperature 70 °C resulting in heat curve = 1.5).
- Floor heating systems require a lower heat curve slope. (Example: Desired flow temperature 35 °C resulting in heat curve = 0.4).
- Corrections of the heat curve slope should be done in small steps when having outdoor temperatures below 0 °C; one step pr. day.
- If required, adjust the heat curve in the six coordinate points.
- Setting of the desired **room** temperature has an influence on the desired flow temperature even if a room temperature sensor / Remote Control Unit is not connected. An example: Increasing the desired **room** temperature results in a higher flow temperature.
- Typically, the desired **room** temperature should be adjusted when having outdoor temperatures above 0 °C.

### 7.5 Definitions



The definitions apply to the ECL Comfort 210 / 296 / 310 series. Consequently, you might come across expressions that are not mentioned in your guide.

#### **Accumulated temperature value**

A filtered (dampened) value, typically for room and outdoor temperatures. Is calculated in the ECL controller and is used to express the heat stored in the walls of the house. The accumulated value does not change so rapidly as the actual temperature.

#### **Air duct temperature**

Temperature measured in the air duct where the temperature is to be controlled.

#### **Alarm function**

Based on the alarm settings, the controller can activate an output.

#### **Anti-bacteria function**

For a defined period, the DHW temperature is increased in order to neutralize dangerous bacteria, e.g. Legionella.

#### **Balance temperature**

This setpoint is the basis for the flow / air duct temperature. The balance temperature can be adjusted by the room temperature, the compensation temperature and the return temperature. The balance temperature is only active if a room temperature sensor is connected.

#### **BMS**

Building Management System. A supervisory system for remote control and monitoring.

#### **Comfort operation**

Normal temperature in the system controlled by the schedule. During heating the flow temperature in the system is higher to maintain the desired room temperature. During cooling the flow temperature in the system is lower to maintain the desired room temperature.

#### **Comfort temperature**

Temperature maintained in the circuits during comfort periods. Normally during daytime.

#### **Compensation temperature**

A measured temperature influencing the flow temperature reference / balance temperature.

#### **Desired flow temperature**

Temperature calculated by the controller on basis of the outdoor temperature and influences from the room and / or return temperatures. This temperature is used as a reference for the control.

#### **Desired room temperature**

Temperature which is set as the desired room temperature. The temperature can only be controlled by the ECL Comfort controller if a room temperature sensor is installed.

If a sensor is not installed, the set desired room temperature however still influences the flow temperature.

In both cases the room temperature in each room is typically controlled by radiator thermostats / valves.

#### **Desired temperature**

Temperature based on a setting or a controller calculation.

#### **Dew point temperature**

Temperature at which the humidity in the air condensates.

## Operating Guide ECL Comfort 310, application A361

---

### **DHW circuit**

The circuit for heating the domestic hot water (DHW).

### **Duct temperature**

Temperature measured in the air duct where the temperature is to be controlled.

### **ECL 485 Bus**

This communication bus is Danfoss proprietary and used for internal communication between ECL 210, ECL 210B, ECL 296, ECL 310, ECL 310B, ECA 30 and ECA 31.

Communication with "ECL Bus", used in ECL 100, ECL 110, ECL 200, ECL 300 and ECL 301, is not possible.

### **ECL Portal**

A supervisory system for remote control and monitoring, locally and via Internet.

### **EMS**

Energy Management System. A supervisory system for remote control and monitoring.

### **Factory settings**

Settings stored on the ECL Application Key to simplify the set up of your controller the first time.

### **Firmware**

is used by the ECL Comfort controller and ECA 30 / 31 to manage display, dial and program execution.

### **Flow temperature**

Temperature measured in the water flow where the temperature is to be controlled.

### **Flow temperature reference**

Temperature calculated by the controller on basis of the outdoor temperature and influences from the room and / or return temperatures. This temperature is used as a reference for the control.

### **Heat curve**

A curve showing the relationship between actual outdoor temperature and desired flow temperature.

### **Heating circuit**

The circuit for heating the room / building.

### **Holiday schedule**

Selected days can be programmed to be in comfort, saving or frost protection mode. Besides this, a day schedule with comfort period from 07.00 to 23.00 can be selected.

### **Humidistat**

A device, which reacts on the air's humidity. A switch can go ON if the measured humidity gets above a set point.

### **Humidity, relative**

This value (stated in %) refers to the indoor moisture content compared to the max. moisture content. The relative humidity is measured by the ECA 31 and is used for the calculation of the dew point temperature.

### **Inlet temperature**

Temperature measured in the inlet air flow where the temperature is to be controlled.

### **Limitation temperature**

Temperature that influences the desired flow / balance temperature.

### **Log function**

The temperature history is displayed.

### **Master / slave**

Two or more controllers are interconnected on the same bus, the master sends out e.g. time, date and outdoor temperature. The slave receives data from master and sends e.g. desired flow temperature value.

## Operating Guide ECL Comfort 310, application A361

---

### **Modulating control (0 - 10 V control)**

Positioning (by means of a 0 - 10 V control signal) of the actuator for the motorized control valve in order to control the flow.

### **Optimization**

The controller optimizes the start time of the scheduled temperature periods. Based on the outdoor temperature, the controller automatically calculates when to start in order to reach the comfort temperature at the set time. The lower the outdoor temperature, the earlier the start time.

### **Outdoor temperature trend**

The arrow indicates the tendency, i.e. whether the temperature rises or falls.

### **Override mode**

When ECL Comfort is in Scheduled mode, a switch or contact signal can be applied to an input in order to override to Comfort, Saving, Frost protection or Constant temperature. As long as the switch or contact signal is applied, the override is active.

### **Pt 1000 sensor**

All sensors used with the ECL Comfort controller are based on the Pt 1000 type (IEC 751B). The resistance is 1000 ohm at 0 °C and it changes with 3.9 ohm / degree.

### **Pump control**

One circulation pump is working and the other is the spare circulation pump. After a set time, the roles are exchanged.

### **Refill water function**

If the measured pressure in the heating system is too low (e.g. due to a leakage), water can be supplemented.

### **Return temperature**

The temperature measured in the return influences the desired flow temperature.

### **Room temperature**

Temperature measured by the room temperature sensor or the Remote Control Unit. The room temperature can only be controlled directly if a sensor is installed. The room temperature influences the desired flow temperature.

### **Room temperature sensor**

Temperature sensor placed in the room (reference room, typically the living room) where the temperature is to be controlled.

### **Saving temperature**

Temperature maintained in the heating / DHW circuit during saving temperature periods. Typically, the Saving temperature is lower than the Comfort temperature in order to save energy.

### **SCADA**

Supervisory Control And Data Acquisition. A supervisory system for remote control and monitoring.

### **Schedule**

Schedule for periods with comfort and saving temperatures. The schedule can be made individually for each week day and may consist of up to 3 comfort periods per day.

### **Software**

is used in the ECL Comfort controller to do the application related processes.

### **Weather compensation**

Flow temperature control based on the outdoor temperature. The control is related to a user-defined heat curve.

## Operating Guide ECL Comfort 310, application A361

---

### **2-point control**

ON / OFF control, e.g. circulation pump, ON / OFF valve, change-over valve or damper control.

### **3-point control**

Actuator positioning by means of Opening, Closing or No-action signals for the motorized control valve in order to control the flow. No-action means that the actuator remains in its current position.

## Operating Guide ECL Comfort 310, application A361

### 7.6 Type (ID 6001), overview

	Type 0	Type 1	Type 2	Type 3	Type 4
<b>Address</b>	✓	✓	✓	✓	✓
<b>Type</b>	✓	✓	✓	✓	✓
<b>Scan time</b>	✓	✓	✓	✓	✓
<b>ID / Serial</b>	✓	✓	✓	✓	✓
<b>Reserved</b>	✓	✓	✓	✓	✓
<b>Flow temp. [0.01 °C]</b>	✓	✓	✓	✓	-
<b>Return temp. [0.01 °C]</b>	✓	✓	✓	✓	-
<b>Flow [0.1 l/h]</b>	✓	✓	✓	✓	-
<b>Power [0.1 kW]</b>	✓	✓	✓	✓	-
<b>Acc. Volume</b>	[0.1 m3]	[0.1 m3]	[0.1 m3]	[0.1 m3]	-
<b>Acc. Energy</b>	[0.1 kWh]	[0.1 MWh]	[0.1 kWh]	[0.1 MWh]	-
<b>Tariff1 Acc. Energy</b>	-	-	[0.1 kWh]	[0.1 MWh]	-
<b>Tariff2 Acc. Energy</b>	-	-	[0.1 kWh]	[0.1 MWh]	-
<b>Up time [days]</b>	-	-	✓	✓	-
<b>Current time [M-bus defined structure]</b>	-	-	✓	✓	✓
<b>Error status [energy meter defined bitmask]</b>	-	-	✓	✓	-
<b>Acc. Volume</b>	-	-	-	-	[0.1 m3]
<b>Acc. Energy</b>	-	-	-	-	[0.1 kWh]
<b>Acc. Volume2</b>	-	-	-	-	[0.1 m3]
<b>Acc. Energy2</b>	-	-	-	-	[0.1 kWh]
<b>Acc. Volume3</b>	-	-	-	-	[0.1 m3]
<b>Acc. Energy3</b>	-	-	-	-	[0.1 kWh]
<b>Acc. Volume4</b>	-	-	-	-	[0.1 m3]
<b>Acc. Energy4</b>	-	-	-	-	[0.1 kWh]
<b>Flow MAX</b>	[0.1 l/h]	[0.1 l/h]	[0.1 l/h]	[0.1 l/h]	-
<b>Power MAX</b>	[0.1 kW]	[0.1 kW]	[0.1 kW]	[0.1 kW]	-
<b>Max T forward</b>	✓	✓	✓	✓	-
<b>Max T return</b>	✓	✓	✓	✓	-
<b>Storage * Acc. Energy</b>	[0.1 kWh]	[0.1 kWh]	[0.1 kWh]	[0.1 kWh]	-

## Operating Guide ECL Comfort 310, application A361

---

### 7.7 Automatic / manual update of firmware

#### Info:

- Firmware and application software are on the application key
- ECL Comfort has firmware implemented
- Firmware with Encryption has version 2.00 and up

#### Situation 1:

ECL Comfort controller, new (= no application installed), from before 10<sup>th</sup> of July 2018, to be installed:

1. Insert application key.
2. If the firmware on application key is newer than the firmware in the ECL, an update will be done automatically.
3. Hereafter the application can be uploaded.
4. If the firmware in the ECL is newer than the firmware on application key, the application can be uploaded.

#### Situation 2:

ECL Comfort controller is installed and runs an application.

1. Store all settings on the existing application key \*.
2. Erase actual application in the ECL \*\*.
3. Insert an application key with new firmware. The firmware update will be done automatically.
4. When ECL requires language selection, then remove application key.
5. Insert "old" application key.
6. Select language, select application subtype and see an "i" in upper right corner.
7. Set time / date if needed.
8. Choose "Next".
9. In Copy menu, choose YES at System and User settings; then choose "Next".
10. "Old" application is uploaded, ECL restarts and is ready again.

\* Navigation: MENU > Common controller settings > Key functions > Copy > "To KEY", System settings = YES, User settings = YES, Start copying: Push dial.  
Within 1 sec the settings are stored on the application key.

\*\* Navigation: MENU > Common controller settings > Key functions > New application > Erase application: Push dial.

NOTE: You might come in a situation where the update will not elapse. This is typically when one or two ECA 30 are connected.

Remedy: Disconnect (remove from its base) the ECA 30. If ECL 310B, then only one ECA 30 should be connected.

## Operating Guide ECL Comfort 310, application A361

### 7.8 Parameter ID overview

A361.x — x refers to the subtypes listed in the column.

ID	Parameter Name	A361.x	Setting range	Factory	Unit	Own settings	
10326	No. of pumps	1, 2	OFF ... 1	1			<a href="#">77</a>
11011	Auto saving	1, 2	OFF, -29 ... 10	-15	°C		<a href="#">61</a>
11012	Boost	1, 2	OFF, 1 ... 99	OFF	%		<a href="#">62</a>
11013	Ramp	1, 2	OFF, 1 ... 99	OFF	Min		<a href="#">63</a>
11014	Optimizer	1, 2	OFF, 10 ... 59	OFF			<a href="#">63</a>
11017	Demand offset	1, 2	OFF, 1 ... 20	OFF	K		<a href="#">79</a>
11021	Total stop	1, 2	OFF ; ON	OFF			<a href="#">64</a>
11022	P exercise	1, 2	OFF, 1 ... 200	OFF	Sec		<a href="#">71</a>
11023	M exercise	1, 2	OFF ; ON	OFF			<a href="#">79</a>
11026	Pre-stop	1, 2	OFF ; ON	ON			<a href="#">65</a>
11031	High T out X1	1, 2	-60 ... 20	15	°C		<a href="#">54</a>
11032	Low limit Y1	1, 2	10 ... 150	40	°C		<a href="#">54</a>
11033	Low T out X2	1, 2	-60 ... 20	-15	°C		<a href="#">54</a>
11034	High limit Y2	1, 2	10 ... 150	60	°C		<a href="#">55</a>
11035	Infl. - max.	1, 2	-9.9 ... 9.9	0.0			<a href="#">55</a>
11036	Infl. - min.	1, 2	-9.9 ... 9.9	0.0			<a href="#">55</a>
11037	Adapt. time	1, 2	OFF, 1 ... 50	25	Sec		<a href="#">55</a>
11052	DHW priority	1, 2	OFF ; ON	OFF			<a href="#">79</a>
11077	P frost T	1, 2	OFF, -10 ... 20	2	°C		<a href="#">80</a>
11078	P heat T	1, 2	5 ... 40	20	°C		<a href="#">80</a>
11085	Priority	1, 2	OFF ; ON	OFF			<a href="#">56</a>
11093	Frost pr. T	1, 2	5 ... 40	10	°C		<a href="#">80</a>
11109	Input type	1, 2	EM1 ; EM2 ; EM3 ; EM4 ; EM5 ; OFF	OFF			<a href="#">58</a>
11112	Adapt. time	1, 2	OFF, 1 ... 50	OFF	Sec		<a href="#">58</a>
11113	Filter constant	1, 2	1 ... 50	10			<a href="#">59</a>
11115	Units	1, 2	ml, l/h ; l, l/h ; ml, m3/h ; l, m3/h ; Wh, kW ; kWh, kW ; kWh, MW ; MWh, MW ; MWh, GW ; GWh, GW	ml, l/h			<a href="#">59</a>
11116	High limit Y2	1, 2	0.0 ... 999.9	999.9			<a href="#">59</a>
11117	Low limit Y1	1, 2	0.0 ... 999.9	999.9			<a href="#">60</a>
11118	Low T out X2	1, 2	-60 ... 20	-15	°C		<a href="#">60</a>
11119	High T out X1	1, 2	-60 ... 20	15	°C		<a href="#">60</a>
11141	Ext. input	1, 2	OFF ; S1 ; S2 ; S3 ; S4 ; S5 ; S6 ; S7 ; S8 ; S9 ; S10	OFF			<a href="#">80</a>
11142	Ext. mode	1, 2	COMFORT ; SAVING	COMFORT			<a href="#">81</a>
11147	Upper difference	1, 2	OFF, 1 ... 30	OFF	K		<a href="#">85</a>
11148	Lower difference	1, 2	OFF, 1 ... 30	OFF	K		<a href="#">85</a>



## Operating Guide ECL Comfort 310, application A361

ID	Parameter Name	A361.x	Setting range	Factory	Unit	Own settings	
11149	Delay	1, 2	1 ... 99	10	Min		<a href="#">85</a>
11150	Lowest temp.	1, 2	10 ... 50	30	°C		<a href="#">86</a>
11174	Motor pr.	1, 2	OFF, 10 ... 59	OFF	Min		<a href="#">68</a>
11177	Temp. min.	1, 2	10 ... 150	10	°C		<a href="#">51</a>
11178	Temp. max.	1	10 ... 150	90	°C		<a href="#">51</a>
11179	Summer, cut-out	1, 2	OFF, 1 ... 50	20	°C		<a href="#">66</a>
11184	Xp	1, 2	5 ... 250	80	K		<a href="#">68</a>
11185	Tn	1, 2	1 ... 999	30	Sec		<a href="#">69</a>
11186	M run	1, 2	5 ... 250	60	Sec		<a href="#">69</a>
11187	Nz	1, 2	1 ... 9	3	K		<a href="#">69</a>
11189	Min. act. time	1, 2	2 ... 50	10			<a href="#">83</a>
11300	High supp. T X2	2	10 ... 150	150	°C		<a href="#">51</a>
11301	High T max Y2	2	10 ... 150	95	°C		<a href="#">51</a>
11302	Low supply T X1	2	10 ... 150	70	°C		<a href="#">51</a>
11303	Low T max Y1	2	10 ... 150	50	°C		<a href="#">52</a>
11310	Retry time	1, 2	OFF, 1 ... 99	20	Min		<a href="#">71</a>
11311	Change, duration	1, 2	1 ... 10	2			<a href="#">71</a>
11312	Change time	1, 2	0 ... 23	12			<a href="#">72</a>
11313	Stab. time	1, 2	1 ... 99	15	Sec		<a href="#">72</a>
11314	Chan.-over time	1, 2	OFF, 1 ... 99	5	Sec		<a href="#">72</a>
11315	Circ. pumps	1, 2	OFF ; ON	OFF			<a href="#">86</a>
11320	P exercise	1, 2	OFF, 1 ... 200	OFF	Sec		<a href="#">75</a>
11321	Pressure, des.	1, 2	0.2 ... 25.0	3.0	Bar		
11322	Pressure, diff.	1, 2	0.1 ... 5.0	1.0	Bar		<a href="#">75</a>
11323	Time-out	1, 2	0 ... 1000	100	Sec		<a href="#">75</a>
11324	Refill water	1, 2	OFF ; ON	OFF			<a href="#">86</a>
11325	Valve delay	1, 2	0 ... 30	1	Sec		<a href="#">76</a>
11327	Input type	1, 2	OFF ; AI ; DI	OFF			<a href="#">77</a>
11609	Low Y	1, 2	0.0 ... 30.0	0.0	Bar		
11610	High Y	1, 2	0.0 ... 30.0	20.0	Bar		
12011	Auto saving	1, 2	OFF, -29 ... 10	-15	°C		<a href="#">61</a>
12012	Boost	1, 2	OFF, 1 ... 99	OFF	%		<a href="#">62</a>
12013	Ramp	1, 2	OFF, 1 ... 99	OFF	Min		<a href="#">63</a>
12014	Optimizer	1, 2	OFF, 10 ... 59	OFF			<a href="#">63</a>
12021	Total stop	1, 2	OFF ; ON	OFF			<a href="#">64</a>
12022	P exercise	1, 2	OFF, 1 ... 200	OFF	Sec		<a href="#">71</a>
12023	M exercise	1, 2	OFF ; ON	OFF			<a href="#">79</a>
12026	Pre-stop	1, 2	OFF ; ON	ON			<a href="#">65</a>
12031	High T out X1	1, 2	-60 ... 20	15	°C		<a href="#">54</a>
12032	Low limit Y1	1, 2	10 ... 150	40	°C		<a href="#">54</a>
12033	Low T out X2	1, 2	-60 ... 20	-15	°C		<a href="#">54</a>

## Operating Guide ECL Comfort 310, application A361

ID	Parameter Name	A361.x	Setting range	Factory	Unit	Own settings	
12034	High limit Y2	1, 2	10 ... 150	60	°C		<a href="#">55</a>
12035	Infl. - max.	1, 2	-9.9 ... 9.9	0.0			<a href="#">55</a>
12036	Infl. - min.	1, 2	-9.9 ... 9.9	0.0			<a href="#">55</a>
12037	Adapt. time	1, 2	OFF, 1 ... 50	25	Sec		<a href="#">55</a>
12052	DHW priority	1, 2	OFF ; ON	OFF			<a href="#">79</a>
12077	P frost T	1, 2	OFF, -10 ... 20	2	°C		<a href="#">80</a>
12078	P heat T	1, 2	5 ... 40	20	°C		<a href="#">80</a>
12085	Priority	1, 2	OFF ; ON	OFF			<a href="#">56</a>
12093	Frost pr. T	1, 2	5 ... 40	10	°C		<a href="#">80</a>
12109	Input type	1, 2	EM1 ; EM2 ; EM3 ; EM4 ; EM5 ; OFF	OFF			<a href="#">58</a>
12112	Adapt. time	1, 2	OFF, 1 ... 50	OFF	Sec		<a href="#">58</a>
12113	Filter constant	1, 2	1 ... 50	10			<a href="#">59</a>
12115	Units	1, 2	ml, l/h ; l, l/h ; ml, m3/h ; l, m3/h ; Wh, kW ; kWh, kW ; kWh, MW ; MWh, MW ; MWh, GW ; GWh, GW	ml, l/h			<a href="#">59</a>
12116	High limit Y2	1, 2	0.0 ... 999.9	999.9			<a href="#">59</a>
12117	Low limit Y1	1, 2	0.0 ... 999.9	999.9			<a href="#">60</a>
12118	Low T out X2	1, 2	-60 ... 20	-15	°C		<a href="#">60</a>
12119	High T out X1	1, 2	-60 ... 20	15	°C		<a href="#">60</a>
12141	Ext. input	1, 2	OFF ; S1 ; S2 ; S3 ; S4 ; S5 ; S6 ; S7 ; S8 ; S9 ; S10	OFF			<a href="#">80</a>
12142	Ext. mode	1, 2	COMFORT ; SAVING	COMFORT			<a href="#">81</a>
12147	Upper difference	1, 2	OFF, 1 ... 30	OFF	K		<a href="#">85</a>
12148	Lower difference	1, 2	OFF, 1 ... 30	OFF	K		<a href="#">85</a>
12149	Delay	1, 2	1 ... 99	10	Min		<a href="#">85</a>
12150	Lowest temp.	1, 2	10 ... 50	30	°C		<a href="#">86</a>
12174	Motor pr.	1, 2	OFF, 10 ... 59	OFF	Min		<a href="#">68</a>
12177	Temp. min.	1, 2	10 ... 150	10	°C		<a href="#">51</a>
12178	Temp. max.	1	10 ... 150	90	°C		<a href="#">51</a>
12179	Summer, cut-out	1, 2	OFF, 1 ... 50	20	°C		<a href="#">66</a>
12184	Xp	1, 2	5 ... 250	80	K		<a href="#">68</a>
12185	Tn	1, 2	1 ... 999	30	Sec		<a href="#">69</a>
12186	M run	1, 2	5 ... 250	60	Sec		<a href="#">69</a>
12187	Nz	1, 2	1 ... 9	3	K		<a href="#">69</a>
12189	Min. act. time	1, 2	2 ... 50	10			<a href="#">83</a>
12300	High supp. T X2	2	10 ... 150	150	°C		<a href="#">51</a>
12301	High T max Y2	2	10 ... 150	95	°C		<a href="#">51</a>
12302	Low supply T X1	2	10 ... 150	70	°C		<a href="#">51</a>
12303	Low T max Y1	2	10 ... 150	50	°C		<a href="#">52</a>

## Operating Guide ECL Comfort 310, application A361

ID	Parameter Name	A361.x	Setting range	Factory	Unit	Own settings	
12310	Retry time	1, 2	OFF, 1 ... 99	20	Min		<a href="#">71</a>
12311	Change, duration	1, 2	1 ... 10	2			<a href="#">71</a>
12312	Change time	1, 2	0 ... 23	12			<a href="#">72</a>
12313	Stab. time	1, 2	1 ... 99	15	Sec		<a href="#">72</a>
12314	Chan.-over time	1, 2	OFF, 1 ... 99	5	Sec		<a href="#">72</a>
12315	Circ. pumps	1, 2	OFF ; ON	OFF			<a href="#">86</a>
12320	P exercise	1, 2	OFF, 1 ... 200	OFF	Sec		<a href="#">75</a>
12321	Pressure, des.	1, 2	0.2 ... 25.0	3.0	Bar		
12322	Pressure, diff.	1, 2	0.1 ... 5.0	1.0	Bar		<a href="#">75</a>
12323	Time-out	1, 2	0 ... 1000	100	Sec		<a href="#">75</a>
12324	Refill water	1, 2	OFF ; ON	OFF			<a href="#">86</a>
12325	Valve delay	1, 2	0 ... 30	1	Sec		<a href="#">76</a>
12327	Input type	1, 2	OFF ; AI ; DI	OFF			<a href="#">77</a>
12609	Low Y	1, 2	0.0 ... 30.0	0.0	Bar		
12610	High Y	1, 2	0.0 ... 30.0	20.0	Bar		

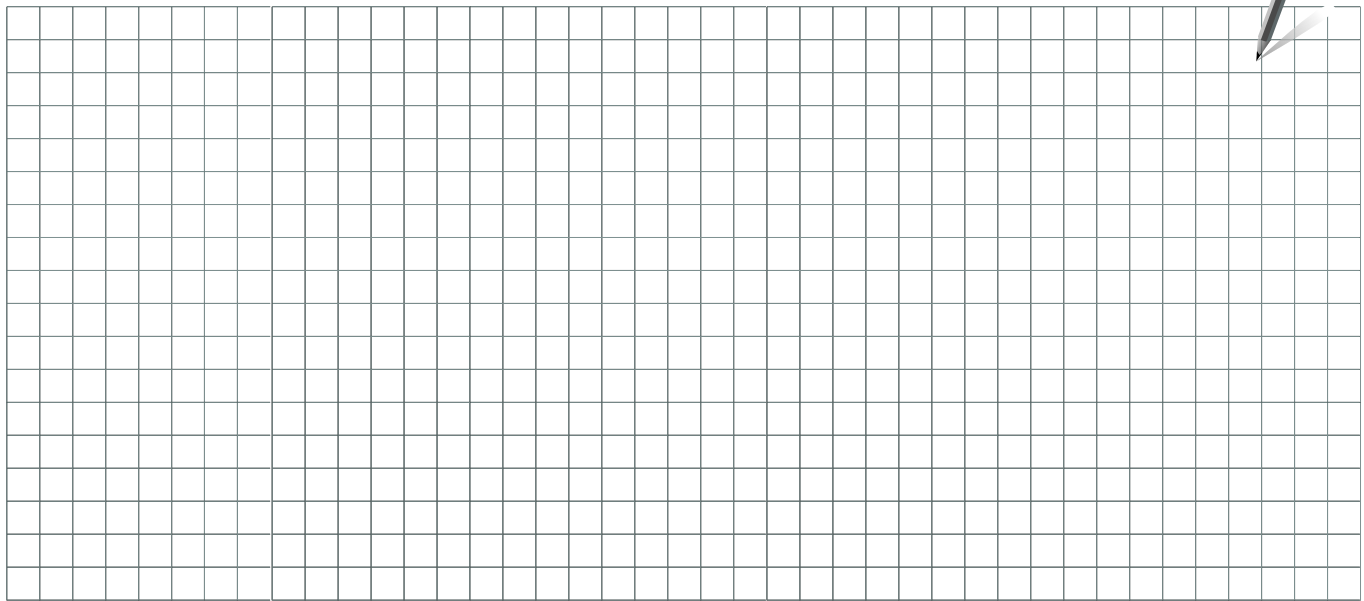

Installer:
By:
Date:

## Operating Guide ECL Comfort 310, application A361

---



### Danfoss A/S

Heating Segment • danfoss.com • +45 7488 2222 • E-Mail: heating@danfoss.com

Danfoss can accept no responsibility for possible errors in catalogues, brochures and other printed material. Danfoss reserves the right to alter its products without notice. This also applies to products already on order provided that such alterations can be made without subsequential changes being necessary in specifications already agreed. All trademarks in this material are property of the respective companies. Danfoss and all Danfoss logotypes are trademarks of Danfoss A/S. All rights reserved.