

Fact Sheet

AK-CC55

Case controller compatibility

Replacing AK-CC 5XX case controller series with a AK-CC55 in an ADAP-KOOL® system



Fact Sheet | AK-CC55 case controller compatibility

Contents

- 1. AK-CC55 Introduction 2
- 2. Product overview and comparison with AK-CC 5xx 3
- 3. AK-CC55 applications 8
- 4. Front-end support and backwards compatibility 8

1. AK-CC55 Introduction

The AK-CC55 is designed to replace AK-CC 4xx / 5xx. The document describes important details to be aware of when replacing an AK-CC 450, 525 and 550, and compatibility with Danfoss System Managers.



AK-CC55 Connect – Mobile Service APP

- Efficient installation and service

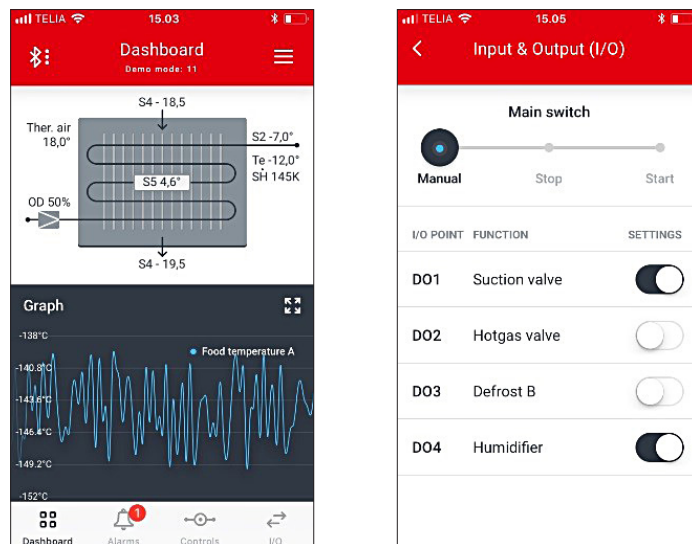

Visible upgrade on displays

- Plastic parts in grey
- White LED light



AK-UI55 Bluetooth

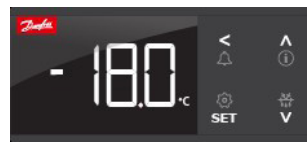

AK-UI55 Set



AK-UI55 Info

A number of new value-adding features have been introduced.

New features:

- 115/230VAC SMPS = **Reduced complexity**
- Bigger Plugs Modbus/Transmitter = **Easy mounting**
- Individual plugs for input/outputs = **Easy service**
- RJ12 connector display connector = **Fast connection**
- Different connector colors = **Less installation faults**
- Connector on option board = **Intuitive installation**



- White LED = **Modern design**
- 4 menu buttons = **Improved user interface**
- Bluetooth display = **Cable free access**



- AK-CC55 Connect app = **Time saving setup/service**
 - 24 hour History log = **Faster root cause analysis**
 - Intuitive Quick Setup = **No need for manual**



2. Product overview and comparison with AK-CC 5xx

AK-CC55 Case controller – Product program

	AK-CC55 Compact	AK-CC55 Single Coil	AK-CC55 Single Coil UI	AK-CC55 Multi Coil
Valve	1 x TEV or AKV	1 x AKV	1 x AKV	3 x AKV
Digital Output (+)	3	5	5	4
Digital Input	1	3 (2)	3 (2)	3 (2)
Analog Output	1	1	1	1
Analog Input	5	6 (7)	6 (7)	6 (7)
Display	1 remote	2 remote	1 remote + 1 Integrated	2 remote
Modbus	Build-in	Build-in	Build-in	Build-in
LON	-	Option	Option	Option
IP (release 2)	-	Option	Option	Option

Cross reference list for AK-CC55 vs AK-CC 4/5xx

	AK-CC55 Compact	AK-CC55 Single Coil	AK-CC55 Single Coil UI
AK-CC 450 (TXV)	(✓) Less I/O's	X	X
AK-CC 550 (2 temp SH (S1))	(X) No S1/s2 Control, Less I/O's	(X) No S1/S2 control	(X) No S1/S2 control
AK-CC 525A	(✓) Less I/O's	✓	✓
AK-CC 550A/(F)	(✓) Less I/O's	(✓) No build in display	✓
AK-CC 550B	X	(✓) 2 remote displays	(✓) 1 remote display

Note: AK-CC55 does not substitute AK-CC 750A.

Fact Sheet | AK-CC55 case controller compatibility

2.1 AK-CC550A vs AK-CC55 Single Coil – application mapping

Main remarks regarding compatibility of AK-CC 550A and AK-CC55 are highlighted in the table. Furthermore important differences are marked with red in the application overviews.

AK-CC 550A	AK-CC55 Single Coil	AK-CC55 remarks
Application: 1,2,3,4	Use application 1,2,3,4	Identical functions (be aware of differences in electrical connections)
Application: 5, 7, 8	Use Application 9	Use custom setup where relay 2 to 6 can be custom defined for 2'nd compressor, blinds, heat etc.
Application 6	Use application 5	A separate output has been defined for Drain valve - use Suction relay also for drain heater.
Application 9	Use application 7	Alarm output included. PWM (0/10 Volt) output and external SSR relay used for smooth control of rail heat. DI1 configured for S5b
Application 10	Use application 6	Two remote displays can be connected via RJ 12 connectors.
NA	Application 8	New application to activate an external humidifier via DO3. DI1 configured for 0 – 10 V input for HR% sensor.

AK-CC 550A

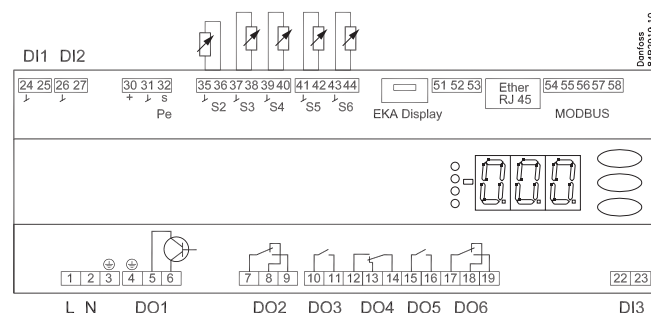

Application	DO1	DO2	DO3	DO4	DO5	DO6	DI1	DI2	DI3	AI1	AI2	AI3	AI4	AI5	AI6
1	Light	Blinds	Heat	Heat	Heat	Light	●	●	●	P0	S2	S3	S4	S5	S6
2	Light	Blinds	Heat	Heat	Heat	Light	●	●	●	P0	S2	S3	S4	S5	S6
3	Light	Blinds	Heat	Heat	Heat	Light	●	●	●	P0	S2	S3	S4	S5	S6
4	Light	Blinds	Heat	Heat	Heat	Light	●	●	●	P0	S2	S3	S4	S5	S6
5	Light	Blinds	Heat	Heat	Heat	Light	●	●	●	P0	S2	S3	S4	S5	S6
6	Light	Suction	Drain	Heatgas	Heat	Light	●	●	●	P0	S2	S3	S4	S5	S6
7	Light	Blinds	Heat	Heat	Heat	Light	●	●	●	P0	S2	S3	S4	S5	S6
8	Light	Blinds	Heat	Heat	Heat	Light	●	●	●	P0	S2	S3	S4	S5	S6
9	Light	Blinds	Heat	Heat	Heat	Light	●	●	●	P0	S2	S3	S4	S5	S5B
10	Light	Blinds	Heat	Heat	Heat	Light	●	●	●	P0	S2	S3	S4	S5	S3B

AK-CC55 Single Coil

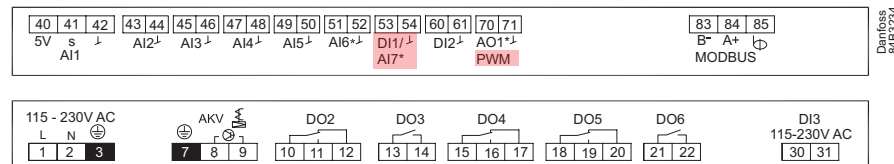

Application	DO1	DO2	DO3	DO4	DO5	DO6	AO1	AI1	AI2	AI3	AI4	AI5	AI6	AI7/DI1	DI2	DI3
1	Light	Blinds	Heat	Heat	Light	Light	●	Pe	S2	S3	S4	S5	S6	●	●	●
2	Light	Blinds	Heat	Heat	Light	Light	●	Pe	S2	S3	S4	S5	S6	●	●	●
3	Light	Blinds	Heat	Heat	Light	Light	●	Pe	S2	S3	S4	S5	S6	●	●	●
4	Light	Blinds	Heat	Heat	Light	Light	●	Pe	S2	S3	S4	S5	S6	●	●	●
5	Light	Suction	Drain	Heatgas	Light	Light	●	Pe	S2	S3	S4	S5	S6	●	●	●
6	Light	Blinds	Heat	Heat	Light	Light	●	Pe	S2	S3	S4	S5	S3B	●	●	●
7	Light	Blinds	Heat	Heat	Light	Light	●	Pe	S2	S3	S4	S5	S3B	S5B	●	●
8	Light	Blinds	Humidity	Heat	Light	Light	●	Pe	S2	S3	S4	S5	S6	RH%	●	●
9	Light	Blinds	Heat	Heat	Light	Light	●	Pe	S2	S3	S4	S5	S6	●	●	●

Fact Sheet | AK-CC55 case controller compatibility

2.2 AK-CC550B vs AK-CC55 Single Coil – Application mapping

Main remarks regarding compatibility of AK-CC 550B and AK-CC55 are highlighted in the table. Furthermore important differences are marked with red in the application overviews.

AK-CC 550B	AK-CC55 Single Coil	AK-CC55 remarks
Application: 1,2,3,4	Use application 1,2,3,4	Identical functions (be aware of differences in electrical connections)
Application: 5, 7, 8	Use Application 9	Use custom setup where relay 2 to 6 can be custom defined for 2nd compressor, blinds, heat etc.
Application 6	Use application 5	A separate output has been defined for Drain valve - use Suction relay also for drain heater.
Application 9	Use application 7	Alarm output included. PWM (0/10 Volt) output and external SSR relay used for smooth control of rail heat. DI1 configured for S5b
Application 10	Use application 6	Two remote displays can be connected via RJ 12 connectors. No S6 sensor.
NA	Application 8	New application to activate an external humidifier via DO3. DI1 configured for 0 – 10 V input for HR% sensor.

AK-CC 550B

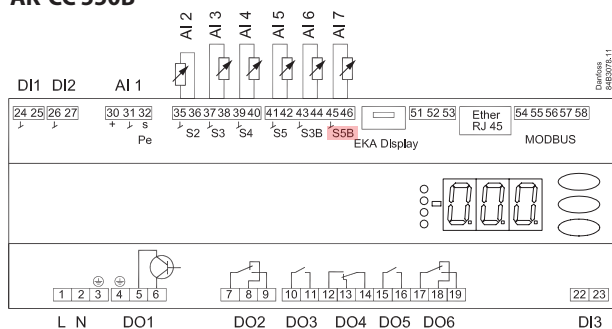

Application	DO1	DO2	DO3	DO4	DO5	DO6	DI1	DI2	DI3	AI1	AI2	AI3	AI4	AI5	AI6	AI7
1																
2																
3																
4																
5																
6																
7																
8																
9																
10																

AK-CC55 Single Coil

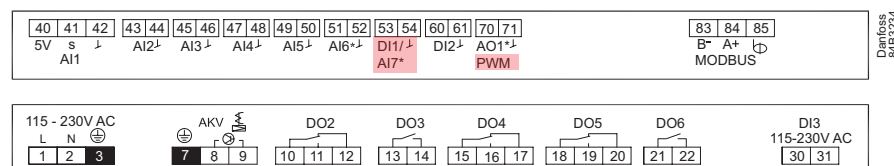

Application	DO1	DO2	DO3	DO4	DO5	DO6	AO1	AI1	AI2	AI3	AI4	AI5	AI6	AI7/DI1	DI2	DI3
1																
2																
3																
4																
5																
6																
7																
8																
9																

Fact Sheet | AK-CC55 case controller compatibility

2.3 Attention when replacing AK-CC 550 with AK-CC55!

Be aware when exchanging an AK-CC550 controller with a new AK-CC55 controller - new wiring principles!

- Pressure sensor has new connection – signal and ground are switched

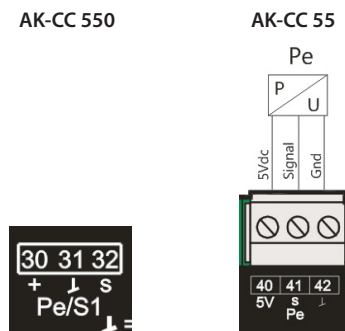

- SPDT relays have a new wiring scheme – NO and NC terminals are switched (e.g. defrost heater on when should be off)

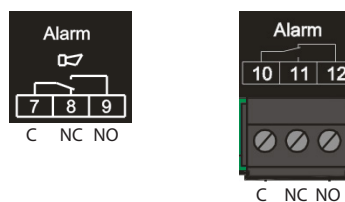

- Modbus has new connection scheme (A,B and screen)

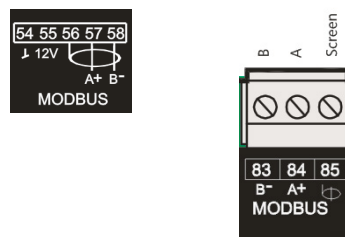

AK-CC55 does not support two EEC coils connected to one AKV output.
 Pressure transmitter can be shared between AK-CC 550 and AK-CC55.
 DI2 defrost coordination can be wired between AK-CC 550 and AK-CC55.
EKA displays and cables can not be used for AK-CC55.

2.4 AK-CC55 Case Controllers

Type	Function	Packing	Qty.	Code no.
AK-CC55 Compact	Case controller with one AKV or solenoid valve	S/M-Pack	10	084B4081
AK-CC55 Single Coil	Case controller with one AKV valve	S/M-Pack	10	084B4082
AK-CC55 Single Coil UI	Case controller with one AKV valve integrated display with control buttons	S/M-Pack	10	084B4083
AK-CC55 Multi Coil	Case controller with one, two or three AKV valves	S/M-Pack	10	084B4084

2.5 AK-CC55 Accessories

User Interface, option board and connection bags.

Type	Function	Packing	Qty.	Code no.
AK-UI55 Bluetooth	Bluetooth Display	S/M-Pack	30	084B4075
AK-UI55 Set	Set Display	S/M-Pack	30	084B4076
AK-UI55 Info	Info Display	S/M-Pack	30	084B4077
AK-OB55 LON	LON Com. Module	S/M-Pack	20	084B4070
Accessory	UI 3 M cable	S/M-Pack	24	084B4078
Accessory	UI 6 M cable	S/M-Pack	24	084B4079

Fact Sheet | AK-CC55 case controller compatibility

3. AK-CC55 Applications

3.1 AK-CC55 Compact – Applications

	TEV applications	DO1 SSR	DO2 SPDT	DO3 SPST	DO4 SPDT	0-10V PWM	AI1	AI2	AI3	AI4	DI1	DI2	Display	Mod bus
1	Standard case MT/LT with alarm							S3	S4	S5	D11	D12		X
2	Standard case MT/LT w. light							S3	S4	S5	D11	D12		X
3	Standard case MT/LT w. railheat							S3	S4	S5	D11	D12		X
4	Flexible case w. 1 evaporator							S3	S4	S5	D11	D12		X

	EEV applications	DO1 SSR	DO2 SPDT	DO3 SPST	DO4 SPDT	0-10V PWM	AI1	AI2	AI3	AI4	AI5	DI1	Display	Mod bus
5	Standard case MT/LT w. comp						Pe	S2	S3	S4	S5	D11		X
6	Standard case MT/LT w. alarm						Pe	S2	S3	S4	S5	D11		X
7	Standard case MT/LT w. light						Pe	S2	S3	S4	S5	D11		X
8	Standard case MT/LT w. railheat						Pe	S2	S3	S4	S5	D11		X
9	Flexible case w. 1 evaporator						Pe	S2	S3	S4	S5	D11		X

Flexible DO options:

- Fan
- Fan Eco
- Defrost
- Rail heat
- Alarm
- Light
- Blinds
- Compressor
- Compressor 2
- Heating element

D11 options:

- Status
- Door function
- Door alarm
- Defrost start
- Main switch
- Night
- Thermostat band
- Alarm at open
- Alarm at closed
- Case cleaning
- Forced cooling
- Night blinds opening
- Forced closing
- Case shutdown
- Light control
- **Leak detection**
- **Adaptive liquid control (ALC)**

AO option:

- 0: Not used
- 1: PWM railheat

3.2 AK-CC55 Single Coil – Applications

	EEV applications	DO1 AKV	DO2 SPDT	DO3 SPST	DO4 SPDT	DO5 SPST	DO6 SPST	0-10V PWM	AI1	AI2	AI3	AI4	AI5	AI6	AI7 DI1	DI2	DI3 230V	Option bus	Display	Mod bus
1	Standard case MT/LT								Pe	S2	S3	S4	S5	S6	D11	D12	D13	X		X
2	Standard case MT/LT								Pe	S2	S3	S4	S5	S6	D11	D12	D13	X		X
3	Standard case MT/LT								Pe	S2	S3	S4	S5	S6	D11	D12	D13	X		X
4	Standard case MT/LT								Pe	S2	S3	S4	S5	S6	D11	D12	D13	X		X
5	Remote case w. hot gas defrost								Pe	S2	S3	S4	S5	S6	D11	D12	D13	X		X
6	Back to back w. 1 evaporator								Pe	S2	S3	S4	S5	S3B	D11	D12	D13	X		X
7	Back to back w. 2 evaporator (1 valve)								Pe	S2	S3	S4	S5	S3B	S5B	D12	D13	X		X
8	Coldroom								Pe	S2	S3	S4	S5	S6	RH%	D12	D13	X		X
9	Flexible case w. 1 evap.								Pe	S2	S3	S4	S5	S6	D11	D12	D13	X		X

Flexible DO options:

- Fan
- Fan Eco
- Defrost
- Rail heat
- Alarm
- Light
- Blinds
- Compressor
- Compressor 2
- Heating element

D11 options:

- Status
- Door function
- Door alarm
- Defrost start
- Main switch
- Night
- Thermostat band
- Alarm at open
- Alarm at closed
- Case cleaning
- Forced cooling
- Night blinds opening
- Co-ordinated defrost
- Forced closing
- Case shutdown
- Light control
- **Leak detection**
- **Adaptive liquid control (ALC)**

AO option:

- 0: Not used
- 1: PWM railheat

Fact Sheet | AK-CC55 case controller compatibility

3.3 AK-CC55 Multi Coil – Applications

EEV applications	DD1 AKV	DD2 SPDT	DD3 SSR	DD4 SPDT	DD5 SPDT	DD6 SPST	DD7 SSR	0-10V PWM	AI1	AI2	AI3	AI4	AI5	AI6	AI7 DI1	DI2	DI3	DI3 230V	Option bus	Display	Mod bus
1 1 x Evaporator LT/MT	A			A					Pe	S2A	S4A	S5A			DI1	DI2	DI3	X	X	X	
2 2 x Evaporator LT/MT	A		B	A			B		Pe	S2A	S4A	S5A	S2B	S4B	S5B	DI2	DI3	X	X	X	
3 3 x Evaporator MT	A		B				C		Pe	S2A	S4A	S2B	S4B	S2C	S4C	DI2	DI3	X	X	X	
4 Coldroom HT 2 evap	A		B Hum				Heat		Pe	S2A	S4A	S2B	S4B	RH%	DI1	DI2	DI3	X	X	X	
5 Coldroom LT 2 evap	A		B	A			B		Pe	S2A	S4A	S5A	S2B	S4B	S5B	DI2	DI3	X	X	X	

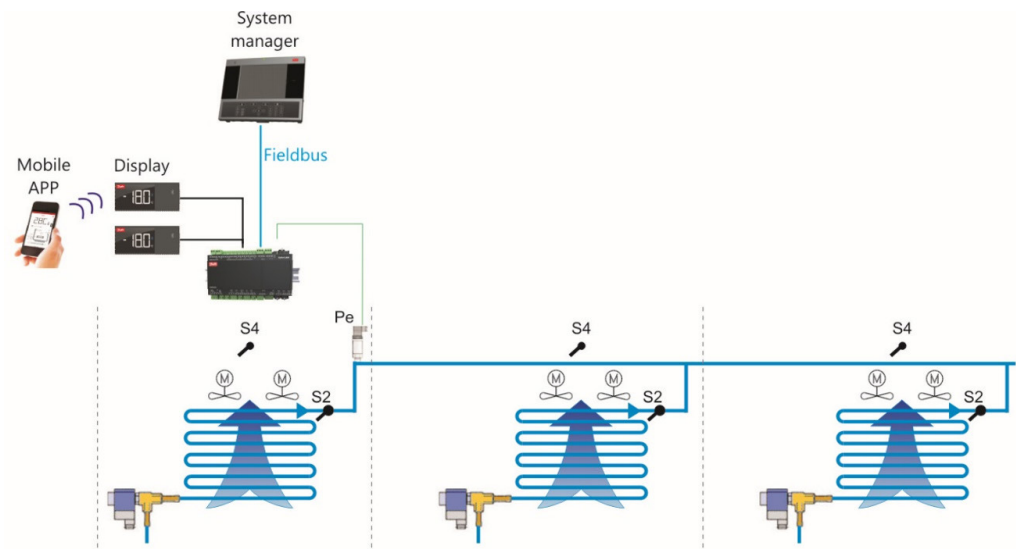

4. Front-end support and backwards compatibility

4.1 AK-CC55 Connectivity

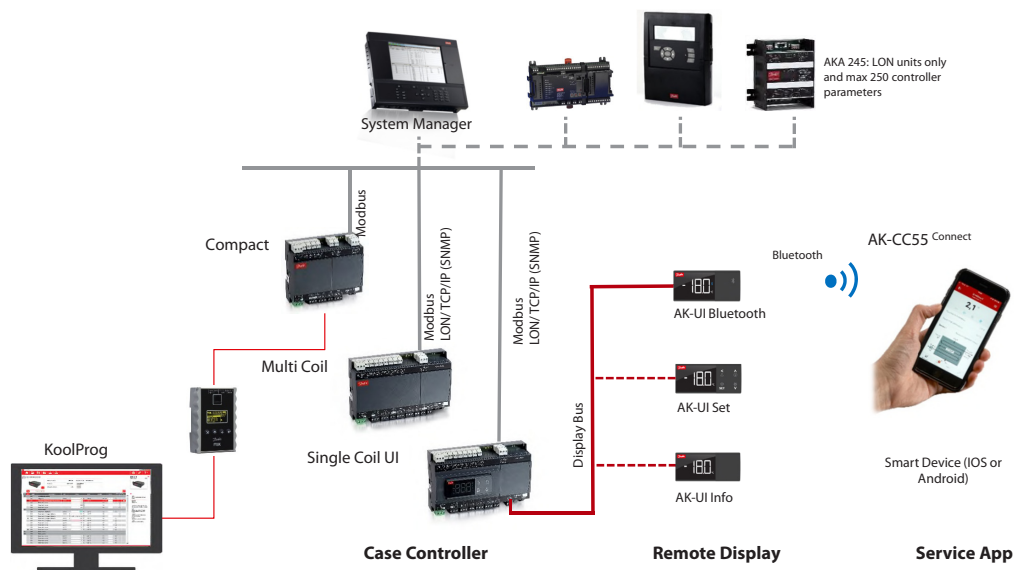

Fact Sheet | AK-CC55 case controller compatibility

4.2 AK-SM 8xxA

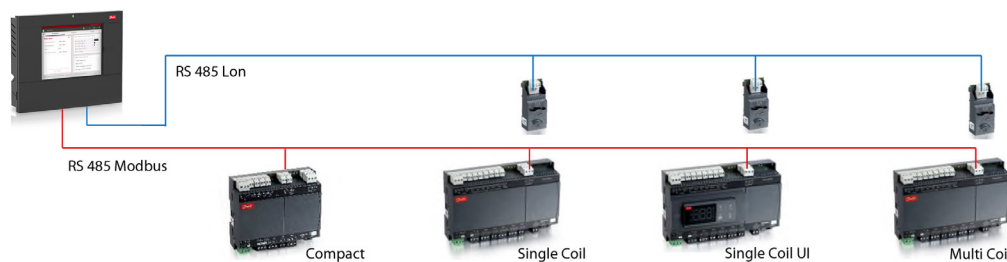

AK-CC55 version	Device description file	AK-CC55 remarks
Compact	EPK	Supported via built in Modbus only. No option for LON.
Single Coil	EPK	Supported via built in RS485 Modbus or RS 485 Lon via optional module.
Single Coil UI	EPK	Supported via built in RS485 Modbus or RS 485 Lon via optional module.
Multi Coil	EPK	Supported via built in RS485 Modbus or RS 485 Lon via optional module.

CO₂ Adaptive Liquid Management (CALM) (activation of ALC in AK-CC55 via bus communication) supported by Custom schedule only.

Only most recent EPK files can be used: [AK-SM 800A Series](#)

4.3 AK-SM 800 Series SW 08.091

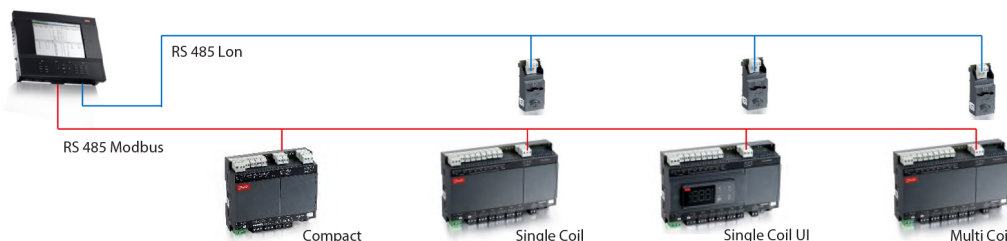

AK-CC55 version	Device description file	AK-CC55 remarks
Compact	ED3 for AK-SM 8xx	Supported via built in Modbus only. No option for LON.
Single Coil	ED3 for AK-SM 8xx ED4 for AK-SM 8xx - SW 08.091	Supported via built in RS485 Modbus or RS 485 Lon via optional module.
Single Coil UI	ED3 for AK-SM 8xx	Supported via built in RS485 Modbus or RS 485 Lon via optional module.
Multi Coil	ED3 for AK-SM 8xx	Supported via built in RS485 Modbus or RS 485 Lon via optional module.

CO₂ Adaptive Liquid Management (CALM) (activation of ALC in AK-CC55 via bus communication) supported by Custom schedule only.

Only most recent ED3/ED4 files can be used: <https://www.danfoss.com/en/service-and-support/downloads/dcs/adap-kool-software/ak-sm-800/#tab-overview>

Note: ED4 files are only to be used for SW 08.091 for Single Coil (084B4082/084B4182).

Fact Sheet | AK-CC55 case controller compatibility

4.4 AK-SC 355

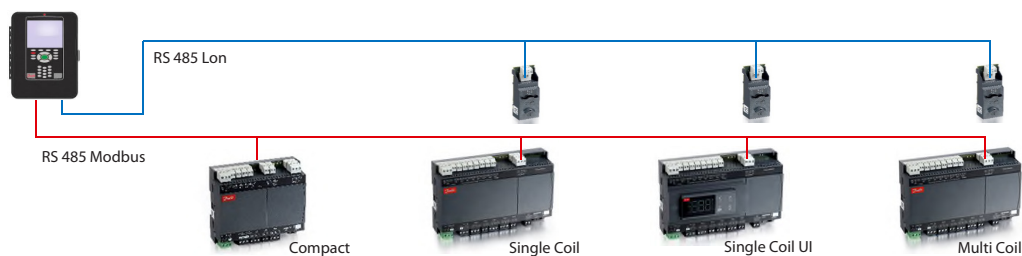

AK-CC55 version	Device description file	AK-CC55 remarks
Compact	EDF Type 2	Supported via built in RS485 Modbus only. No option for LON.
Single Coil	EDF Type 2	Supported via built in RS485 Modbus or RS 485 Lon via optional module.
Single Coil UI	EDF Type 2	Supported via built in RS485 Modbus or RS 485 Lon via optional module.
Multi Coil	EDF Type 2	Supported via built in RS485 Modbus or RS 485 Lon via optional module.

4.5 AK-SC 255

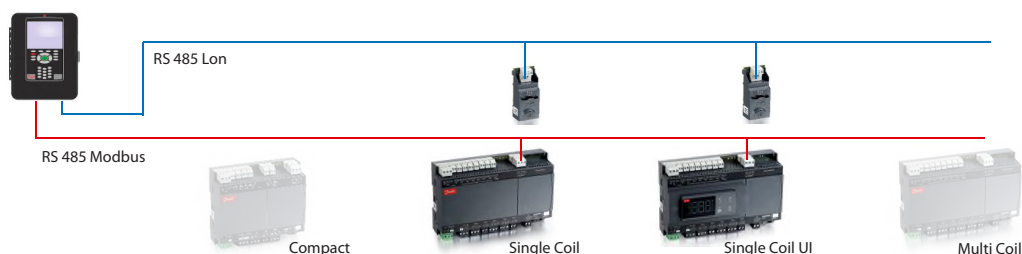

AK-CC55 version	Device description file	AK-CC55 remarks
Compact	Not supported	
Single Coil	EDF Type 1	Supported via built in RS485 Modbus or RS 485 Lon via optional module.
Single Coil UI	EDF Type 1	Supported via built in RS485 Modbus or RS 485 Lon via optional module.
Multi Coil	Not supported	

4.6 AK-SM 720 SW 2.73 (released 2013)

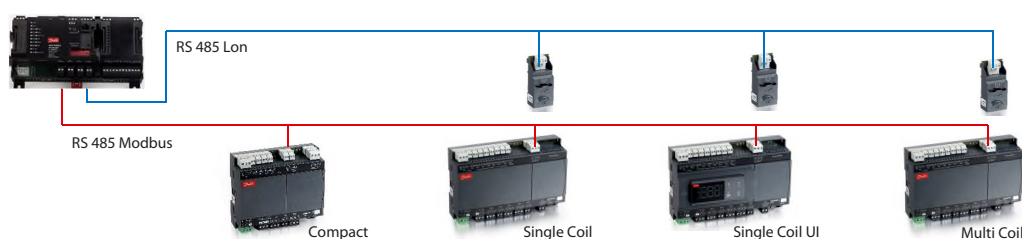

AK-CC55 version	AK-CC55 remarks
Compact	Supported via built in Modbus only. No option for LON
Single Coil	Supported via built in RS485 Modbus or RS 485 Lon via optional module.
Single Coil UI	Supported via built in RS485 Modbus or RS 485 Lon via optional module.
Multi Coil	Supported via built in RS485 Modbus or RS 485 Lon via optional module.

- Newest versions of AK-SM 720 support 300 parameters and 60 alarms per controller.
- AK-SM 720 with H8 processor, max. 15 different controller applications.

Fact Sheet | AK-CC55 case controller compatibility

4.7 AK-SM 350
SW 1.5 and 2.50

080Z8508 SW 1.5 (Coop) & 080Z8500 SW 2.50 or newer (standard version).

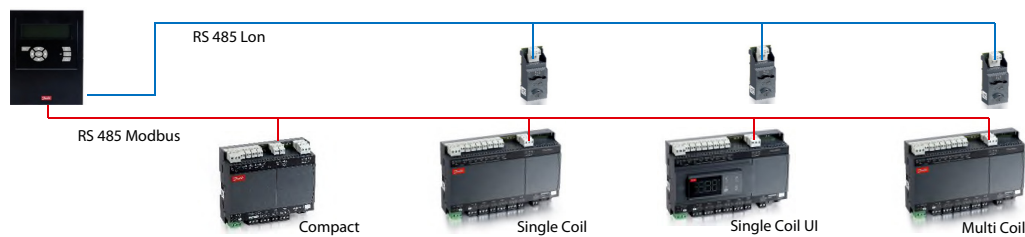

AK-CC55 version	AK-CC55 remarks
Compact	Supported via built in Modbus only. No option for LON
Single Coil	Supported via built in RS485 Modbus or RS 485 Lon via optional module.
Single Coil UI	Supported via built in RS485 Modbus or RS 485 Lon via optional module.
Multi Coil	Supported via built in RS485 Modbus or RS 485 Lon via optional module.

- Newest versions of AK-SM 350 support max 300 parameters and 60 alarms per controller
- Use template editor to create local views

4.8 AKA 245
SW 6.23 (released 2008)

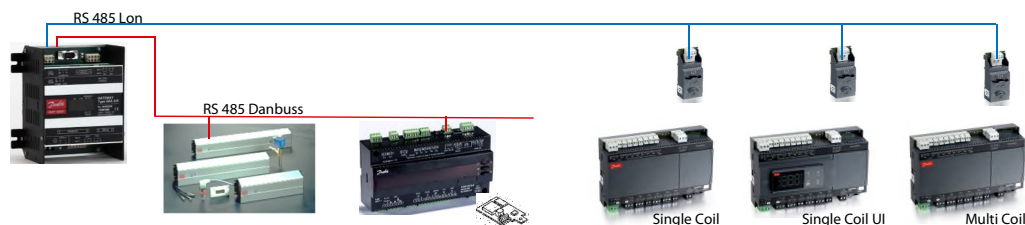

AK-CC55 version	AK-CC55 remarks
Compact	Not supported - No option for LON
Single Coil	RS 485 Lon support only via optional module.
Single Coil UI	RS 485 Lon support only via optional module.
Multi Coil	RS 485 Lon support only via optional module.

- Max. 250 parameters are supported (if more than 250 controller parameters or 50 alarms the last parameters/alarms will not be visible in AKA 245 / AKM)
- Po optimization not supported in AK-CC55 by AKM
- **No support for Danbuss in new AK-CC55 platform**

ENGINEERING
TOMORROW

