

Installation Guide

Remote Control IKORE + R11

Danfoss does not take responsibility for incorrect installation or any frequency interference.

Chance of unintended machine movement on start up.
Ensure the machine is stopped for the entire duration of the assembly process.
Keep the work area free and wear protective clothing.

To guarantee the specified autonomy of the product, it is necessary to use AAA LR03 (x3) Alkaline batteries with nominal capacities between 900 and 1155 mAh. It is highly recommended to use brands with **PLUS** type or similar with nominal capacities close to 1155 mAh. Rechargeable batteries are not recommended because of their lower nominal capacity.

1. Connect the power supply and the outputs according to the connection block diagram provided with the system.
The configuration of the radio node can last up to 1 minute.

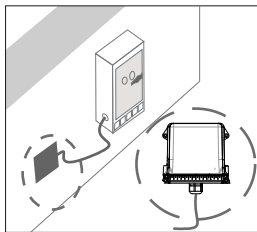

2. Insert the EEPROM and the batteries.

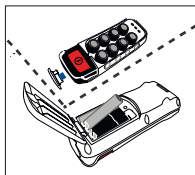

3. Push and pull out the STOP button.

The status LED will pulse blue until the stand by mode is reach, then it will turn into a continuous blue.

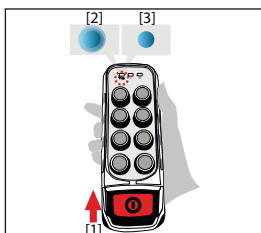

4. Press the start button.

The status LED will pulse green until the transmitter is linked with the receiver. The LED will turn into a continuous green when the receiver confirms the link.

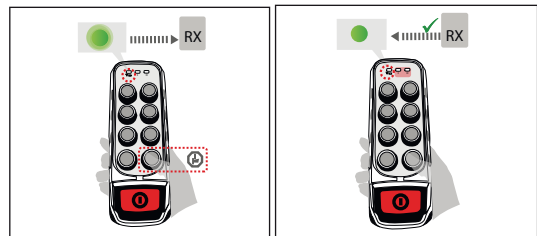

The system is now fully operational.

Description

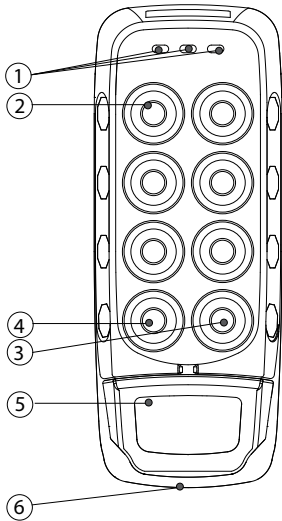

IKORE transmitter

- 1. LED
- 2. Maneuver button
- 3. Start button
- 4. Hoist selection
- 5. STOP button
- 6. Removable EEPROM

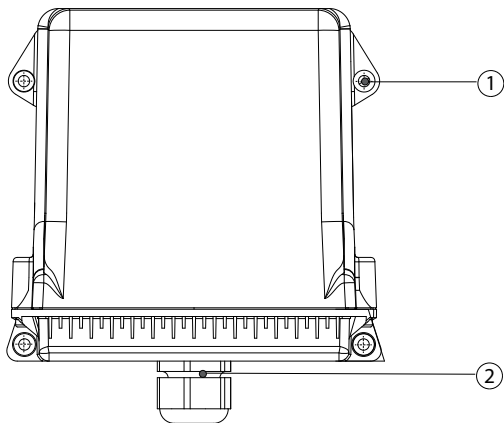

R11 receiver

- 1. Fixing slots (fixed assembly or anti-vibration or anti-vibration with magnets)
- 2. M25 cable gland

Hoist Selection

During the hoist selection, activating maneuvers is not allowed. Hoist selection can only be done in working mode.

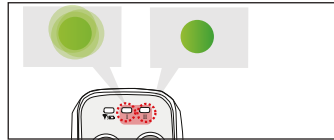
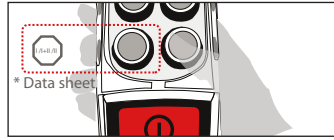

Hoist button and LEDs

[For more information, please consult the relevant User Manual.](#)

Receiver User Manuals & Datasheets



Transmitter User Manuals & Datasheets



<https://www.danfoss.com/en/products/dps/electronic-controls/human-machine-interfaces-hmi/plus1-remote-controls/>