



ECtemp 850 IV



ECtemp 850 version IV is an advanced thermostat with LED display used for outdoor ground or roof applications. The sensors provide information about both moisture level and temperature, resulting in an optimal control of the heating system.

The ECtemp 850 can handle up to 2 independent areas, in any of the following combinations:

- Single system for roof or ground (1 system, 1–4 sensors).
- Combination system: 1 ground system and 1 roof system (2 systems, 2–4 sensors total, min. 1 sensor per system).
- Dual system: either 2 roof systems or 2 ground systems (2 systems, 2–4 sensors total, min. 1 sensor per system).

In the dual / combination systems it is possible to prioritize between the zones, e.g. if only a limited power output is available.

Product specifications

Benefits <ul style="list-style-type: none"> • Single, combination or dual zones • Up to 4 sensors • Moisture and temperature sensing • Self diagnosing programme • Safety level adjustment • Alarm function Approvals:  Standard compliance <ul style="list-style-type: none"> • EN/IEC 60730-1 (general) • EN/IEC 60730-2-9 (thermostat) 	Operation voltage: PSU 24 VDC ECtemp 850	180–250 VAC, 50–60 Hz / 24 VDC, 2,5 A 24 VDC ±10%
	Power consumption, max.: ECtemp 850 Roof sensor Ground sensor	3 W 8 W (each) 13 W (each)
	Relay resistive load, max.: System A / B relay Alarm relay Inductive load each relay, max.	15 A (3450 W) @ 230 V 2 A @ 230 V 1 A @ 230 V, power factor 0,3
	Sensing unit	DEVibus™ connected moisture sensor(s)
	Cable specification max	1 x 4 mm ² or 2 x 2,5 mm ²
	Ball pressure test temperature	75 °C
	Pollution degree	2 (domestic use)
	Controller type	1 C
	Storage temperature	-20 °C to +65 °C
	IP class	20
	Protection class	Class II - 
	Dimensions ECtemp 850 (H/W/D)	85 x 105 x 53 mm
	Mounting method	DIN rail
	Weight	720 g

Types

Item no.	Product name	Type	Power	Size, mm	Operation temperature	EAN no.
088L0449	ECtemp 850 IV no sensors	Without sensors, with PSU CP-D 24 VDC/2,5 A		105 x 23,5 x 53	-10...+50 °C	5703466130391
088L0457	Ground sensor, 1 pcs.	ECtemp 850 IV Latin with PSU	13 W	15 x 24 x 216	-50...+70 °C	5703466168769
088L0458	Ground sensor, 2 pcs.	For ECtemp 850, with sensor tube, cable - 15 m	13 W	15 x 24 x 216	-50...+70 °C	5703466150283
088L0459	Roof sensor	For ECtemp 850, cable - 15 m	8 W	Ø 93 x 98	-30...+70 °C	5703466150290



ECtemp 850 with PSU



Ground sensor



Roof sensor

Connection scheme

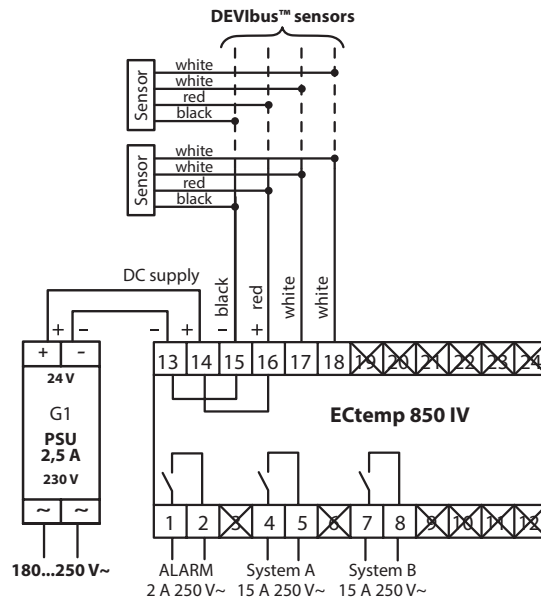

System configurations

Zone support saves energy

ECtemp 850 lets you divide your area in to 2 zones, e.g. a North and South side. In this way it is possible to save energy, when the South side is free of ice and snow faster because of the heat from the sun.

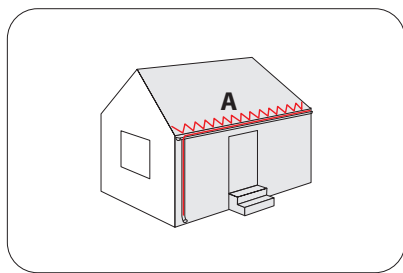

Single zone system for roofs
(system A)

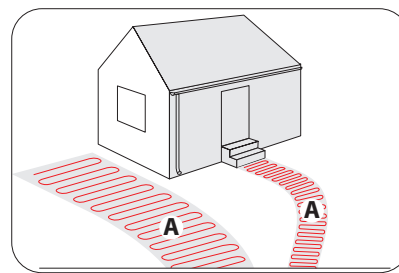

Single zone system for ground
(system A)

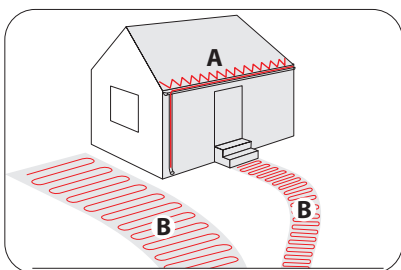

Combined system -
one zone for roof (system A),
one zone for ground (system B)

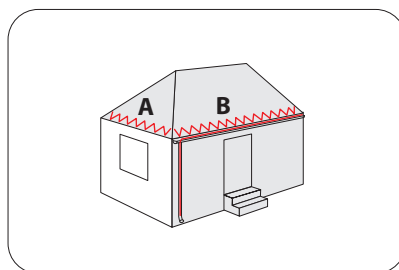

Two zone system for roofs
(systems A and B)

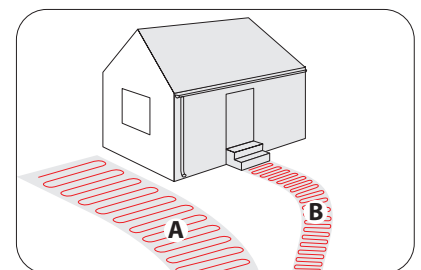

Two zone system for ground
(systems A and B)