

Data Sheet

Thermostat Type **MBC 8000** and **MBC 8100**

For heavy-duty marine applications



MBC 8000 and MBC 8100 thermostats designed for use in severe industrial and marine applications where space and reliability are the most important features.

MBC 8100 have all international marine approvals.

The MBC thermostats are designed according to our block design to survive in the harsh conditions known from machine rooms among others.

MBC 8000 and MBC 8100 have high vibration resistance.

Features:

- Compact design
- A high level of enclosure
- Robust and reliable construction
- Resistance to shock and vibration
- Low differential and high repeatability

Product specification

Technical data

Table 1: Electrical specifications

Contact load (Alternating current)	0.5 A, 250 V, AC15
	12 W, 125 V, DC 13
Switch	SPDT

Table 2: Environmental conditions

Ambient temperature	-40 – 70 °C
Shock resistance	50 g/6 ms
	Acc. to EN 60068-2-27
Vibration resistance	Free fall acc. to EN 60068-2-32
	Sin 4 g, 5Hz – 200 Hz acc. to EN 60068-2-6 ⁽¹⁾
Enclosure	IP65 to EN 60529
	Anodized AlMgSi 1, AW-6082 T6

⁽¹⁾ If higher vibrations are present in the system/installation, temperature controls with capillary tube or armoured capillary tube are recommended.

Table 3: Mechanical characteristics

Electrical connection	DIN 43650 plug, Pg 9, Pg 11, Pg 13.5
-----------------------	--------------------------------------

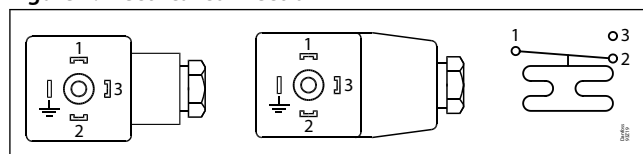
Figure 1: Electrical connection

1	Input
2	Output: Normally closed (NC)
3	Output: Normally open (NO)
⏏	Connected to enclosure of pressure control

Standard specification and code numbers

Table 4: Standard specification and code numbers

Setting range	Fixed diff.	Max. sensor temp.	Cap. tube length	Capillary tube		Armoured capillary tube		Sensor pocket	Rigid sensor	
				Code no.	Type MBC 8100	Code no.	Type MBC 8100		Code no.	Type MBC 8100
-10 – 30	3	80	2	061B820166	1221-1A02000	061B810166	1231-1A02000	–	–	–
20 – 60	3	130	2	–	–	061B810266	1431-1A02000	–	–	–
20 – 60	3	130	–	–	–	–	–	75	061B800266	1411-1A00075
50 – 100	4	200	2	061B820366	2221-1A02000	061B810366	2231-1A02000	–	–	–
50 – 100	4	200	–	–	–	–	–	75	061B800366	2211-1A00075
70 – 120	5	220	2	–	–	061B810466	2431-1A02000	–	–	–
70 – 120	5	220	–	–	–	–	–	75	061B800466	2411-1A00075
60 – 150	6	250	2	061B820566	2621-1A02000	061B810566	2631-1A02000	–	–	–
60 – 150	6	250	–	–	–	–	–	75	061B800566	2611-1A00075

Setting point correction

The sensor on MBC 8100 thermostat contains an adsorption charge. Therefore its function is not affected whether the sensor is placed warmer or colder than the remaining part of the thermostatic element (bellows and capillary tube). However, such a charge is to some extent sensitive to changes in the temperature of the bellows and capillary tube. Under normal conditions this is of no importance, but if the thermostat is to be used in extreme ambient temperatures the setting point might change.

The deviation can be compensated for as follows:

Setting point correction = Z x a

Z can be found from **Figure 2: Setting point correction**, while **a** is the correction factor from the table below.

Figure 2: Setting point correction

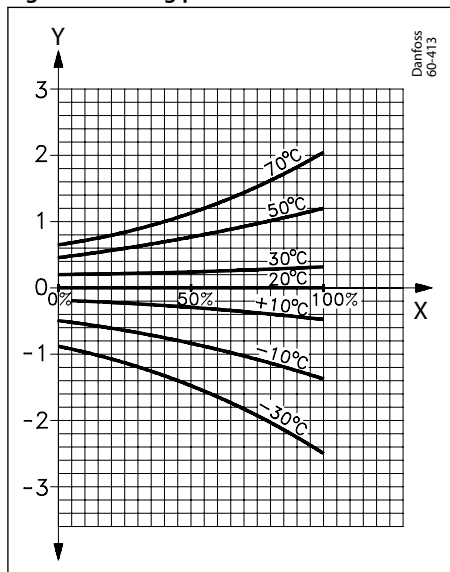

X	Relative scale setting in [%]
Y	Factor for setting point deviation

Table 5: Correction factor

Regulation range [°C]	Correction factor a for thermostats	
	with rigid sensor	with 2 and 5 m capillary tube
-10 – 30	–	1.1
20 – 50	1.0	1.4
50 – 100	1.5	2.2
70 – 120	1.7	2.4
60 – 150	–	3.7

Example:

A MBC 8100 with capillary tube length 2 m and range 50 – 100 °C must cut out at 75 °C in 70 °C ambient temperature. At which cut out temperature should this temperature control be set at in 20 °C ambient temperature.

The relative setting **Z** can be calculated from the following formula:

$$\frac{\text{Setting value} - \text{min. range}}{\text{max. range} - \text{min. range}} \times 100 \%$$

$$\text{Relative setting: } \frac{75 - 50}{100 - 50} \times 100 = 50 \%$$

Relative setting:

Factor for setting point deviation **Z**, see **Figure 2: Setting point correction**.

Z - 1.2

Correction factor **a** (table under fig. 1) a = 2.2

Setting point correction Z x a = 1.2. x 2.2 = 2.6 °C

The MBC must be set at 75 + 2.6 = 77.6 °C in 20 °C ambient temperature in order to cut out at 75 °C ambient temperature.

Installation

Installation

MBC thermostats are designed to withstand the shocks that occur, e.g. in ships, on compressors and in large machine installations. MBC thermostats with remote sensor are fitted with 5 mm screws to bulkheads or similar. See [Figure 3](#). MBC thermostats with rigid sensor are self-supporting from the sensor pocket. For permissible media pressure, see [Figure 4](#).

Figure 3: Mounting example

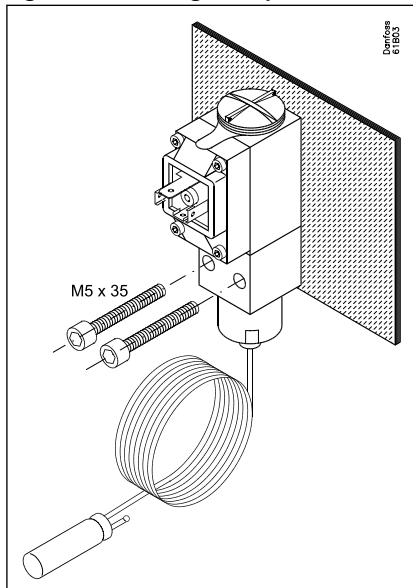
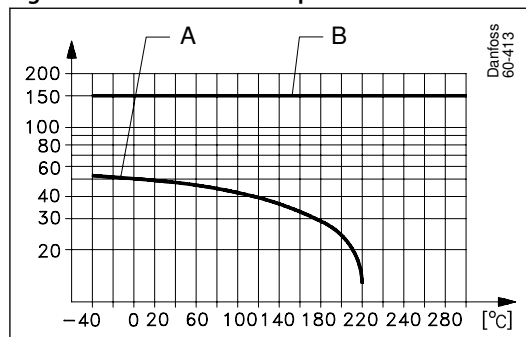

Figure 4: Permissible media pressure on the sensor pocket as a function of temperature



A	Brass
B	Stainless steel

Resistance to media

Material specifications for sensor pockets:

Sensor pocket, brass

The tube is made of CuZn30, CW 505L acc. to EN 12449, the threaded portion of CuZn39 Pb3, CW 614N acc. to EN 12164.

Sensor pocket, stainless steel 18/8

Material designation X5CrNi18-10, 1.4301 acc. to EN 10088.

Sensor position

As far as possible the sensor should be positioned so that its longitudinal axis is at right angles to the direction of flow. The active part of the sensor is $\varnothing 13$ mm x 50 mm long on thermostat with rigid sensors and 2 m capillary tube.

Setting

When the top cover screw at the thermostat is removed, the range can be set with the setting screw. The differential is non-adjustable.

Figure 5: Adjustment

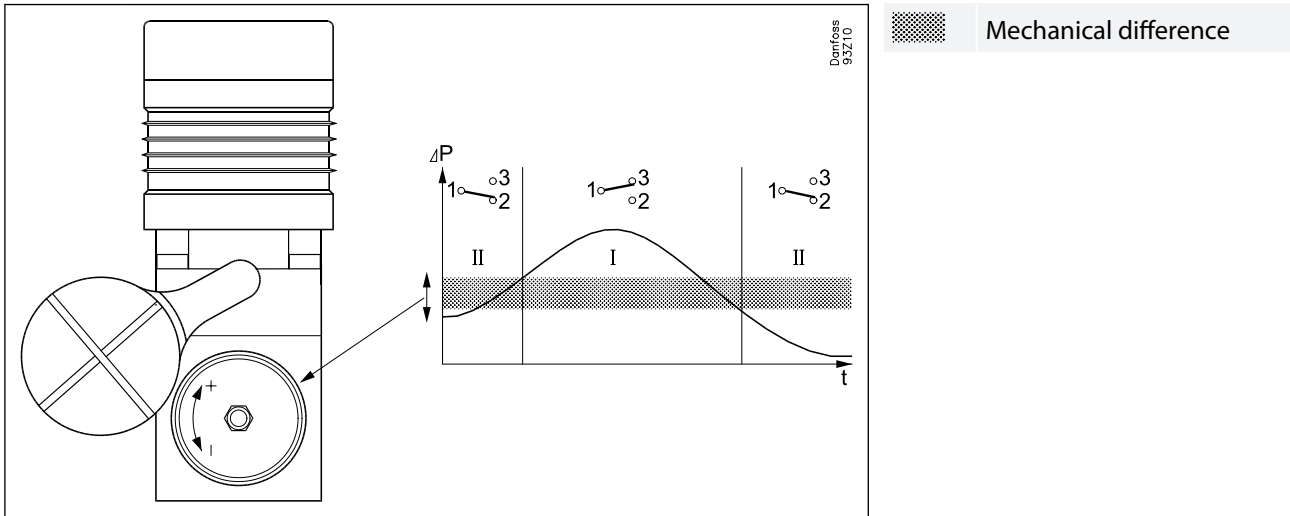

Dimensions and weights

Table 6: Dimensions [mm] and weights [kg]

Rigid sensor		Cap. tube version	
Net weight: 0.25		Net weight: 0.27	

Ordering

Figure 6: Ordering of customized types

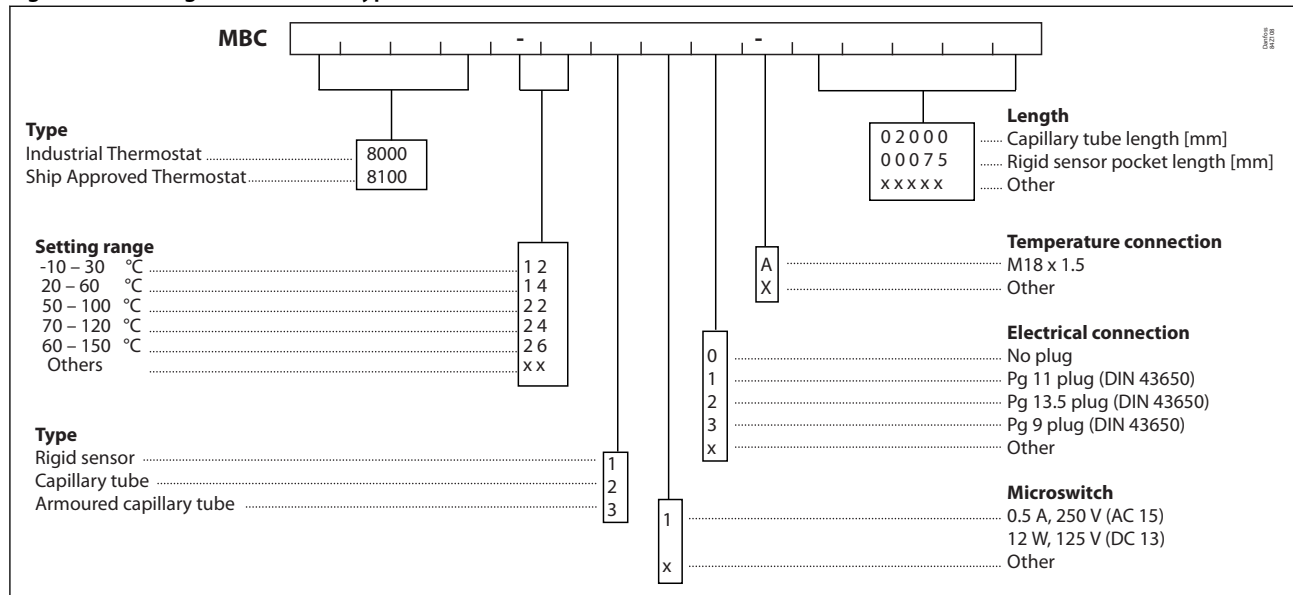



Accessories

Table 7: Sensor pockets

Part	Sensor pocket	A [mm]	Thread B	Code no.
<p>Supplied without gland nut, gaskets and washer</p>	Brass	75	1/2 NPT	060L326466
		75	G 1/2 A	060L326266
		75	G 3/4 A	060L326666
		75	G 1/2 A (ISO 228-1)	060L328166
	Brass	110	1/2 NPT	060L328066
		110	G 1/2 A	060L327166
		110	G 3/4 A (ISO 228-1)	060L340366
	Brass	160	G 1/2 A	060L326366
	Steel 18/8	75	G 1/2 A	060L326766
	Steel 18/8	110	G 1/2 A	060L326866
			1/2 NPT	060L327066
	Steel 18/8	160	G 1/2 A	060L326966

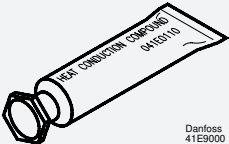
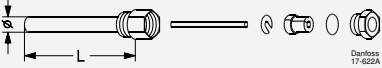
Table 8: Other parts

Part	Description	Code no.
<p>Clamping band</p> 	For MBC thermostats with remote sensor (L = 392 mm)	017-420466
<p>Heat-conductive compound (6 g tube)</p> 	For MBC thermostats with sensor fitted in a sensor pocket. Compound for filling sensor pocket to improve heat transfer between pocket and sensor. Application range for compound: -20 – 150 °C, momentarily up to 220 °C.	041E0115
<p>Gasket set</p> 	For MBC thermostats without armoured capillary tubes	060L327366
<p>Gasket set</p> 	For MBC thermostats with armoured capillary tubes	060L036666

Certificates, declarations, and approvals

The list contains all certificates, declarations, and approvals for this product type. Individual code number may have some or all of these approvals, and certain local approvals may not appear on the list.

Some approvals may change over time. You can check the most current status at danfoss.com or contact your local Danfoss representative if you have any questions.

Table 9: MBC 8000

File name	Document type	Document topic	Approval authority
2003010305069847	Electrical - Safety Certificate	-	CCC
EU 060-9680.AA	EU Declaration	LVD	Danfoss
UA.10146.D.00075-19	UA Declaration	EMCD/LVD	LLC CDC EURO TYSK
060-9639.AB	Manufacturers Declaration	China RoHS	Danfoss
2020970305003455	CCC Declaration	-	Danfoss

Table 10: MBC 8100

File name	Document type	Document topic	Approval authority
17.20389.258	Marine - Safety Certificate		RMRS
HMB 17529-AE001	Marine - Safety Certificate		KR
14-20046(E1)	Marine - Safety Certificate		LR
GB19PTB00011_05	Marine - Safety Certificate		CCS
TAA00002BB	Marine - Safety Certificate		DNV GL
TA20287M	Marine - Safety Certificate		NKK
16-LD1581072-PDA	Marine - Safety Certificate		ABS
11676-D1 BV	Marine - Safety Certificate		BV
ELE-364617XG	Marine - Safety Certificate		RINA
060-9680.AA	EU Declaration	LVD	Danfoss
2003010305069847	Electrical - Safety Certificate		CCC
UA.10146.D.00075-19	UA Declaration	EMCD/LVD	LLC CDC EURO TYSK
060-9639.AB	Manufacturers Declaration	China RoHS	Danfoss
2020970305003455	CCC Declaration		Danfoss

CE-marked in accordance with:

- LVD 2014/35/EU (EN 60947-1, EN 60947-4-1, EN 60947-5-1)

Online support

Danfoss offers a wide range of support along with our products, including digital product information, software, mobile apps, and expert guidance. See the possibilities below.

The Danfoss Product Store



The Danfoss Product Store is your one-stop shop for everything product related—no matter where you are in the world or what area of the cooling industry you work in. Get quick access to essential information like product specs, code numbers, technical documentation, certifications, accessories, and more.

Start browsing at store.danfoss.com.

Find technical documentation



Find the technical documentation you need to get your project up and running. Get direct access to our official collection of data sheets, certificates and declarations, manuals and guides, 3D models and drawings, case stories, brochures, and much more.

Start searching now at www.danfoss.com/en/service-and-support/documentation.

Danfoss Learning



Danfoss Learning is a free online learning platform. It features courses and materials specifically designed to help engineers, installers, service technicians, and wholesalers better understand the products, applications, industry topics, and trends that will help you do your job better.

Create your Danfoss Learning account for free at www.danfoss.com/en/service-and-support/learning.

Get local information and support



Local Danfoss websites are the main sources for help and information about our company and products. Find product availability, get the latest regional news, or connect with a nearby expert—all in your own language.

Find your local Danfoss website here: www.danfoss.com/en/choose-region.

Danfoss A/S

Climate Solutions • danfoss.com • +45 7488 2222

Any information, including, but not limited to information on selection of product, its application or use, product design, weight, dimensions, capacity or any other technical data in product manuals, catalogues descriptions, advertisements, etc. and whether made available in writing, orally, electronically, online or via download, shall be considered informative, and is only binding if and to the extent, explicit reference is made in a quotation or order confirmation. Danfoss cannot accept any responsibility for possible errors in catalogues, brochures, videos and other material. Danfoss reserves the right to alter its products without notice. This also applies to products ordered but not delivered provided that such alterations can be made without changes to form, fit or function of the product.

All trademarks in this material are property of Danfoss A/S or Danfoss group companies. Danfoss and the Danfoss logo are trademarks of Danfoss A/S. All rights reserved.