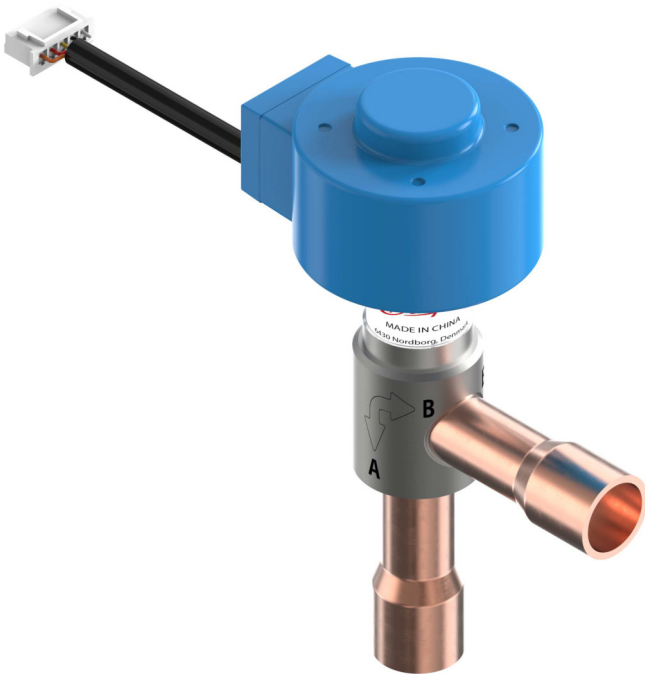

Data Sheet

Electric expansion valve
Type **ETS 8M**

ETS 8M is a stepper motor driven electric expansion valve with a high level of reliability, and it provides a precise solution for expansion and flow control in a wide range of refrigeration and air conditioning system. The valve comes with two flow curve options, a linear and a S-shaped characteristic.

ETS 8M can be applied for applications i.e. Modular Chiller and Low Ambient Temp Heat Pump in single/bi-flow operations.

Valve operation is by means of a stepper motor and as such it is compatible with a number of electronic controllers from Danfoss or third-party vendors.

Features:

- High MOPD to comply with compressor operating envelope
- Low internal leakage
- Long lifetime and durability
- Optimized valve flow characteristic
- Stable flow control at low opening degree
- Dedicated flow control curve for heat pump
- Compatible with existing valve drivers
- Bi-flow, with good performance in both flow directions
- Flexible installation: vertical orientation $\pm 90^\circ$
- Coil enclosure up to IP67
- Available with both uni-polar and bi-polar coils
- In accordance with
 - JB/T 10212
 - RoHS (China and EU)
 - REACH
 - PED
 - UL 429

Portfolio overview

ETS 8M is a system product whose function is controlled through a Danfoss electronic controller or a third-party vendor electronic controller that is compatible with the ETS 8M as to control functionality and connections.

The electronic controller requires precise temperature input from a temperature sensor (refrigerant temperature) and precise pressure inputs (evaporator pressure) from a pressure transmitter.

Table 1: Portfolio overview

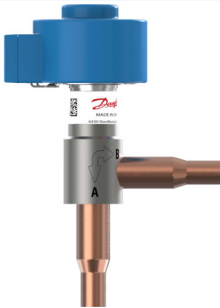
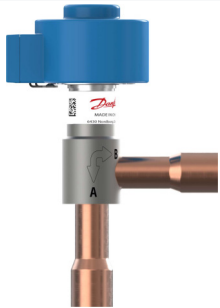
Features	ETS 8M	ETS 8M
		
Solder connection	Copper	Copper
Size [mm]	4.0 – 4.5	4.0 – 6.5
Connection size	ODM 3/8"	ODM 5/8"
Max. working pressure [bar]	49	49
Brazing connector configuration	Angle way	Angle way

Application

Figure 1: Typical application of ETS 8M

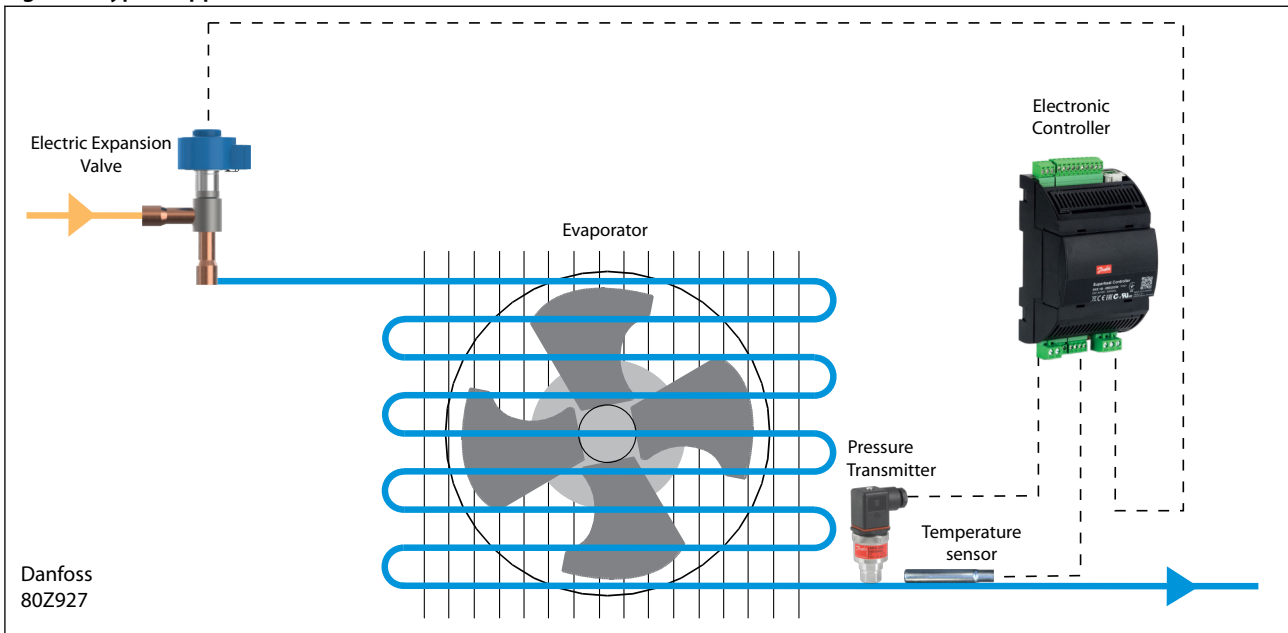

Media

ETS 8M is designed for use with fluorinated refrigerants with suitable lubricants.

Table 2: ETS 8M media data

Refrigerants	R410A, R32, R407C, R290, R454B, R452B, R454C, R513A, R449B, R404A, R448A, R449A, R515B, R452A, R134a, R1234ze
Oil	POE, PVE

NOTE:

For flammable refrigerants (R454C, R290, R32, R452B, R454B):

- This product is validated in accordance to ATEX, EN 378, ISO 5149, ASHRAE 15, IEC 60335-2-x or equivalent standards.
- Ignition risk is evaluated in accordance to ISO 5149 and IEC 60335.
- See safety note below.

NOTE:

- The product can be applied on systems with R454C, R290, R32, R452B, R454B as the working fluid.
- For countries where safety standards are not an indispensable part of the safety system Danfoss recommend the installer to get a third party approval of the system containing flammable refrigerant.
- Note, please follow specific selection criteria stated in the datasheet for these particular refrigerants.
- The valve must only be used in closed circuit refrigeration system, where no oxygen is present acc. EN 378, ISO 5149 ASHRAE 15 or IEC 60335-2-x or equivalent standards.

Product specification

Design

The ETS 8M Electric expansion valves open and close to regulate refrigerant flow by means of a screw whose rotating motion is transformed into linear motion. This occurs by the rotation of a magnet needle valve assembly which moves when electrical signals are applied to the surrounding coil. Within the coil structure, there are different winding configurations, and the polarities are changed by the electrical signals applied.

By application of the appropriate combination of signals, in the form of pulses, the coil forces the rotor of the valve to move in a stepwise fashion. Application of multiple pulses will make the valve mechanism move through a series of steps in the chosen direction, in order to set the valve with the required opening degree.

Flow direction

Figure 2: Flow direction

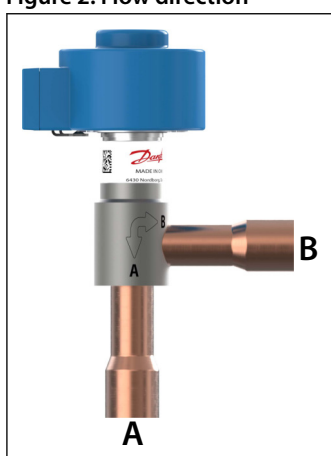

ETS 8M is designed for normal and reverse flow direction, above image from B to A refers the normal flow.

Pressure and temperature data

Table 3: Pressure and temperature data in SI and Imperial units

Data	Value [SI units]	Value [IMP. Units]
Max. working pressure (MWP)	49 barg	710 psig
Burst pressure	5 x MWP	5 x MWP
Max. operating pressure differential (MOPD)	B->A, 39 barg A->B, 32 barg	B->A, 565 psig A->B, 464 psig
Ambient temperature	-30 - 70 °C	-22 - 158 °F
Ambient relative humidity	Max 95%RH	Max 95%RH
Fluid temperature range	-30 - 70 °C	-22 - 158 °F

Environmental conditions

Table 4: Environmental conditions

Data	Value
Max. internal leakage @10 bar	< 800 cm ³ /min
Mechanical noise	Normal operating <60 dB(A) 15 cm away, Overdriving <70 dB(A) @ 15 cm away
Enclosure rating IP (Valve and coil combined)	IP67
Insulation class	Class B
Insulation resistance	>100MΩ
Storage temperature	-30°C to 60°C

Flow characteristics

Figure 3: Linear capacity - Normal flow direction B → A

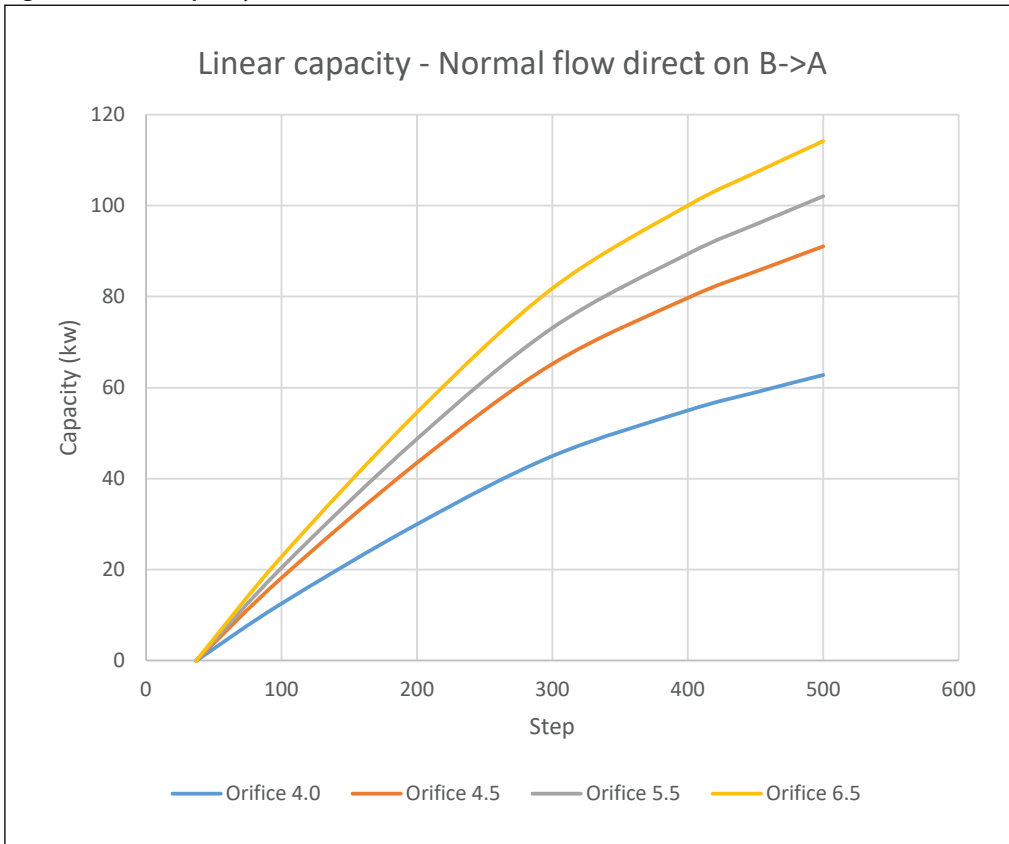

Figure 4: Linear capacity - Reverse flow direction A → B

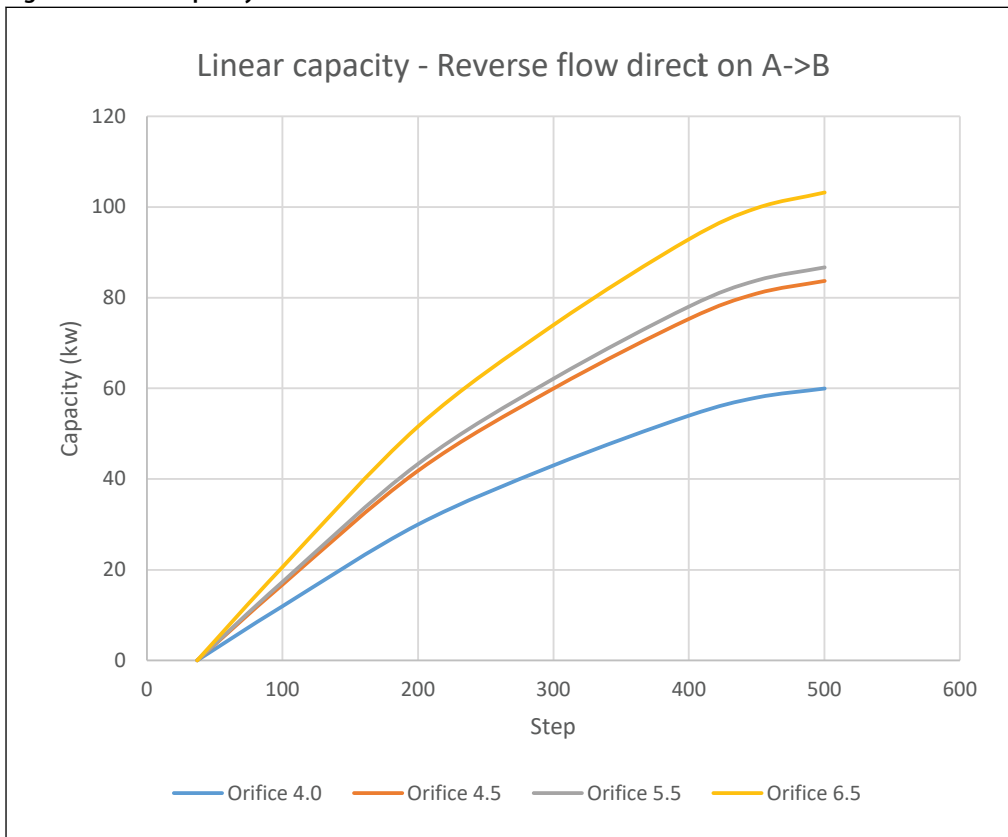

Figure 5: S-shaped capacity - Normal flow direction B → A

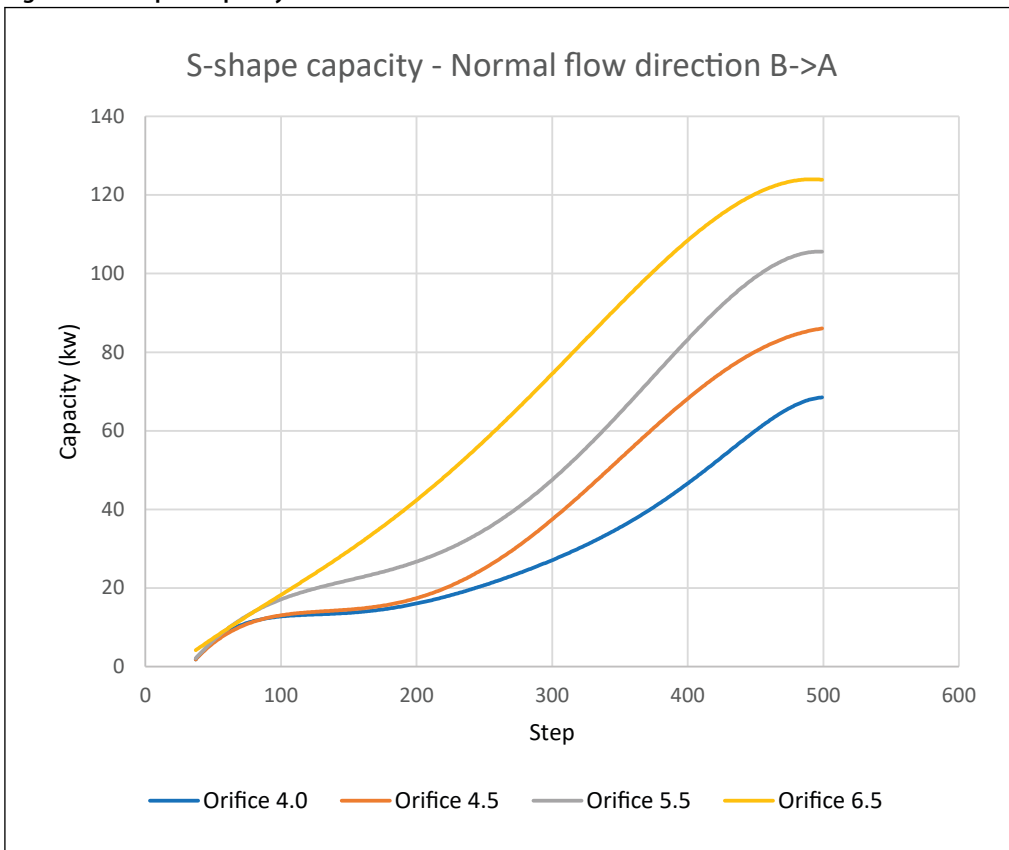
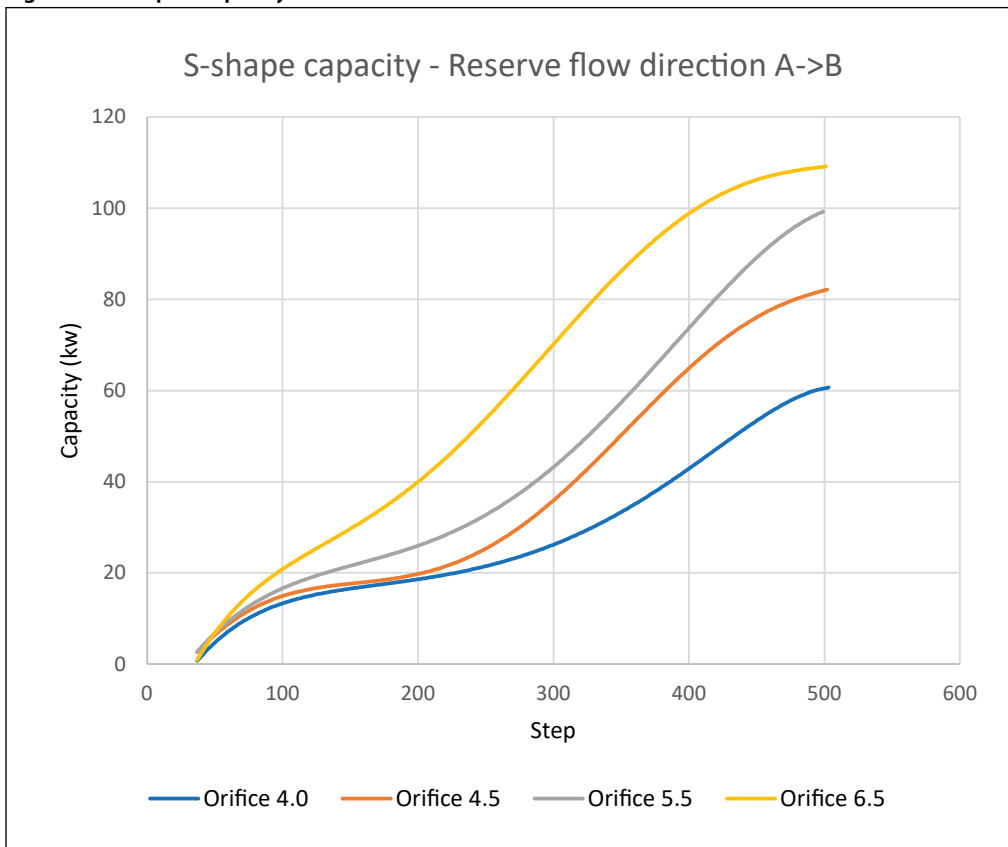

Figure 6: S-shaped capacity - Reverse flow direction A → B



NOTE:

The rated capacity is based on:

Electric expansion valve, type ETS 8M

- Refrigerant: R410A
- Evaporating temperature: $T_e = 5^\circ\text{C}$
- Condensing temperature: $T_c = 38^\circ\text{C}$
- Refrigerant temperature ahead of valve: $T_{\text{liquid}} = 34^\circ\text{C}$
- Subcooling = 4k
- Superheat = 0K
- Driving steps = 500steps

NOTE:

The reverse flow capacity of Orifice 4.0 and 4.5 with 3/8" connection is slightly lower than the 5/8" connection, please contact Danfoss for more details.

Valve selection based on capacity calculation

As for extended capacity calculations and valve selection based on capacities and refrigerants, please refer to Coolselector®

Rated and extended capacities are calculated with Coolselector®2 calculation engine to ARI standards with the ASEREP equations based on laboratory measurements of selected valves.

Electrical connection

Electrical connection is via a fixed cable in a number of lengths from the coil to the controller. Cables up to 6 m length are available with a JST XHP-5 / JST XHP-6 connector. See ETS 8M ordering for details.

Electrical and motor specifications

Valve operation is by means of a Uni-polar motor, designed as a separate coil that clicks onto the valve body.

Table 5: Electrical and motor specifications

Electrical and motor specifications		Value
Motor type		Uni-polar and bi-polar input from controller
Nominal voltage		12V -15% / +10% DC
Coil resistance @ 20°C	Uni-polar	46 ± 3 Ω
	Bi-polar	92 ± 6 Ω
Rated current	Uni-polar	260 mA
	Bi-polar	143 mA
Permanent holding current		No holding current
Open pulses		Max. 52 steps
Number of pulses		500 half-step pulses
Nominal pulse rate		30 pps - 90 pps
Maximum duty cycle (30s)		50%
Insulation resistance		>100 MΩ
Electric strength		< 5 mA
Ex-factory delivery valve position		Packed in 300 steps open valve position

Stepper motor switch sequence

The stepper motor opens and closes as outlined in the table, opening moving to the right of the table, closing moving the opposite direction.

Table 6: Uni-polar motor switch sequence

Cable Color	Excitation Sequence							
	-> Valve opening <- Valve closing							
	1	2	3	4	5	6	7	8
Orange	ON	ON	OFF	OFF	OFF	OFF	OFF	ON
Red	OFF	ON	ON	ON	OFF	OFF	OFF	OFF
Yellow	OFF	OFF	OFF	ON	ON	ON	OFF	OFF
Black	OFF	OFF	OFF	OFF	OFF	ON	ON	ON
Grey	ON	ON	ON	ON	ON	ON	ON	ON

Bi-polar motor switch sequence

Table 7: Bi-polar stepper motor switch sequence

Coil	Wire	Excitation Sequence							
		-> Valve opening -< Valve closing							
		1	2	3	4	5	6	7	8
A1	Orange	-	-	OFF	+	+	+	OFF	-
A2	Yellow	+	+	OFF	-	-	-	OFF	+
B1	Red	OFF	-	-	-	OFF	+	+	+
B2	Black	OFF	+	+	+	OFF	-	-	-

Dimensions

Table 8: Dimensions

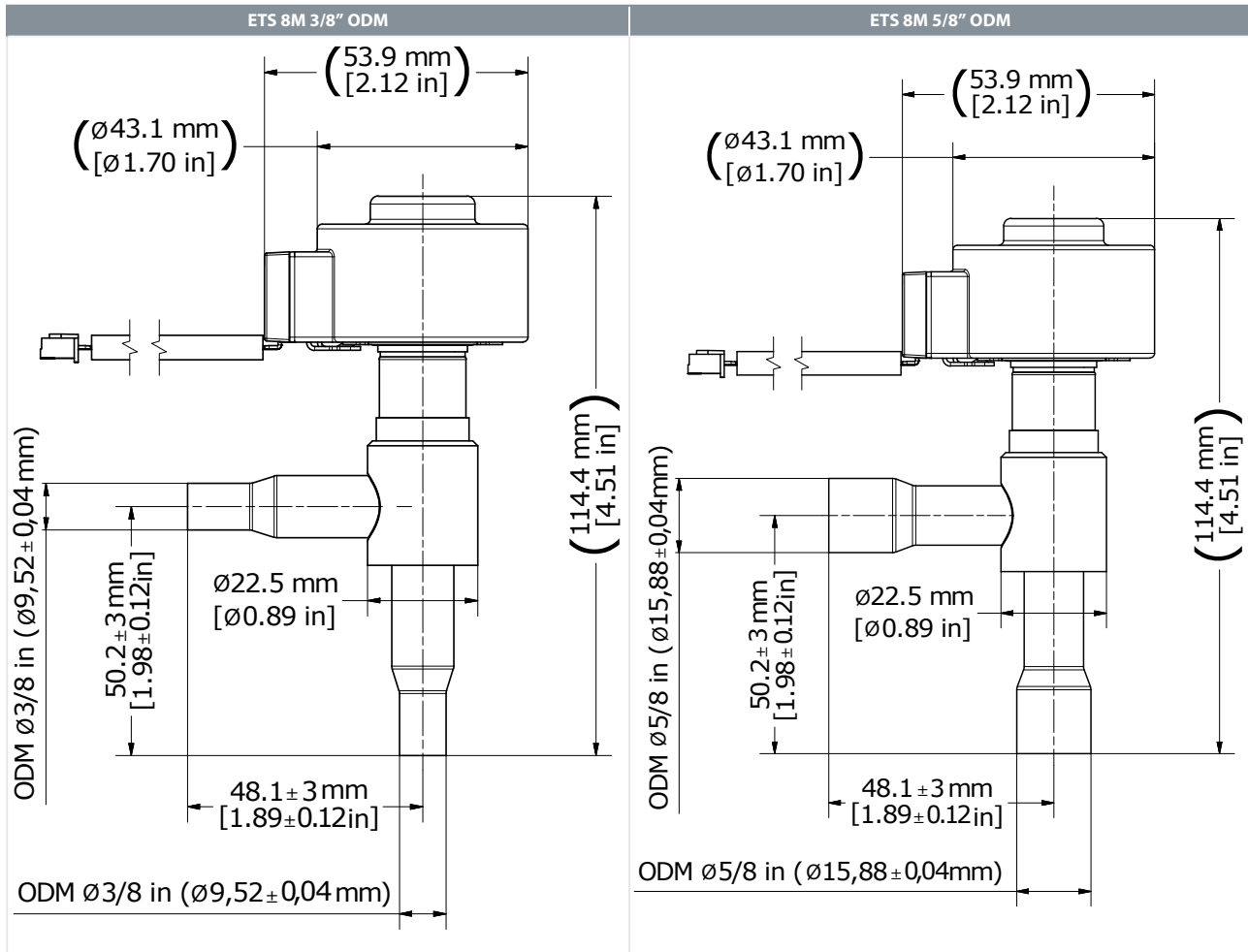

Mounting angle

Figure 7: Mounting angle

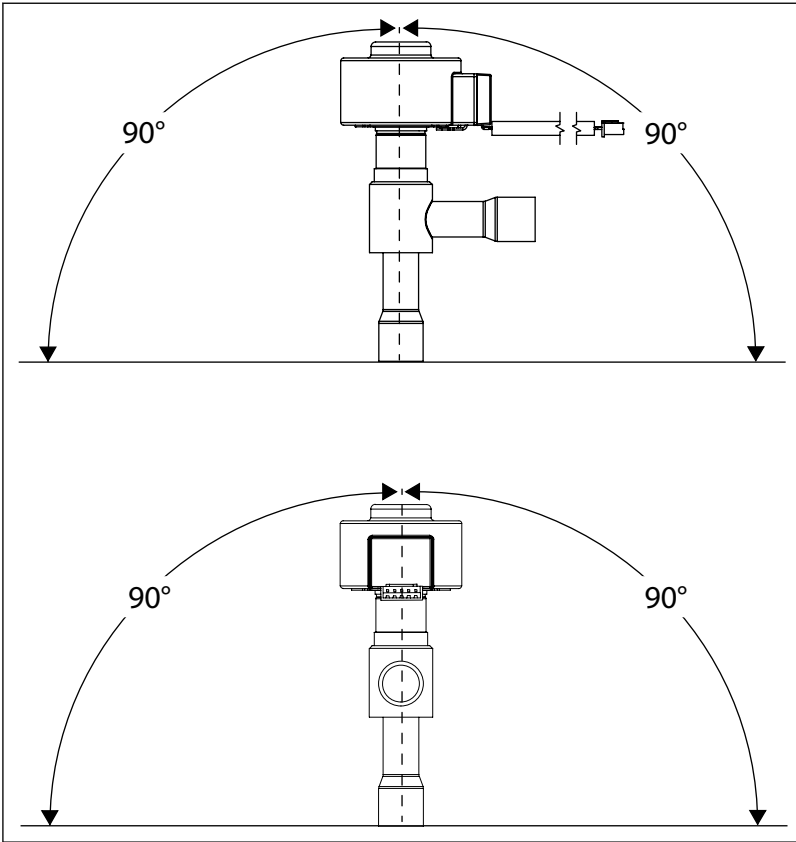

Ordering

Parts program

ETS 8M is a parts program consisting of a valve body and a separate Uni-polar motor coil (ETS 8M coil). Each component is purchased separately. See ordering details below.

Table 9: ETS 8M program

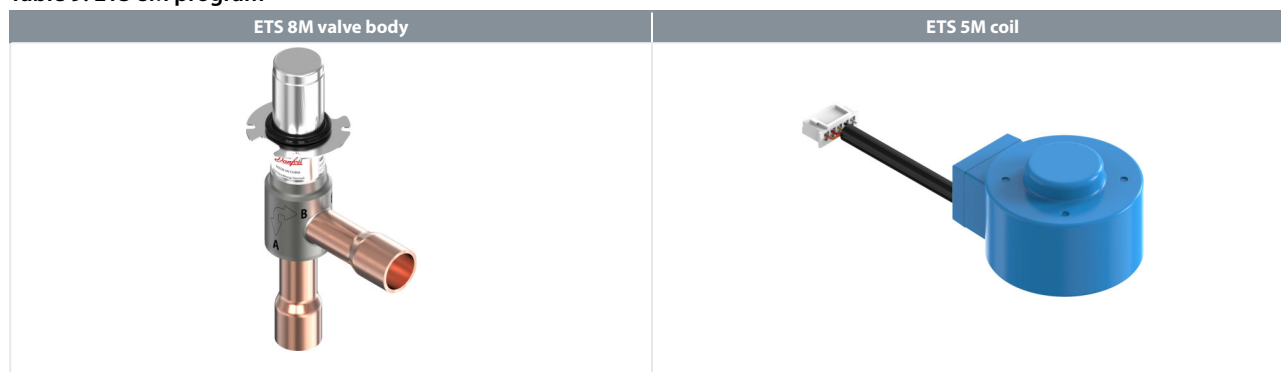

Besides using the ETS 8M coil as spare part, ETS 8M valve is hermetic and unserviceable, therefore is no other spare parts.

Valve body, ordering codes

Table 10: ETS 8M valve body

Orifice size	Connection size		Flow curve	Code no.	Capacity [R410A] *		Packing
	ODM [in]				B->A	A->B	
Orifice Ø4.0	3/8		Linear	034G8800	60.0 kW	55.6 kW	Multi-pack 12 pcs
	5/8			034G8801	62.8 kW	60.0 kW	Multi-pack 12 pcs
	3/8		S-shape	034G8802	60.0 kW	55.6 kW	Multi-pack 12 pcs
	5/8			034G8803	62.8 kW	60.0 kW	Multi-pack 12 pcs
Orifice Ø4.5	3/8		Linear	034G8804	81.2 kW	72.8 kW	Multi-pack 12 pcs
	5/8			034G8805	91.0 kW	83.6 kW	Multi-pack 12 pcs
	3/8		S-shape	034G8806	81.2 kW	72.8 kW	Multi-pack 12 pcs
	5/8			034G8807	91.0 kW	83.6 kW	Multi-pack 12 pcs
Orifice Ø5.5	5/8		Linear	034G8808	102.0 kW	86.7 kW	Multi-pack 12 pcs
	5/8		S-shape	034G8809			Multi-pack 12 pcs
Orifice Ø6.5	5/8		Linear	034G8810	114.2 kW	103.2 kW	Multi-pack 12 pcs
	5/8		S-shape	034G8811			Multi-pack 12 pcs
	5/8		S-shape	034G8811			Multi-pack 12 pcs

Coil, ordering codes

Coils for ETS 8M are dedicated for the product

Table 11: Uni-polar coils for ETS 8M

Valve type	Connection size		Electrical connector	Code no.	Packing
	[m]	[in]			
ETS 8M	2	78.7	JST XHP-5	034G8300	Multi-pack 12 pcs
ETS 8M	3	118.1	JST XHP-5	034G8301	Multi-pack 12 pcs
ETS 8M	6	236.2	JST XHP-5	034G8302	Multi-pack 12 pcs
ETS 8M	2	78.7	JST XHP-6	034G8303	Multi-pack 12 pcs
ETS 8M	3	118.1	JST XHP-6	034G8304	Multi-pack 12 pcs
ETS 8M	6	236.2	JST XHP-6	034G8305	Multi-pack 12 pcs

Bi-polar coils for ETS 8M

Table 12: Bi-polar coils for ETS 8M

Valve type	Cable length		Electrical connector	Code no.	Packing
	[m]	[in]			
ETS 8M	2	78.74	Pitch 3.5mm	034G8350	Multi-pack 12 pcs
ETS 8M	3	118.11	Pitch 3.5mm	034G8351	Multi-pack 12 pcs
ETS 8M	6	236.22	Pitch 3.5mm	034G8352	Multi-pack 12 pcs

Product identification

Relevant product data is available on the product label.

Figure 8: Product label, ETS 8M valve body

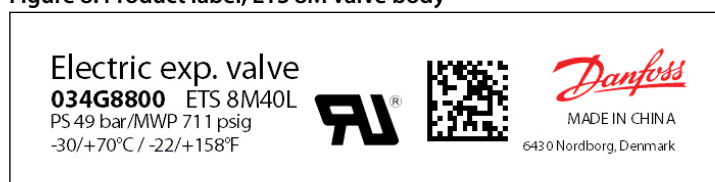

Table 13: Valve body, ETS 8M

Description	Explanation
Electric exp. Valve	Product name
034G8800	Code no.
ETS 8M40L	Product type
PS 49 bar/MWP 711 psig	Max. working pressure
-30/+70°C / -22/+158°F	Refrigerant temperature
MADE IN CHINA	Country of origin
6430 Nordborg, Denmark	Manufacturer address
Data matrix symbol	Machine readable data matrix

Figure 9: Coil marking, ETS 8M



Table 14: Coil, ETS 8M

Description	Explanation
MADE IN CHINA	Country of origin
Coil for ETS 8M	Product type
034G8300	Code no.
12V DC	Rated voltage
S/N: JS2121A12588	Serial no.
Danfoss A/S, 6430 Nordborg, Denmark	Manufacturer address
Data matrix symbol	Machine readable data matrix

Certificates, declarations and approvals



The list contains all certificates, declarations, and approvals for this product type. Individual code number may have some or all of these approvals, and certain local approvals may not appear on the list.

Some approvals may change over time. You can check the most current status at danfoss.com or contact your local Danfoss representative if you have any questions.

Approval

ETS 8M complies with:

Table 15: Compliance table ETS 8M

	Pressure Equipment Directive
RoHS	Restriction of Hazardous Substances
	Registration, Evaluation, Authorisation and Restriction of Chemicals
	UL 429

Online support

Danfoss offers a wide range of support along with our products, including digital product information, software, mobile apps, and expert guidance. See the possibilities below.

The Danfoss Product Store



The Danfoss Product Store is your one-stop shop for everything product related—no matter where you are in the world or what area of the cooling industry you work in. Get quick access to essential information like product specs, code numbers, technical documentation, certifications, accessories, and more.

Start browsing at store.danfoss.com.

Find technical documentation



Find the technical documentation you need to get your project up and running. Get direct access to our official collection of data sheets, certificates and declarations, manuals and guides, 3D models and drawings, case stories, brochures, and much more.

Start searching now at www.danfoss.com/en/service-and-support/documentation.

Danfoss Learning



Danfoss Learning is a free online learning platform. It features courses and materials specifically designed to help engineers, installers, service technicians, and wholesalers better understand the products, applications, industry topics, and trends that will help you do your job better.

Create your Danfoss Learning account for free at www.danfoss.com/en/service-and-support/learning.

Get local information and support



Local Danfoss websites are the main sources for help and information about our company and products. Find product availability, get the latest regional news, or connect with a nearby expert—all in your own language.

Find your local Danfoss website here: www.danfoss.com/en/choose-region.

Spare Parts



Get access to the Danfoss spare parts and service kit catalog right from your smartphone. The app contains a wide range of components for air conditioning and refrigeration applications, such as valves, strainers, pressure switches, and sensors.

Download the Spare Parts app for free at www.danfoss.com/en/service-and-support/downloads.

Danfoss A/S

Climate Solutions • danfoss.com • +45 7488 2222

Any information, including, but not limited to information on selection of product, its application or use, product design, weight, dimensions, capacity or any other technical data in product manuals, catalogues descriptions, advertisements, etc. and whether made available in writing, orally, electronically, online or via download, shall be considered informative, and is only binding if and to the extent, explicit reference is made in a quotation or order confirmation. Danfoss cannot accept any responsibility for possible errors in catalogues, brochures, videos and other material. Danfoss reserves the right to alter its products without notice. This also applies to products ordered but not delivered provided that such alterations can be made without changes to form, fit or function of the product.

All trademarks in this material are property of Danfoss A/S or Danfoss group companies. Danfoss and the Danfoss logo are trademarks of Danfoss A/S. All rights reserved.