

Data Sheet

CTM Low pressure valve
Type **CTM 6**

Improves COP and lowers swept volume of the MT compressors in CO₂ booster systems



Danfoss Multi Ejector Solution™, consists of a CTM 6 Low Pressure valve and an AK-PC 782A controller. This solution makes CO₂ refrigeration systems economically competitive with the HFC systems at all ambient temperatures by improving COP in comparison to standard booster systems.

CO₂ systems with Multi Ejector Solution™ can be installed in any climate delivering lower energy consumption than i.e. R404A.

CTM 6 LP is designed for CO₂ booster systems to lift a part of the gas from MT suction and mix it with the gas coming from the gas cooler at medium pressure level.

Features

First Cost savings

- Lower cost compared to parallel compression transcritical CO₂ packs due to lower swept volume of compressors. (i.e. smaller compressors or less number of compressors).
- Reliable and robust design
- Fully integrated solution not requiring any additional components like check valves or motorized ball valves
- Fully serviceable - wide range of spare parts and accessories
- Easily accessible strainer / filter for fast maintenance
- DST P310 pressure transmitters integrated
- Brings first cost savings
 - High pressure valve becomes redundant
 - Enables 15 - 35 % savings on compressor swept volume, compared to booster systems without Multi Ejector systems

Fast Pay Back – Energy saving

- Improved COP, enhanced operation of parallel compressors and lower swept volume to the MT compressors , resulting in lower energy consumption.
- Savings for end users
- Fast payback – lower energy consumption
 - Less compressors and higher efficiency on the systems, leads to payback time of less than 2 years on average globally.
- The combination of CTM 6 Low Pressure and the AK-PC 782A ensure an easy setup and commissioning, robust control of the system that ensures many years of problem free operation.

Functions

The Multi Ejector function

Figure 1: The Multi Ejector function

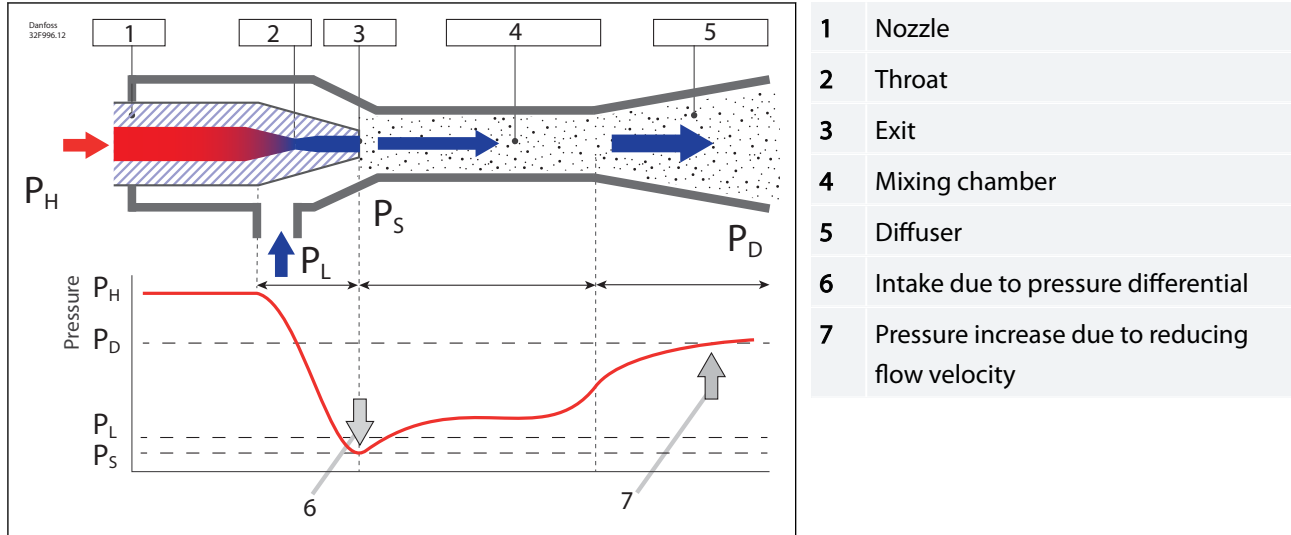

An ejector is a device that uses expansion energy to compress another fluid. In this case with the transcritical system there is up to 20% of the compressor work that can theoretically be recovered in the expansion.

In this case with the Multi Ejector system the work is coming from the CO_2 leaving the gas cooler. The high pressure CO_2 (P_H) is entering the nozzle where the expansion is taking place. At the exit of the nozzle the speed is very high and as a consequence of that the pressure is low.

This low pressure is used to drag liquid from the MT suction accumulator (P_L). From there the two flows are mixed in the mixing chamber where the pressure will be lower than at the drive inlet due to the mixing of vapour from a higher pressure.

After the mixing the flow enters the diffuser where the flow is slowed down. The shape of the diffuser enables the conversion from kinetic energy (velocity) to potential energy (pressure). After the diffuser the flow is returned to the receiver.

Applications

The Multi Ejector is designed to lift a part of the gas from MT suction and mix it with the gas coming from the gas cooler at medium pressure level. Pre-compressed gas is taken from the receiver to parallel compressor which works more efficiently due to lower pressure lift required.

Figure 2: Application

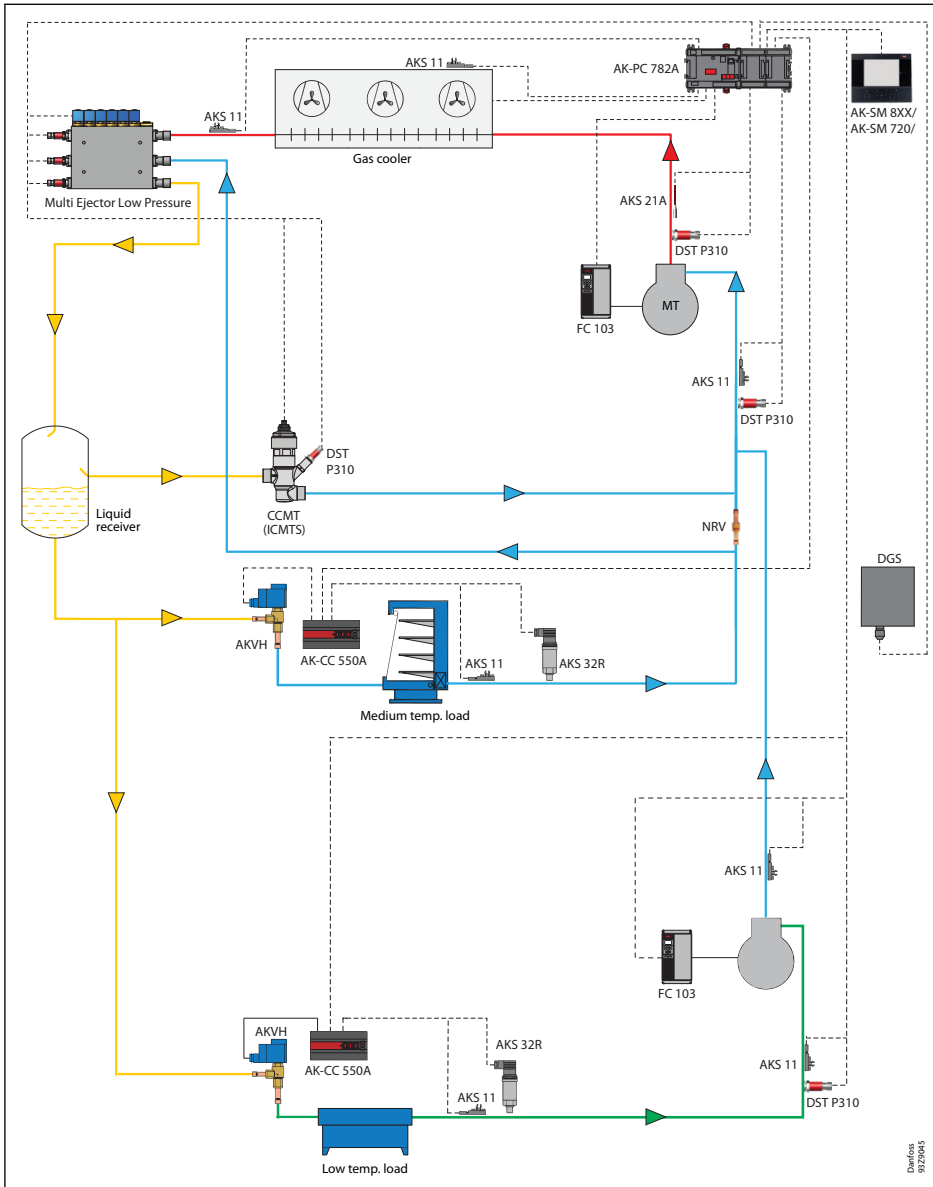

	HP High Pressure (120-140 bar Max working pressure)
	HP Receiver Pressure (60-90 bar Max working pressure)
	LP Suction Pressure MT (35-55 bar Max working pressure)
	LP Suction Pressure LT (25-30 bar Max working pressure)

Media**Technical data****Table 1: Technical data**

Refrigerant	R744 with oil
Maximum working pressure	140 bar / 2031 psi
Max. test pressure	1.43 x 140 bar / 1.43 x 2031 psi
Max. OPD	90 bar / 1305 psi (for single-voltage coil, 50 Hz)
Min. OPD	< 0.1 bar / 1.45 psi
Max. pres. dif. E and C connections	20 bar / 290 psi
Media temp. range	-10 °C – +50 °C / +14 °F – 122 °F
Ambient temp. range	-10 °C – +50 °C / +14 °F – 122 °F
Humidity	0 – 100% R.H. (0-97% R.H. non-condensation condition if IP level is below IPX5)

Product specification

Material specification

Table 2: Material specification

Housing	Aluminium AW-6082 T6
Connections	Stainless steel AISI 304
Ejectors	Brass
Screws	Stainless steel A2-70

Dimensions and weights

Figure 3: CTM 6 (Weight: 9.1 Kg / 20.1 lb)

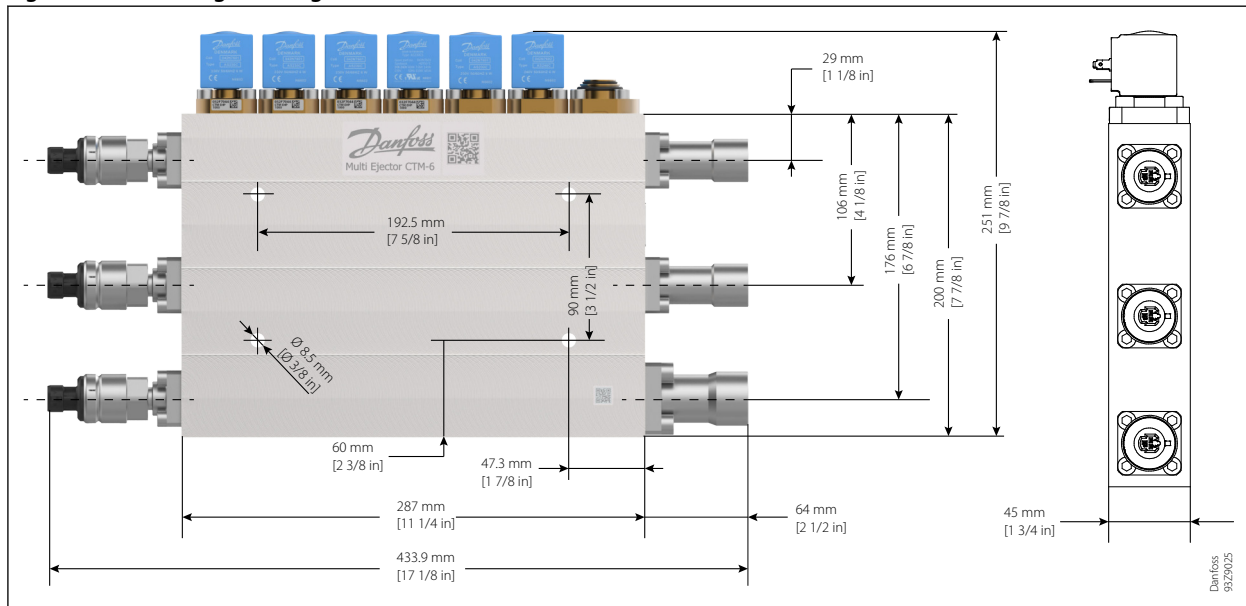

Connector positions

Figure 4: Connector positions

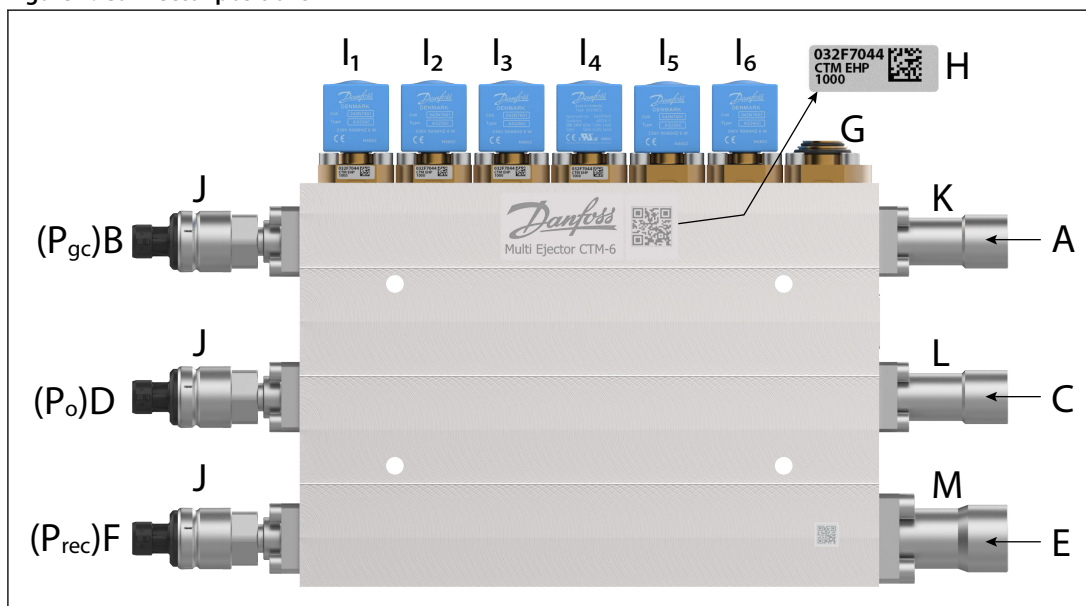

CTM Low pressure valve, type CTM 6

A	Gas cooler outlet - Ball valve - inlet connector Combi brazing 7/8 inch ODF - weld 3/4 inch (EN10220)	F	Outlet measurement port G 7/16 inch - 20 UNF
B	Inlet measurement port G 7/16 inch - 20 UNF	G	Strainer
C	Suction connector. MT evaporator outlet - Ball valve - suction connector. Combi brazing 7/8 inch ODF - weld 3/4 inch (EN10220)	H	Label
D	Suction measurement port G 7/16 inch - 20 UNF	I	Ejector
E	Common outlet connector - Ball valve - Receiver Combi brazing 1 1/8 inch ODF - weld 1 inch (EN10220)	J	Pressure transmitter DST P310 (076G1021)
		K	High pressure inlet
		L	Suction inlet
		M	Receiver

Mounting order of ejectors:

Ejectors with the highest capacities (longest ejectors) must be placed closest to the suction connector C. Any blank ejector should be placed after the ejectors.

Ordering

Valve configuration

Figure 5: Valve configuration

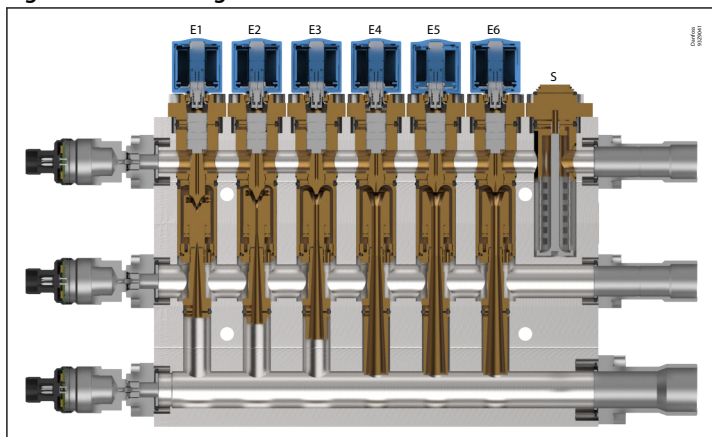

E	Ejector
S	Strainer

Table 3: Valve configuration

Type	Code no.	Product name	Ejector 1	Ejector 2	Ejector 3	Ejector 4	Ejector 5	Ejector 6
CTM 6	032F5678	CTM Multi Ejector LP 935	CTM ELP 60	CTM ELP 125	CTM ELP 250	CTM ELP 500	Blank ejector	Blank ejector
CTM 6	032F5693	CTM Multi Ejector LP 1435	CTM ELP 60	CTM ELP 125	CTM ELP 250	CTM ELP 500	CTM ELP 500	Blank ejector
CTM 6	032F5679	CTM Multi Ejector LP 1935	CTM ELP 60	CTM ELP 125	CTM ELP 250	CTM ELP 500	CTM ELP 500	CTM ELP 500

Multi Ejector

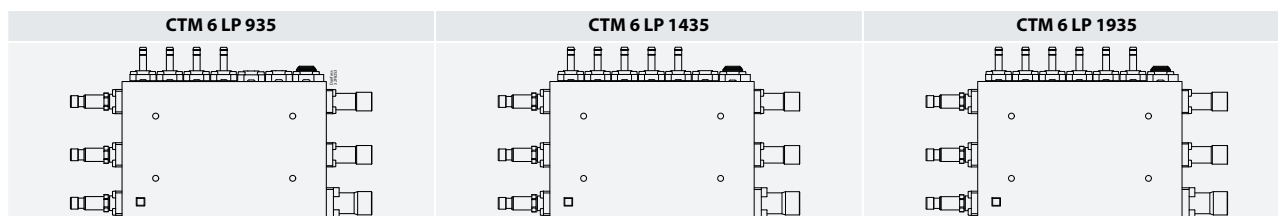

Table 4: Multi Ejector CTM 6

Type	Capacity - Mass flow ⁽¹⁾		Code no. Single pack
	[kg/h]	[lb/h]	
CTM 6 LP 935	935	2061	032F5678
CTM 6 LP 1435	1435	3164	032F5693
CTM 6 LP 1935	1935	4266	032F5679

⁽¹⁾ R744 at 90 bar / 35 °C

⁽²⁾ R744 at 1305 psi /95 °F

(LP = Low Pressure lift)

(The above code numbers are without coils which should be ordered separately – see coil ordering below).

Accessories

Spare parts

Table 5: Ejectors

Image	Part	Type	Capacity - HP Mass flow 1		Description	Code no. Single pack
			[kg/h]	[lb/h]		
	Ejectors	CTM ELP 60	60	132.3	1. Completely assembled ejector with O-rings already mounted	032F9106
		CTM ELP 125	125	275.5	1. Completely assembled ejector with O-rings already mounted	032F9107
		CTM ELP 250	250	551.0	1. Completely assembled ejector with O-rings already mounted	032F9108
		CTM ELP 500	500	1102	1. Completely assembled ejector with O-rings already mounted	032F9109
		CTM Blank ejector	-	-	1. Completely assembled blank ejector with O-rings already mounted	032F9112

Table 6: Strainer, O-rings and Connectors

Image	Part	Type	Description	Code no. Single pack
X 1	Strainer	CTM strainer	1. Mesh only	032F9113
X 2			2. 2 sets of 2 O-rings	
X 6	O-rings	CTM O-rings	1. 2 sets of 2 O-rings for strainer 2. 6 sets of 3 O-rings for ejectors	032F9114
	Connectors	DN 20	Connector + O-ring	032F9116
		DN 25	Connector + O-ring	032F9117

Table 7: Pressure transmitter and Cable

Image	Part	Type	Description	Code no.
	Pressure transmitter	DST P310	Pressure transmitter with O-ring	076G1021
	Cable	-	10 meter cable for pressure transmitter	064G0950

Coils

Table 8: DIN spade connection

Image	Type	Voltage	Frequency / Power consumption				Code no. Single pack
		[V]	[Hz]	[W]	[Hz]	[W]	with DIN plug ⁽¹⁾
	AS230CS	230	50	8	60	7	042N7601
	AZ120CS	110 - 120	50	8.5	60	7	042N4202

⁽¹⁾ The three pins on the coil can be fitted with spade tabs, 6.3 mm wide (to DIN 46247). The two current carrying pins can also be fitted with spade tabs, 4.8 mm wide. Max. lead cross section: 1.5 mm². Voltage variation: V AC -15% - 10%, If DIN plug is used (DIN 43650) the leads must be connected in the socket. The socket is fitted with a Pg 11 screwed entry for 6 – 12 mm.

Plug for DIN spade connection

Table 9: Plug for DIN spade connection

Image	Type	Voltage [V]	Frequency	Code no. Single pack
	DIN plug (LED)	230	50 / 60	042N0265 ⁽¹⁾
	DIN plug	Max. 250	50 / 60	042N0156

⁽¹⁾ Only for AS230CS

Controller AK-PC 782A



Danfoss offers a wide range of market leading Pack Controllers. Being the flag ship and best in class controller for transcritical CO₂ packs controls, the AK-PC 782A offers the highest possible efficiency with the Multi Ejector, CTM.

The complete application control features:

- Complete booster pack control of up to 3 suction groups (max. 12 compressors) and high pressure system
- Significant savings with heat recovery for Tap Water and heat reclaim
- Extensive control of oil flow and pressurization
- Best in class safety monitoring and fail-safe functions
- Minimal energy consumption while ensuring optimal food quality
- Auto-configured, easy-to-use graphical representation with Danfoss System Manager
- Independent, customised control and monitoring of auxiliary function

Temperature sensors and pressure transmitters



Danfoss offers a comprehensive range of sensors for temperature and pressure sensors developed to meet the requirements of the entire pack application.

The sensor range delivers the following key features and benefits:

- Long term reliability minimize system downtime.
- Robust construction protects against mechanical shock and vibration.
- Temperature sensor design ensures fast response time and precise measurement.
- Hermetically sealed pressure element ensures no leakage.
- Pressure transmitter output calibrated for perfect fit to the application.
- Pulse snubber ensures protection against liquid hammering, cavitation or pressure peaks.

Disclaimer

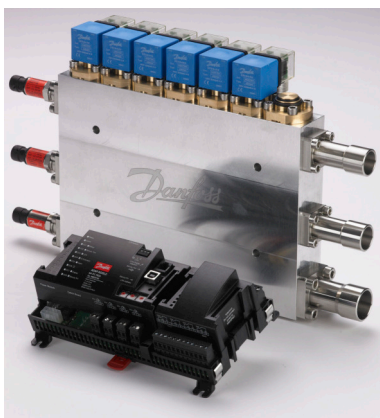

CTM Low pressure valve, type CTM 6

⚠ WARNING:

The CTM Multi Ejector valve is approved for use only with Danfoss pack controller type AK-PC 78x.

Danfoss expressly disclaims, and any responsibility or liability, whether based on contract, breach of warranty, tort, statute or otherwise, shall be excluded, if the CTM Multi Ejector valve is used with any controller other than a Danfoss controller type AK-PC 78x.

For further information on AK-PC, please see separate document.

Certificates, declarations, and approvals

The list contains all certificates, declarations, and approvals for this product type. Individual code number may have some or all of these approvals, and certain local approvals may not appear on the list.

Some approvals may change over time. You can check the most current status at danfoss.com or contact your local Danfoss representative if you have any questions.

Certificates, declarations, and approvals

Table 10: Certificates, declarations, and approvals

File name	Document type	Document topic	Approval authority
Danfoss 032F9627.AA	Manufacturers Declaration	PED	Danfoss
UL SA45046	Mechanical - Safety Certificate	-	UL

AS230CS: LLC CDC TYSK; The Low Voltage Directive 2014/35/EU (LVD);
Electromagnetic Compatibility Directive 2014/30/EU (EMC)

AZ120CS: C UR US; LLC CDC TYSK; The Low Voltage Directive 2014/35/EU (LVD);
Electromagnetic Compatibility Directive 2014/30/EU (EMC)

Online support

Danfoss offers a wide range of support along with our products, including digital product information, software, mobile apps, and expert guidance. See the possibilities below.

The Danfoss Product Store



The Danfoss Product Store is your one-stop shop for everything product related—no matter where you are in the world or what area of the cooling industry you work in. Get quick access to essential information like product specs, code numbers, technical documentation, certifications, accessories, and more.

Start browsing at store.danfoss.com.

Find technical documentation



Find the technical documentation you need to get your project up and running. Get direct access to our official collection of data sheets, certificates and declarations, manuals and guides, 3D models and drawings, case stories, brochures, and much more.

Start searching now at www.danfoss.com/en/service-and-support/documentation.

Danfoss Learning



Danfoss Learning is a free online learning platform. It features courses and materials specifically designed to help engineers, installers, service technicians, and wholesalers better understand the products, applications, industry topics, and trends that will help you do your job better.

Create your Danfoss Learning account for free at www.danfoss.com/en/service-and-support/learning.

Get local information and support



Local Danfoss websites are the main sources for help and information about our company and products. Find product availability, get the latest regional news, or connect with a nearby expert—all in your own language.

Find your local Danfoss website here: www.danfoss.com/en/choose-region.

Coolselector®2 - find the best components for you HVAC/R system



Coolselector®2 makes it easy for engineers, consultants, and designers to find and order the best components for refrigeration and air conditioning systems. Run calculations based on your operating conditions and then choose the best setup for your system design.

Download Coolselector®2 for free at coolselector.danfoss.com.

Danfoss A/S

Climate Solutions • danfoss.com • +45 7488 2222

Any information, including, but not limited to information on selection of product, its application or use, product design, weight, dimensions, capacity or any other technical data in product manuals, catalogues descriptions, advertisements, etc. and whether made available in writing, orally, electronically, online or via download, shall be considered informative, and is only binding if and to the extent, explicit reference is made in a quotation or order confirmation. Danfoss cannot accept any responsibility for possible errors in catalogues, brochures, videos and other material. Danfoss reserves the right to alter its products without notice. This also applies to products ordered but not delivered provided that such alterations can be made without changes to form, fit or function of the product.

All trademarks in this material are property of Danfoss A/S or Danfoss group companies. Danfoss and the Danfoss logo are trademarks of Danfoss A/S. All rights reserved.