



Domestic Hot Water

Application guide



Table of content

1. Application overview	4
2. System Description	5
3. System design	7
3.1 Heat loss calculation	7
3.2 Product selection	9
3.2.1 Heating cable selection	9
3.2.2 Thermostat/Controller selection	11
3.2.3 Accessories selection	14
4. Safety instruction	18
4.1 DO's	18
4.2 DON'Ts	18
5. Case stories	19
6. Technical support	19

Let DEVI do the work

DEVI - an abbreviation of Dansk El-Varme Industri - was established in Copenhagen, Denmark, in 1942. As from January 1st 2003 DEVI has become a part of the Danfoss Group - Denmark's largest industrial Group. Danfoss is one of the world's leading companies within heating, cooling and air-conditioning. The Danfoss Group has more than 23.000 employees and serves customers in more than 100 countries.

DEVI is Europe's leading brand of electric cable heating systems and electric pipe heating systems with over 70 years of experience. The development of electric floor heating system takes place in Denmark, where the head office is situated while heating elements (cables and mats) are manufactured by Danfoss in EU.

Domestic Hot Water temperature maintenance system

This design guide presents DEVI's recommendations for design and installation of Domestic Hot Water system. It provides guidance for a heating cable layout, electric data and system configurations.

Following DEVI's recommendations will ensure energy efficient, reliable and maintenance free solution for constant wattage heating cables with 20 year warranty, self-limiting heating cables with 5 years of warranty.

Our quality management system **certifications and compliances**

✓ ISO 9001 ✓ TS 16949

✓ ISO 14001

Along with full compliance with EU directives and product approvals



1. Application overview

Modern living requires buildings to have hot water available whenever and wherever needed – and preferably immediately. The building regulations demand domestic hot water systems to ensure best comfort and efficiency as well as the Legionella control measures.

DEVIhotwatt™ systems ensure continuous and reliable supply of with the possibility to disinfect Domestic Hot Water (DHW). DEVIhotwatt™ is a self-limiting heating cable that is used for temperature maintenance of hot water supply.

DEVIhotwatt™ systems compliments domestic hot water systems and enables the unique possibility to temperature control and disinfect, both for circulation systems and uniquely also for single pipe systems from source to tap.

DEVIhotwatt™ systems complies with IEC 62395-2:2013.

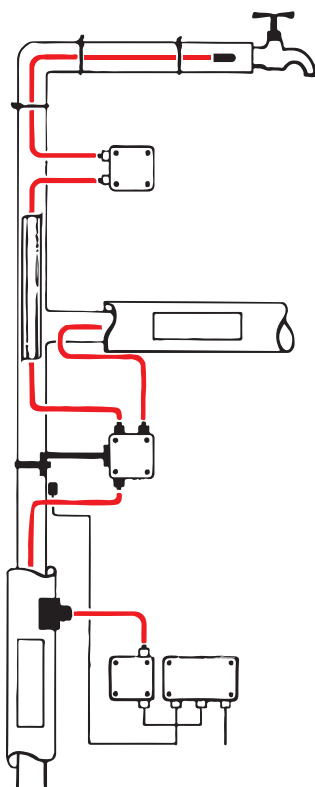

Benefits

- **Unique opportunity** - allows the installation of a single pipe hot-water system, that includes thermally controlled and disinfected hot water at the tap.
- **Lower initial investment** the electric pipe tracing in DHW system without circulation requires less pipes and insulation (approximately 50%), less valves, less pumps and installation labor compared to the recirculating system.
- DEVI pipe tracing systems **ensure hot water** in all taps and savings when a circulating pipe system is unnecessary.
- DEVI heating cable **reduces water waste** as you can get hot water immediately.
- **Protection against Legionella** – DEVI system maintains water supply at the required temperature level and provides disinfection to combat the bacteria.
- DEVIhotwatt™ system is the Perfect solution to be used in domestic hot water systems. Including systems supplied by low temperature district heating.
- **Energy efficient** - Self limiting heating cables provide power where needed, adapting their output according to the ambient temperature. Less pipes and smaller boilers will in term mean lower heat losses.
- The heating cable is **flexible and easy to install** as it can be cut to length, right on site and installed directly on the pipe system.

2. System Description

Since 1998 the EU Drinking Water Directive (98/83/EG) in EN 806-2 has established standards for hot water in pipes that should not drop below 50 °C. The building regulations as well as global trends are demanding DHW systems to provide the best comfort, energy efficiency and the Legionella mitigation measures.

General design principles aim to provide uniform water temperature, which should also enable temperatures to combat Legionella growth. **The general recommendation for DHW is to maintain the heat source temperature between 50-60 °C (IEC 62395-2:2013).**

Water heating is provided by centralized or decentralized sources, Centralized water heating systems (district heating) often have large distribution network that might contribute to temperature inconsistencies. **According to IEC 62395-2:2013 guidelines: "For disinfection purposes min 55 °C is typically required for hot water installations fitted with mixing valves".**

In the case that the water temperature of DHW systems cannot achieve the recommended level, risks of possible water waste and Legionella will arise, therefore a supplementary electrical tracing system is recommended.

The Legionella bacteria which is commonly found in many types of water worldwide. The bacteria can create a potentially fatal type of pneumonia commonly by inhalation.

The Legionella bacteria multiply best where temperatures are between 20-45 °C and nutrients are available. A method used to reduce the risk from the Legionella bacteria, is to control the water temperature, which is easy to do with help of DEVI pipe heating system .

The DEVI pipe heating system for DHW, maintains the water at the desired nominal temperatures or heats (disinfects) it when needed.

DEVI Pipe tracing systems will be required in the following cases:

- Low-temperature, heat source is supplying DHW at lower than 50 °C
- The ambient temperature variation is significant
- Tap is located so far away that the hot water temperature is not properly maintained

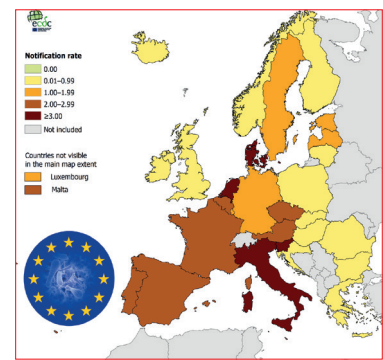
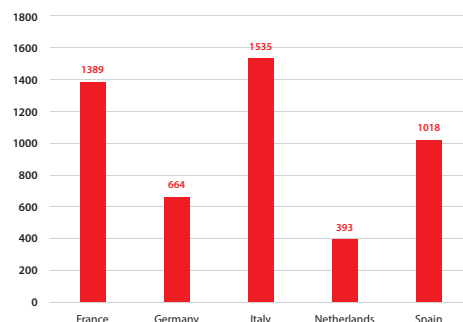

Temperature and disinfection time

Temperature of disinfection [°C]	Time settings for thermal disinfection
	Recommended
55	2 h 00 minute
60	0 h 40 minute
65	0 h 26 minute
70	0 h 20 minute
75	0 h 10 minute

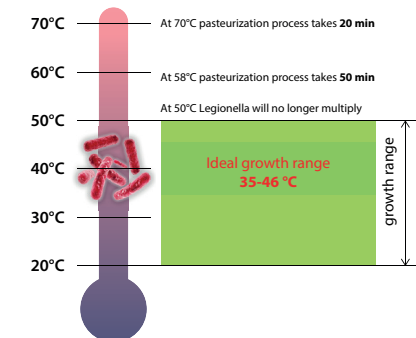

Heat tracing in DHW (Domestic Hot Water) systems

DHW system, single pipe system

(without circulation) - the cable modifies its output and thereby temperature according to the conditions along the installation. This means that the DHW system is heated corresponding to heat losses, thus maintaining and/or controlling the temperature.

The more often the hot water tap is turned on, the less the hot water temperature maintenance system needs to be activated assuming a water supply with a higher or equal temperature to the respective requirement.

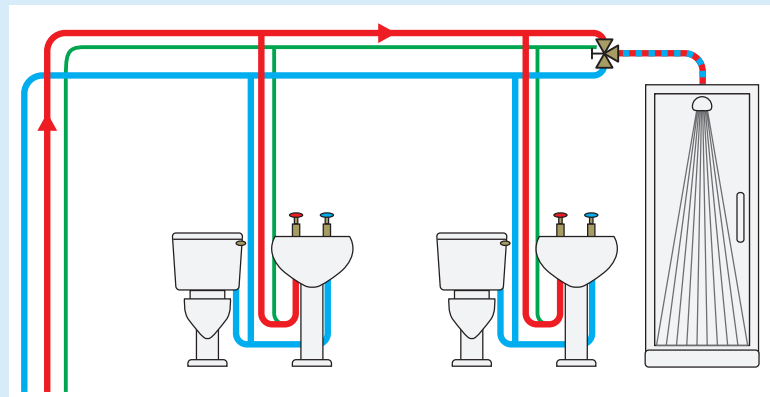

— Self-limiting heating cable

DHW system with circulation -

continuous circulation of hot water to ensure that hot water is available at any of the taps.

In case of DHW with circulation - pipe tracing can be installed to ensure loop temperature. Thereby aiding the system to maintain temperatures at the required level.

DHW systems can also be installed to secure pipes where circulation can't be provided to ensure the wanted/ needed temperature.

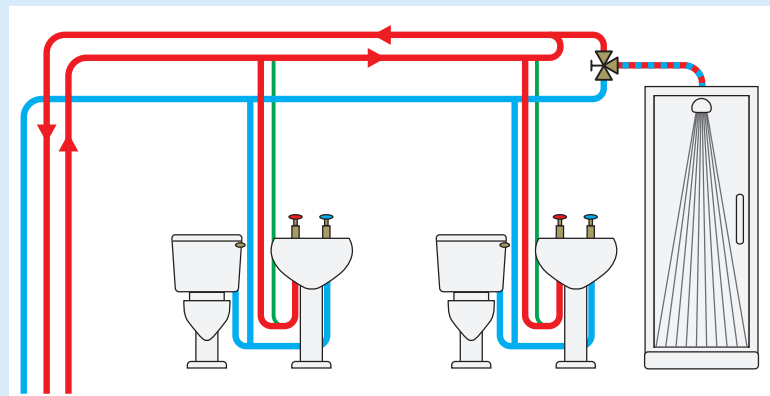

— Self-limiting heating cable

The DEVIhotwatt™ pipe tracing in DHW system without circulation requires less pipes, less valves, less pumps and installation labor compared to the Recirculating system.

- Approximately 50% less pipes – less water volume in the pipes, thus smaller boiler can be used.
- Energy consumption reduction, as heat losses from the pipes will be reduced by a significant amount.

- Less maintenance cost, as less mechanical parts and pumps.
- Saving water – DEVI pipe heating system attached to the pipes keeps water at the desired temperature along the pipe system, so hot water is immediately provided, when demanded, and with minimum water loss.

The DEVI pipe heating system insures that DHW is supplied, independent of

the pipes length, and reduces the risk of localized temperature fluctuations by heating only where needed.

DEVI pipe heating system is insuring automatic maintenance of the required temperature 24/7.

3. System design

Following pages provide an easy design guide for selection of a Domestic hot water system. The recommendations are provided relates to self-limiting cables, as well as thermostats and accessories.

3.1 Heat loss calculation

Linear output of a heating cable (W/m), which is installed on hot water pipe, should be at least the same as heat loss (Q, W/m) of the pipe. Heat loss depends on the following: pipe diameter, insulation thickness, temperature inside pipe and ambient/surrounding temperature.

Increased heat loss can lead to the necessity of installing 2 or more lines

of heating cable along 1 pipe length or a higher W/m cable.

Heat and losses of pipe systems [W/m]

The table below shows the heat loss for 1 meter of pipe (q_{pipe}) for various pipe dimensions, insulation thicknesses and temperatures.

To define the heat loss follow the pipe diameter (in [mm] or [inch]) at the top bar of the table towards the row with the insulation thickness and using the appropriate temperature difference you will find the heat loss value at the crossing point. For this table λ of insulation material is 0,04 W/m-K (e.g. mineral wool) and safety factor is 1,3.

Required minimal outputs in [W/m], for straight pipelines (without flanges, valves or T-branches).

Inside pipe diameter	inch (NPS*)	½	¾	1	1¼	1½	2	2½	3	3½	4	4½	5	6	8	10	12
	mm (DN*)	15	20	25	32	40	50	65	80	90	100	115	125	150	200	250	300
Outside pipe diameter*	mm	21	27	34	42	48	60	73	89	102	114	127	141	168	219	273	324
Insulation thickness	$\Delta T, ^\circ C$	Heat loss for 1 meter of pipe, W/m ($\lambda = 0,04$, Safety factor = 1,3)															
10 mm	20	9,8	11,8	14,1	16,8	18,8	22,7	27,0	32	36	40	45	49	58	75	92	109
	25	12,2	14,7	17,6	21,0	23,4	28,4	34	40	46	51	56	62	73	93	115	136
	30	14,6	17,7	21,2	25,2	28,1	34	40	48	55	61	67	74	87	112	139	164
	40	19,5	23,6	28,2	34	38	45	54	64	73	81	89	98	116	149	185	218
	60	29,3	35	42	50	56	68	81	97	109	121	134	148	174	224	277	327
	80	39,0	47	56	67	75	91	108	129	146	162	179	197	232	299	370	436
20 mm	20	6,1	7,2	8,4	9,8	10,8	12,8	14,9	17,6	19,7	21,7	23,9	26,2	31	39	48	56
	25	7,7	9,0	10,5	12,2	13,5	16,0	18,7	22,0	24,7	27,1	30	33	38	49	60	70
	30	9,2	10,8	12,6	14,6	16,2	19,2	22,4	26,4	30	33	36	39	46	58	72	84
	40	12,2	14,4	16,8	19,5	21,6	25,6	30	35	39	43	48	52	61	78	96	112
	60	18,4	21,6	25,2	29,3	32	38	45	53	59	65	72	78	92	117	143	168
	80	24,5	28,7	34	39	43	51	60	70	79	87	95	105	122	156	191	224
30 mm	20	4,8	5,6	6,4	7,4	8,1	9,4	10,9	12,7	14,1	15,4	16,9	18,4	21,4	27,0	33	38
	25	6,0	7,0	8,0	9,2	10,1	11,8	13,6	15,8	17,6	19,3	21,1	23,0	26,7	34	41	48
	30	7,3	8,4	9,6	11,0	12,1	14,1	16,3	19,0	21,2	23,2	25,3	27,6	32	40	49	58
	40	9,7	11,2	12,8	14,7	16,1	18,8	21,8	25,3	28,2	31	34	37	43	54	66	77
	60	14,5	16,7	19,3	22,1	24,2	28,3	33	38	42	46	51	55	64	81	99	115
	80	19,4	22,3	25,7	29,4	32	38	44	51	56	62	68	74	86	108	131	154
40 mm	20	4,2	4,7	5,4	6,1	6,7	7,7	8,8	10,2	11,3	12,3	13,4	14,5	16,8	21,0	25,4	29,6
	25	5,2	5,9	6,7	7,7	8,3	9,6	11,0	12,7	14,1	15,4	16,7	18,2	21,0	26,2	32	37
	30	6,2	7,1	8,1	9,2	10,0	11,6	13,2	15,3	16,9	18,4	20,1	21,8	25,2	31	38	44
	40	8,3	9,5	10,8	12,2	13,3	15,4	17,7	20,4	22,6	24,6	26,7	29,1	34	42	51	59
	60	12,5	14,2	16,2	18,4	20,0	23,1	26,5	31	34	37	40	44	50	63	76	89
	80	16,6	19,0	21,6	24,5	26,6	31	35	41	45	49	53	58	67	84	102	118
50 mm	20	3,7	4,2	4,8	5,4	5,8	6,7	7,6	8,7	9,6	10,4	11,2	12,2	14,0	17,4	20,9	24,3
	25	4,7	5,3	6,0	6,7	7,3	8,3	9,5	10,8	11,9	13,0	14,1	15,2	17,5	21,7	26,2	30,4
	30	5,6	6,3	7,1	8,0	8,7	10,0	11,4	13,0	14,3	15,6	16,9	18,3	21,0	26,0	31	36
	40	7,5	8,4	9,5	10,7	11,6	13,3	15,1	17,3	19,1	20,7	22,5	24,4	28,0	35	42	49
	60	11,2	12,7	14,3	16,1	17,4	20,0	22,7	26,0	28,7	31	34	37	42	52	63	73
	80	14,9	16,9	19,0	21,4	23,2	26,6	30	35	38	41	45	49	56	69	84	97
75 mm	20	3,1	3,5	3,9	4,3	4,6	5,2	5,8	6,6	7,2	7,8	8,4	9,0	10,2	12,5	14,9	17,2
	25	3,9	4,3	4,8	5,4	5,8	6,5	7,3	8,3	9,0	9,7	10,5	11,3	12,8	15,6	18,6	21,5
	30	4,7	5,2	5,8	6,4	6,9	7,8	8,8	9,9	10,8	11,7	12,6	13,5	15,4	18,8	22,4	25,7
	40	6,2	6,9	7,7	8,6	9,2	10,4	11,7	13,2	14,4	15,6	16,8	18,0	20,5	25,0	29,8	34
	60	9,3	10,4	11,6	12,9	13,8	15,6	17,5	19,8	21,7	23,3	25,1	27,0	31	38	45	51
	80	12,5	13,9	15,5	17,2	18,4	20,9	23,4	26,4	28,9	31	34	36	41	50	60	69
100	15,6	17,4	19,3	21,5	23,0	26,1	29,2	33	36	39	42	45	51	63	75	86	

* NPS - Nominal Pipe Size, DN - diamètre nominal/nominal diameter/Durchmesser nach Norm. Values in table can be calculated with help of formula on next page.

The most important factors to define the pipe heat losses are the following:

- Pipe diameter
- Insulation thickness
- Difference between inside (desired maintained temperature).

The following formula is used for heat losses calculation for total length of a pipe to be protected:

$$Q[W] = \frac{2 \cdot \pi \cdot \lambda \cdot l \cdot (t_a - t_p)}{\ln(D/d)} \cdot 1,3,$$

where:

- D - Outside pipe diameter incl. insulation, [m],
- d - Pipe diameter without insulation [m],
- l - Total length of pipe, [m],
- t_p - Desired maintained temperature, [°C],
- t_a - Outside temperature, [°C],
- λ - Thermal conductivity of insulation, [W/m·K],
- 1,3 - Safety factor.

λ value for standard insulation material (like glass wool or styropor), is set to 0,04 W/m·K.

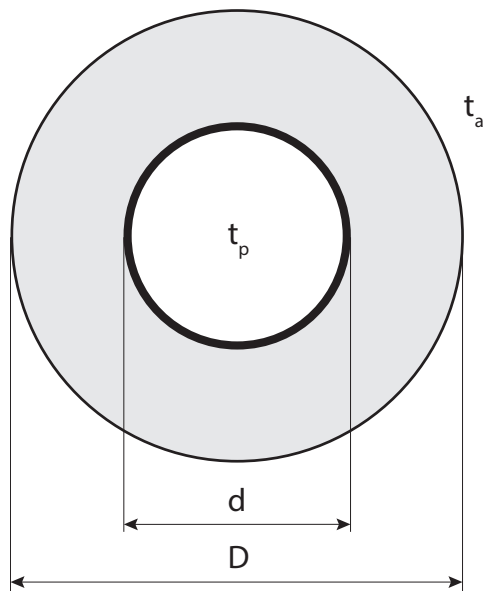

ln(D/d)	0,0	0,4	0,7	0,9	1,1	1,3	1,4	1,5	1,6	1,8	1,9	2,1	2,2	2,3	2,7	3,0	3,2
(D/d)	1,0	1,5	2,0	2,5	3,0	3,5	4,0	4,5	5,0	6,0	7,0	8,0	9,0	10,0	15,0	20,0	25,0

Heat loss values from the table on the previous page calculated by the above formula and divided by total pipe length. The obtained values are in [W/m].

Natural logarithm (ln) values for D/d ratio: $X = D/d$.

3.2 Product selection

This section will show how to choose the correct heating element, control device and what accessories to use for the installation.

3.2.1 Heating cable selection

Self-limiting cables are often used for pipe systems with many branches, because it's easier to adjust the cable length to appropriate pipe length.

The self-limiting behavior of the cables, provides output adjustment based on the temperature (pipe and ambient), this a rather useful feature. However a thermostat for self-limiting cable regulation is a must.

When choosing a self-limiting heating cable it's essential to investigate whether the heating cable can provide the required output at the desired temperature.

How to read the graph

Draw a line from the desired temperature value (X-axis) and a calculated heat loss output (Y-axis).

Afterwards find a heating cable with output values higher (Y-axis) than the cross point of temperature and output lines.

Example (values from Previous page)

- Pipe diameter $d = 25 \text{ mm}$
- Insulation thickness = 30 mm
- Thermal conductivity value for insulation $\lambda = 0,04$
- Desired temperature $t_u = +45 \text{ }^\circ\text{C}$

- Minimum outside temperature $t_o = +20 \text{ }^\circ\text{C}$

Heat loss Q is calculated by the formula of Step 1 or from the table on page 7: $Q = 8 \text{ W/m}$.

This would then prompt the choice to be DEVIhotwatt 55 for an output of 9 W/m at $55 \text{ }^\circ\text{C}$

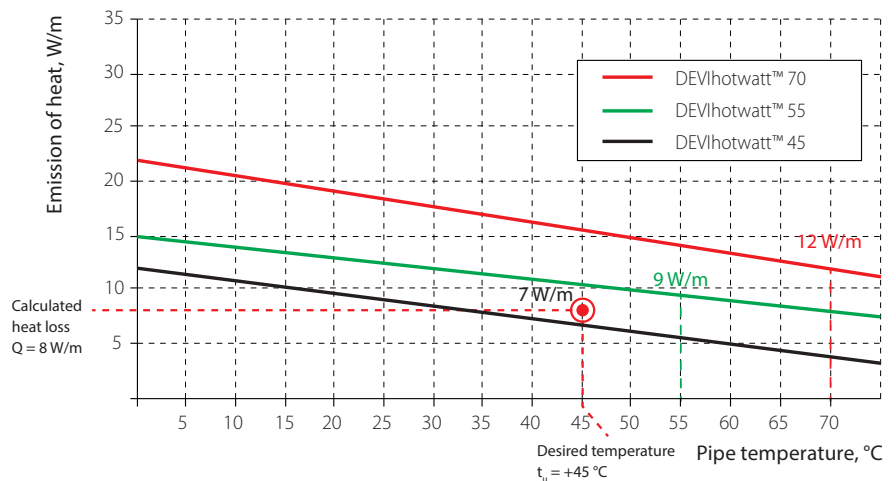

The pipe tracing system consists of a self-limiting heating cable, installed on a pipe along its whole length, and providing hot water instantly, even at faucets placed far away from pipe draw off.

The system must be controlled by an electronic regulator to maintain the temperature and to run disinfection ensuring safe and enabling the option to maintain a Legionella free water supply.

The DEVIhotwatt™ is a self-limiting heating cable that is used for temperature maintenance of hot water and other fluids which require certain temperature levels.

The self-limiting capability of the cable ensures cable output regulation according to temperature to which the cable is exposed, hence the self-limiting effect.

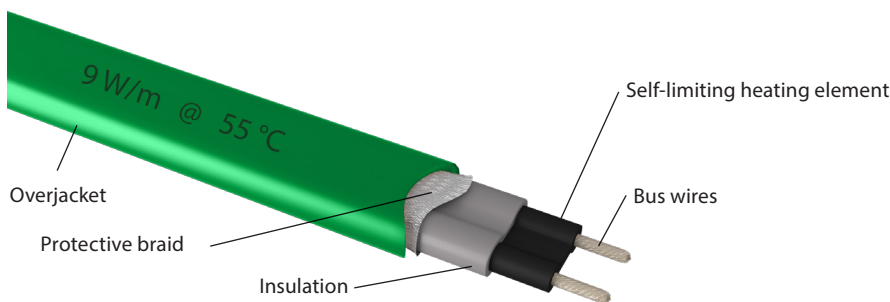

Fig. 3 - Self-limiting cable construction

- 1,3 mm² nickel plated cooper bus wires
- Radiation Cross-linked Semiconductive Heating Matrix
- Radiation Cross-linked Primary Dielectric insulation
- Tinned copper braid
- Polyolefin overjacket

DEVIhotwatt™ 45 (B), DEVIhotwatt™ 55 (B), DEVIhotwatt™ 70 (B)



The DEVIhotwatt™ is a self-limiting heating cable that is used for temperature maintenance of hot water supply and other fluids that need to maintain a certain temperature.

The self-limiting capability of the cable ensures that the output of the cable increase or decrease according to ambient temperature.

DEVIhotwatt™ ensures hot water in all taps and savings when circulation of the whole pipe system is unnecessary.

The cable is not approved for use in drinking water.

Type	Value
Nominal voltage	230 V AC
Nominal output (min-max) :	
DEVIhotwatt™ 45	7 W/m @ 45 °C (6,5-9,5 W/m @ 45 °C)
DEVIhotwatt™ 55	9 W/m @ 55 °C (8,5-13,0 W/m @ 55 °C)
DEVIhotwatt™ 70	12 W/m @ 70 °C (11,3-15,2 W/m @ 70 °C)
Outer sheath:	
DEVIhotwatt™ 45	Black, TPE
DEVIhotwatt™ 55	Green, TPE
DEVIhotwatt™ 70	Red, TPE
Maximum permissible use temperature	80 °C, powered 100 °C, unpowered
Minimum installation temperature	-50 °C
Cable dimensions	11,8 mm × 5,8 mm
Minimum braid coverage	70%
Maximum resistance protective braid	18,2 Ω/Km
Bending Ø, min.	50 mm (Ø to the inside of the tape)
Max. installation length	
- with 10 A circuit breaker	55 m
IP Class	IPX7

Maximum heating circuit length on a pipe, with circuit breaker with C-characteristic

"Circuit breaker size"	6A				10A				16A			
"start-up temperature", [°C]	-25	-10	+10	+20	-25	-10	+10	+20	-25	-10	+10	+20
DEVI-hotwatt 45	72	77	86	92	119	129	144	153	191	203	230	231
DEVI-Hotwatt 55	52	56	61	65	86	93	102	108	138	148	164	173
DEVI-Hotwatt 70	24	27	42	59	37	45	71	99	64	72	113	146

"Circuit breaker size"	20A				25A				32A			
"start-up temperature", [°C]	-25	-10	+10	+20	-25	-10	+10	+20	-25	-10	+10	+20
DEVI-hotwatt 45	231	231	231	231	231	231	231	231	231	231	231	231
DEVI-Hotwatt 55	173	185	188	188	188	188	188	188	188	188	188	188
DEVI-Hotwatt 70	80	90	142	146	103	113	146	146	133	143	146	146

Benefits

- The cables can be cut to length on site providing quick installation.
- Automatic compensation for heat loss along the pipe assuming cable has more output capability than heat loss present.
- Economical, self-limiting
- PVC free
- Limited pre-planning of the installation

3.2.2 Thermostat/Controller selection

Temperature regulation

Self-limiting heating cables require a thermostat for temperature control. The thermostat ensures maintaining desired temperature.

Domestic hot water systems are required to have sensors mounted on each hot water pipe system to ensure proper control.

If the size of the heating cable exceeds the maximum limit defined by the thermostat or fuse.

The load of the heating cables can be distributed by means of external relays / contactors or by use of the multiple relays within the DEVireg Hotwater controller. In such installations, one thermostat can regulate several heating elements.

When load distributing, please do not exceed maximum cable lengths mentioned on step 10.

Temperature regulation using on-pipe sensors

This type of installation, where the sensor is placed directly on pipe under insulation, is more precise and energy efficient way of regulation.

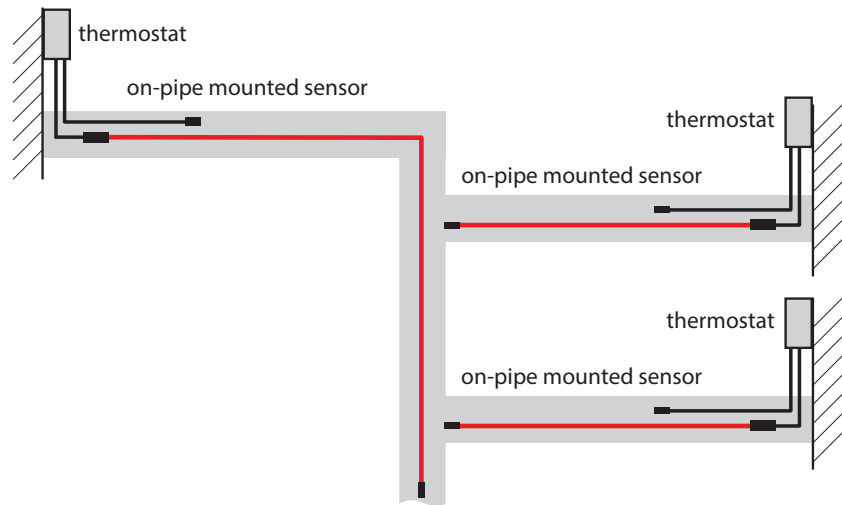

Pipe of different lengths. Installation completed with 3 individual thermostats, this could also be achieved using one DEVireg Hotwater.

Sensor placing

Sensors for Domestic hot water systems should be installed, at the estimated most representative position on the pipe.

Sensor placement for DEVireg Hotwater should be done such, that the hottest and coldest spot on pipe is measured, as the DEVireg Hotwater calculates a user configurable mean temperature.



DEVIreg™ Hotwater

DEVIreg™ Hotwater is an electronic programmable controller with 4 channels for on DIN rail mounting. Every channel can be set individually to maintain hot water with the option to disinfect manually, or on a schedule. The channels sensors can be selected between 7 different temperature sensors including NTC 15 kOhm at 25 °C. Building Management System (BMS) control is possible through the Modbus RS485 serial interface.

DEVIreg™ Hotwater has been developed to give the user easy setup, control of their hot water system, along with the option to disinfect. The controller allows up to 4 channels to be operated, each capable of controlling a separate pipe system. 2 sensors have to be used to measure the temperature for each channel.

Type	Value
Nominal voltage	110/230 V AC, 50–60 Hz
Power consumption, max.	20 V A
Relay load: Resistive (inductive, cos(phi sign) = 0,6)	
Total current load limit	32 A
C1-NO1, C2-NO2	10 (3,5) A (100 000 cycles)
C3-NO3-NC3, C4-NO4-NC4	6 (4) A (100 000 cycles)
C8-NO8-NC8	6 (4) A (100 000 cycles)
Sensor inputs	Analog inputs AI1-AI8
Compatible sensors	NTC15k (15 kOhm @ 25 °C) (standard) NTC10k (10 kOhm @ 25 °C) NTC5k (5 kOhm @ 25 °C) NTC2k (2 kOhm @ 25 °C) NTC100 (100 kOhm @ 25 °C) NTC16k (16,7 kOhm @ 100 °C) PT1000 (1000 Ohm @ 0 °C)
Digital inputs	DI1-DI8, voltage free contacts, on/off inputs
Connection specification	Grouped screws plug-in connectors
Cable specification for connectors terminals	0,2-2,5 mm ²
Battery back-up time, min.	48 hours
Ball pressure test	125 °C
Pollution degree	2 (domestic use)
Controller type	1 C
Operating temperatures and conditions	CE: -20T60 / UL: 0T55, 90% RH non-condensing
Storage temperature and conditions	-30T85, 90% RH non-condensing
IP class	IP40 only on the front cover
Protection class	Class II - □
Immunity against voltage surges	Over Voltage Category II
Dimensions (H/W/D), DIN dimension :	110(122) x 138 x 70 mm, 8 DIN modules
Mounting method	DIN rail, complying with EN 60715
Weight, net	511 g
Menu languages:	GB,DE,BG,CZ,DK,ES,EE,FI,FR,HR,HU,LT,LV,NL,NO,PL,PT,RO,RU,SE,SR,SI,SK,TR,UA,CN.
Base controller	Danfoss MCX08M2, item no. 080G0307
Software class	A

Compliance:

Low Voltage Directive 2014/35/EU
EMC Directive 2014/30/EU
EN/IEC 60730-1 + EN/IEC 60730-2-9

Certificates:



Benefits

- 4 independent channels
- 2 control modes:
 - Hot water maintenance
 - Hot water maintenance with disinfection
- User definable accuracy
- Compatible with 7 sensors types
- Sensor failure monitoring
- Accurate temperature control
- Alarm functions
- Multilanguage menu
- Graphic LCD display
- BMS control

DEVireg™ Hotwater + 2 sensor NTC 15kOhm

Item no.	Product name	Type	EAN no.
140F1133	DEVireg™ Hotwater	Programmable controller with 2 Wire sensor NTC 15 kOhm at 25 °C, 3 m	5703466249680

Accessories

Item no.	Product name	Description	EAN no.
140F1091	Sensor 3 m, 15 kOhm, Santropene	Wire sensor, 2x0,75 mm ² , NTC 15 kOhm at 25 °C, Ø5x18 mm, black Santropene (TPV), IP 67	5703466209301
140F1098	Temperature Sensor 10 m NTC 15k Santropene		5703466210734
19121445	Sensor cable 40 m, 15 kOhm, Santropene		5703466115015
140F1092	Outdoor sensor 2,5 m, 15 kOhm, PVC	Wire sensor, 2x0,75 mm ² , NTC 15 kOhm at 25 °C, Ø8 mm, white PVC outer sheath, IP 67	5703466209318
140F1097	Silicon sensor for DEVireg™ 330 (60-160°C), NTC 16,7 kOhm @ 100°C	Wire silicon sensor, 2,5 m, 2x0,75 mm ² , NTC 16,7 kOhm at 100 °C, IP 65	5703466209707

Connection scheme DEVireg™ Hotwater

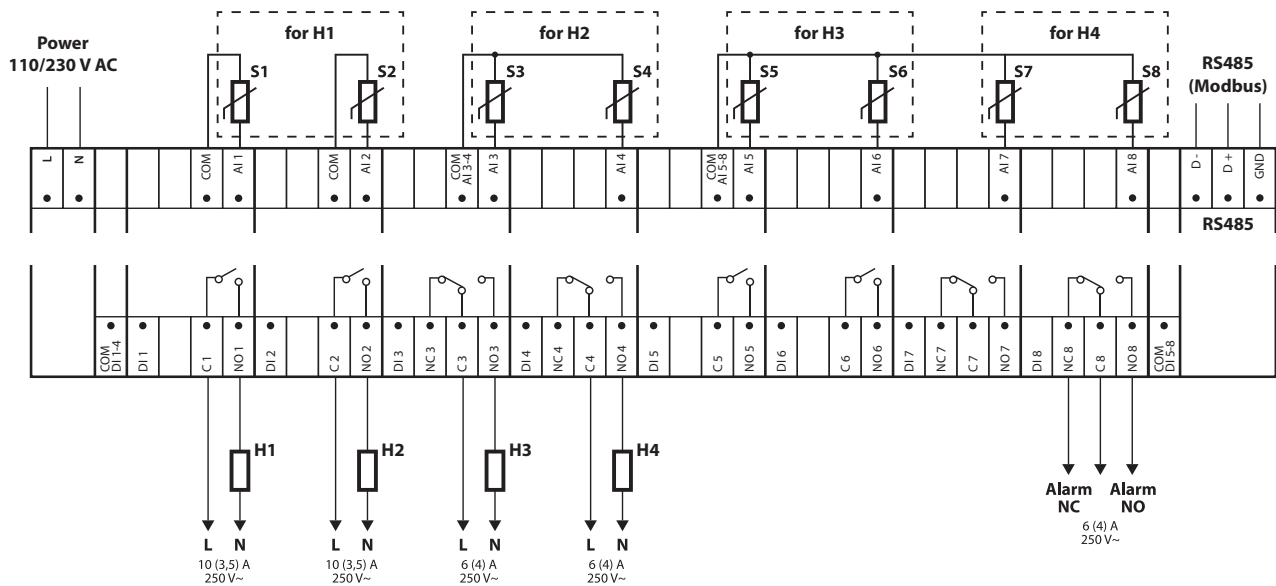

S - temperature Sensor
H - Heating element

3.2.3 Accessories selection

In case of metal pipes the heating cable can be attached to the pipe by means of an aluminum tape placed at intervals of approx. 1 meter. Subsequently, the total length of the heating cable needs to be covered with aluminum tape, securing cables to the pipe.

In case of the plastic pipes, before mounting the cable onto the pipe, the aluminum tape needs to be applied on the pipe where the heating cable will be placed. Other part of the installation steps resembles that of the installation on metal pipe.

For plastic pipe a temperature of more than 60 degrees can't be recommended, as this might weaken the connections of the pipes.

The cable installed throughout the pipe length needs to be covered along its whole length with aluminum tape to ensure good contact with the pipe.

On plastic pipes aluminum tape is necessary both below and above cable to ensure heat transfer.

All cables must be installed in parallel passes; no spiral wrapping is allowed. Hot water pipes shall be pressure tested prior to installation of heating cable and thermal insulation. Thermal insulation shall not be installed until heating cable installation is complete and tested.





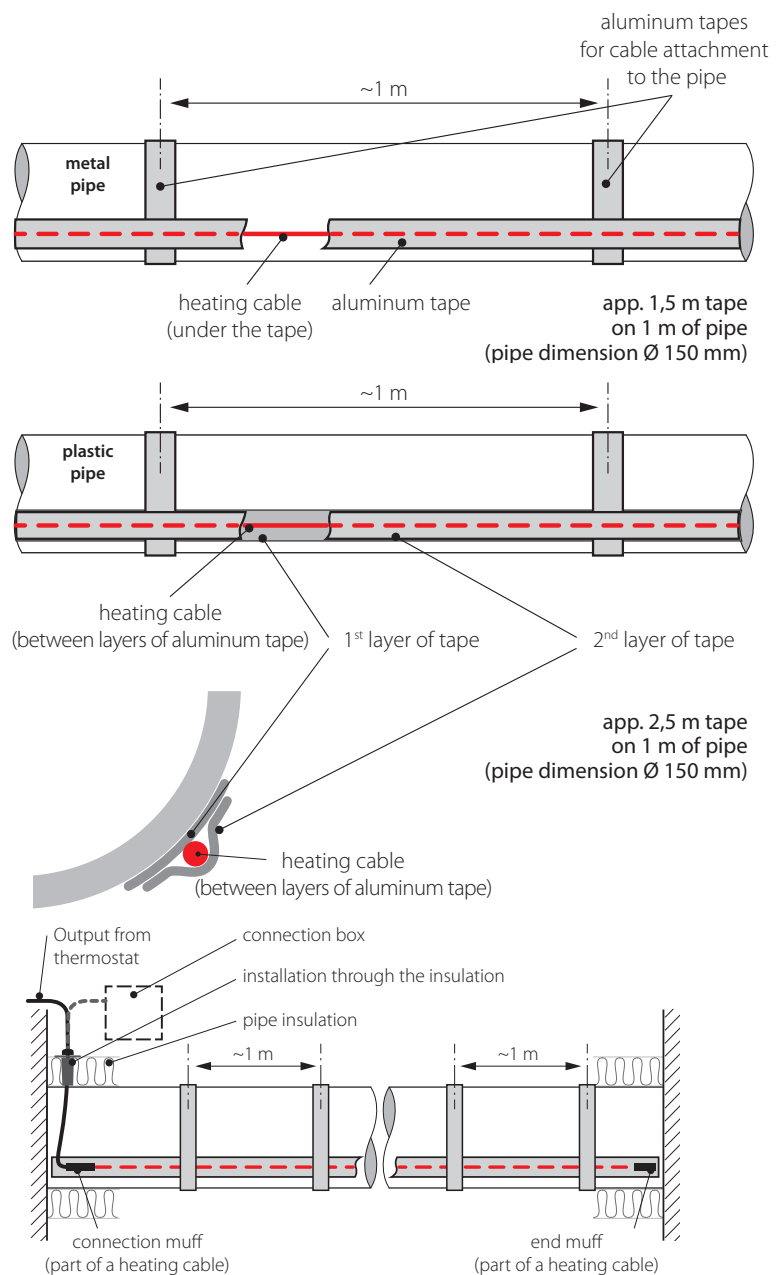

Cables must be fitted as shown at 5 or 7 o'clock positions when mounting two cables, or alternatively at 6 o'clock when mounting a single cable.

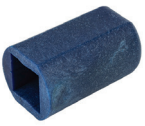

When the heating cable is

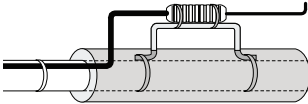

installed on pipes, the insulation should be clearly marked with a warning sign, e.g. **“WARNING: 230 VOLT HEATING CABLES”** as stated on our aluminum tape.

List of accessories:

Picture	Name	Description/Technical data	Art. no.	
	Tape aluminium 38 mm x 50 m	Self-adhesive, with 2-colour warning text, max. 75 °C Backing Aluminium foil Adhesive Waterbased Acrylic Liner Monosiliconized Paper Adhesion/Steel 8 N/ 38 mm Tensile strength 57,5 N/ 38 mm Total thickness 60 µm	Art. no.	19805076
			EAN no.	5703435003053
	DEVlconnecto B-A Connection	Package 130 x 265 x 75 mm	Art. no.	19808360
			EAN no.	5703466103067
	DEVlconnecto B-C Heating cable connection	130 x 265 x 75 mm	Art. no.	19808361
			EAN no.	5703466103074
	DEVlconnecto B-E End termination	130 x 265 x 75 mm	Art. no.	19808362
			EAN no.	5703466103081
	DEVlconnecto B-S Connection termination	130 x 265 x 75 mm	Art. no.	19808363
			EAN no.	5703466103098
	DEVlconnecto B-T, T-Junction + End termination	130 x 265 x 75 mm	Art. no.	19808364
			EAN no.	5703466103104
	DEVlconnecto B-TE2 Junction + 2 End termination	130 x 265 x 75 mm	Art. no.	19808365
			EAN no.	5703466103111
	DEVlconnecto B-TE3 Junction + 3 End termination	130 x 265 x 75 mm	Art. no.	19808366
			EAN no.	5703466103128
	DEVlconnecto B-X, X-Junction + 2 End termination	130 x 265 x 75 mm	Art. no.	19808367
			EAN no.	5703466103135
	DEVlconnecto Bracket, ref AH 61400005	Braket for installation outside the insulation 	Art. no.	19808390
			EAN no.	5703466125021

Picture	Name	Description/Technical data		Art. no.			
	Sensor cable 3 m, 15 kOhm, Santropene	Wire sensor 2x0,75 mm ² , NTC 15 kOhm at 25 °C, Ø5 mm, black Santropene (TPV) outer sheath, IP 67, Temp. range -25 °C to 90 °C	Temp., °C	Resistanse, kOhm	Art. no.	140F1091	
			-10	66,1	EAN no.	5703466209301	
			-5	52,5			
	0		41,1	Art. no.	140F1098		
	5		33,2			EAN no.	5703466210734
	Temperature Sensor 10 m NTC 15k Santropene		Temperature Sensor 40 m NTC15k Santropene	10	27,0	Art. no.	19121445
				15	22,1	EAN no.	5703466115015
	20		18,2				
	25		15,0				
	30		12,3				
	35		10,4				
	40		8,7				
	45		7,4				
50	6,2						
	Outdoor sensor 2,5 m, 15 kOhm, PVC, DIN 44574	Wire sensor, 2x0,75 mm ² , NTC 15 kOhm at 25 °C, Ø8 mm, white PVC outer sheath, IP 67, Temp. range -25 °C to 70 °C	Art. no.	140F1092			
			EAN no.	5703466209318			
	Silicon temperature sensor for DEVIreg™ 330 (60-160°C), NTC 16,7 kOhm @ 100°C	Wire sensor, 2,5 m, 2x0,75 mm ² , NTC 16,7 kOhm at 100 °C, Ø9 mm, IP 65, Temp. range 50 °C to 170 °C	Art. no.	140F1097			
			EAN no.	5703466209707			

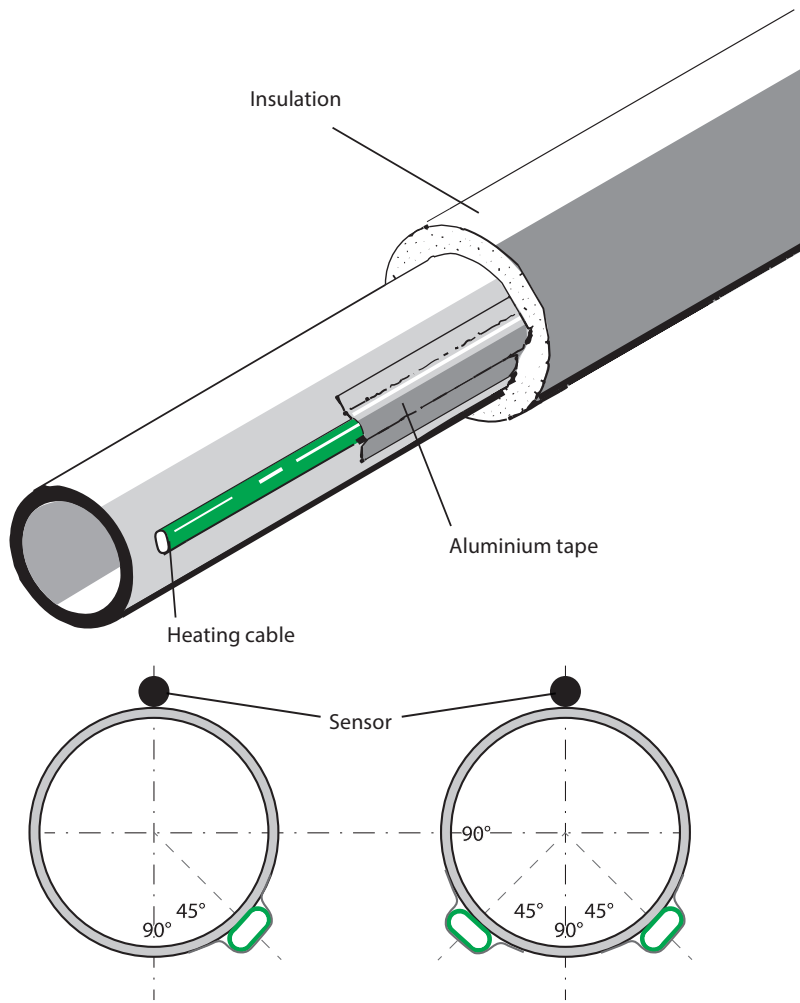

The recommended ways to mount the cable lines on the pipe

Selection of connection accessories for self-limiting heating cables

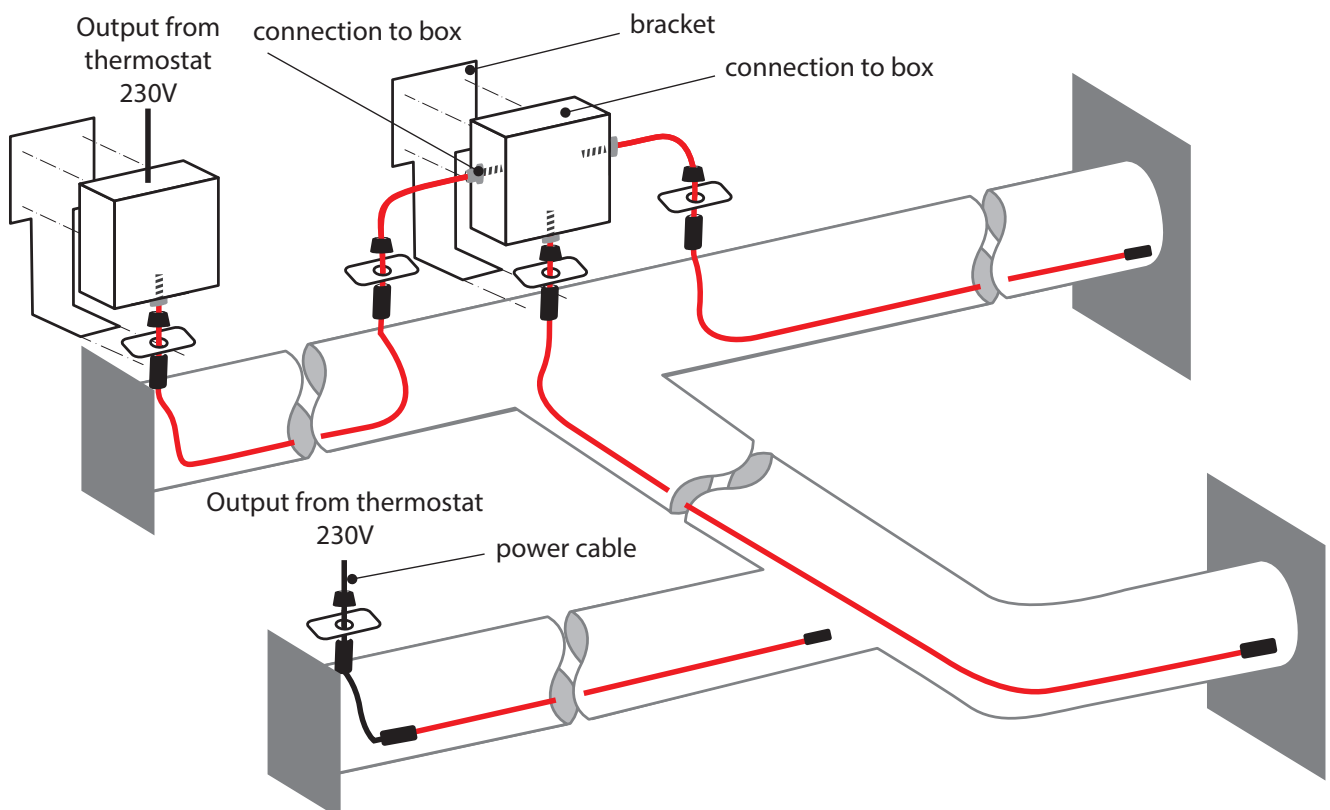

4. Safety instruction

Heating cables must always be installed according to local building regulations and wiring rules as well as the guidelines in this installation manual.

De-energize all power circuits before installation and service.

Residual current device (RCD) protection is required. RCD trip rating is max. 30 mA.

The screen from each heating cable must be connected to earthing terminal in accordance with local electricity regulations.

Heating cables must be connected via a switch providing all pole disconnection.

The heating cable must be equipped with a correctly sized fuse or circuit breaker according to local regulations.

Never exceed the maximum heat density (W/m or W/m²) for the actual application.

Strongly recommended to use the heating cable together with an appropriate thermostat to secure against overheating.

The presence of a heating cable must be made evident by affixing caution signs in the fuse box and in the distribution board or markings at the power connection fittings and/or frequently along the circuit line where clearly visible (tracing) must be stated in any electrical documentation following the installation.

4.1 DO's

- For installation of cable and thermostat/controller, always refer to the local regulations/legislations and respective manuals.
- Remember to fill out the warranty sheet with the required information as this will not be valid otherwise.
- Carefully complete the installation, the cable can break when overloaded.
- If any doubt arises consult you manual or local DEVI department.
- Ensure that the cable is sufficiently fixed and mounted according to the manual.
- Ensure that warning labels and stickers (potentially tape) with warning text is used to inform about the heat traced cable.
- Install sensors where the temperature is estimated to be representative for the whole installation, where 2 sensors are needed for the thermostat/controller please install at the estimated extreme points (coldest and hottest).
- To get the best performance of the system and avoid failures it is necessary to follow the installation descriptions.
- To get the best performance of the system it is strictly necessary to calculate the correct heat losses, for all dimensions of pipes and the whole system. Using this knowledge the cable with right output can be chosen.
- Plan every installation step and fixing point of the traced pipes ahead of time and ensure that the "run" is proper and possible.
- Ensure sensors are connected according to the applicable installation guide and/or application guide.

4.2 DON'Ts

- Never make an installation without thermostat.
- Never install cables where the heat can't be dissipated, even with a self-limiting cable the output will never become zero and the cable can overheat.
- Never let unauthorized personnel install controllers/thermostats or heating elements.
- Never use unauthorized accessories.
- Never use our products (cables, controllers, sensors, etc.) outside provided temperature range.

5. Case stories

<https://devi.danfoss.com/en/case-stories/?page=1>



6. Technical support

The Electric Heating team is offering valuable support to professionals when it comes to preparing your new projects.

We offer support for:

- Calculation of Electric Heating system
- Development of drawings for projects
- Preparation of the BoM (Bill of Material)
- Recommendations for the installation and operation of the system

In order to clarify the project data for different applications use the following technical request forms, fill in with your specifications and send it to: EH@danfoss.com

<https://devi.danfoss.com/en/support/>

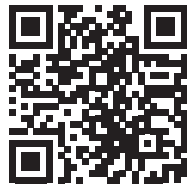

Intelligent solutions
with lasting effect

Visit [devi.com](https://www.devi.com)

DEVI[®] 
by Danfoss