

Contents

1 Safety	3
Safety Note	3
Safety Regulations	3
Warning against Unintended Start	4
2 Introduction	5
About this Manual	5
Technical Overview	5
Assumptions	5
Hardware	5
Background Knowledge	5
Available Literature	6
ODVA Conformance	6
Abbreviations	6
3 How to Install	7
The EtherNet/IP Option	7
How to Install Option in Frequency Converter	8
LED Behaviour	9
Topology	10
Network	11
Recommended Design Rules	12
EMC Precautions	13
4 How to Configure	15
IP Settings	15
Ethernet Link Parameters	16
Configuring the Scanner	17
IP traffic	19
5 How to Control	21
How to Control	21
I/O Assembly Instances	21
EtherNet/IP Connections	22
Class 1 connection	22
Class 3 connection	23
Unconnected Messages, UCMM	23
Control Word Profile	23
Change of State, COS	24
Danfoss FC Control Profile	25
Danfoss FC Control Profile	25

Status Word according to FC ProfileDrive Profile (STW)	26
ODVA Control Profile	27
Control Word under Instances 20/70 and 21/71	27
Status Word under Instances 20/70 and 21/71	28
Reference Handling	29
Bus Speed Reference Value under Instances 100-101-103/150-151-153	29
Bus Speed Reference Value under Instances 20/70 and 21/71	30
6 Parameters	31
Parameter Group 8-**	31
Parameter Group 12-**	35
IP Settings	35
Ethernet Link Parameters	36
Process Data	37
EtherNet/IP	38
Other EtherNet Services	39
Advanced EtherNet Settings	40
Parameter List	42
Data Types	44
Data Types Supported by FC 200/FC 300	44
7 Troubleshooting	45
Step-by-step Troubleshooting	45
Alarm Word and Warning Word	45
8 Appendix	51
Supported CIP Objects	51
Index	59

1 Safety

1

1.1.1 Copyright, Limitation of Liability and Revision Rights

This publication contains information proprietary to Danfoss. By accepting and using this manual the user agrees that the information contained herein will be used solely for operating equipment from Danfoss or equipment from other vendors provided that such equipment is intended for communication with Danfoss equipment over an Ethernet serial communication link. This publication is protected under the Copyright laws of Denmark and most other countries.

Danfoss does not guarantee that a software program produced according to the guidelines provided in this manual will function properly in every physical, hardware or software environment.

Although Danfoss has tested and reviewed the documentation within this manual, Danfoss makes no warranty or representation, either express or implied, with respect to this documentation, including its quality, performance, or fitness for a particular purpose.

In no event shall Danfoss be liable for direct, indirect, special, incidental, or consequential damages arising out of the use, or the inability to use information contained in this manual, even if advised of the possibility of such damages. In particular, Danfoss is not responsible for any costs including but not limited to those incurred as a result of lost profits or revenue, loss or damage of equipment, loss of computer programs, loss of data, the costs to substitute these, or any claims by third parties.

Danfoss reserves the right to revise this publication at any time and to make changes in its contents without prior notice or any obligation to notify previous users of such revisions or changes.

1.1.2 Safety Note



The voltage of the frequency converter is dangerous whenever connected to mains. Incorrect installation of the motor, frequency converter or fieldbus may cause damage to the equipment, serious personal injury or death. Consequently, the instructions in this manual, as well as national and local rules and safety regulations, must be complied with.

1.1.3 Safety Regulations

1. The frequency converter must be disconnected from mains if repair work is to be carried out. Check that the mains supply has been disconnected and that the necessary time has passed before removing motor and mains plugs.
2. The [OFF] key on the LCP of the frequency converter does not disconnect the equipment from mains and is thus not to be used as a safety switch.
3. Correct protective earthing or grounding of the equipment must be established, the user must be protected against supply voltage, and the motor must be protected against overload in accordance with applicable national and local regulations.
4. The earth leakage currents are higher than 3.5 mA.
5. Protection against motor overload is not included in the factory setting. If this function is desired, set par. to data value ETR trip or data value ETR warning.



NB!

The function is initialised at 1.16 x rated motor current and rated motor frequency. For the North American market; the ETR functions provide class 20 motor overload protection in accordance with NEC.

6. Do not remove the plugs for the motor and mains supply while the frequency converter is connected to mains. Check that the mains supply has been disconnected and that the necessary time has passed before removing motor and mains plugs.
7. Please note that the frequency converter has more voltage inputs than L1, L2 and L3, when load sharing (linking of DC intermediate circuit) and external 24 V DC have been installed. Check that all voltage inputs have been disconnected and that the necessary time has passed before commencing repair work.

1.1.4 Warning against Unintended Start

1. The motor can be brought to a stop by means of digital commands, bus commands, references or a local stop, while the frequency converter is connected to mains. If personal safety considerations make it necessary to ensure that no unintended start occurs, these stop functions are not sufficient.
2. While parameters are being changed, the motor may start. Consequently, the [OFF] key must always be activated.
3. A motor that has been stopped may start if faults occur in the electronics of the frequency converter, or if a temporary overload or a fault in the supply mains or the motor connection ceases.



Touching the electrical parts may be fatal - even after the equipment has been disconnected from mains.

Also make sure that other voltage inputs have been disconnected, such as external 24 V DC, load sharing (linkage of DC intermediate circuit), as well as the motor connection for kinetic back up.

Please take note of discharge times and further safety guidelines from the section: "Safety and conformity", in the respective Design Guide (MG.33.Ax.yy).

2 Introduction

2.1.1 About this Manual

First time users can obtain the most essential information for quick installation and set-up in these chapters:

Introduction

How to Install

How to Configure the System

For more detailed information including the full range of set-up options and diagnosis tools please refer to the chapters:

How to Configure the System

How to Control the FC 200/FC 300

How to Access FC 200/FC 300 Parameters

Parameters

Troubleshooting

Terminology:

In this manual several terms for Ethernet is used.

- EtherNet/IP, is the term used to describe the CIP/ODVA application protocol.
- Ethernet, is a common term used to describe the physical layer of the network and does not relate to the application protocol.

2.1.2 Technical Overview

EtherNet/IP™ was introduced in 2001 and today is the most developed, proven and complete industrial Ethernet network solution available for manufacturing automation. EtherNet/IP is a member of a family of networks that implements the Common Industrial Protocol (CIP™) at its upper layers. CIP encompasses a comprehensive suite of messages and services for a variety of manufacturing automation applications, including control, safety, synchronization, motion, configuration and information. As a truly media-independent protocol that is supported by hundreds of vendors from around the world, CIP provides users with unified communication architecture throughout the manufacturing enterprise.

EtherNet/IP provides users with the network tools to deploy standard Ethernet technology for manufacturing applications while enabling Internet and enterprise connectivity.

2.1.3 Assumptions

These operating instructions are under the conditions that the Danfoss EtherNet/IP option is used in conjunction with a Danfoss FC-200/FC-300 frequency converter, inclusive that the installed controller supports the interfaces described in this document and that all the requirements stipulated in the controller, as well as the frequency converter, are strictly observed along with all limitations herein.

2.1.4 Hardware

This manual relates to the EtherNet/IP option MCA 121, type no. 130B1119 (un-coated) and 130B1219 (coated).

2.1.5 Background Knowledge

The Danfoss EtherNet/IP Option Card is designed to communicate with any system complying with the CIP EtherNet/IP standard. Familiarity with this technology is assumed. Issues regarding hardware or software produced by other manufacturers, including commissioning tools, are beyond the scope of this manual, and are not the responsibility of Danfoss.

For information regarding commissioning tools, or communication to a non-Danfoss node, please consult the appropriate manuals.

2.1.6 Available Literature

Available Literature for FC 200/ FC 300

- The VLT AutomationDrive Operating Instructions provide the necessary information for getting the drive up and running.
- The VLT AutomationDrive Design Guide entails all technical information about the drive design and applications including encoder, resolver and relay options.
- The VLT AutomationDrive Profibus Operating Instructions provide the information required for controlling, monitoring and programming the drive via a Profibus fieldbus.
- The VLT AutomationDrive Operating Instructions provide the information required for controlling, monitoring and programming the drive via a DeviceNet fieldbus.
- The VLT AutomationDrive MCT 10 Operating Instructions provide information for installation and use of the software on a PC.
- The VLT AutomationDrive IP21 / Type 1 Instruction provides information for installing the IP21 / Type 1 option.
- The VLT AutomationDrive 24 V DC Backup Instruction provides information for installing the 24 V DC Backup option.

Danfoss Drives technical literature is also available online at www.danfoss.com/drives.

2.1.7 ODVA Conformance

The EtherNet/IP option is tested to conform to the ODVA standards, and is certified, towards conformance test level version 3.

2.1.8 Abbreviations

Abbreviation	Definition
API	Actual Packet Interval
CC	Control Card
CIP	Common Industrial Protocol
CTW	Control Word
DHCP	Dynamic Host Configuration Protocol
EIP	EtherNet/IP
EMC	Electromagnetic Compatibility
I/O	Input/Output
IP	Internet Protocol
LCP	Local Control Panel
LED	Light Emitting Diode
LSB	Least Significant Bit
MAR	Major Recoverable fail
MAU	Major Unrecoverable fail
MAV	Main Actual Value (actual output)
MSB	Most Significant Bit
MRV	Main Reference Value
N/A	Not applicable
ODVA	Open DeviceNet Vendor Association
PC	Personal Computer
PLC	Programmable Logic Controller
PNU	Parameter Number
REF	Reference (= MRV)
RTC	Real Time Clock
STP	Spanning tree Protocol
STW	Status Word

3 How to Install

3.1.1 The EtherNet/ IP Option

3

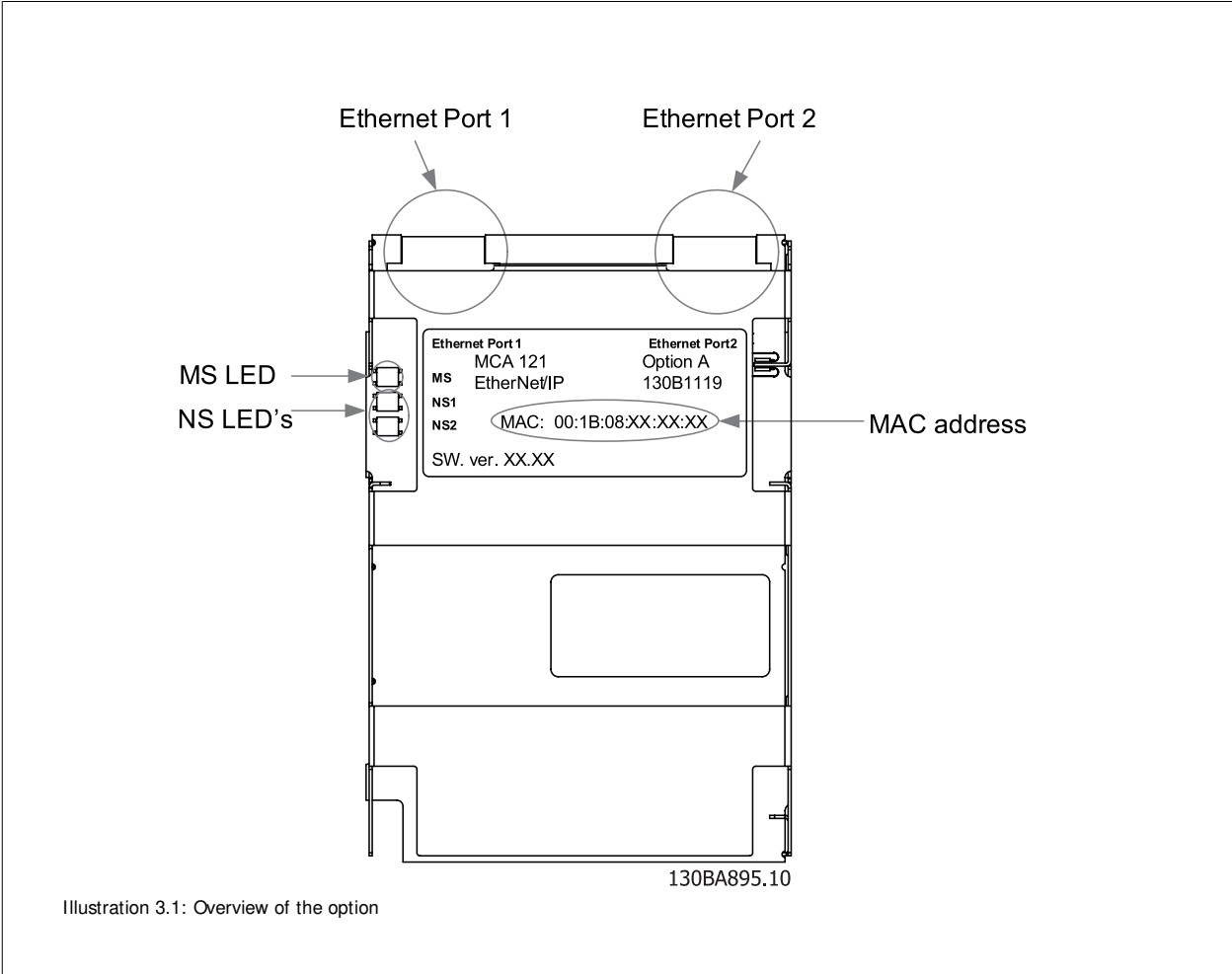

Illustration 3.1: Overview of the option

3.1.2 How to Install Option in Frequency Converter

Items required for installing a fieldbus option in the frequency converter:

- The fieldbus option
- Fieldbus option adaptor frame for the FC 200/FC 300. This frame is deeper than the standard frame, to allow space for the fieldbus option beneath
- Strain relief (only for A1 and A2 enclosures)

3

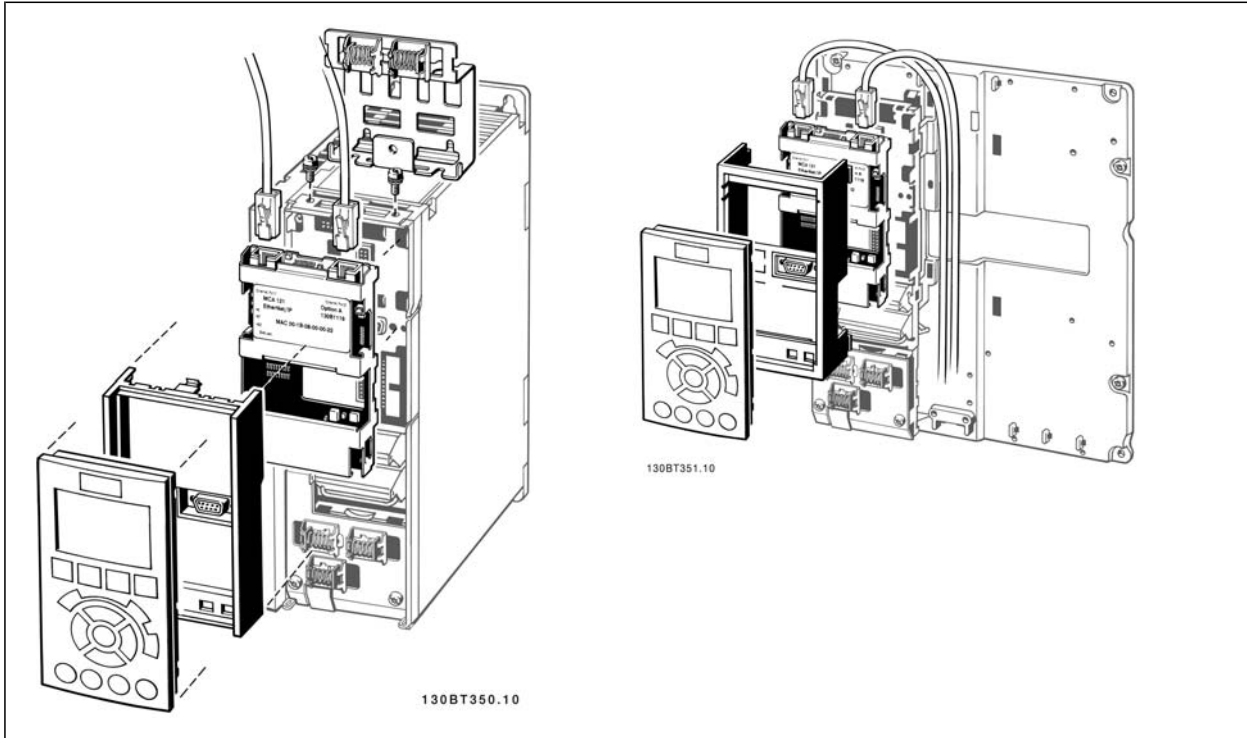

Instructions:

- Remove LCP panel from the FC 200/FC 300.
- Remove the frame located beneath and discard it.
- Push the option into place. The Ethernet connectors must be facing upwards.
- Remove both knock-outs on the fieldbus option adaptor frame.
- Push the fieldbus option adaptor frame for the FC 200/FC 300 into place.
- Replace the LCP and attach cable



NB!

Do not strip the Ethernet cable and ground it via the strain relief-plate! The grounding of screened Ethernet cable is done through the RJ-45 connector on the option.



NB!

After installing the MCA 121 option, be aware of the following parameter settings:
 par. 8-01 *Control Site*: [2] *Controlword only* or [0] *Digital and ctrl. word*
 par.8-02 *Control Word Source*: [3] *Option A*

3.1.3 LED Behaviour

The option has 3 bi-coloured LEDs according to ODVA specifications:

LED Label	Description
MS	Module Status
NS1	Network Status Ethernet Port 1
NS2	Network Status Ethernet Port 2

The option LED's operates according to ODVA specifications.







State	LED	Description
No power	Off	The device is un-powered
Device operational	Green: 	Solid green The device is operational
Standby	Green: 	Flashing green The device needs commissioning
Minor fault	Red: 	Flashing red The device has detected a recoverable fault
Major fault	Red: 	Solid red The device has detected an un-recoverable fault
Self test	Red:  Green: 	Flashing red/ green The EIP option is in self-test mode

Table 3.1: MS: Module Status







State	LED	Description
No IP-address (no power)	Off	The device does not have a valid IP-address (or is un-powered)
No connections	Green: 	Flashing green There are no established CIP connections to the device
Connected	Green: 	Solid green There is established (at least) one CIP connection to the device
Connection time-out	Red: 	Flashing red One or more CIP connections have timed-out
Duplicate IP	Red: 	Solid red The IP-address assigned to the device is already in use
Self test	Red:  Green: 	Flashing red/green The EIP option is in self-test mode

Table 3.2: NS1 + NS2: Network Status (one per port)

During normal operation the MS and at least one NS LED will show a constant green light.

3.1.4 Topology

The MCA 121 features a build-in Ethernet-switch, thus having two Ethernet RJ-45 connectors. This enables the possibility for connecting several EtherNet/IP options in a line topology as an alternative to the typical star-topology.

The two ports are equal, in the sense that they are transparent for the option. If only one connector is used, either port can be used.

3

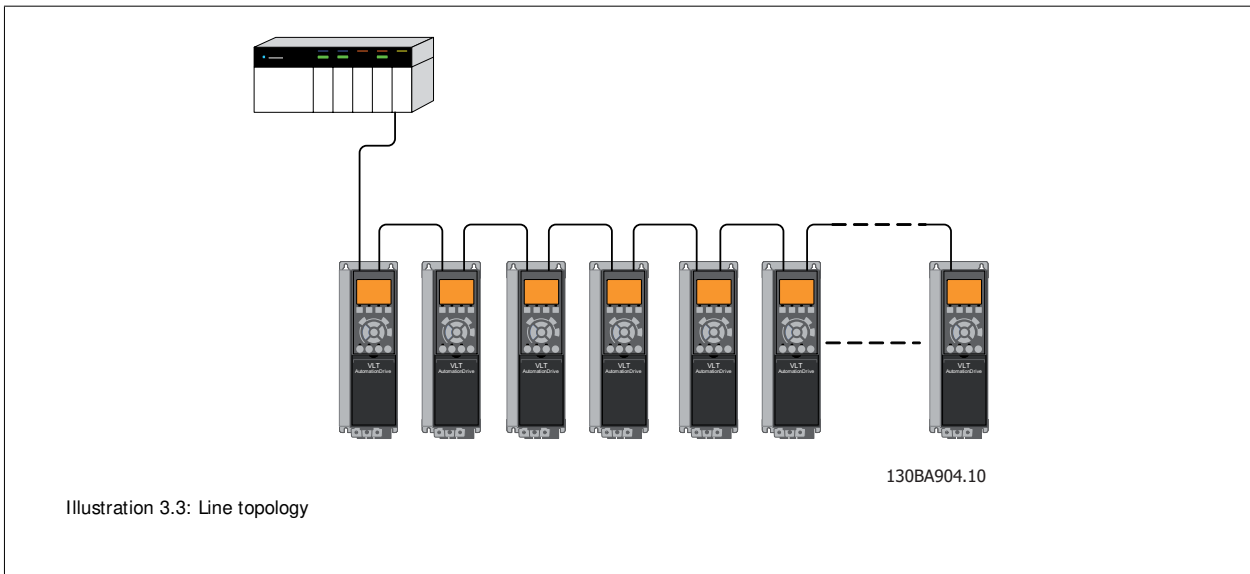
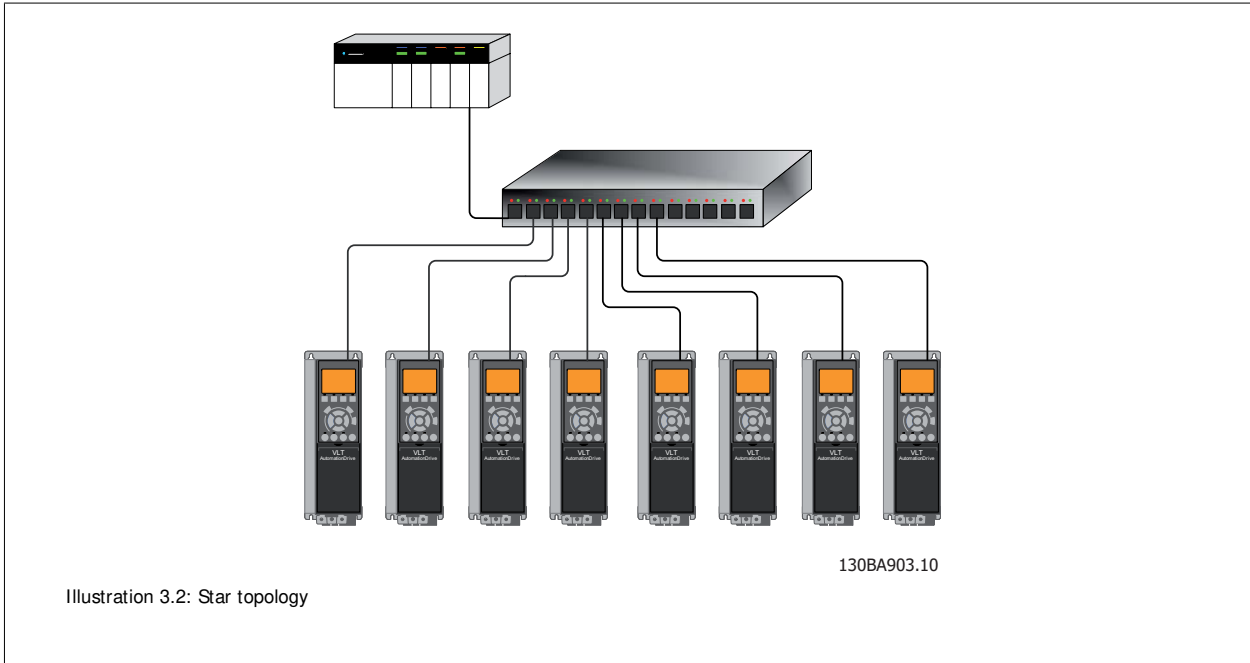

NB!

For line topology please refer to section: "Recommended design rules" In a line topology all drives must be powered, either by mains or by their 24 V DC option cards, for the build-in switch to work.



NB!

Please observe that mounting drives of different power-sizes in a line topology may result in unwanted power-off behaviour. Smaller drives discharge faster than bigger drives. This can result in loss of link in the line topology, which may lead to control word timeout.

To avoid this, mount the drives with the longest discharge time first in the line topology.

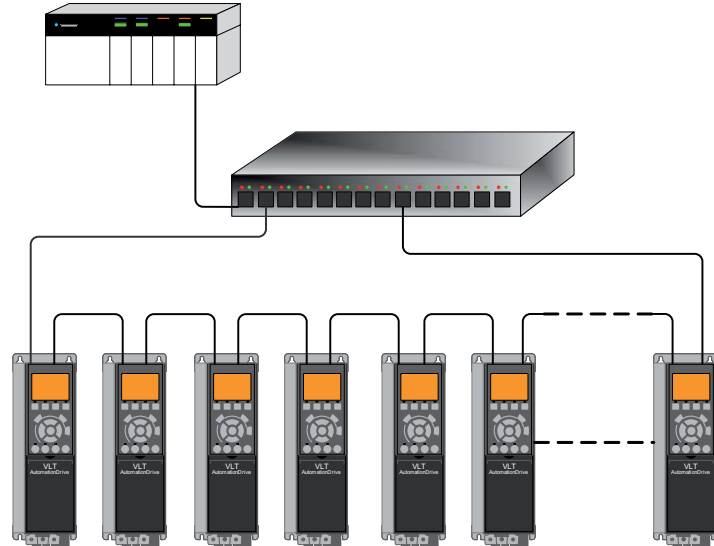

Illustration 3.4: Ring/redundant line topology



NB!

For this type of topology it is crucial that the network switch supports Spanning Tree Protocol (STP) or Rapid Spanning Tree (RSTP), and that STP is enabled. For more information on Spanning Tree please refer to section *IP traffic*.

3.1.5 Network

It is of high importance that the media chosen for Ethernet data transmission are suitable. Usually CAT 5e and 6 cables are recommended for industrial applications. Both types of cable are available as Unshielded Twisted Pair and Shielded Twisted Pair. Generally shielded cables are recommended for use in industrial environments and with frequency converters.

A maximum cable-length of 100 m is allowed between switches.

Optical fibres can be used for gapping longer distances and providing galvanic isolation.

For connecting EtherNet/IP devices both hubs and switches can be used. It is, however, recommended always to use suitable industrial graded Ethernet switches. For more information regarding IP-switching, please refer to section: *IP Traffic* in this manual.

3.1.6 Recommended Design Rules

While designing Ethernet networks special attention and caution must be taken regarding active network components.

While designing a network for line topology it is important to notice that a small delay is added with each every switch in the line.

It is not recommended to connect more than 32 drives in a line at any API. Exceeding the recommended design rules, may result in failing communication.

3

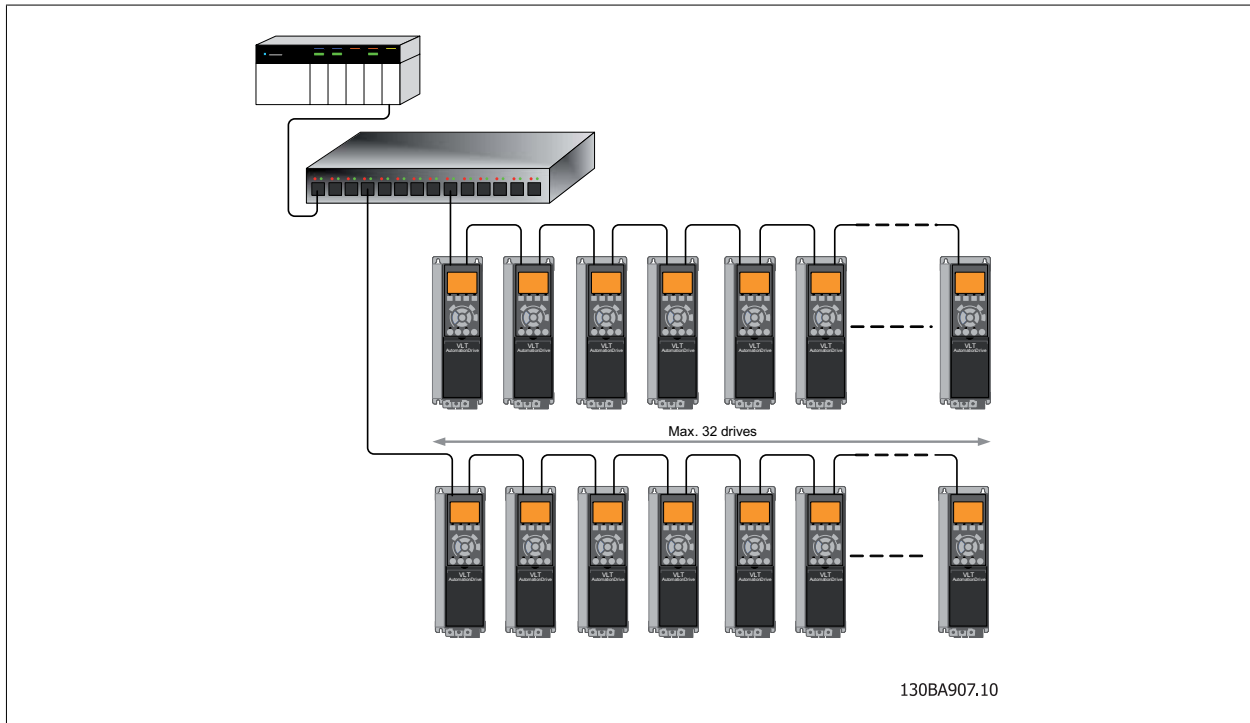

3.1.7 EMC Precautions

The following EMC precautions are recommended in order to achieve interference-free operation of the Ethernet network. Additional EMC information is available in the FC 200/FC 300 series Design Guide.



NB!
Relevant national and local regulations, for example regarding protective earth connection, must be observed.

The Ethernet communication cable must be kept away from motor and brake resistor cables to avoid coupling of high frequency noise from one cable to the other. Normally a distance of 200 mm (8 inches) is sufficient, but maintaining the greatest possible distance between the cables is recommended, especially where cables run in parallel over long distances. When crossing is unavoidable, the Ethernet cable must cross motor and brake resistor cables at an angle of 90 degrees.

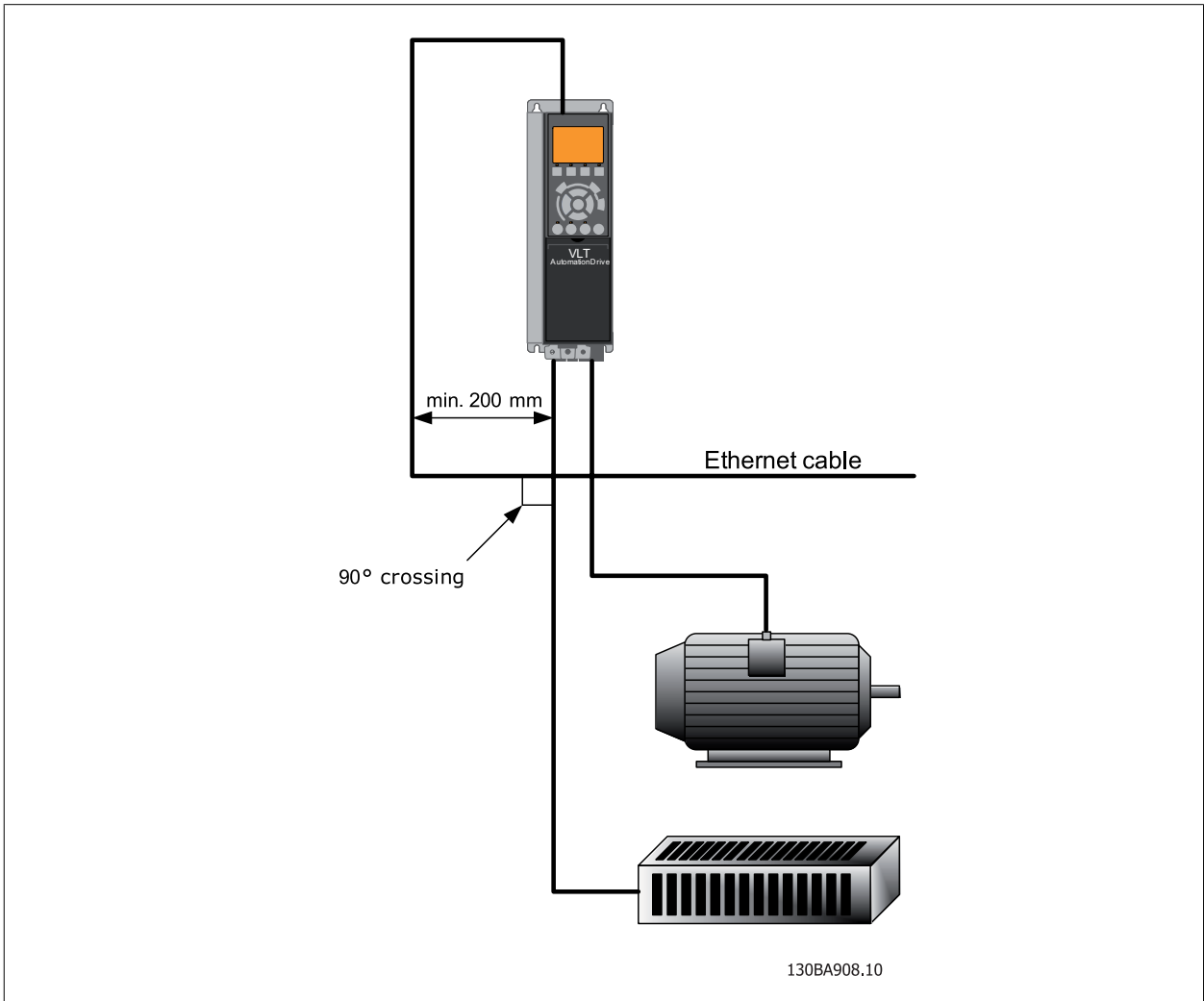

4

4 How to Configure

4.1.1 IP Settings

All IP-related parameters are located in parameter group 12-0* :

12-00	IP Address Assignment
12-01	IP Address
12-02	Subnet Mask
12-03	Default Gateway
12-04	DHCP Server
12-05	Lease Expires
12-06	Name Servers
12-07	Domain Name
12-08	Host Name
12-09	Physical Address

The MCA 121 option offers several ways of IP address assignment.

Setting up drive with manual assigned IP address:

Par.	Name	Value
12-00	<i>IP Address Assignment</i>	[0] MANUAL
12-01	<i>IP Address</i>	192.168.0.xxx*
12-02	<i>Subnet Mask</i>	255.255.255.0*
12-03	<i>Default Gateway</i>	optional

* = Class C IP address example. Any valid IP address can be entered.



NB!

A power-cycle is necessary after setting the IP parameters manually.

Setting up drive with automatic (BOOTP/ DHCP) assigned IP address:

Par.	Name	Value
12-00	<i>IP Address Assignment</i>	[1] DHCP/[2] BOOTP
12-01	<i>IP Address</i>	Read only
12-02	<i>Subnet Mask</i>	Read only
12-03	<i>Default Gateway</i>	Read only

By IP address assigned by DHCP/BOOTP server, the assigned *IP Address* and *Subnet Mask* can be read out in par. 12-01 and 12-02. In par. 12-04 *DHCP Server*, the IP address of the found DHCP or BOOTP server is displayed. For DHCP only: The remaining lease-time can be read-out in par. 12-05 *Lease Expires*.

Par. 12-09, *Physical Address* reads out the MAC address of option, which is also printed on the label of the option. If using fixed leases together with DHCP or BOOTP, the physical MAC address is linked with a fixed IP address.



NB!

If no DHCP or BOOTP reply has been received after 4 attempts (e.g. if the DHCP/BOOTP server has been powered off), the option will fallback to the last good known IP address.

Par. 12-03, *Default Gateway* is optional and only used in routed networks.

Par. 12-06, *Name Servers*

Par. 12-07, *Domain Name*

Par. 12-08, *Host Name*

Are used with Domain Name Server systems and are all optional. If DHCP or BOOTP is selected as IP address assignment, these parameters are read only.



NB!

It is only possible to assign valid class A, B and C IP address to the option. The valid ranges are shown in the below table:

Class A	1.0.0.1 - 126.255.255.254
Class B	128.1.0.1 - 191.255.255.254
Class C	192.0.1.1 - 223.255.254.254

4

4.1.2 Ethernet Link Parameters

Parameter group 12-1* holds information Ethernet Link information:

12-10	Link Status
12-11	Link Duration
12-12	Auto Negotiation
12-13	Link Speed
12-14	Link Duplex

Please note the Ethernet Link Parameters are unique per port.

Par. 12-10, *Link Status* and par. 12-11, *Link Duration* displays information on the link status, per port.

Par. 12-10, *Link Status* will display Link or No Link according to the status of the present port.

Par. 12-11, *Link Duration* will display the duration of the link on the present port. If the link is broken the counter will be reset.

Par. 12-12, *Auto Negotiation* – is a feature that enables two connected Ethernet devices to choose common transmission parameters, such as speed and duplex mode. In this process, the connected devices first share their capabilities as for these parameters and then choose the fastest transmission mode they both support.

By default this function is enabled.

Incapability between the connected devices, may lead to decreased communication performance.

To prevent this, Auto Negotiation can be disabled.

If par. 12-12 is set to OFF, link speed and duplex mode can be configured manually in par. 12-13 and 12-14.

Par. 12-13, *Link Speed* – displays/sets the link speed per port. "None" is displayed if no link is present.

Par. 12-14, *Link Duplex* – displays/sets the duplex mode per port.

Half-duplex provides communication in both directions, but only in one direction at a time (not simultaneously).

Full-duplex allows communication in both directions, and unlike half-duplex, allows for this to happen simultaneously.

4.1.3 Configuring the Scanner

EDS file

Danfoss provides a generic English EDS (Electronic Data Sheet) file covering all voltage and power sizes, for off-line configuration.

The EDS file can be downloaded from:

http://www.danfoss.com/BusinessAreas/DrivesSolutions/SoftwareDownload/DDFieldbus_Setup_Files.htm



NB!

The current version of the major EtherNet/IP configuration tools does not support EDS-files for EtherNet/IP devices.

Configuring a Rockwell Master

For configuring a FC 200/FC 300 with MCA121 for operation with a Rockwell (Allen-Bradley) Scanner via EtherNet/IP, the FC 200/FC 300 must be added as a *Generic Ethernet Module*.

Under the *General*-tab, enter information about: Name of device, IP Address, Assembly Instance and Data size

130BA909.10



NB!

Under *Configuration* in the Connection Parameters a "4" must be entered as Assembly Instance.



NB!

Please note that the example shows a 20/70 assembly instance connection. This requires par. 8-10 *Control Profile* to be set to: ODVA. Other supported connections are shown in section: *I/O Assembly Instanced*.

Under the *Connection*-tab, enter information about: RII and fault conditions.

4

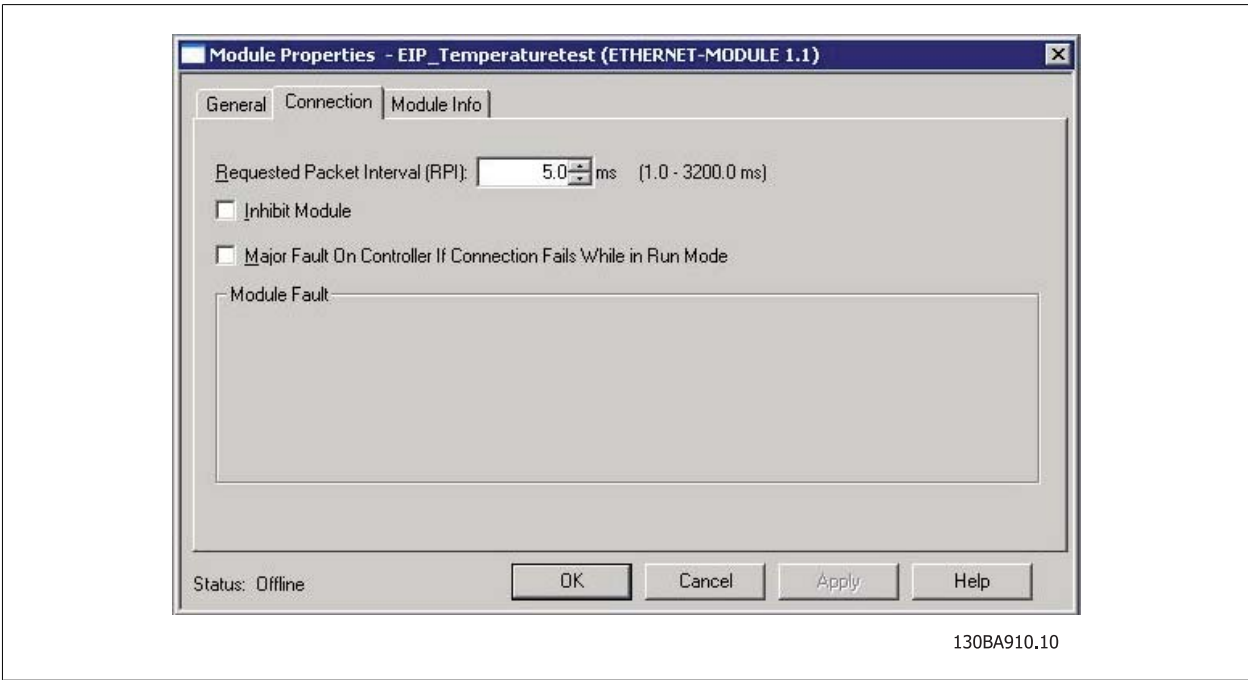

130BA910.10

The *Module Info* – This tap holds generic information.

The *Reset Module* – This button will make a simulated Power-cycle of the drive.

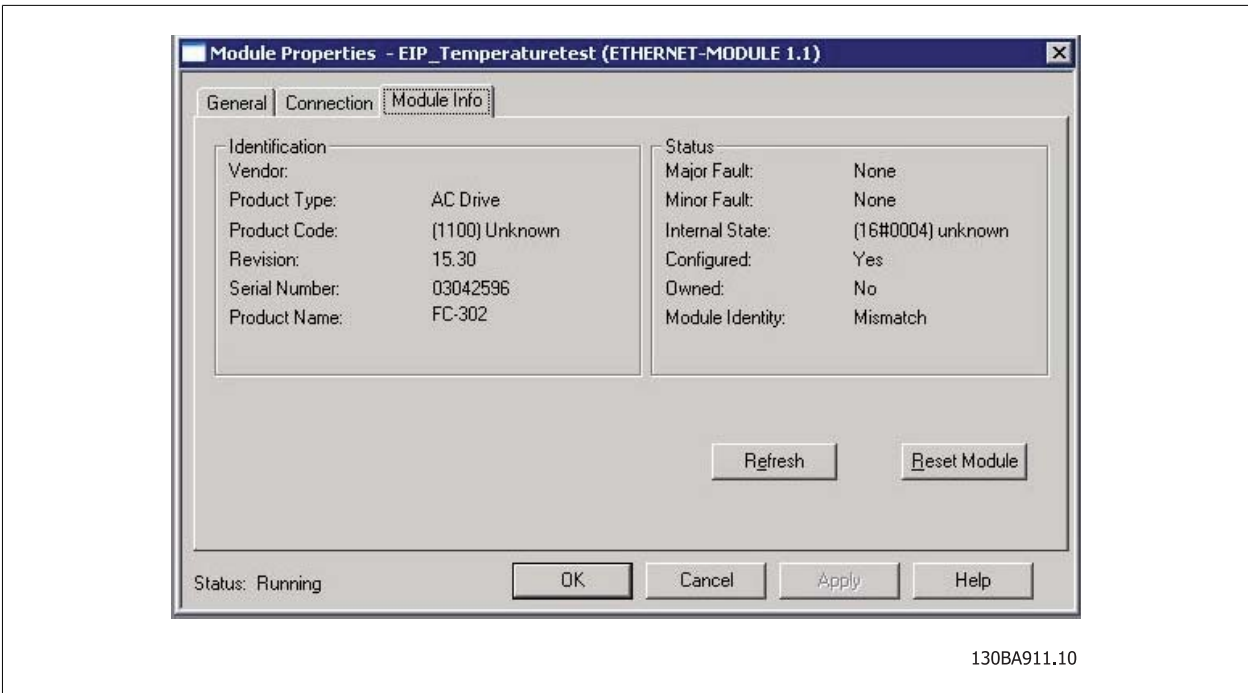

130BA911.10



NB!

For more information on the CIP class 1 Forward Open command, please refer to section: *EtherNet/IP Connections* under the *How to Control* -chapter.

4.1.4 IP traffic

The use of Ethernet based network for industrial automation purposes, calls for careful and thorough network design. Especially the use of active network components like switches and routers requires detailed know-how about the behaviour of IP traffic.

Some important issues:

Multicast

Multicast traffic; is traffic that is addressed to a number of recipients. Each host processes the received multicast packet to determine if it is the target for the packet. If not, the IP package is discarded. This causes an excessive network load of each node in the network since they are flooded with multicast packages. The nature of EtherNet/IP traffic is that all Originator-to-Target traffic is Unicast (point-to-point) but Target-to-Originator traffic is optional Multicast. This enables that several listen only -connections can be made to a single host.

In switched networks hosts also have the risk of becoming flooded with multicast traffic. A switch usually forwards traffic by MAC address tables build by looking into the source address field of all the frames it receives.

A multicast MAC address is never used as a source address for a packet. Such addresses do not appear in the MAC address table, and the switch has no method for learning them, so it will just forward all multicast traffic to all connected hosts.

IGMP

IGMP (Internet Group Management Protocol) is an integrated part of IP. It allows hosts to join or leave a multicast host group. Group membership information is exchanged between a specific host and the nearest multicast router.

For EtherNet/IP networks it is essential that the switches used, supports IGMP Snooping. IGMP Snooping enables the switch to "listen in" on the IGMP conversation between hosts and routers. By doing this the switch will recognise which hosts are members of which groups, thus being able to forward multicast traffic only to the appropriate hosts.

Spanning Tree Protocol (STP)

For an Ethernet network to function properly, only one active path can exist between two nodes. Spanning-Tree Protocol is a link management protocol that provides path redundancy while preventing undesirable loops in the network.

When loops occur, some switches see stations appear on both sides of it self. This condition confuses the forwarding algorithm and allows for duplicate frames to be forwarded.

To provide path redundancy, Spanning-Tree Protocol defines a tree that spans all switches in an extended network. Spanning-Tree Protocol forces certain redundant data paths into a standby (blocked) state. If one network segment in the Spanning-Tree Protocol becomes unreachable, or if Spanning-Tree Protocol costs change, the spanning-tree algorithm reconfigures the spanning-tree topology and re-establishes the link by activating the standby path.

Spanning-Tree Protocol operation is necessary if the FC 200/FC 300's are running in a ring/redundant line topology.

5

5 How to Control

5.1 How to Control

5.1.1 I/O Assembly Instances

I/O Assembly Instances are a number of defined process control objects with defined content comprising control and status information. Unlike DeviceNet it is possible to run with asymmetrical instances. E.g. 101/153 = 8 bytes/20 bytes.

It is not possible to mix instances across profiles, e.g. 20/100. Assembly instances must be consistent to the: ODVA or FC profile.

The controlling instance can be read in par. 12-20, *Control Instance*.

The figure below shows the I/O Assembly Instance options for controlling and monitoring the FC 200/FC 300 drive.

Profile (par.8-10 <i>Control Word Profile</i>)	Direction	Instances (decimal)	Size (bytes)	Data
ODVA	Originator →Target	20	4	CTW (20) REF
		21	4	CTW (21) REF
	Target →Originator	70	4	STW (70) MAV
		71	4	STW (71) MAV
FC	Originator →Target	100	4	CTW (FC) REF
		101	8	CTW (FC) REF PCD [2] PCD [3]
		103	20	CTW (FC) REF PCD [2] PCD [9]
	Target →Originator	150	4	STW (FC) MAV
		151	8	STW (FC) MAV PCD [2] PCD [9]
		153	20	STW (FC) MAV PCD [2] PCD [9]



NB!

Use of 32-bit process data.

For configuration of a 2-word (32-bit) parameter read/write, use 2 consecutive arrays in par. 12-21 and 12-22, like [2]+[3], [4]+[5], [6]+[7] etc. Read/write of 2-word values in arrays like: [3]+[4], [5]+[6], [7]+[8] are not possible.

5.1.2 EtherNet/ IP Connections

The MCA 121 option supports the CIP connections described in the following sections:

5.1.3 Class 1 connection

I/O connection using TCP transport. Maximum one Class 1 connection is supported by the EtherNet/IP option, but several listen only connection can be established if multicast is selected as Transport type. This type of connection is used for cyclic I/O and Change-Of-State connections. The connection is established with a Forward Open command, containing the following information:

Transport Type:

Specified for both directions:

- Originator-to-Target / Target-to-Originator.
- Point to Point
- Multicast (Target-to-Originator only)

Data Size:

Specified (in bytes) for both directions: Originator -> Target / Target -> Originator.

The data-size depends on the assembly-instance chosen in: *Destination*.

Instances (decimal)		Data Size
Originator →Target	Target →Originator	
20, 21, 100	70, 71, 150	4 bytes
101	151	8 bytes
103	153	20 bytes

Packet Rate:

Specified (in milliseconds) for both directions: Originator -> Target / Target -> Originator.

Minimum packet rate supported: 1 ms

Production Inhibit Timeout:

Specifies (in milliseconds) the timeout-time for both directions.

Trigger:

Selects the transport trigger type:

- Cyclic (Data is transmitted cyclically as polled I/O)
- Change Of State (Data is transmitted on Change of State only. COS-filters are set-up in par. 12-38 COS Filters)

Connection Points

Specified for both directions: Originator -> Target / Target -> Originator.

Profile (par.8-10 <i>Control Word Profile</i>)	Direction	Connection Points (decimal)
ODVA	Originator →Target	20, 21
	Target →Originator	70, 71
FC	Originator →Target	100, 101, 103
	Target →Originator	150, 151, 153

5.1.4 Class 3 connection

Cyclic connection using UDP transport.

Maximum 6 Class 3 connections are supported.

This type of connection is used for explicit messaging. The connection is established with a Forward Open command, containing the following information:

Connection Name:

Given name for the connection

Message Parameters

- Service Code
- Class
- Instance
- Attribute
- Member
- Request Data

5

5.1.5 Unconnected Messages, UCMM

Non-cyclic (single) connection using TCP transport.

This type of connection is used for explicit messaging. The connection is established on-the-fly and does not require any Forward Open command.

Message Parameters

- Service Code
- Class
- Instance
- Attribute
- Member
- Request Data

Please refer to section Appendix for information on accessing CIP objects explicitly.

5.1.6 Control Word Profile

The Control profile is selected in par.8-10 *Control Word Profile*

- ODVA; gives access to the ODVA specific profiles and assembly instances: 20, 21, 70 and 71
- FC; enables the Danfoss profile and assembly instances: 100, 101, 103, 150, 151 and 153

For more information on the different profiles, please refer to the subsequent sections.



NB!

Change of control profile

It is only possible to change the Control profile while the drive is stopped. Control word and reference will not be recalculated to match the selected profile, but are kept at the last good known value.

5.1.7 Change of State, COS

The event controlled operation mode is used to minimize network traffic. Messages are transmitted only if a defined state or value has changed. The condition for triggering a COS message, is determined by the insertion of COS-filters (par. 12-38), for each bit in the different PCD-words. The filter acts like a logical AND-function: If a bit in the filter is set to "1", the COS-function triggers when there is a change to the corresponding bit for the PCD-word.

Parameter 12-38 can be used to filter out undesired events for COS. If a filter bit is set to 0, the corresponding I/O Instance bit will be unable to produce a COS message. By default, all bits in the COS filters are set to 0.

In order to signal that the connection has not been interrupted, or the device is not powered off, a Heartbeat Message is transmitted within a specified time interval (Heartbeat Interval). This interval is defined in Attribute Heartbeat Time of the connection object, Class 0x01.

5

To prevent the device from producing heavy network traffic when a value changes frequently, a Production Inhibit Time is defined in par. 12-37. This parameter defines the minimum time between two COS messages. If par. 12-37 is set to 0, the Production Inhibit Timer is disabled.

The figure below shows the different PCD's and their corresponding filter parameters.

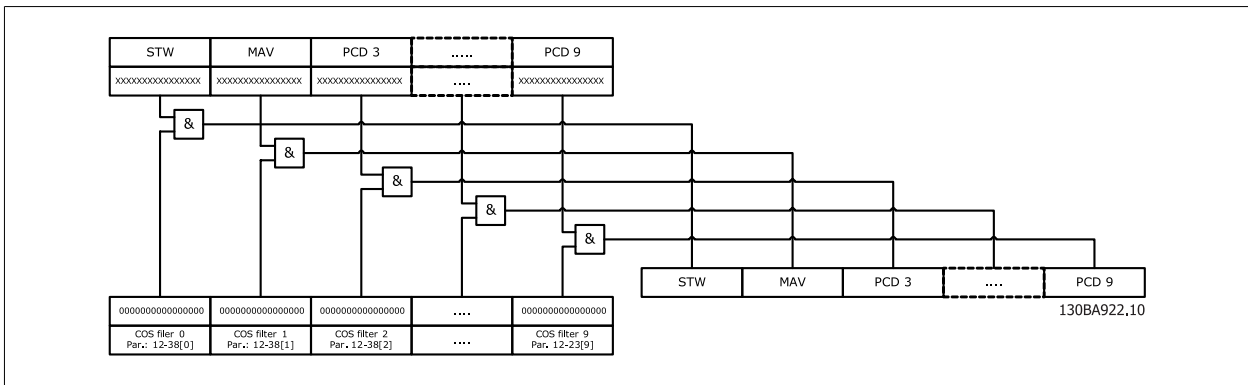

5.2 Danfoss FC Control Profile

5.2.1 Danfoss FC Control Profile

Control Word according to FC ProfileDrive Profile. Instances 100, 101, 103/150, 151, 153

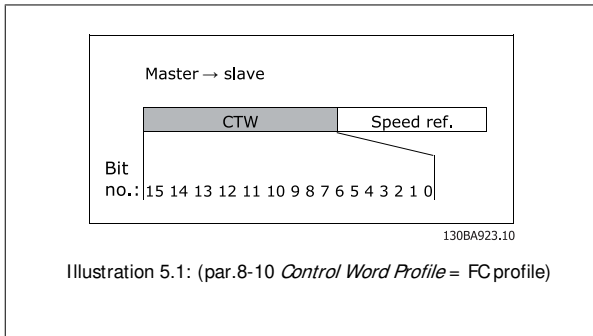

Bit	Bit value = 0	Bit value = 1
00	Reference value	External selection LSB
01	Reference value	External selection MSB
02	DC brake	Ramp
03	Coasting	No coasting
04	Quick stop	Ramp
05	Hold output frequency	Use ramp
06	Ramp stop	Start
07	No function	Reset
08	No function	Jog
09	Ramp 1	Ramp 2
10	Data invalid	Data valid
11	No function	Relay 01 active
12	No function	Relay 04 active
13	Parameter set-up	Selection LSB
14	Parameter set-up	Selection MSB
15	No function	Reverse

Explanation of Control Bits

Bits 00/01

Bits 00 and 01 are used to choose between the four reference values, which are pre-programmed in par. 3-10 *Preset Reference* according to the following table:

Programmed ref. value	Parameter	Bit 01	Bit 00
1	3-10 [0]	0	0
2	3-10 [1]	0	1
3	3-10 [2]	1	0
4	3-10 [3]	1	1

NB!
In par. 8-56 *Preset Reference Select* a selection is made to define how Bit 00/01 gates with the corresponding function on the digital inputs.

Bit 02, DC brake:

Bit 02 = '0' leads to DC braking and stop. Braking current and duration are set in par. 2-01 *DC Brake Current* and par. 2-02 *DC Braking Time*. Bit 02 = '1' leads to ramping, par. 3-41 *Ramp 1 Ramp up Time*

Bit 03, Coasting:

Bit 03 = '0' causes the frequency converter to immediately "let go" of the motor (the output transistors are "shut off"), so that it coasts to a standstill.

Bit 03 = '1' enables the frequency converter to start the motor if the other starting conditions have been fulfilled.

NB!
In par. 8-50 *Coasting Select* a selection is made to define how Bit 03 gates with the corresponding function on a digital input.

Bit 04, Quick stop:

Bit 04 = '0' causes a stop, in which the motor speed is ramped down to stop via par. 3-81 *Quick Stop Ramp Time*.

Bit 05, Hold output frequency:

Bit 05 = '0' causes the present output frequency (in Hz) to freeze. The frozen output frequency can then be changed only by means of the digital inputs (par. 5-10 *Terminal 18 Digital Input* to par. 5-15 *Terminal 33 Digital Input*) programmed to *Speed up* and *Speed down*.

NB!
If Freeze output is active, the frequency converter can only be stopped by the following:

- Bit 03 Coasting stop
- Bit 02 DC braking
- Digital input (par. 5-10 *Terminal 18 Digital Input* to par. 5-15 *Terminal 33 Digital Input*) programmed to *DC braking*, *Coasting stop* or *Reset and coasting stop*

Bit 06. Ramp stop/start:

Bit 06 = '0' causes a stop, in which the motor speed is ramped down to stop via the selected *ramp down* parameter. Bit 06 = '1' permits the frequency converter to start the motor, if the other starting conditions have been fulfilled.

NB!
In par. 8-53 *Start Select* Start select a selection is made to define how Bit 06 Ramp stop/start gates with the corresponding function on a digital input.

Bit 07. Reset:

Bit 07 = '0' no reset. Bit 07 = '1' resets a trip. Reset is activated on the leading edge of the signal, i.e. when changing from logic '0' to logic '1'.

Bit 08. Jog:

Bit 08 = '1' causes the output frequency to be determined by par. 3-19 *Jog Speed [RPM]*.

Bit 09. Selection of ramp 1/2:

Bit 09 = '0' means that ramp 1 is active (par. 3-40 *Ramp 1 Type* to par. 3-47 *Ramp 1 S-ramp Ratio at Decel. Start*). Bit 09 = '1' means that ramp 2 (par. 3-50 *Ramp 2 Type* to par. 3-57 *Ramp 2 S-ramp Ratio at Decel. Start*) is active.

Bit 10. Data not valid/Data valid:

This bit tells the frequency converter whether the control word is to be used or ignored. Bit 10 = '0' causes the control word to be ignored, Bit 10 = '1' causes the control word to be used. The control word is always contained in the telegram, regardless of which type of telegram is used, so this function is useful for 'turning off' the control word when not required for updating or reading parameters.

Bit 11. Relay 01:

Bit 11 = '0' Relay not activated. Bit 11 = '1' Relay 01 activated, provided *Control word bit 11* has been chosen in par. 5-40 *Function Relay*.

Bit 12. Relay 02:

Bit 12 = '0' Relay 02 has not been activated. Bit 12 = '1' Relay 02 has been activated, provided *Control word bit 12* has been chosen in par. 5-40 *Function Relay*.

Bit 13/14. Selection of set-up:

Bits 13 and 14 are used to select one of four menu set-ups according to the following table:

Set-up	Bit 14	Bit 13
1	0	0
2	0	1
3	1	0
4	1	1

The function is only possible when *Multi-Set-ups* is selected in par. 0-10 *Active Set-up*.

NB!
In par. 8-55 *Set-up Select* a selection is made to define how Bit 13/14 gates with the corresponding function on the digital inputs.

Bit 15 Reverse:

Bit 15 = '0' causes no reversing. Bit 15 = '1' causes reversing. Note: In the factory setting reversing is set to *digital* in par.8-54 *Reversing Select*. Bit 15 causes reversing only when *Ser. communication, Logic AND* or *Logic OR* is selected.

5

5.2.2 Status Word according to FC ProfileDrive Profile (STW)

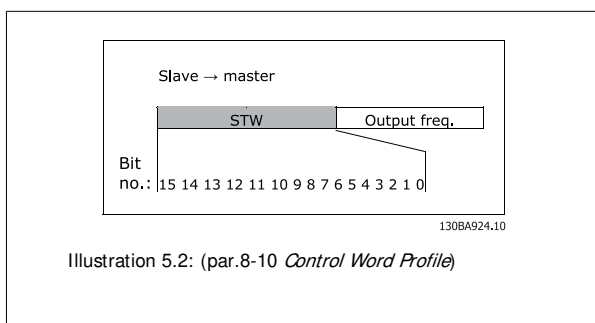

Bit	Bit value = 0	Bit value = 1
00	Control not ready	Control ready
01	Drive not ready	Drive ready
02	Coasting	Enable
03	No error	Trip
04	No error	Error (no trip)
05	Reserved	-
06	No error	Trip lock
07	No warning	Warning
08	Speed ≠ reference	Speed = reference
09	Local operation	Bus control
10	Out of frequency limit	Frequency limit ok
11	No operation	In operation
12	Drive ok	Stopped, auto start
13	Voltage ok	Voltage exceeded
14	Torque ok	Torque exceeded
15	Thermal ok	Thermal exceeded

Explanation of the Status Bits

Bit 00, Control ready:

Bit 00 = '0' means that the frequency converter has tripped. Bit 00 = '1' means that the frequency converter controls are ready, but that the power component is not necessarily receiving any power supply (in the event of external 24 V supply to controls).

Bit 01, Drive ready:

Bit 01 = '1'. The frequency converter is ready for operation.

Bit 02, Coasting stop:

Bit 02 = '0'. The frequency converter has released the motor. Bit 02 = '1'. The frequency converter can start the motor when a start command is given.

Bit 03, No error/Trip:

Bit 03 = '0' means that the frequency converter is not in fault mode. Bit 03 = '1' means that the frequency converter is tripped, and that a reset signal is required to re-establish operation.

Bit 04, No error/Error (no trip):

Bit 04 = '0' means that the frequency converter is not in fault mode. Bit 04 = '1' means that there is a frequency converter error but no trip.

Bit 05, Reserved:

Bit 05 is not used in the status word.

Bit 06, No error / Trip lock:

Bit 06 = '0' means that the frequency converter is not in fault mode. Bit 06 = '1' means that the frequency converter is tripped, and locked.

Bit 07, No warning/Warning:

Bit 07 = '0' means that there are no warnings. Bit 07 = '1' means that a warning has occurred.

Bit 08, Speed≠ reference/Speed = reference:

Bit 08 = '0' means that the motor is running, but that the present speed is different from the preset speed reference. For example, this might occur while the speed is being ramped up/down during start/stop. Bit 08 = '1' means that the present motor speed matches the preset speed reference.

Bit 09, Local operation/Bus control:

Bit 09 = '0' means that [STOP/RESET] is activated on the control unit, or that Local control in par. 3-13 *Reference Ste* is selected. It is not possible to control the frequency converter via serial communication. Bit 09 = '1' means that it is possible to control the frequency converter via the field-bus/ serial communication.

Bit 10, Out of frequency limit:

Bit 10 = '0', if the output frequency has reached the value in par. 4-11 *Motor Speed Low Limit [RPM]* or par. 4-13 *Motor Speed High Limit [RPM]*. Bit 10 = '1' means that the output frequency is within the defined limits.

Bit 11, No operation/In operation:

Bit 11 = '0' means that the motor is not running. Bit 11 = '1' means that the frequency converter has a start signal or that the output frequency is greater than 0 Hz.

Bit 12, Drive OK/Stopped, auto start:

Bit 12 = '0' means that there is no temporary over temperature on the inverter. Bit 12 = '1' means that the inverter has stopped because of over temperature, but that the unit has not tripped and will resume operation once the over temperature stops.

Bit 13, Voltage OK/Voltage exceeded:

Bit 13 = '0' means that there are no voltage warnings. Bit 13 = '1' means that the DC voltage in the frequency converter's intermediate circuit is too low or too high.

Bit 14, Torque OK/Torque limit exceeded:

Bit 14 = '0' means that the motor current is lower than the torque limit selected in par. 4-16 and 4-17 Torque limit. Bit 14 = '1' means that the torque limit in par. 4-16 and 4-17 Torque limit has been exceeded. The nominal torque can be read in par. 16-16 *Torque [Nm]*.

Bit 15, Thermal OK/limit exceeded:

Bit 15 = '0' means that the timers for both motor thermal protection and VLT thermal protection, have not exceeded 100%. Bit 15 = '1' means that one of the limits has exceeded 100%.

5.3 ODVA Control Profile

5.3.1 Control Word under Instances 20/ 70 and 21/ 71

Set par.8-10 *Control Word Profile* to ODVA.

The control word in Instances 20 and 21 is defined as follows:

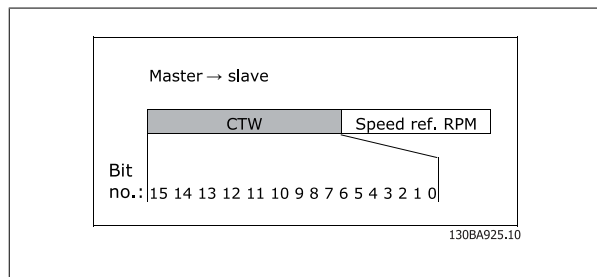

NB!
Bits 00 and 02 in Instance 20 are identical with bits 00 and 02 in the more extensive Instance 21.

Bit	Instance 20		Instance 21	
	Bit = 0	Bit = 1	Bit = 0	Bit = 1
00	Stop	Run	Fwd Stop	Run Fwd
01	-	-	Stop	Run Rev
02	No function	Fault reset	No function	Fault reset
03	-	-	-	-
04	-	-	-	-
05	-	-	-	Net Ctrl
06	-	-	-	Net Ref
07-15	-	-	-	-

Explanation of the Bits:

Bit 0, Run Fwd:

Bit 0 = "0" means that the VLT frequency converter has a stop command.
 Bit 0 = "1" leads to a start command and the VLT frequency converter will start to run the motor clockwise.

Bit 1, Run Rev:

Bit 1 = "0" leads to a stop of the motor. Bit 1 = "1" leads to a start of the motor.

Bit 2, Fault Reset:

Bit 2 = "0" means that there is no trip reset. Bit 2 = "1" means that a trip is reset.

Bit 3, No function:

Bit 3 has no function.

Bit 4, No function:

Bit 4 has no function.

Bit 5, Net Control:

Bit 5 = "0" means that the drive is controlled from the standard inputs.
 Bit 5 = "1" means that EIP controls the drive.

NB!
 Please note that changes will affect parameters 8-50 to 8-56.

Bit 6, Net Reference:

Bit 6 = "0" Reference is from the standard inputs. Bit 6 = "1" Reference is from EIP.

NB!
 Please note that changes will affect par. 3-15 *Reference Resource 1* to par. 3-17 *Reference Resource 3*.
 For the Speed reference, see section *Bus speed reference value under Instances 20/70 and 21/71*.

5.3.2 Status Word under Instances 20/ 70 and 21/ 71

The status word in Instances 70 and 71 is defined as follows:

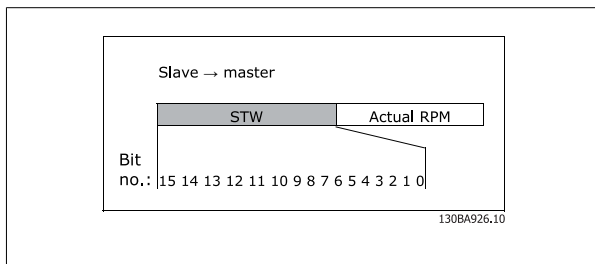

NB!
 Bits 00 and 02 in Instance 70 are identical with bits 00 and 02 in the more extensive Instance 71.

Bit	Instance 70		Instance 71	
	Bit = 0	Bit = 1	Bit = 0	Bit = 1
00	No Fault	Fault	No Fault	Fault
01	-	-	-	Warning
02	-	Running 1 Fwd	-	Running 1 Fwd
03	-	-	-	Running 2 Rev.
04	-	-	-	Ready
05	-	-	-	Ctrl from Net
06	-	-	-	Ref. from Net
07	-	-	-	At ref.
08-15	-	-	State Attribute	

Explanation of the Bits:

Bit 0, Fault:

Bit 0 = "0" means that there is no fault in the frequency converter. Bit 0 = "1" means that there is a fault in the frequency converter.

Bit 1, Warning:

Bit 0 = "0" means that there is no unusual situation. Bit 0 = "1" means that an abnormal condition has occurred.

Bit 2, Running 1:

Bit 2 = "0" means that the drive is not in one of these states or that Run 1 is not set. Bit 2 = "1" means that the drive state attribute is enabled or stopping, or that Fault-Stop and bit 0 (Run 1) of the control word are set at the same time.

Bit 3, Running 2:

Bit 3 = "0" means that the drive is in neither of these states or that Run 2 is not set. Bit 3 = "1" means that the drive state attribute is enabled or stopping, or that fault-stop and bit 0 (Run 2) of the control word are set at the same time.

Bit 4, Ready:

Bit 4 = "0" means that the state attribute is in another state. Bit 4 = "1" means that the state attribute is ready, enabled or stopping.

Bit 5, Control from net:

Bit 5 = "0" means that the drive is controlled from the standard inputs. Bit 5 = "1" means that EIP has control (start, stop, reverse) of the drive.

Bit 6, Ref from net:

Bit 6 = "0" means that the reference comes from inputs to the drive. Bit 6 = "1" means that the reference comes from EIP.

Bit 7, At reference:

Bit 7 = "0" means that the motor is running, but that the present speed is different from the preset speed reference, i.e. the speed is being ramped up/down during start/stop. Bit 7 = "1" means that the drive and reference speeds are equal.

Bit 8 - 15, State attribute:

(Instance 71 only) Represents the state attribute of the drive, as indicated in the following table:

Bit Number	Meaning
8	(Vendor specific)
9	Start up
10	Not ready
11	Ready
12	Enabled
13	Stopping
14	Fault stop
15	Faulted

For more detail of the actual output speed, see the section *Actual output speed under Instances 20/70 and 21/71.*

5.4 Reference Handling

5.4.1 Bus Speed Reference Value under Instances 100-101-103/ 150-151-153

In FC-Profile (par. 8-10 = [0] FC profile) the reference is scaled as a normalized relative value in percent. The value is transmitted in hexadecimal:

- 0% = 0hex
- 100% = 4000hex
- 100% = C000hex

Depending of the setting of par. 3-00 *Reference Range*, the reference is scaled from - Max. to + Max. or from Min. to Max.

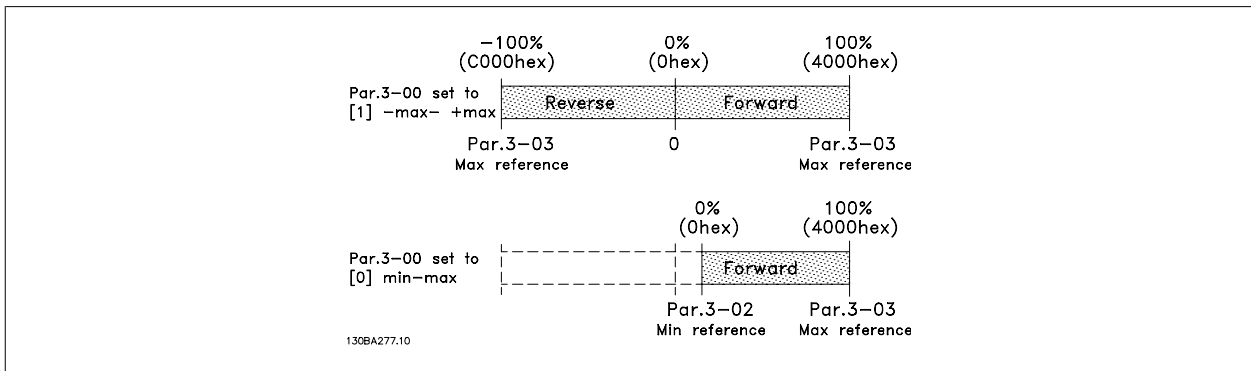

The actual reference [Ref. %] in the VLT frequency converter depends on the settings in the following parameters:

- Par. 1-23 *Motor Frequency*
- Par. 1-25 *Motor Nominal Speed*
- Par. 3-02 *Minimum Reference*
- Par. 3-03 *Maximum Reference*

All references provided to the frequency converter are added to the total reference value. If a reference is to be controlled by the fieldbus only, ensure that all other reference inputs are zero.

This means that digital and analogue input terminals should not be used for reference signals. The default setting (0%) should be maintained for preset references in par. 3-10 *Preset Reference*.

NB!
If the bus speed reference is negative, and the control word contains a run reverse signal, the drive will run clockwise (- is +).

MAV is scaled in the same way as the reference.

5.4.2 Bus Speed Reference Value under Instances 20/ 70 and 21/ 71

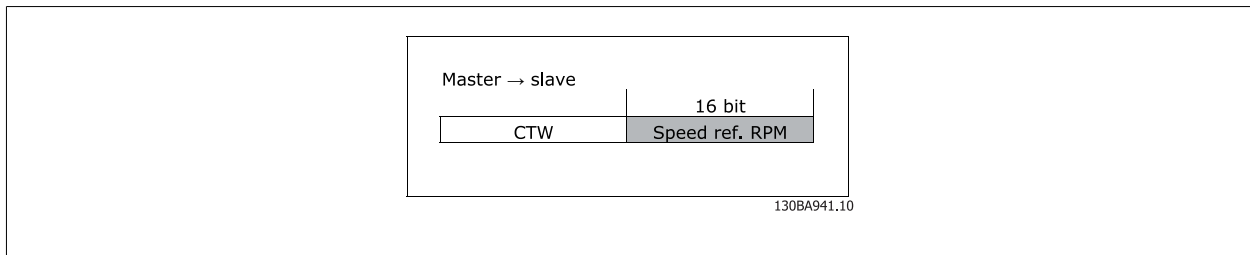

The speed reference value should be transmitted to the VLT frequency converter in the form of a 16-bit word. The value is transmitted directly in RPM.

5

6 Parameters

6.1 Parameter Group 8- * *

8-01 Control Site

Option:

Function:

The setting in this parameter overrides the settings in par.8-50 *Coasting Select* to par.8-56 *Preset Reference Select*.

[0] *	Digital and ctrl.word	Control by using both digital input and control word.
[1]	Digital only	Control by using digital inputs only.
[2]	Controlword only	Control by using control word only.

8-02 Control Word Source

Select the source of the control word: one of two serial interfaces or four installed options. During initial power-up, the frequency converter automatically sets this parameter to *Option A* [3] if it detects a valid fieldbus option installed in slot A. If the option is removed, the frequency converter detects a change in the configuration, sets par.8-02 *Control Word Source* back to default setting *FCRS485*, and the frequency converter then trips. If an option is installed after initial power-up, the setting of par.8-02 *Control Word Source* will not change but the frequency converter will trip and display: Alarm 67 *Option Changed*.

This parameter cannot be adjusted while the motor is running.

Option:

Function:

[0]	None
[1]	FC RS485
[2]	FC USB
[3] *	Option A
[4]	Option B
[5]	Option C0
[6]	Option C1

8-03 Control Word Timeout Time

Range:

Function:

1.0 s* [0.1 - 18000.0 s]

Enter the maximum time expected to pass between the reception of two consecutive telegrams. If this time is exceeded, it indicates that the serial communication has stopped. The function selected in par.8-04 *Control Word Timeout Function* will then be carried out. The time-out counter is triggered by a valid control word.

8-04 Control Word Timeout Function

Select the time-out function. The time-out function activates when the control word fails to be updated within the time period specified in par.8-03 *Control Word Timeout Time*.

Option:

Function:

[0] *	Off	Resumes control via serial bus (Fieldbus or standard) using the most recent control word.
[1]	Freeze output	Freezes output frequency until communication resumes.
[2]	Stop	Stops with auto restart when communication resumes.
[3]	Jogging	Runs the motor at JOG frequency until communication resumes.
[4]	Max. speed	Runs the motor at maximum frequency until communication resumes.
[5]	Stop and trip	Stops the motor, then resets the frequency converter in order to restart: via the fieldbus, via the reset button on the LCP or via a digital input.
[7]	Select setup 1	Changes the set-up upon reestablishment of communication following a control word time-out. If communication resumes causing the time-out situation to disappear, par.8-05 <i>End-of-Timeout</i>

Function defines whether to resume the set-up used before the time-out or to retain the set-up endorsed by the time-out function.

[8]	Select setup 2	See [7] <i>Select setup 1</i>
[9]	Select setup 3	See [7] <i>Select setup 1</i>
[10]	Select setup 4	See [7] <i>Select setup 1</i>



NB!

The following configuration is required in order to change the set-up after a time-out:

Set par. 0-10 *Active Set-up* to [9] *Multi set-up* and select the relevant link in par. 0-12 *This Set-up Linked to*.

8-05 End-of-Timeout Function

Option: **Function:**

Select the action after receiving a valid control word following a time-out. This parameter is active only when par. 8-04 *Control Timeout Function* is set to [Set-up 1-4].

[0]	Hold set-up	Retains the set-up selected in par. 8-04 <i>Control Timeout Function</i> and displays a warning, until par. 8-06 <i>Reset Control Timeout</i> toggles. Then the frequency converter resumes its original set-up.
[1] *	Resume set-up	Resumes the set-up active prior to the time-out.

8-06 Reset Control Word Timeout

This parameter is active only when *Hold set-up* [0] has been selected in par.8-05 *End-of-Timeout Function*.

Option: **Function:**

[0] *	Do not reset	Retains the set-up specified in par.8-04 <i>Control Word Timeout Function</i> , following a control word time-out.
[1]	Do reset	Returns the frequency converter to the original set-up following a control word time-out. The frequency converter performs the reset and then immediately reverts to the <i>Do not reset</i> [0] setting

8-10 Control Word Profile

Select the interpretation of the control and status words corresponding to the installed fieldbus. Only the selections valid for the fieldbus installed in slot A will be visible in the LCP display.

For guidelines in selection of *FC profile* [0] and *PROFIdrive profile* [1] please refer to the *Serial communication via RS 485 Interface* section.

For additional guidelines in the selection of *PROFIdrive profile* [1], *ODVA* [5] and *CANopen DSP 402* [7], please refer to the Operating Instructions for the installed fieldbus.

Option: **Function:**

[0] *	FC profile
[5]	ODVA

8-13 Configurable Status Word STW

Option: **Function:**

This parameter enables configuration of bits 12 – 15 in the status word.

[0]	No function	
[1] *	Profile Default	Function corresponds to the profile default selected in par. 8-10 <i>Control Profile</i> .
[2]	Alarm 68 Only	Only set in case of an Alarm 68.
[3]	Trip excl Alarm 68	Set in case of a trip, except if the trip is executed by an Alarm 68.
[16]	T37 DI status	The bit indicates the status of terminal 37. "0" indicates T37 is low (safe stop) "1" indicates T37 is high (normal)

8-14 Configurable Control Word CTW

Option:

Function:

Selection of control word bit 10 if it is active low or active high

[0] None

[1] * Profile default

[2] CTW Valid, active low

8-50 Coasting Select

Option:

Function:

Select control of the coasting function via the terminals (digital input) and/or via the bus.

[0] Digital input

[1] Bus

Activates Start command via the serial communication port or fieldbus option.

[2] Logic AND

Activates Start command via the fieldbus/serial communication port, AND additionally via one of the digital inputs.

[3] * Logic OR

Activates Start command via the fieldbus/serial communication port OR via one of the digital inputs.



NB!

This parameter is active only when par.8-01 *Control Ste* is set to [0] *Digital and control word*.

[3] * Logic OR Activates the Reverse command via the fieldbus/serial communication port OR via one of the digital inputs.

NB!
This parameter is only active when par. 8-01 *Control Site* is set to [0] *Digital and control word*.

8-55 Set-up Select

Option:	Function:
	Select control of the frequency converter set-up selection via the terminals (digital input) and/or via the fieldbus.
[0] Digital input	Activates the set-up selection via a digital input.
[1] Bus	Activates the set-up selection via the serial communication port or fieldbus option.
[2] Logic AND	Activates the set-up selection via the fieldbus/serial communication port, AND additionally via one of the digital inputs.
[3] * Logic OR	Activate the set-up selection via the fieldbus/serial communication port OR via one of the digital inputs.

NB!
This parameter is active only when par.8-01 *Control Site* is set to [0] *Digital and control word*.

8-56 Preset Reference Select

Option:	Function:
	Select control of the frequency converter Preset Reference selection via the terminals (digital input) and/or via the fieldbus.
[0] Digital input	Activates Preset Reference selection via a digital input.
[1] Bus	Activates Preset Reference selection via the serial communication port or fieldbus option.
[2] Logic AND	Activates Preset Reference selection via the fieldbus/serial communication port, AND additionally via one of the digital inputs.
[3] * Logic OR	Activates the Preset Reference selection via the fieldbus/serial communication port OR via one of the digital inputs.

NB!
This parameter is active only when par.8-01 *Control Site* is set to [0] *Digital and control word*.

6.2 Parameter Group 12-* *

6.2.1 IP Settings

12-00 IP Address Assignment

Option:	Function:
	Selects the IP Address assignment method.
[0] * Manual	IP-address can be set in par. 12-01 IP Address.
[1] DHCP	IP-address is assigned via DHCP server.
[2] BOOTP	IP-address is assigned via BOOTP server.

12-01 IP Address

Range: [000.000.000.000 - 255.255.255.255]
Function: - Configure the IP address of the option. Read-only if par. 12-00 set to DHCP or BOOTP.

12-02 Subnet Mask

Range: [000.000.000.000 - 255.255.255.255]
Function: - Configure the IP subnet mask of the option. Read-only if par. 12-00 set to DHCP or BOOTP.

12-03 Default Gateway

Range: [000.000.000.000 - 255.255.255.255]
Function: - Configure the IP default gateway of the option. Read-only if par. 12-00 set to DHCP or BOOTP.

12-04 DHCP Server

Range: [000.000.000.000 - 255.255.255.255]
Function: - Read only. Displays the IP address of the found DHCP or BOOTP server.



NB!
 A power-cycle is necessary after setting the IP parameters manually.

12-05 Lease Expires

Range: [dd:hh:mm:ss]
Function: Read only. Displays the lease-time left for the current DHCP-assigned IP address.

12-06 Name Servers

Option: [0] Primary DNS
 [1] Secondary DNS
Function: IP addresses of Domain Name Servers. Can be automatically assigned when using DHCP.

12-07 Domain Name

Range: Blank [0-19 characters]
Function: Domain name of the attached network. Can be automatically assigned when using DHCP.

12-08 Host Name

Range: Blank [0-19 characters]
Function: Logical (given) name of option.

12-09 Physical Address

Range: [00:1B:08:00:00:00 - 00:1B:08:FF:FF:FF]
Function: Read only Displays the Physical (MAC) address of the option.

6.2.2 Ethernet Link Parameters**12-1* Ethernet Link Parameters**

Option:
Function: Applies for whole parameter group.

- [0] Port 1
- [1] Port 2

12-10 Link Status

Option: **Function:**
Read only. Displays the link status of the Ethernet ports.

- [0] No link
- [1] Link

12-11 Link Duration

Option: **Function:**
Link Duration Port 1 (dd:hh:mm:ss) Read only. Displays the duration of the present link on each port in dd:hh:mm:ss.

12-12 Auto Negotiation

Option: **Function:**
Configures Auto Negotiation of Ethernet link parameters, for each port: ON or OFF.

- [0] Off *Link Speed and Link Duplex can be configured in par. 12-13 and 12-14.*
- [1] On

12-13 Link Speed

Option: **Function:**
Forces the link speed for each port in 10 or 100 Mbps. If par. 12-12 is set to: ON, this parameter is read only and displays the actual link speed. "None" is displayed if no link is present.

- [0] * None
- [1] 10 Mbps
- [2] 100 Mbps

12-14 Link Duplex

Option: **Function:**
Forces the duplex for each port to Full or Half duplex. If par. 12-12 is set to: ON, this parameter is read only.

- [0] Half duplex
- [1] * Full duplex

6.2.3 Process Data

12-20 Control Instance

Range: **Function:**
[None, 20, 21, 100, 101, 103] Read only. Displays the originator-to-target connection point. If no CIP connection is present "None" is displayed.

12-21 Process Data Config Write

Range: **Function:**
[[0 - 9] PCD read 0 - 9] Configuration of readable process data.



NB!
 For configuration of 2-word (32-bit) parameter read/write, use 2 consecutive arrays in par. 12-21 and 12-22.

12-22 Process Data Config Read

Range: [[0 - 9] PCD read 0 - 9]
Function: Configuration of readable process data.

12-28 Store Data Values

Option:
Function: This parameter activates a function that stores all parameter values in the non-volatile memory (EEPROM) thus retaining parameter values at power-down. The parameter returns to "Off".

[0] * Off The store function is inactive.
 [1] Store All set-ups All parameter value will be stored in the non-volatile memory, in all four setups.

12-29 Store Always

Option:
Function: Activates function that will always store received parameter data in non-volatile memory (EEPROM).

[0] * Off
 [1] On

6

6.2.4 EtherNet/IP

12-30 Warning Parameter

Range: [0000 – FFFF hex]
Function: Read only. Displays the EtherNet/IP specific 16-bit Status-word.

Bit	Description
0	Owned
1	Not used
2	Configured
3	Not used
4	Not used
5	Not used
6	Not used
7	Not used
8	Minor recoverable fault
9	Minor unrecoverable fault
10	Major recoverable fault
11	Major unrecoverable fault
12	Not used
13	Not used
14	Not used
15	Not used

12-31 Net Reference

Option:
Function: Read only. Displays the reference source in Instance 21/71.

[0] * Off Reference from the network is not active.
 [1] On Reference from the network is active.

12-32 Net Control

Option:
Function: Read only. Displays the control source in Instance 21/71.

[0] * Off Control via the network is not active.

[1] On Control via the network is active

12-33 CIP Revision

Option: **Function:**
Read only. Displays the CIP-version of the option software.

[0] Major version (00 - 99)

[1] Minor version (00 - 99)

12-34 CIP Product Code

Range: **Function:**
1100 (FC [0 - 9999])
302) 1110
(FC301)*
Read only. Displays the CIP product code.

12-37 COS Inhibit Timer

Range: **Function:**
[0 - 65.535 ms]
Read only Change-Of-State inhibit timer. If the option is configured for COS operation, this inhibit timer can be configured in the Forward Open telegram to prevent that continuously changing PCD data generates extensive network traffic. The inhibit time is in milliseconds, 0 = disabled.

12-38 COS Filters

Range: **Function:**
[[0 - 9] Filter 0 - 9 (0000 - FFFFhex)]
Change-Of-State PCD filters. Sets up a filter mask for each word of process data when operating in COS-mode. Single bits in the PCD's can be filtered in/out.

6.2.5 Other EtherNet Services

12-80 FTP Server

Option: **Function:**
[0] * Disable Disables the built-in FTP server.
[1] Enable Enables the built-in FTP server.

12-81 HTTP Server

Option: **Function:**
[0] * Disable Disables the build-in HTTP (web) server.
[1] Enable Enables the build-in HTTP (web) server.

12-82 SMTP Service

Option: **Function:**
[0] * Disable Disables the SMTP (e-mail) service on the option.
[1] Enable Enables the SMTP (e-mail) service on the option.

12-89 Transparent Socket Channel Port

Range: **Function:**
0* [0 - 9999]
Configures the TCP port-number for the transparent socket channel. This enables FC-telegrams to be sent transparently on Ethernet via TCP. Default value is 4000, 0 means disabled.

6.2.6 Advanced EtherNet Settings

12-90 Cable Diagnostics

Option:

Function:

Enables/disables advanced Cable diagnosis function. If enabled, the distance to cable errors can be read out in par. 12-93. The parameter resumes to the default setting of Disable after the diagnostics have finished.

[0] * Disable

[1] Enable



NB!

The cable diagnostics function will only be issued on ports where there is no link (see par. 12-10, *Link Status*)

12-91 Auto Cross-Over

Option:

Function:

[0] Disable

Disables the auto cross-over function.

[1] * Enable

Enables the auto cross-over function.



NB!

Disabling of the auto cross-over function will require crossed Ethernet cables for daisy-chaining the options.

12-92 IGMP Snooping

Option:

Function:

This prevents flooding of the Ethernet protocol stack by only forwarding multicast packets to ports that are a member of the multicast group

[0] Disable

Disables the IGMP snooping function.

[1] * Enable

Enables the IGMP snooping function.

12-93 Cable Error Length

Option:

Function:

If Cable Diagnostics is enabled in par. 12-90, the built-in switch is able via Time Domain Reflectometry (TDR). This is a measurement technique which detects common cabling problems such as open circuits, short circuits and impedance mismatches or breaks in transmission cables. The distance from the option to the error is displayed in meters with an accuracy of +/- 2m. The value 0 means no errors detected.

[0] Error length Port 1 (0 – 200m)

[1] Error length Port 2 (0 – 200m)

12-94 Broadcast Storm Protection

Option:

Function:

The built-in switch is capable of protecting the switch system from receiving too many broadcast packages, which can use up network resources. The value indicates a percentage of the total bandwidth that is allowed for broadcast messages.

Example:

The "OFF" means that the filter is disabled –all broadcast messages will be passed through. The value "0%" means that no broadcast messages will be passed through. A value of "10%" means that 10% of the total bandwidth is allowed for broadcast messages, if the amount of broadcast messages increases above the 10% threshold, they will be blocked.

[0] Protection Value Port 1 (* Off – 20%)

[1] Protection Value Port 2 (* Off – 20%)

12-95 Broadcast Storm Filter

Option:

Function:

Applies to par. 12-94; if the Broadcast Storm Protection should also include Multicast telegrams.

[0] Broadcast only

[1] Broadcast & Multicast

12-98 Interface Counters

Option:

Function:

Read only. Advanced Interface counters, from build-in switch, can be used for low-level troubleshooting. The parameter shows a sum of port 1 + port 2.

[0] In Octets

[1] In Unicast Packets

[2] In Non-Unicast Packets

[3] In Discards

[4] In Errors

[5] In Unknown Protocols

[6] Out Octets

[7] Out Unicast Packets

[8] Out Non-Unicast Packets

[9] Out Discards

[10] Out Errors

12-99 Media Counters

Option:

Function:

Read only. Advanced Interface counters, from build-in switch, can be used for low-level troubleshooting. The parameter shows a sum of port 1 + port 2.

[0] Alignment Errors

[1] FCS Errors

[2] Single Collisions

[3] Multiple Collisions

[4] SQE Test Errors

[5] Deferred Errors

[6] Late Collisions

[7] Excessive Collisions

[8] MAC Transmit Errors

[9] Carrier Sense Errors

[10] Frame Too Long

[11] MAC Receive Errors

6.3 Parameter List

Par. No. #	Parameter description	Default value	4-set-up	FC 302 only	Change during operation	Conversion index	Type
8-0* General Settings							
8-01	Control Ste	[0] Digital and ctrl.word	All set-ups		TRUE	-	Uint8
8-02	Control Word Source	null	All set-ups		TRUE	-	Uint8
8-03	Control Word Timeout Time	1.0 s	1 set-up		TRUE	-1	Uint32
8-04	Control Word Timeout Function	null	1 set-up		TRUE	-	Uint8
8-05	End-of-Timeout Function	[1] Resume set-up	1 set-up		TRUE	-	Uint8
8-06	Reset Control Word Timeout	[0] Do not reset	All set-ups		TRUE	-	Uint8
8-07	Diagnosis Trigger	[0] Disable	2 set-ups		TRUE	-	Uint8
8-1* Ctrl. Word Settings							
8-10	Control Word Profile	[0] FC profile	All set-ups		TRUE	-	Uint8
8-13	Configurable Status Word STW	[1] Profile default	All set-ups		TRUE	-	Uint8
8-14	Configurable Control Word CTW	[1] Profile default	All set-ups		TRUE	-	Uint8
8-3* FC Port Settings							
8-30	Protocol	[0] FC	1 set-up		TRUE	-	Uint8
8-31	Address	1 N/A	1 set-up		TRUE	0	Uint8
8-32	FC Port Baud Rate	null	1 set-up		TRUE	-	Uint8
8-33	Parity / Stop Bits	[0] Even Parity, 1 Stop Bit	1 set-up		TRUE	-	Uint8
8-35	Minimum Response Delay	10 ms	All set-ups		TRUE	-3	Uint16
8-36	Max Response Delay	SR	1 set-up		TRUE	-3	Uint16
8-37	Max Inter-Char Delay	SR	1 set-up		TRUE	-3	Uint16
8-4*	FC MC protocol set						
8-40	Telegram selection	[1] Standard telegram 1	2 set-ups		TRUE	-	Uint8
8-5* Digital/ Bus							
8-50	Coasting Select	[3] Logic OR	All set-ups		TRUE	-	Uint8
8-51	Quick Stop Select	[3] Logic OR	All set-ups		TRUE	-	Uint8
8-52	DC Brake Select	[3] Logic OR	All set-ups		TRUE	-	Uint8
8-53	Start Select	[3] Logic OR	All set-ups		TRUE	-	Uint8
8-54	Reversing Select	[3] Logic OR	All set-ups		TRUE	-	Uint8
8-55	Set-up Select	[3] Logic OR	All set-ups		TRUE	-	Uint8
8-56	Preset Reference Select	[3] Logic OR	All set-ups		TRUE	-	Uint8
8-8* FC Port Diagnostics							
8-80	Bus Message Count	0 N/A	All set-ups		TRUE	0	Uint32
8-81	Bus Error Count	0 N/A	All set-ups		TRUE	0	Uint32
8-82	Slave Messages Rcvd	0 N/A	All set-ups		TRUE	0	Uint32
8-83	Slave Error Count	0 N/A	All set-ups		TRUE	0	Uint32
8-9* Bus Jog							
8-90	Bus Jog 1 Speed	100 RPM	All set-ups		TRUE	67	Uint16
8-91	Bus Jog 2 Speed	200 RPM	All set-ups		TRUE	67	Uint16

Parameter Number	Parameter Description	Default Value	Range	Conversion Index	Data Type	Array
12-0* IP Settings						
12-00	IP Address Assignment	0.0.0.0	0 - 255	-	Unsigned 8	-
12-01	IP Address	0.0.0.0	0 - 255	-	Oct. string 4	-
12-02	Subnet Mask	0.0.0.0	0 - 255	-	Oct. string 4	-
12-03	Default Gateway	0.0.0.0	0 - 255	-	Oct. string 4	-
12-04	DHCP Server	0.0.0.0	0 - 255	-	Oct. string 4	-
12-05	Lease Expires	00:00:00:00	-	-	Time diff. w/date	-
12-06	Name Servers	0.0.0.0	0 - 255	-	Oct. string 4	-
12-07	Domain Name	-	max. 19 ch.	-	Visible string 48	-
12-08	Host Name	-	max. 19 ch.	-	Visible string 48	-
12-09	Physical Address	00:1B:08:00:00:00	-	-	Visible string 17	-
12-1* EtherNet Link Parameters						
12-10	Link Status	No Link [0]	[0 - 1]	-	Unsigned 8	[0-1]
12-11	Link Duration	00:00:00:00	-	-	Time diff. w/date	[0-1]
12-12	Auto Negotiation	On [1]	[0 - 1]	-	Unsigned 8	[0-1]
12-13	Link Speed	None [0]	[0 - 2]	-	Unsigned 8	[0-1]
12-14	Link Duplex	Full Duplex [1]	[0 - 1]	-	Unsigned 8	[0-1]
12-2* Process Data						
12-20	Control Instance	None	20 - 103	-	Unsigned 8	-
12-21	Process Data Config Write	-	-	-	Unsigned 16	[0-9]
12-22	Process Data Config Read	-	-	-	Unsigned 16	[0-9]
12-28	Store Data Values	Off [0]	[0 - 1]	-	Unsigned 8	-
12-29	Store Always	Off [0]	[0 - 1]	-	Unsigned 8	-
12-3* EtherNet/IP						
12-30	Warning Parameter	0000 hex	0000-FFFF	-	Unsigned 16	-
12-31	Net Control	Off [0]	[0 - 1]	-	Unsigned 8	-
12-32	Net Reference	Off [0]	[0 - 1]	-	Unsigned 8	-
12-33	CIP Revision	00	0 - 99	-	Unsigned 16	[0-1]
12-34	CIP Product Code	0	9999	-	Unsigned 16	[0-1]
12-37	COS Inhibit Timer	0	0 - 65535	0	Unsigned 16	-
12-38	COS Filters	0000	0000 - FFFF	-	Unsigned 16	[0-9]
12-8* Other EtherNet Services						
12-80	FTP Server	Disable [0]	[0 - 1]	-	Unsigned 8	-
12-81	HTTP Server	Disable [0]	[0 - 1]	-	Unsigned 8	-
12-82	SMTP Service	Disable [0]	[0 - 1]	-	Unsigned 8	-
12-89	Transp. Socket Channel Port	Disable [0]	[0 - 1]	-	Unsigned 8	-
12-9* Advanced EtherNet Settings						
12-90	Cable Diagnostics	Disable [0]	[0 - 1]	-	Unsigned 8	-
12-91	Auto Cross-Over	Enable [0]	[0 - 1]	-	Unsigned 8	-
12-92	IGMP Snooping	Enable [0]	[0 - 1]	-	Unsigned 8	-
12-93	Cable Error Length	0	0 - 200	0	Unsigned 16	[0-1]
12-94	Broadcast Storm Protection	0	Off - 20%	-	Unsigned 16	[0-1]
12-95	Broadcast Storm Filter	Enable [1]	[0 - 1]	-	Unsigned 8	[0-1]
12-98	Interface Counters	0	0 - 65535	-	Unsigned 16	[0-10]
12-99	Media Counters	0	0 - 65535	-	Unsigned 16	[0-1]

6.4 Data Types

6.4.1 Data Types Supported by FC 200/ FC 300

Conversion Index

This number to the left refers to a conversion figure on the right to be used when writing or reading parameters.

Conversion Index	Conversion Factor
67	1/60
6	1000000
5	100000
4	10000
3	1000
2	100
1	10
0	1
-1	0.1
-2	0.01
-3	0.001
-4	0.0001
-5	0.00001
-6	0.000001

7 Troubleshooting

7.1.1 Step-by-step Troubleshooting

Check: LEDs

The option contains two LEDs to indicate the state of the device and the network. During normal operation the MS and at least one NS LED will show a constant green light.

State	LED	Description	
Standby	Green:	Flashing green	The device needs commissioning
Device operational	Green:	Solid green	The device is operational
Major recoverable fault		Flashing red	The device has detected a recoverable fault (MAR)
Major unrecoverable fault	Red:	Solid red	The device has detected a un-recoverable fault (MAU)
Self test	Red:	Flashing red/green	The EIP option is in self-test mode
	Green:		

Table 7.1: MS: Module Status

State	LED	Description	
No connections	Green:	Flashing green	There are no established any CIP connections to the device
Connected	Green:	Solid green	There is established (at least) one CIP connection to the device
Connection time-out	Red:	Flashing red	One or more CIP connections has timed-out
Duplicate IP	Red:	Solid red	The IP-address assigned to the device is already in use
Self test	Red:	Flashing red/green	The EIP option is in self-test mode
	Green:		

Table 7.2: NS1 + NS2: Network Status (one per port)

Check: Link Status

The status of the Ethernet link cannot be directly identified by means of the LEDs, if no CIP connection is established.

Use par. 12-10, *Link Status* to verify presents of the link.

Use par. 12-11, *Link Duration* to verify that the link is steady present.

The parameter will show the duration of the present link, and preset to 00:00:00:00 if the link is broken.

Check: Cabling

In rare cases of cabling mis-configuration, the option might show the presents of a link, but no communication is running. Exchange the cable in doubt.

Check: IP Address

Verify that the option has a valid IP address (please refer to section: IP Settings) in par. 12-01, *IP Address*. If the option has identified a duplicate IP Address NS LEDs will light steady red. If the option is set up for BOOTP or DHCP, verify that a BOOTP or DHCP server is connected in par. 12-04, *DHCP Server*. If no server is connected, the parameter will show: 000.000.000.000.

7.1.2 Alarm Word and Warning Word

Alarm word and warning word are shown in the display in Hex format. If there is more than one warning or alarm, a sum of all warnings or alarms will be shown. Warning word and alarm word are displayed in par. 16-90 to 16-95. For more information on the individual alarms and warnings, please refer to: FC 200/FC 300 Design Guide.

NB!
Please note that the availability of the individual alarms and warnings are dependent on the drive type: /FC 200/FC 300 series.

Warning and Alarm Messages

There is a clear distinction between alarms and warnings. In the event of an alarm, the frequency converter will enter a fault condition. After the cause for the alarm has been cleared, the master must acknowledge the alarm message in order to start operation of the frequency converter again. A warning, on the other hand, may appear when a warning condition arises, then disappear when conditions return to normal without interfering with the process.

Warnings

All warnings within the frequency converter are represented by a single bit within a warning word. A warning word is always an action parameter. Bit status FALSE [0] means no warning, while bit status TRUE [1] means warning. Each bit status has a corresponding text string message. In addition to the warning word message the master will also be notified via a change in the status word.

Alarms

Following an alarm message the frequency converter will enter a fault condition. Only after the fault has been rectified and the master has acknowledged the alarm message by a bit in the Control Word, can the VLT resume operation. All alarms within the VLT are represented by a single bit within an alarm word. An alarm word is always an action parameter. Bit status FALSE [0] means no alarm, while bit status TRUE [1] means alarm. In CIP, Alarms are divided in to two categories:

- Major Recoverable Faults
- Major Unrecoverable Faults

Please refer to the following sections for a classification of the specific faults.

Bit (Hex)	Alarm word (Par. 16-90)	CIP Classification
00000001	Brake check	-
00000002	Power card over temperature	MAR
00000004	Earth fault	MAU
00000008	Ctrl. card over temperature	-
00000010	Control word timeout	MAR
00000020	Torque limit	MAU
00000040	Over current	MAR
00000080	Motor thermistor over temp.	MAR
00000100	Motor ETR over temperature	MAR
00000200	Inverter overloaded	MAR
00000400	DC link under voltage	MAR
00000800	DC link over voltage	MAR
00001000	Short circuit	MAU
00002000	Inrush fault	MAR
00004000	Mains phase loss	MAU
00008000	AMA not OK	MAR
00010000	Live zero error	MAR
00020000	Internal fault	MAU
00040000	Brake overload	MAU
00080000	Motor phase U is missing	MAU
00100000	Motor phase V is missing	MAU
00200000	Motor phase W is missing	MAU
00400000	Fieldbus fault	MAR
00800000	24V supply fault	MAU
01000000	Mains failure	MAR
02000000	1.8V supply fault	MAU
04000000	Brake resistor short circuit	MAR
08000000	Brake chopper fault	MAR
10000000	Option change	-
20000000	Drive initialized	-
40000000	Safe Stop	MAR
80000000	Mech. Brake low	-

MAR = Major Recoverable Fault

MAU = Major Unrecoverable Fault

Bit (Hex)	Alarm word 2 (Par 16-91)
00000001	Service Trip, Read/Write
00000002	Reserved
00000004	Service Trip, Typecode/Sparepart
00000008	Reserved
00000010	Reserved
00000020	No Flow
00000040	Dry Pump
00000080	End of Curve
00000100	Broken Belt
00000200	Discharge high
00000400	Start failed
00000800	Speed limit
00001000	Reserved
00002000	Reserved
00004000	Reserved
00008000	Reserved
00010000	Reserved
00020000	KTY error
00040000	Fans error
00080000	ECB error
00100000	Reserved
00200000	Reserved
00400000	Reserved
00800000	Reserved
01000000	Reserved
02000000	Reserved
04000000	Reserved
08000000	Reserved
10000000	Reserved
20000000	Reserved
40000000	PTC thermistor
80000000	Dangerous failure

Bit (Hex)	Warning word (Par. 16-92)
00000001	Brake check
00000002	Power card over temperature
00000004	Earth fault
00000008	Control card over temperature
00000010	Control word timeout
00000020	Over current
00000040	Torque limit
00000080	Motor thermistor over temp.
00000100	Motor ETR over temperature
00000200	Inverter overloaded
00000400	DC link under voltage
00000800	DC link over voltage
00001000	DC link voltage low
00002000	DC link voltage high
00004000	Mains phase loss
00008000	No motor
00010000	Live zero error
00020000	10V low
00040000	Brake resistor power limit
00080000	Brake resistor short circuit
00100000	Brake chopper fault
00200000	Speed limit
00400000	Fieldbus comm. fault
00800000	24V supply fault
01000000	Mains failure
02000000	Current limit
04000000	Low temperature
08000000	Voltage limit
10000000	Encoder loss
20000000	Output frequency limit
40000000	Safe stop
80000000	Extended status word

Bit (Hex)	Warning word 2 (Par. 16-93)
00000001	Start Delayed
00000002	Stop Delayed
00000004	Clock Failure
00000008	Firemode was active
00000010	Reserved
00000020	No Flow
00000040	Dry Pump
00000080	End of Curve
00000100	Broken Belt
00000200	Discharge high
00000400	Reserved
00000800	Reserved
00001000	Reserved
00002000	Reserved
00004000	Reserved
00008000	Reserved
00010000	Reserved
00020000	KTY warning
00040000	Fans warning
00080000	ECB warning
00100000	Reserved
00200000	Reserved
00400000	Reserved
00800000	Reserved
01000000	Reserved
02000000	Reserved
04000000	Reserved
08000000	Reserved
10000000	Reserved
20000000	Reserved
40000000	PTC thermistor
80000000	Reserved

Bit (Hex)	Extended status word (Par. 16-94) FC 200 only !!
00000001	Ramping
00000002	AMA Running
00000004	Start CW/CCW
00000008	Slow Down
00000010	Catch Up
00000020	Feedback high
00000040	Feedback low
00000080	Output current high
00000100	Output current low
00000200	Output frequency high
00000400	Output frequency low
00000800	Brake check OK
00001000	Braking max
00002000	Braking
00004000	Out of speed range
00008000	OVC active
00010000	AC brake
00020000	Password Timelock
00040000	Password Protection
00080000	Reference high
00100000	Reference low
00200000	Local Ref./Remote Ref.
00400000	Reserved
00800000	Reserved
01000000	Reserved
02000000	Reserved
04000000	Reserved
08000000	Reserved
10000000	Reserved
20000000	Reserved
40000000	Reserved
80000000	Reserved

Bit (Hex)	Extended status word 2 (Par. 16-95)
FC 200 only !!	
00000001	Off
00000002	Hand/Auto
00000004	PROFibus OFF1 active
00000008	PROFibus OFF2 active
00000010	PROFibus OFF3 active
00000020	Relay 123 active
00000040	Start Prevented
00000080	Control ready
00000100	Drive ready
00000200	Quick Stop
00000400	DC Brake
00000800	Stop
00001000	Stand By
00002000	Freeze Output Request
00004000	Freeze Output
00008000	Jog Request
00010000	Jog
00020000	Start Request
00040000	Start
00080000	Start Applied
00100000	Start Delay
00200000	Sleep
00400000	Sleep Boost
00800000	Running
01000000	Bypass
02000000	Fire Mode
04000000	Reserved
08000000	Reserved
10000000	Reserved
20000000	Reserved
40000000	Reserved
80000000	Reserved

8 Appendix

8.1.1 Supported CIP Objects

As in all implementations of CIP, EtherNet/IP shares the common Object Model. Objects are a common method to describe the specific application implemented in a device.

Data is structured in Classes, Instances and Attributes:

A class is a group of objects with the same structure. These groups of objects within a class are called instances. Every instance provides the same data elements called attributes. Each class provides services to access data or to change the state of an object.

Class ID 0x01 Identity Object

Attribute	Access	Name	Data type	Description
1	Get	Vendor	UINT (97)	Danfoss Drives vendor code
2	Get	Device Type	UINT (2)	AC Drive
3	Get	Product Code	UINT	Value of par. 12-34
4	Get	Revision	Struct	Value of par. 12-33
5	Get	Status	WORD	EIP status word (par. 12-30)
6	Get	Serial Number	UDINT	Serial number
7	Get	Product Name	String	Value of par. 15-40 (e.g. "FC 302")
8	Get	State	UINT	0 = Non-existent 1 = Device Self Testing 2 = Standby 3 = Operational 4 = Major Recoverable Fault 5 = Major Unrecoverable Fault 6-254 = Reserved 255 = Default for Get Attribute All
9	Get	Conf. consistency value	UINT	

Table 8.1: Instance Attributes

Class ID 0x04 Assembly Objects

Instance	Access	Name	Size	Description
20	Set	ODVA basic speed control Output	2 Words	
21	Set	ODVA extended speed control Output	2 Words	
70	Get	ODVA basic speed control Input	2 Words	
71	Get	ODVA extended speed control Input	2 Words	
100	Set	Danfoss Basic Control Output	2 Words	
101	Set	Danfoss Extended Control Output	4 Words	
103	Set	Danfoss Extended Control Output	10 Words	
150	Get	Danfoss Basic Control Input	2 Words	
151	Get	Danfoss Extended Control Input	4 Words	
153	Get	Danfoss Extended Control Input	10 Words	

Table 8.2: Instance Attributes

Class ID 0x06 Connection Manager

Attribute	Access	Name	Data Type	Description
1	Get	Open Requests	UINT	Number of Forward Open requests received
2	Get	Open Format Rejects	UINT	Number of Forward Open requests rejected due to bad format
3	Get	Open Resource Rejects	UINT	Number of Forward Open requests rejected due to lack of resources
4	Get	Open Other Rejects	UINT	Number of Forward Open requests rejected due to other reasons
5	Get	Close Requests	UINT	Number of Forward Close requests received
6	Get	Close Format Requests	UINT	Number of Forward Close requests rejected due to bad format
7	Get	Close Other Requests	UINT	Number of Forward Close requests rejected due to other reasons
8	Get	Connection Timeouts	UINT	Number of connection timeouts
9	Get	Connection Entry List Struct of: NumConnEntries	INT	Number of connection entries ConnOpenBits ARRAY of BOOL List of connection data

Table 8.3: Instance Attributes

Class ID 0x28 Motor Data Object

Attribute	Access	Name	Data Type	Parameter	Description
1	Get	Number of Attributes supported	USINT	-	7
2	Get	List of attributes supported	Array of USINT	-	3,6,7,8,9,12,15
3	Get/Set	Motor Type	USINT	1-10	3: PM sync. motor (FC 302 only) 7: Squirrel cage induction motor
6	Get/Set	Rated Current	UINT	1-24	Unit: 100 mA
7	Get/Set	Rated Voltage	UINT	1-22	Unit: Volt
8	Get/Set	Rated Power	UDINT	1-20	Unit: Watt
9	Get/Set	Rated Frequency	UINT	1-23	Unit: Hertz
12	Get/Set	Pole Count	UINT	1-39	Number of poles in motor
15	Get/Set	Base Speed	UINT	1-25	Unit: RPM

Table 8.4: Instance Attributes



NB!

Class ID 0x28 is only available if ODVA profile is selected in par.8-10 *Control Word Profile*.

Class ID 0x29 Control Supervisor Object

Attribute	Access	Name	Data Type	Description
1	Get	Number of Attributes supported	USINT	12
2	Get	List of supported Attributes	Array of USINT	3,4,4,5,6,7,8,9,10,11,12,13,15
3	Get/Set	Run 1 (forward)	Boolean	FC CTW Bit 6 = Run1 XOR Run2 FC CTW Bit15 = 0
4	Get/Set	Run 2 (reverse)	Boolean	FC CTW Bit 6 = Run1 XOR Run2 FC CTW Bit15 = 1
5	Get/Set	Network Control	Boolean	Parameter 12-32 value written from option
6	Get	State	USINT	The state of the CIP state-machine
7	Get	Running 1	Boolean	Run1 AND bit 11 in FC STW
8	Get	Running 2	Boolean	Run2 AND bit 11 in FC STW
9	Get	Ready	Boolean	STATE_ENABLED or STATE_STOPPING or STATE_FAULT_STOP from state-machine
10	Get	Faulted	Boolean	Bit 3 in FC STW
11	Get	Warning	Boolean	Bit 7 in FC STW
12	Get/Set	Fault reset	Boolean	Bit 7 in FC CTW
13	Get	Fault Code	UINT	Mapping of par. 16-90 <i>Alarm Word</i> to CIP specific fault codes
15	Get	Control from net	Boolean	Parameter 12-31 value written from option

Table 8.5: Instance Attributes

CIP Malfunction Code	Meaning	VLT-Code Alarmword	CIP Malfunction Meaning	CIP Classification
0	No alarm	0000 0000	No fault	-
0	unused	0000 0001	No fault	-
4210	Drive over temperature	0000 0002	Excessive Device Temperature	mar
2240	Earth fault	0000 0004	Short to earth	mau
0	unused	0000 0008	No fault	-
8100	Controlword timeout	0000 0010	Communication	mir
2310	Overcurrent	0000 0020	Continuous Overcurrent	mau
8302	Torque limit	0000 0040	Torque limiting	mar
4310	Motor thermistor	0000 0080	Excess Drive Temperature	mar
4310	Motor ETR over temp	0000 0100	Excess Drive Temperature	mar
2311	Inverter overloaded	0000 0200	Current inside the device, No. 1	mar
3220	DC Link undervoltage	0000 0400	Undervoltage inside the Device	mar
3210	DC Link overvoltage	0000 0800	Overvoltage inside the device	mar
2130	Short circuiting	0000 1000	Short Circuit	mau
2213	Inrush fault	0000 2000	Overcurr. marduring startup	
3130	Mains phase loss	0000 4000	Phase Failure	mau
5210	AMT fail	0000 8000	Measurement Circuit	mir
1000	Live zero fault	0001 0000	General fault	mar
6100	Internal fault	0002 0000	Internal software fault	mau
7110	Brake resistor power limit	0004 0000	Brake Chopper	mau
3300	Motor phase U missing	0008 0000	Output voltage	mau
3300	Motor phase V missing	0010 0000	Output voltage	mau
3300	Motor phase W missing	0020 0000	Output voltage	mau
8100	Fieldbus Comm. fault	0040 0000	Communication	mir
5112	24V supply fault	0080 0000	+ 24V Power supply	mau
3100	Mains failure	0100 0000	Mains Voltage	mar
5110	1,8V supply fault	0200 0000	Low voltage power supp.	mau
7110	Brake resist. short circ.	0400 0000	Brake chopper	mar
7110	Brake chopper fault	0800 0000	Brake chopper	mar
0	unused	1000 0000	No fault	-
0	unused	2000 0000	No fault	-
0	unused	4000 0000	No fault	-
0	unused	8000 0000	No fault	-

Table 8.6: Attribute 13 "Fault Code"

Mir = Minor Recoverable
 Mar = Major Recoverable
 Mau = Major Unrecoverable

Service Code	Service Name	Service Description
0Eh	Get_Attribute_Single	Returns contents of specified attribute
10h	Set_Attribute_Single	Sets the contents of specified attribute
05h	Reset	Resets drive to it's start-up state.

Table 8.7: Services supported

NB!
 Class ID 0x29 is only available if ODVA profile is selected in par. 8-10 *Control Word Profile*.

Class ID 0x2A AC/ DC Drive Object

Attribute	Access Rule	Information about	Data Type	Contents
1	Get	Number of Attributes Supported	USINT	12
2	Get	List of Attributes Supported	USINT	3,4,6,7,8,18,19,20,21,22,28,29
3	Get	At Reference	Boolean	Bit 8 of FC STW
4	Get/Set	Network Reference	Boolean	value written to parameter "Net Reference"
6	Get/Set	Drive Mode	USINT	Mapping of values from parameter 1-00
7	Get	Actual Speed	INT	See Attribute 22
8	Get/Set	Reference Speed	INT	See Attribute 22
18	Get/Set	Acceleration Time	UINT	Scaled with Attribute 28 and written to par. 3-41
19	Get/Set	Deceleration time	UINT	Scaled with Attribute 28 and written to par. 3-42
20	Get/Set	Low Speed Limit	UINT	Scaled with Attribute 22 and written to par. 4-11
21	Get/Set	High Speed Limit	UINT	Scaled with Attribute 22 and written to par. 4-13
22	Get/Set	Speed Scale	SINT	Forms the "Speed Reference" and "Main Actual Value" for the Drive together with Attribute 7 and 8
28	Get/Set	Time Scale	SINT	Scaling factor for all time attributes
29	Get	Ref From Net	Boolean	value of parameter "Net Reference"

Table 8.8: Instance Attributes

Value of Attribute 6	ODVA Text	Value of par. 1-00	FC Text
0	Vendor specific	Remaining values not listed below	?
1	Open loop speed ctr.	0	Speed open loop
2	Closed loop speed ctr.	1	Speed closed loop
3	Torque Control	NA	NA
4	Process Control	NA	NA
5	Position Control	NA	NA

Table 8.9: Attribute 6 "Drive Mode"



NB!

Class ID 0x2A is only available if ODVA profile is selected in par.8-10 *Control Word Profile*.

Class ID 0xF5 I Interface Object

Attribute	Access Rule	Name	Data Type	Description of Attribute	Parameter In Drive
1	Get	Status	DWORD	Interface status	-
2	Get	Configuration Capability	DWORD	Interface capability flags	-
3	Get/Set	Configuration Control	DWORD	Interface control flags	-
4	Get	Physical Link Object	STRUCT of:	Path to physical link object	-
		Path size	UINT	Size of Path	-
		Path	Padded EPATH	Logical segments identifying the physical link object	-
5	Get/Set	Interface Configuration	STRUCT of:	TCP/IP network interface configuration.	-
		IP Address	UDINT	The device's IP address.	12-01
		Network Mask	UDINT	The device's network mask.	12-02
		Gateway Address	UDINT	Default gateway address	12-03
		Name Server	UDINT	Primary name server	12-06 [0]
		Name Server 2	UDINT	Secondary name server	12-06[1]
6	Get/Set	Domain Name	STRING	Default domain name	12-07
		Host Name	STRING	Host name	12-08

Table 8.10: Instance Attributes

Class ID 0xF6 Link Object

Three instances of the Link Object are implemented:

- Instance 1 and 2 relates to the physical Port 1 and 2 of the option.
- Instance 3 relates to the internal interface of the option, after the build-in switch.

At-tribute	Access Rule	Name	Data Type	Description of Attribute	Parameter in drive		
1	Get	Interface Speed	UDINT	Interface speed in Mbps (e.g., 0, 10, 100, 1000, etc.)	12-13		
2	Get	Interface Flags	DWORD	Interface status flags	-		
3	Get	Physical Address	ARRAY of 6 USINTs	MAC layer address	12-09		
4	Get	Interface Counters	STRUCT of				
		In Octets	UDINT	Octets received on the interface	12-98 [0]		
		In Ucast Packets	UDINT	Unicast packets received on the interface	12-98 [1]		
		In NUcast Packets	UDINT	Non-unicast packets received on the interface	12-98 [2]		
		In Discards	UDINT	Inbound packets received on the interface but discarded	12-98 [3]		
		In Errors	UDINT	Inbound packets that contain errors (does not include In Discards)	12-98 [4]		
		In Unknown Protos	UDINT	Inbound packets with unknown protocol	12-98 [5]		
		Out Octets	UDINT	Octets sent on the interface	12-98 [6]		
		Out Ucast Packets	UDINT	Unicast packets sent on the interface	12-98 [7]		
		Out NUcast Packets	UDINT	Non-unicast packets sent on the interface	12-98 [8]		
		Out Discards	UDINT	Outbound packets discarded	12-98 [9]		
		Out Errors	UDINT	Outbound packets that contain errors	12-98 [10]		
		5	Get	Media Counters	STRUCT of:	Media-specific counters	
				Alignment Errors	UDINT	Frames received that are not an integral number of octets in length	12-99 [0]
FCS Errors	UDINT			Frames received that do not pass the FCS check	12-99 [1]		
Single Collisions	UDINT			Successfully transmitted frames which experienced exactly one collision	12-99 [2]		
Multiple Collisions	UDINT			Successfully transmitted frames which experienced more than one collision	12-99 [3]		
SQE Test Errors	UDINT			Number of times SQE test error message is generated	12-99 [4]		
Deferred Transmissions	UDINT			Frames for which first transmission attempt is delayed because the medium is busy	12-99 [5]		
Late Collisions	UDINT			Number of times a collision is detected later than 512 bit times into the transmission of a packet	12-99 [6]		
Excessive Collisions	UDINT			Frames for which transmission fails due to excessive collisions	12-99 [7]		
MAC Transmit Errors	UDINT			Frames for which transmission fails due to an internal MAC sub layer transmit error	12-99 [8]		
Carrier Sense Errors	UDINT			Times that the carrier sense condition was lost or never asserted when attempting to transmit a frame	12-99 [9]		
Frame Too Long	UDINT	Frames received that exceed the maximum permitted frame size	12-99 [10]				
MAC Receive Errors	UDINT	Frames for which reception on an interface fails due to an internal MAC sub layer receive error	12-99 [11]				
6	Set	Interface Control	STRUCT of:	Configuration for physical interface	-		
		Control Bits	WORD	Interface Control Bits	-		
		Forced Interface Speed	UINT	Speed at which the interface shall be forced to operate Speed in Mbps (10, 100, 1000, etc.)	-		
7	Get	Interface Label	SHORT_STRING	Human readable identification	-		
8	Get	Link List Size	USINT	Number of members in Link List	-		
9	Get	Link List	ARRAY OF UINT	Link List between internal and all according external interfaces	-		

Table 8.11: Instance Attributes

Service Code	Supported		Service Name	Description of Service
	Class	Instance		
01h	Yes	Yes	Get_Attribute_All	Returns a predefined listing of this objects attributes
0Eh	Yes	Yes	Get_Attribute_Single	Returns the contents of the specified attribute.
10h	-	Yes	Set_Attribute_Single	Modifies a single attribute.
43h	-	Yes	Get_and_Clear	Gets then clears the specified attribute (Interface Counters or Media Counters).

Table 8.12: Services supported

Class ID 0x0F Parameter Object

Attribute	Access Rule	Name	Data Type	Description of Attribute	Contents
1	Get	Revision	UINT	revision of object	01
2	Get	Max Instance	UINT	max instance number	variable
3	Get	Number of instances	UINT	amount of instances	variable
8	Get	Parameter Class Descriptor	WORD	Parameter description	0x03
9	Get	Configuration Assembly Instance	UINT	instance number of the configuration assembly	0
10	Get/Set	Native Language	USINT	Language ID for all character array accesses	variable

Table 8.13: Class attributes

8

Attribute	Access Rule	Name	Data type	Description	Value
1	Set/Get	Parameter Value	data type described in Attr. 5	actual value of parameter	Value of parameter from drive
2	Get	Link path size	USINT	Size of link path	variable
3	Get	Link path	ARRAY:	CIP path of parameter's origin	variable
		Segment type/port	BYTE		
		Segment Address	path		
4	Get	Descriptor	WORD	Description of parameter	See Standard
5	Get	Data Type	EPATH	Data type code	-
6	Get	Data size	USINT	Number of bytes in parameter value	variable
7	Get	Parameter name string	SHORT STRING	human readable text string representing parameter name	Parameter Attribute From drive
8	Get	Units string	SHORT STRING	human readable text string representing parameter unit	Parameter Attribute From drive
9	Get	Help String	SHORT STRING	human readable text string representing short online help.	Parameter Attribute From drive
10	Get	min value	data type described in Attr. 5	Generic min valid value	Parameter Attribute From drive
11	Get	max value	data type described in Attr. 5	Generic max valid value	Parameter Attribute From drive
12	Get	default value	data type described in Attr. 5	Generic parameter's default value	Parameter Attribute From drive
13	Get	Scaling multiplier	UINT	multiplier for scaling factor	1
14	Get	Scaling divisor	UINT	divisor for scaling factor	1
15	Get	Scaling base	UINT	base for scaling formula	0
16	Get	Scaling offset	INT	offset for scaling formula	0
17	Get	Multiplier link	UINT	parameter instance of multiplier source	0
18	Get	divisor link	UINT	parameter instance of divisor source	0
19	Get	base link	UINT	parameter instance of base source	0
20	Get	offset link	UINT	parameter instance of offset source	0
21	Get	decimal precision	USINT	specifies parameter value format	variable

Table 8.14: Instance attributes

Service Code	Supported		Service Name	Description of Service
	Class	Instance		
0Eh	Yes	Yes	Get_Attribute_Single	returns contents of specified attribute
01h	Yes	Yes	Get_Attributes_All	returns predefined listing of object attributes
10h	No	Yes	Set_Attribute_Single	modifies attribute
4Bh	No	Yes	Get_Enum_String	reads enumerated strings from parameter instance

Table 8.15: Services supported

Class ID 0x10 Parameter Group Object

Attribute	Access Rule	Name	Data Type	Description	Contents
1	Get	Group Name String	SHORT_STRING	represents group name	Name of Group from Drive
2	Get	Number of group members	UINT	amount of parameters in group	value of n
3	Get	1st group parameter (000-099)	UINT	instance number of Parameter Object	variable
4	Get	2nd group parameter (100-199)	UINT	instance number of Parameter Object	variable
...	Get	...	UINT	...	variable
n+2	Get	nth group parameter	UINT	instance number of Parameter Object	variable

Table 8.16: Instance Attributes

Class ID 0x64 – 0xC7 Danfoss Objects

The CIP Class ID 100 to 199 (0x64 to 0xC7) gives access to all drive parameters.

Class (decimal)	Danfoss Parameter range
100	0-01 - 0-99
101	1-00 – 1-99
102	2-00 – 2-99
103	3-00 – 3-99
104	4-00 – 4-99
105	5-00 – 5-99
106	6-00 – 6-99
107	7-00 – 7-99
108	8-00 – 8-99
109	9-00 – 9-99
110	10-00 – 10-99
111	11-00 – 11-99
...	...
199	99-00 – 99-99

The class Instance and Attribute acts in the following way:

- 100 added to the parameter group = the value for the class.
- 100 added to the remaining parameter number = the value for the instance.
- 100 added to the array index of the parameter = the value for the attribute

Examples: (fictitious parameters)

- Parameter 0-01 [index 0] = Class 100; Instance 101; Attribute 100
- Parameter 1-00 [index 0] = Class 101; Instance 100; Attribute 100 - Parameter 2-59[index 0] = Class 102; Instance 159; Attribute 100
- Parameter 5-34[index 3] = Class 105; Instance 134; Attribute 103
- Parameter 6-54 [index 9] = Class 106; Instance 154; Attribute 109
- Parameter 10-01 [index 0] = Class 110; Instance 101; Attribute 100

All values in decimal.

All parameters are accessed in the Active setup (par. 0-10 *Active Set-up*)

Service Code	Supported Class	Instance	Service Name	Description of Service
0Eh	Yes	Yes	Get_Attribute_Single	returns contents of specified attribute
10h	No	Yes	Set_Attribute_Single	modifies attribute
4Bh	No	Yes	Get_Att_Scattered	returns specified parameter values
4Ch	No	Yes	Set_Att_Scattered	sets specified parameter values

Table 8.17: Services supported

Index

A

Abbreviations	6
Ac/dc Drive Object	54
Alarm Word	45
Assembly Instances	23
Assembly Instances	21
Assembly Objects	51
Assumptions	5

B

Background Knowledge	5
----------------------	---

C

Cabling	40
Cabling	45
Change-of-state	22, 39
Cip Objects	23
Cip Objects	51
Class 1 Connection	22
Class 3 Connection	23
Coasting Select 8-50	33
Configurable Control Word Qw 8-14	33
Configurable Status Word Stw 8-13	32
Configuration	5, 17, 21, 31, 32
Configuration	6, 37, 38
Configuration Assembly Instance	56
Configuration Capability	54
Control Site 8-01	31
Control Supervisor Object	52
Control Word Profile 8-10	32
Control Word Source 8-02	31
Control Word Timeout Function 8-04	31
Control Word Timeout Time 8-03	31
Conversion Index	43, 44

D

Data Type	51, 56
Data Type	43, 52, 54, 55, 56, 57
Data Types	44
Dc Backup	6
Dc Brake Select 8-52	34
Devicenet	6
Drive Profile	25, 26

E

Eds	17
Emc Precautions	13
End-of-timeout Function 8-05	32
Ethernet	13, 16, 17, 19, 36, 37, 39, 40, 45
Ethernet	43
Ethernet/ip	5, 17, 18, 19, 22, 38, 51

F

Fc Profile	21, 29, 32
Fc Profile	25, 26
Forward Open	18, 22, 23, 39, 52

H

Hardware	3, 5
Hardware	5

I

I/o	6, 21, 22
Identity Object	51
Igmp	19, 40
Igmp Snooping	43
Installation	3, 5, 6
Installation	7
Interface Object	54
Ip Settings	15, 43, 45
Ip Traffic	19
Ip21 / Type 1	6

L

Led	6, 9
Leds	45
Link Object	54, 55
Literature	6

M

Master	46
Master	17
Motor Data Object	52
Multicast	22
Multicast	19, 41

N

Network	5, 11, 13, 19, 24, 36, 38, 39, 40, 45, 54
Network	9, 11, 52, 54

O

Object Model	51
Objects	57
Odva Conformance	6
Odva Profile	52, 53, 54
Overview	7

P

Parameter Group Object	57
Parameter Object	56, 57
Parameters	4, 15, 16, 57
Parameters	16, 17, 23
Preset Reference Select 8-56	35
Profibus	6

Q

Quick Stop Select 8-51	34
------------------------	----

R

Reference	23, 25, 26, 27, 28
Reference	6, 25, 28, 29, 30, 38, 48, 54
References	4
Reset Control Word Timeout 8-06	32
Reversing Select 8-54	34

S

Safety	3
Set-up Select 8-55	35
Spanning Tree	6
Spanning Tree	11, 19
Start Select 8-53	34

T

Topology	10, 12, 19
Topology	10
Troubleshooting	45

U

Unconnected Messages	23
----------------------------	----

W

Warning Word	47, 48
Warning Word	45