

DOOR KEYPAD MOUNTING KIT - MOUNTING INSTRUCTIONS

1. INTRODUCTION

The Door Keypad is used for the same purpose as the standard control keypad. It is installed on the door of a switchgear cabinet.

For the installation, you need the following parts (see picture below):

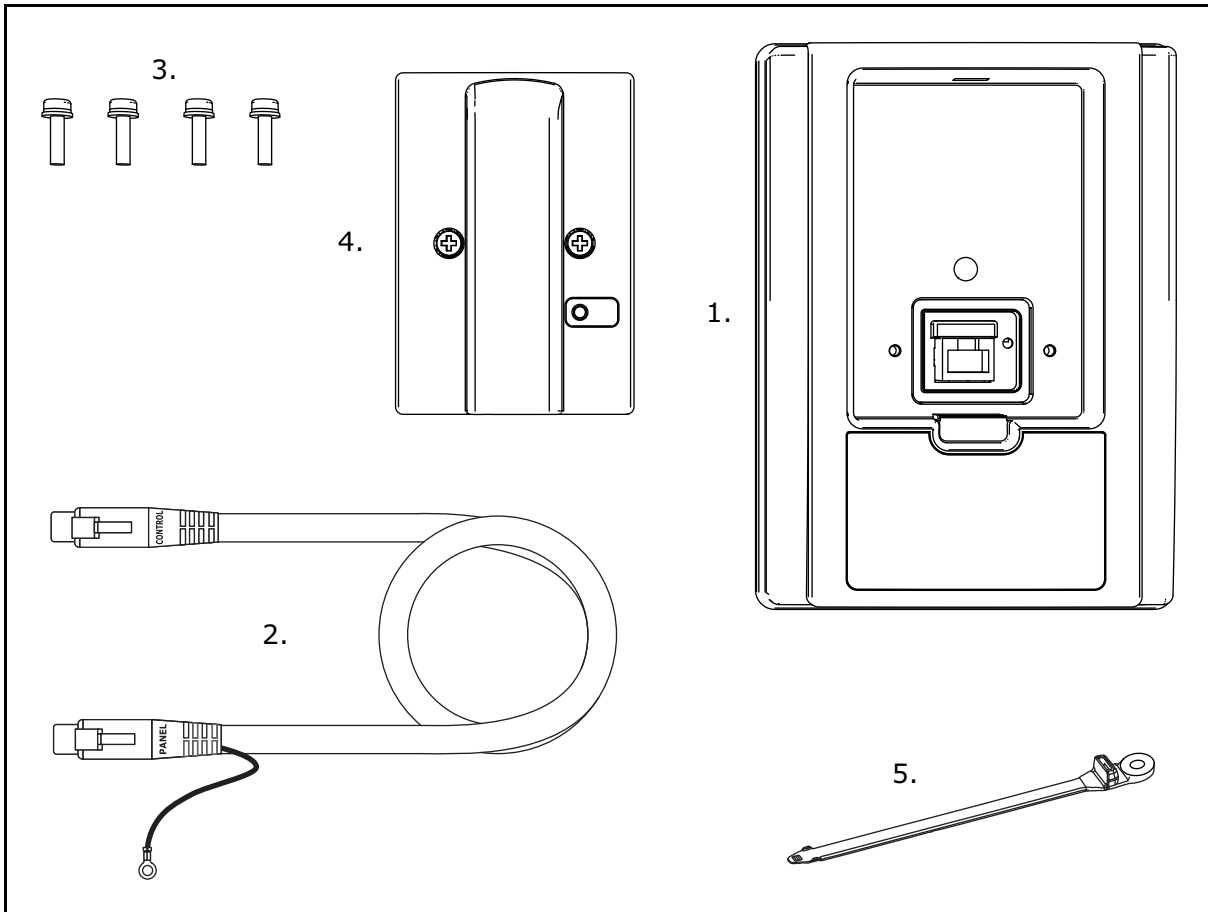

Figure 1. Door keypad mounting kit

1. Door keypad base
2. Data cable with attached grounding cable
3. Screws (4 pcs)
4. Panel adapter kit (packaged); See manual in package for components
5. Cable tie

MAKE SURE THAT YOU HAVE RECEIVED ALL NECESSARY ITEMS!



DPD00459D

2. MOUNTING PROCEDURE

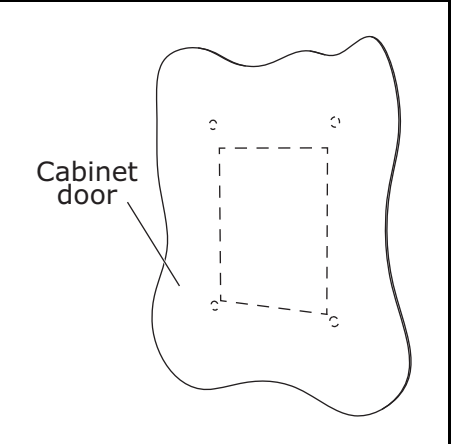
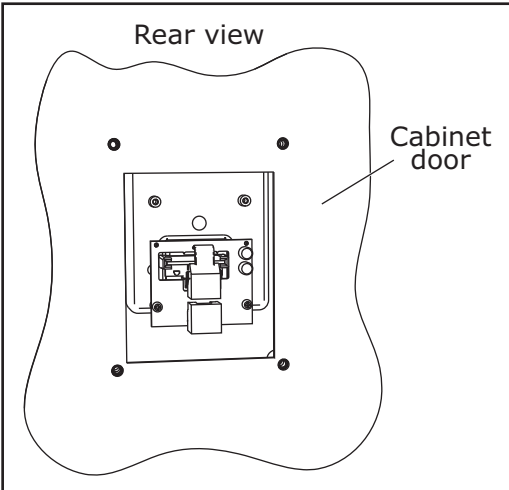
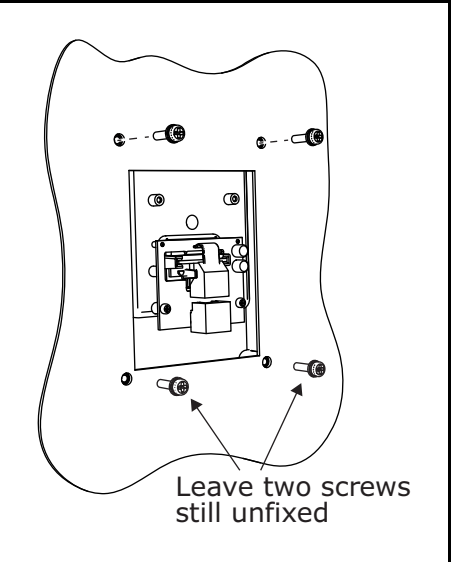
<p style="text-align: center; font-size: 2em; font-weight: bold;">1</p>	<p>Make an opening in the cabinet door for the control keypad according to the dimensions in Appendix 1. Also make the holes in the cabinet door for the screws using the dimensions in Appendix 1.</p>	
<p style="text-align: center; font-size: 2em; font-weight: bold;">2</p>	<p>Place the control keypad base (1.) toward the opening so that the screw holes you made in the cabinet door meet the bushings on the backside of the base.</p>	
<p style="text-align: center; font-size: 2em; font-weight: bold;">3</p>	<p>Fix the base on the cabinet door by tightening the screws (3.).</p>	

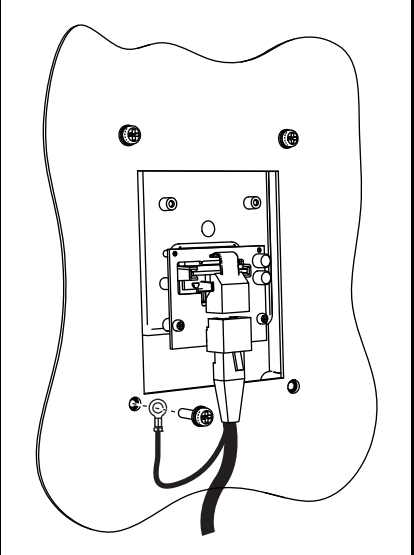
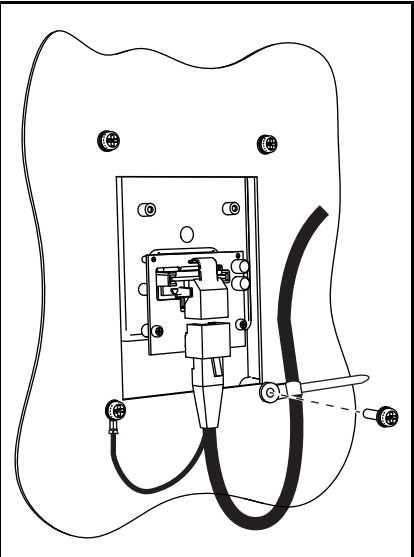
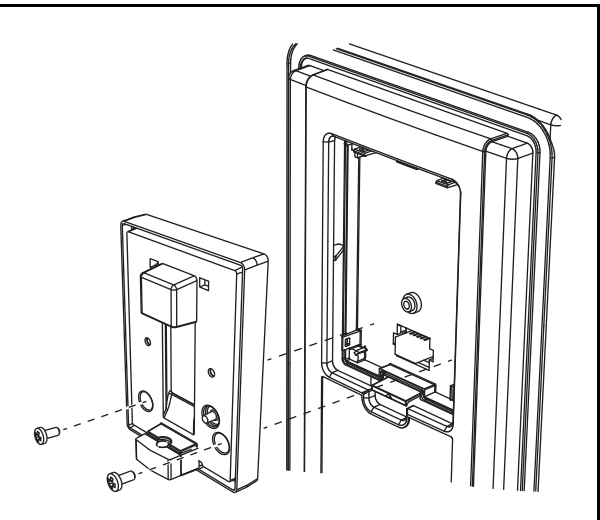
4	<p>Fix the data cable grounding wire (2.) against the backside of the cabinet door through one of the screw holes.</p> <p>NOTE: Ensure that a proper contact with the cabinet door is achieved. If necessary, remove the paint from the metal surface.</p> <p>Don't forget to place the washers (attached to the screws) between the door and the screws. The tightening torque to be applied is 1.5 Nm.</p> <p>Connect the data cable (2.) to the terminal of the keypad.</p>	
5	<p>Fix the data cable (2.) against the backside of the cabinet door through one of the screw holes. Use the cable tie (5.) provided in the kit.</p> <p>Don't forget to place the washers (attached to the screws) between the door and the screws. The tightening torque to be applied is 1.5 Nm.</p>	
6	<p>Fix the transparent cover B of the panel adapter kit (4.) to the keypad base using the two screws provided in the package. Tighten the screws to max. 1 Nm.</p>	

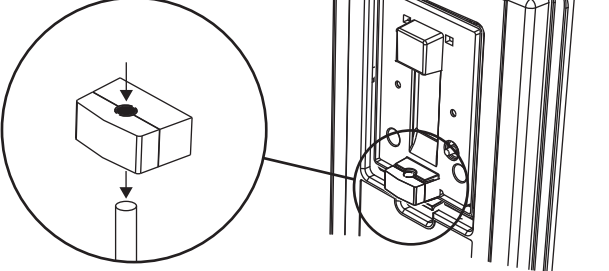
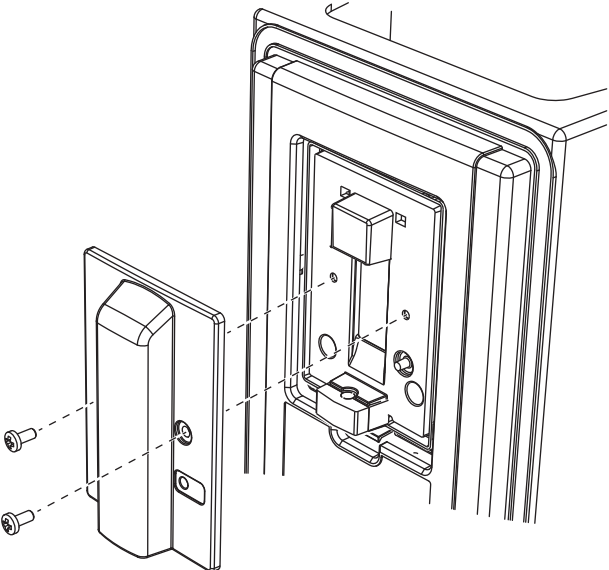
7	<p>Detach the foam rubber gasket from the transparent cover and punch out the cylinder-formed piece of foam rubber in order to open way for the cable. The gasket can then be split into two pieces.</p>	
8	<p>Then insert the cable and fix the black cover A of the panel adapter kit (4.) with the two screws provided. Tighten the screws to max. 1 Nm.</p>	

3. APPENDIX

The graphic is in real size. Use it to mark the cut-out for the door keypad as well as the screw holes.

