

ENGINEERING
TOMORROW

Danfoss

Installation Guide

VLT® AutomationDrive EZ FC 321

0.33–200 hp



1 Overview

1.1 Safety and Installation Awareness

Before starting installation, get familiarized with all safety guidelines and precautions in this guide. Additional resources - including the VLT® Safe Torque Off Operating Guide for VLT® AutomationDrive EZ FC 321, the Programming Guide, and the Application Guide - can be downloaded at www.danfoss.com/service-and-support.

1.2 Tools Needed

The following tools are required for installing the VLT® AutomationDrive EZ FC 321.

- Lifting aids to place the unit into position.
- Drill with 10 mm and 12 mm drill bits.
- Tape measurer.
- Torx, Phillips, and slotted screwdrivers (T15, T20, T25, T30, T50, PZ1, SL1, and SL2).
- Wrench with extensions and 7–17 mm sockets.
- Wire crimper.
- Sheet metal punch and/or pliers for cable entry plate.

1.3 Items Supplied

Items supplied vary according to product configuration.

- Make sure that the items supplied and the information on the nameplate correspond to the order confirmation.
- Check the packaging and the drive visually for damage caused by inappropriate handling during shipment. File any claim for damages with the carrier. Retain damaged parts for clarification.

VLT®
Automation Drive

1 — T/C: FC-321P75KT5P20H2XGCXXXXXXXAXBXXXXDX
 2 — P/N: 134G6302 S/N: 999999G999
 4 — 55 kW / 75 kW; 75 kW / 90 kW (NO)
 5 — IN: 3x380-500V 50/60Hz 87/86A; 161/145A (NO)
 6 — OUT: 3x0-Vin 0-590Hz 87/83A; 105/100A (NO)
 7 — Chassis/IP20 Tamb. 50°C / 122°F
 8 — Danfoss A/S
 6430 Nordborg Denmark
 www.danfoss.com

Danfoss

e30bj018.10

MADE IN USA

UL LISTED 76 X1 E134261 IND. CONT. EQ.
 UL Voltage 525-600 V

CE EAC 089

DANGER
 See manual for special condition/mains fuse
 voir manuel de conditions spéciales/fusibles

15 min. 10

Illustration 1: Nameplate Example

1	Type code	6	Output voltage, frequency, and current (at low/high voltages)
2	Code number	7	Enclosure size and IP rating
3	Serial number	8	Maximum ambient temperature
4	Power rating	9	Certifications
5	Input voltage, frequency, and current (at low/high voltages)	10	Discharge time (Warning)

NOTICE

Do not remove the nameplate from the drive (loss of warranty).

2 Safety Instructions

2.1 Overview

This Safety chapter only relates to installing the drive. When programming or operating the drive, refer to the Application Guide or Programming Guide for applicable safety instructions. To install this product safely:

- Check that the content of the delivery is correct and complete.
- Never install or start up damaged units. File a complaint immediately to the shipping company, if you receive a damaged unit.
- Follow the instructions provided in this installation guide.
- Make sure that all personnel working on or with the drive have read and understood this guide and any additional product manuals. Contact Danfoss if you are unclear of the given information, or if you are missing information.

2.2 Target Group and Necessary Qualifications

Correct and reliable transport, storage, installation, operation, and maintenance are required for the trouble-free and safe operation of the drive. Only **skilled personnel** are allowed to perform all related activities for these tasks. Skilled personnel are defined as properly trained staff, who are familiar with and authorized to install, commission, and maintain equipment, systems, and circuits in accordance with pertinent laws and regulations. Also, the skilled personnel must be familiar with the instructions and safety measures described in this manual and the other product-specific manuals. If you are not a skilled electrician, do not perform any electrical installation, and troubleshooting activities.

2.3 Safety Symbols

The following symbols are used in this manual:

⚠ D A N G E R ⚠

Indicates a hazardous situation which, if not avoided, will result in death or serious injury.

⚠ W A R N I N G ⚠

Indicates a hazardous situation which, if not avoided, could result in death or serious injury.

⚠ C A U T I O N ⚠

Indicates a hazardous situation which, if not avoided, could result in minor or moderate injury.

N O T I C E

Indicates information considered important, but not hazard-related (for example, messages relating to property damage).

2.4 General Safety Precautions

For US and Canadian markets:

NOTE! Download the English and French product guides with applicable safety, warning and caution information from <https://www.danfoss.com/en/service-and-support/>.

REMARQUE Vous pouvez télécharger les versions anglaise et française des guides produit contenant l'ensemble des informations de sécurité, avertissements et mises en garde applicables sur le site <https://www.danfoss.com/en/service-and-support/>.

⚠ W A R N I N G

LACK OF SAFETY AWARENESS

This document gives important information on how to prevent injury and damage to the equipment or the system. Ignoring them can lead to death, serious injury, or severe damage to the equipment.

- Make sure to fully understand the dangers and safety measures incurred in the application.

⚠ W A R N I N G

HAZARDOUS VOLTAGE
 AC drives contain hazardous voltage when connected to the AC mains or connected on the DC terminals. Failure to perform installation, start-up, and maintenance by skilled personnel can result in death or serious injury.

- Only skilled personnel must perform installation, start-up, and maintenance.

⚠ W A R N I N G ⚠

DISCHARGE TIME
 The drive contains DC-link capacitors, which can remain charged even when the drive is not powered. High voltage can be present even when the warning indicator lights are off.
 Failure to wait the specified time after power has been removed before performing service or repair work can result in death or serious injury.

- Stop the motor.
- Disconnect AC mains, permanent magnet type motors, and remote DC-link supplies, including battery back-ups, UPS, and DC-link connections to other drives.
- Wait for the time specified in the *Discharge Time tables* for the capacitors to discharge fully before performing any service or repair work.
- Measure the voltage level to verify full discharge.

Table 1: Discharge Time

Voltage [V]	Minimum waiting time (minutes)		
	4	15	20
	[hp]		
200–240	0.34–5.0	7.5–50	60–100
380–500	1.0–10	15–100	125–200
525–600	1.0–10	15–100	–
525–690	–	–	125–200

⚠ W A R N I N G

UNINTENDED START
 When the drive is connected to the AC mains, DC supply, or load sharing, the motor may start at any time, causing risk of death, serious injury, and equipment or property damage. The motor may start by activation of an external switch, a fieldbus command, an input reference signal from the LCP or LOP, via remote operation using MCT 10 Set-up software, or after a cleared fault condition.

- Press [Off] on the LCP before programming parameters.
- Disconnect the drive from the mains whenever personal safety considerations make it necessary to avoid unintended motor start.
- Check that the drive, motor, and any driven equipment are in operational readiness.

⚠ C A U T I O N ⚠

INTERNAL FAILURE HAZARD
 An internal failure in the drive can result in serious injury when the drive is not properly closed.

- Ensure that all safety covers are in place and securely fastened before applying power.

⚠ CAUTION ⚠

HOT SURFACES

The drive contains metal components that are still hot even after the drive has been powered off. Failure to observe the high temperature symbol (yellow triangle) on the drive can result in serious burns.

- Be aware that internal components, such as busbars, may be extremely hot even after the drive has been powered off.
- Do not touch exterior areas that are marked by the high temperature symbol (yellow triangle). These areas are hot while the drive is in use and immediately after being powered off.

2.5 Lifting the Drive

N O T I C E

LIFTING HEAVY LOAD

The weight of the drive is heavy and failure to follow local safety regulations for lifting heavy weights may cause death, personal injury, or property damage.

- Ensure that the lifting equipment is in proper working condition.
- Check the weight of the drive and verify that the lifting equipment can safely lift the weight.
- Always lift the drive using a lifting bar inserted into the lifting eyes. Maximum diameter for the lifting bar: 20 mm (0.8 in).
- The angle from the top of the drive to the lifting cable: 60° or greater.
- Test lift the unit approximately 610 mm (24 in) to verify the proper center of gravity lift point. Reposition the lifting point if the unit is not level.

Table 2: Drive Weights and Dimensions

Enclosure size	Protection rating	Dimensions (HxWxD) [in]	Weight [lb]
A2	IP20/Chassis	10.6x3.6x8.7	10.8
A3	IP20/Chassis	10.6x5.2x8.7	14.6
A5	IP66 - Type 4X	16.6x9.6x7.9	31.5
B1	IP66 - Type 4X	18.9x9.6x10.3	51
B2	IP66 - Type 4X	25.6x9.6x10x3	60
B3	IP20/Chassis	15.8x6.5x9.8	26.5
B4	IP20/Chassis	20.5x9.1x9.6	52
C1	IP66 - Type 4X	26.8x12.2x12.3	99
C2	IP66 - Type 4X	30.4x14.6x13.2	143
C3	IP20/Chassis	21.7x12.2x13	77
C4	IP20/Chassis	26x14.6x13	110
D1h	Type 12	35.5x12.8x14.9	136.7
D2h	Type 12	43.6x12.8x14.9	275.6
D3h	IP20/Chassis	35.8x19.8x14.8	136.7
D4h	IP20/Chassis	44.2x14.8x14.8	238.1

2.6 Mechanical Installation Precautions

⚠ WARNING ⚠

EXPLOSIVE ATMOSPHERE

Installing the drive in a potentially explosive atmosphere can lead to death, personal injury, or property damage.

- Install the unit in a cabinet outside of the potentially explosive area.
- Use a motor with an appropriate ATEX protection class.
- Install a PTC temperature sensor to an ATEX PTC-Thermistor device to monitor the motor temperature.
- Install short motor cables.
- Use sine-wave output filters when shielded motor cables are not used.

2.7 Electrical Installation Precautions

Before you do electrical work on the drive, lock out and tag out all power sources to the drive.

⚠ WARNING ⚠

INDUCED VOLTAGE

Induced voltage from output motor cables that run together can charge equipment capacitors, even with the equipment turned off and locked out/tagged out. Failure to run output motor cables separately or to use shielded cables could result in death or serious injury.

- Run output motor cables separately or use shielded cables.
- Simultaneously lock out/tag out all the drives.

Protective earth connection and RCD requirements

A properly dimensioned protective earth (PE) setup is essential for the safety of the drive system protecting the user against electrical shock. The PE connections of the drive installation ensure that the drive system remains safe preventing that the single fault currents will generate any hazardous voltages on accessible conductive part, for example, conductive enclosure parts.

The VLT® AutomationDrive EZ FC 321 shall be installed according to the requirement for PE connection and supplementary protective bonding as specified in IEC/EN 60364-5-54 cl. 543 and 544.

For the automatic disconnection, if there is a fault at the motor side, it shall also be ensured that the impedance of the PE connection between drive and motor is sufficiently low to ensure compliance with IEC/EN 60364-4-41 cl. 411 or 415. The impedance is verified by initial and periodic test according to IEC 60364-4-41.

In some regions, extra local requirements apply and must be adhered to.

The suitability for connection of PE and protective bonding of accessible conductive parts according to IEN/EN 60364-5-54 to the drive is ensured by following the design according to IEC/EN 61800-5-1.

Where the FC 321 is used as a component inside specific applications, special requirement for proper connection to the PE may apply, for example, IEC/EN 60204 and IEC/EN 61349-1.

⚠ W A R N I N G

ELECTRICAL SHOCK HAZARD - LEAKAGE CURRENT HAZARD >3.5 MA

Leakage currents exceed 3.5 mA. Failure to connect the drive properly to protective earth (PE) can result in death or serious injury.

- Ensure reinforced protective earthing conductor according to IEC 60364-5-54 cl. 543.7 or according to local safety regulations for high touch current equipment. The reinforced protective earthing of the can be done with:
 - a PE conductor with a cross-section of at least 10 mm² (8 AWG) Cu or 16 mm² (6 AWG) Al
 - an extra PE conductor of the same cross-sectional area as the original PE conductor as specified by IEC 60364-5-54 with a minimum cross-sectional area of 2.5 mm² (14 AWG) (mechanical protected) or 4 mm² (12 AWG) (not mechanical protected).
 - a PE conductor completely enclosed with an enclosure or otherwise protected throughout its length against mechanical damage.
 - a PE conductor part of a multi-conductor power cable with a minimum PE conductor cross-section of 2.5 mm² (14 AWG) (permanently connected or pluggable by an industrial connector. The multi-conductor power cable shall be installed with an appropriate strain relief).
- NOTE: In IEC/EN 60364-5-54 cl. 543.7 and some application standards (for example IEC/EN 60204-1), the limit for requiring reinforced protective earthing conductor is 10 mA leakage current.

⚠ W A R N I N G ⚠

ELECTRICAL SHOCK HAZARD - LEAKAGE CURRENT

Leakage currents can exceed 5%. Failure to ground the drive properly can result in death or serious injury.

- When the leakage currents exceed 5%, the protective earth (PE) shall be oversized by one number according to IEC/EN 60364-5-54 cl. 543.
- Ensure that the minimum size of the ground conductor complies with local safety regulations.

⚠ W A R N I N G ⚠

ELECTRICAL SHOCK AND FIRE HAZARD - RCD COMPLIANCE

The unit can cause a DC fault current in the PE conductor. Failure to use a Type B residual current-operated protective device (RCD) may lead to the RCD not providing the intended protection and therefore may result in death, fire, or other serious hazard.

- When an RCD is used for protection against electrical shock or against fire, only a Type B device is allowed on the supply side.

Other precautions

⚠ C A U T I O N ⚠

THERMISTOR INSULATION

Risk of personal injury or equipment damage.

- To meet PELV insulation requirements, use only thermistors with reinforced or double insulation.

N O T I C E

EXCESSIVE HEAT AND PROPERTY DAMAGE

Overcurrent can generate excessive heat within the drive. Failure to provide overcurrent protection can result in risk of fire and property damage.

- Other protective devices such as short-circuit protection or motor thermal protection between drive and motor are required for applications with multiple motors.
- Input fusing is required to provide short circuit and overcurrent protection. If fuses are not factory-supplied, the installer must provide them. See [4.11 Fuses and Circuit Breakers](#) for fuse specifications.

N O T I C E**PROPERTY DAMAGE**

Protection against motor overload is not included in the default setting. The ETR function provides class 20 motor overload protection. Failure to set the ETR function means that motor overload protection is not provided and property damage can occur if the motor overheats.

- Enable the ETR function. See the application guide for more information.

2.8 Safe Operation

When operating the unit, refer to the Programming Guide and Application Guide for guidance and all applicable safety instructions.

- The drive is not suitable as the only safety device in the system. Make sure that additional monitoring and protection devices on drives, motors, and accessories are installed according to the regional safety guidelines and accident prevention regulations.
- Keep all doors, covers, and terminal boxes closed and securely fastened during operation.

3 Mechanical Installation

3.1 Connection Tightening Torques

Table 3: Tightening Torque for Cables

Location	Enclosure sizes					
	A2–A5	B1/B3	B2/B4	C1/C3	C2/C4	D1h/D3h
Mains terminals [in-lb]	4.4–5.3	15.9	39.8	89	124 (up to 3 AWG) 212 (over 3 AWG)	168/335 ⁽¹⁾
Motor terminals [in-lb]	4.4–5.3	15.9	39.8	89	124 (up to 3 AWG) 212 (over 3 AWG)	168/335 ⁽¹⁾
Ground terminals [in-lb]	–	17.7–26.6	17.7–26.6	17.7–26.6	17.7–26.6	84/169 ⁽²⁾
Brake terminals [in-lb]	4.4–5.3	15.9	39.8	89	124	84
Relay terminals [in-lb]	–	4.4–5.3	4.4–5.3	4.4–5.3	4.4–5.3	4

¹ Bolt size M10/M12

² Bolt size M8/M10

3.2 Cooling

- Ensure that top and bottom clearance for air cooling is provided. See [Table 4](#) for clearance requirements.

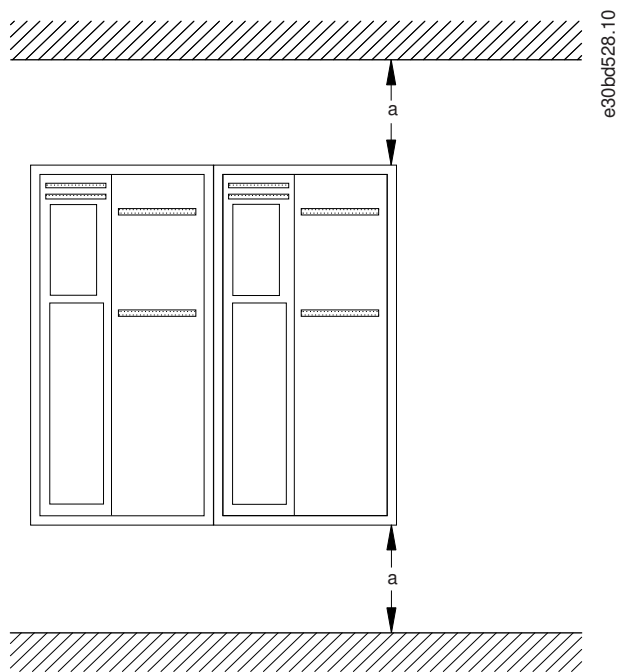

Illustration 2: Top and Bottom Cooling Clearance

Table 4: Minimum Airflow Clearance Requirements

Enclosure	A2–A3, A5	B1–B4	C1, C3	C2, C4	D1h–D4h
a [in]	3.9	7.8	7.8	8.9	8.9

3.3 Mounting

Procedure

1. Ensure that the strength of the mounting location supports the unit weight.

The drive allows side-by-side installation.

2. Place the unit as near to the motor as possible. Keep the motor cables as short as possible.
3. Mount the unit vertically to a solid flat surface or to the optional backplate to provide cooling airflow.
4. Use the slotted mounting holes on the unit for wall mount, when provided.

3.3.1 Mounting with Mounting Plate and Railings

A mounting plate is required when mounted on railings.

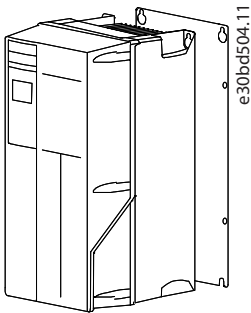

Illustration 3: Proper Mounting with Mounting Plate

3.4 Preparing Cable Entry Holes

Procedure

1. Remove cable entry from the drive. Avoid that foreign parts fall into the drive when removing the knockouts.
2. Support the cable entry where the knockout is to be removed.
3. Remove the knockout with a strong mandrel and a hammer.
4. Remove burrs from the hole.
5. Mount the cable entry on the drive.

4 Electrical Installation

4.1 EMC-compliant Installation

To obtain an EMC-compliant installation, refer to the wiring schematic (see [Illustration 5](#)) and follow the electrical installation instructions.

Also, remember to practice the following:

- When using relays, control cables, a signal interface, fieldbus, or brake, connect the shield to the enclosure at both ends. If the ground path has high impedance, is noisy, or is carrying current, break the shield connection on 1 end to avoid ground current loops.
- Convey the currents back to the unit using a metal mounting plate. Ensure good electrical contact from the mounting plate through the mounting screws to the drive chassis.
- Use shielded cables for motor output cables. An alternative is unshielded motor cables within metal conduit.
- Ensure that motor and brake cables are as short as possible to reduce the interference level from the entire system.
- Provide a minimum 200 mm (7.9 in) separation between mains input, motor cables, and control cables.
- For communication and command/control lines, follow the particular communication protocol standards. For example, USB must use shielded cables, but RS485/ethernet can use shielded UTP or unshielded UTP cables.
- Ensure that all control terminal connections are PELV.

NOTICE

TWISTED SHIELD ENDS (PIGTAILS)

Twisted shield ends increase the shield impedance at higher frequencies, which reduces the shield effect and increases the leakage current.

- Use integrated shield clamps instead of twisted shield ends.

NOTICE

SHIELDED CABLES

If shielded cables or metal conduits are not used, the unit and the installation do not meet regulatory limits on radio frequency (RF) emission levels.

NOTICE

EMC INTERFERENCE

Failure to isolate power, motor, and control cables can result in unintended behavior or reduced performance.

- Use shielded cables for motor and control wiring.
- Provide a minimum 200 mm (7.9 in) separation between mains input, motor cables, and control cables.

NOTICE

INSTALLATION AT HIGH ALTITUDE

There is a risk for overvoltage. Isolation between components and critical parts could be insufficient and may not comply with PELV requirements.

- Use external protective devices or galvanic isolation. For installations above 2000 m (6500 ft) altitude, contact Danfoss regarding protective extra low voltage (PELV) compliance.

NOTICE

PROTECTIVE EXTRA LOW VOLTAGE (PELV) COMPLIANCE

Prevent electric shock by using PELV electrical supply and complying with local and national PELV regulations.

e30bf228.11

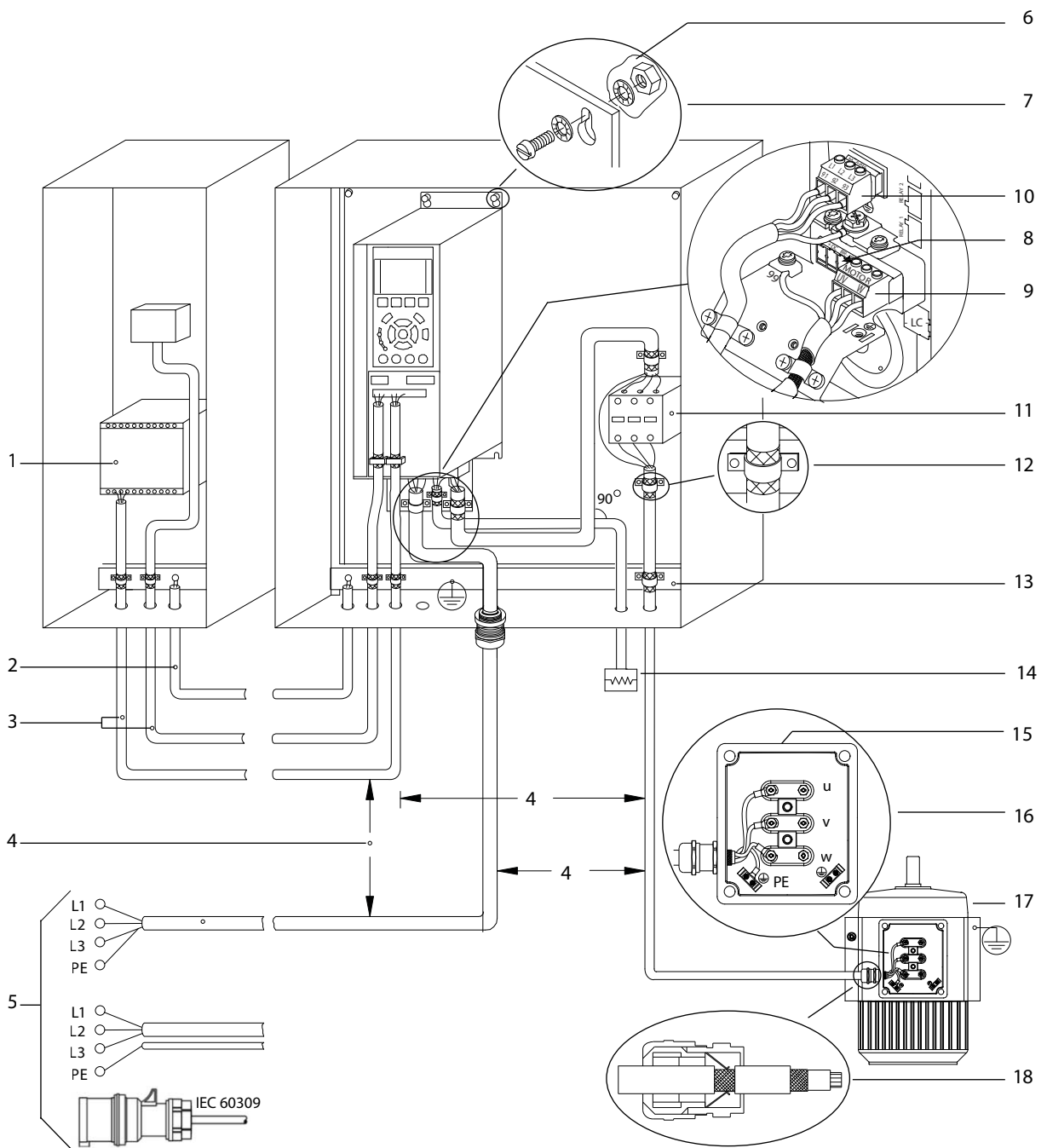

Illustration 4: Example of Proper EMC Installation

1	Programmable logic controller (PLC)	10	Mains cable (unshielded)
2	Minimum 16 mm ² (6 AWG) equalizing cable	11	Output contactor, and so on.
3	Control cables	12	Cable insulation stripped
4	Minimum 200 mm (7.9 in) between control cables, motor cables, and mains cables	13	Common ground busbar. Follow local and national requirements for cabinet grounding.
5	Mains supply options, see IEC/EN 61800-5-1	14	Brake resistor
6	Bare (unpainted) surface	15	Terminal box
7	Star washers	16	Connection to motor
8	Brake cable (shielded) – not shown, but same grounding principle applies as for motor cable	17	Motor
9	Motor cable (shielded)	18	EMC cable gland

N O T I C E

EMC INTERFERENCE

Use shielded cables for motor and control wiring, and separate cables for input power, motor wiring, and control wiring. Failure to isolate power, motor, and control cables can result in unintended behavior or reduced performance. Minimum 200 mm (7.9 in) clearance is required between power, motor, and control cables.

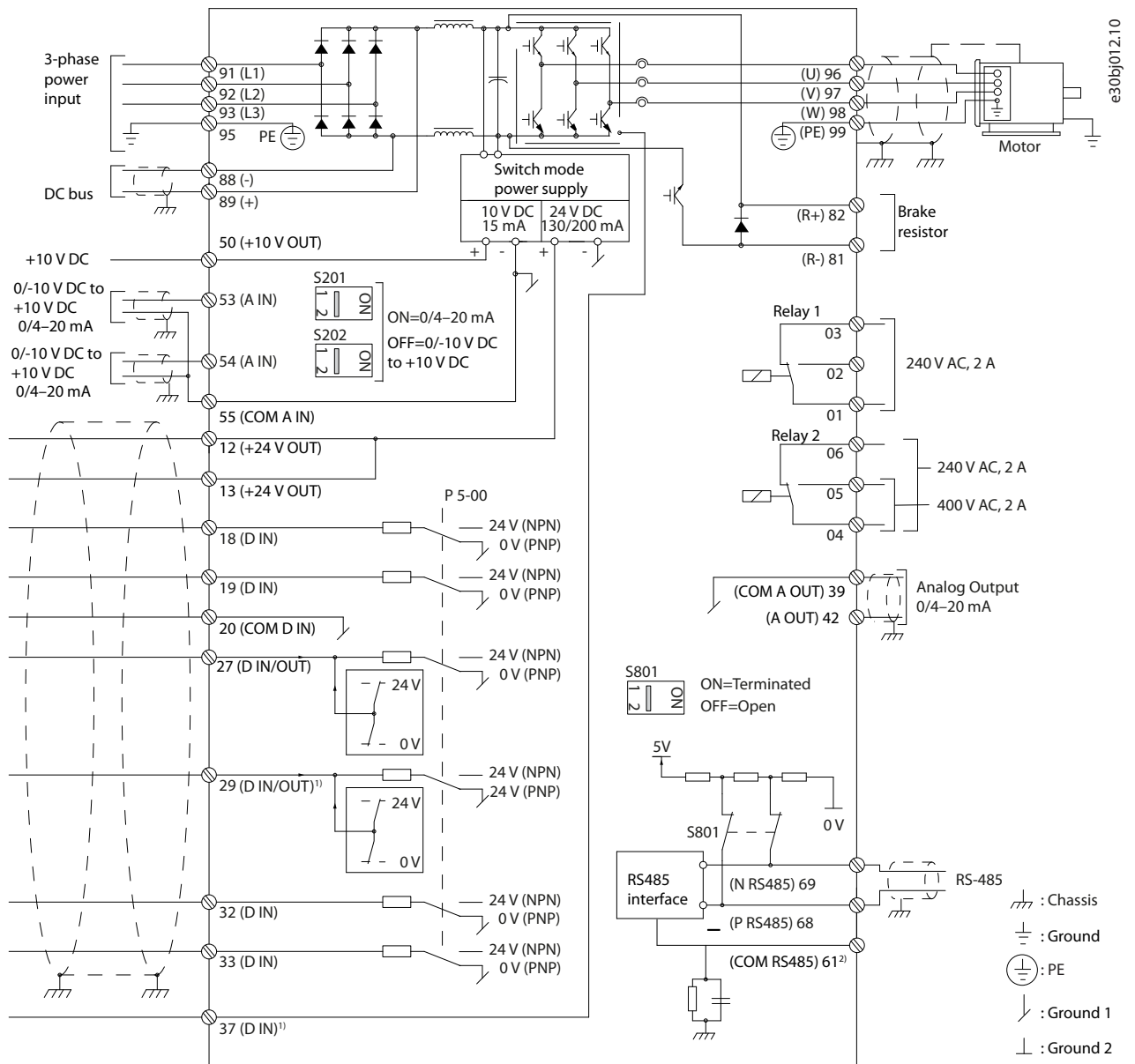

Illustration 5: Wiring Schematic

4.2 Cable Specifications

NOTICE

WIRE TYPE AND RATINGS

All wiring must comply with local and national regulations regarding cross-section and ambient temperature requirements. For power connections, minimum 167 °F rated copper wire is recommended.

Table 5: Control Cable Specifications

Type of cable	Maximum cross-section [AWG]	Minimum cross-section [AWG]
Flexible wire without cable end sleeves	16	24
Rigid wire without cable end sleeves	16	24
Flexible wire with cable end sleeves	18	24
Flexible wire with cable end sleeves with collar	20	24

Table 6: Power Cable Sizes for 104 °F Ambient Temperature, 200–240 V and 380–500 V

Enclosure size	Maximum cable size [AWG], mains, motor, brake
A2–A5	12
B1/B3	7
B2/B4	2
C1	1/0
C3	1/0
C2/C4	4/0
D1h/D3h	3/0
D2h/D4h	2x3/0

Table 7: Power Cable Sizes for 104 °F Ambient Temperature, 525–600 V

Enclosure size	Maximum cable size [AWG], mains, motor, and brake
A3/A5	12
B1/B3	7
B2/B4	2
C1	1/0
C3	1/0
C2/C4	4/0

Table 8: Power Cable Sizes for 104 °F Ambient Temperature, 525–690 V

Enclosure size	Maximum cable size [AWG], mains, motor, and brake
D1h/D3h	3/0
D2h/D4h	2x400

4.3 Terminal Descriptions

Table 9: Digital Inputs/Outputs

Terminal	Parameter	Default setting	Description
12, 13	–	+24 V DC	+24 V DC supply voltage for digital inputs and external transducers. Maximum output current 200 mA for all 24 V loads.
18	<i>Parameter 5-10 Terminal 18 Digital Inputs</i>	<i>[8] Start</i>	Digital inputs
19	<i>Parameter 5-11 Terminal 19 Digital Inputs</i>	<i>[0] No operation</i>	
32	<i>Parameter 5-14 Terminal 32 Digital Input</i>	<i>[0] No operation</i>	
33	<i>Parameter 5-15 Terminal 33 Digital Input</i>	<i>[0] No operation</i>	
27	<i>Parameter 5-12 Terminal 27 Digital Input</i>	<i>[2] Coast inverse</i>	For digital input or output. Default setting is input.

Terminal	Parameter	Default setting	Description
29	<i>Parameter Terminal 29 Digital Input</i>	[14] Jog	
20	–	–	Common for digital inputs and 0 V potential for 24 V supply.
37	–	Safe Torque Off (STO)	Safe input. Used for STO.

Table 10: Analog Inputs/Outputs

Terminal	Parameter	Default setting	Description
39	–	–	Common for analog output.
42	<i>Parameter 6-50 Terminal 42 Output</i>	Speed 0–high limit	Programmable analog output. 0–20 mA or 4–20 mA at a maximum of 500 Ω.
50	–	+10 V DC	10 V DC analog supply voltage potentiometer or thermistor. 15 mA maximum.
53	<i>Parameter group 6-1* Analog Input 1</i>	Reference	Analog input. For voltage or current. Switches A53 and A54 select mA or V.
54	<i>Parameter group 6-1* Analog Input 2</i>	Feedback	
55	–	–	Common for analog input.

Table 11: Serial Communication

Terminal	Parameter	Default setting	Description
61	–	–	Integrated RC-filter for cable shield. ONLY for connecting the shield if EMC problems occur.
68 (+)	<i>Parameter group 8-3* FC Port Settings</i>	–	RS485 interface. A control card switch is provided for termination resistance.
69 (-)	<i>Parameter group 8-3* FC Port Settings</i>	–	

Table 12: Relays

Terminal	Parameter	Default setting	Description
01, 02, 03	<i>Parameter 5-40 Function Relay [0]</i>	[9] Alarm	Form C relay output. For AC or DC voltage and resistive or inductive loads.
04, 05, 06	<i>Parameter 5-40 Function Relay [1]</i>	[5] Running	

4.4 Connecting the Control Cables to the Control Terminals

The control terminal connectors can be unplugged from the drive for convenience when wiring. Either solid or flexible wire can be connected to the control terminals.

N O T I C E

ELECTRICAL INTERFERENCE

Minimize interference by keeping control wires as short as possible and separate from high-power cables.

- Strip 10 mm (0.4 in) of the outer plastic layer from the end of the wire.

2. Insert the control wire into the appropriate terminals.

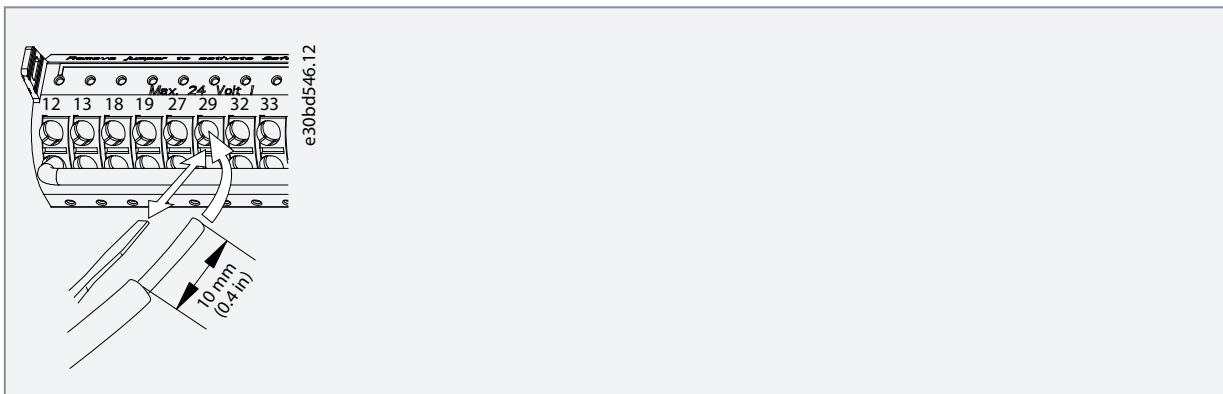

3. Pull gently on the wire to ensure that the contact is firmly established.

Loose control cable can cause equipment faults or reduced performance.

4.5 Start/Stop

Terminal 18 = Parameter 5-10 Terminal 18 Digital Input [8] Start.

Terminal 27 = Parameter 5-12 Terminal 27 Digital Input [0] No operation (Default [2] Coast inverse).

Terminal 37 = Safe Torque Off.

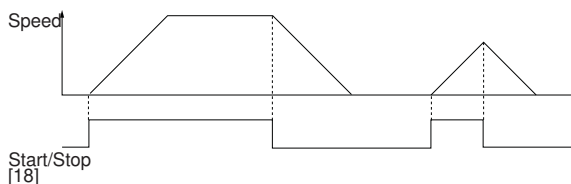
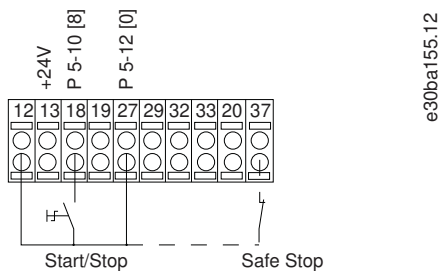

Illustration 6: Start/Stop

4.6 Pulse Start/Stop

Terminal 18 = Parameter 5-10 Terminal 18 Digital Input [9] Latched start.

Terminal 27 = Parameter 5-12 Terminal 27 Digital Input [6] Stop inverse.

Terminal 37 = Safe Torque Off.

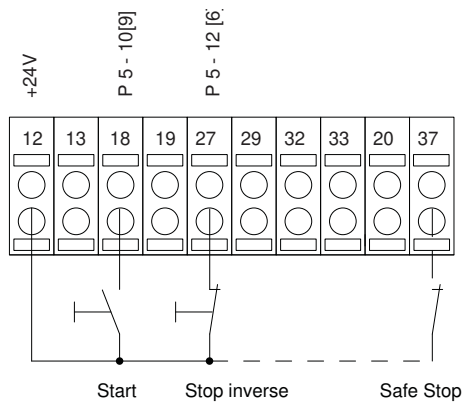

e30bat156.12

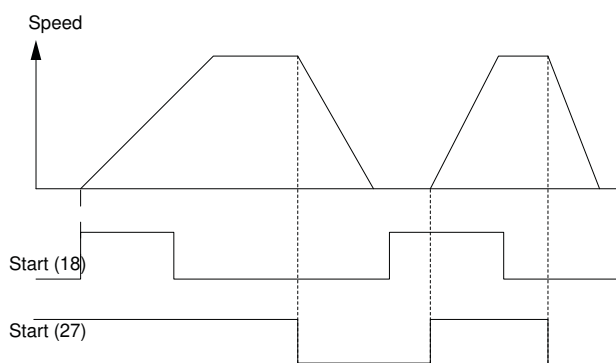

Illustration 7: Pulse Start/Stop

4.7 Speed Up/Speed Down

Terminal 18 = Parameter 5-10 Terminal 18 Digital Input [8] Start.

Terminal 27 = Parameter 5-12 Terminal 27 Digital Input [19] Freeze reference.

Terminal 37 = Safe Torque Off.

Terminal 29 = Parameter 5-13 Terminal 29 Digital Input [21] Speed up.

Terminal 32 = Parameter 5-14 Terminal 32 Digital Input [22] Speed down.

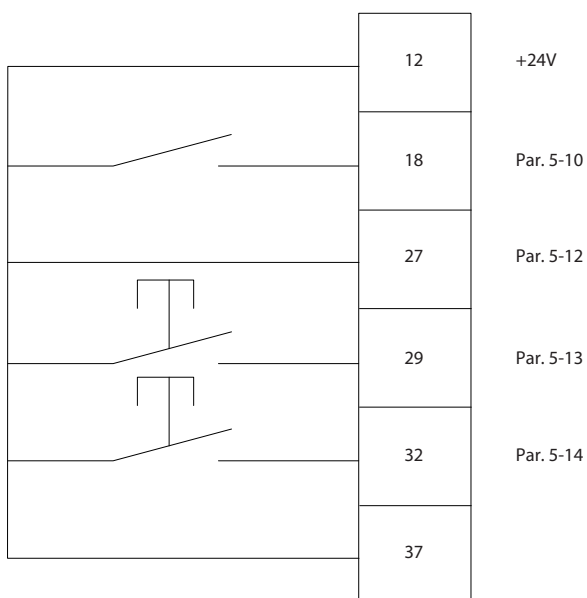

e30ba021.13

Illustration 8: Speed Up/Speed Down

4.8 Potentiometer Reference

Voltage reference via a potentiometer

Reference source 1 = [1] Analog input 53 (default).

Terminal 53, low voltage = 0 V.

Terminal 53, high voltage = 10 V.

Terminal 53, low reference/feedback = 0 RPM.

Terminal 53, high reference/feedback = 1500 RPM.

Switch S201 = OFF (U)

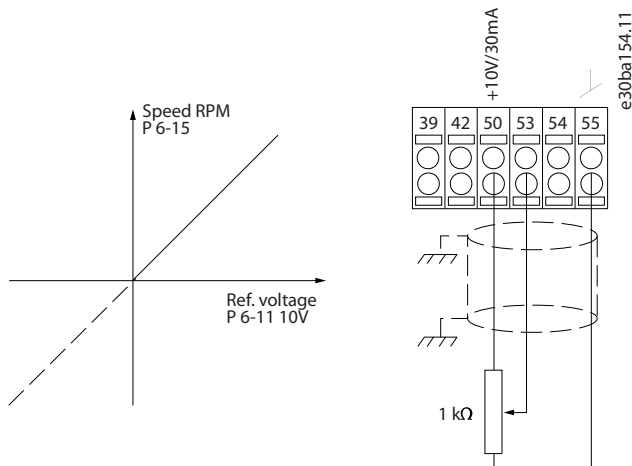

Illustration 9: Potentiometer Reference

4.9 Connecting the Motor

⚠ WARNING ⚠

INDUCED VOLTAGE

Induced voltage from output motor cables that run together can charge equipment capacitors, even with the equipment turned off and locked out/tagged out. Failure to run output motor cables separately or to use shielded cables could result in death or serious injury.

- Run output motor cables separately or use shielded cables.
- Simultaneously lock out/tag out all the drives.

- Run output motor cables separately or
- Use shielded cables.
- Comply with local and national electrical codes for cable sizes. For maximum wire sizes, see [4.2 Cable Specifications](#).
- Follow motor manufacturer wiring requirements.
- Motor wiring knockouts or access panels are provided at the base of IP55 (NEMA 12) units.
- Do not wire a starting or pole-changing device (for example a Dahlander motor or slip ring asynchronous motor) between the drive and the motor.

4.9.1 Grounding the Cable Shield

Procedure

1. Strip a section of the outer cable insulation.
2. Position the stripped wire under the cable clamp to establish mechanical fixation and electrical contact between the cable shield and ground.

3. Connect the ground wire to the nearest grounding terminal.

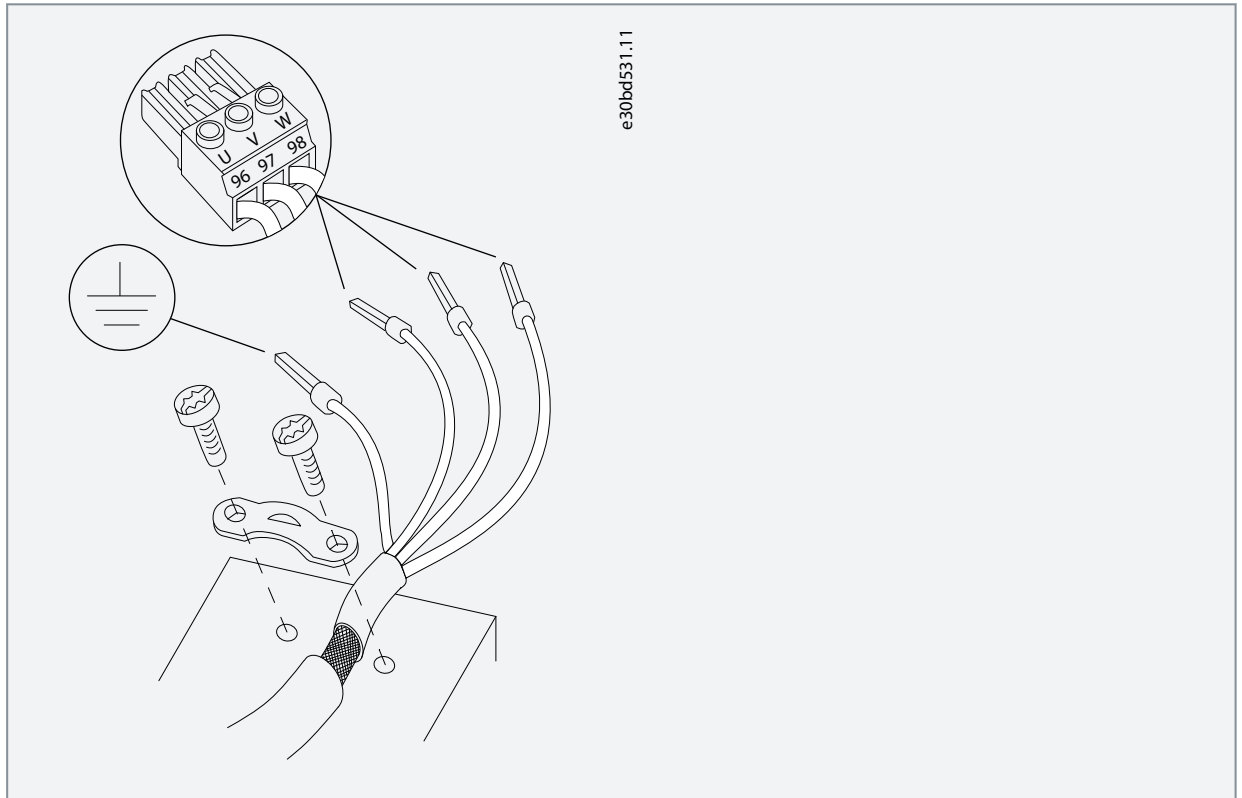

4. Connect the 3-phase motor wiring to terminals 96 (U), 97 (V), and 98 (W).
5. Torque-tighten the terminals, see [Table 3](#).

Example

Mains input, motor, and grounding for basic drives. Actual configurations vary with unit types and optional equipment.

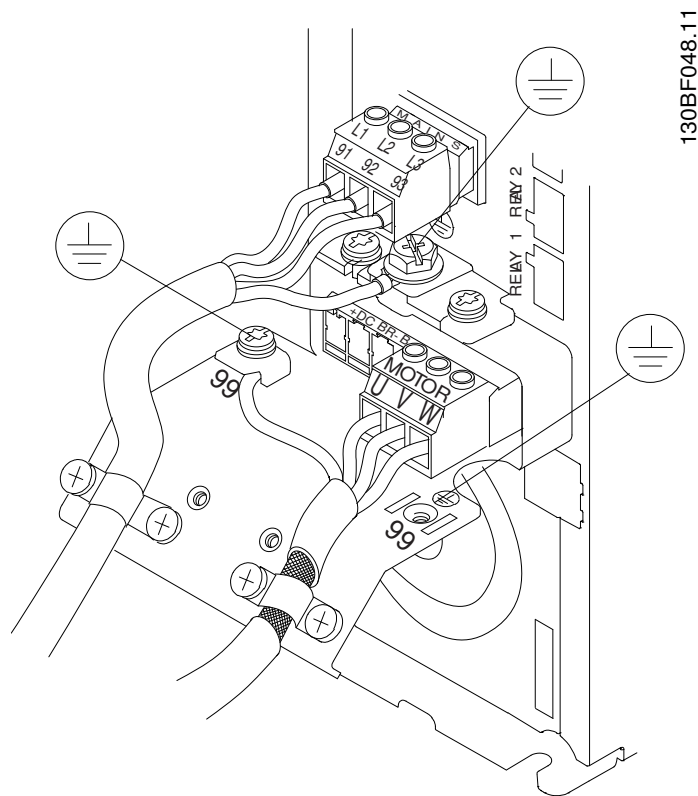

Illustration 10: Example of Motor, Mains, and Ground Wiring

4.10 Connecting AC Mains

- Size the wiring based on the input current of the drive. For maximum wire sizes, see [4.2 Cable Specifications](#).
- Comply with local and national electrical codes for cable sizes.

4.10.1 Connecting the Drive to Mains

Procedure

1. Connect the 3-phase AC input power wiring to terminals L1, L2, and L3.
2. Depending on the configuration of the equipment, connect the input power to the mains input terminals or the input disconnect.
3. Ground the cable.
4. When supplied from an isolated mains source (IT mains or floating delta) or TT/TN-S mains with a grounded leg (grounded delta), ensure that *parameter 14-50 RFI Filter* is set to [0] Off. This setting prevents damage to the DC link and reduces ground capacity currents in accordance with IEC 61800-3.

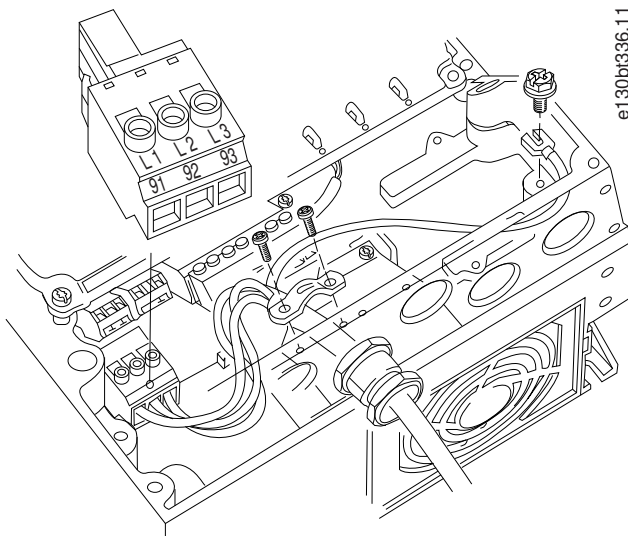

Illustration 11: Connecting to AC Mains

4.11 Fuses and Circuit Breakers

4.11.1 Fuse Recommendations

Fuses ensure that possible damage to the drive is limited to damages inside the unit. Danfoss recommends fuses and/or circuit breakers on the supply side as protection. For further information, see the application guide *Fuses and Circuit Breakers*.

NOTICE

Use of fuses on the supply side is mandatory for IEC 60364 (CE) and NEC 2009 (UL) compliant installations.

Recommendations

- gG type fuses.
- Eaton/Moeller type circuit breakers. For other circuit breaker types, ensure that the energy into the drive is equal to or lower than the energy provided by Eaton/Moeller types.

For further information, see the application guide *Fuses and Circuit Breakers*.

The recommended CE and UL compliant fuses are suitable for use on a circuit capable of 100000 A_{rms} (symmetrical), depending on the drive voltage rating. With the proper fusing, the drive short circuit current rating (SCCR) is 100000 A_{rms}.

4.11.2 CE Compliance

Table 13: 200–240 V, Enclosure Sizes A, B, C, and D

Enclosure	Power [hp]	Recommended fuse size	Recommended maximum fuse	Recommended circuit breaker Eaton/Moeller	Maximum trip level [A]
A2	0.34–2.0	gG-10	gG-25	PKZM0-25	25
	3.0	gG-16			
A3	4.0	gG-16	gG-32	PKZM0-25	25
	5.0	gG-20			
A5	0.34–2.0	gG-10	gG-32	PKZM0-25	25
	3.0–4.0	gG-16			
	5.0	gG-20			
B1	7.5	gG-25	gG-80	PKZM4-63	63

Enclosure	Power [hp]	Recommended fuse size	Recommended maximum fuse	Recommended circuit breaker Eaton/Moeller	Maximum trip level [A]
	10.0	gG-32			
B2	15.0	gG-50	gG-100	NZMB1-A100	100
B3	7.5	gG-25	gG-63	PKZM4-50	50
B4	10	gG-32	gG-125	NZMB1-A100	100
	15	gG-50			
	20	gG-63			
C1	20	gG-63	gG-160	NZMB2-A200	160
	25	gG-80			
	30	gG-100	aR-160		
C2	40	aR-160	aR-200	NZMB2-A250	250
	50	aR-200	aR-250		
C3	25	gG-80	gG-150	NZMB2-A200	150
	30	aR-125	aR-160		
C4	40	aR-160	aR-200	NZMB2-A250	250
	50	aR-200	aR-250		
D1h/D3h	60	aR-350	aR-350	–	–
	75	aR-400	aR-400	–	–
D2h/D4h	100	aR-550	aR-550	–	–

Table 14: 380–500 V, Enclosure Sizes A, B, C, and D

Enclosure	Power [hp]	Recommended fuse size	Recommended maximum fuse	Recommended circuit breaker Eaton/Moeller	Maximum trip level [A]
A2	0.5–4.0	gG-10	gG-25	PKZM0-25	25
	5.0	gG-16			
A3	7.5–10	gG-16	gG-32	PKZM0-25	25
A5	0.5–4.0	gG-10	gG-32	PKZM0-25	25
	5.0–10	gG-16			
B1	15–20	gG-40	gG-80	PKZM4-63	63
B2	25	gG-50	gG-100	NZMB1-A100	100
	30	gG-63			
B3	15–20	gG-40	gG-63	PKZM4-50	50
B4	25	gG-50	gG-125	NZMB1-A100	100
	30	gG-63			

Enclosure	Power [hp]	Recommended fuse size	Recommended maximum fuse	Recommended circuit breaker Eaton/Moeller	Maximum trip level [A]
	40	gG-80			
C1	40	gG-80	gG-160	NZMB2-A200	160
	50	gG-100			
	60	gG-160			
C2	75	aR-200	aR-250	NZMB2-A250	250
	100	aR-250			
C3	50	gG-100	gG-150	NZMB2-A200	150
	60	gG-160	gG-160		
C4	75	aR-200	aR-250	NZMB2-A250	250
	100	aR-250			
D1h/D3h	125	aR-315	aR-315	–	–
	150	aR-350	aR-350	–	–
	200	aR-400	aR-400	–	–

Table 15: 525–600 V, Enclosure Sizes A, B, C, and D

Enclosure	Power [hp]	Recommended fuse size	Recommended maximum fuse	Recommended circuit breaker Eaton/Moeller	Maximum trip level [A]
A2	1.0-5.0	gG-10	gG-25	PKZM0-25	25
A3	7.5	gG-10	gG-32	PKZM0-25	25
	10	gG-16			
A5	7.5	gG-10	gG-32	PKZM0-25	25
	10	gG-16			
B1	15	gG-25	gG-80	PKZM4-63	63
	20	gG-32			
	25	gG-40			
B2	30	gG-50	gG-100	NZMB1-A100	100
	40	gG-63			
B3	15	gG-25	gG-63	PKZM4-50	50
	20	gG-32			
B4	25	gG-40	gG-125	NZMB1-A100	100
	30	gG-50			
	40	gG-63			
C1	50	gG-63	gG-160	NZMB2-A200	160

Enclosure	Power [hp]	Recommended fuse size	Recommended maximum fuse	Recommended circuit breaker Eaton/Moeller	Maximum trip level [A]
	60	gG-100	aR-250		
	60	aR-160			
C2	100	aR-200	aR-250	NZMB2-A250	250
C3	50	gG-63	gG-150	NZMB2-A200	150
	60	gG-100	gG-150	NZMB2-A200	
C4	75	aR-160	aR-250	NZMB2-A250	250
	100	aR-200			

Table 16: 525–690 V, Enclosure Size D

Enclosure	Power [hp]	Recommended fuse size	Recommended maximum fuse
D1h/D3h	125	aR-315	aR-315
	150	aR-315	aR-315
	200	aR-315	aR-315

4.11.3 UL Compliance

Fuse classification for UL Compliance

NOTICE

UL COMPLIANCE

To comply with NEC 2017, it is mandatory to use fuses or circuit breakers. Danfoss recommends using a selection of the fuses listed in the following tables. These fuses are suitable for use on a circuit capable of delivering 100000 A_{rms} (symmetrical), 240 V, 500 V, or 600 V depending on the drive voltage rating. With the proper fusing, the drive short-circuit current rating (SCCR) is 100000 A_{rms} .

For semiconductor fuse types, the drive controller and the overcurrent protection device must be integrated within the same overall assembly.

Table 17: UL Fuse Classification Chart

UL class	Fuse overload characteristics	Interrupting rating [A]	AC voltage rating [V]	Available ampere rating
RK1	Ultra fast-acting, current limiting/time delay	200.000	250 600	1–600
T	Fast-acting	200.000	300 600	1–1.200
J	Fast-acting	200.000	600	1–600
CC	Fast-acting	200.000	600	5–30

Table 18: Recommended Maximum UL Fuse Class, Voltage Range 3x200–240 V, Enclosure Sizes A, B, and C

Power [hp]	Class fuses		Semiconductor fuses			
	RK1/J/T [A]	CC [A]	SIBA	Littelfuse	Ferraz Shawmut (Mersen)	Bussmann (Eaton)
0.34–0.5	5	5	5017906-005	–	–	FWX-5
0.75–1.5	10	10	5017906-010	–	–	FWX-10
2.0	15	15	5017906-016	–	–	FWX-15
3.0	20	20	5017906-020	–	–	FWX-20
4.0	25	25	5017906-025	–	–	FWX-25
5.0	30	30	5012406-032	–	–	FWX-30
7.5	50	–	5014006-050	–	–	FWX-50
10	60	–	5014006-063	–	–	FWX-60
15	80	–	5014006-080	–	–	FWX-80
20–25	125	–	2028220-125	–	–	FWX-125
30	150	–	2028220-150	L25S-150	A25X-150	FWX-150
40	200	–	2028220-200	L25S-200	A25X-200	FWX-200
50	250	–	2028220-250	L25S-250	A25X-250	FWX-250

Table 19: Recommended Maximum UL Fuse Class, Voltage Range 380–500 V, Enclosure Sizes A, B, and C

Power [hp]	Class fuses		Semiconductor fuses			
	RK1/J/T [A]	CC [A]	SIBA	Littelfuse	Ferraz Shawmut (Mersen)	Bussmann (Eaton)
0.5–1.5	6	6	5017906-006	–	–	FWH-6
2.0–3.0	10	10	5017906-010	–	–	FWH-10
4.0	15	15	5017906-016	–	–	FWH-15
5.0	20	20	5017906-020	–	–	FWH-20
7.5	25	25	5017906-025	–	–	FWH-25
10	30	30	5012406-032	–	–	FWH-30
15	40	–	5014006-040	–	–	FWH-40
20	50	–	5014006-050	–	–	FWH-50
25	60	–	5014006-063	–	–	FWH-60
30	80	–	2028220-100	–	–	FWH-80
40	100	–	2028220-125	–	–	FWH-100
50	125	–	2028220-125	–	–	FWH-125
60	150	–	2028220-160	–	–	FWH-150
75	200	–	2028220-200	L50-S-225	A50-P-225	FWH-200
100	250	–	2028220-250	L50-S-250	A50-P-250	FWH-250

Table 20: Recommended Maximum UL Fuse Class, Voltage Range 525–690 V, Enclosure Sizes A, B, and C

Power [hp]	Class fuses		Semiconductor fuses
	RK1/J/T [A]	CC [A]	SIBA
1.5	5 ⁽¹⁾	5	5017906-005
2.0–3.0	10	10	5017906-010
4.0	15	15	5017906-016
5.0	20	20	5017906-020
7.5	25	25	5017906-025
10	30	30	5017906-030
15	35	–	5014006-040
20	45	–	5014006-050
25	50	–	5014006-050
30	60	–	5014006-063
40	80	–	5014006-080
50	100	–	5014006-100
60	125	–	2028220-125
75	150	–	2028220-150
100	175	–	2028220-200

¹ Bussmann Class T allowed up to 6 A.

NOTICE

UL Compliance only for 525–600 V.

Table 21: UL Approved Branch Circuit Protection

Enclosure size	Enclosure ⁽¹⁾	Voltage [V]	Power [hp] HO	Maximum interrupting rating for listed circuit breakers	Maximum ampere rating [A]	Further information
A4/A5	Type 4X	380–500 (T5)	0.5, 0.75, 1.0, 1.5, 2.0, 3.0, 4.0, 5.0, 7.5, 10	100 kA (at 480 V)	25	Any UL 489 listed circuit breaker, maximum 25 A.
A5	Type 4X	200–240 V (T2)	4.0, 5.0	Specific type	25	ABB MS165-25 480V/277Y 65 kA.
A5	Type 4X	380–500 V (T5)	7.5, 10	Specific type	25	ABB MS165-25 480V/277Y 65 kA.
A5	Type 4X	525–600 V (T6)	5.0, 7.5, 10	Specific type	25	ABB MS165-25 600V/347Y 30 kA.

Enclosure size	Enclosure ⁽¹⁾	Voltage [V]	Power [hp] HO	Maximum interrupting rating for listed circuit breakers	Maximum ampere rating [A]	Further information
B1	Type 4X	200–240 V (T2)	7.5, 10	Specific type	40–54	ABB MS165-54 480V/277Y 65 kA.
B1	Type 4X	380–500 V (T5)	15, 20	Specific type	40–54	ABB MS165-54 480V/277Y 65 kA.
B1	Type 4X	380–500 V (T5)	15, 20	100 kA	60	Any UL 489 circuit breaker type with maximum interrupt rating and maximum ampere rating in list.
B1	Type 4X	525–600 V (T6)	15, 20	50 kA	40	Any UL 489 circuit breaker type with maximum interrupt rating and maximum ampere rating in list.
B2	Type 4X	380–500 V (T5)	25, 30	100 kA	100	Any UL 489 circuit breaker type with maximum interrupt rating and maximum ampere rating in list.
B2	Type 4X	525–600 V (T6)	25, 30	35 kA	60	any UL 489 circuit breaker type with maximum interrupt rating and maximum ampere rating in list.
C1	Type 4X	380–500 V (T5)	40, 50, 60	100 kA	200	Any UL 489 circuit breaker type with maximum interrupt rating and maximum ampere rating in list.
C2	Type 4X	380–500 V (T5)	75, 100	100 kA	250	Any UL 489 circuit breaker type with maximum interrupt rating and maximum ampere rating in list.

¹ Only Type 4X enclosures can be used. Not valid for Open type (IP20) units.

5 Specifications

5.1 Ambient Conditions

5.1.1 Environment

Enclosure	IP20/Chassis, IP54/NEMA 12, IP66/Type 4X
Vibration test	1.0 g
Maximum THDv	10%
Maximum relative humidity	5–93 (IEC 721-3-3); Class 3K3 (non-condensing) during operation
Aggressive environment (IEC 60068-2-43) H ₂ S test	Class Kd
Ambient temperature	Maximum 122 °F (24-hour average maximum 113 °F)
Minimum ambient temperature during full-scale operation	32 °F
Minimum ambient temperature at reduced speed performance	14 °F
Temperature during storage/transport	-13 to +149/158 °F
Maximum altitude above sea level without derating	3280 ft
EMC standards, Emission	EN 61800-3
EMC standards, Immunity	EN 61800-3
Energy efficiency class ⁽¹⁾	IE2

¹ Determined according to IEC 61800-9-2 and EN 50598-2 at:

- Rated load.
- 90% rated frequency.
- Switching frequency factory setting.
- Switching pattern factory setting.

5.2 Mains Supply

Supply terminals (6-pulse)	L1, L2, L3
Supply voltage ⁽¹⁾⁽²⁾	200–240 V ±10%
Supply voltage ⁽¹⁾⁽²⁾	380–500 V ±10%
Supply voltage ⁽¹⁾⁽²⁾	525–600 V ±10%
Supply voltage ⁽¹⁾⁽²⁾	575–690 V ±10%
Supply frequency	47.5–63 Hz
Maximum imbalance temporary between mains phases	3.0% of rated supply voltage
True power factor (λ)	≥0.9 nominal at rated load
Displacement power factor ($\cos \varphi$)	Near unity (>0.98)
Switching on the input supply L1, L2, L3 (power-ups) ≤10 hp	Maximum twice per minute
Switching on input supply L1, L2, L3 (power-ups) 15–100 hp	Maximum once per minute
Switching on input supply L1, L2, L3 (power-ups) ≥125 hp	Maximum once per 2 minutes
Environment according to EN60664-1	Overvoltage category III/pollution degree 2

¹ Mains voltage low/mains dropout: During low mains voltage or a mains dropout, the drive continues until the DC-link voltage drops below the minimum stop level, which typically corresponds to 15% below the drive's lowest rated supply voltage. Power-up and full torque cannot be expected at mains voltage lower than 10% below the drive's lowest rated supply voltage.

² The unit is suitable for use on a circuit capable of delivering not more than 100000 RMS symmetrical Amperes, 240/500/600 V maximum.

5.3 Control Input/Output and Control Data

5.3.1 Digital Inputs

Programmable digital inputs	4 (6) ⁽¹⁾
-----------------------------	----------------------

Terminal number	18, 19, 27 ⁽¹⁾ , 29 ⁽¹⁾ , 32, 33
Logic	PNP or NPN
Voltage level	0–24 V DC
Voltage level, logic 0 PNP	<5 V DC
Voltage level, logic 1, PNP	>10 V DC
Voltage level, logic 0 NPN ⁽²⁾	>19 V DC
Voltage level, logic 1 NPN ⁽²⁾	<14 V DC
Maximum voltage on input	28 V DC
Pulse frequency range	0–110 kHz
(Duty cycle) minimum pulse width	4.5 ms
Input resistance, R_i	Approximately 4 k Ω

¹ Terminals 27 and 29 can also be programmed as output.

² Except STO input terminal 37.

5.3.2 STO Terminal 37 (Terminal 37 is Fixed PNP Logic)

Voltage level	0–24 V DC
Voltage level, logic 0 PNP	<4 V DC
Voltage level, logic 1 PNP	>20 V DC
Maximum voltage on input	28 V DC
Typical input current at 24 V	50 mA rms
Typical input current at 20 V	60 mA rms
Input capacitance	400 nF

All digital inputs are galvanically isolated from the supply voltage (PELV) and other high-voltage terminals.

When using a contactor with a DC coil inside in combination with STO, it is important to make a return way for the current from the coil when turning it off. This can be done by using a freewheel diode (or, alternatively, a 30 V or 50 V MOV for quicker response time) across the coil. Typical contactors can be bought with this diode.

5.3.3 Analog Inputs

Number of analog inputs	2
Terminal number	53, 54
Modes	Voltage or current
Mode select	Switch S201 and switch S202
Voltage mode	Switch S201/switch S202 = OFF (U)
Voltage level	-10 V to +10 V (scaleable)
Input resistance, R_i	Approximately 10 k Ω
Maximum voltage	\pm 20 V
Current mode	Switch S201/S202 = ON (I)
Current level	0/4 to 20 mA (scaleable)
Input resistance, R_i	Approximately 200 Ω
Maximum current	30 mA
Resolution for analog inputs	10 bit (+ sign)
Accuracy of analog inputs	Maximum error 0.5% of full scale
Bandwidth	100 Hz

The analog inputs are galvanically isolated from the supply voltage (PELV) and other high-voltage terminals.

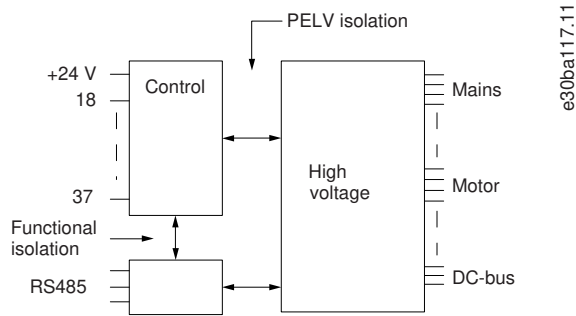

Illustration 12: PELV Isolation

5.3.4 Pulse/Encoder Inputs

Programmable pulse/encoder inputs	2/1
Terminal number pulse/encoder	29, 33 ⁽¹⁾ /32 ⁽²⁾ , 33 ⁽²⁾
Maximum frequency at terminals 29, 32, 33	110 kHz (Push-pull driven)
Maximum frequency at terminals 29, 32, 33	5 kHz (Open collector)
Maximum frequency at terminals 29, 32, 33	4 Hz
Voltage level	See 5.3.1 Digital Inputs .
Maximum voltage on input	28 V DC
Input resistance, R _i	Approximately 4 kΩ
Pulse input accuracy (0.1–1 kHz)	Maximum error: 0.1% of full scale
Encoder input accuracy (1–11 kHz)	Maximum error: 0.05% of full scale

¹ Pulse inputs are 29 and 33.

² Encoder inputs: 32=A, 33=B.

The pulse and encoder inputs (terminals 29, 32, 33) are galvanically isolated from the supply voltage (PELV) and other high-voltage terminals.

5.3.5 Digital Outputs

Programmable digital/pulse outputs	2
Terminal number	27, 29 ⁽¹⁾
Voltage level at digital/frequency output	0–24 V
Maximum output current (sink or source)	40 mA
Maximum load at frequency output	1 kΩ
Maximum capacitive load at frequency output	10 nF
Minimum output frequency at frequency output	0 Hz
Maximum output frequency at frequency output	32 kHz
Accuracy of frequency output	Maximum error: 0.1% of full scale
Resolution of frequency outputs	12 bit

¹ Terminals 27 and 29 can also be programmed as input.

The digital output is galvanically isolated from the supply voltage (PELV) and other high-voltage terminals.

5.3.6 Analog Output

Number of programmable outputs	1
Terminal number	42
Current range at analog output	0/4 to 20 mA
Maximum load GND - analog output less than	500 Ω
Accuracy on analog output	Maximum error: 0.5% of full scale

Resolution of analog output	12 bit
-----------------------------	--------

The analog output is galvanically isolated from the supply voltage (PELV) and other high-voltage terminals.

5.3.7 Control Card, 24 V DC Output

Terminal number	12, 13
Output voltage	24 V +1, -3 V
Maximum load	200 mA

The 24 V DC supply is galvanically isolated from the supply voltage (PELV), but has the same potential as the analog and digital inputs and outputs.

5.3.8 Control Card, +10 V DC Output

Terminal number	50
Output voltage	10.5 V ±0.5 V
Maximum load	15 mA

The 10 V DC supply is galvanically isolated from the supply voltage (PELV) and other high-voltage terminals.

5.3.9 Control Card, RS485 Serial Communication

Terminal number	68 (P,TX+, RX+), 69 (N,TX-, RX-)
Terminal number 61	Common for terminals 68 and 69

The RS485 serial communication circuit is galvanically isolated from the supply voltage (PELV).

5.3.10 Control Card, USB Serial Communication

USB standard	1.1 (full speed)
USB plug	USB type B plug

Connection to the PC is carried out via a standard host/device USB cable.

The USB connection is galvanically isolated from the supply voltage (PELV) and other high-voltage terminals.

The USB ground connection is not galvanically isolated from protective earth. Use only an isolated laptop as PC connection to the USB connector on the drive.

5.3.11 Relay Outputs

Programmable relay outputs	2
Relay 01 terminal number	1–3 (break), 1–2 (make)
Maximum terminal load (AC-1) ⁽¹⁾ on 1–3 (NC), 1–2 (NO) (resistive load)	240 V AC, 2 A
Maximum terminal load (AC-15) ⁽¹⁾ (inductive load @ cosφ 0.4)	240 V AC, 0.2 A
Maximum terminal load (DC-1) ⁽¹⁾ on 1–2 (NO), 1–3 (NC) (resistive load)	60 V DC, 1 A
Maximum terminal load (DC-13) ⁽¹⁾ (inductive load)	24 V DC, 0.1 A
Relay 02 terminal number	4–6 (break), 4–5 (make)
Maximum terminal load (AC-1) ⁽¹⁾ on 4–5 (NO) (resistive load) ⁰⁰	400 V AC, 2 A
Maximum terminal load (AC-15) ⁽¹⁾ on 4–5 (NO) (inductive load @ cosφ 0.4)	240 V AC, 0.2 A
Maximum terminal load (DC-1) ⁽¹⁾ on 4–5 (NO) (resistive load)	80 V DC, 2 A
Maximum terminal load (DC-13) ⁽¹⁾ on 4–5 (NO) (inductive load)	24 V DC, 0.1 A
Maximum terminal load (AC-1) ⁽¹⁾ on 4–6 (NC) (resistive load)	240 V AC, 2 A
Maximum terminal load (AC-15) ⁽¹⁾ on 4–6 (NC) (inductive load @ cosφ 0.4)	240 V AC, 0.2 A

Maximum terminal load (DC-1) ⁽¹⁾ on 4–6 (NC) (resistive load)	50 V DC, 2 A
Maximum terminal load (DC-13) ⁽¹⁾ on 4–6 (NC) (inductive load)	24 V DC, 0.1 A
Minimum terminal load on 1–3 (NC), 1–2 (NO), 4–6 (NC), 4–5 (NO)	24 V DC 10 mA, 24 V AC 20 mA
Environment according to EN 60664-1	Overvoltage category III/pollution degree 2

¹ IEC 60947 parts 4 and 5. The relay contacts are galvanically isolated from the rest of the circuit by reinforced isolation (PELV).

5.3.12 Control Card Performance

Scan interval	1 ms
---------------	------

5.3.13 Control Characteristics

Resolution of output frequency at 0–590 Hz	±0.003 Hz
Repeat accuracy of precise start/stop (terminals 18, 19)	≤±0.1 ms
System response time (terminals 18, 19, 27, 29, 32, 33)	≤2 ms
Speed control range (open loop)	1:100 of synchronous speed
Speed control range (closed loop)	1:1000 of synchronous speed
Speed accuracy (open loop)	30–4000 RPM: Error ±8 RPM
Speed accuracy (closed loop), depending on resolution of feedback device	0–6000 RPM: Error ±0.15 RPM
Torque control accuracy (speed feedback)	Maximum error ±5% of rated torque

All control characteristics are based on a 4-pole asynchronous motor.

6 Appendix

6.1 Abbreviations

Table 22: Abbreviations

Term	Definition
AC	Alternating current
AWG	American wire gauge
DC	Direct current
EMC	Electromagnetic compatibility
ETR	Electronic thermal relay
IEC	International Electrotechnical Commission
IP	Ingress protection
LCP	Local control panel
LOP	Local operation pad
mA	Milliamp
NC	Normally closed
NEMA	National Electrical Manufacturers Association
NO	Normally open
PELV	Protective extra low voltage
PTC	Positive temperature coefficient
RMS	Root means square (cyclically alternating electric current)
RPM	Revolutions per minute
STO	Safe Torque Off
UPS	Uninterruptible power supply
UTP	Unshielded twisted pair
V	Volt

Danfoss A/S
Ulsnaes 1
DK-6300 Graasten
vlt-drives.danfoss.com

Danfoss can accept no responsibility for possible errors in catalogs, brochures, and other printed material. Danfoss reserves the right to alter its products without notice. This also applies to products already on order provided that such alterations can be made without subsequential changes being necessary in specifications already agreed. All trademarks in this material are property of the respective companies. Danfoss and the Danfoss logotype are trademarks of Danfoss A/S. All rights reserved.

