



3500 Annapolis Lane North, Minneapolis, MN 55447
 Telephone: (763) 509-2084 Telefax: (763) 559-0108

Unit Specification

KE04101 Valve Drive Amplifier

ISSUE: 2

DATE: September 1996

GENERAL DESCRIPTION

The device is a free-standing amplifier mounted on 4 standoffs. Voltage from a sensor potentiometer, through the amplifier, produces current to drive electrohydraulic actuators. Connections to the amplifier are via screw terminals. An external switch can change gain settings by shorting between two terminals.

DIMENSIONS

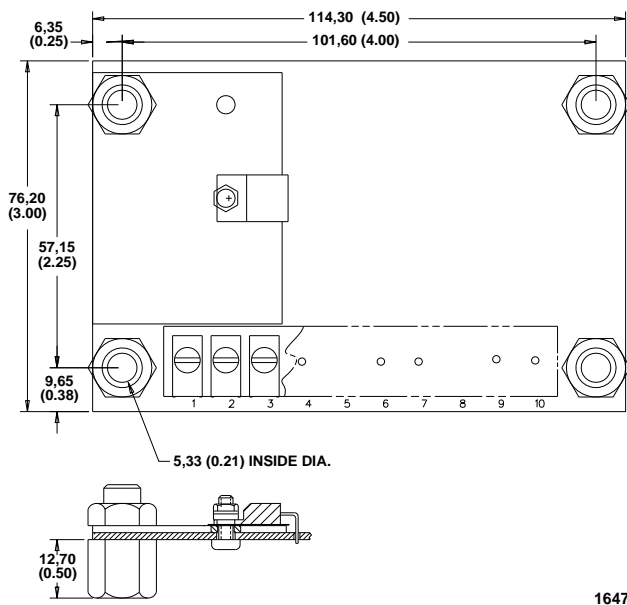

Dimensions of the KE04101 in Millimeters (Inches).

CONNECTION DIAGRAM

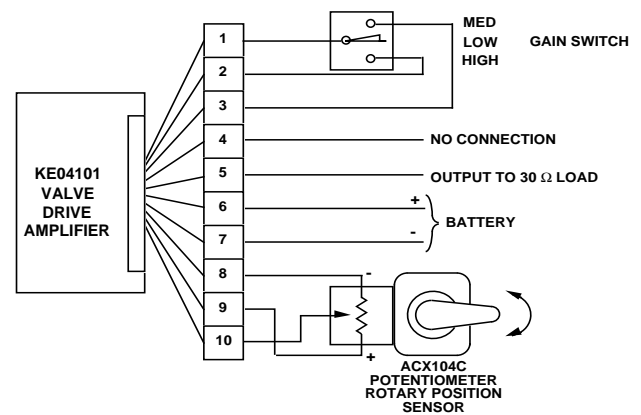

POLARITY OF BATTERY CONNECTIONS MAY BE REVERSED TO CHANGE ACTION OUTPUT VERSUS SENSOR INPUT

GAIN SWITCH IS OPTIONAL. JUMPERS MAY BE USED IN PLACE OF SWITCH

OUTPUT CHARACTERISTICS

SUPPLY VOLTAGE
12 Vdc (11 to 15 Volts)

TURN ON VOLTAGE
48% of supply

MAXIMUM OUTPUT CURRENT
100 mA nominal

% MAXIMUM
OUTPUT VOLTAGE

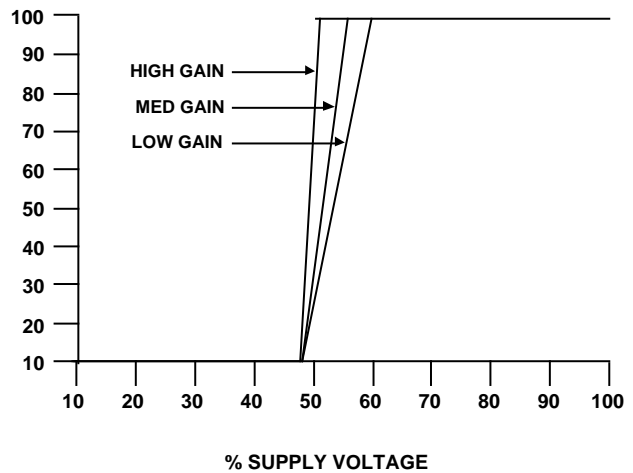

1649A