

Datasheet

# RA2000 One Pipe Steam Thermostatic radiator valve

(For use on one-pipe low-pressure steam systems)

## Typical Installation (Examples):

**FREE STANDING RADIATORS:** The free-standing one-pipe low-pressure steam radiator is positioned where air continually passes freely over the operator.

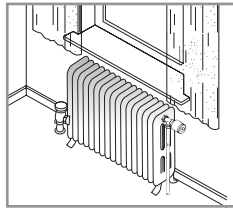

Use standard or tamper resistant model w/ combined dial/ operator/sensor. Always install the operator horizontally.

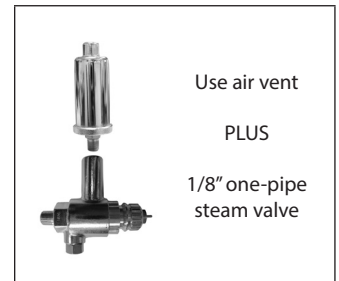

### FREE STANDING RADIATORS

The free-standing one-pipe low-pressure steam radiator is accessible, but due to obstruction air cannot continually pass freely over the operator.

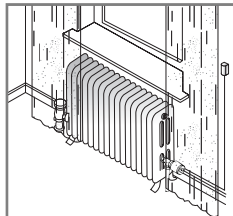

Use dial / operator w/ remote sensor. The sensor & capillary tube may be extended up to 6' & can be easily wall mounted.

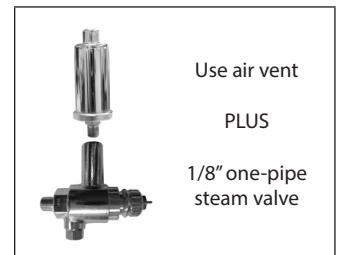

### CONVECTORS

The one-pipe low-pressure steam convector is inaccessible; room air cannot continually pass freely over the sensing element.

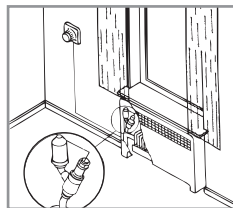

Use operator w/ combined remote dial / sensor. The dial/ sensor & capillary tube may be extended up to 6' & wall mounted.

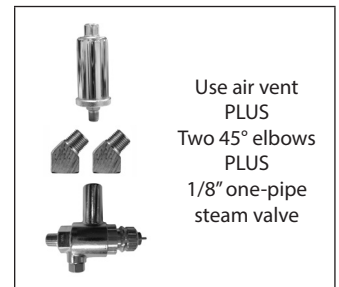

### ENCLOSED RADIATORS

The cabinet enclosed radiator configuration requires that the dial and sensor be mounted separately, away from the valve.

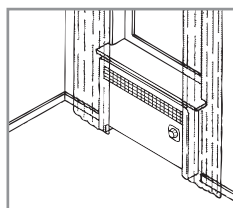

Use operator w/ separate remote dial & remote sensor. Place the remote sensor on a draft-free wall. The remote dial mounts on the enclosure or wall.

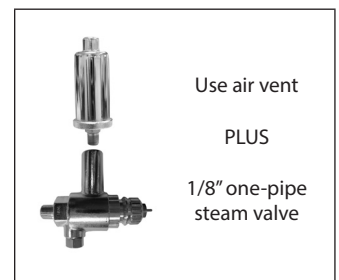

## Datasheet: RA2000 One-Pipe Steam Thermostatic radiator valve

### Design & Function:

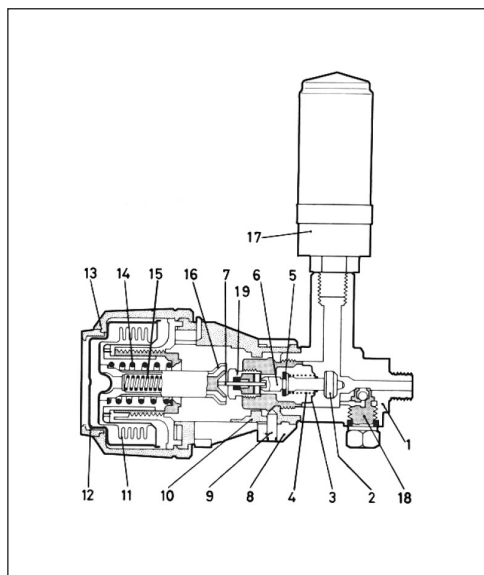

Part	Material
1. Valve	Nicel plated brass
2. Valve disc	EPDM
3. Spindle guide	Phosphor bronze
4. Spring	Stainless Steel
5. Back seat washer	EPDM
6. Valve Spindle	Brass
7. Pressure pin	Stainless steel
8. Clamping band	Al. alloy
9. Allenscrew	Steel
10. Socket	Zytel Nylon
11. Bellows	Phosphor bronze
12. Operator dial face	-
13. Handle	ABS
14. Adjustment spring	Steel
15. Safety spring	Steel
16. Pressure spindle	Polymide no. 6
17. Air vent / -	-
18. Vacuum breaker	Brass
19. Packing gland	DRZ brass

- Danfoss' RA 2000 1PS one-pipe steam thermostatic radiator valve provides accurate temperature control and quite operation.
- The movement of air across the thermostatic operator effects the modulation control in regulating the venting of air from the radiator or convector.
- Based on the set temperature on the operator, the 1PS regulates the amount of steam allowed into the emitter by controlling the amount of air allowed to vent out.
- The venting action occurs during each system (boiler) on-cycle only when heat

is required. Air will re-enter the system during the boiler off-cycle via a patented "across the seat" vacuum breaker. This eliminates condensate buildup and allows natural system aspiration to take place.

- The RA 2000 1PS assembly is specifically designed for low pressure steam systems. The system pressure should not be constant preventing air to get back into the system.
- Thermostatic radiator valve assembly-valve, thermostatic operator and air vent-can be used for free standing radiators, convectors, and enclosed radiators. 1PS is not recommended for copper fin tube radiators.

### Dimensions:

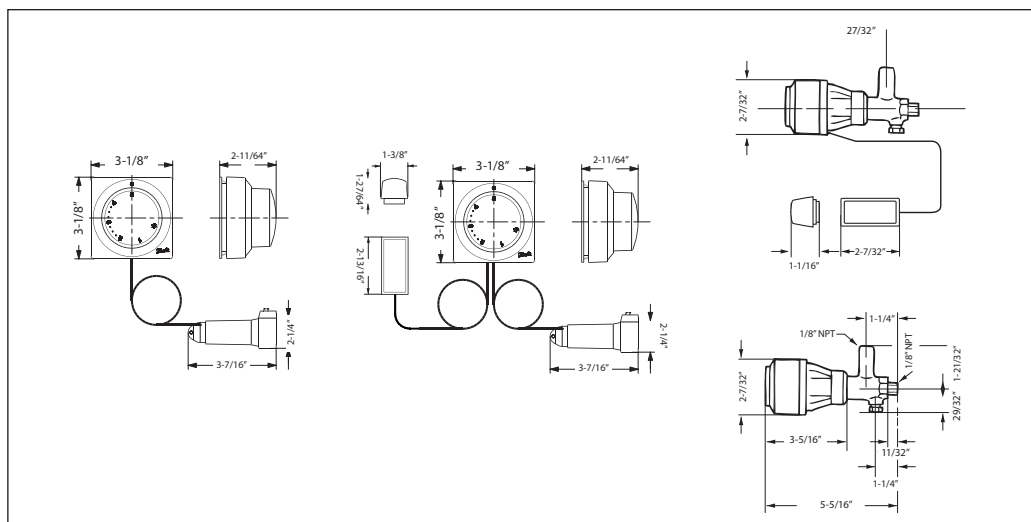







Datasheet: RA2000 One-Pipe Steam Thermostatic radiator valve

Technical Data:

Type	Maximum Temperature	Maximum Pressure
RA 2000 1PS	250°F (121°C)	15psig

RA 2000 Operators:

Operator	Code No.	Description	Sensor	Capillary
	<b>015G4290</b>	Valve mounted dial & sensor	Built-in	-
	<b>015G4292</b>	Valve mounted dial with remote sensor	Remote	6'
	<b>015G4240</b>	Valve mounted dial and sensor, tamper resistant	Built-in	-
	<b>015G4042</b>	Valve mounted dial with remote sensor tamper resistant	Remote	6'
	<b>013G8562</b>	Combined remote mounted dial & sensor	-	6'
	<b>013G8565</b>	Combined remote mounted dial & sensor	-	16'
	<b>013G8568</b>	Combined remote mounted dial & sensor	-	26'
	<b>013G8564</b>	Separate remote mounted dial and sensor	Remote	6' + 6'

Parts and Accessories  
For RA 2000 Operators:

015G4290  
015G4292  
015G4240  
015G4042

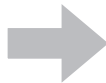

Code No.	Description
<b>013G1236</b>	Screwdriver tool set for tamper resistant operators.
<b>013G1215</b>	Limitation pins for Danfoss Aveo® 4290 / 4292 (30 pcs)
<b>013G1237</b>	Limitation pins for tamper resistant operators Danfoss Aveo® 4240 / 4042 (30 pcs)
<b>013G5245</b>	Anti-theft protection clips for Danfoss Aveo® 4290 / 4292 (20 pcs)
<b>013G1232</b>	Locking screw plugs for tamper resistant operators Danfoss Aveo® 4240 / 4042 (50 pcs).
<b>015G4952</b>	Cover plate for setting Window of tamper resistant operators (20 pcs)

013G8562  
013G8565  
013G8568  
013G2564



Code No.	Description	Position No.
<b>013G5191</b>	Socket Body for RA 2000	1
<b>013G5503</b>	Bellows Holder (set of 2 pcs)	2

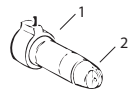

RA 2000 1PS Valve :

Design	Code No.	Valve size	Pattern	Connection Inlet x Outlet
	<b>013G0140</b>	1/8"	1PS	MPT x FTP

**Parts and Accessories  
For RA 2000 1PS Valve :**

Code No.	Description
013L8011	1-Pipe steam air vent
013L8300	Brass 45° street elbow for convector, for space consideration
013G0290	Packing gland for valves

**How to avoid problems:**

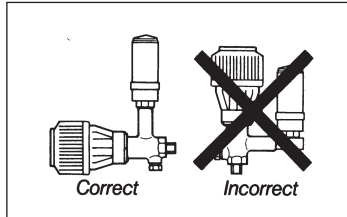

The operator with valve-mounted dial and sensor must be mounted horizontally.

**IMPORTANT**

In one-pipe steam systems sufficient pitch is required to permit condensate return. Condensate should not be trapped in the valve or vent. The vent (when not supplied) should be checked to assure it is properly working.

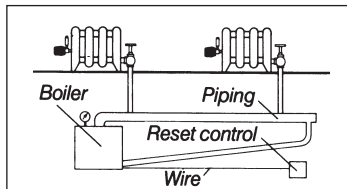

Boiler/steam supply must not run at constant pressure. This prevents the ability for air to enter back into the system.

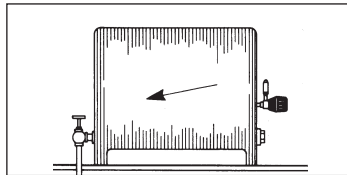

Make sure that free-standing radiators or cast iron convectors are properly pitched and that hand valves are FULLY open.

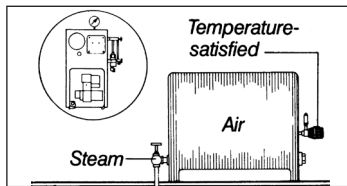

To aid in preventing overheating of rooms that are temperature satisfied, boiler steam pressure must be kept low, recommended normally at or below 2psig. Otherwise air will be compressed in the radiator, allowing steam to enter when not required.

**Setting:**

Control of the space temperature at a comfortable level is easily accomplished by adjusting the dial clockwise or counter-clockwise. The dial has a numbered scale of 1 to 5 corresponding to temperatures of approximately 57°F to 79°F (14°C to 26°C).

Integrated with the standard valve mounted operators is a tactile feedback when setting the temperature. The subtle click sound provides a 1°F (0.5°C) indication of temperature setting change when adjusting.

Should the space be unoccupied for an extended period, the dial can be set to the “\*” symbol for freeze protection (50°F or 9°C) to save energy.



*	1	2	• •	3	• •	4	5	
	45	57	63	68	73	79		°F
	7	14	17	20	23	26		°C
Room temperature								
* = Frost protection setting								
Indicated temperatures are approximate. Adjust the dial to the desired setting.								

**Danfoss**

Tel.: 1-888-DANFOSS (326-3677) | Fax: 416-352-5981 | www.heating.danfoss.us

Danfoss can accept no responsibility for possible errors in printed materials and reserves the right to alter its products without notice. All trademarks in this material are property of the respective companies. Danfoss and Danfoss logotype are trademarks of Danfoss A/S. All rights reserved.