

ENGINEERING  
TOMORROW

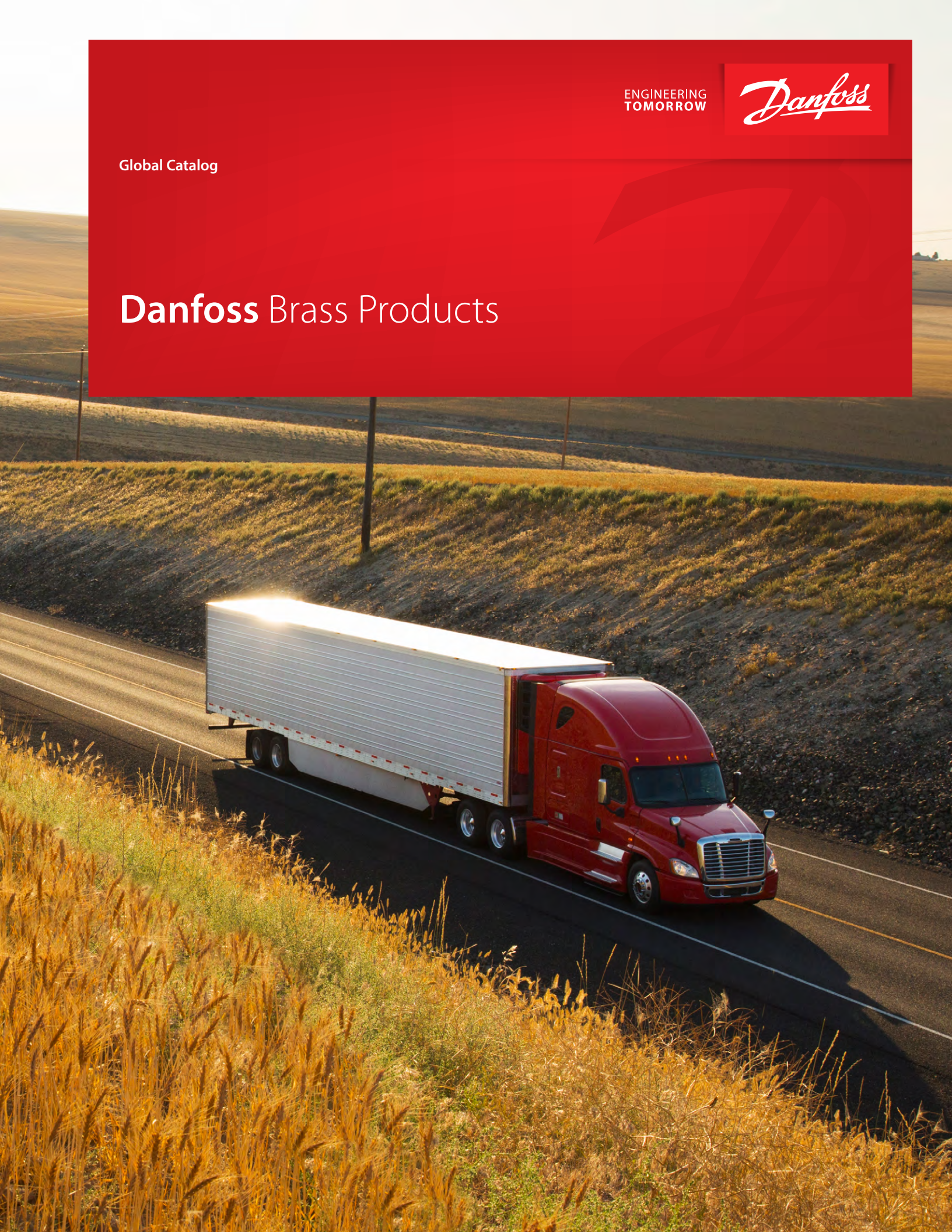

Global Catalog

# Danfoss Brass Products



# Table of Contents

## Application Data

Important Safety Information .....	3
Visual Index .....	4
Numbering Systems .....	10
Tube Connector Selector Chart .....	11
Thread Identification .....	12
Tubing Selection .....	17
Flare Dimensions .....	21
Tubing Installation .....	22
Chemical Compatibility Chart .....	23

## Tubing

Plastic Tubing .....	28
Air Brake Tubing .....	31

## Brass Products

Introduction .....	33
Inverted Flare .....	34
SAE 45° Flare .....	39
Compression .....	44
SelfAlign™ .....	50
Polyline™ Flareless .....	56
Push>Connect™ .....	60
Push>Connect Metric .....	67
Push>Connect Flow Controls .....	71
Push>Connect Plus .....	73
Mini-Barb .....	75
Quick>Connect™ Air Brake - Brass & Composite .....	79
Air Brake - Nylon Tubing .....	88
Air Brake - Copper Tubing .....	94
Threaded Sleeve .....	99
Pipe .....	103
Needle Valves .....	108
Drain Cocks .....	111
Truck Valves .....	113

Plastic Drain Cocks .....	114
Ground Plug & Multiple Shut-Offs .....	115
Brass Ball Valves .....	117
Special Adapter .....	121
Hydraulic Brake Products .....	125

## Plastic Products

Molded Compression Tube Products .....	127
Plastic Products .....	135

## Brass – Nickel Plated

BSPP Products .....	136
---------------------	-----

## Related Products

Assembly & Tool Cutting Equipment .....	137
Air Brake Products & Measuring Kits .....	137
Tube Cutting Equipment .....	138
Tube Bending Tools .....	139
Tube Flaring & Brazing Tools .....	140
Label Sets & Bags .....	141
Cabinets & Assortments .....	142

## Certification

ISO & QS Certifications .....	150
-------------------------------	-----

## Conversion

Conversion Charts .....	151
-------------------------	-----

## Glossary

Alpha/Numeric .....	153
---------------------	-----

## Index

Numeric/Alpha .....	156
---------------------	-----

# Application Data

## Important Safety Information

### Warning

#### Selection of Tubing

Selecting the proper tubing for a given application is essential to the proper operation and safe use of the tubing and related equipment. Inadequate attention to the selection of the tubing for an application can result in leakage, bursting, or other failure which can cause serious bodily injury or property damage from spraying fluids or flying projectiles. In order to avoid serious bodily injury or property damage resulting from selection of the wrong tubing, carefully review the information in this catalog. Some of the factors that are involved in the selection of the proper tubing are:

- material of tubing
- bends
- tubing size
- temperature
- tubing length
- tubing pressure rating
- tubing end connections
- installation design
- fluid conveyed (compatibility)

These factors and the other information in this catalog should be considered when selecting the proper tubing for an application.

#### Proper Selection of Tube Fittings

Selection of the proper Danfoss tube products for the application is essential to the proper operation and safe use of tubing and related equipment. Inadequate attention to the selection of the products for your application can result in tube leakage, bursting, or other failure which can cause serious injury or property damage from spraying fluids or flying projectiles. In order to avoid serious bodily injury or property damage resulting from selection of the wrong tube end fitting, carefully review the information in this catalog. Some of the factors which are involved in the selection of the proper products are:

- tube end connections
- installation design
- compatibility with tubing
- tubing size
- temperature
- corrosion requirements

These factors and the other information in this catalog should be considered selecting the proper tube when for an application.

#### Tubing Installation

Proper installation of the tubing is essential to the proper operation and safe use of the tubing and related equipment. Improper installation of the tubing can result in serious injury or property damage. In order to avoid serious bodily injury or property damage resulting from improper installation of the tubing, carefully review the information in this catalog regarding tubing installation.

Some of the factors you must consider in installing the tubing properly are:

- proper installation procedures
- changes in length
- protection from high temperature sources
- twisting
- stress
- rubbing and abrasion

These factors and other information in this catalog regarding tubing installation should be considered before installing the tubing.

#### Tubing Assembly

Changes in materials, finishes, and assembly techniques may affect the sealing or holding capability of the joint. Due to the great variety of possible assembly scenarios, assembly procedures should be tested to determine if the joint is adequate for its intended use. Improper assembly or overtightening could result in leakage, tubing separation or other failures which could cause serious bodily injury or property damage from spraying fluids or flying projectiles.

These factors and other information in this catalog regarding tubing assembly should be considered before installing the tubing.

#### Dimensions

Dimensions given in this catalog are approximate and should be used for reference only. Exact dimensional information for a given product is subject to change and varying tolerances.

# Application Data

## Visual Index

### Inverted Flare

<b>Tube Nut (Steel)</b>  105x pg. 35	<b>Tube Nut (Brass)</b>  100x pg. 35	<b>Plug (Steel)</b>  131x pg. 35	<b>Tube Nut Long (Steel)</b>  7896x pg. 35	<b>Union</b>  302x pg. 35	<b>Adapter SAE 45° Flare to Inv. Flare</b>  pg. 36
<b>Male Connector</b>  202x pg. 36	<b>Female Connector</b>  252x pg. 36	<b>45° Male Elbow</b>  352x pg. 36	<b>90° Union Elbow</b>  502x pg. 37	<b>90° Male Elbow</b>  402x pg. 37	
<b>90° Female Elbow</b>  452x pg. 37	<b>Union Tee</b>  702x pg. 38	<b>Male Run Tee</b>  752x pg. 38	<b>Male Branch Tee</b>  602x pg. 38	<b>Female Branch Tee</b>  652x pg. 38	

### SAE 45° Flare

<b>Nut</b>  1110x pg. 40	<b>Long Nut</b>  41x pg. 40	<b>Cap</b>  40x pg. 40	<b>Plug</b>  39x pg. 40	<b>Union</b>  42x pg. 40	<b>Male Connector</b>  48x pg. 41
<b>Female Connector</b>  46x pg. 41	<b>Male Ball Check Connector</b>  43x pg. 41	<b>45° Male Elbow</b>  54x pg. 41	<b>AC Type Adapter</b>  pg. 42	<b>Adapter SAE 45° Flare to Inv. Flare</b>  pg. 42	<b>90° Union Elbow</b>  55x pg. 42
<b>90° Male Elbow</b>  49x pg. 42	<b>90° Female Elbow</b>  50x pg. 42	<b>Union Tee</b>  44x pg. 43	<b>Male Run Tee</b>  51x pg. 43	<b>Male Branch Tee</b>  45x pg. 43	<b>Adapter Tee</b>  56x pg. 43







### Compression and Selfalign Products

<b>Tube Support for Plastic Tubing</b>  2030x pg. 45	<b>Sleeve</b>  60x pg. 45    601x pg. 52	<b>Nut</b>  61x pg. 45    611x pg. 52	<b>Long Nut</b>  1611x pg. 46	<b>Bulkhead Nut</b>  0102x pg. 46	<b>Union</b>  62x pg. 46    621x pg. 53
<b>Male Connector</b>  68x pg. 46    681x pg. 53	<b>Female Connector</b>  66x pg. 47    661x pg. 53	<b>Male Ball Check Connector</b>  63x pg. 47    631x pg. 53	<b>Bulkhead Union</b>  74x pg. 47    741x pg. 54	<b>90° Male Elbow</b>  69x pg. 48    691x pg. 54	<b>90° Union Elbow</b>  65x pg. 48    651x pg. 54
<b>90° Female Elbow</b>  70x pg. 48    701x pg. 54	<b>Union Tee</b>  64x pg. 49    641x pg. 55	<b>Male Run Tee</b>  71x pg. 49    711x pg. 55	<b>Male Branch Tee</b>  72x pg. 49    721x pg. 55	<b>Adapter Tee</b>  76x pg. 49	

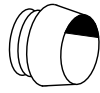

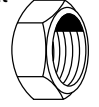
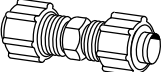
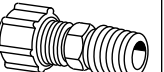
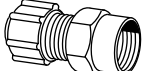

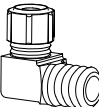
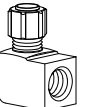

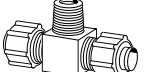

# Application Data

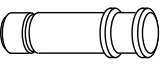
## Visual Index

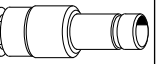
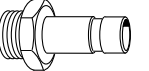
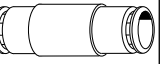
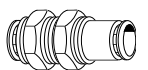
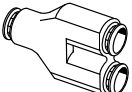
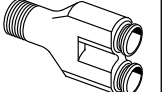
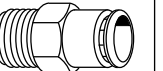
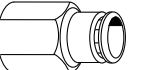
### Polyline Flareless

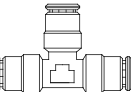
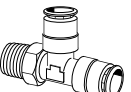
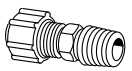
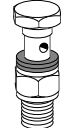
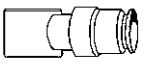

<b>Plastic Sleeve</b>  1260x pg. 57	<b>Brass Nut</b>  1261x- pg. 57	<b>Brass Nut/Plastic Sleeve Assembly</b>  1261x-Ax pg. 57	<b>Brass Bulkhead Nut</b>  1202x-A pg. 57	<b>Union</b>  1262x pg. 57	<b>Male Connector</b>  1268x pg. 58
<b>Female Connector</b>  1266x pg. 58	<b>Bulkhead Union</b>  1274x pg. 58	<b>Male Elbow</b>  1269x pg. 59	<b>Female Elbow</b>  1270x pg. 59	<b>Union Tee</b>  1264x pg. 59	<b>Male Run Tee</b>  1271x pg. 59
<b>Male Branch Tee</b>  1272x pg. 59					

### Push>Connect

<b>Cartridge</b>  Metric 1161x pg. 67 pg. 62	<b>Plug (Plastic)</b>  Metric 1129x pg. 67 pg. 62	<b>Double Union</b>  Metric 1105x pg. 67 pg. 62	<b>Reducer</b>  Metric 1109x pg. 67 pg. 62	<b>Stem Adapter</b>  Metric 1180x pg. 67 pg. 63	<b>Union</b>  Metric 1612x pg. 67 pg. 63
<b>Bulkhead Union</b>  Metric 1174x pg. 68 pg. 63	<b>Union "Y"</b>  Metric 1107x pg. 68 pg. 63	<b>Male "Y"</b>  Metric 1108x pg. 68 pg. 64	<b>Male Connector</b>  Metric 1168x pg. 68 pg. 64	<b>Female Connector</b>  Metric 1166x pg. 68 pg. 64	<b>Union Elbow</b>  Metric 1165x pg. 69 pg. 64
<b>Swivel Male Elbow</b>  Metric 1169x-S pg. 69 pg. 65	<b>Male Elbow</b>  Metric 1169x pg. 69 pg. 65	<b>Union Tee</b>  Metric 1164x pg. 70 pg. 65	<b>Male Run Tee Swivel</b>  Metric 1171x-S pg. 70 pg. 65	<b>Male Connector</b>  Metric 1168x pg. 68 pg. 64	<b>Stud Manifolds</b>  pg. 66
<b>Banjos</b>  pg. 66	<b>Flow Controls</b>  pg. 72				

Push > Connect Plus see page 75.

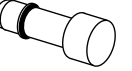
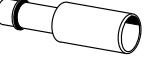
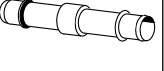
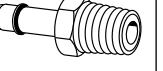
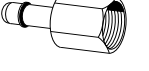
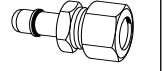
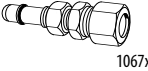
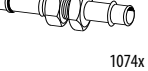

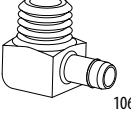
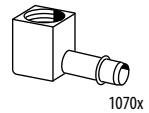
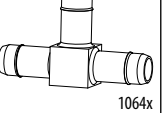
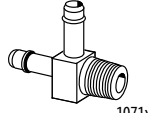
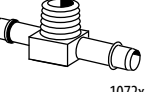
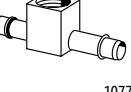
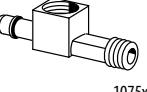







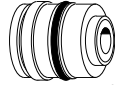

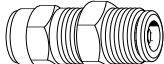

### Mini-Barb

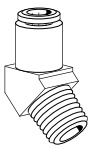
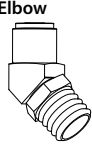
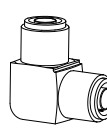
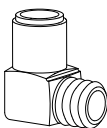
<b>Plug</b>  1073x pg. 76	<b>Solder Connector</b>  1079x pg. 76	<b>Union</b>  1062x pg. 76	<b>Male Connector</b>  1068x pg. 76	<b>Female Connector</b>  1066x pg. 76	<b>Compression Connector</b>  1078x pg. 76
<b>Bulkhead Compression Connector</b>  1067x pg. 77	<b>Bulkhead Union</b>  1074x pg. 77	<b>Union Elbow</b>  1065x pg. 77	<b>90° Male Elbow</b>  1069x pg. 77	<b>90° Female Elbow</b>  1070x pg. 77	<b>Union Tee</b>  1064x pg. 78
<b>Male Run Tee</b>  1071x pg. 78	<b>Male Branch Tee</b>  1072x pg. 78	<b>Female Branch Tee</b>  1077x pg. 78	<b>Adapter Tee</b>  1075x pg. 78		

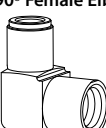



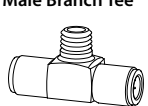

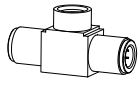
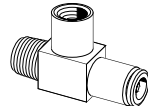
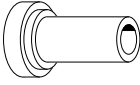
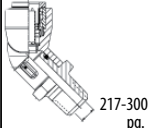
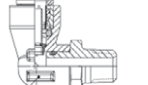



# Application Data

## Visual Index

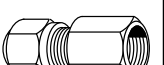
### Quick>Connect Air Brake

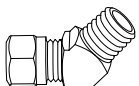
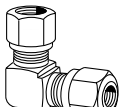
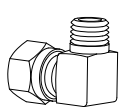
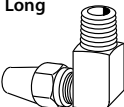
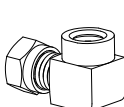
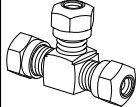
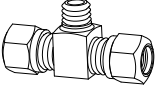
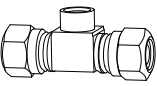
<b>Encapsulated Cartridge</b>  1861x pg. 81	<b>Union</b>  1862x pg. 81	<b>Quick Connect Bulkhead Union</b>  1874x pg. 81	<b>Female Bulkhead Union</b>  1873x pg. 81	<b>Male Connector</b>  1868x pg. 82	<b>Female Connector</b>  1866x pg. 82
<b>45° Male Elbow</b>  1880x pg. 82	<b>45° Male Swivel Elbow</b>  1880x-S pg. 83	<b>90° Union Elbow</b>  1865x pg. 83	<b>90° Male Elbow</b>  1869x pg. 83	<b>90° Male Elbow Long</b>  1869x-L pg. 83	<b>90° Male Swivel Elbow</b>  1869x-S pg. 84
<b>90° Female Elbow</b>  1870x pg. 84	<b>Union Tee</b>  1864x pg. 84	<b>Male Run Tee</b>  1871x pg. 84	<b>Male Swivel Run Tee</b>  1871x-S pg. 85	<b>Male Branch Tee</b>  1872x pg. 85	<b>Swivel Male Branch Tee</b>  1872x-S pg. 85
<b>Female Branch Tee</b>  1877x pg. 85	<b>Adapter Tee</b>  1883x pg. 87	<b>Pressure Plug</b>  1829x pg. 87	<b>Composite 45° Q-Elbow</b>  217-30000 pg. 86	<b>Composite 90° Q-Elbow</b>  217-10000 pg. 86	

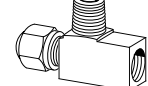
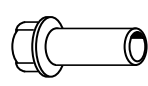





### Air Brake Connectors for Nylon Tubing

<b>Sleeve</b>  1460x pg. 89	<b>Nut</b>  1461x pg. 89	<b>Union</b>  1462x pg. 89	<b>Male Connector</b>  1468x pg. 90	<b>Female Connector</b>  1466x pg. 90	<b>Bulkhead Union</b>  1474x pg. 90
<b>45° Male Elbow</b>  1480x pg. 90	<b>Union Elbow</b>  1465x pg. 91	<b>90° Male Elbow</b>  1469x pg. 91	<b>90° Male Elbow Long</b>  1469x-L pg. 91	<b>90° Female Elbow</b>  1470x pg. 91	<b>Union Tee</b>  1464x pg. 92
<b>Male Branch Tee</b>  1472x pg. 92	<b>Female Branch Tee</b>  1477x pg. 92	<b>Male Run Tee</b>  1471x pg. 92	<b>Adapter Tee</b>  1482x pg. 93	<b>Insert</b>  1484x pg. 93	<b>Gauge Ring</b>  1485x pg. 93

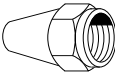
# Application Data

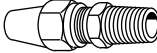
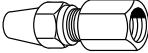
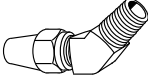
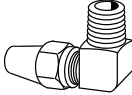
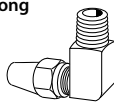
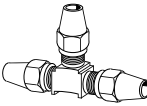
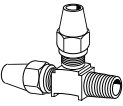
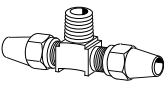
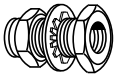
## Visual Index

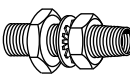
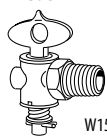



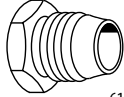
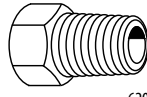
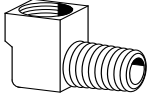

### Air Brake Connectors for Copper Tubing

<b>Sleeve</b>  1360x pg. 95	<b>Nut</b>  1361x pg. 95	<b>Union</b>  1362x pg. 95	<b>Male Connector</b>  1368x pg. 95	<b>Female Connector</b>  1366x pg. 96	<b>45° Male Elbow</b>  1380x pg. 96
<b>90° Male Elbow</b>  1369x pg. 96	<b>90° Male Elbow Long</b>  1369x-L pg. 96	<b>Union Tee</b>  1364x pg. 97	<b>Male Run Tee</b>  1371x pg. 97	<b>Male Branch Tee</b>  1372x pg. 97	<b>Bulkhead Coupling (brass)</b>  pg. 97
<b>Bulkhead Coupling (brass)</b>  pg. 98	<b>Bulkhead Coupling (brass)</b>  pg. 98	<b>Drain Cock</b>  W15310 pg. 98	<b>Shut-Off Valve</b>  W2033L pg. 98	<b>External Seat Draincock</b>  145 pg. 98	

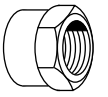
### Threaded Sleeve

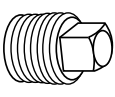
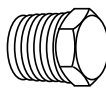
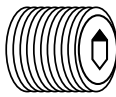
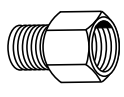
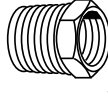
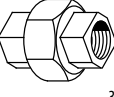
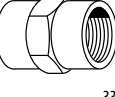
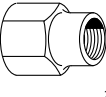
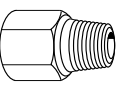
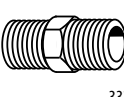
<b>Nut</b>  6100x pg. 100	<b>Male Connector</b>  6200x pg. 100	<b>Male Elbow</b>  6400x pg. 100
---	--	---

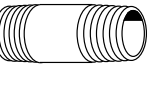
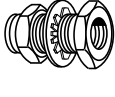

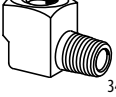
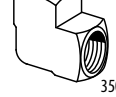
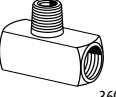
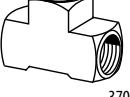
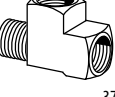
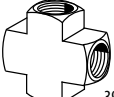
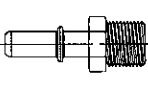
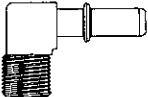



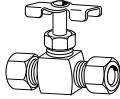
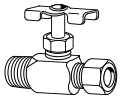
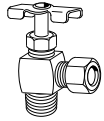

### Pipe

<b>Cap</b>  3129x pg. 102	<b>Slotted Plug</b>  3150x pg. 102	<b>Square Head Plug</b>  3151x pg. 102	<b>Hex Head Plug</b>  3152x pg. 102	<b>Hex Socket Plug</b>  3153x pg. 102	<b>Adapter</b>  3200x pg. 102
<b>Bushing</b>  3220x pg. 103	<b>Union</b>  3250x pg. 103	<b>Coupling</b>  3300x pg. 103	<b>Reducer Coupling</b>  3300x pg. 103	<b>Restriction Pipe Adapter</b>  pg. 103	<b>Hex Nipple</b>  3325x pg. 104
<b>Close Nipple</b>  3326x pg. 104	<b>Long Nipple</b>  pg. 104	<b>Bulkhead Coupling (brass)</b>  pg. 105	<b>45° Street Elbow</b>  3350x pg. 105	<b>90° Street Elbow</b>  3400x pg. 105	<b>90° Elbow</b>  3500x pg. 106
<b>Male Branch Tee</b>  3600x pg. 106	<b>Tee</b>  3700x pg. 106	<b>Male Run Tee</b>  3750x pg. 106	<b>Cross</b>  3950x pg. 106	<b>Straight</b>  pg. 107	<b>90° Elbow</b>  pg. 107



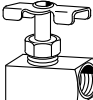

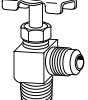

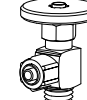
# Application Data

## Visual Index

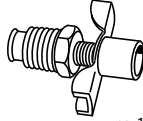
### Needle Valves

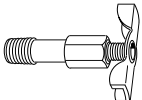
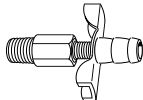
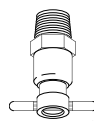
<p><b>Compression Double</b></p>  <p>pg. 108</p>	<p><b>Compression Straightway</b></p>  <p>pg. 108</p>	<p><b>Compression Angle</b></p>  <p>pg. 108</p>	<p><b>Inverted Straightway</b></p>  <p>pg. 108</p>	<p><b>Male Pipe Double</b></p>  <p>pg. 109</p>	<p><b>Male to Female Pipe</b></p>  <p>pg. 109</p>
<p><b>Female Pipe</b></p>  <p>pg. 109</p>	<p><b>SAE 45° Flare Straightway</b></p>  <p>pg. 110</p>	<p><b>SAE 45° Flare Angle</b></p>  <p>pg. 110</p>	<p><b>Polyline Straightway</b></p>  <p>pg. 110</p>	<p><b>Polyline Angle</b></p>  <p>pg. 110</p>	

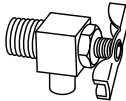
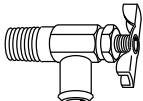
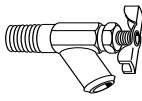
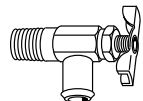
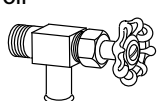
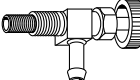
### Drain Cocks

<p><b>External Seat</b></p>  <p>pg. 111</p>	<p><b>External Seat</b></p>  <p>pg. 111</p>	<p><b>Internal Seat</b></p>  <p>pg. 111</p>	<p><b>Internal Seat (long)</b></p>  <p>pg. 111</p>	<p><b>Internal Seat</b></p>  <p>pg. 112</p>	<p><b>Internal Seat Drain Valve</b></p>  <p>pg. 112</p>
<p><b>Air Vent</b></p>  <p>pg. 112</p>	<p><b>Angle Bib Drain</b></p>  <p>pg. 112</p>	<p><b>Angle Bib Drain</b></p>  <p>pg. 112</p>	<p><b>Hose to Pipe (steel)</b></p>  <p>pg. 113</p>	<p><b>Hose to Pipe (steel)</b></p>  <p>pg. 113</p>	<p><b>Pipe to Hose Shut-Off</b></p>  <p>pg. 113</p>
<p><b>Gasoline Shut-Off with screen filter</b></p>  <p>pg. 113</p>	<p><b>Air Tank Drain Valve</b></p>  <p>pg. 113</p>				

### Truck Valves

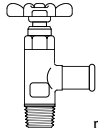
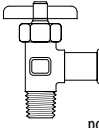
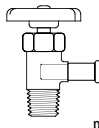
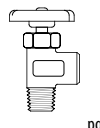
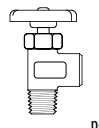







<p><b>Truck Valve</b></p>  <p>7502 pg. 114</p>	<p><b>Truck Valve</b></p>  <p>7504 pg. 114</p>	<p><b>Truck Valve</b></p>  <p>7506 pg. 114</p>	<p><b>Truck Valve</b></p>  <p>7508 pg. 114</p>	<p><b>Truck Valve</b></p>  <p>7509 pg. 114</p>
---	---	---	--	---

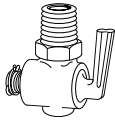



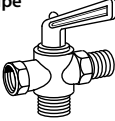
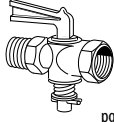
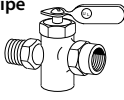
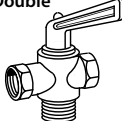
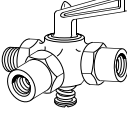

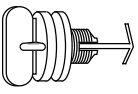
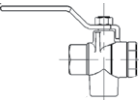
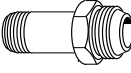









# Application Data

## Visual Index

### Ground Plug & Multiple Shut-Offs

<b>Draincock</b>  pg. 118	<b>Ground Plug Drain</b>  pg. 118	<b>SAE 45° Flare Double</b>  pg. 118	<b>SAE 45° Flare Straightway</b>  pg. 119	<b>Compression Double</b>  pg. 119	<b>Compression Straightway</b>  pg. 119
<b>Male to Female Pipe</b>  pg. 119	<b>Truck Shut-Off to Female Pipe</b>  pg. 119	<b>Marine Shut-Off Male to Female Pipe</b>  pg. 120	<b>Female Pipe Double</b>  pg. 120	<b>3-Way Shut-Off</b>  pg. 120	<b>3-Way Multiple Shut-Off</b>  pg. 120
<b>4-Way Multiple Shut-Off</b>  pg. 120	<b>Plastic Drain Cocks</b>  pg. 117	<b>Brass Ball Valves</b>  pg. 121-127	<b>Special Adapters</b>  pg. 125-128	<b>BSPP Products</b>  pg. 141	

### Molded Compression Tube Fittings

<b>Male Connector</b>  1568x pg. 134	<b>Union Connector</b>  1562x pg. 135	<b>Bulkhead Union</b>  1574x pg. 134	<b>Female Connector</b>  1566x pg. 135	<b>Male Elbow</b>  1569x pg. 136	<b>Female Elbow</b>  1570x pg. 136
<b>Union Tee</b>  1564x pg. 137	<b>Union Elbow</b>  1564x pg. 137	<b>Male Branch Tee</b>  1572x pg. 137	<b>Male Run Tee</b>  1571x pg. 138	<b>Compression Nut</b>  1561x pg. 138	<b>Insert</b>  1584x pg. 138
<b>Cap Nut</b>  1529x pg. 139	<b>Bulkhead Nut</b>  1502x pg. 139	<b>KYNAR Check Valve</b>  1531x pg. 139			

### Plastic Barbed Fittings

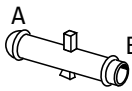
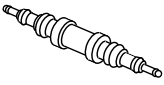
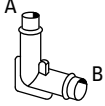
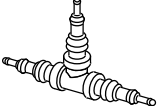
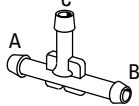
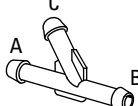
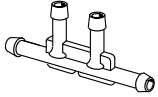
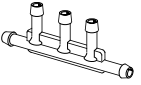
<b>Straight Connector</b>  pg. 140	<b>Universal Connector</b>  pg. 140	<b>Elbow Connector</b>  pg. 140	<b>Universal Tee</b>  pg. 140	<b>3 Way T</b>  pg. 140	<b>Y Connector</b>  pg. 140
<b>4 Way Tee</b>  pg. 140	<b>5 Way Tee</b>  pg. 140				

# Application Data

## Numbering Systems

Parts in this catalog are identified by a series of numbers separated by the letter "X."

48 X 6  
↑     ↑  
1     2

48 X 6 X 2  
↑     ↑     ↑  
1     2     3

1. The number preceding the "X" is the Catalog "Base Number" and indicates the type of connector. See Table 1 for additional base number data (sometimes referred to as dash size).
2. The second number is the tube and/or pipe size in sixteenths of an inch. When a pipe thread for a given tube size follows the SAE standard as shown in Table 2, no other number is required. Example: 48X6 = SAE 45° Flare Male Connector-3/8" tube, 1/4" Male Pipe.
3. If the pipe size is not to the SAE standard, another "X" is added followed by the pipe size indicated in sixteenths of an inch. Example: 1/8" is equal to 2/16" or X2 suffix.

In designating tube and pipe sizes for tees and crosses that are not SAE standard, indicate the sizes in the sequence shown.

**Table 1**

Type	Example Male Connector	Example Female Connector
45° Flare	48	46
Compression	68	66
Polyline	1268	1266
Selfalign	681	661
Air Brake (Nylon)	1468	1466
Air Brake (Copper)	1368	1366

**Table 2**

	Tube Size	Pipe Threads
X2	1/8"	1/8"
X3	3/16"	1/8"
X4	1/4"	1/8"
X5	5/16"	1/8"
X6	3/8"	1/4"
X7	7/16"	1/4"
X8	1/2"	3/8"
X10	5/8"	1/2"
X12	3/4"	1/2"
X14	7/8"	3/4"
X16	1"	1"
X20	1-1/4"	No Standard
X24	1-1/2"	No Standard
X32	2"	No Standard

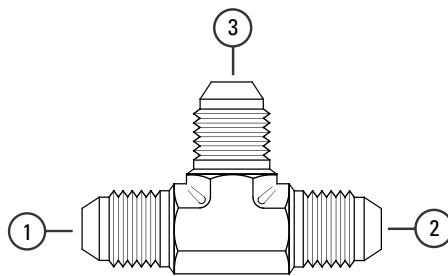

Tee

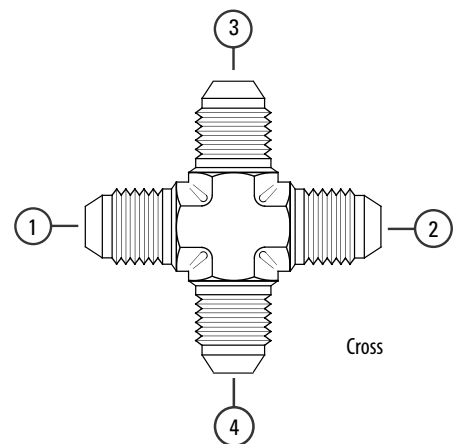

Cross

# Application Data

## Tube Connector Selector Chart

 Refer to safety information regarding proper selection of tubing and tube connectors on page 3.

Connector Types	Mini-Barb	Polyline	Threaded Sleeve	Pipe	Inverted Flare	SAE 45° Flare	Compression	Selfalign	1400 Series Air Brake	1300 Series Air Brake	Push> Connect	Q-CAB®	Molded Compression
Material	Brass	Brass	Brass	Brass	Brass	Brass	Brass	Brass	Brass	Brass	Brass	Brass Comp.	Nylon Poly
Tube Size	1/8	1/8	1/8	1/8	1/8	1/8	1/8	1/8	1/4	1/4	1/8	1/8	1/8
(O.D. range in inches)	1/2	1/2	3/8	3/4	1	3/4	1	1	3/4	3/4	1/2	2	2
Maximum Working Pressure Depends on tubing material, wall thickness and connector size.	135	500	500	1200	2000	2000	2000	2000	150	150	250	150	50/220

### Vibration (Comparative)

Fair													
Good													
Excellent													

### Tubing Types

Copper													
Steel													
Aluminum													
Stainless Steel-Annealed													
Stainless Steel-1/8-Hard													
Polyethylene							w/insert	w/insert					
Nylon									w/insert				
Polyvinyl Chloride (PVC)							w/insert	w/insert					
Bundy							B	B					

### Conforms

SAE													
NSF Listed													
FDA Listed													N
UL				F	F	F	F						
ASA													
ASME													
Military									H				
DOT												H	

### Typical Use

Instrumentation													
Oil-Air-Water													
Refrigeration													
Hydraulic Systems													
Cooling Systems													
Lubrication Systems													
Air Brake													

 Recommendation and Applicability

B — May be used if bundy is tin dipped

N — Nylon material

F — Available on special order

H — Available in most sizes

# Application Data

## Thread Identification

### American Connections NPTF (National Pipe Tapered Fuel)

This connection is still widely used in fluid power systems, even though it is not recommended by the National Fluid Power Association (NFPA) for use in hydraulic applications. The thread is tapered and the seal takes place by deformation of the threads.

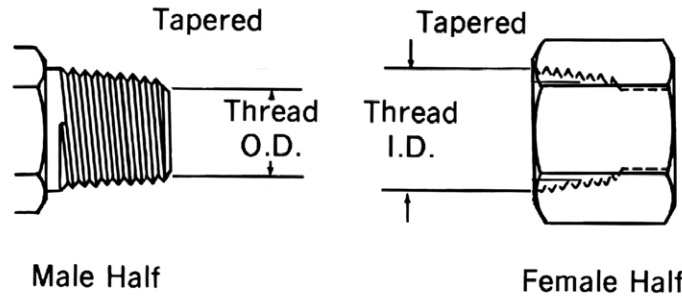

### NPTF Threads

Measure thread diameter and subtract 1/4-inch to find the nominal pipe size.

Inch Size	Dash Size	Nominal Thread Size	Male Thread O.D. Inch		Female Thread I.D. Inch	
			Fraction	Decimal	Fraction	Decimal
1/8	02	1/8-27	13/32	0.41	3/8	0.38
1/4	04	1/4-18	17/32	0.54	1/2	0.49
3/8	06	3/8-18	11/16	0.68	5/8	0.63
1/2	08	1/2-14	27/32	0.84	25/32	0.77
3/4	12	3/4-14	1-1/16	1.05	1	0.98
1	16	1-11-1/2	1-5/16	1.32	1-1/4	1.24
1-1/4	20	1-1/4-11-1/2	1-21/32	1.66	1-19/32	0.58
1-1/2	24	1-1/2-11-1/2	1-29/32	1.90	1-13/16	1.82
2	32	2-11-1/2	2-3/8	2.38	2-5/16	2.30

### NPSM (National Pipe Straight Mechanical)

This connection is sometimes used in fluid power systems. The female half has a straight thread and an inverted 30° seat. The male half of the connection has a straight thread and a 30° internal chamfer. The seal takes place by compression of the 30° seat on the chamfer. The threads hold the connection mechanically.

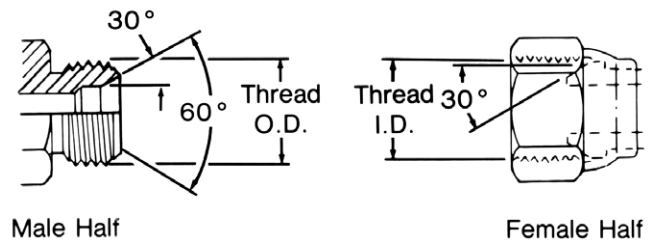

**Note:** A properly chamfered NPTF male will also seal with the NPSM female.

Inch Size	Dash Size	Nominal Thread Size	Male Thread O.D. Inch		Female Thread I.D. Inch	
			Fraction	Decimal	Fraction	Decimal
1/8	02	1/8-27	13/32	0.41	3/8	0.38
1/4	04	1/4-18	17/32	0.54	1/2	0.49
3/8	06	3/8-18	11/16	0.68	5/8	0.63
1/2	08	1/2-14	27/32	0.84	25/32	0.77
3/4	12	3/4-14	1-1/16	1.05	1	0.98
1	16	1-11-1/2	1-5/15	1.32	1-1/4	1.24
1-1/4	20	1-1/4-11-1/2	1-21/32	1.66	1-19/32	0.58
1-1/2	24	1-1/2-11-1/2	1-29/32	1.90	1-13/16	1.82
2	32	2-11-1/2	2-3/8	2.38	2-5/16	2.30

# Application Data

## Thread Identification

### American Connections SAE J514 37° Hydraulic

This connection is very common in fluid power systems. Both the male and female halves of the connections have 37° seats. The seal takes place by establishing a line contact between the male flare and the female cone seat.

The threads hold the connection mechanically.

**Caution:**

In the -02, -03, -04, -05, -08 and -10 sizes, the threads of the SAE 45° flare and the SAE 37° flare are the same. However, the sealing surface angles are not the same.

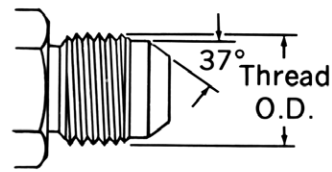

Male Half

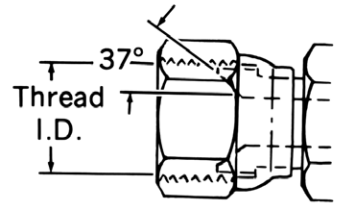

Female Half

Inch Size	Dash Size	Nominal Thread Size	Male Thread O.D. Inch		Female Thread I.D. Inch	
			Fraction	Decimal	Fraction	Decimal
1/8	02	5/16-24	5/16	0.31	9/32	0.27
3/16	03	3/8-24	3/8	0.38	11/32	0.34
1/4	04	7/16-20	7/16	0.44	13/32	0.39
5/16	05	1/2-20	1/2	0.50	15/32	0.45
3/8	06	9/16-18	9/16	0.56	17/32	0.51
1/2	08	3/4-16	3/4	0.75	11/16	0.69
5/8	10	7/8-14	7/8	0.88	13/16	0.81
3/4	12	1-1/16-12	1-1/16	1.06	1	0.98
7/8	14	1-3/16-12	1-3/16	1.19	1-1/8	1.13
1	16	1-5/16-12	1-5/16	1.31	1-1/4	1.23
1-1/4	20	1-5/8-12	1-5/8	1.63	1-9/16	1.54
1-1/2	24	1-7/8-12	1-7/8	1.88	1-13/16	1.79
2	32	2-1/2-12	2-1/2	2.50	2-7/16	2.42

# Application Data

## Thread Identification

### American Connections SAE J512 Inverted

This connection is frequently used in automotive systems. The male connector can either be a 45° flare in the tube fitting form or a 42° seat in the machined adapter form. The female has a straight thread with a 42° inverted flare. The seal takes place on the flared surfaces. The threads hold the connection mechanically.

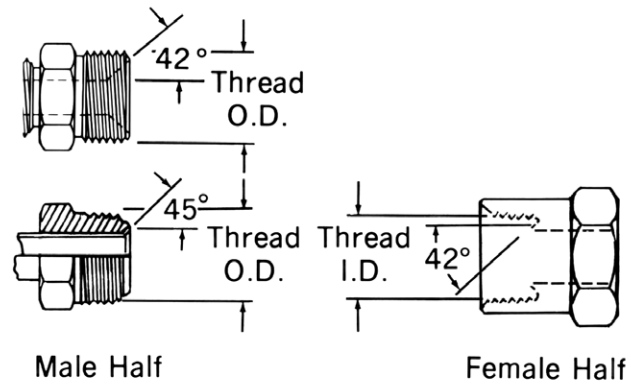

Inch Size	Dash Size	Nominal Thread Size	Male Thread O.D. Inch		Female Thread I.D. Inch	
			Fraction	Decimal	Fraction	Decimal
1/8	02	5/16-28	5/16	0.32	9/32	0.28
3/16	03	3/8-24	3/8	0.38	11/32	0.34
1/4	04	7/16-24	7/16	0.44	13/32	0.40
5/16	05	1/2-20	1/2	0.50	15/32	0.45
3/8	06	5/8-18	5/8	0.63	9/16	0.57
7/16	07	11/16-18	11/16	0.69	5/8	0.63
1/2	08	3/4-18	3/4	0.75	23/32	0.70
5/8	10	7/8-18	7/8	0.88	13/16	0.82
3/4	12	1-1/16-16	11/16	1.06	1	1.00

# Application Data

## Thread Identification

### American Connections SAE J512 45°

This connection is commonly used in refrigeration, automotive and truck piping systems. The connector is frequently made of brass. Both the male and female connectors have 45° seats. The seal takes place between the male flare the female cone seat. The threads hold the connection mechanically.

#### Caution:

In the -02, -03, -04, -05, -08 and -10 sizes, the threads of the SAE 45° flare and the SAE 37° flare are the same. However, the sealing surface angles are not the same.

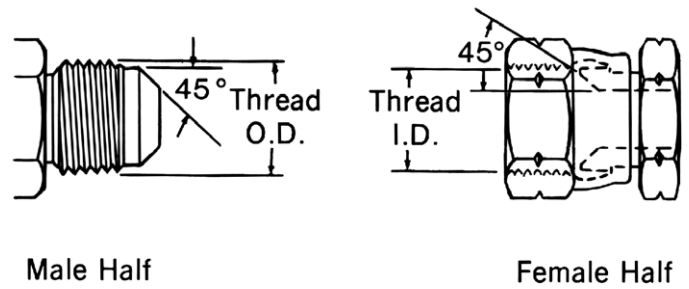

Male Half

Female Half

Inch Size	Dash Size	Nominal Thread Size	Male Thread O.D. Inch		Female Thread I.D. Inch	
			Fraction	Decimal	Fraction	Decimal
1/8	02	5/16-24	5/16	0.31	9/32	0.27
3/16	03	3/8-24	3/8	0.38	11/32	0.34
1/4	04	7/16-20	7/16	0.44	13/32	0.39
5/16	05	1/2-20	1/2	0.50	15/32	0.45
3/8	06	5/8-18	5/8	0.63	9/16	0.57
1/2	08	3/4-16	3/4	0.75	11/16	0.69
5/8	10	7/8-14	7/8	0.88	13/16	0.81
3/4	12	1-1/16-14	1-1/16	1.06	1	0.99
7/8	14	1-1/4-12	1-1/4	1.25	1-5/32	1.16
1	16	1-3/8-12	1-3/8	1.38	1-9/32	1.29

# Application Data

## Thread Identification

### British Connections British Standard Pipe (BSP)

This BSPT (tapered) connection is similar to the NPT, except that the thread pitches are different in most sizes, and the thread form and O.D.s are close but not the same. Sealing is accomplished by thread distortion. A thread sealant is recommended.

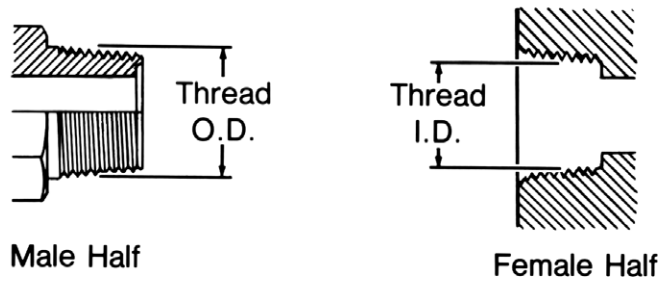

The BSP (parallel) male is similar to the NPSM male except the thread pitches are different in most sizes.

The female swivel BSPP has a tapered nose/Globeseal flareless swivel which seals on the cone seat of the male.

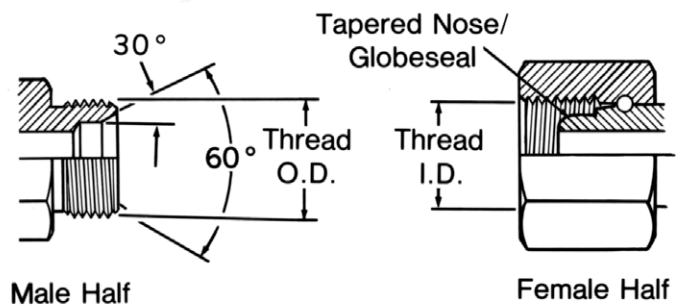

### BSPT/BSPP Threads

Inch Size	Dash Size	Nominal Thread Size*	Male Thread O.D. Inch		Female thread I.D. Inch	
			Fraction	Decimal	Fraction	Decimal
1/8	02	1/8-28	3/8	0.38	11/32	0.35
1/4	04	1/4-19	33/64	0.52	15/32	0.47
3/8	06	3/8-19	21/32	0.65	19/32	0.60
1/2	08	1/2-14	13/16	0.82	3/4	0.75
5/8	10	5/8-14	7/8	0.88	13/16	0.80
3/4	12	3/4-14	11/32	1.04	31/32	0.97
1	16	1-11	15/16	1.30	1-7/32	1.22
1-1/4	20	1-1/4-11	1-21/32	1.65	1-9/16	1.56
1-1/2	24	1-1/2-11	1-7/8	1.88	1-25/32	1.79
2	32	2-11	2-11/32	2.35	2-1/4	2.26

\*Frequently, the thread size is expressed as a fractional dimension preceded by the letter "G" or the letter "R". The "G" represents a parallel thread and the "R" indicates a tapered thread. For example, BSPP 3/8-19 may be expressed as G 3/8, and BSPT 3/8-19 may be expressed as R3/8.



**To select tubing for a particular installation, two factors must be determined...**

### Tubing Types

1. Tubing Type: material and construction
2. Size: Inside diameter (I.D.) and wall thickness. Information listed below will aid in your tubing selection. Commercial tubing is available in a wide variety of materials, types of construction and quality. Each is best suited for certain specific applications.

#### Aluminum Tubing

Seamless annealed is approved by SAE for low pressure applications.

#### Copper Tubing:

Seamless fully annealed coils and fully annealed or quarter-hard straight lengths can be used for systems that do not use petroleum based fluids (copper acts as an oil-oxidation catalyst, causing sludge). Copper also tends to work harden when flared or bent and has poor resistance to vibration. Therefore, the use of copper tubing is limited to low-pressure stationary applications and air circuits.

#### Special Alloy Tubing:

May be required for specific corrosion problems. Information on these applications can be obtained from your tubing supplier or from tubing manufacturers.

### Tubing Size

The two variables in tubing size are the inside diameter (ID) and the wall thickness. Each of these is dependent upon a number of factors.

#### Inside Diameter –

The tubing I.D. will determine the flow and velocity of the fluid in the system.

Flow is the volume of fluid that is to be moved through the line to perform a given job within a specified time. Flow rate is expressed in gallons per minute (gpm).

Velocity is the rate of speed at which the fluid passes through the line. It is expressed in feet per second (fps). With a given flow rate, the velocity will increase as the inside diameter of the tubing decreases.

#### Note:

To determine the appropriate tubing I.D. for specific flow rate and velocity, refer to the Velocity vs. Flow chart on page 21.

#### Wall Thickness

The required wall thickness of the tubing depends upon operating pressure, safety factor, temperatures, and tubing material.

Operating Pressure is the pressure of the fluid in the system. It is expressed in pounds per square inch (psi).

Safety Factor is a multiplier applied to the wall thickness that compensates for additional mechanical strains and hydraulic shocks to which the tubing may be subjected during operation.

#### Note:

To determine the appropriate wall thickness, refer to the data on page 22.

#### Pressure Drop

Total pressure supplied to a line must equal usable pressure (or output) plus the pressure that is lost through fluid transmission, which is referred to as pressure drop. These pressure drops cause loss of energy and should be kept to a minimum. Elements which cause pressure drop in the transmission of fluids include sudden enlargements or contractions, bends, fittings and valves. Mathematical analysis of pressure drop, although possible, is not precise because of the interrelationship of factors such as fluid velocity, density, flow area and friction coefficients. Therefore, to obtain optimum efficiency, the system (or the questionable portions of the system) should be mocked-up to obtain empirical pressure drop data.

# Application Data

## Tubing Selection



Refer to safety information regarding proper selection of tubing and tube connectors on page 3.

### Problem

Following is a typical problem that illustrates, step by step, the procedure for determining tube size.

Flow - 5 gpm  
 Velocity - not to exceed 10 fps  
 Pressure - 2000 psi  
 Safety Factor - 4:1

**Select Bundyweld tubing with the appropriate I.D. and wall thickness for the following conditions:**

### Solution

- Using the Flow/Velocity chart on Page 21, follow the horizontal flow line (5 gpm) until it intersects the vertical velocity line (10fps). From this point, follow the diagonal line upward to get the required tube I.D. (.444). If the horizontal flow line and the vertical velocity line intersect between two diagonal lines, normally the larger inside diameter would be selected since it would mean less velocity.
- Refer to the chart of Standard Size Hydraulic Tubing, below. Note that .444 I.D. tubing is not listed. If you want to use standard tubing, select one with a larger I.D. Do not select a smaller size since this would increase the velocity to over the 10 fps limit.

- Therefore, by going to the next largest size, you would select the 5/8" O.D. tubing having an I.D. of .459 and a wall thickness of .083.
- To determine whether this tubing will meet the pressure and safety factor requirements, refer to the Recommended Wall Thickness data on page 18. For 5/8" O.D. tubing at 2000 psi, the chart for Bundyweld indicates that the minimum wall thickness with a safety factor of 4:1 is .05952. Since you have selected a tubing with a .083 wall, this would easily fulfill the requirements. However, for savings on weight and cost, you can select another tubing with a thinner wall that will still meet the performance

requirements. Therefore, refer again to the chart on standard size tubing and select a tubing with a wall thickness closer to the minimum requirements. This would be the 5/8" O.D. tubing with a .509 I.D. and a .058 wall. This tubing will handle the pressure requirements of 2000 psi with a safety factor of 4:1, and also provides the required flow while keeping the velocity within the 10 fps limitation.

### Standard Size Hydraulic Tubing

Tube O.D.	Tube I.D.	Tube Wall	Tube O.D.	Tube I.D.	Tube Wall	Tube O.D.	Tube I.D.	Tube Wall	Tube O.D.	Tube I.D.	Tube Wall
1/8"	.055	.035	3/8"	.245	.065	5/8"	.435	.095	7/8"	.657	.109
	.061	.032		.259	.058		.459	.083		.685	.095
	.065	.030		.277	.049		.481	.072		.709	.083
	.069	.028		.291	.042		.495	.065		.731	.072
3/16"	.117	.035	1/2"	.305	.035	3/4"	.509	.058	1"	.745	.065
	.123	.032		.311	.032		.527	.049		.759	.058
	.127	.030		.310	.095		.541	.042		.777	.049
1/4"	.120	.065	3/4"	.334	.083	3/4"	.555	.035	1"	.760	.120
	.134	.058		.358	.072		.532	.109		.782	.109
	.152	.049		.370	.065		.560	.095		.810	.095
	.166	.042		.384	.058		.584	.083		.834	.083
	.180	.035		.402	.049		.606	.072		.856	.072
	.190	.030		.416	.042		.620	.065		.870	.065
5/16"	.182	.065	3/4"	.430	.035	3/4"	.634	.058	1"	.884	.058
	.196	.058		.436	.032		.652	.049		.902	.049
	.214	.049					.680	.035			
	.228	.042									
	.242	.035									
.248	.032										

# Application Data

## Tubing Selection

### Flow/Velocity Chart

#### To Find Required Tube I.D.

Flow—20 gpm  
Velocity—9 fps

Follow horizontal flow line (20 gpm) until it intersects vertical velocity line (9 fps). From this point follow diagonal line to get required Tube I.D.—(.944).

#### To Find Permissible Flow

Velocity—15 fps  
Tube I.D.—.495

Follow vertical velocity line (15 fps) until it intersects diagonal line representing .495 tube I.D. Then project this point horizontally to get the permissible flow—(9 gpm).

#### To Find Velocity of Fluid in System

Flow—6 gpm  
Tube I.D.—.694

Follow horizontal flow line (6 gpm) until it intersects diagonal line representing .694 tube I.D. Then project this point vertically downward to get the velocity of fluid —(5 fps).

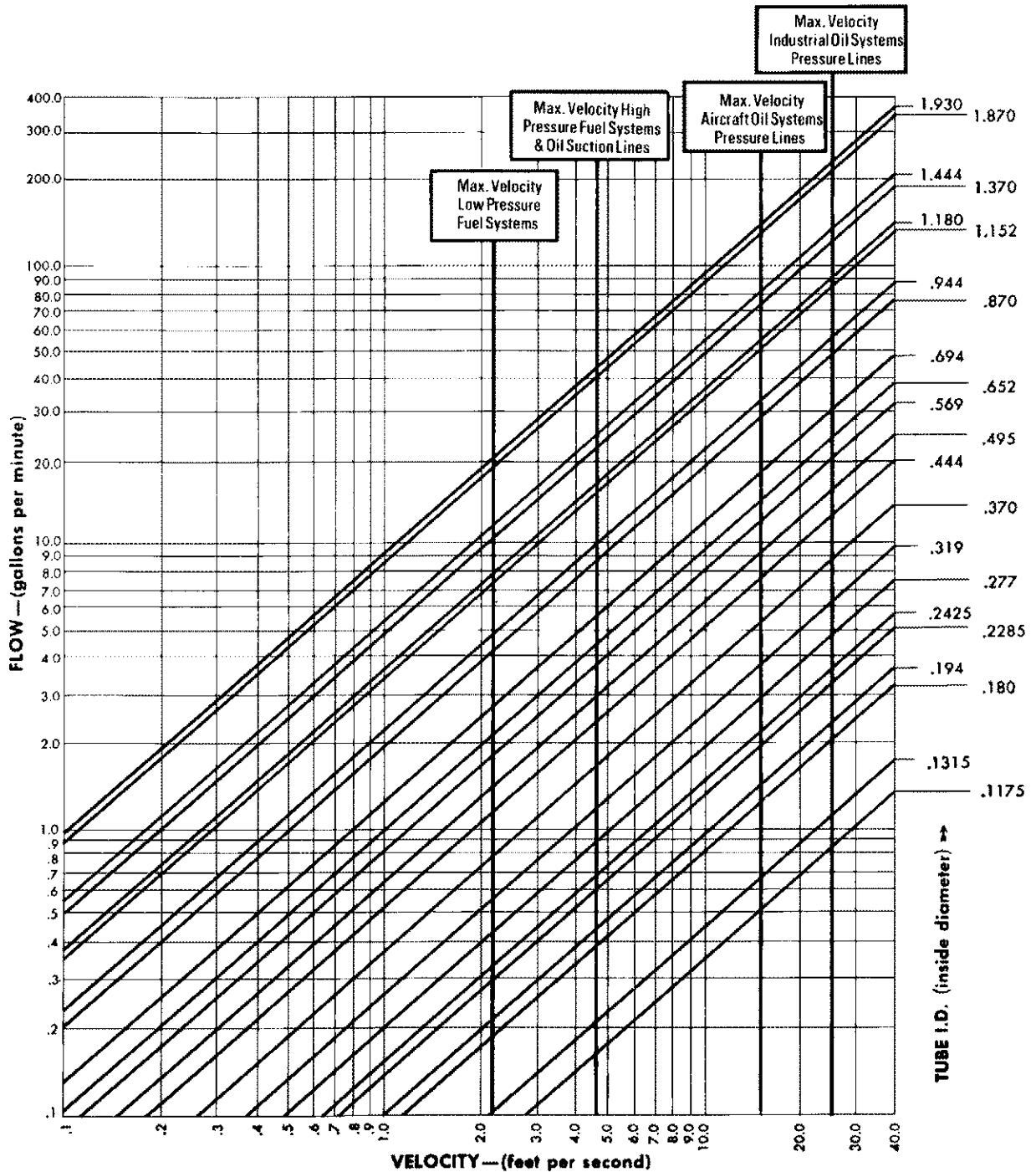

# Application Data

## Tubing Selection



Refer to safety information regarding proper selection of tubing and tube connectors on page 3.

With the following recommended wall thickness tables the tubing wall can be selected that is best suited for a particular application. The data given in these tables are raw figures based on the equation:

$$t = \frac{Dp(FS)}{2S}$$

- t** – wall thickness (inches)
- D** – O.D. of tube (inches)
- p** – pressure (psi)
- FS** – Safety Factor
- S** – tensile strength of tubing material

Therefore, many of the wall thicknesses given in these tables are not found on standard tubing, but serve to establish the minimum wall required.

### Safety Factor

The standard safety factors indicate three grades of severity of service:

- 4:1** – mechanical and hydraulic shocks not excessive
- 6:1** – considerable mechanical strain and hydraulic shock
- 8:1** – hazardous applications with severe service conditions

The wall thickness shown in these tables are based on ultimate strength of material and a safety factor of 4:1.

To obtain the recommended wall for a specific pressure based on a safety factor of 6:1, multiply the wall thickness indicated in the table by 1.5. For a safety factor of 8:1, multiply by 2

### Temperature

The wall thickness found by using these tables can be corrected for temperature by multiplying the wall thickness by the appropriate correction factor given in the chart below. The table is based on strength reduction due to increased temperature.

Recommended Wall Thickness		
Temperature	Copper	Aluminum
+100F.	1.00	1.00
+200F.	1.08	1.00
+300F.	1.22	1.08
+400F.	2.30	1.41
+500F.	-	2.10
+600F.	-	-
+700F.	-	-
+800F.	-	-
+900F.	-	-
+1000F.	-	-

Bundyweld					
Based on 42,000#/IN. <sup>2</sup> Strength (F S=4)					
O.D.	Tube	Working Pressure (psi)			
		1,000	2,000	3,000	4,000
1/8	.00595	.01190	.01786	.02381	.02976
3/16	.00893	.01786	.02679	.03571	.04464
1/4	.01190	.02381	.03571	.04762	.05952
5/16	.01488	.02976	.04464	.05952	.07440
3/8	.01786	.03571	.05357	.07143	.08929
1/2	.02381	.04762	.07143	.09524	.11905
5/8	.02976	.05952	.08929	.11905	.14881

Tube O.D.	Aluminum 3003 (H-14) Based on 20,000#/IN.2, Strength (F.S. -4)					Aluminum 5052 (H-32) Based on 31,000#/IN.2, Strength (F.S. -4)				
	1,000	2,000	3,000	4,000	5,000	1,000	2,000	3,000	4,000	5,000
1/8	.01250	.02500	.3750	.05000		.00806	.01613	.02419	.03226	.04032
3/16	.01875	.03750	.05650	.07500		.01210	.02419	.03629	.04839	.06048
1/4	.02500	.05000	.07500	.10000		.01613	.03226	.04839	.06452	.08065
5/16	.03125	.06250	.09375	.12500		.02016	.04032	.06048	.08065	.10081
3/8	.03750	.07500	.11250	.15000		.02419	.04839	.07258	.09677	.12097
1/2	.05000	.10000	.15000	.20000		.03227	.06452	.09677	.12903	.16129
5/8	.06250	.12500	.18750	.25000		.04032	.08065	.12097	.16129	.20161
3/4	.07500	.15000	.22500	.30000		.04839	.09677	.14516	.19355	.24194
7/8	.08750	.17500	.26250	.35000		.05645	.11290	.16935	.22581	.28226
1	.10000	.20000	.30000	.40000		.06452	.12903	.19355	.25806	.32258
1-1/4	.12500	.25000	.37500	.50000		.08065	.16129	.24194	.32258	.40323
1-1/2	.15000	.30000	.45000	.60000		.09677	.19355	.29032	.38710	.48387
2	.20000	.40000	.60000	.80000		.12903	.25806	.38710	.51613	.64516

Tube O.D.	Annealed Copper Based on 30,000#/IN.2, Strength (F.S. -4)					Copper (UNS C12200 Light Drawn) Based on 40,000#/IN.2, Strength (F.S. -4)				
	1,000	2,000	3,000	4,000	5,000	1,000	2,000	3,000	4,000	5,000
1/8	.00833	.01667	.02500	.03333	.04167	.00625	.01250	.01875	.02500	.03125
3/16	.01250	.02499	.03750	.04999	.06250	.00938	.01875	.02812	.03750	.04688
1/4	.01667	.03333	.05000	.06666	.08333	.01250	.02500	.03750	.05000	.06250
5/16	.02083	.04167	.06250	.08333	.10417	.01562	.03125	.04688	.06250	.07812
3/8	.02499	.04999	.07500	.09999	.12499	.01875	.03750	.05625	.07500	.09375
1/2	.03333	.06667	.10000	.13333	.16667	.02500	.05000	.07500	.10000	.12500
5/8	.04167	.08333	.12500	.16666	.20883	.03125	.06250	.09375	.12500	.15625
3/4	.04999	.09999	.15000	.19999	.24999	.03750	.07500	.11250	.15000	.18750
7/8	.05833	.11667	.17500	.23333	.29166	.04375	.08750	.13125	.17500	.21875
1	.06667	.13333	.20000	.26666	.33333	.05000	.10000	.15000	.20000	.25000
1-1/4	.08333	.16667	.25000	.33333	.41667	.06250	.12500	.18750	.25000	.31250
1-1/2	.09999	.19999	.30000	.39999	.49999	.07500	.15000	.22500	.30000	.37500
2	.13333	.26667	.40000	.53333	.66667	.10000	.20000	.30000	.40000	.50000

**Shaded Areas**  
Tubing wall thickness listed in the shaded areas are generally either too light or too heavy for practical applications, and are listed only to provide data for accurate computation.

# Application Data

## Flare Dimensions

### JIC 37° Flare Tubes (SAE J533)

Tube Size O.D.	Single Flare A Diameter		Double Flare B Diameter		R Radius ±.020	Maximum Wall Thickness	
	Max.	Min.	Max.	Min.		Single Flare D	Double Flare D
1/8	0.200	0.180	0.200	0.180	0.030	0.035	0.025
3/16	0.280	0.260	0.280	0.260	0.030	0.035	0.028
1/4	0.360	0.340	0.360	0.340	0.030	0.065	0.035
5/16	0.430	0.400	0.430	0.400	0.030	0.065	0.035
3/8	0.490	0.460	0.490	0.460	0.040	0.065	0.049
1/2	0.660	0.630	0.660	0.630	0.060	0.083	0.049
5/8	0.790	0.760	0.790	0.760	0.060	0.083	0.049
3/4	0.950	0.920	0.960	0.920	0.080	0.109	0.049
7/8	1.070	1.040	1.070	1.040	0.080	0.109	0.065
1	1.200	1.170	1.200	1.170	0.090	0.120	0.065
1 1/4	1.510	1.480	1.510	1.480	0.090	0.120	0.065
1 1/2	1.730	1.700	1.730	1.700	0.110	0.120	0.065
2	2.360	2.330	2.360	2.330	0.110	0.134	0.065

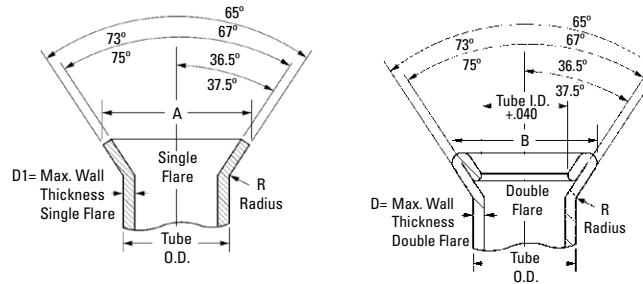

### SAE 45° Flare Tubes (SAE J533)

Tube Size	Single Flare A Diameter		Single Flare B Diameter		Double Coined Flare Seat Length C	Maximum Wall Thickness	
	Max.	Min.	Max.	Min.		Single Flare D	Double Flare D <sub>1</sub>
1/8	0.171/	0.181	0.198/	0.213	0.040	0.035	0.025
3/16	0.239/	0.249	0.265/	0.280	0.040	0.035	0.028
1/4	0.315/	0.325	0.345/	0.360	0.040	0.049	0.035
5/16	0.388/	0.404	0.410/	0.425	0.062	0.049	0.035
3/8	0.471/	0.487	0.485/	0.500	0.062	0.065	0.049
7/16	0.545/	0.561	0.555/	0.570	0.062	0.065	0.049
1/2	0.607/	0.623	0.625/	0.640	0.062	0.083	0.049
9/16	0.660/	0.676	0.697/	0.712	0.062	0.083	0.049
5/8	0.732/	0.748	0.757/	0.772	0.062	0.095	0.049
3/4	0.900/	0.916	0.897/	0.912	0.062	0.109	0.049
7/8	1.025/	1.041	--	--	--	0.109	--
1	1.141/	1.157	--	--	--	0.120	--

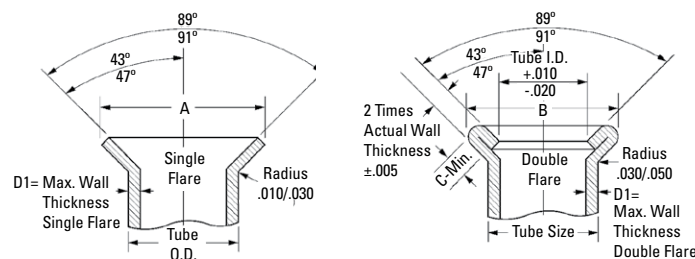

# Application Data

## Tube Installation

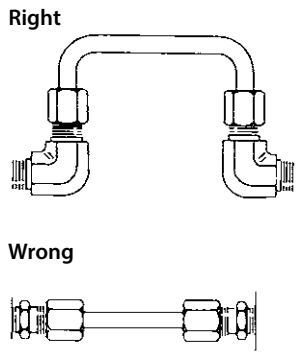

Figure 1

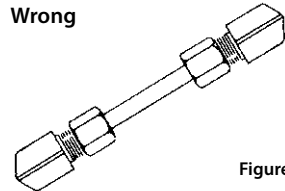
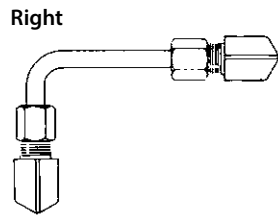

Figure 2

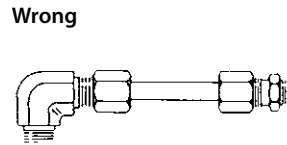
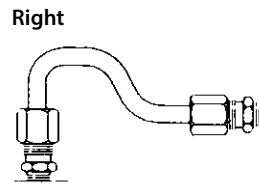

Figure 3

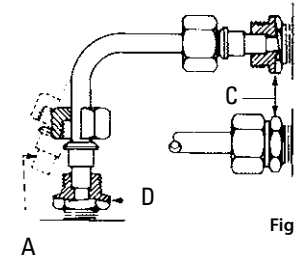

Figure 4

**Note:**  
Springing the tubing to force alignment places strain on fitting joints.

Nearly all industrial equipment now in service makes some use of fluid lines. From an economic point of view, the best fluid lines system is that which is easiest to maintain at the lowest original cost. The use of tubing and tube connectors on lines up to 2" diameter is usually more economical than the use of pipe and pipe connectors in modern installations. A few of the more important reasons follow:

1. Size for size, tubing is lighter weight, easier to handle and can be bent more easily than iron pipe.
2. Ductile hydraulic tubing reduces the number of connections required, thus reducing material and labor costs. Bent tubing also reduces pressure drop and turbulence in the system.
3. Fewer joints means lower costs and fewer points of potential leakage.
4. The use of tube connectors makes every joint a union, permitting easier, faster maintenance and repair work.
5. Modern flared and flareless tube fittings eliminate the need for threading, soldering, or welding.

### Tube Bending

Tubing should be bent wherever possible to reduce the number of connectors.

Copper tubing can be bent easily with a hand bender. Steel tubing can be bent in sizes 1/8" to 5/8" O.D. by using a hand bender designed for steel tubing. For production quantities, or for sizes larger than 5/8" O.D., a power bender is generally used.

Tubing should be bent accurately. Tubing manufacturers will advise the correct radii for various types and wall thicknesses of tubing. Kinks, flattened bends, wrinkles and tube breakage or loss should be avoided by the use of proper tube bending equipment.

### Precautions

Avoid straight line connections wherever possible, especially in short runs.

Design piping systems symmetrically. They are easier to install and present a neat appearance.

Care should be taken to eliminate stress from tubing lines. Long tubing runs should be supported by brackets or clips. All parts installed on tubing lines such as heavy fittings, valves, etc., should be bolted down to eliminate tubing fatigue.

Before installing tubing, inspect the tube to see that it conforms to the required specifications, is of the correct diameter and wall thickness and is not out of round.

Cut tube ends reasonably square and lightly deburr inside and outside edge. Chamfer on outside edge will destroy bearing of tube end on the connector seat.

To avoid difficulty in assembly and disconnecting, a sufficient straight length of tube must be allowed from the end of the tube to the start of the bend. Allow twice the length of the nut as a minimum.

**Tubes should be formed to assemble with true alignment to the center line of the fittings, without distortion or tension.**

Tubing which has to be sprung from position, "A", (see Fig. 4), to be inserted into the connector has not been properly fabricated, and when so installed and connected, places the tubing under stress.

When assembling the tubing, insert the longer leg to the connector as at "C" (Fig. 4). With the nut free, the short leg of the tubing can be easily moved and brought to proper position with and inserted into the seat in connector "D". The nuts can then be tightened as required.

# Application Data

## Chemical Compatibility Chart



Refer to safety information regarding proper selection of tubing and tube connectors on page 3.

These tables alphabetically list commonly used materials of various chemical composition. After each agent listing you will find the basic tubing and connector materials rated according to their chemical resistance to each individual agent. The chart is intended to be used as a guide only. Many factors (concentration, temperature, intermittent or continuous exposure, etc.) have a bearing upon the suitability of any tubing or connector for any

specific application, and these factors must be considered by you as you review the chemical compatibility chart.

Where unusual conditions exist or where questions arise, consult Danfoss for expert assistance on your tubing application requirements.

**Note:** All data given herein is believed to be accurate and reliable but presented without guarantee, warranty, or responsibility of any kind, express or implied, on our part. Chemical resistance will vary with the wide diversity of possible mixtures and service conditions. It is not therefore possible to give any guarantee whatsoever in individual cases. Danfoss Eclipse® and Solstice™ tubing should only be used in air brake applications.

Fluid	Nylon 11 MTP160	Nylon 6/6 PT230	PVC PT200	Polyethylene PT240 (LDPE)	Brass
Acetaldehyde	G	F	X	X	G
Acetic Acid (Concentrated)	X	X	X	X	X
Acetic Acid (Dilute)	F	X	F	G	X
Acetic Anhydride	X	X	X	X	X
Acetone	G	F	X	G	G
Acrylonitrile	G	—	G	—	—
Air	G	G	G	G	G
Alcohols					
Amyl Alcohol	G	G	X	G	G
Butyl Alcohol, Butanol	G	G	X	G	G
Ethyl Alcohol, Ethanol	G	G	F	G	G
Isopropyl Alcohol, Isopropanol	G	G	G	G	G
Methyl Alcohol, Methanol	G	G	X	G	G
Aluminum Chloride	X	X	G	G	X
Aluminum Fluoride	X	X	G	G	X
Aluminum Hydroxide	G	G	G	G	X
Aluminum Nitrate	G	F	G	G	X
Aluminum Sulfate	G	F	G	G	X
Alums	F	G	G	G	X
Ammonia, Anhydrous	Use approved anhydrous ammonia hose				X
Ammonia Solution (10%)	G	X	G	G	X
Ammonium Chloride	X	X	G	G	X
Ammonium Hydroxide	G	X	X	G	X
Ammonium Nitrate	G	G	G	G	X
Ammonium Phosphate	G	G	F	G	X
Ammonium Sulfate	G	G	G	G	X
Amyl Acetate	G	G	X	X	G
Amyl Alcohol	G	G	X	G	G
Aniline	X	X	X	X	X
Aniline Dyes	X	X	X	X	X
Animal Oils and Fats	G	—	G	X	G
Anti-Freeze (Glycol Base)	G	—	G	F	G
Aqua Regia	X	X	X	X	—
Aromatic Hydrocarbons	G	G	X	G	G
Asphalt Emulsion	G	—	X	—	G
Barium Chloride	G	—	G	G	G
Barium Hydroxide	G	G	G	G	X
Barium Sulfate	G	G	G	G	G
Barium Sulfide	X	—	G	G	X
Beet Sugar Liquors	G	G	G	G	X
Benzaldehyde	G	G	X	X	F

### Codes:

- G = Good Resistance
- F = Fair Resistance
- X = Incompatible
- = No data available
- + = Call Technical Support for specific application

# Application Data

## Chemical Compatibility Chart



Refer to safety information regarding proper selection of tubing and tube connectors on page 3.

Fluid	Nylon 11 MTP 160	Nylon 6/6 PT230	PVC PT200	Polyethylene PT240 (LDPE)	Brass
Benzene, Benzol	G	G	X	X	G
Benzoic Acid	X	X	X	G	G
Black Sulfate Liquor	X	X	X	G	X
Bleach Solution	X	X	F	G	X
Borax Solution	G	—	G	G	G
Boric Acid	G	G	G	G	G
Brake Fluid (Glycol Ether Base)	G	—	X	X	G
Brine	G	—	G	G	G
Bromine	X	X	X	X	X
Butane	Use Butane approved hose				
Butyl Acetate	G	—	X	X	G
Butyl Alcohol, Butanol	G	G	X	G	G
Calcium Bisulfite	G	X	G	G	X
Calcium Chloride	G	X	G	G	X
Calcium Hydroxide	G	G	G	G	G
Calcium Hypochlorite	X	X	G	G	G
Cane Sugar Liquors	G	—	G	G	G
Carbon Dioxide (Dry)	G	G	G	G	G
Carbon Dioxide (Wet)	G	G	G	G	F
Carbon Disulfide (Bisulfide)	X	X	X	X	G
Carbon Monoxide (Hot)	X	X	X	X	G
Carbon Tetrachloride	G	G	X	X	G
Carbonic Acid	G	—	G	G	X
Castor Oil	G	—	G	X	G
Cellosolve Acetate	G	—	X	—	X
Chlorinated Solvents	F	G	X	X	G
Chloroacetic Acid	X	X	X	X	X
Chlorobenzene	X	X	X	X	F
Chlorine Gas (Dry)	X	X	X	X	G
Chlorine Gas (Wet)	X	X	X	X	X
Chloroform	F	G	X	X	G
Chlorosulfonic Acid	X	X	X	X	X
Chromic Acid (under 25%)	X	X	F	F	X
Chromic Acid (over 25%)	X	X	X	X	X
Citric Acid	X	F	G	G	X
Coke Oven Gas	G	—	X	G	F
Copper Chloride	X	X	G	G	X
Copper Cyanide	G	G	G	G	X
Copper Sulfate	G	G	G	G	X
Corn Syrup (Non-food)	G	—	G	G	—
Cottonseed Oil	G	—	F	G	G
Creosote	X	X	X	X	F
Cresol	X	X	X	X	—
Cyclohexanol	G	G	X	F	G
Dextrose (Food Grade)	X	X	X	G	—
Dichlorobenzene	G	—	X	X	—
Diesel Fuel	G	—	X	X	G
Diethanolamine	G	—	X	—	X
Diethylenetriamine	X	X	X	G	—
Dowtherm A	X	X	X	X	X
Enamel (Solvent Base)	G	—	X	G	G
Ethanolamine	G	—	X	G	X
Ethers (Ethyl Ether)	G	—	X	X	G
Ethyl Alcohol	G	G	F	G	G
Ethyl Acetate	G	G	X	G	G
Ethyl Acrylate	X	—	X	—	—
Ethyl Methacrylate	X	—	X	—	—
Ethylamine	X	X	X	G	G

### Codes:

- G = Good Resistance
- F = Fair Resistance
- X = Incompatible
- = No data available
- + = Call Technical Support for specific application



# Application Data

## Chemical Compatibility Chart

 Refer to safety information regarding proper selection of tubing and tube connectors on page 3.

Fluid	Nylon 11 MTP 160	Nylon 6/6 PT230	PVC PT200	Polyethylene PT240 (LDPE)	Brass
Ethyl Cellulose	F	—	X	G	G
Ethyl Chloride	G	—	X	X	G
Ethylenediamine	X	X	X	G	G
Ethylene Dibromide	F	—	X	—	—
Ethylene Dichloride	F	—	X	X	F
Ethylene Glycol	G	G	G	G	G
Ethylene Oxide	G	—	X	X	X
Fatty Acids	G	G	G	G	F
Ferric Chloride 5%	G	G	G	G	X
Ferric Sulfate	G	G	G	G	X
Fertilizer Salts Solution	F	—	G	G	—
Formaldehyde	G	G	X	G	G
Formic Acid	X	X	X	G	F
Freon 12	Use approved Freon 12 hose				G
Freon 134a	Use approved Freon 134a hose				—
Fuel Oil	G	—	F	X	G
Furfural	X	X	X	X	G
Gasoline (Refined)	G	G	X	X	G
Gasoline (Unleaded)	G	G	X	X	G
Gasoline (10% Ethanol)	G	G	X	X	G
Gasoline (10% Methanol)	G	G	X	X	G
Glucose (non-food)	G	G	G	G	G
Glycerine, Glycerol (Non-food)	G	G	G	G	G
Greases	G	G	G	G	G
Green Sulfate Liquor	X	X	G	G	X
Heptane	G	G	X	X	G
Hexane	G	G	X	X	G
Houghto Safe 273 to 640	G	—	F	G	G
Houghto Safe 5046, 5047F	G	—	G	G	G
Houghto Safe 1000 Series	G	—	X	X	G
Hydraulic Oils					
Straight Petroleum Base	G	G	G	G	G
Water Petroleum Emulsion	G	—	—	F	G
Water Glycol	G	G	X	—	G
Straight Phosphate Ester	G	G	X	X	G
Phos. Ester/Petroleum Blend	G	G	X	X	G
Polyol Ester	G	—	—	—	G
Hydrobromic Acid (under 48%)	X	X	G	G	X
Hydrochloric Acid	X	X	G	G	X
Hydrocyanic Acid	X	X	G	G	G
Hydrofluoric Acid (under 50%)	X	X	F	F	X
Hydrofluoric Acid (over 50%)	X	X	X	X	X
Hydrofluosilicic Acid	X	X	G	G	X
Hydrogen	Use approved hydrogen hose or metal tubing				G
Hydrogen Peroxide	X	X	—	G	X
Hydrogen Sulfide	X	X	G	G	G
Hydrolube	G	—	G	G	G
Iodine	X	X	X	X	X
Isocyanates	X	X	X	X	—
Isopropyl Alcohol, Isopropanol	G	G	G	G	G
Isopropylamine	X	—	X	—	G
Iso-Octane	G	G	X	X	G
Jet Fuel (Transfer Only)	G	G	X	X	G
Kerosene	G	G	X	X	G
Lacquer	G	G	X	F	G
Lacquer Solvents	G	G	X	F	G
Lactic Acid	G	G	G	G	F
Lime Sulfur	G	F	G	G	X

### Codes:

G = Good Resistance  
 F = Fair Resistance  
 X = Incompatible  
 — = No data available  
 + = Call Technical Support  
 for specific application

# Application Data

## Chemical Compatibility Chart

 Refer to safety information regarding proper selection of tubing and tube connectors on page 3.

FLUID	Nylon 11 MTP 160	NYLON 6/6 PT230	PVC PT200	POLYETHYLENE PT240 (LDPE)	BRASS
Lindol	G	G	—	—	F
Linseed Oil	G	G	G	G	G
Lubricating Oils	G	G	G	G	G
Lye	G	F	G	G	F
Magnesium Chloride	G	G	G	G	F
Magnesium Hydroxide	G	G	G	G	G
Magnesium Sulfate	G	G	G	G	G
Mercuric Chloride	X	X	F	G	X
Mercury	G	G	F	G	X
Methyl Alcohol, Methanol	G	G	X	G	G
Methyl Acrylate	X	X	X	—	G
Methyl Bromide	G	F	X	X	G
Methyl Chloride	G	G	X	X	G
Methylene Chloride	F	F	X	X	G
Methyl t-Butyl Ether (MTBE)	G	G	X	—	—
Methyl Ethyl Ketone	G	G	X	G	G
Methyl Isobutyl Ketone	G	G	X	G	G
Methyl Isopropyl Ketone	G	G	X	G	G
Methyl Methacrylate	X	—	X	—	—
Mineral Oil	G	G	F	X	G
Mineral Spirits	G	G	X	G	G
Naphtha	G	G	X	G	—
Napthalene	G	G	X	X	G
Nickel Acetate	G	G	G	G	F
Nickel Chloride	G	G	G	G	X
Nickel Sulfate	G	G	G	G	G
Nitric Acid (under 35%)	X	X	G	F	X
Nitric Acid (35% to 60%)	X	X	F	X	X
Nitric Acid (over 60%)	X	X	X	X	X
Nitrobenzene	X	—	X	X	G
Nitrogen Gas	G	G	G	G	G
Nitrous Oxide	F	F	X	X	G
Oleic Acid	G	G	F	G	G
Oleum (Fuming Sulfuric Acid)	X	X	X	X	X
Oxalic Acid	X	X	G	G	F
Oxygen (non-breathing,non-welding) +	G	G	G	G	G
Ozone (300 pphm)	X	X	X	X	—
Paint (Solvent Base)	G	G	X	F	G
Palmitic Acid	G	G	F	G	X
Paper Mill Liquors	X	X	X	X	—
Pentane	G	—	X	X	G
Perchloroethylene	F	G	X	X	G
Petroleum Ether	G	G	X	X	G
Petroleum Oils	G	G	G	G	G
Phenol	X	X	X	X	G
Phosphoric Acid (to 85%)	X	X	G	G	G
Picric Acid (Molten)	X	X	X	X	X
Picric Acid (Solution)	X	X	X	X	X
Potassium Chloride	G	G	G	G	F
Potassium Cyanide	G	G	G	G	X
Potassium Dichromate	F	—	G	G	F
Potassium Hydroxide	G	F	G	G	F
Potassium Permanganate	X	X	G	G	—
Potassium Sulfate	G	G	G	G	F
Propane Liquid	Use hose approved for Propane Liquid				G
Propylene Glycol	G	—	F	G	F
Pyridine	X	X	X	G	F
Sea Water	G	G	G	G	G

### Codes:

G = Good Resistance  
 F = Fair Resistance  
 X = Incompatible  
 — = No data available  
 + = Call Technical Support  
 for specific application

# Application Data

## Chemical Compatibility Chart



Refer to safety information regarding proper selection of tubing and tube connectors on page 3.

Fluid	Nylon 11 MTP 160	Nylon 6/6 PT230	PVC PT200	Polyethylene PT240 (LDPE)	Brass
Silver Nitrate	G	G	G	G	X
Skydrol	G	G	X	X	G
Soap Solution					
Sodium Bicarbonate	G	G	G	X	G
Sodium Bisulfate	G	G	G	G	G
Sodium Bisulfite	G	G	G	G	F
Sodium Borate	G	G	G	G	G
Sodium Carbonate	G	G	G	G	G
Sodium Chloride	G	G	G	G	X
Sodium Cyanide	G	G	G	G	X
Sodium Hydroxide	G	F	G	G	F
Sodium Hypochlorite	X	X	G	G	X
Sodium Nitrate	G	G	G	G	F
Sodium Perborate	G	F	G	G	X
Sodium Peroxide	X	X	X	X	X
Sodium Phosphates	G	G	G	G	G
Sodium Silicate	G	G	G	G	G
Sodium Sulfate	G	G	G	G	G
Sodium Sulfide	G	G	G	G	X
Sodium Thiosulfate	G	G	G	G	X
Soybean Oil	G	—	F	G	G
Stannic Chloride	F	X	G	G	X
Steam 450° F	X	X	X	X	F
Stearic Acid	G	G	F	G	X
Stoddard Solvent	G	G	X	X	G
Styrene	G	G	X	X	G
Sulfur 70° F	G	G	F	G	X
Sulfur 200° F	X	X	X	X	X
Sulfur Chloride	X	X	X	G	X
Sulfur Dioxide	X	X	X	X	G
Sulfuric Acid (under 50%)	X	X	G	G	X
Sulfuric Acid (51% to 70%)	X	X	G	X	X
Sulfuric Acid (71% to 95%)	X	X	X	X	X
Sulfuric Acid (96% to 98%)	X	X	X	X	X
Tannic Acid	X	X	G	G	G
Tar	G	G	X	X	G
Tartaric Acid	G	G	G	G	F
Tetrachloroethane	F	—	X	F	—
Tetrahydrofuran (THF)	G	—	X	X	—
Toluene	G	G	X	G	G
Transmission Oil (Petrol. Base)	G	G	G	G	G
Trichloroethane	F	G	X	G	G
Trichloroethylene	F	G	X	G	G
Tung Oil	G	—	—	—	G
Turpentine	G	G	X	G	G
Urea (Water Solution)	G	G	G	G	—
Uric Acid	G	G	G	G	—
Varnish	G	G	X	G	G
Vegetable Oil (Non-food)	G	G	F	G	G
Vinegar	G	X	G	G	X
Vinyl Acetate	G	—	X	—	F
Water (non-potable)	G	G	G	G	G
Water-Glycol Mixture	G	G	X	—	G
Water-Petroleum Mixture	G	G	—	F	G
Xylene	G	G	X	G	G
Zinc Chloride	X	X	G	G	X
Zinc Sulfate	G	G	G	G	X

### Codes:

G = Good Resistance  
 F = Fair Resistance  
 X = Incompatible  
 — = No data available  
 + = Call Technical Support  
 for specific application

**Note:**  
For plastic tube cutter,  
see page 141.

**Part Number Key:**

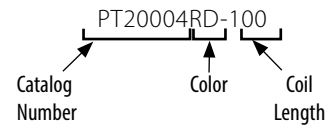

### PT200 Polyvinyl Chloride



**Typical Application:**  
Soft, pliable, plasticized PVC Resin Tubing, for practically any low pressure laboratory, industrial, agricultural or domestic application.

**Temperature Range:**  
-5°F to +105°F  
(-20°C to +41°C)

**Available Colors:**  
Clear (suffix NA)

**Connectors:**  
Polyline pgs. 58-61  
SelfAlign pgs. 52-57 with 2030x insert  
Compression pgs. 46-51 with 2030x insert  
Molded Compression pgs. 132-139

Catalog Number	Tube O.D. (in)	Tube Wall (in)	Max. Work. Pres. PSI 75°	Min. Burst Pres. PSI 75°	Min. Bend Radius 70° F	Lbs. Per 100 Ft.	Coil Length(s) (Ft)
PT20004	1/4 (.250)	.062	65	195	1.0"	2.00	100
PT20044	1/4 (.250)	.040	55	165	1.0"	2.00	100
PT20005	5/16 (.312)	.062	55	165	1.25"	2.60	100
PT20006	3/8 (.375)	.062	55	165	1.5"	3.30	100
PT20008	1/2 (.500)	.062	45	135	2.0"	4.60	100
PT20010	5/8 (.625)	.062	30	90	2.5"	5.90	100
PT20012	3/4 (.750)	.094	40	120	3.0"	10.3	100
PT20016	1(1.00)	.125	35	105	4.0"	18.5	100

### PT230 Polyamide "Nylon 6/6"



Natural off-white compound covered under 21CFR177.1500 regulations for food contact.

**Typical Application:**  
Semi-rigid general purpose tubing.

**Temperature Range:**  
-40°F to +180°F  
(-40°C to + 82°C)

**Available Colors:**  
Natural off-white (NA) and black (BK). FDA colors available on request.

**Contains:**  
Ultra-Violet Stabilizer in black tubing.

**Connectors:**  
SelfAlign pgs. 52-57  
Compression pgs. 46-51  
Push>Connect pgs. 62-72  
Push>Connect Flow Controls pgs. 73-74  
Push>Connect Plus pgs. 75-76

Catalog Number	Tube O.D. (in)	Tube Wall (in)	Max. Work. Pres. PSI 70°	Min. Burst Pres. PSI 70°	Min. Bend Radius 70° F	Lbs. Per 100 Ft.	Coil Length(s) (Ft)
PT23002	1/8 (.125)	.015	300	1,000	0.75"	0.3	100, 1,000
PT23003	3/16 (.188)	.023	300	1,000	1.25"	0.6	100, 1,000
PT23004	1/4 (.250)	.030	300	1,000	1.50"	1.0	100, 1,000
PT23005	5/16 (.312)	.036	300	1,000	2.00"	1.5-1.6	100, 1,000
PT23006	3/8 (.375)	.040	300	1,000	2.25"	2.1	100, 1,000

**Note:**  
For plastic tube cutter,  
see page 141.

**Part Number Key:**

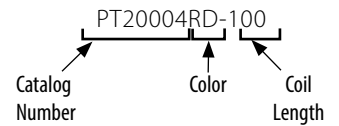

### PT240 Polyethylene

Meets FDA for food contact. Natural off-white compound covered under 21CFR177.1520 regulations for food contact.

**Typical Application:**

Economical, flexible, low density Polyethylene has a wide range of uses in industrial and agricultural applications.

**Temperature Range:**

-40°F to +135°F  
(-40°C to +57°C)

**Available Colors:**

Natural off-white (NA), black (BK), yellow (YW), orange (OR), blue (BU), red (RD), green (GN). FDA colors available on request. Refer to current price list for availability of colors.

**Contains:**

Ultra-Violet Stabilizer in black tubing.

**Connectors:**

Minibarb pgs. 77-80  
Polyline pgs. 58-61  
SelfAlign pgs. 52-57 with 2030 insert  
Compression pgs. 46-51 with 2030 insert  
Push>Connect pgs. 62-72  
Push>Connect Flow Controls pgs. 73-74  
Push>Connect Plus pgs. 75-76  
Molded Compression pgs. 132-139

Catalog Number	Tube O.D. (in)	Tube Wall (in)	Max. Work. Pres. PSI 70°	Min. Burst Pres. PSI 70°	Min. Bend Radius 70° F	Lbs. Per 100 Ft.	Coil Length(s) (Ft)
PT24004	1/4 (.250)	.062	200	600	0.75"	1.50	100, 1,000
PT24044	1/4 (.250)	.040	133	400	0.62"	1.00	100, 1,000
PT24005	5/16 (.312)	.062	135	480	1.00"	1.90	100, 1,000
PT24006	3/8 (.375)	.062	135	400	1.50"	2.40	100, 1,000
PT24008	1/2 (.500)	.062	100	300	2.00"	3.40	100, 500
PT24010	5/8 (.625)	.062	80	240	2.50"	4.40	100
PT24012	3/4 (.750)	.094	70	210	3.00"	7.60	100
PT24016	1 (1.000)	.125	100	300	5.00"	13.4	100

### TP160 Polyamide "Nylon 11"

**Typical Application:**

Flexible nylon tubing. Used for instrumentation; lubrication and air lines; gas, chemical and oil processing; low pressure hydraulics.

**Temperature Range:**

-40°F to +200°F  
(-40°C to +93°C)

**Available Colors:**

Black (BK) or natural (NA).

**Contains:**

Ultra-Violet Stabilizer

**Connectors:**

SelfAlign pgs. 52-57  
Compression pgs. 46-51

**Connectors (cont.):**

Push>Connect pgs. 62-72  
Push>Connect Flow Controls pgs. 58, 73-74  
Push>Connect Plus pgs. 75-76  
Molded Compression pgs. 132-139

Catalog Number	Tube O.D. (in)	Tube Wall (in)	Max. Work. Pres. PSI 70°	Min. Burst Pres. PSI 70°	Min. Bend Radius 70° F	Lbs. Per 100 Ft.	Coil Length(s) (Ft)
TP16002	1/8 (.125)	.023	250	1,000	.62"	.30	100, 1,000
TP16025	5/32 (.156)	.029	250	1,000	1"	.75	100, 1,000
TP16004	1/4 (.250)	.040	250	1,000	1.25"	1.2	100, 1,000
TP16005	5/16 (.312)	.040	250	1,000	2"	2.0	100, 1,000
TP16006	3/8 (.375)	.062	250	1,000	3"	2.7	100, 1,000
TP16008	1/2 (.500)	.062	250	1,000	4.5"	3.8	100, 500

# Tubing

## Plastic Tubing

**Note:**  
For plastic tube cutter,  
see page 143.

**Part Number Key:**

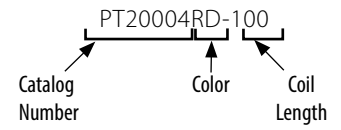

**MTP160 Polyamide “Nylon 11”  
Metric Tubing**

**Typical Application:**

Flexible nylon tubing. Used for instrumentation; lubrication and air lines; gas, chemical and oil processing; low pressure hydraulics.

**Temperature Range:**

-40°F to +200°F  
(-40°C to +93°C)

**Available Colors:**

Natural (NA).

**Contains:**

Ultra-Violet Stabilizer

**Connector:**

Metric Push>Connect  
pgs. 69-72

Catalog Number	Tube O.D. (mm)	Tube Wall (mm)	Max. Work. Pres. PSI 75°	Min. Burst Pres. PSI 75°	Min. Bend Radius 75° F	Lbs. Per 100 Ft.	Coil Length(s) (Ft)
MTP16004	4	.65	250	1,000	.75"	0.6	100
MTP16005	5	1	250	1,000	1"	0.9	100
MTP16006	6	1	250	1,000	1.5"	1.1	100
MTP16008	8	1	250	1,000	2.25"	1.5	100
MTP16010	10	1	200	800	3"	1.9	100
MTP16012	12	1	112	450	3.5"	2.3	100

# Tubing

## Air Brake Tubing

### Eclipse® Air Brake Tubing

Meets SAE J844, 1131, J2494-3 and DOT FMVSS106

#### Synflex Eclipse Type A Air Brake Tubing

Part Number	Nominal O.D.		Nominal I.D.		Minimum Bend Radius		Nominal Wall Thickness		Minimum Burst Pressure		Weight	
	mm	in	mm	in	mm	in	mm	in	kpa	psi	kg/100 m	lbs/100 ft
4245-022	3.18	1/8	2.01	.079	6.35	1/4	0.58	.023	6,900	1,000	.49	.33
4245-025	3.96	5/32	2.34	.092	12.70	1/2	0.79	.031	8,300	1,200	.83	.56
4245-03	4.77	3/16	2.97	.117	19.05	3/4	0.89	.035	8,300	1,200	1.06	.71
4245-05	7.95	5/16	5.89	.232	28.58	1-1/8	1.02	.040	6,900	1,000	2.29	1.54

#### Synflex Eclipse Type B Air Brake Tubing

Part Number	Nominal O.D.		Nominal I.D.		Minimum Bend Radius		Nominal Wall Thickness		Minimum Burst Pressure		Weight	
	mm	in	mm	in	mm	in	mm	in	kpa	psi	kg/100 m	lbs/100 ft
3270-06	9.53	3/8	6.38	.251	38.10	1.5	1.57	.062	9,700	1,400	4.2	2.8
3270-08	12.70	1/2	9.55	.376	50.80	2.0	1.57	.062	6,600	950	5.8	3.8
3270-10	15.88	5/8	11.20	.441	63.50	2.5	2.34	.092	6,200	900	10.4	7.0
3270-12	19.05	3/4	14.38	.566	76.20	3.0	2.34	.092	5,500	800	12.8	8.6

#### Features

- Superior abrasion resistance
- Easy to cut
- Enhanced flexibility and extension
- Flow performance

#### Applications

- Truck air brake systems
- Trailer air brake systems

- Auxiliary air systems
- Formed tubes
- Formed and straight air brake harness assemblies

#### Construction

- Distinctive patented construction
- 100% polyamide construction with polyester yarn reinforcement

- UV stabilized
- Thermoformable
- Available in standard and custom colors
- Available in all standard sizes

#### Temperature Range

- -65°F to 200°F (-54°C to 93°C).

#### Connectors:

QCAB pages 81-89 1400 series Air Brake pages 90-95

For 1/8" Tubing use SelfAlign.

**Note:** SelfAlign Connectors are not designed to meet DOT standards.

### Solstice™ Type A Air Brake Tubing

Meets or exceeds the performance requirements SAE J844, J1131, J2494-3, and DOT FMVSS106 Synflex Solstice Type Air Brake Tubing

Part Number	Nominal O.D.		Nominal I.D.		Minimum Bend Radius		Nominal Wall Thickness		Minimum Burst Pressure		Weight	
	mm	in	mm	in	mm	in	mm	in	kpa	psi	kg/100m	lbs/100 ft
4247-041	6.35	1/4	4.32	.170	25.40	1	1.02	0.04	8,300	1,200	2.20	1.50

#### Applications

- Truck air brake systems
- Trailer air brake systems
- Auxiliary air systems
- Formed tubes
- Formed and straight air brake harness assemblies

#### Features

- Highly engineered thermoplastic material
- Monowall tubing
- UV stabilized
- Thermoformable
- Available in standard and custom colors

#### Temperature Range

- (-40°F to 200°F)
- -40°C to 93°C

#### Connectors:

QCAB pages 81-89 1400 Series Air Brake pages 88-93

# Tubing

## Air Brake Tubing

Eclipse ABT Part #	O.D.	Master Pack Color	Master Pack Quantities	Configuration
4245-02207	1/8"	black	12,000 ft	6 reels of 2000 ft
4245-02227	1/8"	red	12,000 ft	6 reels of 2000 ft
4245-02257	1/8"	green	12,000 ft	6 reels of 2000 ft
4245-02267	1/8"	blue	12,000 ft	6 reels of 2000 ft
4245-02506	5/32"	black	6,000 ft	6 reels of 1000 ft
4245-02526	5/32"	red	6,000 ft	6 reels of 1000 ft
4245-02546	5/32"	yellow	6,000 ft	6 reels of 1000 ft
4245-02556	5/32"	green	6,000 ft	6 reels of 1000 ft
4245-02566	5/32"	blue	6,000 ft	6 reels of 1000 ft
4245-03306	3/16"	black	6,000 ft	6 reels of 1000 ft
4245-03326	3/16"	red	6,000 ft	6 reels of 1000 ft
4245-03356	3/16"	green	6,000 ft	6 reels of 1000 ft
4247-04106	1/4"	Black	6,000 ft	6 reels of 1000 ft
4247-04156	1/4"	Green	6,000 ft	6 reels of 1000 ft
4247-04126	1/4"	Red	6,000 ft	6 reels of 1000 ft
4247-04166	1/4"	Blue	6,000 ft	6 reels of 1000 ft
4247-041C6	1/4"	Brown	6,000 ft	6 reels of 1000 ft
4247-04146	1/4"	Yellow	6,000 ft	6 reels of 1000 ft
4247-04136	1/4"	Orange	6,000 ft	6 reels of 1000 ft
4247-041D6	1/4"	Purple	6,000 ft	6 reels of 1000 ft
4247-04116	1/4"	White	6,000 ft	6 reels of 1000 ft
4247-041F6	1/4"	Silver	6,000 ft	6 reels of 1000 ft
4245-05204	5/16"	black	3,000 ft	6 reels of 500 ft
4245-05224	5/16"	red	3,000 ft	6 reels of 500 ft
4245-05244	5/16"	yellow	3,000 ft	6 reels of 500 ft
4245-05254	5/16"	green	3,000 ft	6 reels of 500 ft
4245-05264	5/16"	blue	3,000 ft	6 reels of 500 ft
3270-06104	3/8"	black	3,000 ft	6 reels of 500 ft
3270-06124	3/8"	red	3,000 ft	6 reels of 500 ft
3270-06134	3/8"	orange	3,000 ft	6 reels of 500 ft
3270-06144	3/8"	yellow	3,000 ft	6 reels of 500 ft
3270-06154	3/8"	green	3,000 ft	6 reels of 500 ft
3270-06164	3/8"	blue	3,000 ft	6 reels of 500 ft
3270-08104	1/2"	black	1,500 ft	3 reels of 500 ft
3270-08124	1/2"	red	1,500 ft	3 reels of 500 ft
3270-08134	1/2"	orange	1,500 ft	3 reels of 500 ft
3270-08144	1/2"	yellow	1,500 ft	3 reels of 500 ft
3270-08154	1/2"	green	1,500 ft	3 reels of 500 ft
3270-08164	1/2"	blue	1,500 ft	3 reels of 500 ft
3270-10103	5/8"	black	750 ft	3 reels of 250 ft
3270-10123	5/8"	red	750 ft	3 reels of 250 ft
3270-10133	5/8"	orange	750 ft	3 reels of 250 ft
3270-10143	5/8"	yellow	750 ft	3 reels of 250 ft
3270-10153	5/8"	green	750 ft	3 reels of 250 ft
3270-10163	5/8"	blue	750 ft	3 reels of 250 ft
3270-12103	3/4"	black	750 ft	3 reels of 250 ft
3270-12123	3/4"	red	750 ft	3 reels of 250 ft
3270-12133	3/4"	orange	750 ft	3 reels of 250 ft
3270-12153	3/4"	green	750 ft	3 reels of 250 ft
3270-12163	3/4"	blue	750 ft	3 reels of 250 ft



# Brass Products

## Introduction

Danfoss brass tube fittings are made from high quality UNS CA-360 brass bar. Danfoss brass connectors are precision machined to meet SAE standards and specifications. Large, uniform wrench pad areas have standard dimensions for easy assembly and disassembly using standard open-end wrenches. On fittings where pipe threads are used, the fittings are standardized on Dryseal American National Standard Taper. Danfoss offers the only complete line of brass connectors with these outstanding advantages.

### Hot Extrusion

A cast billet is heated and extruded through a die containing the desired configuration. This process recrystallizes the weaker cast structure into the stronger pressed structure of the shaped extrusion.

### Cold Draw

The hot extruded shape is pulled through a die with the same configuration but less cross sectional area. This further recrystallizes and refines the structure while increasing the strength and elongation. In addition, the dimensions are brought to close tolerances.

Hot Extrusion

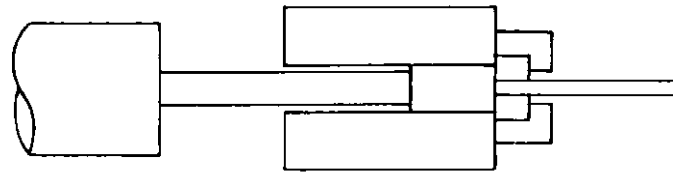

Cold Draw

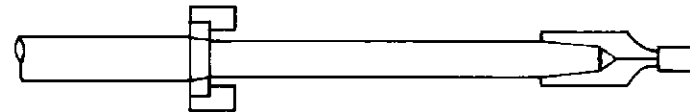

### Shapes

The dies through which the billets are forced may be one of hundreds of shapes. Four of the most common shapes, used in the manufacture of Danfoss connectors, are illustrated.

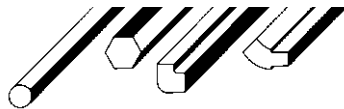

### Saw and Machine

The cold bar stock is then cut into individual pieces for precision machining. After the part is machined, it is ready for the market as a strong, tough, high quality connector. Only by using this process is it possible to get the big all-flat sides on elbows and tees, instead of the usual small wrench pads, or lack of flats all together.

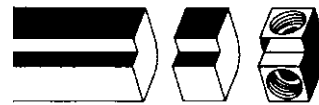

### Microstructure

The photomicrographs illustrate the change in microstructure from the low strength low ductility dendritic structure of the cast billet, to the recrystallized structure of the hot extrusion, to the refined structure of the high strength high ductility cold drawn rod.



As Cast – 50x



Hot Extruded – 200x



Cold Drawn – 200x

# Brass Products Inverted Flare

**Note:**  
For additional technical questions, contact Technical Support at 1-888-258-0222.

 Refer to safety information regarding proper selection of tubing and tube connectors on page 3.

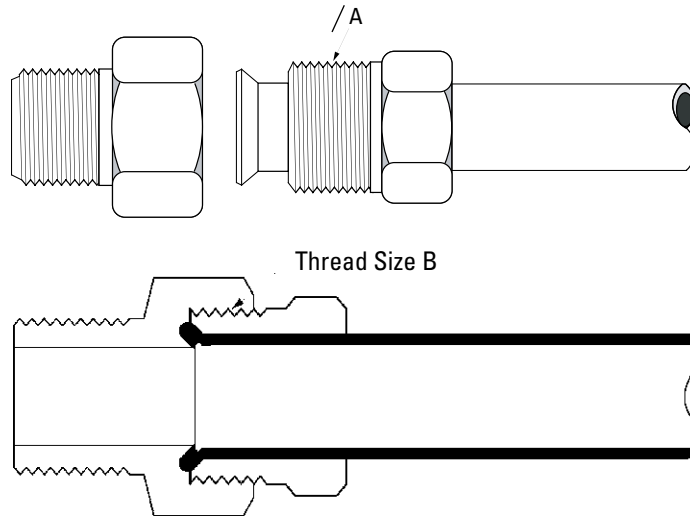

Tube O.D.	1/8	3/16	1/4	5/16	3/8	7/16	1/2	5/8	3/4	7/8	1
Thread Size-B	5/16-28	3/8-24	7/16-24	1/2-20	5/8-18	11/16-18	3/4-18	7/8-18	1-1/16-16	1-3/16-16	1-5/16-16

**Typical Application:**

Hydraulic brake, power steering, fuel lines and transmission cooler lines, LP and natural gas (special order).

**Pressure:**

Working pressure up to 2000 psi depending on tube size. Will withstand burst pressure of standard tubing - up to 5000 psi with Bundy-weld (double flared) and 3500 psi with copper tubing, depending on size.

**Vibration:**

Excellent resistance.

**Temperature Range:**

-65°F to +250°F (-53°C to +121°C) range at maximum operating pressures.

**Material:**

CA360 Brass.

**Used With:**

Copper, brass, aluminum and steel hydraulic tubing that can be flared. See pages 25-29 for material compatibility.

**Advantages:**

Very low cost and reusable. Seats and threads are internal and protected. Compact, excellent vibration life. Short nut affords very close tube bends. Steel or brass tube nut.

**Conformance:**

Listed by Underwriter's Laboratories (available on special order) for fuel equipment, refrigeration and gas. Meets specifications and standards of ASA, ASME, SAE and MS (Military Standards).

**How to Order:**

Order individually by catalog number.

**Note:**

Refer to current price list for availability of cataloged items. Configurations and dimensions subject to change without notice. Additional information can be found in SAE J512.

**Label Set:**

W-8022 (adhesive)  
CL-490 (non-adhesive)

**Assembly Instructions:**

1. Cut tubing to desired length. Make sure all burrs are removed and the ends are cut square.
2. Slide nut on tube. Threaded end "A" of nut must face out.
3. Flare end of tube with a 45° flaring tool. See page 23 for flare data.
  - a. Measure flare diameter.
  - b. Examine flare for excessive thin out.
  - c. On thin wall, welded or brazed tubing, use double flare to prevent pinch-off and cracked flares.
4. Lubricate threads and assemble to connector body. Nut should be turned hand tight.
5. Tighten assembly with a wrench until a solid feeling is encountered. From that point, apply a one-sixth turn.

**Note:**

Do not over-torque as it may damage the connectors or split the tubing at the flare.

# Brass Products

## Inverted Flare

### Tube Nut

(Steel)

(Ref. SAE No. 040110)

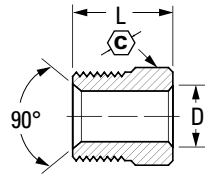
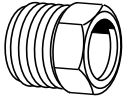

Tube O.D.	Catalog Number		D	L
1/8	105x2	5/16	0.132	0.52
3/16	105x3	3/8	0.196	0.56
1/4	105x4	7/16	0.259	0.56
5/16	105x5	1/2	0.321	0.62
3/8	105x6	5/8	0.384	0.66
3/8	105x6x7*	11/16	0.387	0.66
7/16	105x7	11/16	0.444	0.68
1/2	105x8	3/4	0.508	0.74
5/8	105x10	7/8	0.632	0.80
3/4	105x12	1-1/16	0.757	0.88
7/8	105x14	1-3/16	0.882	1.06
1	105x16	1-3/8	1.008	1.18

\*3/8" Tube to 11/16-18 Male Thread

### Tube Nut

(Brass)

(Ref. SAE No. 040110)

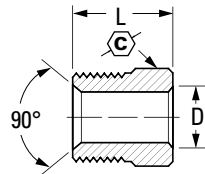
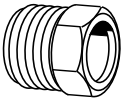

Tube O.D.	Catalog Number		D	L
3/16	100x3	3/8	.196	0.56
1/4	100x4	7/16	.259	0.56
5/16	100x5	1/2	.321	0.62
3/8	100x6	5/8	.384	0.66
1/2	100x8	3/4	.508	0.74

### Plug

(Steel)

(Ref. SAE No. 040109)

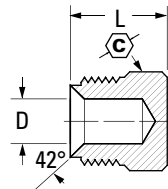
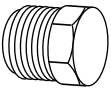

Tube O.D.	Catalog Number		D	L
3/16	131x3	3/8	.188	0.53
1/4	131x4	7/16	.188	0.54
5/16	131x5	1/2	.250	0.59
3/8	131x6	5/8	.312	0.66

### Tube Nut Long

(Steel)

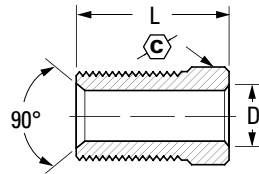
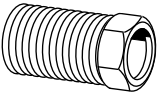

Tube O.D.	Catalog Number		D	L
3/16	7896x3	3/8	.196	.844
1/4	7896x4	7/16	.257	.812

Required for wheel cylinders with deep port connection.

### Union

(Ref. SAE No. 040101)

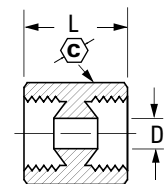
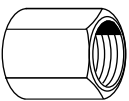

Tube O.D.	Catalog Number		D	L
1/8	302x2	13/32	.078	.59
3/16	302x3	15/32	.125	.62
1/4	302x4	17/32	.188	.62
5/16	302x5	19/32	.219	.70
3/8	302x6	3/4	.281	.80
1/2	302x8	29/32	.406	.91
5/8	302x10	1-1/16	.531	.97

♦ MTO - Made To Order

# Brass Products

## Inverted Flare

### Male Connector

(Ref. SAE No. 040102)

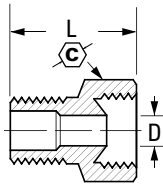
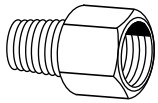

Pipe end drill may be reduced or increased from seat dimension 'D'.

Tube O.D.	Male Pipe Thread	Catalog Number		D	L
1/8	1/8	202x2	13/32	.078	0.62
3/16	1/8	202x3	15/32	.125	0.70
1/4	1/8	202x4	17/32	.188	0.74
1/4	1/4	202x4x4	9/16	.188	0.89
5/16	1/8	202x5	19/32	.219	0.79
5/16	1/4	202x5x4	19/32	.220	0.98
3/8	1/8	202x6x2	3/4	.281	0.89
3/8	1/4	202x6	3/4	.281	1.03
3/8	3/8	202x6x6	3/4	.281	1.01
1/2	1/4	202x8x4	29/32	.406	1.08
1/2	3/8	202x8	29/32	.406	1.07
1/2	1/2	202x8x8	29/32	.406	1.26
5/8	1/2	202x10	1-1/16	.531	1.32
3/4	3/4	202x12	1-1/4	.625	1.39
7/8	3/4	202x14	1-3/8	.750	1.38
1	1	202x16	1-1/2	.812	1.62

♦ MTO - Made To Order

### Female Connector

(Ref. SAE No. 040103)

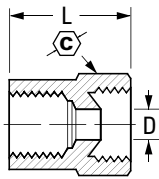
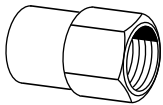

Tube O.D.	Fem. Pipe Thread	Catalog Number		D	L
3/16	1/8	252x3	1/2	.125	0.75
1/4	1/8	252x4	17/32	.188	0.75
5/16	1/8	252x5	19/32	.219	0.78
3/8	1/4	252x6	3/4	.281	1.03
1/2	3/8	252x8	29/32	.406	1.09

♦ MTO - Made To Order

### 45° Male Elbow

(Ref. SAE No. 040302)

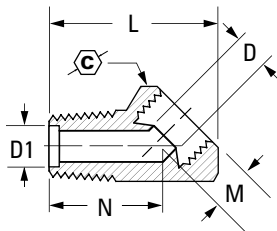
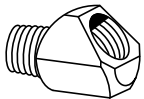

Tube O.D.	Male Pipe Thread	Catalog Number		D	D1	L	M	N
3/16	1/8	352x3	17/32	.125	.156	0.88	0.25	0.55
1/4	1/8	352x4	9/16	.188	.188	0.94	0.27	0.58
5/16	1/8	352x5	5/8	.219	.203	1.00	0.34	0.56
5/16	1/4	352x5x4	5/8	.219	.203	1.16	0.23	0.83
3/8	1/4	352x6	25/32	.281	.219	1.34	0.41	0.84
1/2	3/8	352x8	7/8	.406	.375	1.44	0.38	0.91

♦ MTO - Made To Order

# Brass Products

## Inverted Flare

### 90° Union Elbow

(Ref. SAE No. 040201)

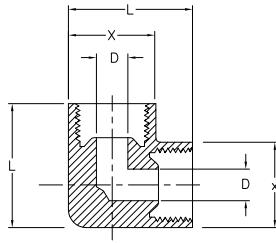
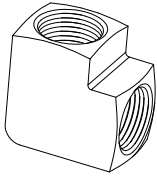

Tube O.D.	Catalog Number	D	L	X
1/4	502x4	.188	0.77	0.53
5/16	502x5 ♦	.219	0.87	0.60
3/8	502x6 ♦	.281	1.04	0.72

♦ MTO - Made To Order

### 90° Male Elbow

(Ref. SAE No. 040202)

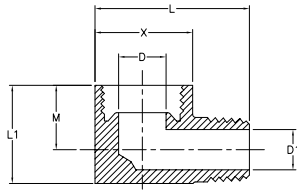
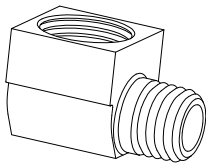

Tube O.D.	Male Pipe Thread	Catalog Number	D	D1	L	L1	M	X
1/8	1/8	402x2	.078	.116	0.80	0.47	0.27	0.42
3/16	1/8	402x3	.125	.125	0.85	0.47	0.27	0.47
1/4	1/8	402x4	.188	.177	0.92	0.55	0.33	0.53
1/4	1/8	431x4*	.188	.062	0.91	0.53	0.33	0.53
1/4	1/4	402x4x4	.188	.188	1.09	0.58	0.28	0.56
5/16	1/8	402x5	.219	.219	0.98	0.67	0.47	0.59
5/16	1/4	402x5x4	.219	.219	1.16	0.75	0.45	0.59
3/8	1/8	402x6x2	.281	.219	1.14	0.75	0.54	0.76
3/8	1/4	402x6	.281	.281	1.32	0.82	0.53	0.76
3/8	3/8	402x6x6	.281	.312	1.32	0.84	0.50	0.75
1 1/2	3/8	402x8	.406	.375	1.48	0.94	0.59	0.92
1/2	1/2	402x8x8	.406	.406	1.67	1.09	0.66	0.91
5/8	3/8	402x10x6 ♦	.531	.437	1.62	1.11	0.67	1.06
5/8	1/2	402x10 ♦	.531	.500	1.82	1.11	0.67	1.06
3/4	1/2	402x12x8	.626	.531	2.09	1.30	0.85	1.25
7/8	3/4	402x14	.750	.750	2.12	1.46	0.94	1.38
1	1	402x16	.812	.812	2.44	1.70	1.02	1.50

\*.062 dia. restricted hole through pipe end. Available on special order with any restricted hole size up to .172 dia.

♦ MTO - Made To Order

### 90° Female Elbow

(Ref. SAE No. 040203)

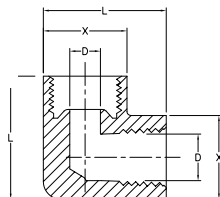
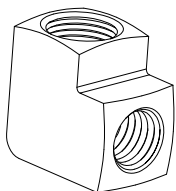

Tube O.D.	Fem. Pipe Thread	Catalog Number	D	L	X
3/16	1/8	452x3 ♦	.125	0.81	0.50
1/4	1/8	452x4	.188	0.81	0.53
5/16	1/8	452x5	.219	0.88	0.60
3/8	1/4	452x6	.281	1.05	0.75

♦ MTO - Made To Order

# Brass Products

## Inverted Flare

### Union Tee

(Ref. SAE No. 040401)

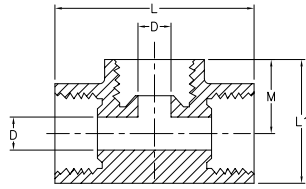
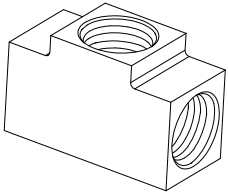

Tube O.D.	Catalog Number	D	L	L1	M
1/8	702x2	.078	0.94	0.53	.330
3/16	702x3	.125	1.09	0.64	.390
1/4	702x4	.189	1.13	0.70	.420
5/16	702x5	.219	1.25	0.75	.450
3/8	702x6	.282	1.48	0.95	.560

### Male Run Tee

(Ref. SAE No. 040424)

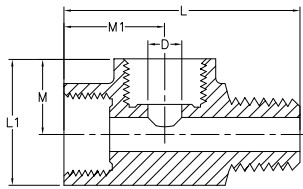
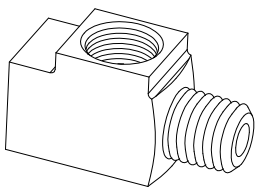

Tube O.D.	Male Pipe Thread	Catalog Number	D	L	L1	M	M1
3/16	1/8	752x3 ♦	.125	1.25	0.62	0.39	0.53
1/4	1/8	752x4	.189	1.31	0.70	0.42	0.56
5/16	1/8	752x5 ♦	.219	1.47	0.75	0.45	0.62
3/8	1/4	752x6 ♦	.281	1.83	0.94	0.56	0.75
1/2	3/8	752x8 ♦	.406	.406	1.39	1.47	0.91

♦ MTO - Made To Order

### Male Branch Tee

(Ref. SAE No. 040425)

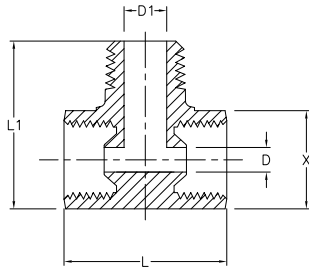
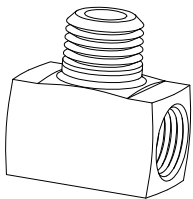

Tube O.D.	Male Pipe Thread	Catalog Number	D	D1	L	L1	X
3/16	1/8	602x3	.125	.219	0.83	0.86	0.50
1/4	1/8	602x4	.189	.219	0.84	0.96	0.57
5/16	1/8	602x5	.219	.219	0.96	0.96	0.58
3/8	1/4	602x6	.281	.344	1.16	1.33	0.78
1/2	3/8	602x8 ♦	.406	.406	1.39	1.47	0.91

♦ MTO - Made To Order

### Female Branch Tee

(Ref. SAE No. 040427)

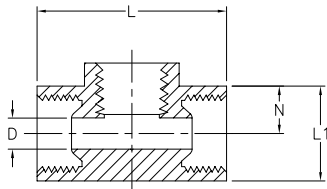
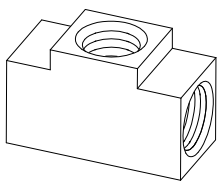

Tube O.D.	Fem. Pipe Thread	Catalog Number	D	L	L1	N
3/16	1/8	652x3	.125	1.10	0.62	0.39
1/4	1/8	652x4 ♦	.189	1.13	0.70	0.42

♦ MTO - Made To Order

# Brass Products

## SAE 45° Flare

**Note:**  
For additional technical questions, contact Technical Support at 1-888-258-0222.

 Refer to safety information regarding proper selection of tubing and tube connectors on page 3.

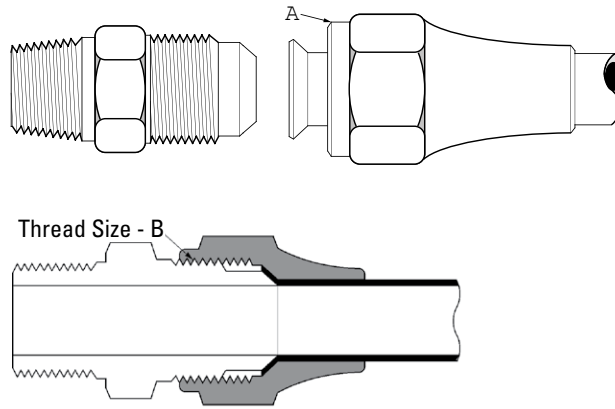

<b>Tube O.D.</b>	1/8	3/16	1/4	5/16	3/8	7/16	1/2	5/8	3/4
<b>Thread Size-B</b>	5/16-24	3/8-24	7/16-20	1/2-20	5/8-18	11/16-18	3/4-16	7/8-14	1-1/16-14

### Typical Application:

LP and natural gas, flammable liquids (special order), instrumentation, refrigeration, power steering, hydraulic and pneumatic systems.

### Pressure:

Working pressure up to 2000 psi depending on tube size. Will withstand burst pressure of standard tubing - up to 5000 psi with Bundy-weld (double flared) and 3500 psi with copper tubing, depending on size.

### Vibration:

Good resistance - use long nut when greater vibration resistance is required.

### Temperature Range:

-65°F to +250°F (-53°C to +121°C) range at maximum operating pressures.

### Material:

CA360 Brass.

### Used With:

Copper, brass, aluminum and steel hydraulic tubing that can be flared. See pages 25-29 for material compatibility.

### Advantages:

Low cost and reusability, long or short nut. Good resistance to vibration.

### Conformance:

Listed by Underwriter's Laboratories (available on special order) for flammable liquids, refrigeration and gas. Meets specifications and standards of ASA, ASME, SAE and MS (Military Standards).

### How to Order:

Order individually by catalog number.

### Note:

Refer to current price list for availability of cataloged items. Configurations and dimensions subject to change without notice. Quotations of non-stock items available upon request. Additional information can be found in SAE J512.

### Assembly Instructions:

1. Cut tubing to desired length. Make sure all burrs are removed and the ends are cut square.
2. Slide nut on tube. Threaded end "A" of nut must face out.
3. Flare end of tube with a 45° flaring tool. See page 23 for flare data.
  - a. Measure flare diameter.
  - b. Examine flare for excessive thin out.
4. Lubricate threads and assemble to connector body. Nut should be turned hand tight.
5. Tighten assembly with a wrench until a solid feeling is encountered. From that point, apply a one-sixth turn.

### Note:

Do not over-torque as it may damage the connector or split the tubing at the flare.

### Label Set:

W-8022 (adhesive)  
CL-490 (non-adhesive)

# Brass Products

## SAE 45° Flare

**Note:**  
For additional technical questions, contact Technical Support at 1-888-258-0222.



Refer to safety information regarding proper selection of tubing and tube connectors on page 3.

**Nut**  
(Ref. SAE No. 010110)

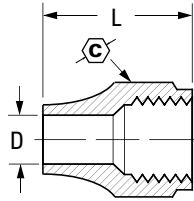
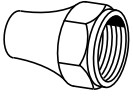

**Long Nut**  
(Ref. SAE No. 010111)

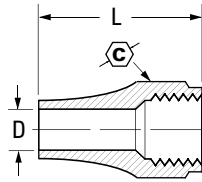
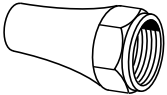

**Cap**

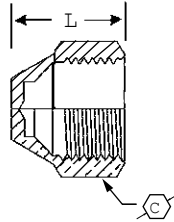
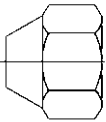

**Plug**  
(Ref. SAE No. 010109)

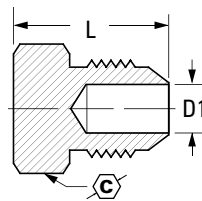
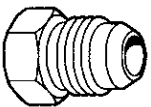

**Union**  
(Ref. SAE No. 010101)

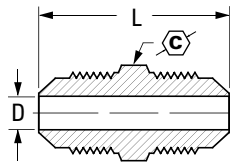
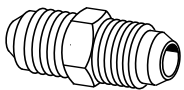

Tube O.D.	Catalog Number		D	L
1/8	1110x2	3/8	.133	0.50
3/16	1110x3	7/16	.195	0.62
1/4	1110x4	9/16	.258	0.75
5/16	1110x5	5/8	.320	0.88
3/8	1110x6 ♦	3/4	.383	1.00
7/16	1110x7	13/16	.445	1.06
1/2	1110x8	7/8	.508	1.12
5/8	1110x10 ♦	1-1/16	.633	1.31
3/4	1110x12	1-1/4	.758	1.50

♦ MTO - Made To Order

Tube O.D.	Catalog Number		D	L
3/16	41x3	7/16	.195	0.81
1/4	41x4	9/16	.258	0.94
5/16	41x5	5/8	.320	1.12
3/8	41x6	3/4	.383	1.31
1/2	41x8	7/8	.508	1.62
5/8	41x10 ♦	1-1/16	.633	1.88

♦ MTO - Made To Order

Tube O.D.	Catalog Number		L
1/8	40x2	7/16	0.40
3/16	40x3	1/2	0.47
1/4	40x4	7/16	0.53
5/16	40x5	5/8	0.62
3/8	40x6	3/4	0.69
1/2	40x8	7/8	0.84
5/8	40x10	1-1/16	0.97
3/4	40x12	1-5/16	1.09

Tube O.D.	Catalog Number		L	D1 (opt.)
1/8	39x2	5/16	0.47	.079
3/16	39x3	3/8	0.58	.126
1/4	39x4	7/16	0.69	.189
5/16	39x5	1/2	0.79	.220
3/8	39x6	5/8	0.88	.282
1/2	39x8	3/4	1.06	.408
5/8	39x10	7/8	1.19	.502
3/4	39x12	1-1/16	1.31	.627

Tube O.D.	Catalog Number		D	L
1/8	42x2 ♦	5/16	.078	0.92
3/16	42x3	3/8	.125	1.06
1/4	42x4	7/16	.188	1.19
5/16	42x5	1/2	.219	1.34
3/8	42x6	5/8	.281	1.50
1/2	42x8	3/4	.406	1.81
5/8	42x10	7/8	.500	2.12
3/4	42x12	1-1/16	.625	2.44

MTO - Made To Order ♦



# Brass Products

## SAE 45° Flare

### Male Connector

(Ref. SAE No. 010102)

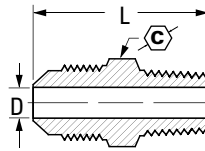
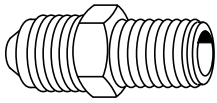

Tube O.D.	Male Pipe Thread	Catalog Number		D	L1	D1
1/8	1/8	48x2	7/16	.078	0.90	.219
3/16	1/8	48x3	7/16	.125	1.00	.219
1/4	1/8	48x4	7/16	.188	1.06	.219
1/4	1/4	48x4x4	9/16	.188	1.26	.312
5/16	1/8	48x5	1/2	.219	1.16	.219
5/16	1/4	48x5x4	9/16	.219	1.34	.281
3/8	1/8	48x6x2	5/8	.281	1.25	.406
3/8	1/4	48x6	5/8	.281	1.44	.562
3/8	3/8	48x6x6	11/16	.281	1.44	.312
3/8	1/2	48x6x8	7/8	.281	1.69	.219
1/2	1/4	48x8x4	3/4	.406	1.62	.281
1/2	3/8	48x8	3/4	.406	1.62	.406
1/2	1/2	48x8x8	7/8	.406	1.81	.562
5/8	3/8	48x10x6	7/8	.500	1.81	.406
5/8	1/2	48x10	7/8	.500	2.00	.500
3/4	1/2	48x12	1-1/16	.562	2.18	.562
3/4	3/4	48x12x12	1-1/16	.625	2.18	.751

### Female Connector

(Ref. SAE No. 010103)

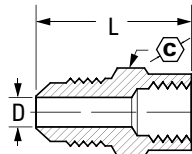
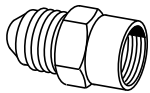

Tube O.D.	Fem. Pipe Thread	Catalog Number		D	L
3/16	1/8	46x3 ♦	9/16	.125	0.97
1/4	1/8	46x4	9/16	.188	1.03
1/4	1/4	46x4x4	11/16	.188	1.25
5/16	1/8	46x5	9/16	.219	1.06
5/16	1/4	46x5x4 ♦	11/16	.219	1.28
3/8	1/4	46x6	11/16	.281	1.31
3/8	3/8	46x6x6	13/16	.281	1.38
3/8	1/2	46x6x8 ♦	1	.281	1.62
1/2	3/8	46x8	13/16	.406	1.50
1/2	1/2	46x8x8 ♦	1	.406	1.75
5/8	3/8	46x10x6 ♦	7/8	.500	1.59
5/8	1/2	46x10w	1	.500	1.81
5/8	3/4	46x10x12 ♦	1-1/4	.500	1.90

♦MTO - Made To Order

### Male Ball Check Connector

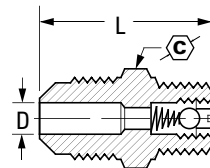
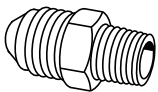

Ball & Spring position may be reversed to change flow/check direction. Min pressure 3 psi.

Tube O.D.	Male Pipe Thread	Catalog Number		D	L
1/4	1/8	43x4	7/16	.125	1.06
3/8	1/4	43x6	5/8	.219	1.31

### 45° Male Elbow

(Ref. SAE No. 010302)

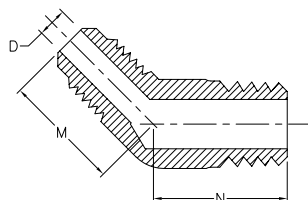
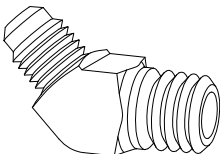

Tube O.D.	Male Pipe Thread	Catalog Number	D	M	N
1/4	1/8	54x4	.188	0.67	0.64
1/4	1/4	54x4x4	.188	0.73	0.87
5/16	1/8	54x5	.219	0.78	0.64
3/8	1/4	54x6	.283	0.89	0.86
1/2	3/8	54x8	.407	1.06	0.96
1/2	1/2	54x8x8	.406	1.12	1.17
5/8	3/8	54x10x6	.500	1.23	0.98
5/8	1/2	54x10	.500	1.23	1.17

# Brass Products

## SAE 45° Flare

**AC Type Adapter**

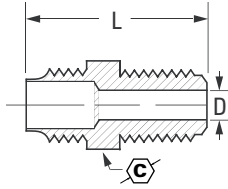
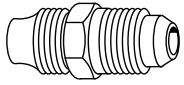

Tube Size	SAE Tube Size	Catalog Number		D	L
1/4	1/4	1521	7/16	.188	1.094

**90° Union Elbow**

(Ref. SAE No. 010201)

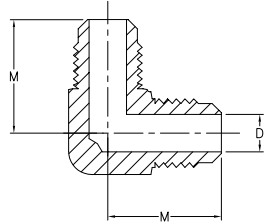
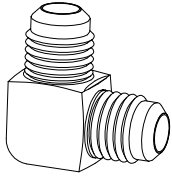

Tube O.D.	Catalog Number	D	M
1/2	55x8	.406	1.23
3/4	55x12 ♦	.625	1.64

♦MTO - Made To Order

**90° Male Elbow**

(Ref. SAE No. 010202)

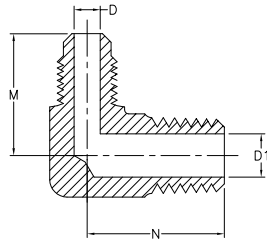
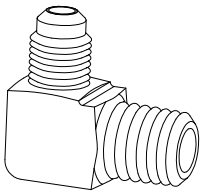

Tube O.D.	Male Pipe Thread	Catalog Number	D	D1	M	N
1/8	1/8	49x2	.078	.219	0.62	0.69
3/16	1/8	49x3	.125	.219	0.75	0.75
1/4	1/8	49x4	.188	.219	0.81	0.76
1/4	1/4	49x4x4	.188	.312	0.88	0.99
1/4	3/8	49x4x6	.188	.406	0.94	1.03
5/16	1/8	49x5	.219	.219	0.91	0.78
5/16	1/4	49x5x4	.219	.312	0.95	0.92
3/8	1/8	49x6x2	.283	.219	1.03	0.91
3/8	1/4	49x6	.281	.312	0.97	1.06
3/8	3/8	49x6x6	.281	.406	1.06	1.09
3/8	1/2	49x6x8	.281	.438	1.16	1.28
1/2	1/4	49x8x4	.406	.312	1.23	1.19
1/2	3/8	49x8	.406	.406	1.23	1.12
1/2	1/2	49x8x8	.406	.406	1.25	1.32
5/8	3/8	49x10x6	.502	.406	1.42	1.23
5/8	1/2	49x10	.502	.562	1.42	1.37
3/4	1/2	49x12	.626	.562	1.62	1.48
3/4	3/4	49x12x12	.625	.750	1.59	1.62

**90° Female Elbow**

(Ref. SAE No. 010203)

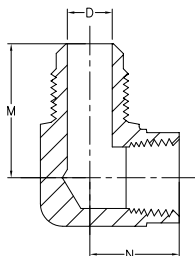
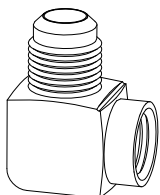

Tube O.D.	Fem. Pipe Thread	Catalog Number	D	M	N
1/4	1/8	50x4	.189	0.88	0.47
1/4	1/4	50x4x4	.188	0.97	0.66
3/8	1/4	50x6	.283	1.09	0.69

♦MTO - Made To Order

# Brass Products

## SAE 45° Flare

### Union Tee

(Ref. SAE No. 010401)

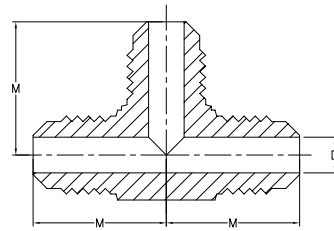
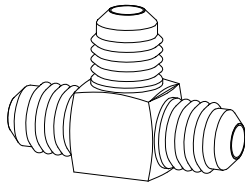

Tube O.D.	Catalog Number	D	M
3/16	44x3 ♦	.125	0.73
1/4	44x4	.188	0.88
3/8	44x6 ♦	.283	1.06
1/2	44x8	.407	1.20

♦MTO - Made To Order

### Male Run Tee

(Ref. SAE No. 010424)

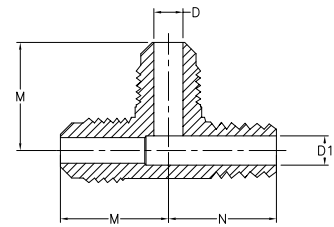
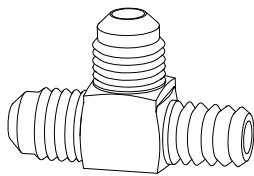

Tube O.D.	Male Pipe Thread	Catalog Number	D	D1 Opt.	M	N
1/4	1/8	51x4	.188	.219	0.88	0.76

♦MTO - Made To Order

### Male Branch Tee

(Ref. SAE No. 010425)

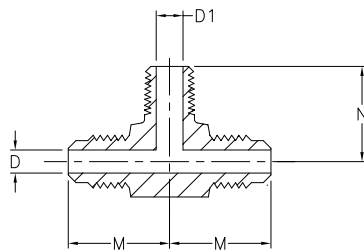
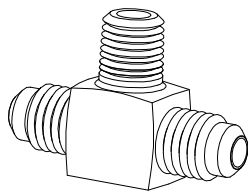

Tube O.D.	Male Pipe Thread	Catalog Number	D	D1	M	N
1/4	1/8	45x4	.188	.222	0.83	0.78
1/2	3/8	45x8 ♦	.407	.406	1.22	1.12
1/2	1/2	45x8x8x8 ♦	.406	.562	1.28	1.38

♦MTO - Made To Order

### Adapter Tee

(Female to Male Pipe on Run)

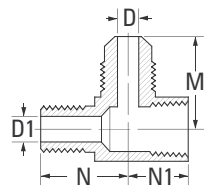
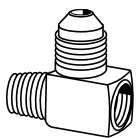

Tube O.D.	Male Pipe Thread	Catalog Number	D	D1	M	N	N1
1/4	1/8	56x4w	.188	.188	0.78	0.76	0.46

♦MTO - Made To Order

**Note:**  
For additional technical questions, contact Technical Support at 1-888-258-0222.

 Refer to safety information regarding proper selection of tubing and tube connectors on page 3.

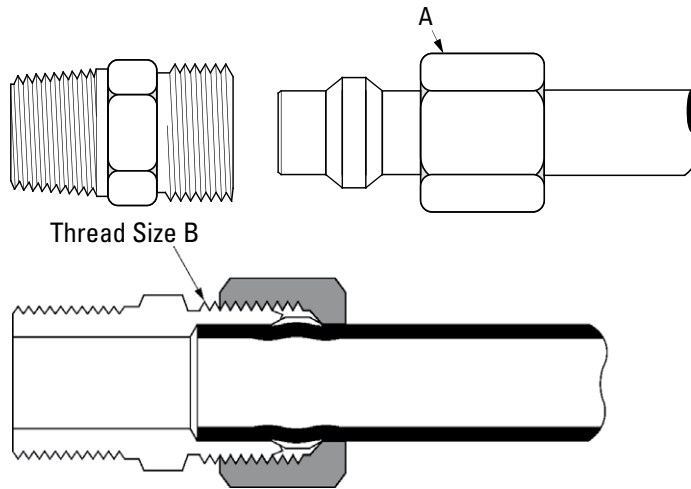

Tube O.D.	1/8	3/16	1/4	5/16	3/8	7/16	1/2	5/8	3/4	1
Thread Size-B	5/16-24	3/8-24	7/16-24	1/2-24	9/16-24	5/8-24	11/16-20	13/16-18	1-18	1-1/4-18

**Typical Application:**

Instrumentation, hydraulic and pneumatic systems.

**Pressure:**

Working pressure up to 2000 psi with a 4:1 safety factor depending on tube size. When using plastic tubing, use the working pressure for type used.

**Vibration:**

Fair resistance - use long nut when greater vibration resistance is needed.

**Temperature Range:**

65°F to +250°F (-53°C to +121°C) with metal tubing. When using compatible plastic tubing do not exceed the tubing temperature range. (Refer to tubing temperature range.)

**Material:**

CA360 Brass.

**Used With:**

Aluminum, copper and plastic tubing.

Plastic tubing, except for PT230 and TP160, requires 2030x insert. Not recommended for steel tubing. See pages 25-29 for material compatibility, and pages 30-33 for plastic tubing.

**Advantages:**

Low cost. Easy to assemble, no flaring. Available with long or short nut. Broad selection of styles and sizes.

**Conformance:**

Meets specifications and standards of ASA, ASME and SAE.

**How to Order:**

Compression connectors are ordered as complete assemblies (body, nut and sleeve). To order assembly supplied with long nuts, simply add the prefix "1" to the catalog number. Example: 68x4 with long nut becomes 168x4. Nuts and sleeves can be ordered separately by catalog number. To order bodies only (less nut and sleeve), prefix catalog number with letter "B". Example: B68x4.

**Note:**

Refer to current price list for availability of cataloged items. Quotations and delivery of non-stock items supplied on request. Configurations and dimensions subject to change without notice. Additional information can be found in SAE J512.

**Assembly Instructions:**

1. Cut tubing to desired length.
2. Slide nut and then sleeve on tube. Threaded end "A" of nut must face toward connector.
3. Insert tubing into connector body. Be sure tubing is bottomed on connector shoulder.
4. Lubricate threads and assemble nut to connector body.
5. Tighten nut hand tight. From that point, tighten with a wrench the number of turns indicated in the chart below.

Tube Size	Additional turns From Hand Tight
1/8" thru 1/4"	1-1/4
5/16"	1-3/4
3/8" thru 1"	2-1/4

**Label Set:**

W-8022 (adhesive)  
CL-490 (non-adhesive)

# Brass Products Compression

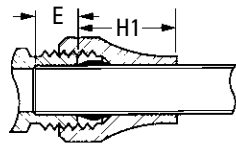
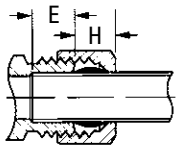

H and H1 are hand tight dimensions.

Tube O.D.	E Tube Stop Depth	H	H1 (Long Nut)
1/8	0.19	0.23	–
3/16	0.22	0.25	0.47
1/4	0.25	0.29	0.56
5/16	0.28	0.30	0.66
3/8	0.31	0.27	0.70
1/2	0.38	0.42	0.88
5/8	0.38	0.42	0.92
3/4	0.44	0.49	1.18

## Tube Support for Plastic Tubing

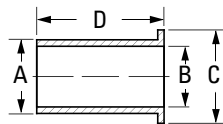
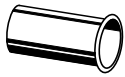

Use only with PT200 and PT240 Tubing.

Tube O.D.	Catalog Number	DIA. A	DIA. B	DIA. C	Length D
1/4	2030x4*	1/8	3/32	11/64	19/32
1/4	2030x4**	11/64	9/64	7/32	17/32
5/16	2030x5	3/16	5/32	15/64	5/8
3/8	2030x6	1/4	7/32	11/32	41/64
1/2	2030x8	3/8	11/32	7/16	13/16
5/8	2030x10	1/2	29/64	35/64	13/16
3/4	2030x12	9/16	33/64	11/16	1-1/32

\* For Tubing with .126 I.D./062 wall thickness.

\*\* For tubing with .170 I.D./040 wall thickness.

## Compression Sleeve (Ref. SAE No. 060115)

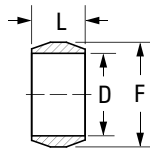

Tube O.D.	Catalog Number	D	F	L
1/8	60x2	0.13	0.19	0.19
3/16	60x3	0.19	0.27	0.22
1/4	60x4	0.26	0.34	0.25
5/16	60x5	0.32	0.41	0.25
3/8	60x6	0.38	0.47	0.25
7/16	60x7	0.44	0.53	0.31
1/2	60x8	0.51	0.59	0.38
5/8	60x10	0.63	0.72	0.38
3/4	60x12 ♦	0.76	0.88	0.44

♦MTO - Made To Order

## Nut (Ref. SAE No. 060110)

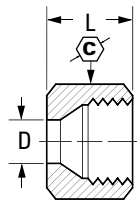
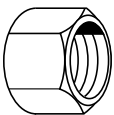

Tube O.D.	Catalog Number	C	D	L
1/8	61x2	3/8	0.13	0.38
3/16	61x3	7/16	0.19	0.41
1/4	61x4	1/2	0.26	0.44
5/16	61x5	9/16	0.32	0.44
3/8	61x6	5/8	0.38	0.47
7/16	61x7	11/16	0.44	0.50
1/2	61x8	13/16	0.51	0.62
5/8	61x10	15/16	0.63	0.62
5/8	61x12 ♦	1-3/16	0.76	0.69

♦MTO - Made To Order

# Brass Products Compression

## Long Nut

(Ref. SAE No. 060111)

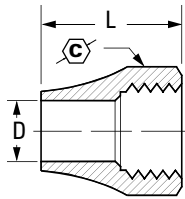
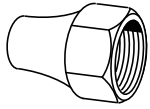

## Bulkhead Nut

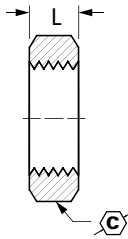
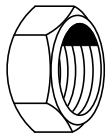

Used on 74x Bulkhead Unions.  
Ref. page 47.

## Union

(Ref. SAE No. 060101BA)

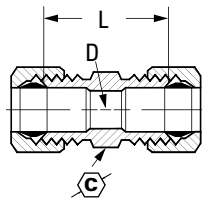
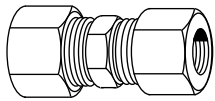

Assembly with long nut 162x.  
Not available in the x3 style.

## Male Connector

(Ref. SAE No. 060102BA)

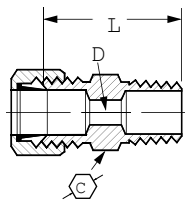
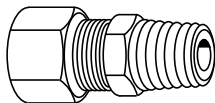

Assembly with long nut 168x.

Tube O.D.	Catalog Number		D	L
3/16	1611x3		.193	0.62
1/4	1611x4		.260	0.75
5/16	1611x5 ♦		.320	0.84
3/8	1611x6		.380	0.88
1/2	1611x8 ♦		.510	1.06
5/8	1611x10 ♦		.637	1.08
3/4	1611x12 ♦		.760	1.38

♦MTO - Made To Order

Tube O.D.	Catalog Number		L	Thread size
1/4	0102x4		0.25	7/16-24
3/8	0102x6		0.25	9/16-24
1/2	0102x8		0.38	11/16-20

Tube O.D.	Catalog Number		D	L
1/8	62x2		.094	0.66
3/16	62x3		.125	0.76
1/4	62x4		.188	0.79
5/16	62x5		.250	0.88
3/8	62x6		.312	0.97
1/2	62x8		.406	1.10
5/8	62x10		.500	1.25
3/4	62x12 ♦		.562	1.44

♦MTO - Made To Order

Tube O.D.	Male Pipe Thread	Catalog Number		D	D1 OPT.	L
1/8	1/16	68x2x1	3/8	.094	-	0.78
1/8	1/8	68x2	7/16	.094	.094	0.78
3/16	1/8	68x3	7/16	.125	.125	0.84
1/4	1/8	68x4	7/16	.188	.188	0.88
1/4	1/4	68x4x4	9/16	.188	.312	1.06
5/16	1/8	68x5	1/2	.250	.234	0.91
5/16	1/4	68x5x4	9/16	.250	.250	1.09
3/8	1/8	68x6x2	9/16	.312	.250	0.97
3/8	1/4	68x6	9/16	.312	.312	1.17
3/8	3/8	68x6x6	11/16	.312	.312	1.16
3/8	1/2	68x6x8	7/8	.312	.562	1.34
1/2	1/4	68x8x4	11/16	.406	.281	1.22
1/2	3/8	68x8	11/16	.406	.406	1.22
1/2	1/2	68x8x8	7/8	.406	.406	1.41
5/8	1/2	68x10	7/8	.500	.500	1.50
3/4	1/2	68x12 ♦	1	.562	.562	1.62
3/4	3/4	68x12x12 ♦	1-1/16	.562	.875	1.62

♦MTO - Made To Order

# Brass Products Compression

## Female Connector (Ref. SAE No. 060103BA)

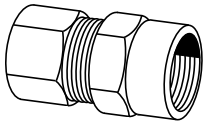

Assembly with long nut 166x.

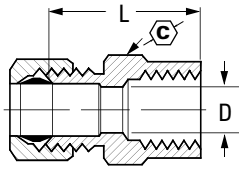

## Male Ball Check Connector

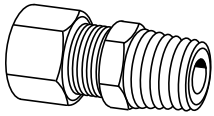

Assembly with long nut 163x. Min. working pressure 3 psi. Ball and spring position may be reversed to change flow/check direction. Ball check valves are neither tested nor adjusted prior to sale.

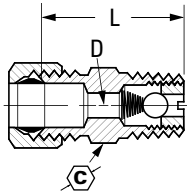

## Bulkhead Union

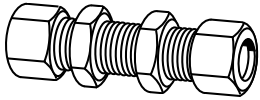

Assembly with long nut 174x. For Bulkhead Nuts, ref. page 48, included with assembly.

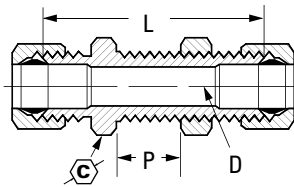

Tube O.D.	Fem. Pipe Thread	Catalog Number		D	L
1/8	1/8	66x2	9/16	.094	0.75
3/16	1/8	66x3	9/16	.125	0.78
1/4	1/8	66x4	9/16	.188	0.78
1/4	1/4	66x4x4	11/16	.188	1.03
5/16	1/8	66x5	9/16	.250	0.81
5/16	1/4	66x5x4 ♦	11/16	.250	1.03
3/8	1/8	66x6x2	9/16	.312	0.84
3/8	1/4	66x6	11/16	.312	1.06
1/2	3/8	66x8	13/16	.406	1.12

♦MTO - Made To Order

Tube O.D.	Male Pipe Thread	Catalog Number		D	L
1/4	1/8	63x4	7/16	.125	0.88
3/8	1/4	63x6	9/16	.219	1.16

Tube O.D.	Catalog Number		D	L	Max. P
1/4	74x4	9/16	.188	1.57	0.52
3/8	74x6 ♦	11/16	.312	1.76	0.55

♦MTO - Made To Order

# Brass Products Compression

## 90° Male Elbow

(Ref. SAE No. 060202BA)

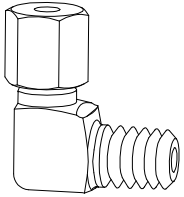

Assembly with long nut 169x.

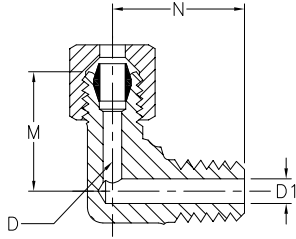

Tube O.D.	Male Pipe Thread	Catalog Number	D	D1	M	N
1/8	1/16	69x2x1	.104	.125	0.54	0.66
1/8	1/8	69x2	.094	.219	0.60	0.67
3/16	1/8	69x3	.125	.219	0.62	0.69
1/4	1/8	69x4	.188	.219	0.62	0.75
1/4	1/4	69x4x4	.188	.188	0.63	0.84
5/16	1/8	69x5	.250	.234	0.62	0.75
5/16	1/4	69x5x4	.202	.344	0.69	0.84
3/8	1/8	69x6x2	.312	.234	0.69	0.69
3/8	1/4	69x6	.312	.344	0.75	0.93
3/8	3/8	69x6x6	.312	.437	0.85	0.94
3/8	1/2	69x6x8	.312	.562	1.04	1.14
7/16	1/4	69x7 ♦	.312	.312	0.84	1.00
1/2	1/4	69x8x4	.406	.312	0.84	0.94
1/2	3/8	69x8	.406	.407	0.94	1.12
1/2	1/2	69x8x8	.406	.531	0.94	1.31
5/8	1/2	69x10	.500	.564	1.06	1.31
3/4	1/2	69x12 ♦	.562	.562	1.19	1.50
3/4	3/4	69x12x12 ♦	.562	.562	1.19	1.31

♦ MTO - Made To Order

## 90° Union Elbow

(Ref. SAE No. 060201BA)

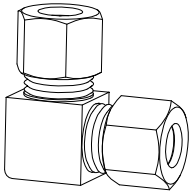

Assembly with long nut 165x.

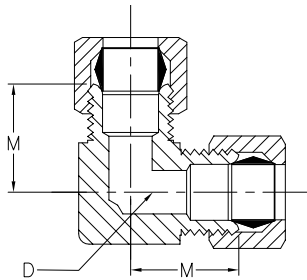

Tube O.D.	Catalog Number	D	M
1/4	65x4	.188	0.60
5/16	65x5	.250	0.62
3/8	65x6	.312	0.75
1/2	65x8	.406	0.94

## 90° Female Elbow

(Ref. SAE No. 060203BA)

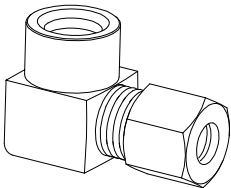

Assembly with long nut 170x.

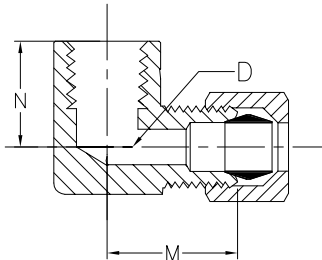

Tube O.D.	Fem. Pipe Thread	Catalog Number	D	M	N
3/16	1/8	70x3	.125	0.69	0.56
1/4	1/8	70x4	.188	0.69	0.56
3/8	1/4	70x6 ♦	.312	0.81	0.75
1/2	3/8	70x8 ♦	.406	1.00	0.88

♦ MTO - Made To Order



# Brass Products Compression

## Union Tee

(Ref. SAE No. 060401BA)

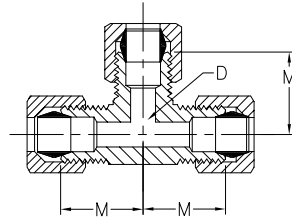
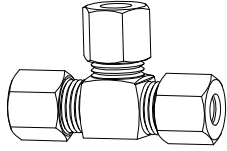

Assembly with long nut 164x.

Tube O.D.	Catalog Number	D	M
3/16	64x3	.125	0.60
1/4	64x4	.188	0.62
5/16	64x5	.250	0.67
3/8	64x6	.312	0.73
1/2	64x8	.406	0.94

## Male Run Tee

(Ref. SAE No. 060424BA)

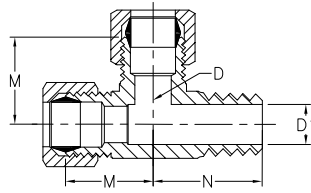
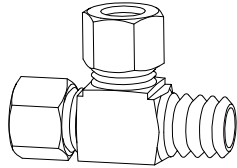

Assembly with long nut 171x.

Tube O.D.	Male Pipe Thread	Catalog Number	D	D1	M	N
3/16	1/8	71x3	.125	.219*	0.64	0.68
1/4	1/8	71x4	.188	.219*	0.63	0.75
3/8	1/4	71x6	.312	.344*	0.75	0.94

\*Optional Counterbore.

## Male Branch Tee

(Ref. SAE No. 060425BA)

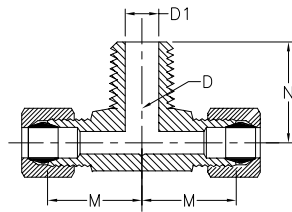
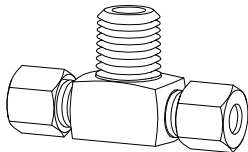

Assembly with long nut 172x.

Tube O.D.	Male Pipe Thread	Catalog Number	D	D1	M	N
3/16	1/8	72x3 ♦	.125	.219	0.62	0.69
1/4	1/8	72x4	.188	.219	0.63	0.74
1/4	1/4	72x4x4x4	.188	.281	0.78	0.85
5/16	1/8	72x5	.250	.234	0.66	0.70
3/8	1/4	72x6	.312	.344	0.78	0.91
1/2	3/8	72x8	.406	.406	0.96	1.08

♦ MTO - Made To Order

## Adapter Tee

(Female to Male Pipe on Run)

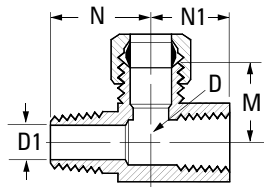
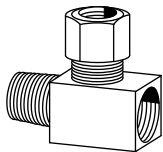

Tube O.D.	M&F Pipe Thread	Catalog Number	D	D1	M	N	N1
1/4	1/8	76x4 ♦	.188	.219	0.59	0.63	0.47

♦ MTO - Made To Order

**Note:**  
For additional technical questions, contact Technical Support at 1-888-258-0222.

 Refer to safety information regarding proper selection of tubing and tube connectors on page 3.

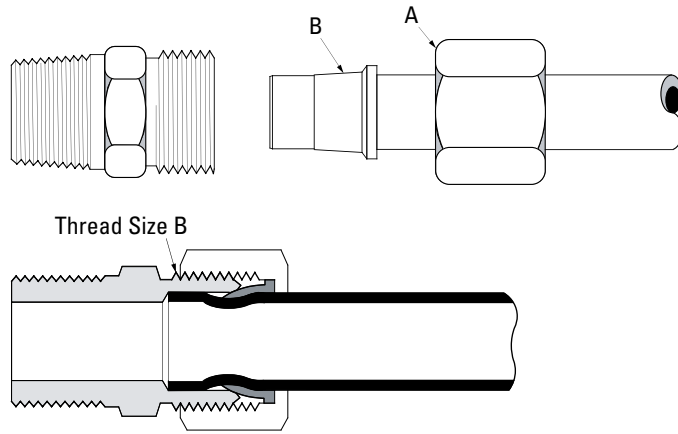

<b>Tube O.D.</b>	1/8	3/16	1/4	5/16	3/8	7/16	1/2	5/8	3/4	1
<b>Thread Size-B</b>	5/16-24	3/8-24	7/16-24	1/2-24	9/16-24	5/8-24	11/16-20	13/16-18	1-18	1-1/4-18

**Typical Application:**  
Instrumentation, hydraulic and pneumatic systems.

**Pressure:**  
Working pressure up to 2000 psi with a 4:1 safety factor depending on tube size. When using plastic tubing, use the working pressure for type used.

**Vibration:**  
Good resistance - use long nut when greater vibration resistance is needed.

**Temperature Range:**  
-65°F to +250°F (-53°C to +121°C) with metal tubing. When using compatible plastic tubing do not exceed the tubing temperature range. (Refer to tubing temperature range.)

**Material:**  
CA360 Brass.

**Used with:**  
Aluminum, copper and plastic tubing.  
Plastic tubing, except for PT230 and TP160, requires 2030x insert. Not recommended for steel tubing. See pages 25-29 for material compatibility, and pages 30-33 for plastic tubing.

**Advantages:**  
Very low cost and reusable. Self aligning - no need to disassemble fitting to line up sleeve on tube. Low cost. Easy to assemble, no flaring. Available with long or short nut. Broad selection of styles and sizes.

**Conformance:**  
An exclusive product design, user approvals only.

**How to Order:**  
Selfalign connectors are ordered as complete assemblies (body, nut and sleeve). To order assembly supplied with long nuts, simply add the prefix "1" to the catalog number. Example: 681x4 with long nut becomes 1681x4. Nuts and sleeves can be ordered separately by catalog number. To order bodies only (less nut and sleeve), prefix catalog number with the letter "B" and drop suffix number. Example: B68x4.

**Note:**  
Refer to current price list for availability of cataloged items. Quotations and delivery of non-stock items supplied on request. Configurations and dimensions subject to change without notice.

- Assembly Instructions:**
1. Cut tubing to desired length.
  2. Slide nut and then sleeve on tube. Threaded end of nut "A" and small end of sleeve "B" must face toward fitting.
  3. Insert tubing into connector body. Be sure tubing is bottomed on connector shoulder.
  4. Lubricate threads and assemble nut to connector body.
  5. Tighten with wrench to the "ring grip" point.
    - a. Ring Grip is the point when the cutting edge of the sleeve grips the tube. This is determined by turning tube slowly but firmly by hand while tightening the nut with a wrench until tube can no longer be turned by hand and a sharp increase in torque is noticed.
  6. Tighten additional turns past "ring grip" as indicated on chart. Refer to page 53.

**Label Set:**  
CL-500 (non-adhesive)

# Brass Products

## SelfAlign

### SelfAlign Assembly

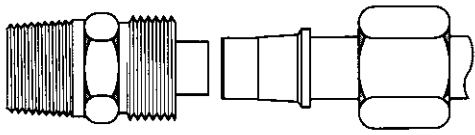

Ring Grip is the point when the cutting edge of the sleeve grips the tube. This is determined by turning tube slowly but firmly by hand while tightening the nut with a wrench until tube can no longer be turned by hand and a sharp increase in torque is noted.

### SelfAlign Assembly Data Chart

Annealed Copper and Soft Aluminum Tubing Nylon Tubing

Fitting Size	Wall	Turns*	Type "T" Thin Wall		Type "H" Thick Wall	
			Wall	Turns*	Wall	Turns*
2	.030	1-1/3	-	-	-	-
3	.030	1-1/3	.023	1-2/3	.039	1-1/3
4	.030	1-2/3	.030	2	.050	1-2/3
5	.032	1-2/3	.036	1-2/3	.062	2-2/3
6	.032	2	.040	1-2/3	.075	2
8	.032	2	-	-	-	-
10	.035	2	-	-	-	-
12	.049	2	-	-	-	-
16	.065	2-1/4	-	-	-	-

\*Turns from "Ring Grip"

### Nut Assembly Comparison

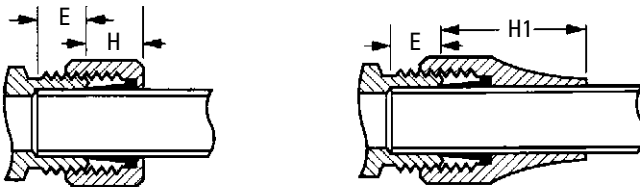

H and H1 are hand tight dimensions.

Tube O.D.	E Tube Stop H Depth	(Std. Nut)	H1 (Long Nut)
1/8	0.19	0.24	-
3/16	0.22	0.25	0.49
1/4	0.25	0.35	0.61
5/16	0.28	0.30	0.70
3/8	0.31	0.31	0.75
1/2	0.38	0.36	0.83
5/8	0.38	0.41	0.92
3/4	0.44	0.41	1.14

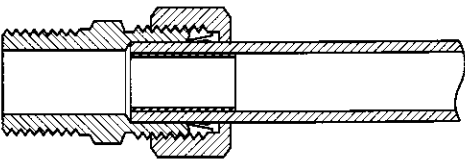

Selfalign fitting used with soft plastic tubing and brass insert.

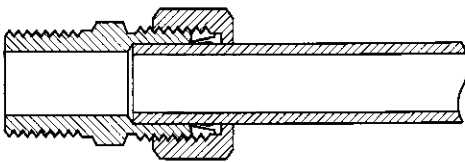

Selfalign fitting used on rigid plastic tubing, no insert.

# Brass Products

## SelfAlign

### Tube Supports for Plastic Tubing

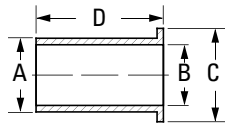
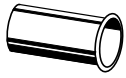

Use only with PT200 and PT240 Tubing.

### Sleeve

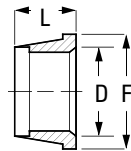

### Nut

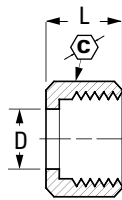
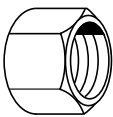

### Long Nut

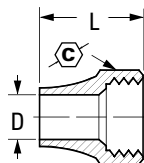
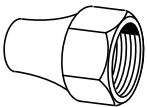

### Bulkhead Nut

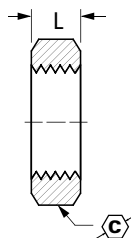
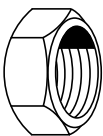



Use on 741x Bulkhead Unions.  
Ref. page 54.

Tube O.D.	Catalog Number	Dia. A	Dia. B	Dia. C	Length D
1/4	2030x4*	1/8	3/32	11/64	19/32
1/4	2030x44**	11/64	9/64	7/32	17/32
5/16	2030x5	3/16	5/32	15/64	5/8
3/8	2030x6	1/4	7/32	11/32	41/64
1/2	2030x8	3/8	11/32	7/16	13/16
5/8	2030x10	1/2	29/64	35/64	13/16
3/4	2030x12	9/16	33/64	11/16	1-1/32

\*For tubing with .126 I.D./062 wall.  
\*\*For tubing with .170 I.D./040 wall.

Tube O.D.	Catalog Number	D	F	L
1/8	601x2	0.130	0.25	0.20
3/16	601x3	0.193	0.31	0.20
1/4	601x4	0.256	0.38	0.26
5/16	601x5	0.318	0.44	0.26
3/8	601x6	0.381	0.50	0.26
1/2	601x8	0.507	0.62	0.30
5/8	601x10	0.630	0.72	0.36
3/4	601x12	0.755	0.88	0.38
1	601x16	1.005	1.19	0.50

Tube O.D.	Catalog Number		D	L
1/8	611x2	3/8	0.14	0.38
3/16	611x3	7/16	0.19	0.38
1/4	611x4	1/2	0.26	0.44
5/16	611x5	9/16	0.32	0.44
3/8	611x6	5/8	0.38	0.44
1/2	611x8	13/16	0.51	0.52
5/8	611x10	15/16	0.64	0.56

Tube O.D.	Catalog Number		D	L
3/16	1611x3	7/16	.193	0.62
1/4	1611x4	9/16	.260	0.75
3/8	1611x6	11/16	.380	0.88

Tube O.D.	Catalog Number		L
1/4	0102x4	9/16	.25
3/8	0102x6	11/16	.25
1/2	0102x8	15/16	.38

# Brass Products

## SelfAlign

### Union

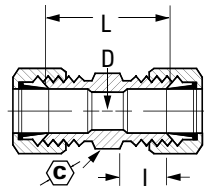
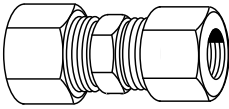

Assembly with long nut 1621x.

Tube O.D.	Catalog Number		D	I	L
1/8	621x2	5/16	.094	0.25	0.66
3/16	621x3	3/8	.125	0.28	0.76
1/4	621x4	7/16	.188	0.31	0.79
5/16	621x5	1/2	.250	0.34	0.88
3/8	621x6	9/16	.312	0.38	0.97
1/2	621x8	1 1/16	.406	0.44	1.10
5/8	621x10	1 3/16	.500	0.50	1.25

### Male Connector

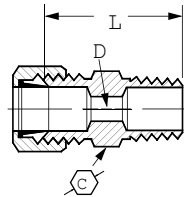
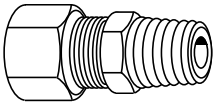

Assembly with long nut 1681x.

Tube O.D.	Male Pipe Thread	Catalog Number		D	L
1/8	1/16	681x2x1	3/8	.094	0.78
1/8	1/8	681x2	7/16	.094	0.78
3/16	1/8	681x3	7/16	.125	0.84
1/4	1/8	681x4	7/16	.188	0.88
1/4	1/4	681x4x4	9/16	.188	1.06
5/16	1/8	681x5	1/2	.234	0.91
5/16	1/4	681x5x4	9/16	.250	1.09
3/8	1/8	681x6x2	9/16	.250	0.97
3/8	1/4	681x6	9/16	.312	1.17
3/8	3/8	681x6x6	1 1/16	.312	1.16
3/8	1/2	681x6x8	7/8	.312	1.34
1/2	1/4	681x8x4	1 1/16	.281	1.22
1/2	3/8	681x8	1 1/16	.406	1.22
1/2	1/2	681x8x8	7/8	.406	1.41
5/8	1/2	681x10	7/8	.500	1.50

### Female Connector

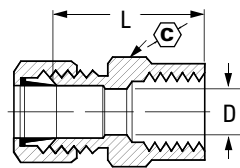
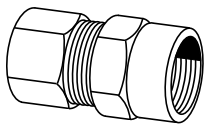

Assembly with long nut 1661x.

Tube O.D.	Fem. Pipe Thread	Catalog Number		D	L
1/8	1/8	661x2	9/16	.094	0.75
3/16	1/8	661x3	9/16	.125	0.78
1/4	1/8	661x4	9/16	.188	0.78
1/4	1/4	661x4x4	1 1/16	.188	1.03
5/16	1/8	661x5	9/16	.250	0.81
3/8	1/8	661x6x2	9/16	.312	0.84
3/8	1/4	661x6	1 1/16	.312	1.06
1/2	3/8	661x8	1 3/16	.406	1.12

### Male Ball Check Connector

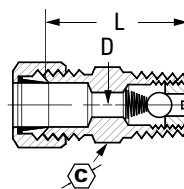
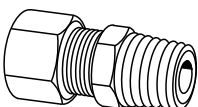

Assembly with long nut 1631x.

Min. pressure 3 psi. Ball and spring position may be reversed to change flow/check direction. Ballcheck valves are neither tested nor adjusted prior to sale.

Tube O.D.	Male Pipe Thread	Catalog Number		D	L
1/4	1/8	631x4	7/16	.125	0.88
3/8	1/4	631x6	9/16	.219	1.16

# Brass Products

## SelfAlign

### Bulkhead Union

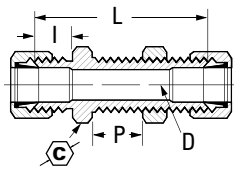
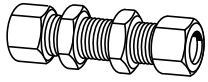

Assembly with long nut 1741x.

Tube O.D.	Catalog Number		D	I	L	Max. P
1/4	741x4	9/16	.188	0.33	1.58	0.52

### 90° Union Elbow

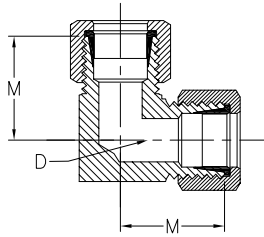
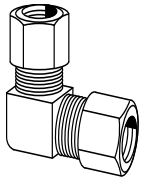

Assembly with long nut 1651x.

Tube O.D.	Catalog Number	D	M
1/4	651x4	.188	0.60
3/8	651x6	.312	0.75

### 90° Male Elbow

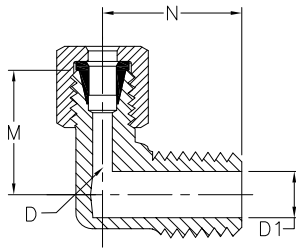
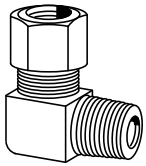

Assembly with long nut 1691x.

Tube O.D.	Male Pipe Thread	Catalog Number	D	D1	M	N
1/8	1/16	691x2x1	.109	.125	0.54	0.66
1/8	1/8	691x2	.094	.219	0.60	0.67
3/16	1/8	691x3	.125	.188	0.62	0.69
1/4	1/8	691x4	.188	.219	0.62	0.75
1/4	1/4	691x4x4	.188	.219	0.63	0.84
5/16	1/8	691x5	.250	.250	0.62	0.75
5/16	1/4	691x5x4	.250	.344	0.69	0.84
3/8	1/8	691x6x2	.312	.235	0.69	0.69
3/8	1/4	691x6	.312	.344	0.75	0.93
3/8	3/8	691x6x6	.312	.437	0.85	0.94
3/8	1/2	691x6x8	.312	.562	1.04	1.14
1/2	1/4	691x8x4	.406	.312	0.84	0.94
1/2	3/8	691x8	.406	.407	0.94	1.12
1/2	1/2	691x8x8	.406	.531	0.94	1.31
5/8	1/2	691x10	.500	.564	1.06	1.31

### 90° Female Elbow

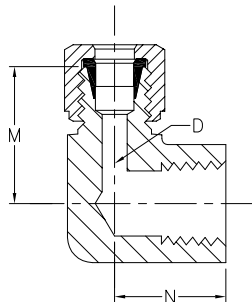
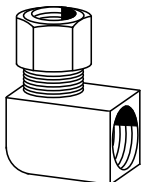

Assembly with long nut 1701x.

Tube O.D.	Fem. Pipe Thread	Catalog Number	D	M	N
3/16	1/8	701x3	.125	0.69	0.56
1/4	1/8	701x4	.188	0.69	0.56

# Brass Products

## SelfAlign

### Union Tee

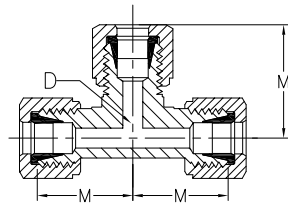
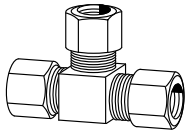

Assembly with long nut 1641x.

Tube O.D.	Catalog Number	D	M
3/16	641x3	.125	0.60
1/4	641x4	.188	0.62
5/16	641x5	.250	0.67
3/8	641x6	.312	0.73
1/2	641x8	.406	0.94

### Male Run Tee

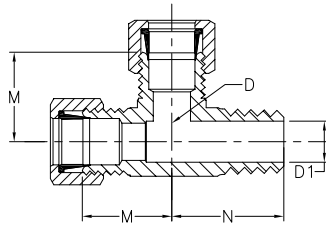
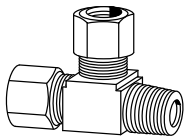

Assembly with long nut 1711x.

Tube O.D.	Male Pipe Thread	Catalog Number	D	D1 Opt.	M	N
3/16	1/8	711x3	.125	.219	0.62	0.69
1/4	1/8	711x4	.188	.219	0.63	0.75
3/8	1/4	711x6	.312	.344	0.75	0.94

### Male Branch Tee

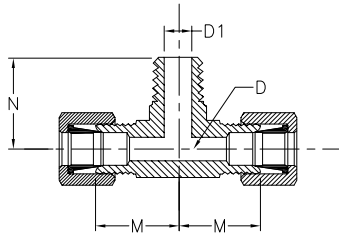
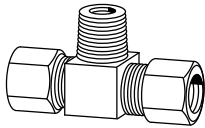

Assembly with long nut 1721x.

Tube O.D.	Male Pipe Thread	Catalog Number	D	D1	M	N
1/4	1/8	721x4	.188	.219	0.63	0.74
1/4	1/4	721x4x4x4	.188	.281	0.78	0.85
3/8	1/4	721x6	.312	.344	0.75	0.94
1/2	3/8	721x8	.406	.406	0.94	1.12

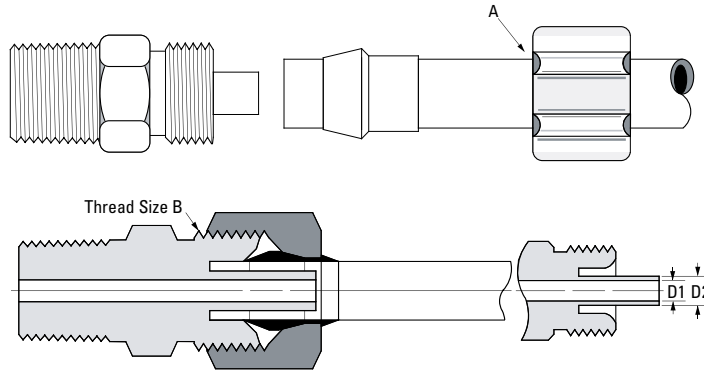

Size	x46	x4	x5	x6	x8
<b>Tube O.D.</b>	1/4	1/4	5/16	3/8	1/2
<b>Thread Size-B</b>	3/8-24	3/8-24	7/16-24	1/2-24	11/16-20
<b>Flow Dia. (D1)</b>	.078	.125	.141	.203	.312
<b>Support Dia. (D2)</b>	.120	.166	.180	.245	.370

**Typical Application:**

Pneumatic instrumentation circuits, lubricant and cooling lines.

**Pressure:**

Working pressure up to 500 psi with a 4:1 safety factor depending on tubing. When using plastic tubing, use the working pressure for type used.

**Vibration:**

Excellent resistance.

**Temperature Range:**

When using compatible plastic tubing do not exceed the tubing temperature range. (Refer to tubing temperature range.)

**Material:**

CA360 Brass body, plastic sleeve.

**Note:**

Not recommended for use with PT230, TP160 or Air Brake tubing.

**Used With:**

PT200 and PT240 plastic tubing. Not recommended for metal tubing. See pages 25-29 for material compatibility and pages 30-33 for plastic tubing.

**Advantages:**

No flaring of tubing required. Easy installation, captive sleeve, pre-assembled for installation and can be reassembled.

**Conformance:**

An exclusive product design. User approvals only.

**How to Order:**

Order 1/4" O.D. tubing with .040 wall, use suffix x4. Example: 1262x4. When .062 wall is desired, use suffix x46. Example: 1262x46.

Ordered as complete assemblies (body, nuts and sleeves) by catalog number. Nuts, sleeves and nut/sleeve assemblies can be ordered separately by catalog number.

**Note:**

Refer to current price list for availability of cataloged items. Quotations and delivery of non-stock items supplied on request. Configurations and dimensions subject to change without notice.

**Assembly Instructions:**

1. Cut tubing to desired length.
2. Slide nut/sleeve assembly on tube. Threaded end "A" of nut must face toward connector.
3. Bottom tubing into the connector.
4. Tighten nut, hand tight.

**Label Set:**

FS-2100 (adhesive)  
CL-498 (non-adhesive)

**Questions:**

For additional technical questions, contact Technical Support at 1-888-258-0222.



# Brass Products

## Polyline Flareless

### Plastic Sleeve

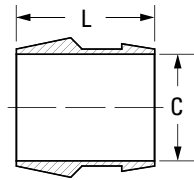
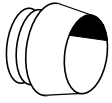

Tube O.D.	Catalog Number	C	L
1/4	1260x4	.259	0.34
5/16	1260x5	.321	0.39
3/8	1260x6	.384	0.41
1/2	1260x8	.509	0.44

### Brass Nut

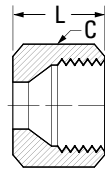

1/8" and 3/16" Nuts are flat Hex type.

Tube O.D.	Catalog Number	Dia. C	L
1/4	1261x4	7/16	0.34
5/16	1261x5 ♦	1/2	0.34
3/8	1261x6	9/16	0.38
1/2	1261x8 ♦	13/16	0.44

♦MTO - Made To Order

### Brass Nut/Plastic Sleeve Assembly

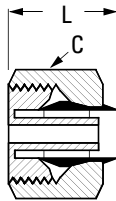
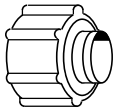

Tube O.D.	Catalog Number	Dia. C	L
1/4	1261x4A	7/16	0.43
5/16	1261x5A ♦	1/2	0.45
3/8	1261x6A	9/16	0.49
1/2	1261x8A ♦	13/16	0.46

♦MTO - Made To Order

### Brass Bulkhead Nut

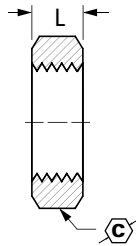
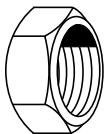



For use with 1274x Bulkhead Unions, ref. page 58.

Tube O.D.	Catalog Number	 Dia. C	L
1/4	1202x4 ♦	9/16	0.19
3/8	1202x6 ♦	11/16	0.19
1/2	1202x8 ♦	7/8	0.19

♦MTO - Made To Order

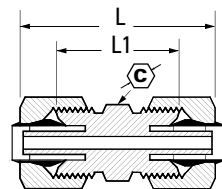
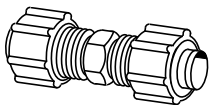
### Union



Tube O.D.	Catalog Number	 Dia. C	L	L1
1/4	1262x4	3/8	1.00	0.69
3/8	1262x6	1/2	1.03	0.72
1/2	1262x8 ♦	11/16	1.28	0.84

♦MTO - Made To Order

# Brass Products

## Polyline Flareless

### Male Connector

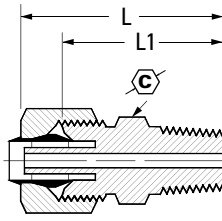
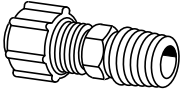

Tube O.D.	Male Pipe Thread	Catalog Number		L	L1
1/4	1/16	1268x4x1	7/16	0.97	0.81
1/4	1/8	1268x4	7/16	0.97	0.81
1/4	1/4	1268x4x4	9/16	1.15	1.00
1/4	3/8	1268x4x6 ♦	11/16	1.18	1.03
5/16	1/8	1268x5w	7/16	0.97	0.81
5/16	1/4	1268x5x4 ♦	9/16	1.16	1.00
3/8	1/8	1268x6x2	1/2	1.00	0.84
3/8	1/4	1268x6	9/16	1.19	1.03
3/8	3/8	1268x6x6	11/16	1.19	1.03
1/2	1/4	1268x8x4 ♦	11/16	1.31	1.09
1/2	3/8	1268x8	11/16	1.31	1.09
1/2	1/2	1268x8x8 ♦	11/16	1.62	1.03

♦ MTO - Made To Order

### Female Connector

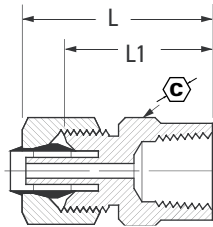
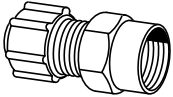

Tube O.D.	Fem. Pipe Thread	Catalog Number		L	L1
1/4	1/8	1266x4	1/2	0.87	0.72
1/4	1/4	1266x4x4	5/8	1.09	0.93
3/8	1/4	1266x6	5/8	1.09	0.94

### Bulkhead Union

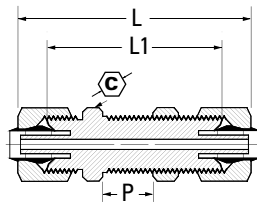
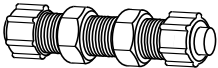

Tube O.D.	Catalog Number		L	L1	Max. P
1/4	1274x4 ♦	9/16	1.56	1.25	0.38
3/8	1274x6 ♦	11/16	1.68	1.38	0.47
1/2	1274x8 ♦	7/8	2.09	1.66	0.63

♦ MTO - Made To Order

For Bulkhead Nuts, ref. page 57.

# Brass Products

## Polyline Flareless

### Male Elbow

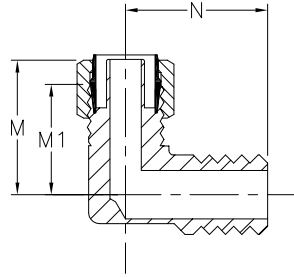
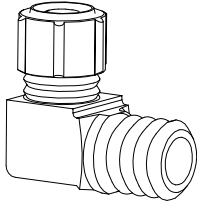

Tube O.D.	Male Pipe Thread	Catalog Number	M	M1	N
1/4	1/16	1269x4x1	0.75	0.59	0.72
1/4	1/8	1269x4	0.75	0.59	0.72
1/4	1/4	1269x4x4	0.81	0.66	0.94
1/4	3/8	1269x4x6	0.84	0.69	1.08
5/16	1/8	1269x5 ♦	0.75	0.59	0.72
3/8	1/8	1269x6x2	0.86	0.72	0.75
3/8	1/4	1269x6	0.86	0.72	0.92
3/8	3/8	1269x6x6	0.86	0.72	1.08

♦ MTO - Made To Order

### Female Elbow

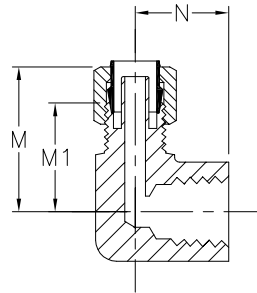
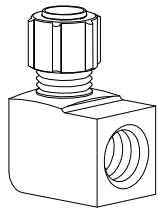

Tube O.D.	Fem. Pipe Thread	Catalog Number	M	M1	N
1/4	1/8	1270x4	0.81	0.71	0.56
1/4	1/4	1270x4x4	0.96	0.75	0.69
3/8	1/4	1270x6 ♦	0.86	0.75	0.69

♦ MTO - Made To Order

### Union Tee

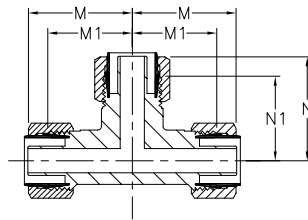
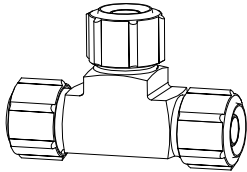

Tube O.D.	Catalog Number	M	M1	N	N1
1/4	1264x4	0.75	0.59	0.75	0.59
3/8	1264x6	0.87	0.72	0.87	0.72

### Male Run Tee

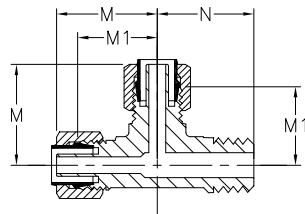
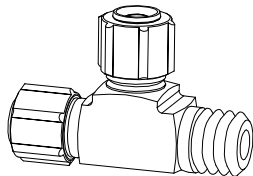

Tube O.D.	Male Pipe Thread	Catalog Number	M	M1	N
1/4	1/8	1271x4	0.75	0.59	0.72
1/4	1/4	1271x4x4x4 ♦	0.81	0.66	0.94
3/8	1/4	1271x6 ♦	0.87	0.72	1.00

♦ MTO - Made To Order

### Male Branch Tee

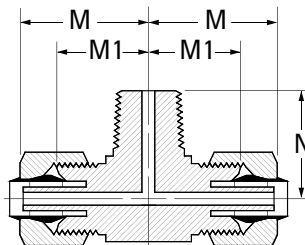
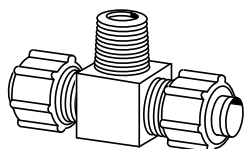

Tube O.D.	Male Pipe Thread	Catalog Number	M	M1	N
1/4	1/8	1272x4 ♦	0.75	0.59	0.72
1/4	1/4	1272x4x4x4 ♦	0.81	0.66	0.94
3/8	1/4	1272x6 ♦	0.87	0.72	1.00
1/2	3/8	1272x8 ♦	1.06	0.84	1.12

♦ MTO - Made To Order

# Brass Products

## Push>Connect

**Note:**  
For additional technical questions, contact Technical Support at 1-888-258-0222.

 Refer to safety information regarding proper selection of tubing and tube connectors on page 3.

### Push>Connect

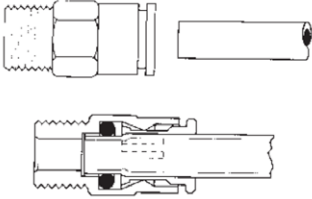

See Push>Connect Products on pages 57-61.

**Typical Application:**

Compressed air, pneumatic instrumentation, circuit, lubricant and cooling lines.

**Pressure:**

Up to 250 psi depending on tube size.

**Sealing Method:**

O-Ring of Buna-N Construction.

**Temperature Range:**

When using compatible plastic tubing do not exceed the tubing temperature range (Refer to tubing temperature range).

**Material:**

Brass, Nickel Plated.

**Vacuum:**

Fittings rated at 29.5 inches of mercury vacuum.

**Used With:**

PT230 and TP160 nylon, and PT240 Polyethylene tubing. See pages 25-29 for material compatibility and pages 30-33 for plastic tubing.

**Advantages:**

Ease of assembly. No tools required, reusability of connectors and the time savings of assembly and disassembly.

**Hex Dimensions:**

All hexes are in inches.

**How to Order:**

Individually by catalog number.

**Note:**

Refer to current price list for availability of cataloged items. Quotations and delivery of non-stock items supplied on request. Configurations and dimensions subject to change without notice.

**Assembly Instructions:**

1. To connect, simply push the tubing into the connector.
2. To disconnect, depress the collet ring with two fingers and withdraw.

**Label Set:**

CL-499 (non-adhesive)

### Push>Connect Metric

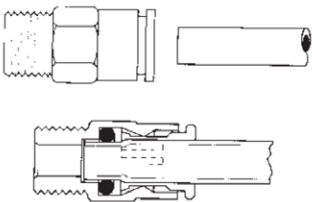

See Push>Connect Products on pages 62-65.

Nominal Size	2	4	5MM	6	8
<b>Thread</b>					
<b>MM</b>	M5 x .8				
<b>BSPT</b>	1/8 (2PT)	1/4 (4PT)		3/8 (6PT)	1/2 (8PT)
<b>BSPP</b>	1/8 (2PP)	1/4 (4PP)		3/8 (6PP)	1/2

**Typical Application:**

Compressed air, pneumatic instrumentation, circuit, lubricant and cooling lines.

**Pressure:**

Up to 250 psi depending on tube size.

**Sealing Method:**

O-Ring of Buna-N Construction.

**Temperature Range:**

-40°F to 200°F (-40°C to 93°C).

**Material:**

Brass, Nickel Plated.

**Used With:**

MTP160 nylon tubing. See pages 25-29 for material compatibility and pages 30-32 for plastic tubing.

**Advantages:**

Ease of assembly. No tools required, reusability of fittings and the time savings of assembly and disassembly.

**Hex Dimensions:**

All hexes are metric.

**How to Order:**

Individually by catalog number.

**Note:**

Refer to current price list for availability of cataloged items. Quotations and delivery of non-stock items supplied on request. Configurations and dimensions subject to change without notice.

**Assembly Instructions:**

1. To connect, simply push the tubing into the connector.
2. To disconnect, depress the collet ring with two fingers and withdraw.

**Suffix Chart:**

- MM** - Metric Screw Thread
- MMS** - Metric Screw Thread Swivel
- MRP** - Metric Red Plug
- PP** - British Parallel Plug
- PPS** - British Parallel Pipe Swivel
- PT** - British Tapered Pipe
- PTS** - British Tapered Pipe Swivel

# Brass Products

## Push>Connect

**Note:**  
For additional technical questions, contact Technical Support at 1-888-258-0222.

 Refer to safety information regarding proper selection of tubing and tube connectors on page 3.

### Push>Connect Flow Controls

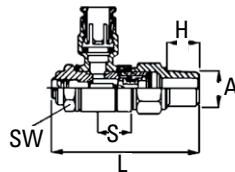
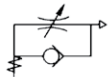
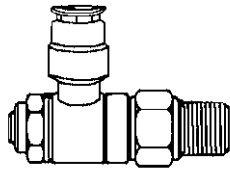

See Push>Connect Products on pages 71-72.

#### Typical Application:

Compressed air, pneumatic instrumentation, circuit, lubricant and cooling lines. Also excellent for assembly equipment and cylinder control.

#### Pressure:

Up to 250 psi depending on tube size.

#### Sealing Method:

O-Ring of Buna-N Construction. (Viton available on request by special order.)

#### Temperature Range:

0°F to +160°F  
(-17.8°C to +71°C)

#### Material:

Brass, Nickel Plated.

#### Used With:

PT230 and TP160 nylon, and PT240 Polyethylene tubing. See pages 25-29 for material compatibility and pages 30-33 for plastic tubing.

#### Advantages:

Ease of assembly. No tools required, reusability of connectors and the time savings of assembly and disassembly. These flow controls have a simple design, but offer excellent ability to control the speed of a cylinder or motor.

#### Hex Dimensions:

All hexes are in inches.

#### How to Order:

Individually by catalog number.

#### Note:

Refer to current price list for availability of cataloged items. Quotations and delivery of non-stock items supplied on request. Configurations and dimensions subject to change without notice.

#### Assembly Instructions:

1. To connect, simply push the tubing into the connector.
2. To disconnect, depress the collet ring with two fingers and withdraw.

# Brass Products

## Push>Connect

### Cartridge

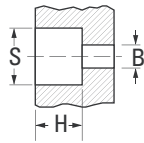

Cartridge body is not Nickel-plated.

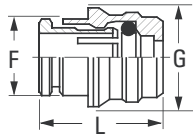

Tube O.D.	Catalog Number	F	G	L	S	H	B
1/8	1161x2	0.34	0.35	0.59	.344	.433	0.14
5/32	1161x2.5	0.34	0.35	0.57	.344	.433	0.14
1/4	1161x4	0.46	0.48	0.65	.470	.472	0.16
5/16	1161x5	0.54	0.56	0.67	.549	.551	0.25
3/8	1161x6	0.62	0.64	0.79	.627	.590	0.32
1/2	1161x8	0.74	0.76	0.83	.746	.629	0.42

### Plug

(Plastic)

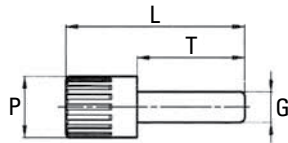

G Tube O.D.	Catalog Number	L	P	T
1/8	1129x2	1.06	0.24	0.79
5/32	1129x2.5	1.14	0.32	0.79
1/4	1129x4	1.24	0.32	0.89
5/16	1129x5	1.36	0.47	0.96
3/8	1129x6	1.46	0.47	1.06
1/2	1129x8	1.59	0.63	1.12

### Double Union

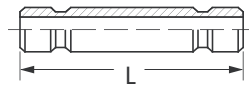
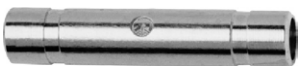

Joins Push>Connect Fittings

Tube O.D.	Catalog Number	L
1/8	1105x2	1.28
5/32	1105x2.5	1.28
1/4	1105x4	1.40
5/16	1105x5	1.59
3/8	1105x6	1.81
1/2	1105x8	1.89

### Reducer

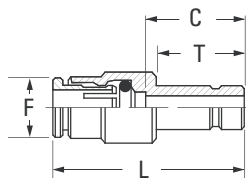

Tube O.D. A	Tube O.D. B	Catalog Number	C	F	L	T
1/8	1/4	1109x2x4	0.61	0.35	1.16	0.71
5/32	1/4	1109x2.5x4	0.61	0.35	1.16	0.71
1/4	3/8	1109x4x6	0.82	0.50	1.46	0.91
1/4	1/2	1109x4x8	0.68	0.50	1.32	0.91
3/8	1/2	1109x6x8	0.79	0.65	1.58	0.94

# Brass Products

## Push>Connect

### Stem Adapter

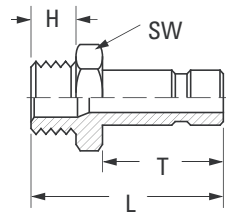
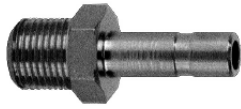

Tube O.D.	Male Pipe	Catalog Number Thread	H	T	L	SW (mm)
1/8	1/8	1180x2	0.37	0.65	1.20	12
1/8	1/4	1180x2x4	0.51	0.65	1.36	14
5/32	1/8	1180x2.5	0.37	0.65	1.20	12
5/32	1/4	1180x2.5x4	0.51	0.65	1.36	14
1/4	1/8	1180x4	0.37	0.71	1.26	12
1/4	1/4	1180x4x4	0.51	0.71	1.42	14
5/16	1/8	1180x5	0.37	0.81	1.36	12
5/16	1/4	1180x5x4	0.51	0.81	1.34	14
3/8	1/4	1180x6	0.51	0.91	1.61	17
3/8	3/8	1180x6x6	0.51	0.91	1.61	19
1/2	3/8	1180x8	0.51	0.94	1.65	19
1/2	1/2	1180x8x8	0.71	0.94	1.87	22

### Union

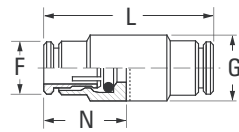

Joins tubing

Tube O.D.	Catalog Number	F	G	L	N
1/8	1162x2	0.33	0.35	1.14	0.55
5/32	1162x2.5	0.33	0.35	1.14	0.55
1/4	1162x4	0.46	0.47	1.32	0.64
5/16	1162x5	0.54	0.55	1.46	0.69
3/8	1162x6	0.61	0.66	1.61	0.79
1/2	1162x8	0.72	0.75	1.71	0.83

### Bulkhead Union

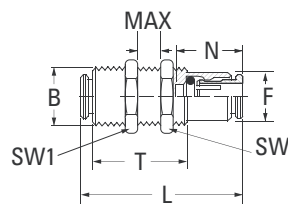
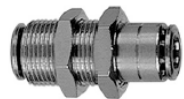

Tube O.D.	Catalog Number	B	F	L	N	MAX (mm)	SW (mm)	SW1	T
1/8	1174x2	M10x1	0.34	1.14	0.55	0.42	14	14	0.91
5/32	1174x2.5	M10x1	0.34	1.14	0.55	0.41	14	14	0.87
1/4	1174x4	M14x1	0.49	1.32	0.64	0.45	17	17	0.93
5/16	1174x5	M16x1	0.56	1.42	0.69	0.45	19	19	0.93
3/8	1174x6	M18x1	0.62	1.61	0.79	0.51	22	22	1.02
1/2	1174x8	M20x1	0.74	1.71	0.83	0.57	24	24	1.08

### Union "Y"

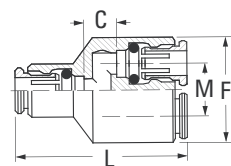

Tube O.D.	Catalog Number	C	F	L	M
1/8	1107x2	0.24	0.83	1.42	0.39
5/32	1107x2.5	0.24	0.83	1.34	0.39
1/4	1107x4	0.24	0.96	1.52	0.49

# Brass Products

## Push>Connect

### Swivel Male "Y"

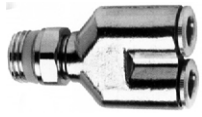

Swivel for installation purposes only

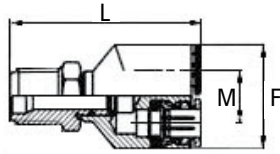

Tube O.D.	Male Pipe Thread	Catalog Number	F	M	L
1/8	10-32*	1108x2A	0.83	0.39	1.04
1/8	1/8	1108x2	0.83	0.39	1.54
5/32	1/8	1108x2.5	0.83	0.39	1.54
1/4	1/8	1108x4	0.96	0.49	1.67

\*UNF Thread. Seals with nylon washer (included).

### Male Connector

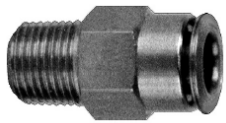

Allen wrench use permits close quarter installation not possible with a standard wrench.

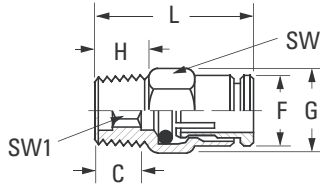

Tube O.D.	Male Pipe Thread	Catalog Number	C	F	G	H	L	SW (mm)	SW1 (mm)
1/8	1/8	1168x2	0.19	0.34	0.55	0.31	0.75	12	2.5
1/8	1/4	1168x2x4	0.35	0.34	0.62	0.47	0.90	14	2.5
5/32	1/8	1168x2.5	0.19	0.34	0.55	0.31	0.74	12	2.5
5/32	1/4	1168x2.5x4	0.35	0.34	0.62	0.49	0.90	14	2.5
1/4	1/8	1168x4	0.28	0.46	0.55	0.31	0.92	12	4
1/4	1/4	1168x4x4	0.40	0.46	0.62	0.49	1.04	14	4
1/4	3/8	1168x4x6	0.42	0.46	0.86	0.49	1.10	19	4
5/16	1/8	1168x5	0.39	0.53	0.62	0.31	1.08	14	5
5/16	1/4	1168x5x4	0.41	0.53	0.62	0.49	1.10	14	6
5/16	3/8	1168x5x6	0.41	0.53	0.86	0.49	1.10	19	6
3/8	1/8	1168x6x2	0.39	0.60	0.79	0.31	1.18	17	4
3/8	1/4	1168x6	0.55	0.60	0.79	0.47	1.34	17	7
3/8	3/8	1168x6x6	0.35	0.60	0.86	0.47	1.14	19	7
3/8	1/2	1168x6x8	0.39	0.60	1.00	0.61	1.16	22	7
1/2	3/8	1168x8	0.48	0.72	0.36	0.49	1.31	19	10
1/2	1/2	1168x8x8	0.42	0.72	1.00	0.61	1.26	22	10

\*UNF Thread. Seals with nylon washer (included).

### Female Connector

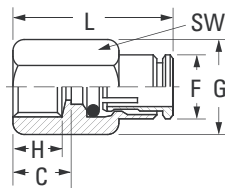
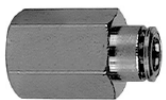

Tube O.D.	Fem. Pipe	Catalog Number Thread	C	F	G	H	L	SW (mm)
1/8	1/8	1166x2	0.39	0.35	0.51	0.34	0.95	12
1/8	1/4	1166x2x4	0.55	0.35	0.65	0.47	1.10	15
5/32	1/8	1166x2.5	0.39	0.35	0.51	0.34	0.95	12
5/32	1/4	1166x2.5x4	0.55	0.35	0.65	0.47	1.10	15
1/4	1/8	1166x4	0.39	0.46	0.51	0.34	1.02	12
1/4	1/4	1166x4x4	0.54	0.47	0.65	0.47	1.18	15
3/8	1/4	1166x6	0.51	0.60	0.73	0.47	1.30	17
3/8	3/8	1166x6x6	0.55	0.60	0.79	0.49	1.34	17

### Union Elbow

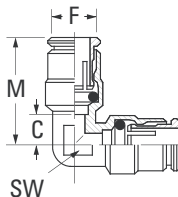

Tube O.D.	Catalog Number	C	F	M	SW (mm)
1/8	1165x2	0.14	0.35	0.69	8
5/32	1165x2.5	0.14	0.35	0.69	8
1/4	1165x4	0.16	0.50	0.79	9
5/16	1165x5	0.20	0.55	0.89	11
3/8	1165x6	0.26	0.65	1.04	13
1/2	1165x8	0.32	0.77	1.12	15



# Brass Products

## Push>Connect

### Swivel Male Elbow

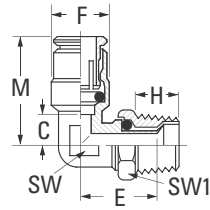

Swivel for installation purposes only

Tube O.D.	Male Pipe Thread	Catalog Number	C	E	F	H	M	SW (mm)	SW1 (mm)
1/8	1/8	1169x2S	0.14	0.65	0.35	0.32	0.69	.32	.47
1/8	1/4	1169x2x4S	0.14	0.69	0.35	0.47	0.70	.32	.55
5/32	1/8	1169x2.5S	0.14	0.65	0.35	0.32	0.69	.32	.47
1/4	1/8	1169x4S	0.16	0.67	0.50	0.32	0.79	.35	.47
1/4	1/4	1169x4x4S	0.16	0.71	0.50	0.47	0.79	.35	.55
1/4	3/8	1169x4x6S	0.16	0.67	0.50	0.47	0.79	.35	.75
5/16	1/8	1169x5S	0.20	0.71	0.55	0.32	0.87	.43	.47
5/16	1/4	1169x5x4S	0.20	0.75	0.55	0.47	0.87	.43	.55
5/16	3/8	1169x5x6S	0.20	0.73	0.55	0.47	0.87	.43	.75
3/8	1/8	1169x6x2S	0.26	0.81	0.65	0.32	1.04	.51	.55
3/8	1/4	1169x6S	0.25	0.85	0.65	0.47	1.04	.51	.55
3/8	3/8	1169x6x6S	0.26	0.83	0.65	0.47	1.04	.51	.75
3/8	1/2	1169x6x8S	0.26	0.91	0.65	0.61	1.04	.51	.87
1/2	1/4	1169x8x4S	0.32	0.91	0.77	0.47	1.12	.59	.67
1/2	3/8	1169x8S	0.32	0.87	0.77	0.47	1.12	.59	.75
1/2	1/2	1169x8x8S	0.32	0.95	0.77	0.61	1.12	.59	.87

\*UNF Thread. Seals with nylon washer (included).

### Male Elbow

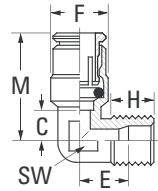

Tube O.D.	Male Pipe Thread	Catalog Number	C	E	F	H	M	SW (mm)
1/4	1/8	1169x4	0.16	0.57	0.50	0.47	0.79	9
1/4	1/4	1169x4x4	0.16	0.47	0.50	0.47	0.79	9
3/8	1/4	1169x6	0.26	0.55	0.65	0.47	1.04	13
3/8	3/8	1169x6x6	0.26	0.51	0.65	0.47	1.04	13

### Union Tee

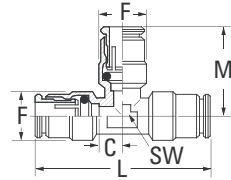

Tube O.D.	Catalog Number	C	F	L	M	SW (mm)
1/8	1164x2	0.14	0.35	1.38	0.69	8
5/32	1164x2.5	0.14	0.35	1.38	0.69	8
1/4	1164x4	0.16	0.50	1.57	0.79	9
5/16	1164x5	0.20	0.55	1.77	0.89	11
3/8	1164x6	0.26	0.65	2.09	1.04	13
1/2	1164x8	0.32	0.77	2.24	1.12	15

### Male Run Tee Swivel

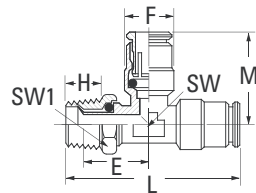

Swivel for installation purposes only

Tube O.D.	Male Pipe Thread	Catalog Number	E	F	H	L	M	SW (mm)	SW1 (mm)
1/8	10-32*	1171x2AS	0.53	0.39	0.18	1.53	0.89	9	8
1/8	1/8	1171x2S	0.65	0.35	0.32	1.54	0.69	8	12
5/32	10-32*	1171x2.5AS	0.53	0.39	0.18	1.50	0.79	9	8
5/32	1/8	1171x2.5S	0.65	0.35	0.32	1.54	0.69	8	12
5/32	1/4	1171x2.5x4S	0.69	0.35	0.26	1.63	0.69	8	14
1/4	1/8	1171x4S	0.67	0.46	0.49	1.65	0.79	9	12
1/4	1/4	1171x4x4S	0.71	0.50	0.32	1.75	0.79	9	14
1/4	3/8	1171x4x6S	0.69	0.50	0.47	1.77	0.79	9	19
3/8	1/4	1171x6S	0.85	0.65	0.47	2.15	1.04	13	14
3/8	3/8	1171x6x6S	0.83	0.65	0.47	2.17	1.04	13	19
3/8	1/2	1171x6x8S	0.91	0.65	0.61	2.28	1.04	13	22
1/2	1/4	1171x8x4S	0.91	0.79	0.47	2.29	1.12	15	13
1/2	3/8	1171x8S	0.87	0.79	0.47	2.29	1.12	15	19
1/2	1/2	1171x8x8S	0.95	0.79	0.61	2.40	1.12	15	22

\*UNF Thread. Seals with nylon washer (included).

# Brass Products

## Push>Connect

### Male Branch Tee Swivel

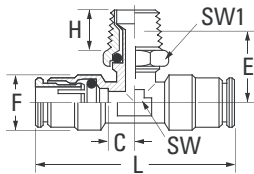

Swivel for installation purposes only

Tube O.D.	Male Pipe Thread	Catalog Number	C	E	F	H	I	SW	SW1
1/8	10-32*	1172x2AS	0.24	0.53	0.39	0.18	1.61	0.35	0.32
1/8	1/8	1172x2S	0.14	0.65	0.35	0.32	1.38	0.32	0.47
5/32	10-32*	1172x2.5AS	0.24	0.56	0.39	0.18	1.57	0.35	0.32
5/32	1/8	1172x2.5S	0.14	0.65	0.35	0.32	1.38	0.32	0.47
5/32	1/4	1172x2.5x4S	0.14	0.67	0.35	0.47	1.38	0.32	0.55
1/4	1/8	1172x4S	0.16	0.67	0.50	0.32	1.57	0.35	0.47
1/4	1/4	1172x4x4S	0.16	0.71	0.50	0.47	1.57	0.35	0.55
1/4	3/8	1172x4x6S	0.16	0.69	0.50	0.47	1.57	0.35	0.75
3/8	1/4	1172x6S	0.26	0.85	0.65	0.47	2.09	0.51	0.55
3/8	3/8	1172x6x6S	0.26	0.83	0.65	0.47	2.09	0.51	0.75
3/8	1/2	1172x6x8S	0.26	0.91	0.65	0.61	2.09	0.51	0.87
1/2	1/4	1172x8x4S	0.32	0.91	0.77	0.47	2.24	0.59	0.67
1/2	3/8	1172x8S	0.32	0.89	0.77	0.47	2.24	0.59	0.75
1/2	1/2	1172x8x8S	0.32	0.95	0.77	0.61	2.24	0.59	0.87

\*UNF Thread. Seals with nylon washer (included).

### Stud Manifolds

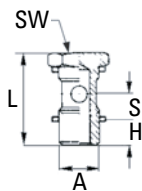

Male Pipe Thread A	Catalog Number	H	L	S	SW
10-32*	1184x1xA	0.16	0.71	0.18	0.32
1/8	1184x1x2	0.24	1.06	0.34	0.55
3/8	1184x1x6	0.35	1.18	0.34	0.75

\*UNF Thread. Seals with nylon washer (included).

### Stud Manifolds

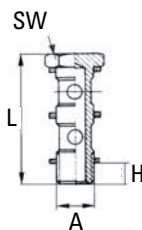

Male Pipe Thread A	Catalog Number	H	L	SW
1/4	1185x2x4	0.32	1.79	0.67

### Banjo

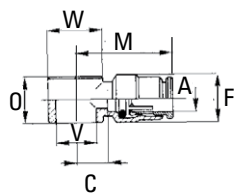

Tube O.D. A	Catalog Number	C	F	M	O	V	W
5/32	1181x2.5A	0.20	0.35	0.75	0.35	0.20	0.35
1/8	1181x2x2	0.32	0.39	0.89	0.57	0.39	0.55
1/4	1181x4x2	0.35	0.50	0.98	0.57	0.39	0.55
1/4	1181x4x4	0.43	0.50	1.06	0.57	0.52	0.71

### Female Banjo

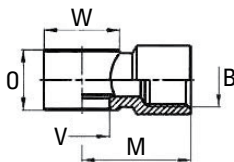

Female Pipe Thread B	Catalog Number	V	O	M	W
10-32*	1183xAxA	10-32	0.35	0.41	0.35
1/8	1183x2x2	1/8	0.57	0.79	0.55
1/4	1183x4x4	1/4	0.57	1.00	0.71
3/8	1183x6x6	3/8	0.57	1.10	0.83

\*UNF Thread. Seals with nylon washer (included).

# Brass Products

## Push>Connect Metric

### Cartridge

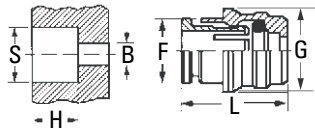

Tube O.D. (mm)	Catalog Number	F	G	L	S	H	B
5	1161x5M	9.60	10.0	15.5	9.750	11.5	3.5
6	1161x6M	11.8	12.2	16.5	11.95	12.0	4.0
8	1161x8M	13.8	14.2	18.0	13.95	14.0	6.0

### Plug (plastic)

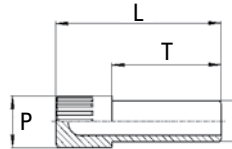

Tube O.D. (mm)	Catalog Number	L	P	T
4	1129x4MRP	29.0	8	20.0
5	1129x5MRP	29.5	8	20.5
6	1129x6MRP	31.5	8	22.5
8	1129x8MRP	34.5	12	24.5
10	1129x10MRP	37.0	12	27.0
12	1129x12MRP	40.5	16	28.5

### Double Union

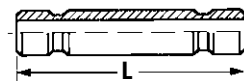

Joins Metric Push>Connect fittings

Tube O.D. (mm)	Catalog Number	L
4	1105x4M	32.5
6	1105x6M	35.5
8	1105x8M	40.5
10	1105x10M	46.0

### Reducer



A B

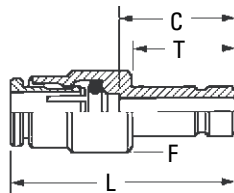

Tube OD. A (mm)	Tube OD. B (mm)	Catalog Number	C	F	L	T
4	6	1109x4Mx6M	15.5	9	29.5	18.0
6	8	1109x6Mx8M	18.0	13	34.0	20.5
6	10	1109x6Mx10M	20.5	13	36.5	23.0
8	10	1109x8Mx10M	20.5	14	39.0	23.0
8	12	1109x8Mx12M	21.5	14	39.0	24.0

### Stem Adapter

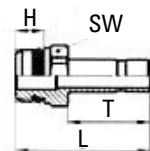

Tube OD. BSPP D (mm)	Thd. Size	Catalog Number	H	T	L	SW
4	1/8	1180x4Mx2PP	5.5	16.5	27.8	12
5	1/8	1180x5Mx2PP	5.5	18.0	29.3	12
6	1/8	1180x6Mx2PP	5.5	18.0	29.3	12
6	1/4	1180x6Mx4PP	7.0	18.0	31.0	14
8	1/8	1180x8Mx2PP	5.5	20.5	31.8	12
8	1/4	1180x8Mx4PP	7.0	20.5	33.5	14
10	1/4	1180x10Mx4PP	7.0	23.0	36.0	14
10	3/8	1180x10Mx6PP	8.0	23.0	37.3	19
12	3/8	1180x12Mx6PP	8.0	24.0	38.3	19

### Union



Joins metric tubing

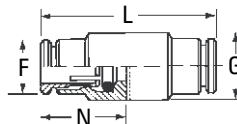

Tube OD.(mm)	Catalog Number	F	G	L	N
4	1162x4M		8.40	9	29.0
5	1162x5M		9.80	11	32.0
6	1162x6M		11.7	12	34.0
8	1162x8M		13.7	14	37.0
10	1162x10M		15.4	17	41.5
12	1162x12M		18.3	19	43.5

# Brass Products

## Push>Connect Metric

### Bulkhead Union

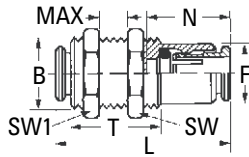

### Union "Y"

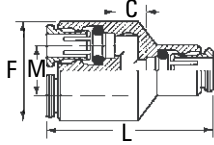

### Male "Y"

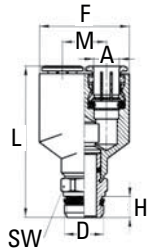

### Male Connector (Universal BSPT/BSPP)



Allen wrench use permits close quarter installation not possible with a standard wrench.

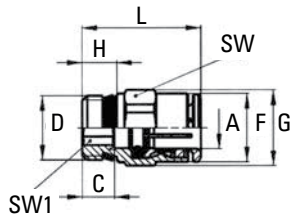

### Male Connector

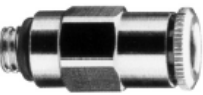

Allen wrench use permits close quarter installation not possible with a standard wrench.

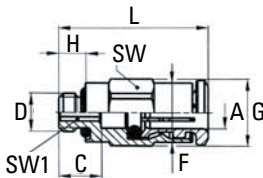

### Female Connector (BSPP)

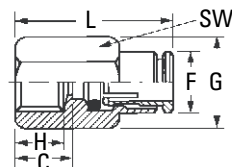
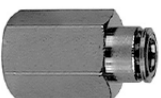

Tube OD.(mm)	Catalog Number	B	F	L	N	MAX	SW (mm)	SW1 (mm)	T
4	1174x4M	M10x1	8.40	29.0	14.5	10.5	14	14	20.0
5	1174x5M	M12x1	9.80	31.0	15.0	10.5	17	17	20.0
6	1174x6M	M14x1	11.7	33.0	16.0	10.5	17	17	20.0
8	1174x8M	M16x1	13.7	36.0	17.5	11.5	19	19	21.0
10	1174x10M	M18x1	15.4	41.5	20.0	13.0	22	22	23.5
12	1174x12M	M20x1	18.3	43.5	21.0	14.5	24	24	25.0

Tube O.D. (mm)	Catalog Number	F	C	L	M
4	1107x4M	18.0	5.0	33.0	9.0
6	1107x6M	24.5	7.0	39.0	12.5
8	1107x8M	28.5	9.0	44.0	14.5
10	1107x10M	32.0	15.5	53.5	16.0

Tube O.D. (mm) A	Thread Size BSP D	Catalog Number	F	H	M	L	SW (mm)
4	1/8	1108x4Mx2PT	18.0	5.5	9	38.0	12
6	1/8	1108x6Mx2PT	24.5	5.5	12.5	41.5	12

\*M5x0.8 metric screw thread. Seals with nylon washer (included).

Tube O.D. (mm) A	Thread Size BSP D	Catalog Number	C	F	G	H	L	SW (mm)	SW1 (mm)
4	1/8	1168x4Mx2PT	3.8	8.80	13.2	5.5	18.0	12	2.5
4	1/4	1168x4Mx4PT	6.0	8.80	15.2	7.0	19.5	14	2.5
5	1/8	1168x5Mx2PT	3.8	9.80	13.2	5.5	19.0	12	3.0
5	1/4	1168x5Mx4PT	5.5	9.80	15.2	7.0	20.0	14	3.0
6	1/8	1168x6Mx2PT	5.0	11.7	13.2	5.5	20.5	12	4.0
6	1/4	1168x6Mx4PT	5.5	11.7	15.2	7.0	21.0	14	4.0
8	1/8	1168x8Mx2PT	7.5	13.7	15.2	5.5	25.0	14	5.0
8	1/4	1168x8Mx4PT	6.5	13.7	15.2	7.0	24.0	14	6.0
8	3/8	1168x8Mx6PT	6.5	13.7	20.5	8.0	23.5	19	6.0
10	1/4	1168x10Mx4PT	8.5	16.3	18.5	7.0	28.5	17	7.0
10	3/8	1168x10Mx6PT	5.5	16.3	20.5	8.0	25.5	19	8.0
10	1/2	1168x10Mx8PT	5.0	16.3	24.5	9.0	25.0	22	8.0
12	1/4	1168x12Mx4PT	10.5	18.3	20.5	7.0	31.5	19	7.0
12	3/8	1168x12Mx6PT	9.5	18.3	20.5	8.0	30.5	19	9.0
12	1/2	1168x12Mx8PT	6.0	18.3	24.5	9.0	27.0	22	10.0

Tube O.D. (mm) A	Thread Size BSPP	Catalog Number	C	F	G	H	L	SW (mm)	SW1 (mm)
5	M5*	1168x5Mx5MM	5.5	8.8	9.9	3.5	20.5	9	2
6	M5*	1168x6Mx5MM	5.5	11.7	13.2	3.5	21.5	12	2

\*M5x0.8 metric screw thread. Seals with nylon washer (included).

Tube O.D. (mm) A	Thread Size BSPP	Catalog Number	C	F	G	H	L	SW (mm)
4	1/8	1166x4Mx2PP	10.0	9.0	13.0	7.5	24.0	12
4	M5*	1166x4Mx5MM	6.5	7.8	8.8	5.0	20.5	8
6	1/8	1166x6Mx2PP	10.0	11.7	13.0	7.5	26.0	12
6	1/4	1166x6Mx4PP	11.5	11.9	16.5	11.0	27.5	15
8	1/8	1166x8Mx2PP	9.5	13.7	15.2	7.5	27.0	14
8	1/4	1166x8Mx4PP	11.5	13.7	16.5	11.0	29.0	15
10	1/4	1166x10Mx4PP	11.5	15.7	18.5	11.0	31.5	17

\*M5x0.8 is M profile thread. Seals with nylon washer (included).

# Brass Products

## Push>Connect Metric

### Union Elbow

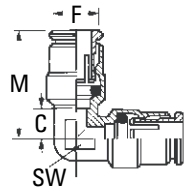

Tube O.D. (mm)	Catalog Number	C	F	M	SW (mm)
4	1165x4M	3.5	9.0	17.5	8
5	1165x5M	6.0	11.0	21.0	9
6	1165x6M	4.0	12.7	20.0	9
8	1165x8M	5.0	14.0	22.5	11
10	1165x10M	6.5	16.5	26.5	13
12	1165x12M	7.5	19.5	28.5	15

### Male Elbow (Universal BSPT/BSPP)

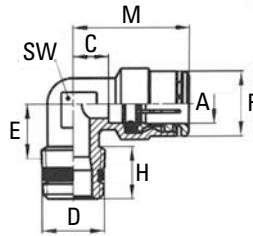

Tube O.D. A (mm)	Thread Size BSP D	Catalog Number	C	E	F	H	M	SW (mm)
4	1/8	1169x4Mx2PT	3.5	8.5	9.0	7.5	17.5	8
4	1/4	1169x4Mx4PT	6.0	11.5	10.0	12	20.0	9
5	1/8	1169x5Mx2PT	6.0	9.5	11.0	7.5	21.0	9
5	1/4	1169x5Mx4PT	6.0	10.5	11.0	11.0	21.0	9
6	1/8	1169x6Mx2PT	4.0	9.0	12.7	7.5	20.0	9
6	1/4	1169x6Mx4PT	4.0	11.5	12.7	12	20.0	9
8	1/8	1169x8Mx2PT	5.0	10.5	14.0	7.5	22.5	11
8	1/4	1169x8Mx4PT	5.0	11.5	14.0	12.5	22.5	11
8	3/8	1169x8Mx6PT	7.5	13.0	15.0	11.5	25.0	12
10	1/4	1169x10Mx4PT	6.5	13.0	16.5	12	26.5	13
10	3/8	1169x10Mx6PT	6.5	12.5	16.5	11.5	26.5	13
12	1/4	1169x12Mx4PT	7.5	14.5	19.5	12	28.5	15
12	3/8	1169x12Mx6PT	7.5	14.5	19.5	12.5	28.5	15

### Male Elbow Swivel (Universal BSPT/BSPP)

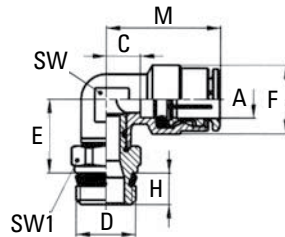

Tube O.D. A (mm)	Thread Size BSP D	Catalog Number	C	E	F	H	M	SW (mm)	SW1 (mm)
4	1/8	1169x4Mx2PTS	3.5	14.5	9.0	5.5	17.5	8	12
4	1/4	1169x4Mx4PTS	3.5	14.5	9.0	7.0	17.5	8	14
5	1/8	1169x5Mx2PTS	6.0	14.5	11.0	5.5	21.0	9	12
5	1/4	1169x5Mx4PTS	6.0	14.5	11.0	7.0	21.0	9	14
6	1/8	1169x6Mx2PTS	4.0	15.0	12.7	5.5	20.0	9	12
6	1/4	1169x6Mx4PTS	4.0	15.0	12.7	7.0	20.0	9	14
8	1/8	1169x8Mx2PTS	5.0	16.0	14.0	5.5	22.5	11	12
8	1/4	1169x8Mx4PTS	5.0	16.0	14.0	7.0	22.5	11	14
8	3/8	1169x8Mx6PTS	5.0	16.5	14.0	8.0	22.5	11	19
10	1/4	1169x10Mx4PTS	6.5	18.5	16.5	7.0	26.5	13	14
10	3/8	1169x10Mx6PTS	6.5	19.0	16.5	8.0	26.5	13	19
10	1/2	1169x10Mx8PTS	6.5	19.5	16.5	9.0	26.5	13	22
12	1/4	1169x12Mx4PTS	7.5	20.0	19.5	7.0	28.5	15	17
12	3/8	1169x12Mx6PTS	7.5	20.0	19.5	8.0	28.5	15	19
12	1/2	1169x12Mx8PTS	7.5	20.5	19.5	9.0	28.5	15	22

Swivel for installation purposes only

### Male Elbow Swivel



Swivel for installation purposes only

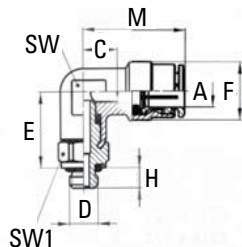

Tube O.D. A (mm)	Thread Size	Catalog Number	C	E	F	H	M	SW (mm)	SW1 (mm)
4	M5*	1169x4Mx5MMS	6	12.5	11.0	4	21	9	8
5	M5*	1169x5Mx5MMS	4	13.0	12.7	4	20	9	10

\*M5x0.8 metric screw thread. Seals with nylon washer (included).

# Brass Products

## Push>Connect Metric

### Male Run Tee Swivel (Universal BSPT/BSPP)



Swivel for installation purposes only

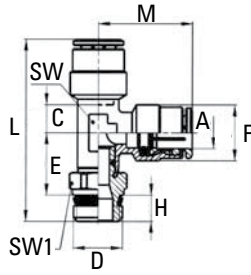

Tube O.D. A (mm)	Thd. Size BSP D	Catalog Number	C	E	F	H	I	m	SW (mm)	SW1 (mm)
4	1/8	1171x4Mx2PTS	3.5	14.5	9.0	5.5	37.5	17.5	8	12
5	1/8	1171x5Mx2PTS	6.0	14.5	11.0	5.5	41.0	21.0	9	12
5	1/14	1171x5Mx4PTS	6.0	14.5	11.0	7.0	42.5	21.0	9	14
6	1/8	1171x6Mx2PTS	4.0	15.0	12.7	5.5	40.0	20.0	9	12
6	1/4	1171x6Mx4PTS	4.0	15.0	12.7	7.0	41.5	20.0	9	14
8	3/8	1171x8Mx6PTS	5.0	16.5	14.0	8.0	47.0	22.5	13	19
10	1/4	1171x10Mx4PTS	6.5	18.5	16.5	7.0	52.0	26.5	13	14
10	3/8	1171x10Mx6PTS	6.5	18.5	16.5	8.0	53.5	26.5	15	19
12	3/8	1171x12Mx6PTS	7.5	19.5	19.5	8.0	56.5	28.5	16	19

### Union Tee

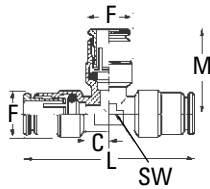

Tube O.D. (mm)	Catalog Number	C	F	L	M	SW (mm)
4	1164x4M	3.5	9.0	35	17.5	8
5	1164x5M	6.0	11.0	42	21.0	9
6	1164x6M	4.0	12.7	40	20.0	9
8	1164x8M	5.0	14.0	45	22.5	11
10	1164x10M	6.5	16.5	53	26.5	13
12	1164x12M	7.5	19.5	57	28.5	15

### Male Run Tee Swivel



Swivel for installation purposes only

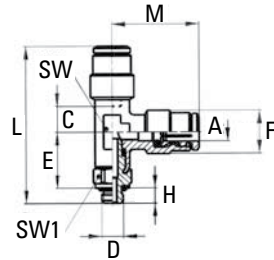

Tube O.D. A (mm)	Thd. Size	Catalog Number	C	E	F	H	I	M	SW (mm)	SW1 (mm)
4	M5*	1171x4Mx5MMS	3.5	12.5	9	4	34	17.5	8	8
5	M5*	1171x5Mx5MMS	6.0	12.5	11	4	37	21.0	9	8

\*M5x0.8 metric screw thread. Seals with nylon washer (included).

### Male Branch Tee Swivel (Universal BSPT/BSPP)



Swivel for installation purposes only

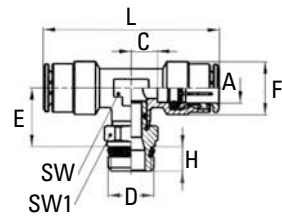

Tube O.D. A (mm)	Thread Size BSP D	Catalog Number	CE	F	H	I	(mm)	SW (mm)	SW1
4	1/8	1172x4Mx2PTS	3.5	14.5	9.0	5.5	35	8	12
5	1/8	1172x5Mx2PTS	6.0	14.5	11.0	5.5	42	9	12
5	1/4	1172x5Mx4PTS	6.0	14.5	11.0	7.0	42	9	14
6	1/8	1172x6Mx2PTS	4.0	15.0	12.7	5.5	40	9	12
6	1/4	1172x6Mx4PTS	4.0	15.0	12.7	7.0	40	9	14
8	1/8	1172x8Mx2PTS	5.0	16.0	14.0	5.5	45	11	12
8	1/4	1172x8Mx4PTS	5.0	16.0	14.0	7.0	45	11	14
8	3/8	1172x8Mx6PTS	5.0	16.5	14.0	8.0	45	11	19
10	1/4	1172x10Mx4PTS	6.5	18.5	16.5	7.0	53	13	14
10	3/8	1172x10Mx6PTS	6.5	19.0	16.5	8.0	53	13	19
12	1/4	1172x12Mx4PTS	7.5	20.0	19.5	7.0	57	15	17
12	3/8	1172x12Mx6PTS	7.5	20.0	19.5	8.0	57	15	19
12	1/2	1172x12Mx8PTS	7.5	20.5	19.5	9.0	57	15	22

### Male Branch Tee Swivel



Swivel for installation purposes only

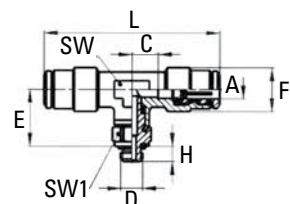

Tube O.D. A (mm)	Thread Size	Catalog Number	C	E	F	H	I	SW (mm)	SW1 (mm)
4	M5* 1172x4Mx5MMS		3.5	14.5	9	4	35	8	8

\*M5x0.8 metric screw thread. Seals with nylon washer (included).

# Brass Products

## Push>Connect Flow Controls

**Note:**  
For additional technical questions, contact Technical Support at 1-888-258-0222.

**Note:**  
We reserve the right to alter these specifications without prior notice.

**Right Angle Flow Control and Needle Valves**  
SCU-MCU

**Technical Data**

**Valve:**  
Flow Regulator

**Regulation:**  
Adjustable Screw

**Material:**  
Brass; Nickel Plated

**Seals:**  
Buna-N

**Threads:**  
10-32 UNF - 1/8 - 1/4 - 3/8 NPTF

**Tube Sizes:**  
1/8 - 5/32 - 1/4 - 3/8

**Operating Pressures:**  
to 150 PSI

**Nominal Diameter:**  
10-32 UNF = .059 - 1/8 = .078  
1/4 = .157 - 3/8 = .275

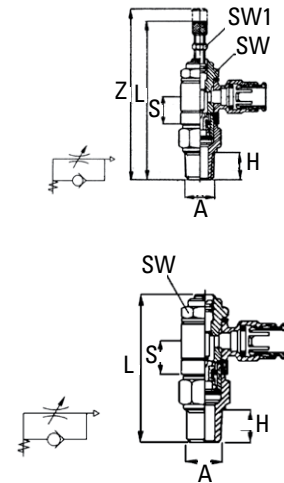

**Flow Control Valve Performance**

Air flow is determined with 85 PSI at the in port and with 70 PSI at the outlet

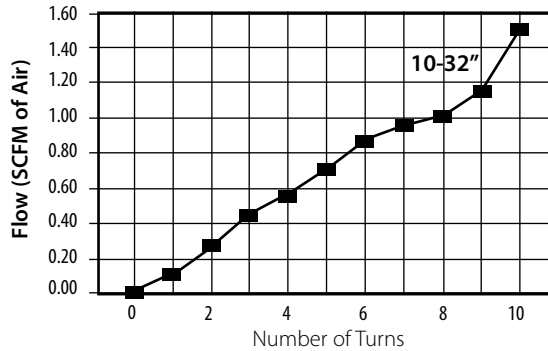

Air flow (SCFM) from B to A  
With adjustment open 1.9  
With adjustment closed 1.4

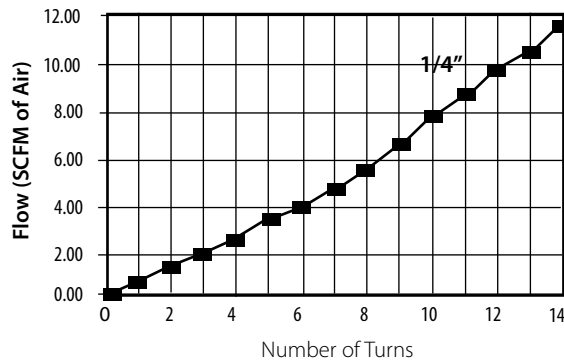
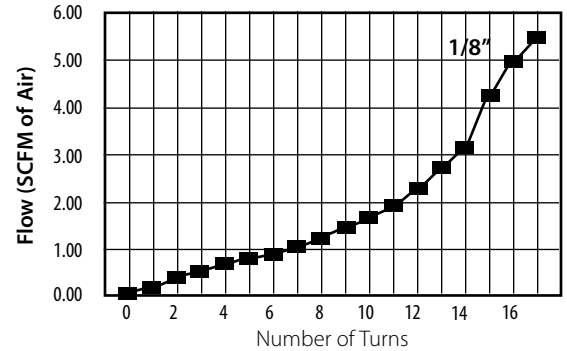

Air flow (SCFM) from B to A  
With adjustment open 15  
With adjustment closed 8

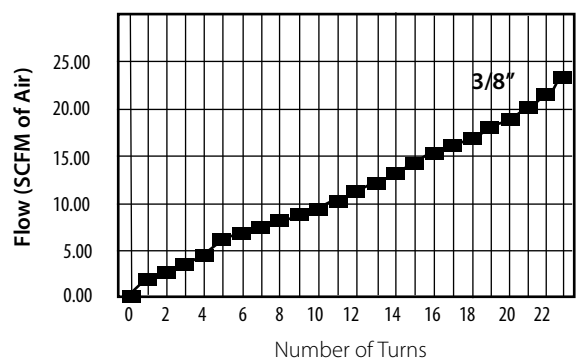

Air flow (SCFM) from B to A  
With adjustment open 23  
With adjustment closed 13

# Brass Products

## Push>Connect Flow Controls

### Identification of flow control

These unidirectional flow controllers have been designed as small as possible so as to be mounted directly on valves or cylinders.

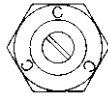

SCU  
MCU

### Coding of Banjo flow controllers

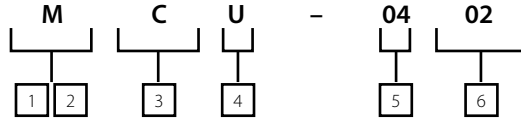

#### 1 2 Adjustment

M=Manual  
S=Screwdriver

#### 3 Assembly

C=On cylinders

#### 4 Function

U= unidirectional  
(flow control)

#### 5 Port A

#### 6 Thread B

### SCU



Port A

Thread B

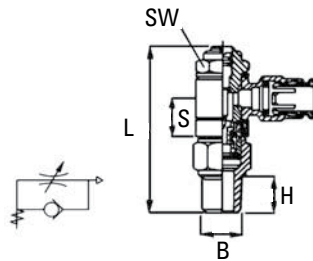

Catalog Number	Tube	B O.D.	NPTF	S	H	L	SW (mm)
A555SCUx2.5A*		5/32	10-32	0.22	0.18	1.141	8
A55SCUx2.5x2		5/32	1/8	0.51	0.37	2.000	14
A55SCUx4x2		1/4	1/8	0.51	0.37	2.000	14
A55SCUx4x4		1/4	1/4	0.45	0.51	2.250	17
A55SCUx6x4		3/8	1/4	0.45	0.51	2.250	17
A55SCUx6x6		3/8	3/8	0.48	0.51	2.440	19

\*UNF Thread

### SCU



Port A

Thread B

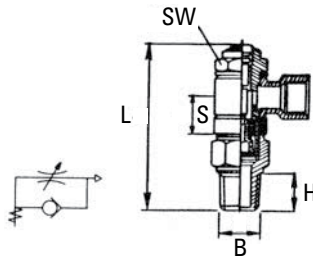

Catalog Number	Female	Banjo B Thread	NPTF	S	H	L	SW (mm)
A557SCUx4x4		1/4	1/4	0.45	0.51	2.25	17
A557SCUx6x6		3/8	3/8	0.48	0.51	2.44	19

\*UNF Thread

### MCU



Port A

Thread B

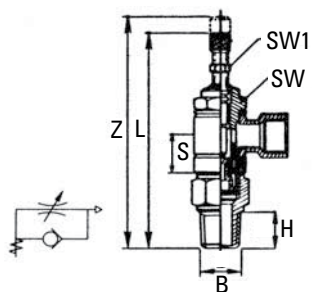

Catalog Number	Banjo Female Thread	B NPTF	S	H	L	Z	SW (mm)	SW1 (mm)
A557MCUx2x2	1/8	1/8	0.51	0.37	2.38	2.56	14	7
A557MCUx6x6	3/8	3/8	0.48	0.51	2.95	3.25	19	10



# Brass Products

## Push>Connect Plus

Danfoss is proud to announce three design changes to Push>Connect products. The introduction of a low profile, sure-seal design for male NPTF threaded fittings is here. Also, an improved collet design will allow use with all types of tubing from Nylon to 90A durometer Polyurethane, including Polyethylene, and PVC tubing. Lastly, the male swivel design provides greater strength and stability.

Below is a summary of features and benefits for the newly named Push>Connect Plus.

### Perfect thread seal:

A captured Teflon® ring around the base of the hex shoulder, seals similar to a reusable (SAE type) seal eliminates thread

sealant and loose particles associated with thread sealant.

### Lower Profile:

Push>Connect Plus has a lower profile for those tight places. A shorter thread design eliminates exposed threads where dirt and bacteria can collect (ideal for food processing and hygienic applications).

### More Versatility:

The new brass collet is designed for use with all types of tubing from Nylon to 90A durometer Polyurethane, including Polyethylene, and PVC tubing.

**Super-quick Installations:** New short thread length means fewer turns and super-quick installations.

### Note:

For additional technical questions, contact Technical Support at 1-888-258-0222.

### Improved Swivel Design:

Strength and stability have been engineered into the new male swivel.

### Universal Thread:

Use with NPT, BSPP, and BSPT ports.

The new part will have a 'P' in the part number to signify the new design. An example of this change is previous #1169x4S becomes #1169Px4S. Current Push>Connect parts with 10-32UNF threads and ending in 'A' (eg.1168x2A) will continue with the current thread design.

Swivel Male "Y"

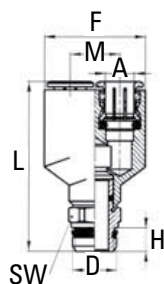

Male Connector

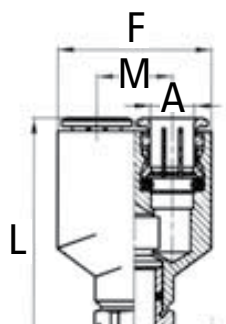

Tube O.D.	Male Pipe	Catalog Number Thread	F	H	M	L
1/8	1/8	1108Px2S	0.83	0.20	0.39	1.28
5/32	1/8	1108Px2.5S	0.83	0.20	0.39	1.28
1/4	1/8	1108Px4S	0.96	0.20	0.49	1.40

Tube O.D. A	Male Pipe Thread D	Catalog Number	F	G	H	L	SW (mm)	SW1 (mm)
1/8	10-32*	1168Px2A	0.346	0.411	0.177	0.846	9	2.0
1/8	1/8	1168Px2	0.346	0.551	0.200	0.728	12	2.5
1/8	1/4	1168Px2x4	0.346	0.629	0.255	0.807	14	2.5
5/32	10-32*	1168x2.5A	0.346	0.411	0.177	0.807	9	2.0
5/32	1/8	1168Px2.5	0.346	0.551	0.200	0.728	12	2.5
5/32	1/4	1168Px2.5x4	0.346	0.629	0.255	0.807	14	2.5
1/4	10-32*	1168x4A	0.460	0.551	0.177	0.905	12	2.0
1/4	1/8	1168Px4	0.460	0.551	0.200	0.807	12	4.0
1/4	1/4	1168Px4x4	0.460	0.629	0.255	0.846	14	4.0
1/4	3/8	1168Px4x6	0.460	0.866	0.294	0.885	19	4.0
5/16	1/8	1168Px5	0.539	0.629	0.200	0.945	14	5.0
5/16	1/4	1168Px5x4	0.539	0.629	0.255	0.945	14	6.0
5/16	3/8	1168Px5x6	0.539	0.866	0.294	0.924	19	6.0
3/8	1/8	1168Px6x2	0.610	0.776	0.200	1.082	17	5.0
3/8	1/4	1168Px6	0.610	0.776	0.255	1.102	17	7.0
3/8	3/8	1168Px6x6	0.610	0.866	0.294	0.945	19	7.0
3/8	1/2	1168Px6x8	0.610	1.004	0.335	0.984	22	7.0
1/2	3/8	1168Px8	0.720	0.866	0.294	1.161	19	10.0
1/2	1/4	1168Px8x4	0.720	0.866	0.255	1.161	19	7.0
1/2	1/2	1168Px8x8	0.720	1.004	0.335	1.062	22	10.0

\*UNF Thread

\*Teflon® is a registered trademark of DuPont used license by Danfoss.

# Brass Products

## Push>Connect Plus

### Swivel Male Elbow



Swivel for installation purposes only

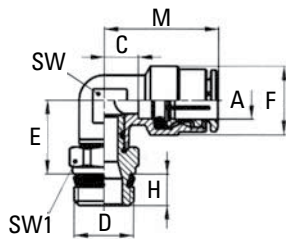

Tube O.D.	Male Pipe Thd.	Catalog Number	C	E	F	H	M	SW (mm)	SW1 (mm)
1/8	1/8	1169Px2S	0.14	0.59	0.35	0.20	0.69	8	12
1/8	1/4	1169Px2x4S	0.14	0.63	0.35	0.26	0.69	8	14
5/32	1/8	1169Px2.5S	0.14	0.59	0.35	0.20	0.69	8	12
5/32	1/4	1169Px2.5x4S	0.14	0.63	0.35	0.26	0.69	8	14
1/4	1/8	1169Px4S	0.16	0.63	0.46	0.20	0.79	9	12
1/4	1/4	1169Px4x4S	0.16	0.65	0.46	0.26	0.79	9	14
1/4	3/8	1169Px4x6S	0.16	0.65	0.46	0.29	0.79	9	19
5/16	1/8	1169Px5S	0.20	0.65	0.54	0.20	0.89	11	12
5/16	1/4	1169Px5x4S	0.20	0.69	0.54	0.26	0.89	11	14
5/16	3/8	1169Px5x6S	0.20	0.69	0.54	0.29	0.89	11	19
3/8	1/8	1169Px6x2S	0.26	0.75	0.64	0.20	1.04	13	14
3/8	1/4	1169Px6S	0.26	0.77	0.64	0.26	1.04	13	14
3/8	3/8	1169Px6x6S	0.26	0.77	0.64	0.29	1.04	13	19
3/8	1/2	1169Px6x8S	0.26	0.79	0.64	0.34	1.04	13	22
1/2	1/4	1169Px8x4S	0.32	0.81	0.72	0.26	1.12	15	17
1/2	3/8	1169Px8S	0.32	0.81	0.72	0.29	1.12	15	19
1/2	1/2	1169Px8x8S	0.32	0.83	0.72	0.36	1.12	15	22

### Male Run Tee Swivel



Swivel for installation purposes only

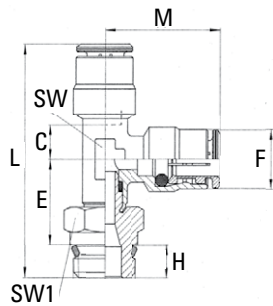

Tube O.D.	Male Pipe Thd.	Catalog Number	C	E	F	H	I	M	SW (mm)	SW1 (mm)
1/8	1/8	1171Px2S	0.14	0.59	0.35	0.20	1.46	0.69	8	12
5/32	1/8	1171Px2.5S	0.14	0.59	0.35	0.20	1.46	0.69	8	12
5/32	1/4	1171Px2.5x4S	0.14	0.63	0.35	0.26	1.57	0.69	8	14
1/4	1/8	1171Px4S	0.16	0.63	0.50	0.20	1.61	0.89	9	12
1/4	1/4	1171Px4x4S	0.16	0.65	0.50	0.26	1.70	0.79	9	14
1/4	3/8	1171Px4x6S	0.16	0.65	0.50	0.30	1.73	0.79	9	19
3/8	1/4	1171Px6S	0.26	0.77	0.65	0.26	2.07	1.04	13	14
3/8	3/8	1171Px6x6S	0.26	0.77	0.65	0.30	2.11	1.04	13	19
3/8	1/2	1171Px6x8S	0.26	0.79	0.65	0.33	2.16	1.04	13	22
1/2	1/4	1171Px8x4S	0.32	0.81	0.77	0.26	2.18	1.12	15	17
1/2	3/8	1171Px8S	0.32	0.81	0.77	0.30	2.22	1.12	15	19
1/2	1/2	1171Px8x8S	0.32	0.83	0.77	0.33	2.28	1.12	15	22

### Male Branch Tee Swivel



Swivel for installation purposes only

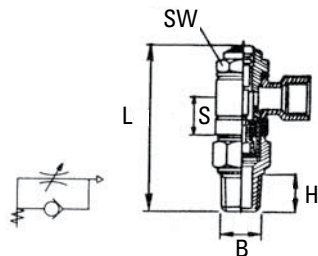

Tube O.D.	Male Pipe Thd.	Catalog Number	C	E	F	H	L	M	SW (mm)	SW1 (mm)
1/8	1/8	1172Px2S	0.14	0.59	0.35	0.20	1.38	8	12	12
5/32	1/8	1172Px2.5S	0.14	0.59	0.35	0.20	1.38	8	12	12
5/32	1/4	1172Px2.5x4S	0.14	0.63	0.35	0.26	1.38	8	14	14
1/4	1/8	1172Px4S	0.16	0.61	0.50	0.20	1.51	9	12	12
1/4	1/4	1172Px4x4S	0.16	0.65	0.50	0.26	1.51	9	14	14
1/4	3/8	1172Px4x6S	0.16	0.65	0.50	0.30	1.51	9	19	19
3/8	1/4	1172Px6S	0.26	0.77	0.65	0.26	2.09	13	14	14
3/8	3/8	1172Px6x6S	0.26	0.77	0.65	0.30	2.09	13	19	19
3/8	1/2	1172Px6x8S	0.26	0.79	0.65	0.32	2.09	13	22	22
1/2	3/8	1172Px8S	0.32	0.81	0.77	0.30	2.24	15	19	19

# Brass Products

## Mini-Barb

**Note:**  
For additional technical questions, contact Technical Support at 1-888-258-0222.

 Refer to safety information regarding proper selection of tubing and tube connectors on page 3.

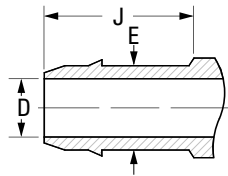
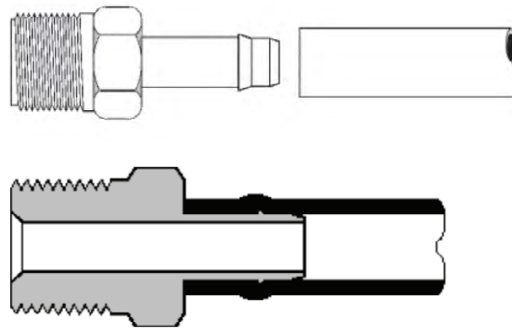

Common Dimensions of Barbed End.

Tubing O.D.	D	E	J
5/32	.062	.113	.380
*3/16	.078	.125	.500
1/4	.127	.189	.500
3/8	.196	.270	.500
1/2	.312	.395	.630

\*No barb on 3/16" size.

**Typical Application:**

Temperature control circuits, test apparatus, lubricant, coolant lines, pneumatic circuits, vacuum and fluid systems.

**Pressure:**

Will withstand burst pressures of plastic tubing.

**Vibration:**

Excellent resistance.

**Temperature Range:**

Depends on tubing used.

**Material:**

CA360 Brass.

**Used With:**

PT240 Polyethylene tubing. See pages 25-29 for material compatibility and pages 30-32 for plastic tubing.

**Advantages:**

Quick connecting - no tube preparation. Hand assembly. Low cost one-piece push-on design. Barbed lip provides safe, positive connection. Compact size permits use in extremely tight areas.

**Conformance:**

An exclusive item with Danfoss. User approvals only.

**How to Order:**

Individually by catalog number.

**Note:**

Refer to current price list for availability of cataloged items. Quotations and delivery of non-stock items supplied on request. Configurations and dimensions subject to change without notice.

**Assembly Instructions:**

1. Push the tubing over insert.
2. Bottom the tubing against connector body.

**Label Set:**

FS-1000 (adhesive)  
CL-496 (non-adhesive)

# Brass Products

## Mini-Barb

### Plug

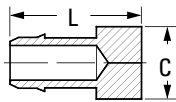
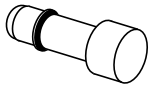

Tubing O.D.	Catalog Number	Dia. C	L
1/4	1073x4	0.31	0.75
3/8	1073x6	0.40	0.75
1/2	1073x8 ♦	0.53	0.88

♦MTO - Made To Order

### Solder Connector

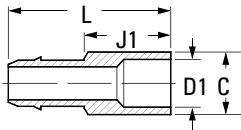
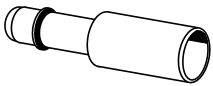

Tubing O.D.	Solder Conn.	Catalog Number	Dia. C	D1	J1	L
1/4	1/4	1079x4x4	5/16	0.25	0.50	1.00

### Union

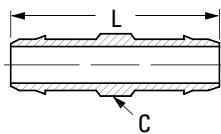
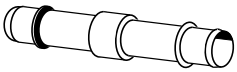

Tubing O.D.	Catalog Number	Dia. C	L
1/4x3/16*	1062x4x3	1/4	1.25
1/4	1062x4	1/4	0.81
1/4	1062x4L	1/4	1.25
3/8x1/4	1062x6x4	5/16	1.19
3/8	1062x6	5/16	1.19
1/2x1/4	1062x8x4 ♦	1/2	1.33
1/2x3/8	1062x8x6	1/2	1.33
1/2	1062x8	1/2	1.45

\*No barb on 3/16" end. "L" Suffix designates long Union.

♦MTO - Made To Order

### Male Connector

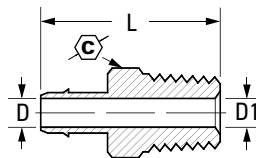
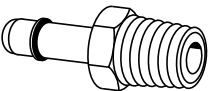

Tubing O.D.	Male Pipe Thread	Catalog Number	C	D	D1 Opt.	L
5/32	1/8	1068x2.5x2	7/16	0.06	0.19	0.98
1/4	1/16	1068x4x1	5/16	0.12	-	1.06
1/4	1/8	1068x4	7/16	0.12	0.19	1.06
1/4	1/4	1068x4x4	9/16	0.12	0.28	1.28
3/8	1/8	1068x6x2	7/16	0.19	-	1.09
3/8	1/4	1068x6	9/16	0.19	0.28	1.28
1/2	3/8	1068x8	11/16	0.31	-	1.38

### Female Connector

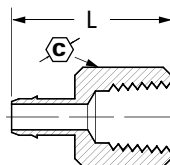
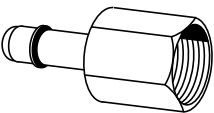

Tubing O.D.	Fem. Pipe Thread	Catalog Number	C	L
1/4	1/8*	1066x4	1/2	1.00
1/4	1/4	1066x4x4	11/16	1.25
3/8	1/4	1066x6 ♦	11/16	1.25

\*PTF Short Thread

♦MTO - Made To Order

### Compression Connector

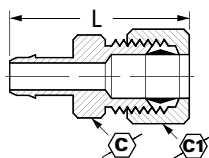
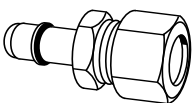

Tubing O.D.	Comp. Tube Size	Catalog Number	C	C1	L
3/16*	1/4	1078x3x4	7/16	1/2	1.29
1/4	1/4	1078x4x4	7/16	1/2	1.29

\*No Barb on 3/16" end

For replacement nuts and sleeves see page 45.

# Brass Products

## Mini-Barb

### Bulkhead Compression Connector

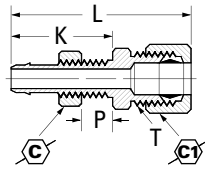
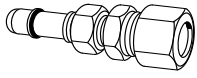

For replacement compression nuts and sleeves, see page 45.

Tubing O.D.	Comp. Tube Size	Catalog Number			K	L	Max. P	Thread T
1/4	1/4	1067x4x4	7/16	1/2	0.88	1.66	0.19	5/16-24 UNF

### Bulkhead Union

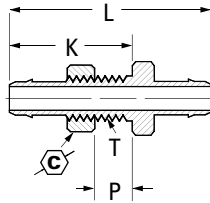
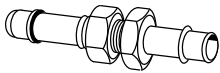

For replacement nuts and sleeves, see page 45 & 46.

Tubing O.D.	Thread T	Catalog Number		K	L	Max. P
1/4	5/16-24 UNF	1074x4	7/16	1.06	1.74	0.31
3/8	3/8-24 UNF	1074x6	1/2	1.06	1.74	0.31

### Union Elbow

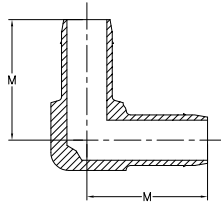
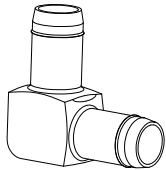

Tubing O.D.	Catalog Number	M
1/4	1065x4	0.70
3/8	1065x6	0.67
1/2	1065x8	0.94

### 90° Male Elbow

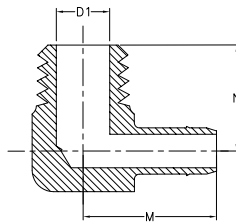
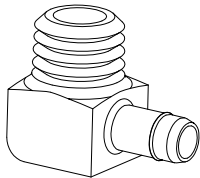

Tubing O.D.	Male Pipe Thread	Catalog Number	D1	M	N
1/4	1/16	1069x4x1	.156	.670	.550
1/4	1/8	1069x4	.250	.720	.630
1/4	1/4*	1069x4x4	.312	.780	.650
3/8	1/8	1069x6x2	.250	.740	.590
3/8	1/4*	1069x6	.312	.780	.620
1/2	3/8*	1069x8	.406	.980	.810

\*PTF Short Thread

### 90° Female Elbow

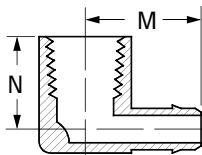
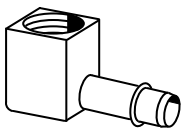

Tubing O.D.	Fem. Pipe Thread	Catalog Number	M	N
1/4	1/8	1070x4	.750	.580
3/8	1/8	1070x6x2	.780	.480
3/8	1/4	1070x6	.840	.800

# Brass Products

## Mini-Barb

Union Tee

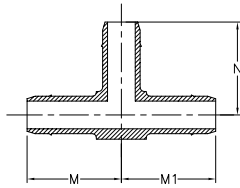
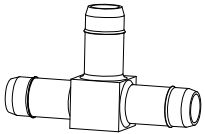

Tubing O.D.	Catalog Number	M	N	M1
1/4	1064x4	0.70	0.70	0.70
3/8x3/8x1/4	1064x6x6x4	0.70	0.74	0.70
3/8	1064x6	0.68	0.67	0.68
3/8x1/2x3/8	1064x6x8x6	0.76	0.75	0.86
1/2x1/2x1/4	1064x8x8x4	0.86	0.80	0.86
1/2x1/2x3/8	1064x8x8x6	0.86	0.76	0.86
1/2	1064x8	0.86	0.86	0.86

Male Run Tee

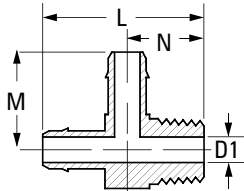
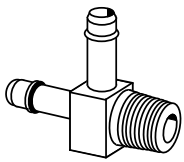

Tubing O.D.	Male Pipe Thread	Catalog Number	D1	L	M	N
1/4	1/8	1071x4	.188	1.21	0.71	0.59

\*PTF Short Thread

Male Branch Tee

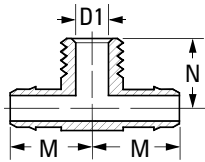
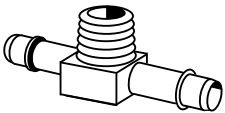

Tubing O.D.	Male Pipe Thread	Catalog Number	D1	M	N
1/4	1/8	1072x4	.188	.720	.590
3/8	1/8	1072x6x2	.188	.720	.590
3/8	1/4	1072x6	.312	.780	.620

Female Branch Tee

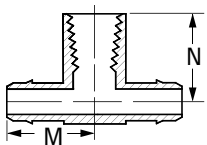
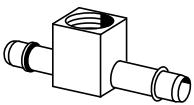

Tubing O.D.	Female Pipe Thread	Catalog Number	M	N
1/4	1/8	1077x4	0.77	0.48

Adapter Tee

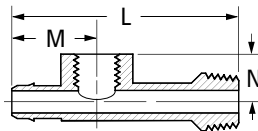
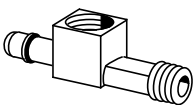

Tubing O.D.	M&F Pipe Thread	Catalog Number	L	M	N
1/4	1/8*	1075x4	2.00	0.75	0.39

\*PTF Special Short Thread

# Brass Products

## Quick>Connect Air Brake

### - Brass & Composite

**Note:**  
For additional technical questions, contact Technical Support at 1-888-258-0222.

 Refer to safety information regarding proper selection of tubing and tube connectors on page 3.

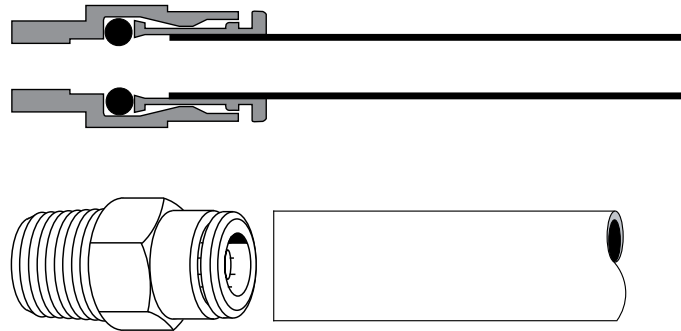

#### Typical Application:

Air brake systems except where temperatures exceed +200°F or where battery acid can drip on tubing. Not for fuel, water or oil.

#### Pressure:

Vacuum to 150 psi.

#### Vibration

Moderate vibration resistance.

#### Material:

CA360 Brass  
(Body & Collet).  
EP (Ethylene Propylene) - o-ring.

#### Used With:

SAE J844 Type A and B.

#### Temperature Range:

-40°F to +200°F  
(-40°C to +93°C)

#### Advantages:

Easy, fast assembly, one-piece fitting, reusable Field Serviceable (See collet repair kits, page 89).

#### Used With:

Danfoss Air Brake Tubing.

#### Conformance:

Meets D.O.T. FMVSS 571.106 and SAE J1131 air brake system performance requirements.

#### How to Order:

Order individually by catalog number (parts are standard with thread sealant).

#### Label Set:

FS-3300 (adhesive)  
CL-503 (non-adhesive)

#### Note:

Refer to current price list for availability of cataloged items. Quotations and delivery of non-stock items supplied on request. Configurations and dimensions subject to change without notice. Additional information can be found in SAE J2494.

#### Assembly Instructions:

See following page.

#### Cartridge Information

##### Encapsulated:

For insertion into single bore cavity in substitution for pipe thread ports. Meets proposed SAE specifications for encapsulated press in style Air Brake connectors.

##### Note:

Encapsulated Cartridges are specifically designed for installation into a thermoplastic (Nylon/Glass filled Nylon/Acetal) or a soft metal (Aluminum/Brass) cavity. For cavity dimensions contact Danfoss Technical Support at 1-888-258-0222.

##### Four-Step Cartridge:

When you clean sheet a component design, the Four-Step Cartridge is an economical substitute for the encapsulated design. Special order only.

Select the design that is right for you. For applications where manifolds (manufactured from aluminum, plastic and brass) and air tanks (manufactured from steel and plastic composites) are used, contact Danfoss Technical Support at 1-888-258-0222 for quotes based on your specific requirements and volumes.

# Brass Products

## Quick>Connect Air Brake - Brass & Composite

### Assembly

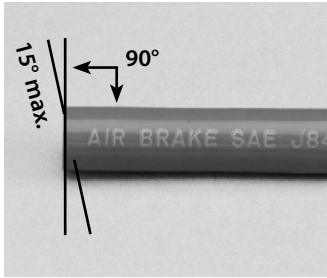

1. Using a tube cutter, make a square cut edge (maximum 15° cutting angle allowed).

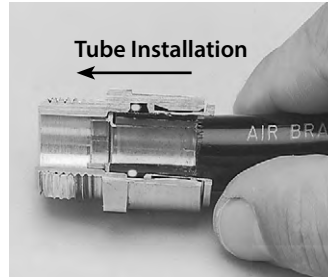

2. Insert tubing straight into connector until a solid stop is felt. The tubing grip and seal (on o-ring) is now accomplished.

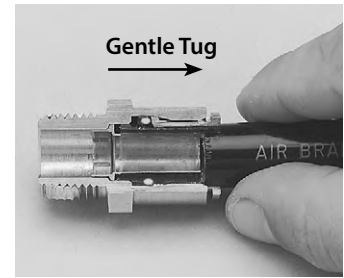

3. Gently tug on tubing to ensure tubing is secure.

### Disassembly



1. Check to be sure there isn't any air pressure.

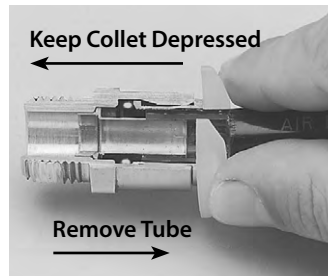

2. Depress collet head using fingers or tube-release tool to release grip on tubing.

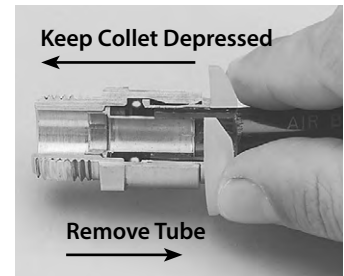

3. With the collet depressed, pull the tubing from the connector.



# Brass Products

## Quick>Connect Air Brake - Brass

**Note:**  
Use with Air Brake Tubing  
see page 31.

### Encapsulated Cartridge

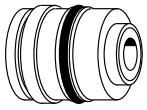

For design installation reference page 79 under Encapsulated heading.

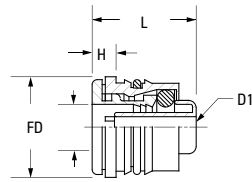

Tube O.D.	Catalog Number	DIA F	L	D1	D	H
5/32	1861x2.5	0.38	0.62	0.12	.165	0.17
3/16	1861x3	0.44	0.62	0.12	.195	0.16
1/4	1861x4	0.56	0.65	0.13	.263	0.17
3/8	1861x6	0.69	0.81	0.22	.388	0.19
1/2	1861x8	0.81	0.83	0.34	.513	0.19
3/4	1861x12	1.12	0.99	0.52	.763	0.24

### Union (Ref. SAE No. AA0101)

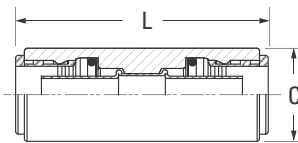
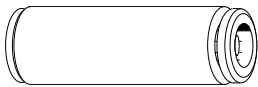

**Note:** Joins tubing

Tube O.D.	Catalog Number	Dia C	L
5/32	1862x2.5	0.44	1.41
3/16	1862x3	0.44	1.62
1/4	1862x4	0.53	1.62
3/8	1862x6	0.69	1.94
1/2	1862x8	0.83	1.96
5/8	1862x10	0.96	2.51

### Quick Connect Bulkhead Union (Ref. SAE No. AA0601)

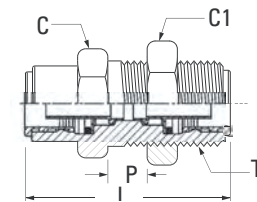
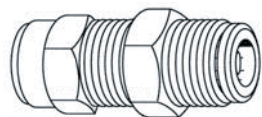

Tube O.D.	Thread T	Catalog Number	Hex C	Hex C1	L	Max P
1/4	9/16-24	1874x4x4	5/8	11/16	1.62	0.47
3/8	3/4-16	1874x6x6	7/8	15/16	1.96	0.66
1/2	7/8-14	1874x8x8	1	1	2.00	0.83
5/8	1-14	1874x10x10	1	1-1/4	2.42	1.00

### Female Bulkhead Union (Ref. SAE No. AA0603)

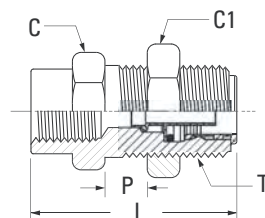
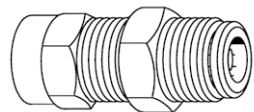

Tube O.D.	Thread T	Female Pipe Thread	Catalog Number	Hex C	Hex C1	L
1/4	9/16-24	1/4	1873x4x4	5/8	11/16	1.45
3/8	3/4-16	3/8	1873x6x6	7/8	15/16	1.59
1/2	1-14	1/2	1873x8x8	1	1-1/4	1.97

# Brass Products

## Quick>Connect Air Brake - Brass

**Note:**  
Use with Air Brake Tubing  
see page 31.

**Male Connector**  
(Ref. SAE No. AA0102)

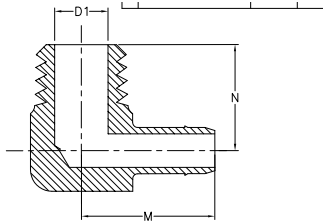
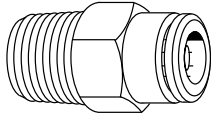

Tube O.D.	Male Pipe Thread	Catalog Number		D1	L
5/32	1/16	1868x2.5x13/8	0.09	0.92	
5/32	1/8	1868x2.5	7/16	0.25	0.92
3/16	1/8	1868x3	1/2	0.25	0.92
1/4	1/8	1868x4	9/16	0.19	0.95
1/4	1/4	1868x4x4	9/16	0.34	1.18
1/4	3/8	1868x4x6	11/16	0.41	1.17
3/8	1/8	1868x6x2	11/16	0.19	1.33
3/8	1/4	1868x6	11/16	0.31	1.29
3/8	3/8	1868x6x6	11/16	0.41	1.27
3/8	1/2	1868x6x8	7/8	0.53	1.47
1/2	1/4	1868x8x4	13/16	0.31	1.46
1/2	3/8	1868x8	13/16	0.41	1.35
1/2	1/2	1868x8x8	7/8	0.53	1.50
5/8	3/8	1868x10x6 1	0.41	1.72	
5/8	1/2	1868x10	1	0.53	1.71
3/4	1/2	1868x12	1-1/16	0.53	1.72

**Female Connector**  
(Ref. SAE No. AA0103)

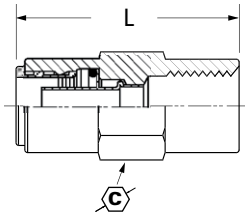
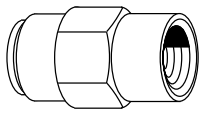

Tube O.D.	Female Pipe Thread	Catalog Number		L
1/4	1/8	1866x4	9/16	1.33
1/4	1/4	1866x4x4	11/16	1.58
3/8	1/8	1866x6x2	11/16	1.45
3/8	1/4	1866x6	11/16	1.69
3/8	3/8	1866x6x6	13/16	1.75
1/2	1/4	1866x8x4	13/16	1.66
1/2	3/8	1866x8	13/16	1.73
1/2	1/2	1866x8x8	1	1.97

**45° Male Elbow**  
(Ref. SAE No. AA0302)

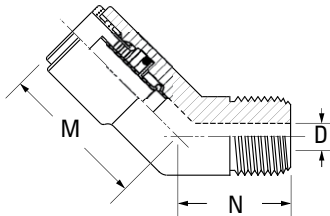
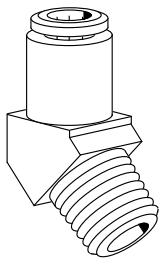

Tube O.D.	Male Pipe Thread	Catalog Number	D1	M	N
1/4	1/8	1880x4	0.19	0.95	0.59
1/4	1/4	1880x4x4	0.31	0.95	0.59
3/8	1/8	1880x6x2	0.25	1.05	0.48
3/8	1/4	1880x6	0.31	1.05	0.69
3/8	3/8	1880x6x6	0.41	1.10	0.63
3/8	1/2	1880x6x8	0.53	1.20	0.70
1/2	1/4	1880x8x4	0.31	1.07	0.88
1/2	3/8	1880x8	0.41	0.99	0.72
1/2	1/2	1880x8x8	0.53	0.99	0.82
5/8	3/8	1880x10x6 0.41	1.13	0.88	
5/8	1/2	1880x10	0.53	1.26	0.92
3/4	1/2	1880x12	0.53	1.16	0.98

# Brass Products

## Quick>Connect Air Brake - Brass

**Note:**  
Use with Air Brake Tubing  
see page 31.

**45° Elbow - Swivel Male**  
(Ref. SAE No. AA03DD)

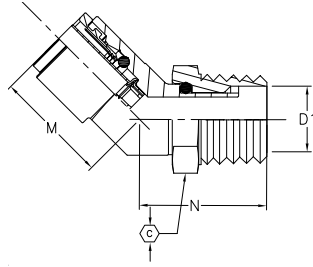
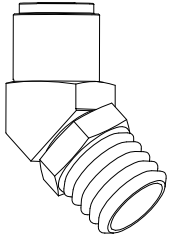

Swivel for installation purposes only.

Tube O.D.	Male Pipe Thread	Catalog Number	D1	M	N	
1/4	1/8	1880x4S	0.13	0.82	0.60	7/16
1/4	1/4	1880x4x4S	0.22	0.98	0.60	9/16
3/8	1/8	1880x6x2S	0.13	1.20	0.68	7/16
3/8	1/4	1880x6S	0.22	1.20	0.89	9/16
3/8	3/8	1880x6x6S	0.30	1.20	0.97	11/16
1/2	1/4	1880x8x4S	0.23	1.20	0.97	9/16
1/2	3/8	1880x8S	0.30	1.04	1.07	11/16
1/2	1/2	1880x8x8S	0.42	1.08	1.22	7/8

**90° Union Elbow**  
(Ref. SAE No. AA0201)

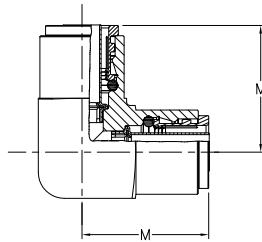
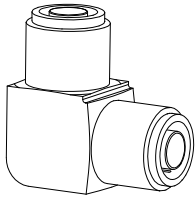

Tube O.D.	Catalog Number	M
1/4	1865x4	0.93
3/8	1865x6	1.15
1/2	1865x8	1.24

**90° Male Elbow**  
(Ref. SAE No. AA0302)

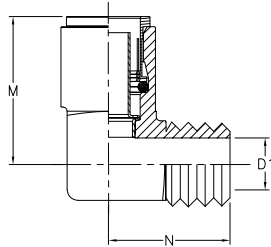
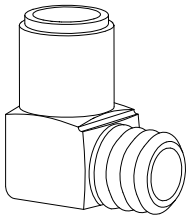

Tube O.D.	Male Pipe Thread	Catalog Number	D1	M	N
5/32	1/16	1869x2.5x10.13	0.75	0.59	
5/32	1/8	1869x2.5	0.19	0.75	0.59
3/16	1/8	1869x3	0.19	0.84	0.69
3/16	1/4	1869x3x4	0.19	0.87	0.81
1/4	1/8	1869x4	0.19	0.92	0.68
1/4	1/4	1869x4x4	0.31	0.92	0.81
1/4	3/8	1869x4x6	0.41	1.03	0.83
3/8	1/8	1869x6x2	0.19	1.08	0.78
3/8	1/4	1869x6	0.31	1.13	0.96
3/8	3/8	1869x6x6	0.41	1.18	0.98
3/8	1/2	1869x6x8	0.53	1.27	1.07
1/2	1/4	1869x8x4	0.31	1.23	1.00
1/2	3/8	1869x8	0.41	1.25	0.98
1/2	1/2	1869x8x8	0.53	1.28	1.11
5/8	3/8	1869x10x6 0.41	1.44	1.09	
5/8	1/2	1869x10	0.53	1.48	1.22

**90° Male Elbow Long**

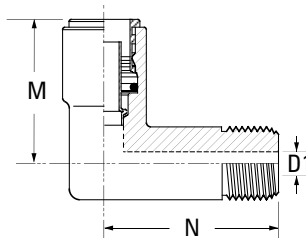
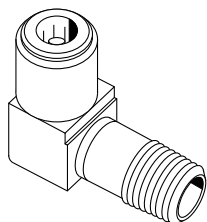

Tube O.D.	Male Pipe Thread	Catalog Number	D1	M	N
3/8	1/4	1869x6L	0.31	1.21	1.55

# Brass Products

## Quick>Connect Air Brake - Brass

**Note:**  
Use with Air Brake Tubing  
see page 31.

### 90° Swivel Male Elbow (Ref. SAE No. AA02DD)

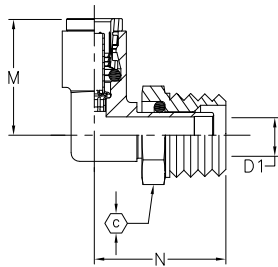
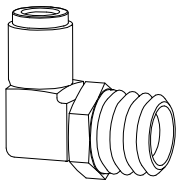

Swivel for installation purposes only.

Tube O.D.	Male Pipe Thread	Catalog Number	D1	M	N	
1/4	1/8	1869x4S	0.14	0.89	0.88	7/16
1/4	1/4	1869x4x4S	0.23	0.99	1.06	9/16
1/4	3/8	1869x4x6S	0.30	0.99	1.06	11/16
3/8	1/8	1869x6x2S	0.74	1.03	0.97	7/16
3/8	1/4	1869x6S	0.23	1.12	1.14	9/16
3/8	3/8	1869x6x6S	0.30	1.12	1.15	11/16
3/8	1/2	1869x6x8S	0.42	1.18	1.40	7/8
1/2	1/4	1869x8x4S	0.22	1.08	1.20	9/16
1/2	3/8	1869x8S	0.30	1.13	1.27	11/16
1/2	1/2	1869x8x8S	0.42	1.25	1.47	7/8
5/8	3/8	1869x10x6S	0.42	1.35	1.34	11/16
5/8	1/2	1869x10S	0.42	1.38	1.54	7/8

### 90° Female Elbow (Ref. SAE No. AA0203)

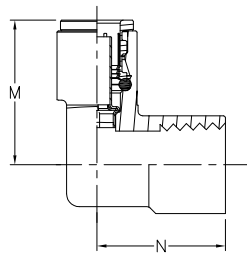
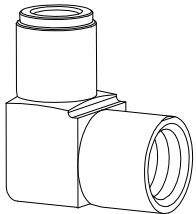

Tube O.D.	Female Pipe Thread	Catalog Number	M	N
1/4	1/8	1870x4	1.03	0.82
1/4	1/4	1870x4x4	1.04	0.76
3/8	1/8	1870x6x2	1.26	0.96
3/8	1/4	1870x6	1.28	1.09
3/8	3/8	1870x6x6	1.21	1.07
1/2	1/4	1870x8x4	1.25	1.11
1/2	3/8	1870x8	1.28	1.11
1/2	1/2	1870x8x8	1.36	1.07

### Union Tee (Ref. SAE No. AA0401)

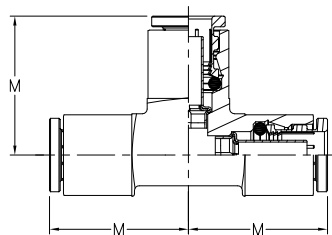
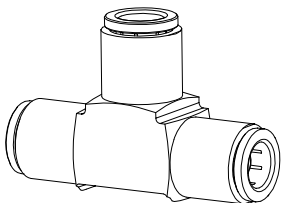

Tube O.D.	Catalog Number	M
1/4	1864x4	0.93
3/8	1864x6	1.15
1/2	1864x8	1.22

### Male Run Tee (Ref. SAE No. AA0424)

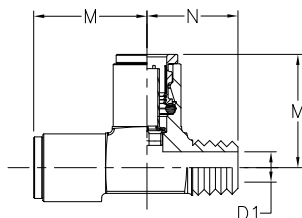
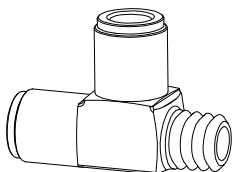

Tube O.D.	Male Pipe Thread	Catalog Number	D1	M	M1	N
1/4	1/8	1871x4	0.23	0.93	0.93	0.68
1/4	1/4	1871x4x4	0.32	0.93	0.93	0.83
3/8	1/4	1871x6	0.31	1.15	1.15	0.90
3/8	3/8	1871x6x6	0.41	1.15	1.14	0.90
3/8x1/4	1/4	1871x6x4x4	0.31	1.14	1.07	0.96
3/8	1/2	1871x6x8	0.53	1.09	1.08	1.11
1/2	3/8	1871x8	0.41	1.09	1.10	1.22

# Brass Products

## Quick>Connect Air Brake - Brass

**Note:**  
Use with Air Brake Tubing  
see page 31.

**Swivel Male Run Tee**  
(Ref. SAE No. AA04EE)

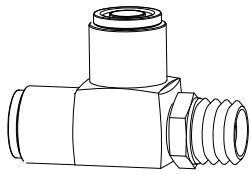

Swivel for installation purposes only.

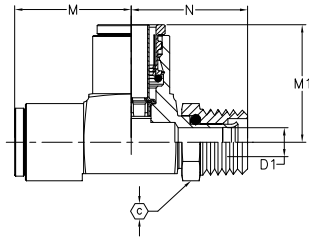

Tube O.D.	Male Pipe Thread	Catalog Number	D1	M	M1	N	
1/4	1/8	1871x4S	0.14	0.93	0.93	0.82	7/16
1/4	1/4	1871x4x4S	0.23	0.93	0.93	1.07	9/16
3/8	1/4	1871x6S	0.23	1.15	1.15	1.20	9/16
3/8	3/8	1871x6x6S	0.30	1.15	1.15	1.20	11/16
1/2	1/4	1871x8x4S	0.22	1.21	1.18	1.22	9/16
1/2	3/8	1871x8S	0.30	1.21	1.23	1.34	11/16
1/2	1/2	1871x8x8S	0.42	1.21	1.19	1.42	7/8

**Male Branch Tee**  
(Ref. SAE No. AA0425)

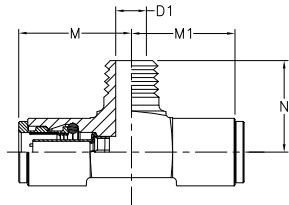
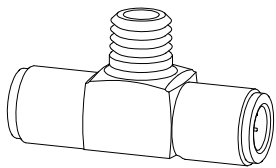

Tube O.D.	Male Pipe Thread	Catalog Number	D1	M	M1	N
3/16	1/8	1872x3	0.19	0.75	0.74	0.64
1/4	1/8	1872x4	0.19	0.93	0.93	0.64
1/4	1/4	1872x4x4	0.31	0.93	0.93	0.83
3/8	1/4	1872x6	0.31	1.15	1.15	0.91
3/8	3/8	1872x6x6	0.31	1.15	1.15	0.91
1/2	1/4	1872x8x4	0.31	1.22	1.22	0.98
1/2	3/8	1872x8	0.41	1.24	1.24	0.99
1/2	1/2	1872x8x8	0.53	1.22	1.22	1.12

**Swivel Male Branch Tee**  
(Ref. SAE No. AA04FF)

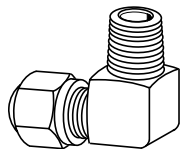

Swivel for installation purposes only.

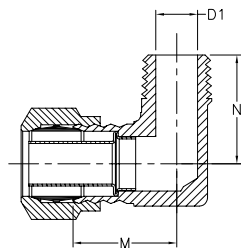

Tube O.D.	Male Pipe Thread	Catalog Number	D1	M	M1	N	
1/4	1/8	1872x4S	0.14	0.93	0.93	0.80	7/16
1/4	1/4	1872x4x4S	0.23	0.93	0.93	1.04	9/16
3/8	1/8	1872x6x2S	0.13	1.15	1.15	0.94	7/16
3/8	1/4	1872x6S	0.23	1.15	1.15	1.14	9/16
3/8	3/8	1872x6x6S	0.30	1.15	1.15	1.17	11/16
1/2	1/4	1872x8x4S	0.22	1.23	1.23	1.21	9/16
1/2	3/8	1872x8S	0.30	1.24	1.24	1.24	11/16
1/2	1/2	1872x8x8S	0.42	1.21	1.19	1.42	7/8

**Female Branch Tee**

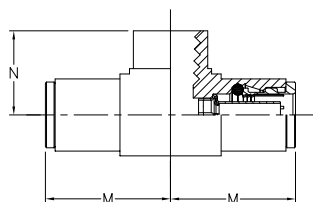
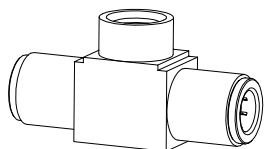

Tube O.D.	Female Pipe Thread	Catalog Number	M	N
3/8	1/4	1877x6	1.19	0.78

# Brass Products

## Quick > Connect Air Brake - Composite

**Note:**  
Use with Air Brake Tubing  
see page 31.

### 45° Q-CAB Connection to Male Pipe

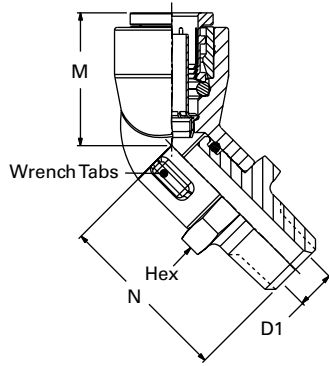

Tube O.D.	Thread Size	45° Male Pipe Part#	D1	M	N	Hex
1/4	1/8-27	217-35004-03	0.19	0.78	1.12	9/16
1/4	1/4-18	217-38404-03	0.28	0.78	1.30	9/16
1/4	3/8-18	217-38604-03	0.41	0.78	1.30	11/16
3/8	1/8-27	217-38206-03	0.19	1.00	1.11	3/4
3/8	1/4-18	217-35006-03	0.28	1.00	1.29	3/4
3/8	3/8-18	217-38606-03	0.41	1.00	1.29	3/4
1/2	1/4-18	217-38408-03	0.28	1.10	1.32	7/8
1/2	3/8-18	217-35008-03	0.41	1.10	1.26	7/8
1/2	1/2-14	217-38808-03	0.53	1.10	1.45	7/8
5/8	3/8-18	217-38610-03	0.41	1.34	1.30	1.0
5/8	1/2-14	217-35010-03	0.53	1.34	1.52	1.0

### Special Fittings

Fitting sizes and configurations other than shown above, can be provided. Please contact your Danfoss Area Sales Manager for assistance.

### 90° Q-CAB Connection to Male Pipe

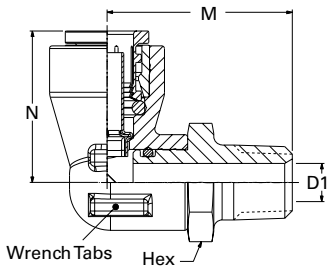

Tube O.D.	Thread Size	90° Male Pipe Part#	D1	M	N	Hex
1/4	1/8-27	217-40004-03	0.19	1.11	0.86	9/16
1/4	1/4-18	217-43404-03	0.28	1.29	0.86	9/16
1/4	3/8-18	217-43604-03	0.41	1.29	0.86	11/16
3/8	1/8-27	217-43206-03	0.19	1.17	1.12	3/4
3/8	1/4-18	217-40006-03	0.28	1.36	1.12	3/4
3/8	3/8-18	217-43606-03	0.41	1.36	1.12	3/4
3/8	1/2-14	217-43806-03	0.53	1.61	1.12	7/8
1/2	1/4-18	217-43408-03	0.28	1.59	1.19	7/8
1/2	3/8-18	217-40008-03	0.41	1.40	1.19	7/8
1/2	1/2-14	217-43808-03	0.53	1.60	1.19	7/8
5/8	3/8-18	217-43610-03	0.41	1.46	1.46	1.0
5/8	1/2-14	217-40010-03	0.53	1.68	1.46	1.0

# Brass Products

## Quick>Connect Air Brake

**Note:**  
Use with Air Brake Tubing  
see page 31.

### Adapter Tee

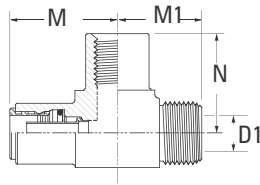
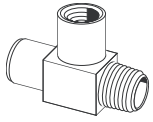

Tube O.D.	Male Pipe Thread	Female Pipe Thread	Catalog Number	D1	M	N	M1
3/8	3/8	1/4	1883x6x6x4	0.41	1.28	1.00	0.95
1/4	1/4	1/4	117-550644-03	0.31	1.62	.94	0.75

### Male Metric

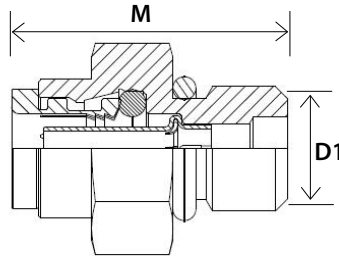

Tube O.D.	Male Pipe Thread	Female Pipe Thread	Catalog Number	D1	M
1/4	M12x1.5	217-2120403	11/16	.34	.94

### Plugs, Pressure (Nylon)

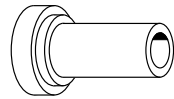

Tube O.D.	Catalog Number
1/4	1829x4
3/8	1829x6
1/2	1829x8

### 1800T Collet Service Tool

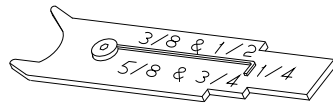

The Collet Service Tool, made from sturdy plated steel, is designed to assist in field servicing O-Rings of Q-CAB fittings. Use the half moon radius section to pry up and

remove the collet and use the movable piano wire to remove the O-Ring. Notches are used to mark the tubing with insertion depth in five tubing sizes.

### 1800TRK Tube Release Kit



The 1800TRK tube release kit is designed to ease the removal of tubing from Q-CAB connectors. The individual tools are manufactured of a sturdy

engineering plastic. All seven tube sizes currently offered in Q-CAB can be serviced with the five tools that make up the 1800TRK kit.

### Collet Repair Kits

Tube O.D.	Repair Kit Part #
5/32	1800Kx2.5
3/16	1800Kx3
1/4	1800Kx4
3/8	1800Kx6
1/2	1800Kx8
5/8	1800Kx10
3/4	1800Kx12

Consisting of a replacement collet and a replacement o-ring, the collet repair kits provide an

opportunity to repair damaged Q-CAB connectors.

# Brass Products

## Air Brake - Nylon Tubing

**Note:**  
For additional technical questions, contact Technical Support at 1-888-258-0222.

 Refer to safety information regarding proper selection of tubing and tube connectors on page 3.

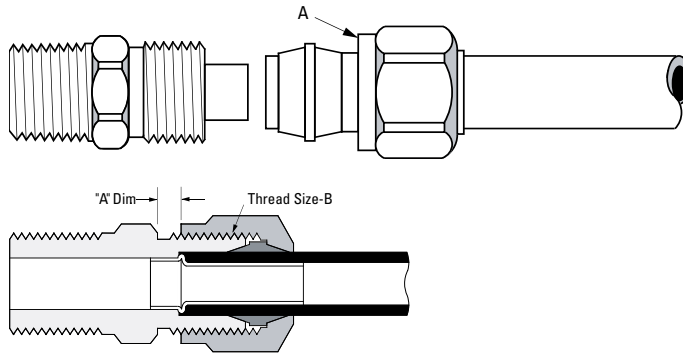

<b>Tube O.D.</b>	1/4	3/8	1/2	5/8	3/4
<b>Thread Size-B</b>	7/16-24	17/32-24	11/16-20	13/16-18	1-18

**Typical Application:**

Air brake systems except where temperatures exceed +200°F or where battery acid can drip on tubing.

**Pressure:**

Maximum operating pressure of 150 psi.

**Vibration:**

Fair resistance.

**Temperature Range:**

-40°F to +200°F  
(-40°C to +93°C)

**Material:**

CA360 Brass.

**Used With:**

Air Brake Tubing. See Page 33

**Advantages:**

Easy to assemble (no tube preparation or flaring required.) Built in tube support. May be used with copper tubing by replacing nut, sleeve and insert with long nut and spherical sleeve. Insert should be removed for copper tubing use. See page 96 for details.

**Conformance:**

Meets specifications and standards of SAE and DOT FMVSS 571.106.

**How to Order:**

For complete assemblies (body, nuts and sleeves), order by catalog number. Example: 1468x4x4. To order body only (less nut and sleeve), add prefix "B" to catalog number and change "14" to "13". Example: B1368x4x4. Nuts, sleeve and insert can be ordered separately by catalog number.

To order complete assembly with pipe sealant (Seal-A-Thread), add suffix "Z" to catalog number. Example: 1468x4x4Z (special order only).

To order complete assembly with gauge ring, add suffix "K" to catalog number. Example: 1468x4x4K (special order only).

**Note:**

Refer to current price list for availability of cataloged items. Quotations and delivery of non-stock items supplied on request. Configurations and dimensions subject to change without notice. Additional information can be found in SAE J246.

**Assembly Instructions:**

1. Cut tubing to desired length.
2. Slide nut and then sleeve on tubing. Threaded end of nut "A" must face toward connector body.
3. Insert tubing into the pre assembled fitting. Be sure tubing is bottomed in connector.
4. Tighten nut to required torque as indicated on chart. Another check on proper assembly is dimension A also noted on chart. A gauge ring also assures installation to specification. See page 95.

Tube Size	Torque	A Dimension
1/4	85 to 115 in. lbs.	.085/.105
3/8	12 to 17 ft. lbs.	.125/.145
1/2	25 to 33 ft. lbs.	.100/.120
5/8	26 to 35 ft. lbs.	.115/.135
3/4	38 to 50 ft. lbs.	.180/.200

**Disassembly:**

Remove nut and pull tubing out of connector body. Insert will remain in tubing.

**Reassembly:**

Push tubing and insert into connector body until it bottoms. Thread nut onto connector body and torque as in Step 4.

**Label Set:**

FS-900 (adhesive)  
CL-497 (non-adhesive)



# Brass Products

## Air Brake - Nylon Tubing

**Note:**  
Use with Air Brake Tubing  
see page 31.

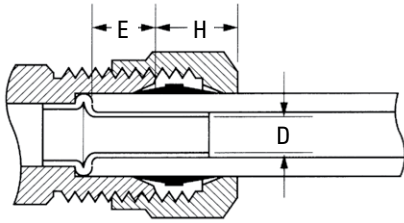

Tube O.D.	E Tube Stop	H*	D
1/4	0.20	0.32	.133
3/8	0.26	0.42	.215
1/2	0.39	0.45	.340
5/8	0.39	0.48	.398
3/4	0.51	0.50	.523

\*H is hand tight dimensions.

**Sleeve**  
(Ref. SAE No. 100115)

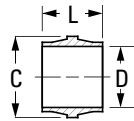

Tube O.D.	Catalog Number	DIA. C	D	L
1/4	1460x4	.359	.256	.300
3/8	1460x6	.479	.384	.390
1/2	1460x8	.625	.509	.430
5/8	1460x10	.745	.635	.480
3/4	1460x12	.922	.760	.530

**Nut**  
(Ref. SAE No. 100110)

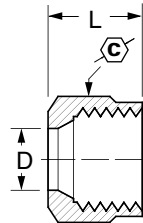
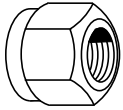

Tube O.D.	Catalog Number		D	L
1/4	1461x4	9/16	.256	.450
3/8	1461x6	5/8	.384	.630
1/2	1461x8	13/16	.509	.720
5/8	1461x10	15/16	.634	.770
3/4	1461x12	1-1/8	.760	.810

**Union**  
(Ref. SAE No. 100101BA)

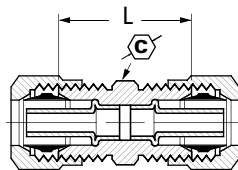
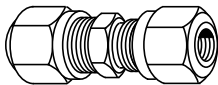

Tube O.D.	Catalog Number		L
1/4	1462x4	7/16	0.85
3/8	1462x6	9/16	1.10
1/2	1462x8	11/16	1.31
5/8	1462x10	13/16	1.43
3/4	1462x12	1	1.60

# Brass Products

## Air Brake - Nylon Tubing

**Note:**  
Use with Air Brake Tubing  
see page 31.

**Male Connector**  
(Ref. SAE No. 100102BA)

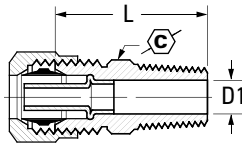
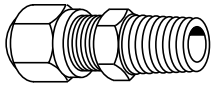

Tube O.D.	Male Pipe Thread	Catalog Number	C	D1	L
1/4	1/16	1468x4x1	7/16	.125	.90
1/4	1/8	1468x4	7/16	.188	.88
1/4	1/4	1468x4x4	9/16	.188	1.09
1/4	3/8	1468x4x6	11/16	.188	1.12
3/8	1/8	1468x6x2	9/16	.188	1.02
3/8	1/4	1468x6	9/16	.312	1.20
3/8	3/8	1468x6x6	11/16	.312	1.23
3/8	1/2	1468x6x8	7/8	.312	1.42
1/2	1/4	1468x8x4	11/16	.312	1.32
1/2	3/8	1468x8	11/16	.406	1.32
1/2	1/2	1468x8x8	7/8	.406	1.51
1/2	3/4	1468x8x12 1-1/16	.406	1.57	
5/8	3/8	1468x10x6 13/16	.406	1.38	
5/8	1/2	1468x10	7/8	.531	1.57
5/8	3/4	1468x10x12	1-1/16	.750	1.63
3/4	1/2	1468x12	1	.531	1.67
3/4	3/4	1468x12x12	1-1/16	.660	1.70

**Female Connector**  
(Ref. SAE No. 100103BA)

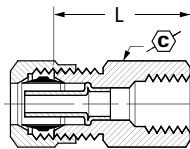
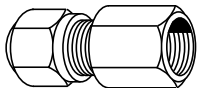

Tube O.D.	Fem. Pipe Thread	Catalog Number	C	L
1/4	1/8	1466x4	9/16	0.85
3/8	1/8	1466x6x2 ♦	9/16	1.01
3/8	1/4	1466x6	11/16	1.19
3/8	3/8	1466x6x6	7/8	1.19
1/2	3/8	1466x8	7/8	1.28

♦MTO - Made To Order

**Bulkhead Union**

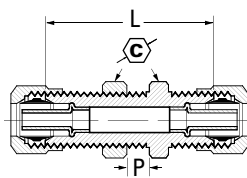
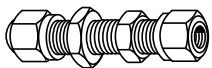

Tube O.D.	Catalog Number	C	L	Max. P
1/4	1474x4	9/16	1.38	0.25
3/8	1474x6	11/16	1.62	0.25
1/2	1474x8 ♦	13/16	1.88	0.25

♦MTO - Made To Order

**45° Male Elbow**  
(Ref. SAE No. 100302BA)

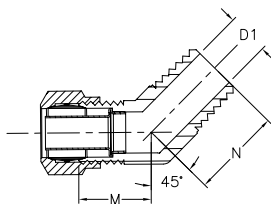
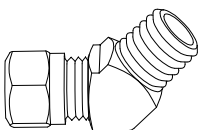

Tube O.D.	Male Pipe Thread	Catalog Number	D1	M	N
1/4	1/8	1480x4	.188	0.50	0.64
1/4	1/4	1480x4x4	.312	0.61	0.86
3/8	1/4	1480x6	.312	0.72	0.86
3/8	3/8	1480x6x6	.406	0.76	0.95
1/2	1/4	1480x8x4	.312	0.85	0.95
1/2	3/8	1480x8	.406	0.85	0.95
1/2	1/2	1480x8x8	.531	0.88	1.17
5/8	1/2	1480x10	.531	0.95	1.17

# Brass Products

## Air Brake - Nylon Tubing

**Note:**  
Use with Air Brake Tubing  
see page 31.

**Union Elbow**  
(Ref. SAE No. 100201BA)

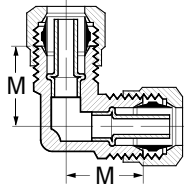
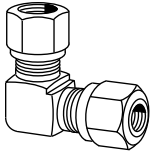

Tube O.D.	Catalog Number	M
1/4	1465x4 ♦	0.63
3/8	1465x6 ♦	0.80
1/2	1465x8 ♦	0.94
5/8	1465x10 ♦	1.10

♦MTO - Made To Order

**90° Male Elbow**  
(Ref. SAE No. 100202BA)

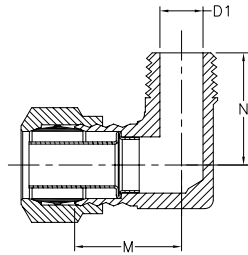
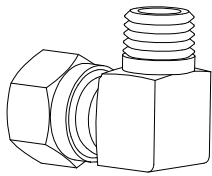

Tube O.D.	Male Pipe Thread	Catalog Number	D1	M	N
1/4	1/8	1469x4	.188	0.63	0.67
1/4	1/4	1469x4x4	.312	0.69	0.88
1/4	3/8	1469x4x6	.406	0.74	0.87
3/8	1/8	1469x6x2	.188	0.73	0.75
3/8	1/4	1469x6	.312	0.80	0.93
3/8	3/8	1469x6x6	.406	0.85	0.92
3/8	1/2	1469x6x8	.562	0.95	1.11
1/2	1/4	1469x8x4	.313	0.87	1.00
1/2	3/8	1469x8	.407	0.94	1.00
1/2	1/2	1469x8x8	.531	1.04	1.19
5/8	3/8	1469x10x6 .406	1.01	1.06	
5/8	1/2	1469x10	.531	1.10	1.25
5/8	3/4	1469x10x12	.750	1.21	1.30
3/4	1/2	1469x12	.531	1.20	1.34

**90° Male Elbow - Long**  
(Ref. SAE No. 100202BA)

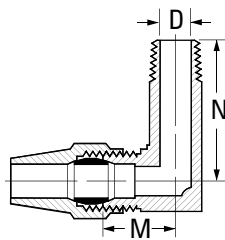
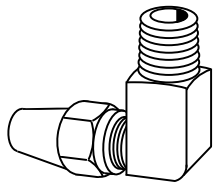

Tube O.D.	Male Pipe Thread	Catalog Number	D1	M	N
3/8	1/4	1469x6L	.312	0.80	1.44
1/2	3/8	1469x8L	.406	0.94	1.38

**90° Female Elbow**  
(Ref. SAE No. 100203BA)

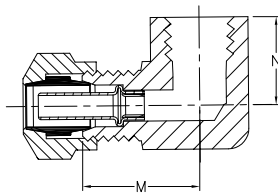
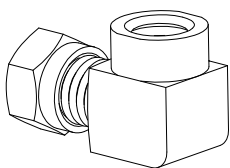

Tube O.D.	Fem. Pipe Thread	Catalog Number	M	N
1/4	1/8	1470x4	0.72	0.54
3/8	1/4	1470x6 ♦	0.90	0.78
1/2	3/8	1470x8 ♦	1.04	0.83

♦MTO - Made To Order

# Brass Products

## Air Brake - Nylon Tubing

**Note:**  
Use with Air Brake Tubing  
see page 31.

### Union Tee (Ref. SAE No. 100401BA)

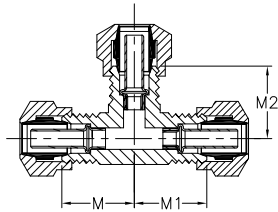
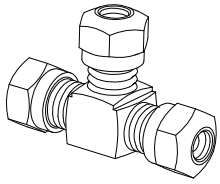

Dimensions read left, right, center.

Tube O.D.	Catalog Number	M	M1	M2
1/4	1464x4	0.64	0.64	0.64
3/8x3/8x1/4	1464x6x6x4	0.72	0.72	0.69
3/8	1464x6	0.80	0.80	0.80
1/2x1/2x3/8	1464x8x8x6	0.86	0.86	0.85
1/2	1464x8	0.94	0.94	0.94

### Male Branch Tee (Ref. SAE No. 100425BA)

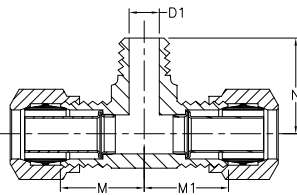
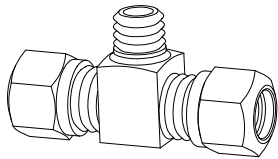

Tube O.D.	Male Pipe Thread	Catalog Number	D1	M	M1	N
1/4	1/8	1472x4	.188	0.63	0.63	0.67
3/8x1/4	1/4	1472x6x4x4	.312	0.82	0.69	0.93
3/8	1/8	1472x6x6x2	.188	0.73	0.73	0.75
3/8	1/4	1472x6	.312	0.82	0.82	0.93
3/8	3/8	1472x6x6x6	.406	0.85	0.85	0.92
1/2x3/8	3/8	1472x8x6x6	.406	0.94	0.85	1.00
1/2	1/4	1472x8x8x4	.312	0.94	0.94	1.00
1/2	3/8	1472x8	.406	0.94	0.94	1.00

♦MTO - Made To Order

### Female Branch Tee

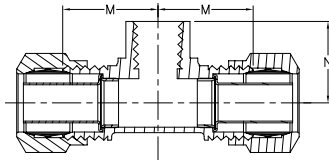
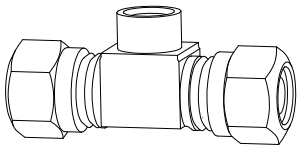

Tube O.D.	Fem. Pipe Thread	Catalog Number	M	N
3/8	1/4	1477x6	0.90	0.78
1/2	1/4	1477x8x8x4	0.97	0.83
5/8	1/4	1477x10x10x4	1.04	0.89

♦MTO - Made To Order

### Male Run Tee (Ref. SAE No. 100424BA)

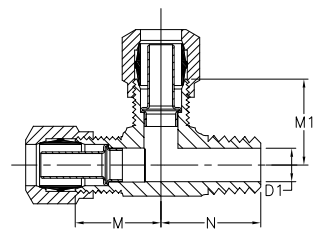
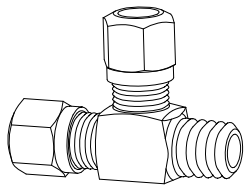

Tube O.D.	Male Pipe Thread	Catalog Number	D1	M	M1	N
1/4	1/8	1471x4	.188	0.64	0.64	0.67
3/8x1/4	1/4	1471x6x4x4	.312	0.80	0.69	0.93
3/8	1/4	1471x6	.312	0.80	0.80	0.93
3/8	3/8	1471x6x6x6	.406	0.85	0.85	0.92
1/2	3/8	1471x8	.406	0.94	0.94	1.10

♦MTO - Made To Order

# Brass Products

## Air Brake - Nylon Tubing

**Note:**  
Use with Air Brake Tubing  
see page 31.

**Adapter Tee**

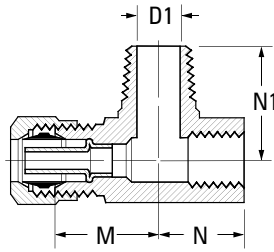
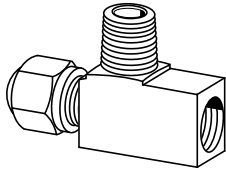

Tube O.D.	Fem. Pipe Thread	Male Pipe Thread	Catalog Number	D1	M	N	N1
3/8	1/4	1/4	1482x6x4x4	♦ .312	0.88	0.75	0.94

♦MTO - Made To Order

**Insert**  
(Brass)

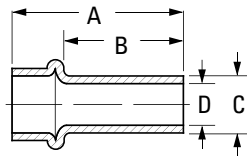
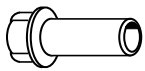

Tube O.D.	Catalog Number	A	B	C	D
1/4	1484x4	0.64	0.46	.163	.133
3/8	1484x6	0.76	0.58	.245	.215
1/2	1484x8	0.94	0.76	.370	.340
5/8	1484x10	1.06	0.84	.434	.398
3/4	1484x12	1.21	1.00	.559	.523

**Gauge Ring**



Nut screwed to Gauge Ring assures installation to specifications.

Tube O.D.	Catalog Number	L
1/4	1485x4	.085/.105
3/8	1485x6	.125/.145
1/2	1485x8	.100/.120
5/8	1485x10	.115/.135
3/4	1485x12	.180/.200

# Brass Products

## Air Brake - Copper Tubing

**Note:**  
For additional technical questions, contact Technical Support at 1-888-258-0222.

 Refer to safety information regarding proper selection of tubing and tube connectors on page 3.

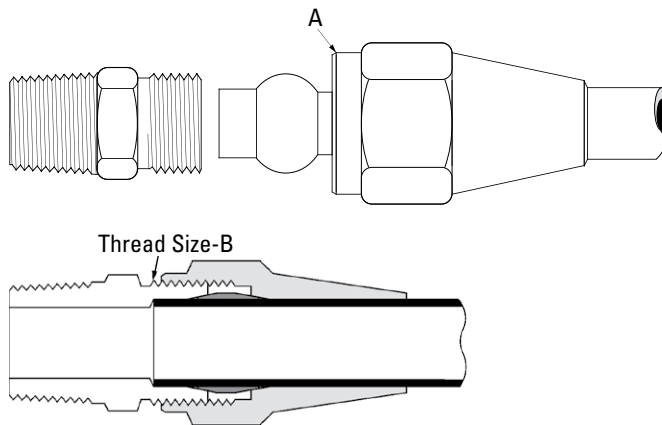

<b>Tube O.D.</b>	1/4	3/8	1/2	5/8	3/4	1
<b>Thread Size-B</b>	7/16-24	17/32-24	11/16-20	13/16-18	1-18	1-1/4-16

**Typical Application:**

Air brake systems.

**Pressure:**

Maximum operating pressure of 150 psi.

**Vibration:**

Fair resistance.

**Temperature Range:**

-65°F to +250°F (-53°C to +121°C) with copper tubing.

**Material:**

CA360 Brass.

**Used With:**

Copper tubing in air brake systems.

**Advantages:**

Easy to assemble (no flaring). May be used with nylon tubing by replacing long nut and spherical sleeve with insert, rigid sleeve and nut.

**Conformance:**

Meets specifications and standards of SAE and DOT.

**How to Order:**

For complete assemblies (body, nuts and sleeves), order by catalog number. Example: 1368x4. To order body only (less nut and sleeve), add prefix "B" to catalog number. Example: B1368x4. Nuts and sleeve can be ordered separately by catalog number.

To order complete assembly with pipe sealant (Seal-A-Thread), add suffix "Z" to catalog number. Example: 1368x4Z (special order only).

**Note:**

Refer to current price list for availability of cataloged items. Quotations and delivery of non-stock items supplied on request. Configurations and dimensions subject to change without notice. Additional information can be found in SAE J246.

**Assembly Instructions:**

1. Cut tubing to desired length. Make sure all burrs are removed and the ends are cut square.
2. Slide nut and then sleeve on tubing. Threaded end of nut "A" must face toward connector body.
3. Insert tubing into connector. Be sure tubing is bottomed on fitting shoulder.
4. Thread nut onto connector body until it is hand tight.
5. From that point, tighten with a wrench the number of turns indicated in the chart below.

Tube Size	Additional Number Of Turns From Hand Tight
1/4, 3/8	1-3/4
1/2, 5/8, 3/4	3-1/4

**Label Set:**

FS-800 (adhesive)  
CL-491 (non-adhesive)

# Brass Products

## Air Brake - Copper Tubing

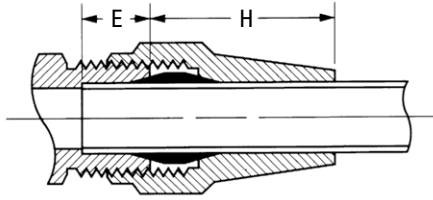

H is hand tight dimensions.

Tube O.D.	E Tube Depth H	
1/4	0.25	0.58
3/8	0.31	0.87
1/2	0.44	0.95
5/8	0.44	1.05
3/4	0.56	1.25

**Sleeve**  
(Ref. SAE No. 120115)

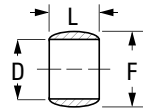

Tube O.D.	Catalog Number	D	F	L
1/4	1360x4	.255	.322	.250
3/8	1360x6	.382	.461	.313
1/2	1360x8	.507	.594	.375
5/8	1360x10	.632	.734	.438
3/4	1360x12	.758	.874	.500

**Nut**  
(Ref. SAE No. 120111)

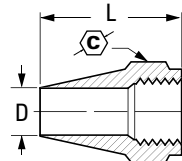
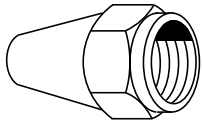

Tube O.D.	Catalog Number	C	D	L
1/4	1361x4	9/16	.256	0.75
3/8	1361x6	5/8	.384	1.13
1/2	1361x8	13/16	.509	1.25
5/8	1361x10	15/16	.634	1.38
3/4	1361x12	1-1/8	.760	1.56

**Union**  
(Ref. SAE No. 120101BA)

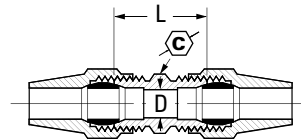
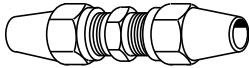

Tube O.D.	Catalog Number	C	D	L
1/4	1362x4	7/16	.188	0.85
3/8	1362x6	9/16	.312	1.10
1/2	1362x8	11/16	.406	1.31
5/8	1362x10	13/16	.531	1.43
3/4	1362x12	1	.656	1.60
1	1362x16	1-1/4	.875	1.78

**Male Connector**  
(Ref. SAE No. 120102BA)

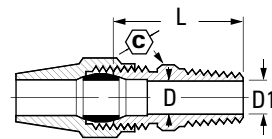
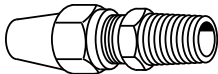

Tube O.D.	Male Pipe Thread	Catalog Number	C	D	D1	L
1/4	1/8	1368x4	7/16	.188	.188	0.88
1/4	1/4	1368x4x4	9/16	.188	.188	1.09
3/8	1/8	1368x6x2	9/16	.312	.188	1.02
3/8	1/4	1368x6	9/16	.312	.312	1.20
3/8	3/8	1368x6x6	11/16	.312	.406 opt.	1.23
3/8	1/2	1368x6x8	7/8	.312	.531 opt.	1.42
1/2	1/4	1368x8x4	11/16	.406	.312	1.32
1/2	3/8	1368x8	11/16	.406	.406	1.32
1/2	1/2	1368x8x8	7/8	.406	.531 opt.	1.51
5/8	3/8	1368x10x6	13/16	.531	.406	1.38
5/8	1/2	1368x10	7/8	.531	.531	1.57
3/4	1/2	1368x12	1	.656	.531	1.67
3/4	3/4	1368x12x12	1-1/16	.656	.719 opt.	1.70

# Brass Products

## Air Brake - Copper Tubing

**Female Connector**  
(Ref. SAE No. 120103BA)

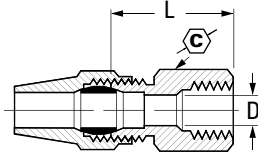
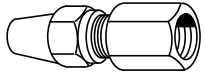

Tube O.D.	Fem. Pipe Thread	Catalog Number		D	L
3/8	1/4	1366x6	11/16	.312	1.19
3/8	3/8	1366x6x6	7/8	.312	1.19
1/2	3/8	1366x8	7/8	.406	1.28

**45° Male Elbow**  
(Ref. SAE No. 120302BA)

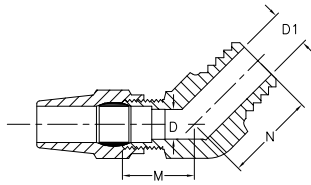
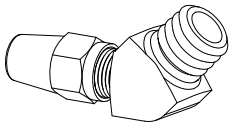

Tube O.D.	Male Pipe Thread	Catalog Number	D	D1	M	N
3/8	1/4	1380x6	.312	.312	0.72	0.86
3/8	3/8	1380x6x6	.312	.406	0.76	0.95
1/2	3/8	1380x8	.409	.406	0.85	0.95
5/8	1/2	1380x10	.534	.531	0.95	1.17

**90° Male Elbow**  
(Ref. SAE No. 120202BA)

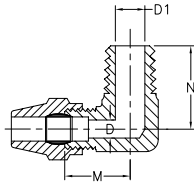
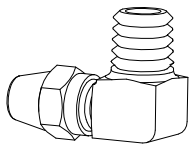

Tube O.D.	Male Pipe Thread	Catalog Number	D	D1	M	N
1/4	1/8	1369x4	.188	.188	0.63	0.67
1/4	1/4	1369x4x4	.190	.312	0.69	0.88
3/8	1/8	1369x6x2	.312	.188	0.73	0.75
3/8	1/4	1369x6	.317	.312	0.80	0.93
3/8	3/8	1369x6x6	.317	.406	0.85	0.92
3/8	1/2	1369x6x8	.317	.562	0.95	1.11
1/2	1/4	1369x8x4	.409	.313	0.87	1.00
1/2	3/8	1369x8	.409	.409	0.94	1.00
1/2	1/2	1369x8x8	.409	.531	1.04	1.19
5/8	3/8	1369x10x6	.534	.406	1.01	1.06
5/8	1/2	1369x10	.534	.531	1.10	1.25

**90° Male Elbow - Long**

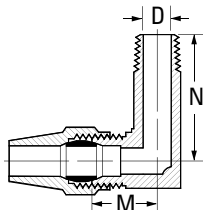
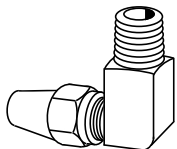

Tube O.D.	Male Pipe Thread	Catalog Number	D	M	N
3/8	1/4	1369x6L	.312	0.81	1.44
1/2	3/8	1369x8L	.406	1.25	1.38



# Brass Products

## Air Brake - Copper Tubing

**Union Tee**  
(Ref. SAE No. 120401BA)

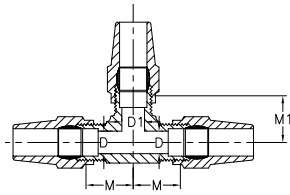
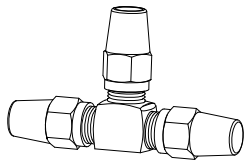

Tube O.D.	Catalog Number	M	M1	D	D1
3/8	1364x6	0.80	0.80	.314	.314
1/2	1364x8	0.94	0.94	.406	.406

**Male Run Tee**  
(Ref. SAE No. 120424BA)

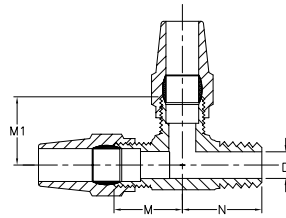
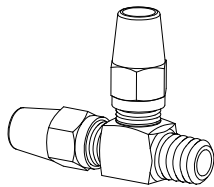

Tube O.D.	Male Pipe Thread	Catalog Number	D	M	M1	N
3/8	1/4	1371x6	.312	0.80	0.80	0.93
3/8	3/8	1371x6x6x6	.406	0.85	0.85	0.92

**Male Branch Tee**  
(Ref. SAE No. 120425BA)

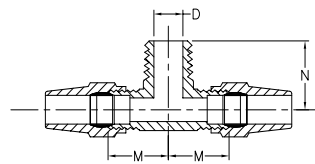
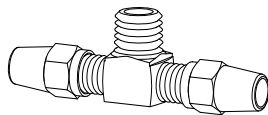

Tube O.D. A	Tube O.D. B	Male Pipe Thread	Catalog Number	D	M	N
3/8	3/8	1/4	1372x6	.312	0.82	0.93
3/8	3/8	3/8	1372x6x6x6	.406	0.85	0.92
1/2	1/2	3/8	1372x8	.406	0.94	1.00

# Brass Products

## Air Brake - Copper Tubing

Draincock

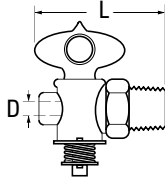
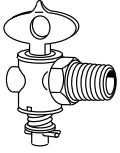

Male Pipe Thread	Catalog Number	D	L
1/4	W15310	.188	1.56

Shut Off Valve

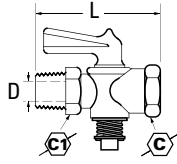
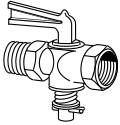

Male Pipe Thread	Fem. Pipe Thread	Catalog Number	C	C1	D	L
1/4	1/4	W20332	5/8	3/4	.218	1.81

Rating: 125 psi with one 1/4" bubble in 5 seconds permissible key leakage.

# Brass Products

## Threaded Sleeve

**Note:**  
For additional technical questions, contact Technical Support at 1-888-258-0222.

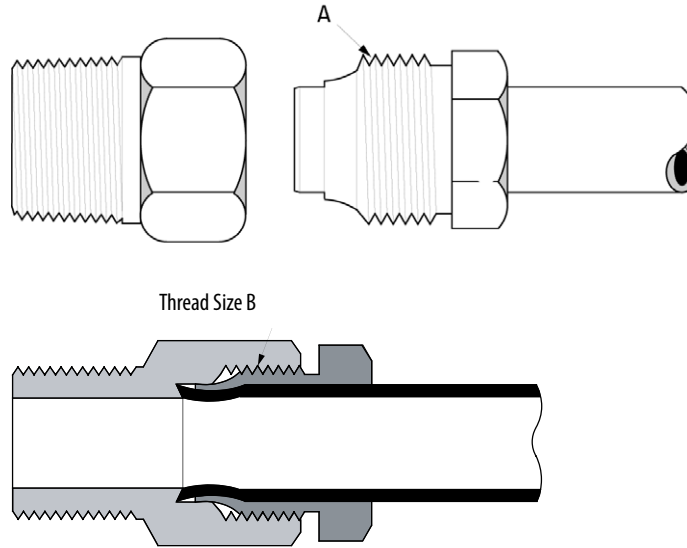

<b>Tube O.D.</b>	1/8	3/16	1/4	5/16	3/8
<b>Thread Size-B</b>	5/16-24	3/8-24	7/16-24	1/2-20	9/16-20

**Typical Application:**

Oil, air, water and lubrication systems.

**Pressure:**

Operating pressure of 500 psi for 1/8" to 1/4" sizes, 250 psi for 5/16" and 3/8" sizes.

**Vibration:**

Fair resistance.

**Temperature Range:**

-65°F to +250°F (-53°C to +121°C) range at maximum operating pressures.

**Material:**

CA360 Brass.

**Used With:**

Aluminum and copper tubing. Not recommended for steel tubing.

**Advantages:**

Easy to assemble, no flaring. Two (2) piece construction.

**Conformance:**

Meets ASA and ASME specifications.

**How to Order:**

Order individually by catalog number.

**Note:**

Refer to current price list for availability of cataloged items. Quotations and delivery of non-stock items supplied on request. Configurations and dimensions subject to change without notice.

**Assembly Instructions:**

1. Cut tubing to desired length.
2. Slide nut on end of tube. Threaded end "A" of nut must face toward connector.
3. Insert tube into connector body. Be sure tube is bottomed on connector shoulder.
4. Lubricate threads and assemble nut to connector body.
5. From that point, tighten. Tighten nut, hand tight. From hand tight, tighten with a wrench 1-1/2 additional turns to form proper seal.

# Brass Products

## Threaded Sleeve

Nut

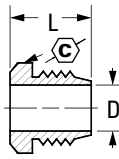
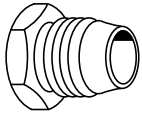

Tube O.D.	Catalog Number		D	L
1/8	6100x2	3/8	.130	0.50
3/16	6100x3	7/16	.193	0.53
1/4	6100x4	1/2	.255	0.56
5/16	6100x5	9/16	.318	0.61
3/8	6100x6	5/8	.380	0.61

♦MTO - Made To Order

Male Connector

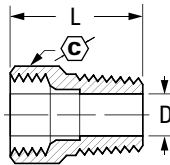
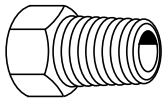

Tube O.D.	Male Pipe Thread	Catalog Number		D	L
1/8	1/8	6200x2	7/16	.078	0.62
1/8	*	6200x2x21 7/16	.080	0.62	
3/16	1/8	6200x3	7/16	.141	0.69
1/4	1/8	6200x4	1/2	.188	0.75
5/16	1/8	6200x5	9/16	.219	0.89
3/8	1/4	6200x6	5/8	.312	0.97

\*Thread Size 1/4-28 Tapered Male Thread.

♦MTO - Made To Order

Male Elbow

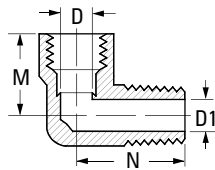
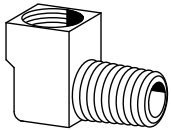

Tube O.D.	Male Pipe Thread	Catalog Number	D	D1	M	N
1/8	1/8	6400x2	.073	.125	0.50	0.66
1/8	*	6400x2x21	.078	.080	0.50	0.52
3/16	1/8	6400x3	.141	.156	0.56	0.62
1/4	1/8	6400x4	.188	.188	0.52	0.62

\*Thread Size 1/4-28 Tapered Male Thread.

# Brass Products

## Pipe

**Note:**  
For additional technical questions, contact Technical Support at 1-888-258-0222.

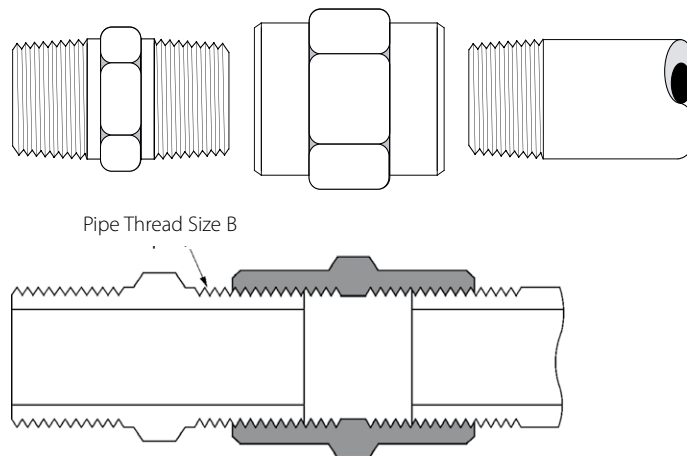

Pipe Size	1/16	1/8	1/4	3/8	1/2	3/4
Thread Size-B	1/16-27	1/8-27	1/4-18	3/8-18	1/2-14	3/4-14

### Typical Application:

Grease, refrigeration, instrumentation and hydraulic systems. Fuel, LP and natural gas available on special order.

### Pressure:

Operating pressure up to 1200 psi.

### Vibration:

Fair resistance.

### Temperature Range:

-65°F to +250°F  
(-53°C to +121°C).

### Material:

CA360 Brass.

### Used With:

Brass, bronze and iron pipe.

### Advantages:

Dryseal pipe threads (NPTF). Large range of sizes and configurations.

### Conformance:

Listed by Underwriters Laboratories (available on special order) for fuel equipment, refrigeration and gas. Meets specifications and standards of ASA, ASME and SAE.

### How to Order:

Order individually by catalog number. Example: 3325x4. To order with pipe sealant (Seal-A-Thread), add a "Z" suffix to the catalog number. (Special order only). Example: 3325x4Z.

### Note:

Refer to current price list for availability of cataloged items. Quotations and delivery of non-stock items supplied on request. Configurations and dimensions subject to change without notice. Additional information can be found in SAE J530 Automotive Pipe Fittings and SAE J531 Drain Plugs.

### Assembly Instructions:

1. Tighten approximately 2-1/2 turns past hand tight.
2. Connectors with Seal-A-Thread tighten two turns past hand tight. Brittle materials require special cautions.

### Label Set:

W-8022 (adhesive)  
CL-490 (non-adhesive)

# Brass Products

## Pipe

Cap

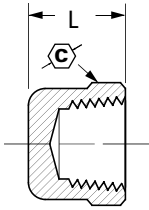
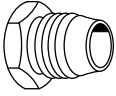

Fem. Pipe Thread	Catalog Number	C	L
1/8*	3129x2	9/16	.50
1/4*	3129x4	11/16	.59
3/8*	3129x6	13/16	.68

\*PTF Short Thread

Slotted Plug

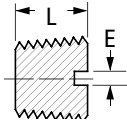

Male Pipe Thread	Catalog Number	E	L
1/8*	3150x2	.05	.28
1/4*	3150x4	.08	.42
3/8*	3150x6	.09	.43

\*PTF Short Thread

Square Head Plug

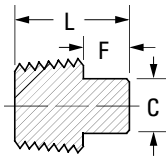
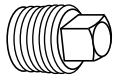

Male Pipe Thread	Catalog Number	Square C	F	L
1/8*	3151x2	.28	.24	.58
1/4*	3151x4	.37	.29	.74
3/8*	3151x6	.43	.32	.82
1/2*	3151x8	.56	.39	.99
3/4*	3151x12	.62	.43	1.12

\*PTF Short Thread

Hex Head Plug

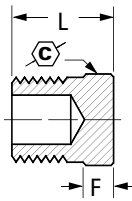
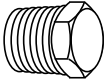

Male Pipe Thread	Catalog Number	C	F	L
1/8*	3152x2	7/16	.19	.57
1/4*	3152x4	9/16	.18	.62
3/8*	3152x6	11/16	.22	.72
1/2*	3152x8	7/8	.22	.78
3/4**	3152x12	1-1/16	.25	.88

\*PTF Short Thread

\*\*PTF Special Short Thread

Hex Socket Plug

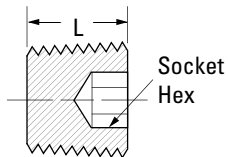

Male Pipe Thread	Catalog Number	Socket Hex	L
1/8	3153x2	3/16	.270
1/4	3153x4 ♦	1/4	.410
3/8	3153x6 ♦	5/16	.410
1/2	3153x8 ♦	3/8	.540

♦MTO - Made To Order

Adapter

(Ref. SAE No. 130139)

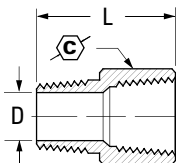
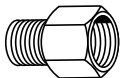

Fem. Pipe Thread	Male Pipe Thread	Catalog Number	C	D	L
1/8	1/8	3200x2	9/16	.219	.88
1/4	1/8	3200x4x2	3/4	.219	1.06
1/4	1/4	3200x4	3/4	.312	1.25
3/8	1/4	3200x6x4	7/8	.312	1.25
3/8	3/8	3200x6	7/8	.438	1.25
1/2	3/8	3200x8x6	1-1/16	.438	1.47
3/4	3/8	3200x12x6 1-1/4	.438	1.59	
3/4	1/2	3200x12x8 1-1/4	.562	1.69	

# Brass Products

## Pipe

### Bushing

(Ref. SAE No. 130140)

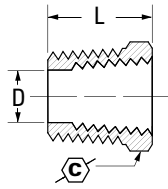
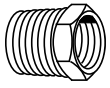

Male Pipe Thread	Fem. Pipe Thread	Catalog Number		D	L
1/4*	1/8	3220x4x2	5/8	.339	0.59
3/8	1/8	3220x6x2	11/16	.328	0.75
3/8*	1/4	3220x6x4	11/16	.438	0.69
1/2*	1/8	3220x8x2	7/8	.530**	0.75
1/2*	1/4	3220x8x4	7/8	.438**	0.75
1/2*	3/8	3220x8x6	7/8	.562	0.75
3/4*	3/8	3220x12x6	1-1/8	.562	0.88
3/4*	1/2	3220x12x8	1-1/8	.703	0.88

\*PTF Short Thread

\*\*Optional Counterbore

### Union

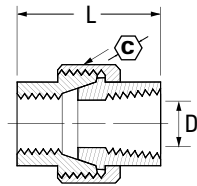
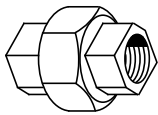

Fem. Pipe Thread	Catalog Number		D	L
1/4*	3250x4	1-1/16	.438	1.31
1/2	3250x8	1-9/16	.703	1.81

\*PTF Short Thread

### Coupling

(Ref. SAE No. 130138)

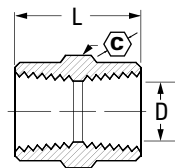
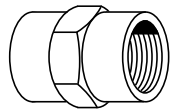

Fem. Pipe Thread	Catalog Number		D	L
1/16	3300x1	7/16	.339	0.75
1/8	3300x2	9/16	.339	0.75
1/4	3300x4	3/4	.438	1.12
3/8	3300x6	7/8	.578	1.12
1/2	3300x8	1-1/16	.703	1.50
3/4	3300x12	1-1/4	.906	1.53

### Reducer Coupling

(Ref. SAE No. 130138)

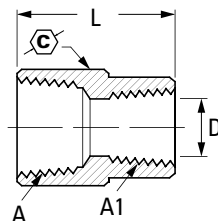
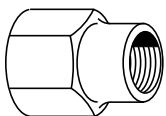

Fem. Pipe Thread A	Fem. Pipe Thread A1	Catalog Number		D	L
1/4	1/8	3300x4x2	3/4	.339	0.96
3/8	1/8	3300x6x2	7/8	.339	0.94
3/8	1/4	3300x6x4	7/8	.438	1.16
1/2	3/8	3300x8x6	1-1/16	.562	1.38

# Brass Products

## Pipe

### Hex Nipple

(Ref. SAE No. 130137)

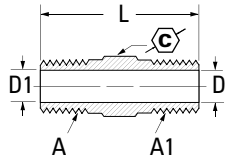
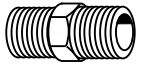

Male Pipe Thread A	Male Pipe Thread A1	Catalog Number		D	D1	L
1/16	1/16	3325x1	3/8	.125	.125	.978
1/8	1/16	3325x2x1	7/16	.230	.156	.955
1/8	1/8	3325x2	7/16	.219	.219	0.97
1/4	1/8	3325x4x2	9/16	.219	.219*	1.19
1/4	1/4	3325x4	9/16	.312	.312	1.38
3/8	1/8	3325x6x2	11/16	.219	.438	1.22
3/8	1/4	3325x6x4	11/16	.312	.438	1.41
3/8	3/8	3325x6	11/16	.438	.438	1.41
1/2	1/2	3325x8	7/8	.562	.562	1.81
3/4	3/4	3325x12	1-1/16	.750	.750	1.94

\*Optional .312 Counterbore on 1/4" side.

### Close Nipple

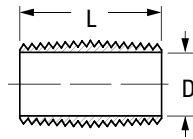
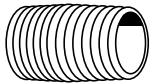

Male Pipe Thread	Catalog Number	D	L
1/8	3326x2	.281	0.75
1/4	3326x4	.375	0.88
3/8	3326x6	.500	1.00
1/2	3326x8	.625	1.12
3/4	3326x12	.750	1.38

### Long Nipple

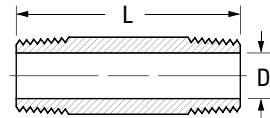
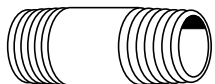

Male Pipe Thread	Catalog Number	D	L
1/8	3327x2	.281	1.50
1/8	3328x2	.281	2.00
1/8	3329x2	.281	2.50
1/8	3330x2	.281	3.00
1/8	3331x2 ♦	.281	3.50
1/4	3327x4	.375	1.50
1/4	3328x4	.375	2.00
1/4	3329x4	.375	2.50
1/4	3330x4	.375	3.00
1/4	3331x4	.375	3.50
3/8	3327x6	.480	1.50
3/8	3328x6	.490	2.00
3/8	3329x6	.480	2.50
3/8	3330x6	.480	3.00
3/8	3331x6 ♦	.480	3.50
1/2	3328x8	.625	2.00
1/2	3329x8	.625	2.50
1/2	3330x8	.625	3.00
3/4	3328x12 ♦	.750	2.00
3/4	3329x12	.750	2.50

♦MTO - Made To Order



# Brass Products

## Pipe

### 45° Street Elbow

(Ref. SAE No. 130339)

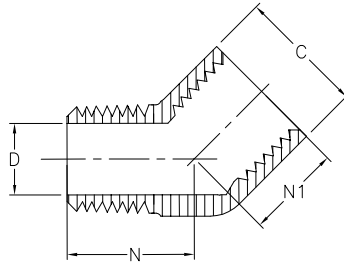
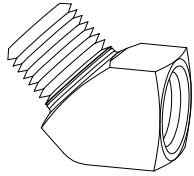

Male Pipe Thread	Fem. Pipe Thread	Catalog Number	C	D	N	N1
1/8	1/8	3350x2	9/16	.219	0.50	0.38
1/4	1/4	3350x4	11/16	.312	0.74	0.56
3/8	3/8	3350x6	13/16	.438	0.78	0.56
1/2	1/2	3350x8	1	.562	1.00	0.75
3/4	3/4	3350x12	1-1/4	.750	1.06	0.75

### 90° Street Elbow

(Ref. SAE No. 130239)

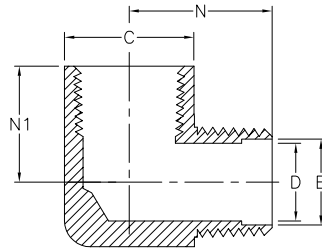
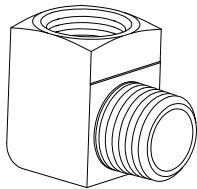

Fem. Pipe Thread	Male Pipe Thread	Catalog Number	C	D	E	N	N1
1/8	1/8	3400x2	9/16	.219	0.25	0.66	0.47
1/8*	1/8**	3400x2W	1/2	.188	0.25	0.57	0.34
1/4	1/8	3400x4x2	11/16	.219	-	0.72	0.53
1/4*	1/4**	3400x4W	11/16	.266	0.36	0.78	0.45
1/4	1/4	3400x4	11/16	.312	-	0.91	0.72
3/8	3/8	3400x6	13/16	.438	-	0.98	0.72
1/2	1/2	3400x8	1	.562	-	1.25	1.04
3/4	3/4	3400x12	1-1/4	.750	-	1.38	1.12

\*PTF short thread.

\*\*PTF special short thread.

# Brass Products

## Pipe

### 90° Elbow

(Ref. SAE No. 130238)

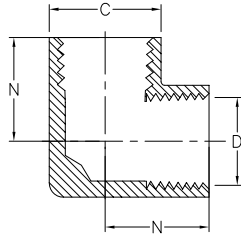
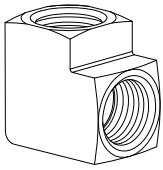

Fem. Pipe Thread	Catalog Number	C	D	N
1/8	3500x2	9/16	.339	0.55
1/4	3500x4	11/16	.438	0.78
3/8	3500x6	3/4	.562	0.84
1/2	3500x8	1	.703	1.09
3/4	3500x12	1-1/4	.891	1.16

### Male Branch Tee

(Ref. SAE No. 130425)

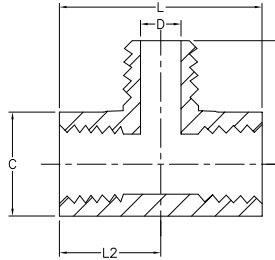
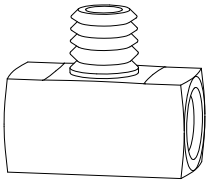

Fem. Pipe Thread	Male Pipe Thread	Catalog Number	C	D	L	L2	N
1/8	1/8	3600x2	9/16	.219	1.10	0.55	0.67
1/4	1/4	3600x4	11/16	.312	1.56	0.78	0.91
3/8	3/8	3600x6	13/16	.438	1.68	0.84	0.97
1/2	1/2	3600x8	1	.562	2.18	1.09	1.25
3/4	3/4	3600x12	1-1/4	.750	2.32	1.16	1.38

### Tee

(Ref. SAE No. 130438)

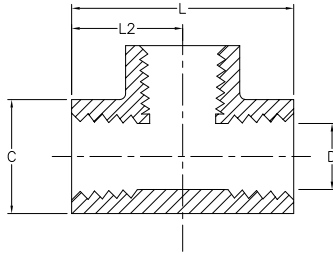
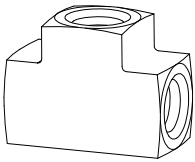

Fem. Pipe Thread	Catalog Number	C	D	L	L2
1/8	3700x2	9/16	.339	1.10	0.55
1/4	3700x4	11/16	.438	1.56	0.78
3/8	3700x6	13/16	.562	1.68	0.84
1/2	3700x8	1	.703	2.18	1.09
3/4	3700x12	1-1/4	.906	2.32	1.16

### Male Run Tee

(Ref. SAE No. 130424)

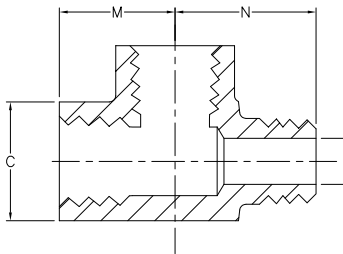
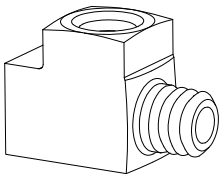

Fem. Pipe Thread	Male Pipe Thread	Catalog Number	C	D	M	N
1/8	1/8	3750x2	9/16	.219	0.55	0.67
1/4	1/4	3750x4	11/16	.312	0.78	0.92
3/8	3/8	3750x6	13/16	.438	0.84	0.97
1/2	1/2	3750x8	1	.562	1.09	1.27
3/4	3/4	3750x12	1-1/4	.750	1.16	1.38

### Cross

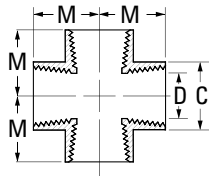
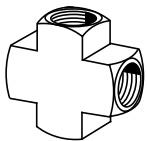

Fem. Pipe Thread	Catalog Number	C	D	M
1/8	3950x2	1/2	.339	0.50
1/4	3950x4	11/16	.438	0.75
3/8	3950x6	7/8	.562	0.81
1/2	3950x8	1	.703	1.09

# Brass Products

## Pipe

**Straight**  
SAE J2044

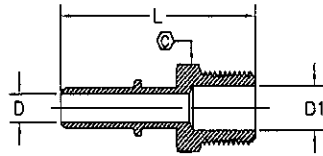
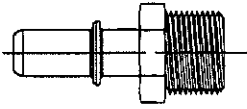

Male Pipe Thread	Catalog Number	D	D1	Ⓢ	L
1/8-27	FF3959-0204B	.15	.19	7/16	1.78
1/8-27	FF3959-0205B	.19	.19	7/16	1.79
1/4-18	FF3959-0406B	.26	.26	9/16	2.00
3/8-18	FF3959-0606B	.26	.41	11/16	2.03
3/8-18	FF3959-0608B	.33	.41	11/16	2.25
1/2-14	FF3959-0806B	.26	.53	7/8	2.28
1/2-14	FF3959-0808B	.33	.53	7/8	2.50
1/2-14	FF3959-0810B	.45	.53	7/8	2.50

**90° Elbow**  
SAE J2044

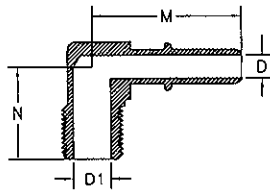

Male Pipe Thread	Catalog Number	D	D1	M	N
1/8-27	FF3960-01-0204B	.15	.19	1.50	.73
3/8-18	FF3960-01-0606B	.26	.41	1.62	1.00
3/8-18	FF3960-01-0608B	.33	.41	1.80	1.00
1/2-14	FF3960-01-0808B	.33	.53	1.89	1.20
1/2-14	FF3960-01-0810B	.45	.53	1.94	1.22
1/8-27	FF3960-0205B	.20	.19	1.65	.73

# Brass Products

## Needle Valves

**Note:**  
For additional technical questions, contact Technical Support at 1-888-258-0222.

 Refer to safety information regarding proper selection of tubing and tube connectors on page 5.

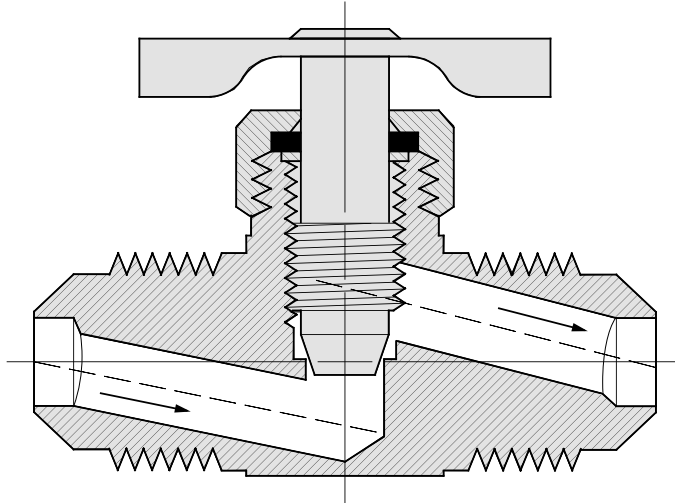

**Typical Application:**  
Instrumentation, hydraulic and pneumatic systems.

**Pressure:**  
150 psi maximum. (Does not include plastic tubing.)

**Temperature Range:**  
-65°F to +250°F (-53°C to +121°C) with metal tubing. For valves using compatible tubing, refer to the tubing temperature range.

**Material:**  
Brass bodies, steel handles except where noted. Polyline valves have brass bodies and brass handles.

**Used With:**  
Copper, aluminum, steel and plastic tubing where applicable.

**Advantages:**  
Metal-to-metal seat, with fine thread screw down, enables valves to seat positively, adjust easily and hold to any amount of flow up to capacity of the valve.

**Conformance:**  
Designed for automotive and industrial use. Not intended for natural gas, LPG, nuclear or aircraft applications.

**How to Order:**  
Order valve body, nuts and sleeves by catalog number. Order valve with Selfalign nuts and sleeves by adding suffix "S". Example: A6763 becomes A6763S. Order valves less nuts and sleeves by adding prefix "B". Example: A6763 becomes B6763.

**Assembly Instructions:**  
Install with the pressure against the seat. Inspection of a straight valve discloses one opening to be higher than the other. Pressure should always be directed against the seat in angle valves, not the stem threads.

# Brass Products

## Needle Valves

### Compression Double

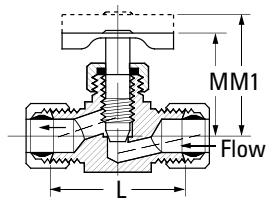
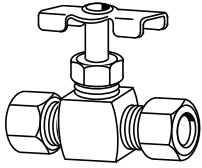

Tube O.D.	Catalog Number	L	M	M1
3/16	A6763	1.06	0.88	1.03
1/4	A6765	1.13	0.88	1.03
1/4	A6765S	1.13	0.88	1.03
5/16	A6770	1.13	0.88	1.03
3/8	A6775	1.50	1.13	1.31

"S" suffix designates Selfalign with nuts and sleeves.

### Compression Straightway

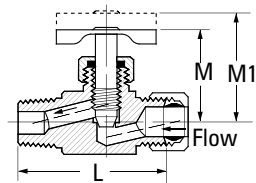
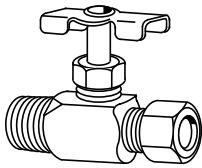

Tube O.D.	Male Pipe Thread	Catalog Number	L	M	M1
3/16	1/8	A6690	1.16	0.88	1.03
3/16	1/8	A6690S	1.16	0.88	1.03
1/4	1/8	A690	1.19	0.88	1.03
1/4	1/8	A690S	1.19	0.88	1.03
5/16	1/8	A660	1.18	0.90	1.05
5/16	1/4	A6755	1.28	0.91	1.09
5/16	1/4	A6755S	1.28	0.91	1.09
3/8	1/4	A6760	1.82	1.31	1.46
3/8	1/4	A6760S	1.82	1.31	1.46

"S" suffix designates Selfalign with nuts and sleeves.

### Compression Angle

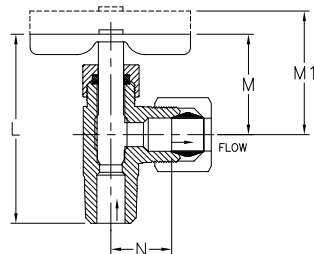
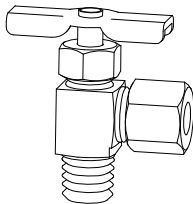

Tube O.D.	Male Pipe Thread	Catalog Number	L	M	M1	N
3/16	1/8	A6845	1.50	0.82	1.07	0.50
1/4	1/8	A555	1.53	0.83	1.05	0.61
1/4	1/8	A555S	1.53	0.83	1.05	0.53
5/16	1/8	A655	1.56	0.84	1.09	0.52
5/16	1/4	A6855	1.73	0.92	1.28	0.69
5/16	1/4	A6855S	1.73	0.92	1.28	0.69
3/8	1/4	A6860	1.64	0.83	1.28	0.78
3/8	1/4	A6860S	1.64	0.83	1.28	0.78

"S" suffix designates Selfalign with nuts and sleeves.

### Inverted Straightway

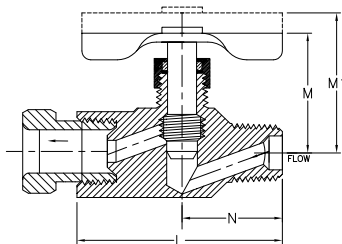
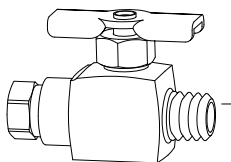

Tube O.D.	Male Pipe Thread	Catalog Number	L	M	M1	N
1/4	1/8	B735	1.41	0.84	1.01	0.72

"B" prefix designates less inverted nut.

For replacement nut use 105x4.  
See page 35.

# Brass Products

## Needle Valves

### SAE 45° Flare Straightway

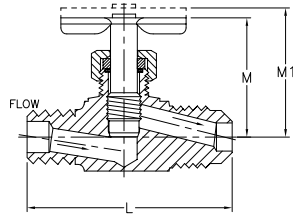
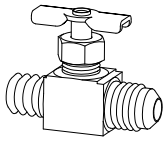

Tube O.D.	Male Pipe Thread	Catalog Number	L	M	M1
5/16	1/8	630	1.38	0.95	1.13

### Polyline Straightway

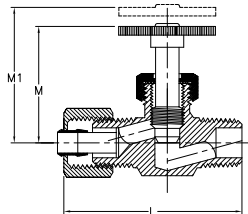
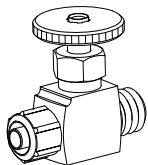

Tube O.D.	Male Pipe Thread	Catalog Number	L	M	M1
1/4	1/8	A690P	1.19	0.86	1.01
3/8	1/4	A6760P	1.50	1.18	1.33

### Temperature Range:

-40°F to +150°F with plastic sleeve.

For replacement Polyline nuts and sleeves, see page 57.

### Polyline Angle

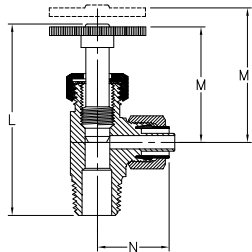
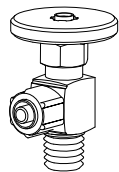

Tube O.D.	Male Pipe Thread	Catalog Number	L	M	M1	N
1/4	1/8	A555P	1.50	0.82	1.04	0.69
1/4	1/4	A556P	1.70	0.84	1.06	0.56
3/8	1/4	A6860P	1.85	0.99	1.44	0.88

### Temperature Range:

-40°F to +150°F with plastic sleeve.

For replacement Polyline nuts and sleeves, see page 57.

# Brass Products

## Drain Cocks

### Internal Seat Drain Valve

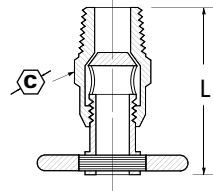
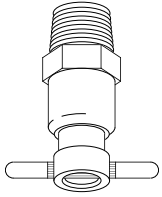



Male Pipe Thread	Catalog Number		L
1/8	1424A	1/2	1.219
1/4	1425A	9/16	1.313
3/8	1426A	11/16	1.688

# Brass Products

## Drain Cocks

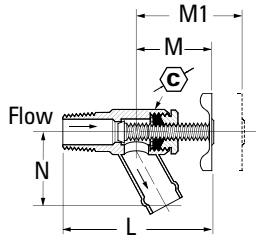
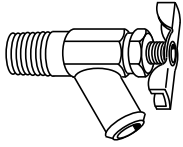
**Hose to Pipe**  
(Steel Body)



Hose Size	Male Pipe Thread	Catalog Number		L	M	M1	N
5/8	3/8	211273A	11/16	2.85	1.41	1.91	1.30

**Hose to Pipe**  
(Steel Body)

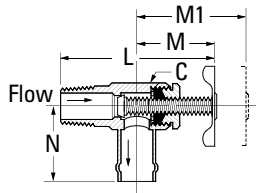
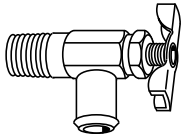

Hose I.D.	Male Pipe Thread	Catalog Number	Square C	L	M	M1	N
5/8	3/8	211280A	11/16	2.85	1.10	1.47	1.19

**Air Tank Drain Valve**

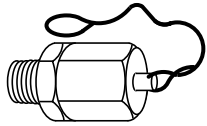

Pull cable sideways.

Male Pipe Thread	Cable Length	Catalog Number
1/4	7"	1421-7
1/4	18"	1421-18
1/4	24"	1421-24
1/4	32"	1421-32
1/4	60"	1421-60
1/4	60"	1421-60A*

\*No loop on cable end.



# Brass Products

## Trucks Valves

**Typical Application:**

Used extensively in the trucking industry for cooling and fuel line applications.

**Material:**

Forged brass bodies, steel handles.

**Pressure Range:**

200 psi maximum.

**Temperature:**

-40°F to +250°F  
(-40°C to +121°C)

**Conformance:**

Designed for trucking use. Not intended for natural gas, LPG, nuclear or aircraft applications.

**Note:**

Buna-N o-ring sealed;

Truck Valve

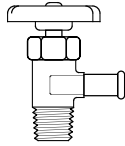

Hose I.D.	Pipe Thread	Catalog Number
3/8	3/8	7506

# Brass Products

## Plastic Drain Cocks

**Material:**  
Nylon 6 Fiber Reinforced.

**Pressure Range:**  
Up to 25 psi.

**Used With**  
Automotive Radiators:

**Temperature:**  
-50°F to +180°F  
(-46°C to +82°C)

**Conformance:**  
Designed for automotive use.  
Not intended for  
natural gas, LPG, nuclear  
or aircraft applications.

**M10x1.25**

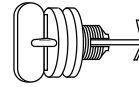

**Ford**

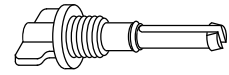

Thread	Catalog Number
M10x1.25	118

Thread	Catalog Number
M14x2.0	124

**Chrysler**

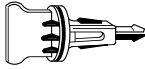

**M12x1.25**



**M12x1.5**

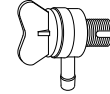

**Chrysler**

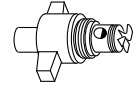

Thread	Catalog Number
Captive	110

Thread	Catalog Number
M12x1.25	114

Thread	Catalog Number
M12x1.5	119

Thread	Catalog Number
5/8-18	125

**GM**

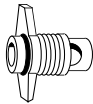

**M14x1.25**

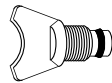

**Ford and Mazda**

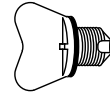

**Chrysler**

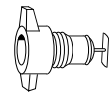

Thread	Catalog Number
Oversized	111

Thread	Catalog Number
M14x1.25	115

Thread	Catalog Number
M10x1.25	121

Thread	Catalog Number
5/8-18	126

**Ford (Long)**

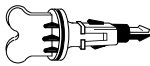

**M10x1.25**

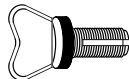

**M14x2.0**

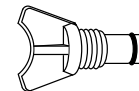

**GM**

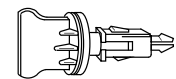

Thread	Catalog Number
Captive	112

Thread	Catalog Number
M10x1.25	116

Thread	Catalog Number
M14x2.0	122

Thread	Catalog Number
Captive	127

**Ford (Short)**

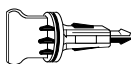

**M14x1.25**

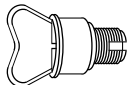

**Chrysler**

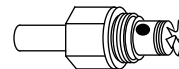

**GM**

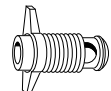

Thread	Catalog Number
Captive	113

Thread	Catalog Number
M14x1.25	117

Thread	Catalog Number
5/8-18	123

Thread	Catalog Number
1/2-18	128

# Brass Products

## Ground Plug & Multiple Shut-Offs

**Note:**  
For additional technical questions, contact Technical Support at 1-888-258-0222.

 Refer to safety information regarding proper selection of tubing and tube connectors on page 5.

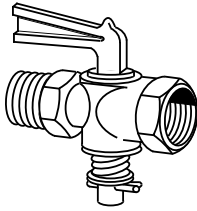
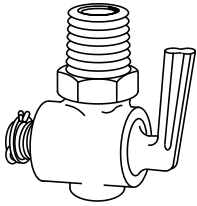

**Pressure Range:**  
30 psi working pressure, except where noted.

**Used With:**  
Copper, aluminum, steel and plastic tubing where applicable.

**Material:**  
Brass bodies and handles.

**Temperature:**  
-65°F to +250°F (-53°C to +121°C) with metal tubing. For use with plastic tubing, refer to the tubing temperature range.

**Conformance:**  
Designed for automotive or industrial use. Not intended for natural gas, LPG, nuclear or aircraft applications, except as noted.

**Ordering Information:**  
Order valve body, nut and sleeves by catalog number. Order valves with Selfalign nuts and sleeves by adding suffix "S". Example: A694S. Order valves less nut and sleeve by adding prefix "B". Example: B694.

**Note:**  
Ground Plug Drains and Shut-Offs use a universal lubricant satisfactory for use with most common fluids. However the lubricant may wash out at higher pressures or with some exotic fluids.

### Draincock

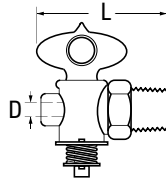

**Ratings:**  
Valves are designed to hold air pressure of 125 psi with one 1/4" bubble in 5 seconds permissible key leakage.

Male Pipe Thread	Catalog Number	D	L
1/4	W15310	.188	1.56

# Brass Products

## Ground Plug & Multiple Shut-Offs

### Compression Double

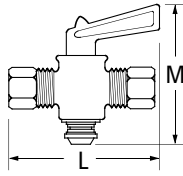
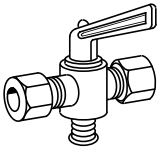

Tube O.D.	Catalog Number	L	M
1/4	A6769	2.12	1.88
1/4	A6769S	2.12	1.88
5/16	A6774	2.19	1.88
3/8	A6779	2.25	1.88
3/8	A6779S	2.25	1.88

"S" suffix designates Selfalign with Nuts and Sleeves.

### Compression Straightway

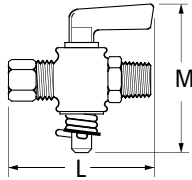
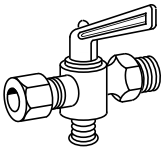

Tube O.D.	Male Pipe Thread	Catalog Number	L	M
1/4	1/8	A694	2.19	1.88
1/4	1/8	A694S	2.19	1.88
1/4	1/4	A6754	2.19	1.88
1/4	1/4	A6754S	2.19	1.88
5/16	1/8	A664	2.19	1.88
5/16	1/4	A6759	2.25	1.88
3/8	1/4	A6764	2.38	1.88
3/8	1/4	A6764S	2.38	1.88

"S" suffix designates Selfalign with Nuts and Sleeves.

### Truck Shut Off Male to Female Pipe

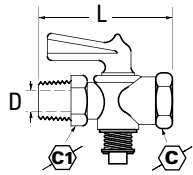
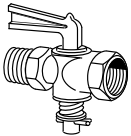

Male Pipe Thread	Female Pipe Thread	Catalog Number			L	D
1/4	1/4	W20332	5/8	3/4	1.81	.218

#### Ratings:

Valves are designed to hold air pressure of 125 psi with one 1/4" bubble in 5 seconds permissible key leakage.

# Brass Products

## Brass Ball Valves

### Forged Body Brass 3-Way Ball Valve

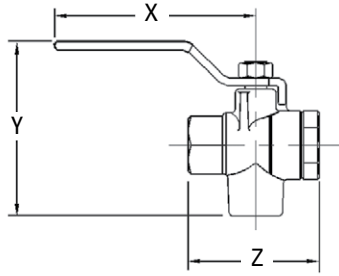

#### Features/Benefits

- Forged brass body
- Blowout proof stem
- Chrome plated ball
- Double o-ring stem seal - never needs tightening
- Floating ball design
- Standard steel handle

#### Applications

- Vacuum service
- Industrial service
- Machine/engine coolant
- Center off position
- Diverter valve

#### Part No.

Part No.	Connections	Size	X	Y	Z
FF90587-04	F x F x F NPT	1/4"	3.20	3.12	2.25
FF90587-06	F x F x F NPT	3/8"	3.20	3.12	2.25
FF90587-08	F x F x F NPT	1/2"	3.20	3.12	2.25

#### Service

- Working pressure: 500 psig bottom inlet@ 70°F; 100 psig side inlets
- Temperature range: -40°F + 300°F
- Orifice diameters:  
1/4" = .440",  
3/8" = .500",  
1/2" = .500"

- Vacuum rating: Full
- For: Water, oils and gases

**Note:** Not steam rated.

### Forged Body Brass Ball Valve

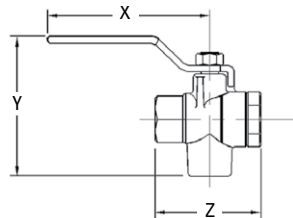
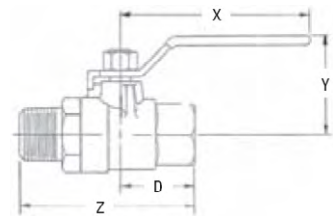

#### Features/Benefits

- Forged brass body
- Blowout proof stem
- Chrome plated brass ball
- Double o-ring stem seal
- Tamper proof design
- Floating ball design
- Standard steel handle
- 1/4 turn - full on/off

#### Applications

- Vacuum service
- Industrial service
- Machine/engine coolant
- Water service
- Fuel tank - gasoline/ diesel

#### Part No.

Part No.	Connections	Size	X	Y	Z	D
FF90588-04	M x F NPT	1/4"	3.70	2.38	2.75	1.13
FF90588-06	M x F NPT	3/8"	3.70	2.38	2.75	1.13
FF90588-08	M x F NPT	1/2"	3.70	2.38	2.75	1.13
FF90588-12	M x F NPT	3/4"	3.80	2.72	3.40	1.43
FF90588-16	M x F NPT	1"	4.50	3.00	4.00	1.71
FF90588-20	M x F NPT	1-1/4"	6.22	3.01	4.05	1.83
FF90588-24	M x F NPT	1-1/2"	6.22	3.24	4.35	2.01
FF90588-32	M x F NPT	2"	6.22	3.52	5.13	2.38

#### Part No.

Part No.	Connections	Size	X	Y	Z
FF90589-04	F x F x F NPT	1/4"	3.70	2.38	2.25
FF90589-06	F x F x F NPT	3/8"	3.70	2.38	2.25
FF90589-08	F x F x F NPT	1/2"	3.70	2.38	2.25
FF90589-12	F x F x F NPT	3/4"	3.80	2.72	2.98
FF90589-16	F x F x F NPT	1"	4.50	3.00	3.34
FF90589-20	F x F x F NPT	1-1/4"	6.20	3.78	3.65
FF90589-32	F x F x F NPT	2"	6.20	4.75	4.76

#### Service

- Working pressure: 600 psig WOG @ 70°F
- Temperature range: -40°F + 300°F
- Orifice diameters:  
1/4" = .44", 3/8" = .50",  
1/2" = .50", 3/4" = .69,  
1" = .88, 1-1/4" = 1.18,  
1-1/2" = 1.57, 2" = 1.89

- Vacuum rating: Full
- For: Water, oils and gases

**Note:** Not steam rated.

# Brass Products

## Brass Ball Valves

### Brass Instrumentation 3-Way Ball Valve

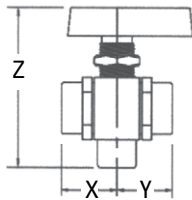

Part No.	Connections	Size	X	Y	Z
FF90597-02	F x F NPT	1/8"	0.92	0.92	2.12
FF90597-04	F x F NPT	1/4"	0.92	0.92	2.12
FF90597-06	F x F NPT	3/8"	1.10	1.10	2.59
FF90597-08	F x F NPT	1/2"	1.19	1.19	2.59
FF90598-02	Compression	1/8"	0.92	0.92	2.12
FF90598-04	Compression	1/4"	0.92	0.92	2.12
FF90598-06	Compression	3/8"	1.10	1.10	2.59
FF90598-08	Compression	1/2"	1.19	1.19	2.59

#### Features/Benefits

- Brass bar stock body
- Blowout proof stem
- Nickel plated ball
- Viton stem seal
- Double o-ring stem seal - never needs tightening
- Metal retainer seal
- Center off position
- Seals: Ball seats = teflon, stem seals = 2 o-rings (Viton & Buna-n)

#### Applications

- Vacuum service
- Industrial service
- Center off position
- Water service
- Panel mounting

#### Services

- Working pressure: 1/8" & 1/4"=1500 psig @ 70oF 3/8" & 1/2"= 1,000 psig @ 70°F (side port inlet) 1000 psig (bottom port inlet)
- Temperature range: -40°F + 300°F
- Orifice diameters: 1/8" & 1/4"=.250" 3/8" & 1/2"=.340"
- Vacuum rating: Full
- For: Water, oils and gases
- Panel mount hole size: 9/16" ID

**Note:** Not steam rated.

# Brass Products

## Brass Ball Valves

### Brass Instrumentation 2-Way 90 Degree Ball Valve

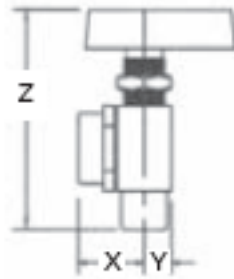

Part No.	Connections	Size	X	Y	Z
FF90595-02	F x F NPT	1/8"	0.92	0.38	2.12
FF90595-04	F x F NPT	1/4"	0.92	0.38	2.12
FF90595-06	F x F NPT	3/8"	1.10	0.75	2.59
FF90595-08	F x F NPT	1/2"	1.19	0.75	2.59
FF90596-02	Compression	1/8"	0.92	0.38	2.12
FF90596-04	Compression	1/4"	0.92	0.38	2.12
FF90596-06	Compression	3/8"	1.10	0.75	2.59
FF90596-08	Compression	1/2"	1.19	0.75	2.59

#### Features/Benefits

- Brass bar stock body
- Blowout proof stem
- Nickel plated brass ball
- Double o-ring stem seal
- Metal retainer seal
- 90° configuration eliminates fittings
- Seals: Ball seats = teflon, stem seals = 2 o-rings (Viton & Buna-n)

#### Applications

- Vacuum service
- Industrial service
- Water service
- Panel mount

#### Service

- Working pressure: 1/8" & 1/4"=1500 psig @ 70°F 3/8" & 1/2"= 1,000 psig @ 70°F (side port inlet) 1000 psig (bottom port inlet)
- Temperature range: -40°F + 300°F
- Orifice diameters: 1/8" & 1/4"=.250" 3/8" & 1/2"=.340"
- Vacuum rating: Full
- For: Water, oils and gases
- Panel mount hole size: 9/16" ID

**Note:** Not steam rated.

# Brass Products

## Brass Ball Valves

### Brass Mini-Instrumentation 2-Way 90 Ball Valve

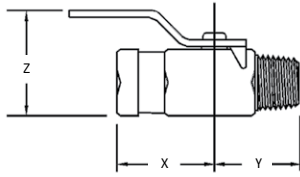

Part No.	Connections	Size	X	Y	Z
FF90590-02	M x F NPT	1/8"	1.13	0.75	1.25
FF90590-04	M x F NPT	1/4"	1.13	0.81	1.25
FF90591-02	M x M NPT	1/8"	1.13	0.75	1.25
FF90591-04	M x M NPT	1/4"	1.13	0.81	1.25
FF90592-02	F x F NPT	1/8"	1.13	0.75	1.25
FF90592-04	F x F NPT	1/4"	1.13	0.85	1.25

#### Features/Benefits

- Brass bar stock body
- Blowout proof stem
- Nickel plated ball
- Viton stem seal
- Standard metal handle
- Floating ball design
- 1/4 turn - full on/off

#### Applications

- Vacuum service
- Industrial service
- Coolant service
- Water service
- Compact shut off installations
- Low cost instrumentation
- Hose shut off

#### Service

- Working pressure: 1,000 psig WOG @ 70°F
- Temperature range: -40°F + 300°F
- Orifice diameters: 1/8" & 1/4"=.250"
- Vacuum rating: Full
- For: Water, oils and gases

**Note:** Not steam rated.

### Brass Instrumentation 2-Way Ball Valve

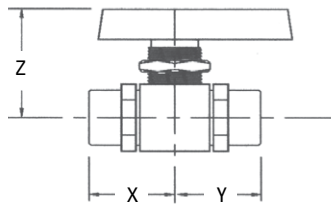

Part No.	Connections	Size	X	Y	Z
FF90593-02	F x F NPT	1/8"	0.92	0.92	1.25
FF90593-04	F x F NPT	1/4"	0.92	0.92	1.25
FF90593-06	F x F NPT	3/8"	1.10	1.10	1.42
FF90593-08	F x F NPT	1/2"	1.19	1.90	1.42
FF90594-02	Compression	1/8"	0.92	0.92	1.25
FF90594-04	Compression	1/4"	0.92	0.92	1.25
FF90594-06	Compression	3/8"	1.10	1.10	1.42
FF90594-08	Compression	1/2"	1.46	1.46	1.42

#### Features/Benefits

- Brass bar stock body
- Blowout proof stem
- Nickel plated ball
- Viton stem seal
- Metal retainer seal
- Seals: Ball seats = teflon, stem seals = 2 o-rings (Viton & Buna-n)

#### Applications

- Vacuum service
- Industrial service
- Water service
- Panel mounting

#### Service

- Working pressure: 1/8" & 1/4"=1500 psig @ 70°F  
3/8" & 1/2"=1000 psig @ 70°F

#### Service (cont)

- Temperature range: -40°F + 300°F
- Orifice diameters: 1/8" & 1/4"=.250"  
3/8" & 1/2"=.375"
- Vacuum rating: Full
- For: Water, oils and gases
- Panel mount hole size: 9/16" ID

**Note:** Not steam rated.



# Brass Products Special Adapters

 Refer to safety information regarding proper selection of tubing and tube connectors on page 3.

## Turbocharger Discharge Connector

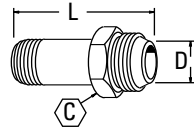

Male Straight Thread	Pipe	Male Catalog Thread	Number		D	L
1 AC-811	3/4	3/4	1408	1-3/8	.719	3.25
30° Flare Tube						

## Transmission Oil Coolant Line Adapter

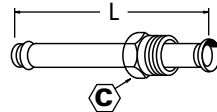

Tube O.D.	Inverted Nut	Catalog Number		L
5/16	5/16	1428	1/2	4.50
3/8	3/8	1429	5/8	4.50

## Truck Oil Line Extended SAE 45° Flare Fitting

(Replaces Roto Master No. 10-35)

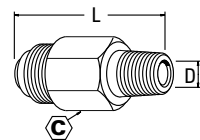

SAE 45° Tube Size	Male Pipe Thread	Catalog Number		D	L
3/8	1/4	1432	5/8	.282	1.90

# Brass Products

## Special Adapters

 Refer to safety information regarding proper selection of tubing and tube connectors on page 3.

Fuel Line Adapter

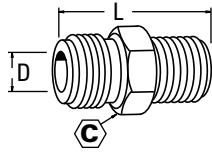

Inverted Male	Male Pipe Thread	Catalog Number		D	L
1/2-20	1/8	1514	1/2	.219	0.90

AC Type Adapter

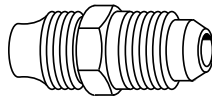

Tube O.D.	S.A.E. 45° Tube Size	Catalog Number		D	L
1/4	1/4	1521	7/16	.188	1.09

Adapter SAE 45° Flare to Inv. Flare

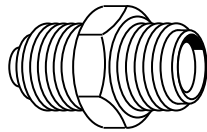

SAE 45° Tube Size	Inverted Male	Catalog Number		D	L
1/4	3/16	1518	7/16	.189	1.03
1/4	1/4	1522	7/16	.189	1.03
3/8	5/16	1553	5/8	.234	1.34
3/8	3/8	1563	5/8	.282	1.38
3/8	7/16	1554	11/16	.282	1.40

# Brass Products

## Special Adapters

 Refer to safety information regarding proper selection of tubing and tube connectors on page 3.

### Special Steel Bushing

Male Thread	Female Pipe Thread	Catalog Number		D	L
1-1/16-16UN-2A	1/8	7977	1-1/8	.328	.94
1-1/16-16UN-2A	3/8	7978	1-1/8	.562	.94

### Male JIC 37° Flare to Metric O-Ring Port Adapter

Steel (with o-ring)

#### Application:

GM power steering with Saginaw steering and rack and pinion steering systems.

Includes O-Ring.

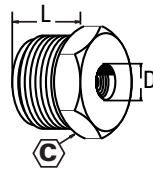

Tube O.D.	Thread B	Catalog Number		D	L
3/8	M14x1.5	M41157x6x14	3/4	.266	1.62
3/8	M16x1.5	M41157x6x16	3/4	.266	1.62
3/8	M18x1.5	M41157x6x18	3/4	.266	1.62

### Ford Nut

For use with 1513 (Nut similar to 59x4 for 3/16" tube, use 6100x3)

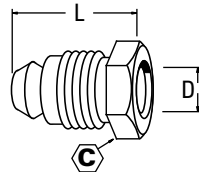



Tube Size	Thread Size	Catalog Number		D	L
1/4	1/2-20	59x4	1/2	.258	0.64

### AC8111 (Steel) Connector

#### Application:

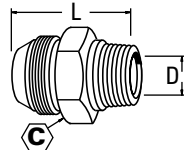
PTT Thread 30° tube to male pipe adapter for diesel engines.



Tube Size	Male Pipe	Catalog Number		D	L
1 (1-5/16-14)	1	C9200	1-3/8	.844	2.04
1 (1-5/16-14)	3/4	C9240	1-3/8	.800	1.84

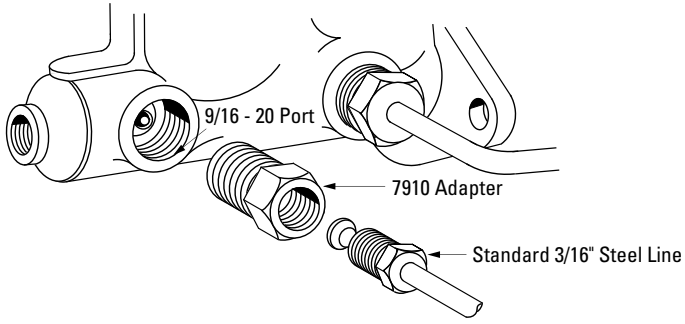

Adapters can be used to adapt standard steel brake lines to the different size ports used in dual master cylinders. The tube O.D. is the outside diameter of the steel brake line. Thread

size can be determined by measuring with a U.S. or Metric screw pitch gauge. See pages 14 to 18.

**Standard Invented Flare Tube And Thread Size**

Tube Size	1/8	3/16	1/4	5/16	3/8	7/16	1/2	5/8	3/4	7/8	1
Thread Size	5/16-28	3/8-24	7/16-24	1/2-20	5/8-18	11/16-18	3/4-18	7/8-18	1-1/16-16	1-3/16-16	1-5/16-16

**Standard Tube Nut**  
(Steel)

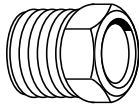

Tube Size	Catalog Number
1/8	105x2
3/16	105x3
1/4	105x4
5/16	105x5
3/8	105x6
3/8	105x6x7*
7/16	105x7
1/2	105x8
5/8	105x10
3/4	105x12
7/8	105x14
1	105x16

\*11/16-18 Thread

**Dual Master Cylinder Adapter**

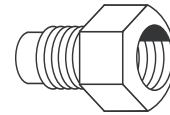

Inverted Male Thread	Inverted Female Thread	Catalog number
(Exceptions Noted)	(Exceptions Noted)	
7/16-20	1/4	7732*
5/16	3/16	7817*
5/16	1/4	7727*
5/16	5/16	1074*

† Seat may be used for 3/16", 1/4", 5/16" Tube Connection with 1/2-20 Thread.  
\*Seals On Hex Face (E)

**Long Tube Nut**  
(Steel)

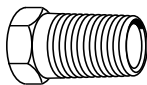

Tube O.D.	Thread Size	Catalog Number
3/16	3/8-24	7896x3
1/4	7/16-24	7896x4

# Brass Products

## Hydraulic Brake Products

### Towed Trailer Brake Tee

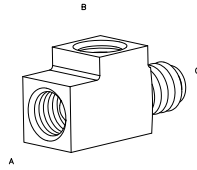

Inverted Seat A	B	Male Thread C	Catalog Number
3/16 (3/8-24)	3/16 (3/8-24)	3/16 inv. (3/8-24)	7900
3/16 (9/16-18)	3/16 (3/8-24)	3/16 inv. (9/16-18)	7933
3/16 (9/16-20)	3/16 (3/8-24)	3/16 inv. (9/16-20)	7905
1/4 (7/16-24)	3/16 (3/8-24)	1/4 inv. (7/16-24)	7901
1/4 (7/16-24)	1/4 (7/16-24)	1/4 inv. (7/16-24)	7898

### Strap Tee Assembly

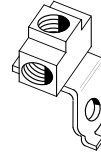

Inv. Seat	Bolt Hole	Catalog Number
1/4 (3)	11/32	7765*

\*Has flat strap

### Metric Hydraulic Brake Products

#### How to Measure Metric Threads

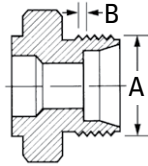

Metric threads are measured and specified by the thread diameter in millimeters and the pitch in millimeters per thread.

If dimension "A" is 22mm and dimension "B" (crest to crest distance) is 1.5mm, then the metric thread size is M22 x 1.5.

# Brass Products

## Hydraulic Brake Products

### Brake Line Unions for Domestic and Imported Vehicles



Description	Catalog No.
3/16" line to 3/16" line (3/8-24 thread), (Standard Flare) 'S' Series	302x3
1/4" line to 1/4" (7/16-24 thread), (Standard Flare) 'S' Series	302x4
5/16" line to 5/16" line (1/2-20 thread), (Standard Flare) 'S' Series	302x5
3/8" line to 3/8" line (5/8-18 thread), (Standard Flare) 'S' Series	302x6
Japanese line to Japanese line (10-1.0mm thread), (Standard Flare) 'SJ' Series (Brass)	7934A

# Plastic Products

## Molded Compression Tube Products

 Refer to safety information regarding proper selection of tubing and tube connectors on page 3.



### Molded Compression Tube Products

**Sizes:**

Available in sizes 1/8" through 3/4" tube OD (7/8" tube OD and metric tube sizes available on request from Technical Support at 1-888-258-0222.

**Materials:**

Molded as standard in two materials: nylon and polypropylene

Nylon characteristics:

- good resistance to organic solvents, oils, and gasoline
- excellent impact resistance
- tolerant to repeated steam for wash down and longtime weathering
- F.D.A. and N.S.F. listed
- operating temperatures -40°F to 200°F (-40°C to 93°C) – not to exceed temperature specification of tubing

Polypropylene characteristics:

- good chemical and corrosion resistance
- opaque
- 20% glass filled

- N.S.F. listed
- operating temperatures -30°F to 200°F (-34°C to 93°C) – not to exceed temperature specification of tubing

Available on request in two materials: Celcon\*\* (acetal copolymer) or KYNAR\*\*\* (polyvinylidene fluoride)

**Styles:**

Available in two standard styles:

Ferrule Nut (integral nut and sleeve for soft tubing to 50 PSI♦)

- features ferrule and nut molded as a single part, eliminating the need for a two-piece assembly

Gripper Nut with separate plastic sleeve (for sure-grip with plastic tubing up to 220 PSI♦)

- for higher pressure applications

**Features and Benefits:**

- leak-free performance
- high integrity in both mechanical and acoustical vibrations

- ten styles and over 400 part number configurations to meet your needs
- easy assembly – no special tools or tube preparation necessary
- reliability in side-loaded applications allows for compact plumbing
- For use with PT200, PT240, and TP160 plastic tubing
- connectors come fully assembled – for your convenience
- very low resistance to media flow resulting from material and internal surfaces
- no metal parts to corrode or present a safety hazard with aggressive chemicals
- ISO 9001 Certified

\* Celcon is a registered trademark of Ticona.  
 \*\* KYNAR is a registered trademark of Elf Atochem North America, Inc.  
 ♦ Operating temperatures of Danfoss connectors are regulated by ambient and fluid temperatures, type of fluid being carried, tubing type and conditions of mechanical abuse. Pressures in excess of above specifications in all connector sizes should be tested by the customer in the particular application.

### Assembly Instructions

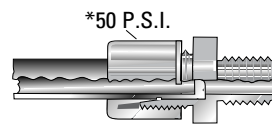
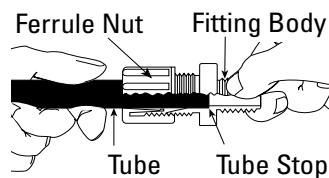

Ferrule nut with integral sleeve low pressure application soft plastic tubing

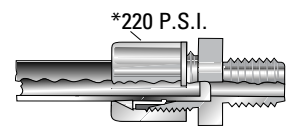

Ferrule nut with plastic gripper for use with plastic tubing for sure grip

**Maximum Operating Pressure:**

Ferrule Nut series = 50 psi max

Gripper Nut series = 220 PSI max

Operating pressures of Danfoss molded compression products are regulated by ambient and fluid temperatures, type of

fluid being carried, tubing type and conditions of mechanical abuse. Pressures in excess of above specifications in all fitting sizes should be tested by the customer for their particular application.

**Used with:**

Plastic tubing: TP160, PT200,

and PT240.

Tube inserts are recommended for optimal performance with PT200 tubing.

**Temperature Range:**

Nylon = -40°F to +200°F (-40°C to +93°C)

Polypropylene = -30°F to +200°F (-34°C to +93°C)

# Plastic Products

## Molded Compression Tube Products

### Assembly Instructions Continued

Ranges are at maximum operating pressures (refer to tubing temperature range). The overlap of temperature ranges of the individual components will decide the actual temperature range of the assembly.

#### Assembly Instructions:

- Cut tubing to desired length; be sure the tube end is cut properly (maximum 10° cutting angle allowed).

- Insert the tubing through the back of the nut all the way through the nut assembly to the tube stop in the connector body (see illustration). If the tubing does not enter the nut easily, loosen the nut one turn and then insert the tubing all the way to the tube stop in the fitting body.
- Turn the nut to hand-tight.
- Tighten the nut an additional

2 to 2-1/2 turns past hand-tight or until the nut bottoms against the connector body, whichever comes first.

- All nuts must be retightened when the system reaches projected operating temperature.

### Ordering Information

Molded compression connectors are available in nylon and in polypropylene. They are also available by special order in KYNAR\*\* (polyvinylidene fluoride) or Celcon\* (acetal copolymer). To order fittings in KYNAR or Celcon, call Technical Support at 1-888-258-0222. Refer to Chemical Resistance Chart, pages 22-26. For detailed information on chemical compatibility, call Technical Support at 1-888-258-0222. General material characteristics are as follows:

**Nylon**, F.D.A. and N.S.F. listed, has good resistance to organic solvents, oils and gasoline. Good strength at high temperatures. Cold and hot-water applications. Longtime weathering resistance. Good impact resistance, both single and repeated. Not recommended for use with bleach, acids, or chlorine.

**Polypropylene**, N.S.F. listed, has good chemical resistance. Withstands continuous temperatures up to 215°F (not to exceed temperature specification of tubing).

Unaffected by most weak acids, alkalis, alcohols and ketones. Do not use with oxidants or strong acids or in continuous sunlight. 20% glass filled for improved stiffness.

**KYNAR**, an F.D.A. and N.S.F. listed polyvinylidene fluoride, has outstanding chemical resistance for handling highly corrosive fluids.

**Celcon**, an acetal copolymer, N.S.F. listed and U.S.D.A. and F.D.A. listed for coffee, milk and antibiotics, has high tensile strength and good impact resistance over a broad temperature range. Translucent white color. Not affected by continuous hot-water service and works smoothly with metal tubing. Celcon cannot be recommended for continuous exposure to solutions with a chlorine concentration greater than 1 ppm. Suggested maximum continuous-use temperature is 220°F in air and 180°F in water (not to exceed temperature specification of tubing). Unaffected by most inorganics, except sulfuric, nitric and hydrochloric acids. Should not be continuously exposed to sunlight.

Most connectors can be ordered with a GRIPPER style nut. Fittings with a GRIPPER style nut are capable of handling greater pressure than those with standard style nut.

For ordering connectors with 'GRIPPER' nut, add 'G' to the end of the part number (example: 1568x4x4G or 1568Px4x4G). Some connectors are NOT available with the GRIPPER style nut, while others are ONLY available with the GRIPPER style nut. For more information, call Technical Support at 1-888-258-0222.

#### Note:

It is not necessary to disassemble the connector for assembly. Merely insert tubing to stop and tighten compression nut.

\* Celcon is a registered trademark of Ticona.

\*\* KYNAR is a registered trademark of Elf Atochem North America, Inc.



# Plastic Products

## Molded Compression Tube Products

- Not available with GRIPPER style nut
- Sold Only with GRIPPER style nut

To order with 'GRIPPER' nut, add 'G' to the end of the part # (Except where noted!) Example: 1568x4x4G or 1568Px4x4G

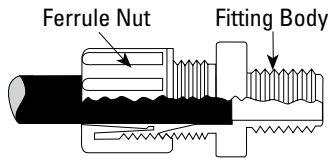

<b>Tube</b>	1/8	1/4	5/16	3/8	1/2	5/8	3/4
<b>O.D.</b>	(.125)	(.250)	(.312)	(.375)	(.500)	(.625)	(.750)
<b>Tube Thread Size</b>	5/16-24	7/16-20	1/2-20	5/8-20	3/4-20	7/8-20	1-1/16-20

### Male Connector

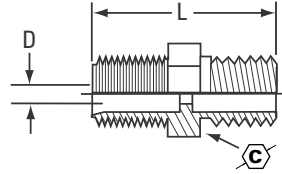

Tube O.D.	Male Pipe Thread	Catalog Number Nylon	Catalog Number Polypropylene	L	D	Ⓢ
1/4	1/8	1568x4	1568Px4	0.99	0.26	5/8
1/4	1/8	1568x4G	1568Px4G	0.99	0.26	5/8
1/4	1/4	1568x4x4	1568Px4x4	1.17	0.26	5/8
1/4	1/4	1568x4x4G	1568Px4x4G	1.17	0.26	5/8
1/4	3/8	1568x4x6G	1568Px4x6	1.20	0.26	13/16
5/16	1/8		1568Px5	1.00	0.32	11/16
5/16	1/4	1568x5x4	1568Px5x4	1.19	0.32	11/16
3/8	1/8	1568x6x2	1568Px6x2	1.14	0.38	13/16
3/8	1/8		1568Px6x2G	1.14	0.38	13/16
3/8	1/4	1568x6	1568Px6	1.30	0.38	13/16
3/8	1/4	1568x6G	1568Px6G	1.30	0.38	13/16
3/8	3/8	1568x6x6	1568Px6x6	1.34	0.38	13/16
3/8	3/8	1568x6x6G		1.34	0.38	13/16
3/8	1/2	1568x6x8	1568Px6x8	1.59	0.38	59/64
3/8	1/2	1568x6x8G	1568Px6x8G	1.59	0.38	59/64
1/2	1/8	1568x8x2G		1.23	0.51	15/16
1/2	1/4	1568x8x4	1568Px8x4	1.42	0.51	15/16
1/2	1/4		1568Px8x4G	1.42	0.51	15/16
1/2	3/8	1568x8	1568Px8	1.47	0.51	15/16
1/2	3/8	1568x8G	1568Px8G	1.47	0.51	15/16
1/2	1/2	1568x8x8	1568Px8x8	1.61	0.51	15/16
5/8	3/8	1568x10x6G		1.50	0.63	1-1/16
5/8	1/2	1568x10G	1568Px10G	1.66	0.63	1-1/16
3/4	3/4	1568x12x12G	1568Px12x12G	1.92	0.76	1-5/16

### Bulkhead Union

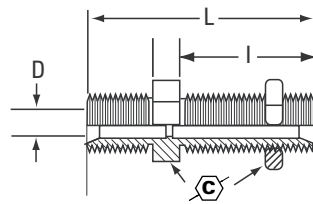
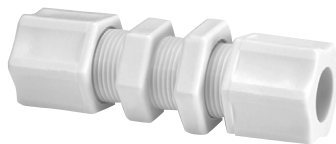

Tube O.D.	Catalog Number Nylon	Catalog Number Polypropylene	L	I	D	Ⓢ
1/4	1574x4		1.45	0.88	0.26	5/8
3/8	1574x6	1574Px6	1.78	1.03	0.38	13/16
1/2	1574x8		1.89	1.04	0.51	15/16
3/4	1574x12G	1574Px12G	2.41	1.35	0.76	1-5/16

# Plastic Products

## Molded Compression Tube Products

- Not available with GRIPPER style nut
- Sold Only with GRIPPER style nut

Union Connector

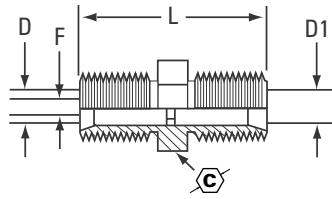

Tube O.D.	Catalog Number Nylon	Catalog Number Polypropylene	L	F	
1/4	1562x4	1562Px4	0.98	0.23	5/8
1/4	1562x4G	1562Px4G	0.98	0.23	5/8
5/16	1562x5		1.03	0.28	11/16
5/16	1562x5G	1562Px5G	1.03	0.28	11/16
3/8	1562x6	1562Px6	1.23	0.30	13/16
3/8	1562x6G	1562Px6G	1.23	0.30	13/16
1/2	1562x8	1562Px8	1.44	0.48	15/16
1/2		1562Px8G	1.44	0.48	15/16
5/8	1562x10G	1562Px10G	1.50	0.50	1-1/16
3/4	1562x12G	1562Px12G	1.75	0.64	1-5/16

Tube O.D.	Tube O.D.	Catalog Number Nylon	Catalog Number Polypropylene	L	D		D1
1/4	1/8		1562Px4x2	0.92	0.26	5/8	0.13
5/16	1/4	1562x5x4		1.00	0.32	11/16	0.26
3/8	1/4	1562x6x4G		1.19	0.38	13/16	0.26
1/2	3/8		1562Px8x6	1.33	0.51	15/16	0.38
5/8	1/2		1562Px10x8G	1.47	0.63	1-1/16	0.51

Female Connector

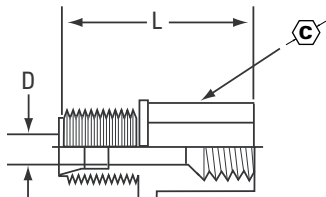

Tube O.D.	Female Pipe Thread	Catalog Number Nylon	Catalog Number Polypropylene	L	D	
1/4	1/8	1566x4		0.92	0.23	9/16
1/4	1/8	1566x4G		0.92	0.23	9/16
1/4	1/4	1566x4x4	1566Px4x4	1.09	0.22	11/16
1/4	1/4	1566x4x4G		1.09	0.22	11/16
5/16	1/4	1566x5x4		1.22	0.28	11/16
5/16	1/4	1566x5x4G		1.22	0.28	11/16
3/8	1/4	1566x6		1.20	0.36	11/16
3/8	3/8	1566x6x6	1566Px6x6	1.20	0.36	13/16
3/8	3/8	1566x6x6G		1.20	0.36	13/16
3/8	1/2	1566x6x8	1566Px6x8	1.27	0.34	1-3/64
3/8	1/2	1566x6x8G	1566Px6x8G	1.27	0.34	1-3/64
1/2	3/8	1566x8		1.23	0.47	13/16
1/2	3/8	1566x8G		1.23	0.47	13/16
1/2	1/2	1566x8x8	1566Px8x8	1.30	0.48	15/16

# Plastic Products

## Molded Compression Tube Products

- Not available with GRIPPER style nut
- Sold Only with GRIPPER style nut

Female Elbow

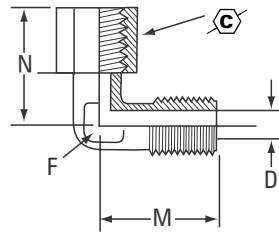

Tube O.D.	Female Pipe Thread	Catalog Number Nylon	Catalog Number Polypropylene	M	N	D		Across Flats F
1/4	1/8	N/A		0.81	.75	0.26	35/64	25/64
1/4	1/4	1570x4x4		0.81	.97	0.26	11/16	13/32
5/16	1/4	1570x5x4G	▪ 1570Px5x4G	0.94	1.00	0.32	11/16	7/16
3/8	3/8	1570x6x6	1570Px6x6	0.91	1.03	0.38	13/16	9/16

Male Elbow

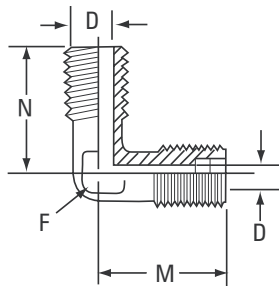

Tube O.D.	Male Pipe Thd.	Catalog Number Nylon	Catalog number Polypropylene	M	N	D	D1	Across Flats F
1/8	1/8		1569Px2▪	0.56	0.63	0.11	0.20	1/4
1/4	1/8	1569x4		0.81	0.81	0.22	0.25	3/8
1/4	1/8	1569x4G		0.81	0.81	0.22	0.25	3/8
1/4	1/4	1569x4x4		0.81	1.02	0.22	0.28	3/8
1/4	1/4	1569x4x4G	1569Px4x4G	0.81	1.02	0.22	0.28	3/8
1/4	3/8	1569x4x6		0.84	1.09	0.23	0.38	9/16
3/8	1/4	1569x6	1569Px6	0.94	1.03	0.30	0.31	37/64
3/8	1/4	1569x6G	1569Px6G	0.94	1.03	0.30	0.31	37/64
3/8	3/8	1569x6x6	1569Px6x6	0.94	1.09	0.34	0.38	9/16
3/8	3/8	1569x6x6G		0.94	1.09	0.34	0.38	9/16
1/2	1/4	1569x8x4G	▪	1.06	1.09	0.39	0.31	11/16
1/2	3/8	1569x8	1569Px8	1.09	1.13	0.39	0.31	11/16
1/2	3/8	1569x8G		1.09	1.13	0.39	0.31	11/16
1/2	1/2	1569x8x8	1569Px8x8	1.09	1.28	0.47	0.36	11/16
1/2	1/2	1569x8x8G	1569Px8x8G	1.09	1.28	0.47	0.36	11/16
5/8	1/2	1569x10G	▪ 1569Px10G	1.25	1.44	0.52	0.50	13/16

# Plastic Products

## Molded Compression Tube Products

- Not available with GRIPPER style nut
- Sold Only with GRIPPER style nut

### Union Tee

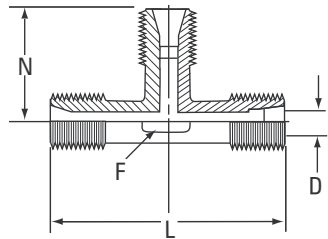

Tube O.D.	Catalog Number Nylon	Catalog Number Polypropylene	L	D	N	Across Flats F
1/8	1564x2•		1.11	0.11	0.52	1/4
1/4	1564x4	1564Px4	1.44	0.22	0.72	23/64
1/4	1564x4G		1.44	0.22	0.72	23/64
5/16	1564x5G	1564Px5G	1.61	0.28	0.83	7/16
3/8	1564x6	1564Px6	1.91	0.30	0.97	17/32
3/8		1564Px6G	1.91	0.30	0.97	17/32
1/2	1564x8	1564Px8	2.13	0.48	1.03	11/16
1/2	1564x8G		2.13	0.48	1.03	11/16
5/8	1564x10G	▪	2.56	0.50	1.25	13/16
3/4	1564x12G	▪	3.11	0.62	1.56	1-1/16

### Union Elbow

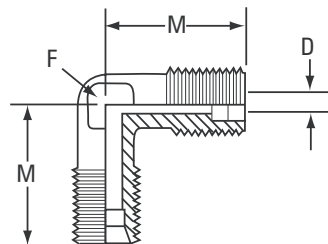

Tube O.D.	Catalog Number Nylon	Catalog Number Polypropylene	M	D	Flats F	Across
1/4	1565x4	-		0.81	0.22	3/8
1/4	1565x4G	-		0.81	0.22	3/8
3/8	1565x6	1565Px6		0.94	0.34	9/16
3/8	1565x6G	1565Px6G	0.94	0.34	9/16	
1/2	1565x8	1565Px8		1.06	0.39	43/64
1/2	1565x8G	-		1.06	0.39	43/64
5/8	1565x10G	▪ -		1.25	0.52	13/16

### Male Branch Tee

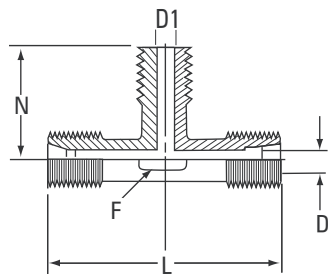

Tube O.D.	Male Pipe Thd.	Catalog Number Nylon	L	D	N	D1	Across Flats F
1/4	1/8	1572x4	1.45	0.22	0.75	0.25	3/8
1/4	1/8	1572x4G	1.45	0.22	0.75	0.25	3/8
1/4	1/4	1572x4x4x4	1.45	0.22	0.92	0.31	3/8
1/4	1/4	1572x4x4x4G	1.45	0.22	0.92	0.31	3/8
5/16	1/4	1572Px5x5x4	1.61	0.30	0.98	0.31	27/64
3/8	3/8	1572x6x6x6	1.91	0.36	1.11	0.38	1/2
1/2	1/2	1572x8x8x8	2.19	0.48	1.31	0.48	5/8

# Plastic Products

## Molded Compression Tube Products

- Not available with GRIPPER style nut
- Sold Only with GRIPPER style nut

### Male Run Tee

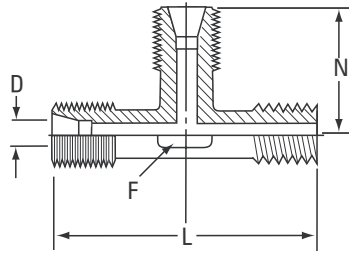

Tube O.D.	Male Pipe Thd.	Catalog Number Nylon	Catalog Number Polypropylene	L	D	N	Across Flats F
1/4	1/8	1571x4		1.47	.22	.73	3/8
1/4	1/4	1571x4x4x4		1.67	.22	.72	23/64
1/4	1/4	1571x4x4x4G		1.67	.22	.72	23/64
5/16	1/4	1571x5x4x5G	1571Px5x4x5	1.81	.28	.81	7/16
3/8	3/8	1571x6x6x6	1571Px6x6x6	2.03	.34	.97	1/2
1/2	3/8	1571x8		2.27	.47	1.11	5/8
1/2	3/8		1571Px8G	2.27	.47	1.11	5/8
1/2	1/2	1571x8x8x8G		2.41	.47	1.11	39/64
3/4	1/2	N/A	1571Px12G	3.17	.64	1.55	1-1/16

### Compression Nut

#### Ferrule Nuts with Integral Sleeve

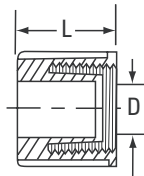
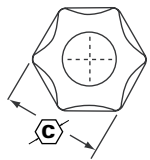

Tube O.D.	Catalog Number Nylon		L	D
1/4	1561x4	5/8	0.63	0.26
5/16	1561x5	11/16	0.69	0.32
3/8	1561x6	13/16	0.75	0.38
1/2	1561x8	15/16	0.88	0.51

#### With Plastic Gripper

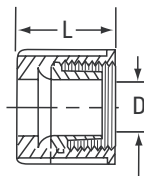

Tube O.D.	Catalog Number Nylon	Catalog Number Polypropylene		L	D
1/4	1561x4G		5/8	0.69	0.26
3/8	1561x6G		13/16	0.73	0.38
1/2	1561x8G	1561Px8G	15/16	0.88	0.51

### Insert

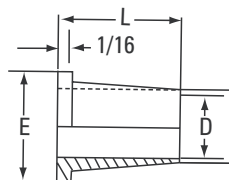

Tube O.D.	Catalog Number Nylon	E	L	D
1/4	1584x4	0.25	0.38	0.12
5/16	1584x5	0.31	0.40	0.14
3/8	1584x6	0.37	0.50	0.20
1/2	1584x8	0.49	0.56	0.30

# Plastic Products

## Molded Compression Tube Products

### Cap Nut

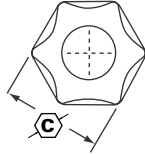
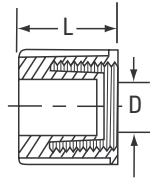

Tube O.D.	Catalog Number Nylon	Catalog Number Polypropylene	L	
1/8	1529x2		0.52	7/16
1/4	1529x4	1529Px4	0.63	5/8
3/8	1529x6		0.73	13/16
1/2	1529x8	1529Px8	0.88	15/16

### Bulkhead Nut

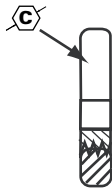

Tube O.D.	Catalog Number Nylon	Catalog Number Polypropylene	
1/4	1502x4		5/8
5/16		1502Px5	11/16
3/8	1502x6		13/16

### KYNAR Check Valve

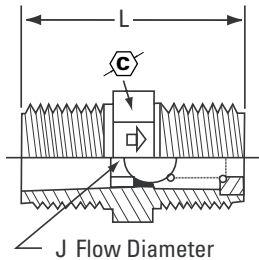

Male Pipe Number Size N.P.T.F.	Catalog KYNAR Only	L	J	
1/8	1531x2	1.00	0.09	7/16
1/4	1531x4	1.41	0.19	5/8
3/8	1531x6	1.50	0.25	13/16
1/2	1531x8	1.81	0.34	15/16

#### KYNAR\*\* Check Valve Features and Benefits:

- Viton® "O" Ring
- Stainless Ball & Spring
- Zero Leakage
- Maximum Operating Temp. 180°F @ 220 PSI
- Cracking Pressure 1 to 2.5 PSI

Viton is a registered trademark of DuPont Dow Elastomers

\*\* KYNAR is a registered trademark of Elf Atochem North America, Inc.

# Plastic Products

 Refer to safety information regarding proper selection of tubing and tube connectors on page 3.

3 Way Tee

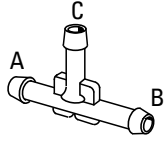

Tube i.d. A	Tube i.d. B	Tube i.d. C	Catalog Number
3/8	3/16	3/8	1944

# Brass-Nickel Plated BSPP Products

 Refer to safety information on page 3.

**BSPP Male To NPTF Female  
Adapter**

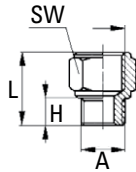

Male BSPP	Female NPTF Thread	Catalog Number	H	L	SW (mm)
1/8	1/8	1150x2x2PP	0.27	0.67	14
1/4	1/4	1150x4x4PP	0.32	0.91	17
3/8	3/8	1150x6x6PP	0.35	0.96	22
1/2	1/2	1150x8x8PP	0.39	1.16	27

**BSPP Female To NPTF Male  
Adapter**

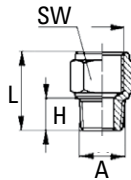

Male BSPP	Female NPTF Thread	Catalog Number	H	L	SW (mm)
M5*	10-32†	1100x5MMxA	0.18	0.47	8
1/8	1/8	1100x2PPx2	0.37	0.77	14
1/4	1/4	1100x4PPx4	0.51	1.06	17
3/8	3/8	1100x6PPx6	0.51	1.08	19

\*M5 has 0.8mm Thread Pitch. M5 seals with nylon washer, included.

†UNF thread



## Related Products

### Assembly & Tool Cutting Equipment

**⚠ Caution:** Sharp blade! Keep hands and fingers away from cutting surface!

#### T-150 Utility Tube Cutter



Need to cut stainless steel tubing? This cutting tool is for you. It features an enclosed feed screw to eliminate clogging and jamming. Grooved rolls for close to flare cuts and a fold away reamer.

**Capacity:**

1/8" to 1-1/8" O.D. Cuts hard and soft copper, aluminum, brass, carbon steel and stainless steel tubing.

**Spare Parts:**

T-1422R Replacement Cutting Wheel

## Air Brake Products & Measuring Kits

**⚠** Refer to safety information on page 3.

#### Thread Measuring Kit Danfoss Part # FT1341



Measuring tube and pipe fitting threads can be a most difficult task if not completely understood. Tools needed include a thread pitch gauge, calipers and seat angle gauges. To aid you, Danfoss has a kit to fit your needs.

**This handy kit includes:**

- Thread Pitch Gauge (American and metric)
- Inside/Outside Caliper (inches and millimeters)
- 2 Seat Angle Gauges (37°/45° and a 12°/30°)
- International Measuring and Identification Guide and Instruction Booklet
- Carrying Case for Easy and Convenient Storage

## Related Products

### Tube Cutting Equipment

 Refer to safety information on page 3.

#### Plastic Tube Cutter

Weatherhead Part # T-135  
Danfoss Part # FT1356



An economical alternative to quality tube and hose cutting. This versatile tool is lightweight and durable for long service life.

**Replacement Blade:**  
Weatherhead=T-135B  
Danfoss=FT1356-2-1

**Capacity:**  
Up to 1" I.D.

**Note:**  
Not for use with wire-reinforced hose.

#### T-191 Plastic Tube and Hose Cutter



A tool designed to be small, only 2-7/8" long. The versatile T-191 offers quick and clean square cuts on 1/16" to 1/2" O.D. plastic tubing and non-wire reinforced hose. The T-191 can be either bench or wall mounted and offers the safety of closing automatically when not in use.

**Spare Parts:**  
T-191B Replacement Blade (one per package)

## Related Products

### Tube Bending Tools

 Refer to safety information on page 3.

#### Spring Tube Benders



Low cost, tube bending spring operates perfectly in hand bending copper, aluminum and other thin-walled tubing.

Bends are true with minimum tubewall collapsing. Belled at one end to facilitate removal. Bright-plated spring wire finish.

Catalog Number	Tubing (O.D.) (Inches)	Length (Inches)	Weight
T-105	5/16	10	4 ozs.
T-106	3/8	10	5 ozs.
T-108	1/2	12	8 ozs.

# Equipment

## Tube Flaring & Brazing Tools

 Refer to safety information on page 3.

### T-345K Tube Cutting and Flaring Kit



Tube flaring and cutting has just become a little easier with the convenient T-345K Tube Flaring and Cutting Kit.

This kit features a quality-made Double Flaring Tool offering accurate single flares between 3/16" and 5/8" O.D. tubing. Double flares between 3/16" and 1/2" O.D. tubing.

#### Check these features:

- Hardened, smooth cone for fast, accurate 45° flares.
- Single and double flare capability.
- Clamp screw for easy clamping and removal of tubes.
- Flaring Bar installed from either side of yoke.
- Flares soft copper, brass, aluminum and mild steel (JIC and Bundy) tubing.

### T-345K

Components can be ordered separately:

T-345  
45° Flaring Tool, Double Flare Adapters and Plastic Box

### T-150

1/8" to 1-1/8" Tube Cutter

### T-1422R

T-150 Spare Cutting Wheel

#### Double Flare Adapters

Catalog Number	Tube O.D.
T-346x3	3/16"
T-346x4	1/4"
T-346x5	5/16"
T-346x6	3/8"
T-346x8	1/2"

# Related Products

## Label Sets & Bags

 Refer to safety information on page 3.

### Label Sets

Full assortment available. Each label contains catalog number, illustration, size data and color coding for quick, positive identification of parts. Labels slide easily into slots on drawers and dividers.



Catalog Number	Description
CL-490	Standard brass products, drain and shut-off cocks.
CL-491	Air brake products for copper tubing.
CL-492	Hydraulic brake products.
CL-494	Master Set - contains one each of CL-490, CL-491, CL-492.
CL-496	Mini-Barb products.
CL-497	Air brake products for nylon tubing.
CL-498	Polyline products.
CL-499	Push>Connect
CL-500	Selfalign
CL-503	QCAB products

### Self-Adhesive Label Sets

Labels are printed on self-adhesive stock for quick application. Each label contains an illustration of the part along with the catalog number and size information.

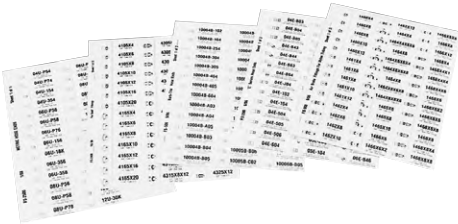

Catalog Number	Description
FS-800	Air brake products for copper tubing
FS-900	Air brake products for nylon tubing
FS-1000	Mini-Barb products
FS-2100	Polyline products
FS-3300	QCAB products
W-8022	Standard brass products and drain-shut-off valve

### Plastic Bags

Danfoss heavy-duty plastic bags for brass products come in sizes 5"x6", 6"x10", and 8"x12". The bags include convenient spaces for labeling.



Catalog Number	Description	Qty.
5x6 PB	Plastic Bag	100
6x10 PB	Plastic Bag	100
8x12 PB	Plastic Bag	100

## Related Products

### Cabinets & Assortments



**C-40X** – The sturdy C-40X cabinet contains 40 heavy-duty drawers that can be divided into two, three, or four compartments providing space for a large selection of hose ends and adapters. It has mounting holes for the T-420, ET1187, and ET1000 crimp machines. **Dimensions: 46-1/2"H x 40"W; 26" Deep at base, 18" Deep at top. Weight: 228 lbs.**



**TC-20** - The TC-20 cabinet provides easy access to all your tooling needs. This collet cabinet fits Danfoss' core tooling products. Standard holes fit the ET425 series collets. Inserts are provided to fit the ET313 series collets. **Dimensions: 28-1/2"H x 26-1/2" W; 12-3/4" Deep. Weight: 37.5 lbs.**



**C-15X** – The rugged C-15X contains 15 extra large drawers that may be divided into two or three sections for those large, difficult to store items. **Dimensions: 13 -5/8"H x 30 -1/4"W; 14-3/8" Deep. Weight: 45 lbs.**



**HD-1X** - The HD-1X cabinet offers the ideal solution for keeping 50-foot lengths of hose off the floor. Vertical slots in the cabinet keep hoses organized and clean. Consider bolting a C-15X stocking cabinet on top of the HD-1X to keep an inventory of hose ends readily available. Internal dimensions have changed from 7 narrow 4.3" sections to 5 wider 6.14" sections to accommodate larger hose sizes. **Dimensions: 36"H x 31" W; 24" Deep. Weight: 83 lbs.**



**C-63X** - This stock cabinet containing 63 drawers, which can be divided into two or three sections, is a nice addition to any store front. **Dimensions: 25"H x 30 -1/4"W; 9-1/4" Deep. Weight: 61 lbs.**



**FC-16X** - The FC-16X contains 16 clear poly drawers that can be divided into two or three sections. **Dimensions: 11-3/4"H x 16 -1/8"W; 9" Deep. Weight: 13 lbs.**



**FH-135X** - The sturdy FH-135X cabinet contains 50 heavy-duty drawers that can be divided into one, two, or three compartments allowing ample space for a large selection of hose ends and adapters. It includes mounting holes for the ET1187 and ET1000 crimp machines. **Dimensions: 46-1/2"H x 33" W; 14-1/2" Deep. Weight: 115 lbs.**



**C-632X** - The C-632X consists of the CB-63X cabinet base, the C-15X cabinet, and two C-63X cabinets. This cabinet is a space saving, efficient addition to the modern store with a lobby type sales area. It requires a minimum amount of space, but does a maximum job merchandising a wide variety of products in 126 clear drawers. An additional 15 large, high impact drawers located in the bottom section provide ample space for large or heavy items. **Dimensions: 68-1/2"H x 30"W; 15" Deep. Weight: 167 lbs.**

# Related Products

## Assortments

### CA-632 Brass Products Assortment and Cabinet

The CA-632 assortment combines a lobby display unit and an assortment of fast moving brass products with coverage for most any application. This space saving assortment includes color coded, illustrated, labels for quick identification by customers of

standard products, as well as fuel line, carburetion, metric and domestic hydraulic brake and thermoplastic brass fittings in 240 configurations and sizes. Be a supplier to auto dealers, brake specialists, RV shops, plant maintenance shops, truck and

bus fleets, contractors, marinas, loggers, shipyards, fishing fleets, farmers and self installers for their brass requirements. Contents of this assortment may vary as new products are introduced and stock changes in popularity.

#### Contents only: CA-632CO & C-632X Brass Cabinet Only (2 C-63X, 1 C-15X, 1 CB-63X)

Catalog Number	Qty.	Catalog Number	Qty.	Catalog Number	Qty.	Catalog Number	Qty.	Catalog Number	Qty.	Catalog Number	Qty.
05703B-102	5	202x4	10	3220x4x2	20	3400x6	5	49x4x4	5	66x2	10
05704B-102	10	202x4x4	10	3220x6x2	10	3400x8	5	49x5	10	66x3	10
05704B-104	5	202x5	10	3220x6x4	10	3500x2	10	49x5x4	5	66x4	10
05704B-C02	5	202x5x4	10	3220x8x2	5	3500x4	10	49x6	10	66x6	5
05705B-102	10	202x6	10	3220x8x4	10	3600x2	5	49x8	5	68x2	10
05705B-104	5	202x6x2	5	3220x8x6	5	3600x4	5	60x2	50	68x3	10
05705B-C02	10	2030x4	10	3220x12x6	2	3700x2	10	60x3	50	68x4	10
05705B-C04	10	2030x44	10	3220x12x8	2	3700x4	5	60x4	50	68x4x4	10
05705B-1560	10	2030x5	10	3300x2	10	3700x6	5	60x5	50	68x5	10
05705B-1561	10	2030x6	10	3300x4	10	3750x2	5	60x6	50	68x5x4	10
05706B-102	10	2030x8	5	3300x4x2	10	3750x4	5	60x8	20	68x6	10
05706B-104	10	252x3	10	3300x6	5	402x3	10	60x10	10	68x6x2	10
05706B-106	5	252x4	10	3300x6x4	5	402x4	10	61x2	10	68x6x6	5
05706B-C02	5	302x3	10	3300x8	5	402x4x4	5	61x3	20	68x8	5
05706B-C04	5	302x4	10	3300x8x6	5	402x5	10	61x4	20	69x2	10
05706B-1568	5	302x5	10	3325x2	10	402x5x4	10	61x5	20	69x3	10
05706B-1570	5	302x6	5	3325x4	10	402x6	10	61x6	10	69x4	10
100x3	10	3129x2	5	3325x4x2	5	41x3	10	61x8	10	69x4x4	10
100x4	10	3150x2	10	3325x6	5	41x4	10	6100x2	10	69x5	10
100x5	10	3150x4	10	3325x6x4	5	41x5	10	6100x3	10	69x5x4	10
100x6	10	3151x2	10	3326x2	10	41x6	10	6100x4	10	69x6	10
105x2	10	3151x4	10	3326x4	10	41x8	5	62x2	10	69x6x2	5
105x3	20	3151x6	10	3326x6	10	42x4	5	62x3	10	69x6x6	5
105x4	20	3151x8	5	3326x8	5	42x6	5	62x4	10	69x8	5
105x5	20	3152x2	10	3327x2	10	48x3	10	62x5	10	7896x3	5
105x6	10	3152x4	10	3327x4	5	48x4	10	62x6	10	7896x4	5
131x3	10	3152x6	10	3328x2	10	48x4x4	10	62x8	5	7934A	5
131x4	10	3152x8	5	3328x4	5	48x5	10	62x10	1	C-632X	1
131x5	10	3152x12	2	3328x6	5	48x5x4	10	6200x2	10	CL-490	1
131x6	10	3200x2	10	3350x2	5	48x6	10	6200x3	10		
1538	10	3200x4	5	3350x4	5	48x6x2	5	6200x4	10		
1539	10	3200x4x2	10	3350x6	5	48x6x6	5	6205-004	10		
1540	10	3200x6x4	5	3400x2	10	48x8	5	64x4	5		
202x3	10	3200x8x6	5	3400x4	10	49x4	10	64x6	5		

## Related Products

### Assortments

#### AB-45 • Air Brake Fittings Assortment



This assortment of draincocks, shutoffs, and air brake fittings for use with 1/4", 3/8", and 1/2" copper tubing is a must for jobbers and fleet service shops. Provides excellent coverage for air brake tube and hose service requirements. The large plastic drawers and the illustrated labels for the 15 drawer cabinet included in the assortment make positive part selection simple and quick.

Part Number	Qty.
1360x6	20
1360x8	20
1360x10	10
1360x12	10
1361x6	20
1361x8	5
1361x10	5
1362x4	5
1362x6	10
1362x8	5
1362x10	5
1368x6	10
1368x6x2	5
1368x6x6	5
1368x8	5
1368x10	5
1369x4x4	5
1369x6	10
1369x8	5
1380x6	5
1390x6	5
1391x6	5

Part Number	Qty.
33806-A	20
33806-B	5
33806B-Y06	2
33806B-Y24	5
33806B-Y28	5
33806B-Y34	5
33806B-Y38	5
C-15X	1
FS-800	1
W05465	5
W14630	10
W15310	5
W76150	5
W79850	3
W79851	3



## Related Products Assortments

### AB-1400 • Air Brake Fittings Assortment



The AB-1400 contains DOT approved brass air brake fittings for servicing nylon brake and secondary air lines. Selecting the proper fittings from the 63-drawer cabinet included with the assortment is easy. Clear, wide plastic drawers with color-coded labels make identification of shapes and sizes quick and simple. Order Danfoss air brake tubing to complete your nylon air brake line service center.

Part Number	Qty.
1460x4	10
1460x6	20
1460x8	10
1460x10	10
1460x12	10
1461x4	5
1461x6	10
1461x8	5
1461x10	5
1461x12	5
1462x4	5
1462x6	10
1462x8	5
1462x10	4
1462x12	2
1464x6	5
1464x8	5
1466x6	5
1466x6x6	5
1466x8	5
1468x4	5
1468x4x4	5
1468x6	10
1468x6x2	5
1468x8	5
1468x10	5
1468x12	4
1469x4	5

Part Number	Qty.
1469x4x4	5
1469x6	10
1469x6L	5
1469x6x2	5
1469x6x6	5
1469x8	5
1469x8x4	5
1469x10	5
1469x10x6	4
1469x12	4
1471x4	5
1471x6	5
1472x6	5
1472x8	5
1480x6	5
1480x6x6	5
1480x8	5
1480x10	4
1484x4	20
1484x6	20
1484x8	20
1484x10	10
1484x12	10
C-63X	1
CL-497	1

### AB-140 • 1400 Series Air Brake Fittings Assortment



This assortment of 1/4", 3/8", and 1/2" air brake fittings designed for use with Danfoss air brake tubing provides the coverage needed for service work by fleets, repair shops, and farm implement dealers. The DOT-approved air brake fittings are easily selected from the cabinet with 16 plastic drawers and color-coded labels included in the assortment.

Part Number	Qty.
1460x4	20
1460x6	20
1460x8	20
1461x4	10
1461x6	10
1461x8	5
1462x4	5
1462x6	10
1462x8	4
1468x4	10
1468x6	10
1468x8	5
1469x4	5
1469x6	5

Part Number	Qty.
1469x8	5
1484x4	20
1484x6	20
1484x8	20
CL-16-3	1
FC-16X	1
W15310	5

## Related Products

### Assortments

#### SA-1 • Secondary Air Systems Kit



Ideal for fleet repair shops, truck dealers, garages and truck stops. SA-1 contains an assortment of popular 1/8" and 1/4" brass fittings plus 200' of Danfoss air brake tubing. The 1/8" fittings are Danfoss SELFALIGN® and 1/4" fittings are Danfoss 1400 series air brake. The sturdy box keeps the tubing and fittings together for quick and easy servicing of the tubing used on shifters, PTO's, wipers, horns, remote air, instrumentation, etc. All of the parts are organized at your finger tips. The SA-1 is a must for all vehicle air system maintenance facilities.

#### Size

15" wide, 3-1/2" high, 14-1/2" deep.

Part Number	Qty.
1460x4	10
1461x4	5
1462x4	2
1464x4	1
1468x4	2
1468x4x1	2
1468x4x4	2
1469x4	2
1469x4x4	2
1484x4	5
601x2	10

Part Number	Qty.
611x2	5
621x2	2
661x2	2
681x2	2
681x2x1	2
691x2	2
691x2x1	2
BF-40X	1
4245-0220-0100	100'
4249-0410-0100	100'

## Related Products Assortments

### QC-180



The QC-180 contains tube unions, male connectors, swivel male 45° elbow, male 90° elbows, and repair kits in popular 1/4", 3/8", and 1/2" tube sizes designed for DOT Truck and Trailer Air Brake System needs (see complete listing at right in table). The QCAB fittings are field proven with over millions of miles of leak free performance. Their design can save up to 75 percent of the assembly time over conventional compression fittings. These fittings are contained in a case measuring 1-3/4" x 6-3/4" x 1-3/4".

Component Part No.	Qty.
1862x4	2
1869x8x8	1
1862x6	2
1880x4x4	2
1862x8	2
1880x6x6	2
1868x2.5	2
1880x8x8	1
1868x3	2
1800Kx4	2
1868x4x4	2
1800Kx6	2

Component Part No.	Qty.
1868x6x6	2
1800Kx8	2
1868x8x8	2
1800TRK	1
1869x4x4	2
BF-40X	1

### QC-1800



This assortment contains a solid inventory of popular Danfoss QCAB fittings designed for DOT Truck and Trailer Air Brake System needs (see complete listing at right in table). The QCAB fittings are field proven with over millions of of leak free performance. Their design can save up to 75 percent of the assembly time over conventional compression fittings.

Component Part No.	Qty.
1800Kx2.5	4
1862x10	2
1868x12	2
1874x6x6	1
1800Kx3	4
1868x2.5x1	5
1869x4	5
1874x8x8	1
1800Kx4	4
1868x2.5	5
1869x4x4	5
1880x4x4	5
1800Kx6	4
1868x3	5
1869x6	5
1880x6x6	5
1800Kx8	4
1868x4	5
1869x8	5
1880x8x8	5
1800Kx10	2
1868x4x4	5
1869x8x8	5
1880x10	2

Component Part No.	Qty.
1800Kx12	2
1868x6	5
1869x10	2
1880x12	2
1862x2.5	2
1868x6x6	5
1869x4S	5
1800T	1
1868x8	5
1869x4x4S	5
CL-503	1
1862x4	5
1868x8x8	5
1869x6S	5
FC-16X	1
1862x6	5
1868x10x6	2
1869x8S	5
T-191	1
1862x8	5
1868x10	2
1874x4x4	1

# Related Products Assortments

## Brass Products Assortment Weatherhead Part # CA-631



This merchandiser will help you organize your brass products in an attractive 63 drawer cabinet. It includes a stock of the 100 fastest moving brass products to better service your customers. To expand, divide the clear, easy to inventory, super sized plastic drawers in half or thirds with plastic dividers provided. Illustrated, color-coded

labels in a wide range of connector types provide instant identification of drawer contents. Your lobby and sales will be improved with this modern display set up on a gondola or shelf. Contents may vary as new numbers become available and popularity changes.

### CA-631 Contents

Catalog Number	Qty.	Catalog Number	Qty.	Catalog Number	Qty.	Catalog Number	Qty.	Catalog Number	Qty.	Catalog Number	Qty.
105x3	20	302x6	5	3220x4x2	20	3327x4	5	48x5x4	10	62x4	10
105x4	20	402x4	10	3220x6x2	10	3328x2	5	48x6	10	62x5	10
105x5	20	402x5	10	3220x6x4	10	3328x4	5	48x6x6	5	62x6	10
105x6	10	402x6	10	3220x8x2	5	3350x2	5	49x4	5	68x2	10
131x3	10	3150x2	5	3220x8x4	10	3350x4	5	49x6	10	68x3	10
131x4	10	3150x4	5	3220x8x6	5	3400x2	10	60x2	50	68x4	10
131x5	10	3151x2	10	3300x2	10	3400x4	10	60x3	50	68x4x4	10
131x6	10	3151x4	10	3300x4	10	3400x6	5	60x4	50	68x5	10
202x3	10	3151x6	10	3300x4x2	10	3700x2	10	60x5	50	68x5x4	10
202x4	10	3151x8	10	3300x6	5	3700x4	5	60x6	50	68x6	10
202x4x4	10	3152x2	10	3300x6x4	5	3750x4	5	61x2	10	68x6x2	10
202x5	10	3152x4	10	3325x2	10	3750x6	2	61x3	10	69x4	10
202x5x4	10	3152x6	10	3325x4	10	41x4	10	61x4	10	69x6	10
202x6	5	3152x8	5	3326x2	10	41x6	10	61x5	10	C-63X	1
302x3	10	3200x2	5	3326x4	10	48x4	10	61x6	10	CL-490	1
302x4	10	3200x4x2	10	3326x6	10	48x4x4	10	62x2	10		
302x5	10	3200x6x4	5	3327x2	5	48x5	10	62x3	10		

## Brass Products Assortment Weatherhead Part # FC-161



The brass products assortment contains the fastest moving SAE 45° Flare, Inverted Flare, Compression and Pipe catalog numbers to give your customers maximum coverage at a low cost. Nuts, sleeves and unions make

an ideal stock for any small repair, auto, boat, lawn mower, or fixit shop. Cabinet includes 16 clear plastic drawers and color-coded labels for easy identification. The cabinet fits on any shelf and goes to work immediately.

### FC-161 Contents

Catalog Number	Qty.	Catalog Number	Qty.	Catalog Number	Qty.	Catalog Number	Qty.	Catalog Number	Qty.	Catalog Number	Qty.
105x3	10	3151x2	2	402x4	2	49x5	2	61x6	5	69x5	2
105x4	10	3151x4	2	402x5	2	49x6	2	62x3	5	69x6	2
105x5	10	3220x4x2	5	41x4	2	60x3	20	62x4	5	CL-16-1	1
105x6	5	3220x6x4	5	41x5	2	60x4	20	62x5	5	FC-16X	1
202x4	2	3300x2	5	41x6	2	60x5	20	62x6	5		
202x5	2	3300x4	2	48x4	2	60x6	20	68x4	2		
302x3	5	3400x2	5	48x5	2	61x3	10	68x5	2		
302x4	5	3400x4	5	48x6	2	61x4	10	68x6	2		
302x5	2	402x3	2	49x4	2	61x5	10	69x4	2		

## Related Products Assortments

### Push>Connect Products Assortment Weatherhead Part # PC-48



Danfoss PUSH > CONNECT products are designed for quick assembly without the need for a wrench. Ideal for pneumatic applications where space is tight. Then product is also easily disconnected; simply depress the collet ring with two fingers and

withdraw the tube. The PC-48 and FT1613 provides the 48 most popular PUSH > CONNECT products in a compact, handy plastic box to make your assortment organized and accessible.

#### PC-48 Contents

Catalog Number	Qty.	Catalog Number	Qty.	Catalog Number	Qty.	Catalog Number	Qty.	Catalog Number	Qty.	Catalog Number	Qty.
1162x2	5	1165x6	5	1168x2.5x4	5	1168x6x6	5	1169x4x6S	5	1172x4x4S	5
1162x4	5	1165x8	2	1168x2x4	5	1168x6x8	2	1169x6S	5	1174x2	5
1162x6	5	1166x4	5	1168x4	5	1168x8	5	1169x6x6S	5	1174x4	5
1164x2.5	5	1166x4x4	5	1168x4A	5	1168x8x8	2	1169x8S	2	CL-499	1
1164x4	5	1166x6	5	1168x4x4	5	1169x2.5S	5	1169x8x4S	2	FC-16X	1
1164x6	5	1166x6x6	2	1168x4x6	5	1169x2S	5	1171x4S	5		
1164x8	2	1168x2	2	1168x5	5	1169x2x4S	5	1171x4x4S	5		
1165x2.5	5	1168x2.5	5	1168x5x4	5	1169x4S	5	1171x6S	5		
1165x4	5	1168x2.5A	5	1168x6	5	1169x4x4S	5	1172x4S	5		

# Certification

## ISO & QS Certifications

Danfoss Hydraulics - Brass  
Products

Facility	Registration	Registrar Number	Product Responsibility
Cleveland, TN	ISO9002	SGSUS98/1495	Distribution of Danfoss Product

# Conversion Conversion Chart

Inches Fractions	Decimals	MM	Inches Fractions	Decimals	MM	Inches Fractions	Decimals	MM	Inches Fractions	Decimals	MM
–	.0004	0.0100	–	.3150	8.0000	11/16	0.6875	17.4630	–	1.1811	30.0000
–	.0040	0.1000	21/64	.3280	8.3340	45/64	0.7030	17.8590	1-3/16	1.1875	30.1630
–	.0100	0.2500	–	.3350	8.5000	–	0.7087	18.0000	1-7/32	1.2190	30.9560
1/64	.0156	0.3970	11/32	.3440	8.7310	23/32	0.7190	18.2560	–	1.2205	31.0000
–	.0197	0.5000	–	.3543	9.0000	–	0.7283	18.5000	1-1/4	1.2500	31.7500
–	.0295	0.7500	23/64	.3590	9.1280	47/64	0.7340	18.6530	–	1.2598	32.0000
1/32	.0313	0.7940	–	.3740	9.5000	–	0.7480	19.0000	1-9/32	1.2810	32.5440
–	.0394	1.0000	3/8	.3750	9.5250	3/4	0.7500	19.0500	–	1.2992	33.0000
3/64	.0469	1.1910	25/64	.3910	9.9220	49/64	0.7656	19.4470	1-5/16	1.3120	33.3380
–	.0590	1.5000	–	.3937	10.0000	25/32	0.7810	19.8440	–	1.3386	34.0000
1/16	.0620	1.5880	13/32	.4060	10.3190	–	0.7874	20.0000	1-11/32	1.3440	34.1310
5/64	.0781	1.9840	–	.4130	10.5000	51/64	0.7970	20.2410	1-3/8	1.3750	34.9250
–	.0787	2.0000	27/64	.4220	10.7160	13/16	0.8125	20.6380	–	1.3779	35.0000
3/32	.0940	2.3810	–	.4331	11.0000	–	0.8268	21.0000	1-13/32	1.4060	35.7190
–	.0984	2.5000	7/16	.4380	11.1130	53/64	0.8280	21.0340	–	1.4173	36.0000
7/64	.1090	2.7780	29/64	.4530	11.5090	27/32	0.8440	21.4310	1-7/16	1.4380	36.5130
–	.1181	3.0000	15/32	.4690	11.9060	55/64	0.8590	21.8280	–	1.4567	37.0000
1/8	.1250	3.1750	–	.4724	12.0000	–	0.8662	22.0000	1-15/32	1.4690	37.3060
–	.1378	3.5000	31/64	.4840	12.3030	7/8	0.8750	22.2250	–	1.4961	38.0000
9/64	.1410	3.5720	–	.4920	12.5000	57/64	0.8906	22.6220	1-1/2	1.5000	38.1000
5/32	.1560	3.9690	1/2	.5000	12.7000	–	0.9055	23.0000	1-17/32	1.5310	38.8940
–	.1575	4.0000	–	.5118	13.0000	29/32	0.9062	23.0190	–	1.5354	39.0000
11/64	.1720	4.3660	33/64	.5156	13.0970	59/64	0.9220	23.4160	1-9/16	1.5620	39.6880
–	.1770	4.5000	17/32	.5310	13.4940	15/16	0.9375	23.8130	–	1.5748	40.0000
3/16	.1875	4.7630	35/64	.5470	13.8910	–	0.9449	24.0000	1-19/32	1.5940	40.4810
–	.1969	5.0000	–	.5512	14.0000	61/64	0.9530	24.2090	–	1.6142	41.0000
13/64	.2030	5.1590	9/16	.5630	14.2880	31/32	0.9690	24.6060	1-5/8	1.6250	41.2750
–	.2165	5.5000	–	.5710	14.5000	–	0.9843	25.0000	–	1.6535	42.0000
7/32	.2190	5.5560	37/64	.5790	14.6840	63/64	0.9844	25.0030	1-31/32	1.6562	42.0690
15/64	.2340	5.9530	–	.5906	15.0000	1	1.0000	25.4000	1-11/16	1.6875	42.8630
–	.2362	6.0000	19/32	.5940	15.0810	–	1.0236	26.0000	–	1.6929	43.0000
1/4	.2500	6.3500	39/64	.6090	15.4780	1-1/32	1.0312	26.1940	1-23/32	1.7190	43.6560
–	.2559	6.5000	5/8	.6250	15.8750	1-1/16	1.0620	26.9880	–	1.7323	44.0000
17/64	.2656	6.7470	–	.6299	16.0000	–	1.0630	27.0000	1-3/4	1.7500	44.4500
–	.2756	7.0000	41/64	.6406	16.2720	1-3/32	1.0940	27.7810	–	1.7717	45.0000
9/32	.2810	7.1440	–	.6496	16.5000	–	1.1024	28.0000	1-25/32	1.7810	45.2440
–	.2953	7.5000	21/32	.6560	16.6690	1-1/8	1.1250	28.5750	–	1.8110	46.0000
19/64	.2970	7.5410	–	.6693	17.0000	–	1.1417	29.0000	1-13/16	1.8125	46.0380
5/16	.3120	7.9380	43/64	.6720	17.0660	1-5/32	1.1560	29.3690	1-27/32	1.8440	46.8310

# Conversion Conversion Chart

Inches Fractions	Decimals	MM	Inches Fractions	Decimals	MM	Inches Fractions	Decimals	MM	Inches Fractions	Decimals	MM
–	1.8504	47.0000	2-1/2	2.5000	63.5000	–	3.1496	80.0000	3-25/32	3.7810	96.0440
1-7/8	1.8750	47.6250	–	2.5197	64.0000	3-5/32	3.1560	80.1690	3-13/16	3.8125	96.8380
–	1.8898	48.0000	2-17/32	2.5310	64.2940	3-3/16	3.1875	80.9630	–	3.8189	97.0000
1-29/32	1.9062	48.4190	–	2.5590	65.0000	–	3.1890	81.0000	3-26/32	3.8440	97.6310
–	1.9291	49.0000	2-9/16	2.5620	65.0880	3-7/32	3.2190	81.7560	–	3.8583	98.0000
1-15/16	1.9375	49.2130	2-19/32	2.5940	65.8810	–	3.2283	82.0000	3-7/8	3.8750	98.4250
–	1.9685	50.0000	–	2.5984	66.0000	3-1/4	3.2500	82.5500	–	3.8976	99.0000
1-31/32	1.9690	50.0060	2-5/8	2.6250	66.6750	–	3.2677	83.0000	3-29/32	3.9062	99.2190
2	2.0000	50.8000	–	2.6380	67.0000	3-9/32	3.2810	83.3440	–	3.9370	100.0000
–	2.0079	51.0000	2-21/32	2.6560	67.4690	–	3.3071	84.0000	3-15/16	3.9375	100.0130
2-1/32	2.0313	51.5940	–	2.6772	68.0000	3-5/16	3.3120	84.1377	3-31/32	3.9690	100.8060
–	2.0472	52.0000	2-11/16	2.6875	68.2630	3-11/32	3.3440	84.9314	–	3.9764	101.0000
2-1/16	2.0620	52.3880	–	2.7165	69.0000	–	3.3464	85.0000	4	4.0000	101.6000
–	2.0866	53.0000	2-23/32	2.7190	69.0560	3-3/8	3.3750	85.7250	4-1/16	4.0620	103.1880
2-3/32	2.09400	53.1810	2-3/4	2.7500	69.8500	–	3.3858	86.0000	4-1/8	4.1250	104.7750
2-1/8	2.1250	53.9750	–	2.7559	70.0000	3-13/32	3.4060	86.5190	–	4.1338	105.0000
–	2.1260	54.0000	2-25/32	2.7810	70.6439	–	3.4252	87.0000	4-3/16	4.1875	106.3630
2-5/32	2.1560	54.7690	–	2.7953	71.0000	3-7/16	3.4380	87.3130	4-1/4	4.2500	107.9500
–	2.1650	55.0000	2-13/16	2.8125	71.4376	–	3.4646	88.0000	4-5/16	4.3120	109.5380
2-3/16	2.1875	55.5630	–	2.8346	72.0000	3-15/32	3.4690	88.1060	–	4.3307	110.0000
–	2.2047	56.0000	2-27/32	2.8440	72.2314	3-1/2	3.5000	88.9000	4-3/8	4.3750	111.1250
2-7/32	2.2190	56.3560	–	2.8740	73.0000	–	3.5039	89.0000	4-7/16	4.4380	112.7130
–	2.2440	57.0000	2-7/8	2.8750	73.0250	3-17/32	3.5310	89.6940	4-1/2	4.5000	114.3000
2-1/4	2.2500	57.1500	2-29/32	2.9062	73.8190	–	3.5433	90.0000	–	4.5275	115.0000
2-9/32	2.2810	57.9440	–	2.9134	74.0000	3-9/16	3.5620	90.4877	4-9/16	4.5620	115.8880
–	2.2835	58.0000	2-15/16	2.9375	74.6130	–	3.5827	91.0000	4-5/8	4.6250	117.4750
2-5/16	2.3120	58.7380	–	2.9527	75.0000	3-19/32	3.5940	91.2810	4-11/16	4.6875	119.0630
–	2.3228	59.0000	2-31/32	2.9690	75.4060	–	3.6220	92.0000	–	4.7244	120.0000
2-11/32	2.3440	59.5310	–	2.9921	76.0000	3-5/8	3.6250	92.0750	4-3/4	4.7500	120.6500
–	2.3622	60.0000	3	3.0000	76.2000	3-21/32	3.6560	92.8960	4-13/16	4.8125	122.2380
2-3/8	2.3750	60.3250	3-1/32	3.0312	76.9940	–	3.6614	93.0000	4-7/8	4.8750	123.8250
–	2.4016	61.0000	–	3.0315	77.0000	3-11/16	3.6875	93.6630	–	4.9212	125.0000
2-13/32	2.4060	61.1190	3-1/16	3.0620	77.7880	–	3.7008	94.0000	4-15/16	4.9375	125.4130
2-7/16	2.4380	61.9130	–	3.0709	78.0000	3-23/32	3.7190	94.4560	5	5.0000	127.0000
–	2.4409	62.0000	3-3/32	3.0940	78.5810	–	3.7401	95.0000			
2-15/32	2.4690	62.7060	–	3.1102	79.0000	3-3/4	3.7500	92.2500			
–	2.4803	63.0000	3-1/8	3.1250	79.3750	–	3.7795	96.0000			



# Glossary

## Alpha/Numeric

### A:

**abrasion:** external damage to a hose assembly caused by its being rubbed on a foreign object; a wearing away by friction.

**ABS:** Air-Brake Swivel

**absorption:** regarding hose, the process of taking in fluid. Hose materials are often compared with regard to relative rates and total amounts of absorption as they pertain to specific fluids.

**acid resistant:** having the ability to withstand the action of identified acids within specified limits of concentration and temperature.

**adapter, adaptor:**

1. connectors of various sizes and materials used to change an end connector from one type to another type or one size to another. (i.e., a male SAE to male pipe adapter is often attached to a female SAE to create a male end union connector);
2. the grooved portion of a cam & groove coupling.

**adhesion:** the strength of bond between cured rubber surfaces or between a cured rubber surface and a non-rubber surface.

**adhesive:** a material which, when applied, will cause two surfaces to adhere.

**ambient/atmospheric conditions:** The surrounding conditions, such as temperature, pressure, and corrosion, to which a hose assembly is exposed.

**anchor:** a restraint applied to eliminate motion and restrain forces.

**anodize, anodized:** an electrolytic process used to deposit protective or cosmetic coatings in a variety of colors on metal, primarily used with aluminum.

**ANSI:** American National Standards Institute.

**Application working pressure:** unique to customer's application. See pressure, working.

**assembly:** a general term referring to any hose coupled with end connectors of any style attached to one or both ends.

**ASTM:** American Society for Testing and Materials.

**axial movement:** compression or elongation along the longitudinal axis.

### B:

**barb:** the portion of a connector (coupling) that is inserted into the hose, usually comprised of two or more radial serrations or ridges designed to form a redundant seal between the hose and connector.

**barbed and ferrule**

**connector:** a two-piece hose connector comprised of a barbed insert (nipple), normally with peripheral ridges or backward-slanted barbs, for inserting into a hose and a ferrule, usually crimped or swaged.

**bend radius:** the radius of a bent section of hose measured to the innermost surface of the curved portion.

**bend radius, minimum:** the smallest radius at which hose or tubing can be used. For Metal Hose: the radius of a bend measured to the hose centerline, as recommended by the manufacturer.

**bore:**

1. an internal cylindrical passageway, as of a tube, hose or pipe;
2. the internal diameter of a tube, hose, or pipe.

**braid:** the woven portion of a hose used as reinforcement to increase pressure rating and add hoop strength. Various materials such as polyester, cotton or metal

wire are used. A hose may have one or more braids, outside or between layers of hose material.

**braided ply:** a layer of braided reinforcement.

**brand:** a mark or symbol identifying or describing a product and/or manufacturer, that is embossed, inlaid or printed.

**brass:** a family of copper/zinc alloys.

**brazing:** a process of joining metals using a non-ferrous filler metal having a melting point that is lower than the "parent metals" to be joined, typically over +800°F.

**bronze:** an alloy of copper, tin and zinc.

**BSPP/BSPT:**

British Standard Pipe Parallel / British Standard Pipe Tapered. See Connector/Coupling - Pipe Thread Connectors.

### C:

**chalking:** the formation of a powdery surface condition due to disintegration of surface binder or elastomer by weathering or other destructive environments.

**chemical compatibility:** the relative degree to which a material may contact another without corrosion, degradation or adverse change of properties.

**chemical resistance:** the ability of a particular polymer, rubber compound, or metal to exhibit minimal physical and/or chemical property changes when in contact with one or more chemicals for a specified length of time, at specified concentrations, pressure, and temperature.

**cold flexibility:** relative ease of bending while being exposed to specified low temperature.

**combustible liquid:** a combustible liquid is one having a flash point at or above +100°F (37.8°C).

**compound:** the mixture of rubber or plastic and other materials, which are combined to give the desired properties when, used in the manufacture of a product.

**compression connector:**

see connector/coupling - Compression

**conductive:** the ability to transfer electrical potential.

**configuration:** the combination of connectors on a particular assembly.

**core:** the inner portion of a hose, usually referring to the material in contact with the medium.

**corrosion:** the process of material degradation by chemical or electrochemical means.

**corrosion resistance:** ability of metal components to resist oxidation.

**coupling:** a frequently used alternative term for hose end connector.

**cover:** the outer component usually intended to protect the carcass of a product.

**CPE:** chlorinated polyethylene, a rubber elastomer.

**cracking:** a sharp break or fissure in the surface, generally caused by strain and environmental conditions.

### D:

**date code:** any combination of numbers, letters, symbols or other methods used by a manufacturer to identify the time of manufacture of a product.

**deburr:** to remove ragged edges from the inside diameter of a hose end.

**design factor:** a ratio used to establish the working pressure of the hose, based on the burst strength of the hose.

**DOT:** Department of Transportation.**DIN:** Deutsche Industrie Norme.

**durometer:** an instrument for measuring the hardness of rubber and plastic compounds.

### E:

**eccentricity:** the condition resulting from the inside and outside diameters not having a common center.

# Glossary

## Alpha/Numeric

**effusion:** the escape, usually of gases, through a material. See permeation.

**elastic limit:** the limiting extent to which a body may be deformed and yet return to its original shape after removal of the deforming force.

**elastomer:** any one of a group of polymeric materials, usually designated thermoset, such as natural rubber, or thermoplastic, which will soften with application of heat.

**elongation:** the increase in length expressed numerically as a percentage of the initial length.

**endurance test:** a service or laboratory test, conducted to product failure, usually under normal use conditions.

**extrude/extruded/ extrusion:** forced through the shaping die of an extruder; extrusion may have a solid or hollow cross section.

### F:

**fabricator:** the producer of hose and tubing assemblies.

**fatigue:** the weakening or deterioration of a material occurring when a repetitious or continuous application of stress causes strain, which could lead to failure.

**FDA:** United States Food and Drug Administration.

**connector/coupling:** a device attached to the end of the hose to facilitate connection. The following is only a partial

list of types of connectors available:

**Compression Connector-** a connector style that seals on a mating tube by compressing an internal ferrule against the tube O.D.

**Field Attachable Connector** a connector designed to be attached to hose without crimping or swaging. This

connector is not always a reusable type connector.

**Inverted Flare Connector** a connector consisting of a male or female nut, trapped on a tube by flaring the end of the tube material to either 37° or 45°.

**JIC Connectors** - joint Industrial Council (no longer in existence). An engineering group that established an industry standard connector design incorporating a 37° mating surface, male and female styles. These standards are now governed by SAE.

**O-ring Connectors** - a connector that seals by means of an elastomeric ring of a specified material.

**Pipe Thread Connectors** -

**NPT** - National Pipe Taper. Pipe thread per ANSI B1.20.1

**NPTF** - National Pipe Tapered for Fuels. (Same as above except dry-seal per ANSI B1.20.3)

**NPSH** - National Pipe Straight Hose per ANSI B1.20.7

**NPSM** - National Pipe Straight Mechanical. Straight thread per ANSI B1.20.1

**NPSL** - National Pipe Straight Loose fit per ANSI B1.20.1

**BSPP, BSPT** - British Standard Pipe, Parallel, British Standard Pipe Taper. BS21

**Quick Connect Connector** - a connector designed to quickly connect and disconnect. These connectors come in many styles and types.

**Tube Connector** - a hose connector of which the mating end conforms to a tube diameter. The mate or male end of a compression connector.

**Flammable gases/liquid/media:** a flammable gas, including liquefied gas, is one having a closed cup flash point below +100°F (+37.8°C) and a vapor pressure greater than 25 psi. (174.2 KPa).

**flow rate:** a volume of media being conveyed in a given time period.

**fluid:** a gas or liquid medium.

### G:

**GPM:** gallons per minute.

### H:

**heat resistance:** the property or ability to resist the deteriorating effects of elevated temperatures.

**hose:** a flexible conduit consisting of a tube, reinforcement, and usually an outer cover.

**hydrostatic testing:** the use of liquid pressure to test a hose or hose assembly for leakage, twisting, and/or hose change-in-length.

**Hytrell:** a DuPont registered trademark.

### I:

**I.D.:** the abbreviation for inside diameter.

**identification yarn:** a yarn of single or multiple colors, usually embedded in the hose wall, used to identify the manufacturer.

**ISO:** International Organization for Standardization.

### J:

**JIC:** see connector/coupling-JIC.

### K:

**kinking:** a temporary or permanent distortion of the hose induced by bending beyond the minimum bend radius.

### L:

**layline:** the line of printed information that runs parallel on the side of a manufactured hose giving details such as part number, PSI rating, hose size and manufacturing data.

**layer:** a single thickness of rubber or fabric between adjacent parts.

**loop installation:** the assembly is installed in a loop or "U" shape, and is most often used when frequent and/or large amounts of motion are involved.

**LPG, LP Gas:** the abbreviation for liquefied petroleum gas.

### M:

**MAWP:** see pressure, maximum allowable working.

**manufacturer's identification:** a code symbol used on or in some hose to indicate the manufacturer.

**media, medium:** the substance(s) being conveyed through a system.

### N:

**NAHAD:** the abbreviation for the National Association of Hose & Accessories Distributors.

**Neoprene:** a registered trademark of DuPont.

**nipple:** the internal member or portion of a hose connector.

**nitrile rubber (NB/Buna-N):** a family of acrylonitrile elastomers used extensively for industrial hose.

**nominal:** a size indicator for reference only.

**nomograph:** a chart used to compare hose size to flow rate to recommended velocity.

**non-conductive:** the inability to transfer an electrical charge.

**NPT/NPTF:** abbreviation for national pipe threads. See connector/coupling - Pipe Thread Connectors.

**nylon:** a family of polyamide materials.

### O:

**OAL:** see overall length

**O.D.:** the abbreviation for outside diameter.

**OE/OEM:** original equipment manufacturer.

**oil resistance:** the ability of the materials to withstand exposure to oil.

**oil swell:** the change in volume of a rubber article resulting from contact with oil.

**operating conditions:** the pressure, temperature, motion, and environment to which a hose assembly is subjected.

**overall length (OAL):** the total length of a hose assembly,

# Glossary

## Alpha/Numeric

which consists of the free hose length plus the length of the coupling(s).

**oxidation:** the reaction of oxygen on a material, usually evidenced by a change in the appearance or feel of the surface or by a change in physical properties.

**ozone cracking:** the surface cracks, checks or crazing caused by exposure to an atmosphere containing ozone.

**ozone resistance:** the ability to withstand the deteriorating effects of ozone (generally cracking).

### P:

**permanent connector:** the type of connector which, once installed, may not be removed for re-use.

**permeation:** the process of migration of a substance into and through another, usually the movement of a gas into and through a hose material; the rate of permeation is specific to the substance, temperature, pressure and the material being permeated.

**plating:** a material, usually metal, applied to another metal by electroplating, for the purpose of reducing corrosion; typically a more noble metal such a zinc is applied to steel.

**ply:** an individual layer in hose construction.

**polymer:** a macromolecular material formed by the chemical combination of monomers, having either the same or different chemical compositions.

**pressure:** force ÷ unit area. For purposes of this document, refers to PSIG (pounds per square inch gauge).

**pressure drop:** the measure of pressure reduction or loss over a specific length of hose.

**pressure, burst:** the pressure at which rupture occurs.

**pressure, working:** the maximum pressure to which a hose will be subjected,

including the momentary surges in pressure, which can occur during service. Abbreviated as WP.

**psi (PSI):** pounds per square inch.

**PTFE:** polytetrafluoroethylene, a high molecular weight fluoroplastic polymer with carbon atoms shielded by fluorine atoms having very strong inter atomic bonds, giving it chemical inertness.

**Push>Connect:** (Push>Connect Metric, Push>Connect Flow Controls, Push>Connect Plus) A Reusable, easy to assemble connector recommended on compressed air, lubrication, and pneumatic instrumentation applications. Use with approved tubing material.

**PVC:** polyvinyl chloride. A low cost thermoplastic material typically used in the manufacture of industrial hoses. The operating temperature range is -500°F to +1750°F (-295.5°C to +954.4°C).

### Q:

**Quick>Connect:** A reusable easy to assemble air brake connector used on NT100 series tubing. This connector meets D.O.T. performance requirements.

### R:

**reinforcement:** the strengthening members, consisting of either fabric, cord, and/or metal, of a hose. See ply.

**reusable connector/coupling:** see connector/coupling, Field Attachable Connectors.

### S:

**SAE:** Society of Automotive Engineers.

**shank:** that portion of a connector, which is inserted into the bore of a hose.

**specification:** a document setting forth pertinent details of a product.

**spring guard:** a helically wound component applied internally or externally to a hose assembly, used for strain relief,

abrasion resistance, collapse resistance.

**standard:** a document, or an object for physical comparison, for defining product characteristics, products, or processes, prepared by a consensus of a properly constituted group of those substantially affected and having the qualifications to prepare the standard for use.

**stem:** see nipple.

**surge (spike):** a rapid and transient rise in pressure.

**swelling:** an increase in volume or linear dimension of a specimen immersed in liquid or exposed to a vapor.

### T:

**Teflon®:** a registered trademark of DuPont used under license by Danfoss. See PTFE, FEP and PFA.

**tube:** the innermost continuous all-rubber or plastic element of a hose.

**tube connector:** see connector/coupling-Tube.

**tubing:** a non-reinforced, homogeneous conduit, generally of circular cross-section.

### V:

**vacuum resistance:** the measure of a hoses ability to resist negative gauge pressure.

**vibration:** amplitude motion occurring at a given frequency.

**viscosity:** the resistance of a material to flow.

### W:

**weathering:** the surface deterioration of a hose cover during outdoor exposure, as shown by checking, cracking, crazing and chalking.

**working temperature:** the temperature range of the application, may include the temperature of the fluid conveyed or the environmental conditions the assembly is exposed to in use.

**WP:** the abbreviation for working pressure.

The preceding Glossary of Terms, as utilized in the hose industry, includes some definitions from The Hose Handbook, published by the Rubber Manufacturers Association.

# Index

## Numeric/Alpha

A55SCUx	72	46x	40	1272x	59	117-550644-03	87
A555	109	48x	41	1274x	58	217-2120403	87
A555P	110	49x	42	1360x	95	217-35004-03	86
A555S	109	50x	42	1361x	95	217-38404-03	86
A556P	110	51x	43	1362x	95	217-38206-03	86
A557MCUx	72	54x	41	1364x	97	A6860	109
A557SCUx	72	55x	42	1366x	96	A6860S	109
A655	109	56x	43	1368x	95	B735	109
A660	109	59x	123	1369x	96	C-15X	142
A664	116	60x	45	1369x-L	96	C-63X	142
A690	109	61x	45	1371x	97	C9200	123
A690P	110	62x	46	1372x	97	C9240	123
A690S	109	63x	47	1380x	96	CA-631	148
A694	116	64x	49	1408	121	CA-632	143
A694S	116	65x	48	1421-7	112	CB-63X	142
A6690	109	66x	47	1421-18	112	CD-15	142
A6690S	109	68x	46	1421-24	112	CL-490	141
A6754	116	69x	48	1421-32	112	CL-491	141
A6754S	116	70x	48	1421-60	112	CL-492	141
A6755	109	71x	49	1421-60A	112	CL-494	141
A6755S	109	72x	49	1424A	111	CL-496	141
A6759	116	74x	47	1425A	111	CL-497	141
A6760	109	76x	49	1426A	111	CL-498	141
A6760P	110	100x	35	1428	121	CL-499	141
A6760S	109	105x	35	1429	121	CL-500	141
A6763	109	110	114	1432	121	CL-501	141
A6764	116	111	114	1460x	89	CL-503	141
A6764S	116	112	114	1461x	89	FC-16X	145
A6765	109	113	114	1462x	89	FC-161	148
A6765S	109	114	114	1464x	91	FF90587	117
A6769	116	115	114	1465x	93	FF90588	117
A6769S	116	116	114	1466x	90	FF90589	117
A6770	109	117	114	1468x	90	FF90590	120
A6774	116	118	114	1469x	91	FF90591	120
A6775	109	119	114	1469x-L	91	FF90592	120
A6779	116	121	114	1470x	91	FF90593	120
A6779S	116	122	114	1471x	92	FF90594	120
A6845	109	123	114	1472x	92	FF90595	119
A6855	109	124	114	1474x	90	FF90596	119
A6855S	109	125	114	1477x	92	FF90597	118
45x	43	1271x	59	7978	123	FF90598	118

# Index

## Numeric/Alpha

FS-800	141	721x	55	1861x	81	PT24004	29
FS-900	141	741x	54	1862x	81	PT24044	29
FS-1000	141	752x	38	217-35006-03	86	PT24005	29
FS-2100	141	1480x	90	217-38606-03	86	PT24006	29
126	114	1482x	93	217-38408-03	86	PT24008	29
127	114	1484x	93	217-35008-03	86	PT24010	29
131x	35	1485x	93	217-38808-03	86	PT24012	29
162x	46	1502x	134	217-38610-03	86	PT24016	29
163x	47	1502Px	134	217-35010-03	86	0102x	46
164x	49	1529x	134	FS-3300	141	1062x	76
165x	48	1529Px	134	FT1341	138	1064x	78
166x	47	1531x	134	FT1356	138	1065x	77
168x	46	1561x	133	FT1356-2-1	138	1066x	76
169x	48	1561xG	133	FT1600	142	1067x	77
170x	48	1561Px	133	FT1601	142	1068x	76
171x	49	1562x	130	FT1602	142	1069x	77
172x	49	1562Px	130	FT1605	142	1070x	77
174x	47	1564x	132	FT1607	148	1071x	78
202x	36	1564Px	132	FT1608	148	1072x	78
252x	36	1565x	132	FT1613	149	1073x	76
302x	35	1565Px	132	M41157	123	1074	77
352x	36	1566x	130	MTP16004	30	1074x	77
402x	37	1566Px	130	MTP16005	30	1075x	78
452x	37	1568x	129	MTP16006	30	1077x	78
502x	37	1568Px	129	MTP16008	30	1078x	76
601x	52	1569x	131	MTP16010	30	1079x	76
602x	38	1569Px	131	MTP16012	30	1100x-MM	136
611x	52	1570x	131	PC-48	149	1100x-PP	136
621x	53	1570Px	131	PT20004	28	1105x	62
630	110	1571x	133	PT20044	28	1105x-M	67
631x	53	1571Px	133	PT20005	28	1107x	63
632	143	1572x	132	PT20006	28	1107x-M	68
641x	55	1572Px	132	PT20008	28	1108Px	73
651x	54	1574x	129	PT20010	28	1108x	64
652x	38	1574Px	129	PT20012	28	1109x	62
661x	53	1584	133	PT20016	28	1109x-M	67
681x	53	1611x	46	PT23002	28	1110x	40
691x	54	1800Kx	87	PT23003	28	1129x	62
701x	54	1800T	147	PT23004	28	1129x-MRP	67
702x	38	1800TRK	87	PT23005	28	1150x-PP	136
711x	55	1829x	87	PT23006	28	1161x	62

# Index

## Numeric/Alpha

1161x-M	67	3328x	104	1165x-M	69	3600x	106
1162x	63	3329x	104	1166x	64	3700x	106
1162x-M	67	3330x	104	1166x-M	68	3750x	106
1164x	65	3331x	104	1168Px	73	3950x	106
1164x-M	70	3350x	105	1168x	64	FF3959-0204B	107
1864x	84	217-43404-03	86	1168x-M	68	FF3959-0205B	107
1865x	83	217-43604-03	86	1168x-MM	68	FF3959-0406B	107
1866x	82	217-43206-03	86	1169x	65	FF3959-0606B	107
1868x	82	217-40006-03	86	1169Px	74	FF3959-0608B	107
1869x	83	217-43606-03	86	1169x-S	65	FF3959-0806B	107
1869x-L	83	217-43806-03	86	1169x-M	69	FF3959-0808B	107
1869x-S	84	217-43408-03	86	1169x-MPTS	69	FF3959-0810B	107
1870x	84	T-105	139	1169x-5MMS	69	FF3960-01-0204B	107
1871x	84	T-106	139	1171x	65	FF3960-01-0606B	107
1871x-S	85	T-108	139	1171Px	74	FF3960-01-0608B	107
1872x	85	T-135	138	1171x-M	70	FF3960-01-0808B	107
1872x-S	85	T-150	137	1171x-S	65	FF3960-01-0810B	107
1873x	81	T-191	138	1172Px	74	FF3960-0205B	107
1874x	81	T-191B	138	1172x-M	70	4245-022	31
1877x	85	T-345	140	1172x-S	66	4245-025	31
1880x	82	T-345K	140	1172x-MM5	70	4245-03	31
1880x-S	83	T-346x	140	1174x	63	4245-04	31
1883x	87	T-1422R	137	1174x-M	68	4245-05	31
1944	135	TP16002	29	1180x	63	4247-041	31
2030x	45	TP16025	29	1180x-M	67	6100x	100
3129x	102	TP16004	29	1181x	66	6200x	100
3150x	102	TP16005	29	1183x	66	6400x	100
3151x	102	TP16006	29	1184x	66	7727	124
3152x	102	TP16008	29	1185x	66	7732	124
3153x	102	W15310	115	1202x	57	7765	125
3200x	102	W20332	98	1260x	57	7817	124
3220x	103	5X6 PB	141	1261x	57	7896x	35
3250x	103	6X10 PB	141	1261xA	57	7898	125
3270-06	31	8X12 PB	141	1262x	57	7900	125
3270-08	31	39x	40	1264x	59	7901	125
3270-10	31	40x	40	1266x	58	7905	125
3270-12	31	41x	40	1268x	58	7933	125
3300x	103	42x	40	1269x	59	7934A	126
3325x	104	43x	41	1270x	59	7977	123
3326x	104	44x	43	3400x	105	217-40008-03	86
3327x	104	1165x	64	3500x	106	217-43808-03	86

# Index

## Numeric/Alpha

<u>217-43610-03</u>	<u>86</u>
<u>217-40004-03</u>	<u>86</u>
<u>217-40010-03</u>	<u>86</u>
<u>211273A</u>	<u>112</u>
<u>211280A</u>	<u>112</u>



ENGINEERING  
TOMORROW



**Danfoss Power Solutions**, Nordborgvej 81, 6430 Nordborg, Denmark, Tel. +45 74 88 22 22, Fax +45 74 65 25 80  
www.danfoss.com, E-mail: info@danfoss.com

Any information, including, but not limited to information on selection of product, its application or use, product design, weight, dimensions, capacity or any other technical data in product manuals, catalogues descriptions, advertisements, etc. and whether made available in writing, orally, electronically, online or via download, shall be considered informative, and is only binding if and to the extent, explicit reference is made in a quotation or order confirmation. Danfoss cannot accept any responsibility for possible errors in catalogues, brochures, videos and other material. Danfoss reserves the right to alter its products without notice. This also applies to products ordered but not delivered provided that such alterations can be made without changes to form, fit or function of the product. All trademarks in this material are property of Danfoss A/S or Danfoss group companies. Danfoss and the Danfoss logo are trademarks of Danfoss A/S. All rights reserved.