

ENGINEERING
TOMORROW

Danfoss

Data center **liquid cooling**

Liquid cooling solutions, designed specifically to meet the growing demands of today's data center.

30 years

Danfoss has been setting the standard in liquid cooling for over 30 years.

The power of **Water**

It's better at **cooling**

1,000x

more cooling capacity

25x

better heat transfer

10x

less energy use

It's better for **your business**

40%

energy use reduction

Greater

chip density, with fewer racks

Easier

to maintain than immersion cooling

It's better for **the environment**

Smaller

carbon footprint

Minimal

water use

Reduced

refrigeration

Why **liquid cooling?**

For increased performance, energy efficiency and cost savings, there is simply no substitute for direct-to-chip liquid cooling. No other system unlocks the full potential of your data center while simplifying installation and maintenance like Danfoss fluid conveyance solutions.

Energy sustained

Danfoss' direct-to-chip liquid cooling improves data center Power Usage Effectiveness (PUE) by efficiently and cost-effectively removing heat emitted by a server processor.

Performance unleashed

The thermal efficiency and reduced space requirements of liquid cooling enables increased chip density, unlocking your data center's full potential. Danfoss' hoses and connectors route coolant from the source to the chip, keeping your high-performing processors running smoothly, even during peak loads. That means consistent computing power and increased performance when you need it most.

40%

Up to 40% energy
use reduction with
water cooling

The Danfoss way

For decades, our fluid conveyance experts have helped shape and evolve the direct-to-chip liquid cooling market, delivering high-performance source line and rack cooling solutions, while keeping ease of installation and service a priority.



One partner, every solution

Danfoss has a comprehensive portfolio of premium fluid conveyance products to meet your thermal management system needs. With products designed to work in concert, we'll deliver everything you need for a high-performing source-to-rack cooling solution.

Creative design solutions are our specialty

With optional configurations, Danfoss' fluid conveyance solutions offer the flexibility you need to design the ultimate data center. Our products are designed to work in tight spaces to simplify installation and maintenance, ensuring your cooling system operates efficiently.

Making cutting-edge simple

Peace of mind and resiliency — that's what Danfoss liquid cooling systems bring to your data center design. Whether it's hoses with the highest-level flame rating available (UL94 V0), or individually leak-tested dry-break couplings, Danfoss delivers market-leading technology optimized for performance and reliability.

Experts everywhere

We are your liquid cooling experts. We pioneered leak-free, quick disconnect technology with IBM decades ago and remain at the forefront of the industry today. And with a global team embedded in all major regions of the world, our extensive knowledge ensures each customer has what they need to be successful.



OPEN
Compute Project
SOLUTION PROVIDER®

A member of OCP

Danfoss is a Solution Provider of the Open Compute Project (OCP), a collaborative, community-focused organization working to standardize the design and performance of all hardware for small- to hyper-scale data centers. We're not just meeting the industry standard; we're helping set it, both today and into the future.

Making connections **you can count on.**

From main supply lines to single point connections, Danfoss provides the hardware to make your software work.



**Danfoss Hansen®
FD83 Series**
Full-flow dual-interlock
coupling

An industry standard, our stainless steel FD83 has been supporting data center liquid cooling reliably for decades.



To data center
Cooling
Distribution
Unit (CDU)

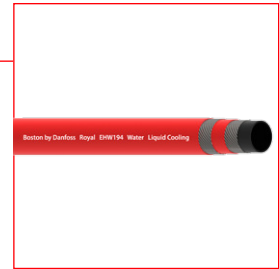

**Boston by Danfoss
Royal™ EHW194 EPDM hose**

Engineered for durability and ease of use, EHW194 hoses feature industry-leading safety ratings, superior kink resistance and long-lasting performance.



FLUID COMPATIBILITY



FULL FLOW





EASE OF USE





RELIABILITY

Source line solutions

Every data center has different requirements. Our range of fluid conveyance solutions enable you to engineer the **safest and most efficient** thermal management system for your data center.

Couplings			
<ul style="list-style-type: none"> Leak-free and corrosion resistant. 100% helium leak tested. FD83 patented locking mechanism ensures parts cannot be disconnected while liquid is flowing. FD83 offers unlimited configuration options, eliminating extra clamps or additional components. 			
FD83 series Full-flow dual-interlock coupling Stainless steel		<ul style="list-style-type: none"> 303 Stainless steel or engineered plastic Standard seal material: EPDM Locking pin design and lever handle Identical coupling halves 	<ul style="list-style-type: none"> Highest flow and low spillage 100% helium leak tested Size: 1" and 2" Port Connections: 3/4", 1" and 2" Pairs with: <ul style="list-style-type: none"> FC332 EHW194
MLDB series Flat face, dry break coupling		<ul style="list-style-type: none"> 316 Stainless steel Standard seal material: EPDM Integrated pre-guiding system for easy connection Flat face design 	<ul style="list-style-type: none"> Color coding available High flow and no spillage Sizes: 1/4" to 1" Sizes for source line and inner rack installations Pairs with: <ul style="list-style-type: none"> FC332 EHW194 GH109

Hoses			
<ul style="list-style-type: none"> Full, unrestricted flow and excellent kink resistance. Multiple size and specification options to meet your requirements. Hoses with UL94 V0 rating — leads the industry. Tested with wide range of industry standard coolant solutions to ensure compatibility with corrosion inhibitors, eliminating contamination and ensuring long life. 			
FC332 Socketless hose		<ul style="list-style-type: none"> CPE tube and cover, textile braid reinforcement UL94 HB compliant Excellent kink resistance 	<ul style="list-style-type: none"> Operating temperature: -40°C to +150°C (-40°F to 302°F) Sizes: -04, -06, -08, -10, -12
Boston Royal EHW194 Rubber hose		<ul style="list-style-type: none"> EPDM tube and cover, two-ply textile reinforcement UL 94 V-0 rated Smooth, kink resistant hose with tight bend radius for routing Qualified with push-on & crimp fitting options 	<ul style="list-style-type: none"> Multiple color options (black, blue, red and grey) Operating temperature: -40°C to +140°C (-40°F to 284°F) Sizes -4 thru -16 (except -5) 16 bar (232 psi)

Fittings			
Socketless Fittings		<ul style="list-style-type: none"> Brass or stainless steel Configurable end connections available No tools needed No clamps required 	<ul style="list-style-type: none"> Qualified with FC332, GH109 and EHW194 hoses

Solutions to your **liquid cooling challenges.**



OCP
INSPIRED™

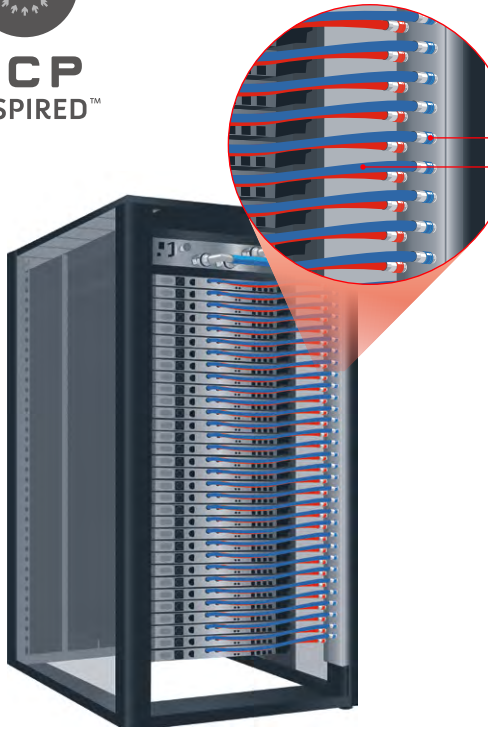

Danfoss UQD
Universal quick disconnect
coupling

Designed for high flow rate and no spillage, the UQD coupling is perfect for in-rack applications with smaller hose lines.

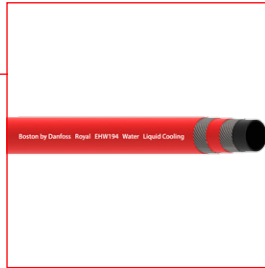

Boston by Danfoss
Royal™ EHW194 EPDM hose

Engineered for durability and ease of use, EHW194 hoses feature industry-leading safety ratings, superior kink resistance and long-lasting performance.

Danfoss Blind Mate
Hands-free self-centering
quick disconnect coupling

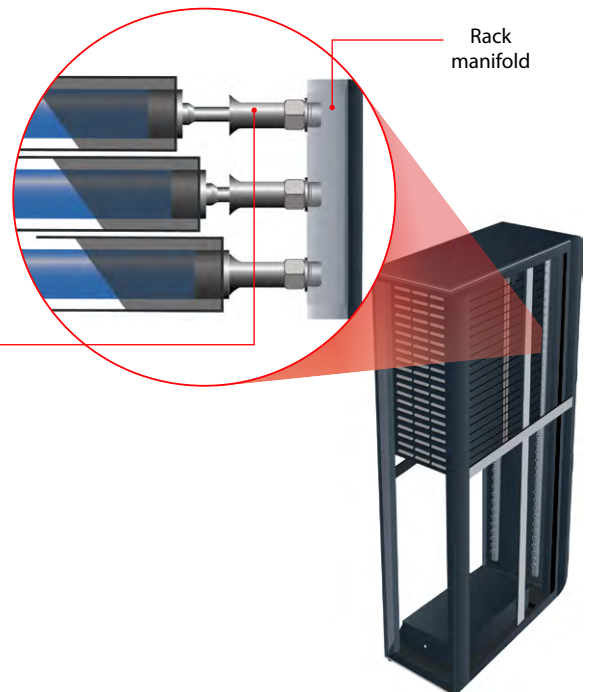

The Blind Mate's self-centering design offers misalignment compensation, ensuring simple and secure connection between the blade and rack manifold.





Rack
manifold

Inner rack solutions

Danfoss' direct-to-chip cooling solutions extend into the racks through efficient routing of flexible, kink-free hoses, and leak free, helium-tested couplings.

Couplings				
<ul style="list-style-type: none"> No-leak, no-drip designs. Corrosion-resistant anodized aluminum, stainless steel or composite plastic options. Deliver high flow and low pressure drop. 				
Blind Mate Hands-free self-centering quick disconnect coupling		<ul style="list-style-type: none"> 303 stainless steel EPDM seal Self-centering design with radial, angular and axial misalignment compensation Designed for hands-free connection 	<ul style="list-style-type: none"> Interchange meets OCP standard 100% helium leak tested Sizes: 3mm 	Pairs with: • EHW194 • GH109
ADB Flat face/dry break couplings		<ul style="list-style-type: none"> Aluminum EPDM seal Integrated pre-guiding system for connection Flat face design 	<ul style="list-style-type: none"> Color coding available High flow and no spillage Sizes: 1/4" to 1" Available in stainless steel (MLDB) 	
UQD Universal quick disconnect coupling		<ul style="list-style-type: none"> 303 and 304 stainless steel EPDM seal Push-to-connect design Meets OCP performance specifications 	<ul style="list-style-type: none"> High flow and no spillage 100% helium leak tested Sizes: UQD02, UQD04, UQD06, UQD08 	

Hoses				
<ul style="list-style-type: none"> Hoses with UL94 V0 rating — leads the industry. Best-in-class rubber hoses and thermoplastic tubing form into shape for easier routing and perfect fit, while maintaining flexibility during installation. 				
GH109 EPDM hose		<ul style="list-style-type: none"> EPDM tube and cover, textile braid reinforcement Flexible and lightweight UL94 HB compliant 	<ul style="list-style-type: none"> Operating temperature: -40°C to +110°C (-40°F to 230°F) Sizes: 9mm, 9.5mm, 11mm 	
Boston Royal EHW194 Rubber hose		<ul style="list-style-type: none"> EPDM tube and cover, two-ply textile reinforcement UL 94 V-0 rated Smooth, kink resistant hose with tight bend radius for routing Qualified with push-on & crimp fitting options 	<ul style="list-style-type: none"> Multiple color options (black, blue, red and grey) Operating temperature: -40°C to +140°C (-40°F to 284°F) Sizes -4 thru -16 (except -5) 16 bar (232 psi) 	

Refrigerant solutions

Always innovating and evolving to deliver the latest in liquid cooling technology, Danfoss' refrigerant solutions meet the needs of the next generation of data center.

Refrigerant solutions				
GH001 & EZ Clip Fittings		<ul style="list-style-type: none"> Thermoplastic veneer lining with elastomeric tube, synthetic elastomer cover, textile reinforcement Lowest permeation assembly on the market Maximum kink resistance and qualified at full vacuum 	<ul style="list-style-type: none"> R134a, R1234yf, R407C, R404A, R12, 1234ze, 1233zd and other refrigerants Sizes: -4, -6, -8, -10, -12, -16 	

Fluid conveyance **solutions for liquid cooling** data centers

Efficient • Reliable • Sustainable

Count on Danfoss' data center experience to help lead the future of data center liquid cooling

Delivering industry-leading solutions with decades of proven performance, Danfoss' global team of fluid conveyance experts continually advance liquid cooling technology to enable the data center of tomorrow.

For more information visit:

danfoss.com/data-center-liquid-cooling

Danfoss can accept no responsibility for possible errors in catalogues, brochures and other printed material. Danfoss reserves the right to alter its products without notice. This also applies to products already on order provided that such alterations can be made without consequential changes being necessary in specifications already agreed. All trademarks in this material are property of the respective companies. Danfoss and the Danfoss logotype are trademarks of Danfoss A/S. All rights reserved.