

ENGINEERING
TOMORROW



Application Guide

iC7 Series Active Front End

iC7-Marine | iC7-Automation



Contents

1	Introduction to App Guide	5
1.1	Version History	5
1.2	Purpose of this Application Guide	5
1.3	Additional Resources	5
1.4	Safety Symbols	6
2	Application Software Overview	7
2.1	Introduction to the Application Software	7
2.1.1	General Features	8
2.1.2	Protection Features.....	11
2.2	Start and Stop Sequence	12
2.2.1	Starting when DC-Link Pre-Charge Ready is the MCB Closing Mode	13
2.2.2	Starting when Filter Energization Ready is the MCB Closing Mode	16
2.3	Fieldbus Profile Description	18
2.3.1	Fieldbus Control Word and Bit Description	21
2.3.2	Fieldbus Status Word and Bit Description	22
3	User Interfaces and How to Configure	23
3.1	Overview of User Interfaces.....	23
3.2	Control Panel	23
3.2.1	iC7 Control Panel Options	23
3.2.2	Control Panel Elements	24
3.2.3	Control Panel Basic Configurations.....	26
3.2.4	Control Panel Shortcuts.....	31
3.3	MyDrive® Insight.....	32
3.3.1	Getting Started with MyDrive® Insight	32
3.3.2	Accessing Parameters and Understanding Parameter Screens in MyDrive® Insight	35
3.3.3	PC Control to Operate the Converter Using MyDrive® Insight.....	38
3.3.4	Datalogger	39
3.3.5	Backup and Restore	43
4	Application Software Structure and Overview.....	48
4.1	Parameter Groups, Related Content, and Settings	48
5	Configuration Examples	50

5.1	Introduction and Prerequisites.....	50
5.2	Basic Setup of the Converter.....	50
5.3	Setup of Pre-Charge and Main Circuit Breaker Control.....	51
5.4	Setup of DC-link Voltage Control	52
6	Parameter Lists.....	54
6.1	How to Read Parameter Lists	54
6.1.1	Understanding Data Types	54
6.2	Monitoring.....	55
6.2.1	Basic Monitoring.....	55
6.2.2	Control Mode and Reference Monitoring.....	55
6.2.3	Limit Monitoring.....	56
6.2.4	Start and Stop Monitoring.....	56
6.2.5	Control Place Monitoring.....	56
6.2.6	Converter Output Monitoring.....	56
6.2.7	Grid Monitoring.....	56
6.2.8	DC-Link Monitoring	57
6.2.9	Converter Control Monitoring.....	57
6.2.10	Protection Monitoring	57
6.2.11	Power Unit Monitoring.....	57
6.2.12	Cooling Fan Monitoring	58
6.2.13	Fieldbus Process Data Monitoring.....	58
6.2.14	I/O and Relay Status.....	58
6.2.15	Temperature Measurement Status	58
6.2.16	Voltage Measurement Status	58
6.3	Parameters.....	59
6.3.1	Basic Parameters.....	59
6.3.2	Control Mode and References	59
6.3.3	Limits.....	59
6.3.4	Digital and Analog Inputs.....	60
6.3.5	Digital and Analog Outputs.....	60
6.3.6	Start and Stop Settings.....	62
6.3.7	Control Places	63
6.3.8	Converter Control.....	64

6.3.9	Protections and Responses	65
6.4	Maintenance & Service	69
6.4.1	Software Information	69
6.4.2	Events.....	70
6.4.3	Operational Counters.....	70
6.4.4	Backup & Restore	70
6.5	Customization	70
6.5.1	Basic Settings	70
6.5.2	Control Panel.....	70
6.6	Option Board Settings	71
6.6.1	I/O and Relay	71
6.6.2	Temperature Measurement.....	74
6.6.3	Voltage Measurement.....	75
6.7	Connectivity	76
6.7.1	Integrated Communication	76
7	Parameter Descriptions	79
7.1	How to Read Parameter Descriptions.....	79
7.2	G1 Monitoring	79
7.2.1	Basic Monitoring	79
7.2.2	Control Mode and Reference Monitoring.....	87
7.2.3	Limit Monitoring	87
7.2.4	Start and Stop Monitoring.....	87
7.2.5	Control Place Monitoring.....	87
7.2.6	Converter Output Monitoring.....	88
7.2.7	Grid Monitoring.....	88
7.2.8	DC-Link Monitoring	89
7.2.9	Converter Control Monitoring	89
7.2.10	Protection Monitoring	90
7.2.11	Power Unit Monitoring.....	90
7.2.12	Cooling Fan Monitoring	91
7.2.13	Fieldbus Process Data Monitoring.....	91
7.3	G2 Parameters	91
7.3.1	Basic Parameters	91

7.3.2	Control Mode and References	94
7.3.3	Limits.....	95
7.3.4	Digital and Analog Inputs.....	95
7.3.5	Digital and Analog Outputs.....	97
7.3.6	Start and Stop Settings.....	100
7.3.7	Control Places	106
7.3.8	Converter Control.....	114
7.3.9	Protections and Responses	118
7.4	G3 Maintenance & Service	133
7.4.1	Software Information	133
7.4.2	Events.....	134
7.4.3	Operational Counters.....	135
7.4.4	Backup & Restore	136
7.5	G5 Customization.....	136
7.5.1	Basic Settings	136
7.5.2	Control Panel.....	136
7.6	G9 Option Board Settings.....	137
7.6.1	I/O And Relay.....	138
7.6.2	Temperature Measurement.....	145
7.6.3	Voltage Measurement.....	152
7.7	Connectivity	154
7.7.1	Integrated Communication	154
8	Troubleshooting.....	158
8.1	Viewing and Resetting Events	158
8.2	Reading the Event Summary Table.....	158
8.3	Events Summary for Active Front End	159

1 Introduction to App Guide

1.1 Version History

Version	Remarks	Software Version
AB485341347770, version 0101	Updated for General Release 1. Document ID number changed.	Application software version 5.0.0 Firmware version 5.6.3
AB318753809018, version 0201	Migration from Tech Pub Studio to Ixiasoft editor program.	Application software version 2.1.1. Firmware version 3.4.3
AB318753809018, version 0101	Updated for Controlled Release.	Application software version 2.1.1. Firmware version 3.4.3

1.2 Purpose of this Application Guide

This application guide provides information on operating the Active Front End application of the iC7 Series. The application guide provides an overview of parameters and value ranges for operating the power converter. In addition to converter parameters, information on the various user interfaces to configure parameters, configuration examples with recommended parameter settings and troubleshooting steps are included in the application guide.

Intended Audience

The intended audience of the application guide is trained personnel, automation engineers, and configurators with experience in operating with parameters and with basic knowledge of Danfoss AC power converters.

1.3 Additional Resources

Additional resources are available with related information.

The design guide provides information about the capability and functionality to design power converter systems with the iC7 series.

The operating guide provides detailed specification, requirements, and installation instructions of the iC7 series power converters.

Protocol specific fieldbus Operating Guides provide details on how to configure and use a specific fieldbus protocol with iC7 series power converters.

The control panel user guide provides detailed specifications and operations to use the various control panel portfolios of iC7 series.

1.4 Safety Symbols

DANGER

Indicates a hazardous situation which, if not avoided, will result in death or serious injury.

WARNING

Indicates a hazardous situation which, if not avoided, could result in death or serious injury.

CAUTION

Indicates a hazardous situation which, if not avoided, could result in minor or moderate injury.

NOTICE

Indicates information considered important, but not hazard-related (for example, messages relating to property damage).

2 Application Software Overview

2.1 Introduction to the Application Software

The Active Front End (AFE) power converter is used to transfer power between the AC input and the common DC bus. The main functionality of the AFE is to maintain a stable DC-link voltage. Whenever there is load in the DC-link, the AFE rectifies the alternating current and voltage and transfers power from the AC input to the common DC bus. When there is excess energy in the DC-link, the AFE module inverts the direct current and voltage and transfers power from the common DC bus to the AC input. A common application for an AFE is to use it as an AC grid interface for motor drives. With an AFE, the braking power generated by motors can be fed back to the grid.

The AFE can boost the DC-link voltage within the voltage window of the converter hardware. The advantage is that the DC voltage available for motor inverters is not limited even under unideal grid conditions. In addition, the same 480 V AC motors can be used whether the grid voltage is 400 V AC or 480 V AC. The power quality of the AFE is excellent since it does not draw reactive current from the grid. Furthermore, the harmonic distortion is low (<5%) which means that the incoming transformer does not need to be oversized and the unit can meet the most stringent harmonics requirements. The DC-link voltage is also much smoother than with standard diode or thyristor rectifier circuits (NFE). An AFE can also produce reactive current so other low power factor equipment can be compensated.

The AFE needs an external pre-charging circuit. Using parameter settings in the Active Front End application software, the start and stop sequence is automated by controlling the pre-charge circuit and main circuit breaker.

An overview of AFE application software is shown in the following figure.

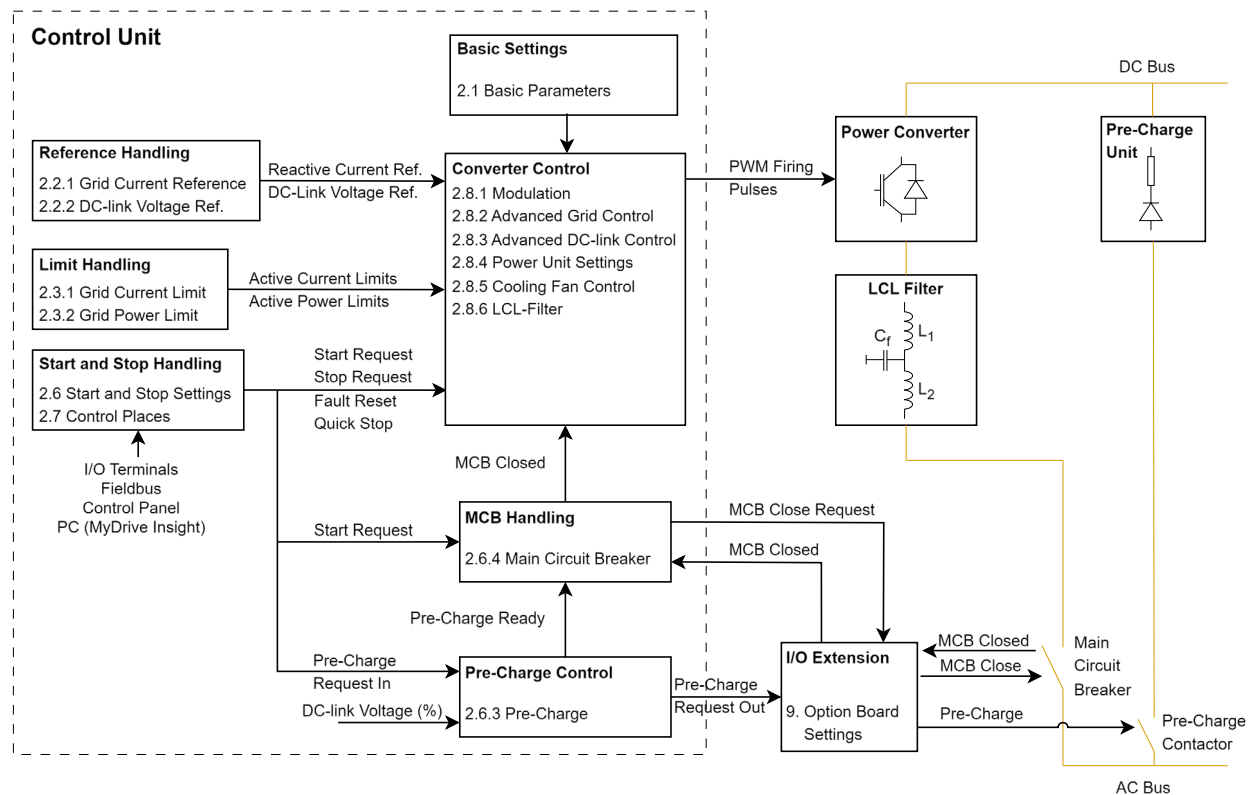

Figure 1: Overview of AFE application software.

The Active Front End has the following elements:

- **Control module:** The Active Front End application software controls the AFE unit functions.
- **Active Front End:** The unit consists of the LCL Filter and the AFE module.
- **Pre-charging circuit:** The Active Front End module requires an external pre-charging circuit. The purpose of the pre-charging unit is to charge the voltage in the DC link to a level sufficient for connecting the Active Front End module to the mains. For information on sizing, refer to the relevant Design Guide.
- **LCL Filter:** The LCL Filter allows the power flow which also reduces the ripple current of the basic frequency, switching frequency, and their harmonics into the mains.
- **Main Circuit Breaker (MCB control):** The AFE application controls the MCB of the system with a relay. When charging of the DC bus is ready, the MCB is closed. MCB feedback is required for the effective functioning of AFE.

For more information on the wiring installations, see system module Operating Guides.

2.1.1 General Features

The application software provides a wide range of built-in features for converter control, security, services, and protections.

DC-Link Voltage Control

Provides users the ability to give a DC-link voltage reference which the converter maintains.

Output Current and Power Limiting Functionality

Provides users the capability to configure the maximum and minimum limits of the grid side active current and power.

Event Handling and Customization

Events indicate undesirable conditions for the converter to operate in. Faults, warnings, and infos are the three types of events.

Faults are critical events which require the operator to take immediate action so that converter is not damaged and converter operations are not stopped.

Warnings are events which indicate that the operator must perform recommended mitigating actions. When warnings occur in the system, the converter continues to operate.

Info events are mainly for notifying the operator of a situation, or to log events into the history. These events do not typically require the operator to take any actions, and they do not stop the operator from operating the converter.

The application software enables the operator to configure conditions and responses to fault and warning events. Configuring events and responses alerts operators so that they can perform necessary actions for the safe operation of the module, converter, and application. Some special activities to handle events include, for example, automatic output deration followed by a fault to stop modulation, and automatic opening of the main circuit breaker after a fault.

Logging and Storage of Data

Both converter and process related signals are logged and stored. The operator can select the process-related signals which are stored. Converter and process data are exported to a format which can be easily understood. The data can be exported from MyDrive® Insight.

The converter records important events which help users understand how the converter or module is used. Apart from standard events logged automatically by the converter, the operator can select events which have to be recorded.

Auto-detection of I/O

The converter has inbuilt terminals and installation space for options. The converter can automatically detect the installed options and connected terminals.

Grid Voltage Measurement Option

AFE can operate without the mains voltage measurement option. The voltage drop across the line filter can be compensated for by configuring the filter parameters in sensorless mode. Extended features are available when the two-channel AC mains Voltage Measurement Option OC7V0 is used. AFE can use the line voltage measurement option for the following operations:

- Line filter energization:
 - AFE can charge the filter capacitors and synchronize to the voltage measured from the other side of the main circuit breaker. This way the inrush currents and voltage transients typically occurring after the breaker closes are effectively avoided.
- Grid voltage dips:
 - The line voltage measurement option helps AFE to handle grid voltage dips without tripping.
- Monitoring of the grid voltage and frequency.

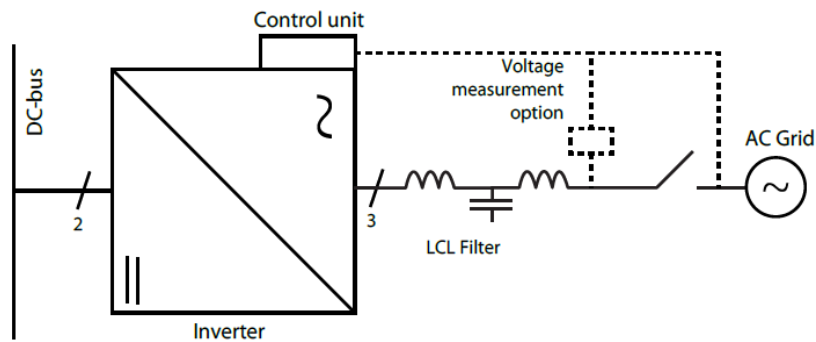

Figure 2: AFE with filter voltage feedback and grid voltage feedback measured by the Voltage Measurement Option OC7V0.

Paralleling AFEs

Paralleling refers to a system in which multiple AFEs (equipped with their own control units) are connected to the same DC bus and the same AC bus. Several power units can operate under one control unit using a star coupler board, and this configuration is considered a single AFE from the system level point of view. Paralleling does not require any communication between the AFEs, but software features like DC voltage drooping and paralleling synchronization mode must be used to guarantee smooth operation of the AFE. A typical paralleling configuration is illustrated in the following figure.

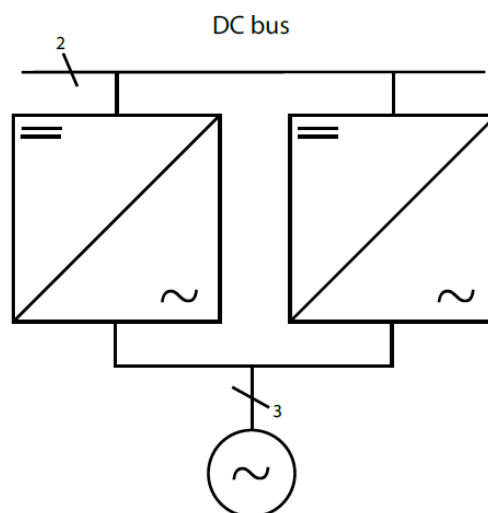

Figure 3: Paralleled AFEs with a common DC bus and a common AC bus.

Paralleling synchronization mode activates a controller for parallel-connected converters to reduce circulating common mode current when the converters are not galvanically isolated. Paralleling synchronization mode can be activated by parameter No. 9654

DC voltage drooping is used to balance the active current (power) drawn from the grid between multiple converters that are controlling the same DC-link voltage. DC-link voltage references are modified according to the following figure as function of active current (power). For example, if one drive is drawing more power from the grid to DC link than the others, its DC-link voltage reference is reduced most, which reduces its power in relation to other converters through the DC-link voltage controller. The DC voltage drooping can be configured with parameters No. 2912 and 5095.

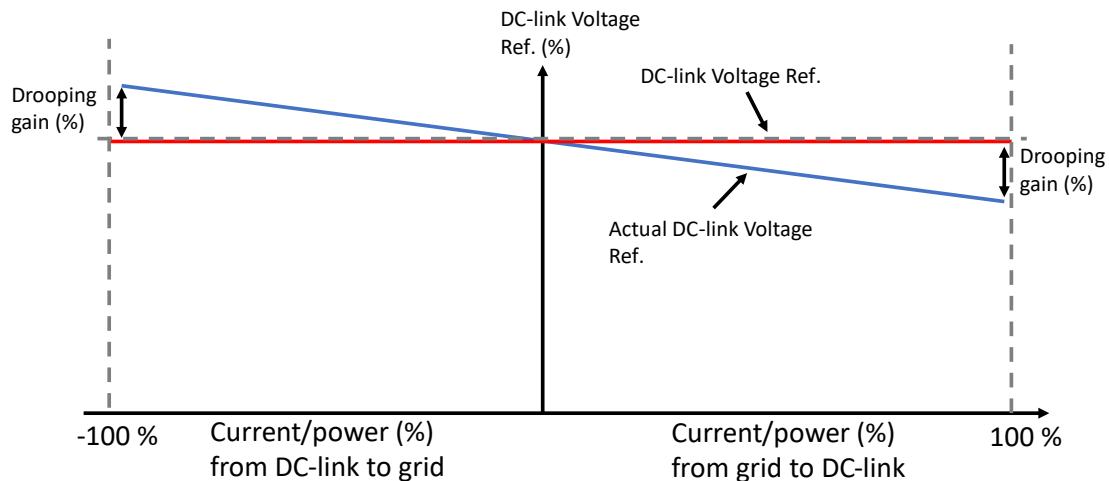

Figure 4: Operation principle of DC voltage drooping.

2.1.2 Protection Features

The Active Front End application software includes multiple protection features. The following is a short summary of the most relevant protections.

DC-link Overvoltage Protection

The converter stops modulation when the overvoltage trip level is reached. This protection also opens the main circuit breaker and brings the DC-link voltage down. The trip level depends on the power unit hardware, and the default response for this protection is a fault. The trip level or the response cannot be changed.

Overtemperature Protection

The converter stops modulation when the overtemperature trip level for the converter heat sink is reached. This protection also opens the main circuit breaker and brings the DC-link voltage down. The trip level depends on the power unit hardware, and the default response for this protection is a fault. The trip level or the response cannot be changed.

Overcurrent Protection

The converter stops modulation when the overcurrent trip level is reached. This protection also opens the main circuit breaker and brings the DC-link voltage down. The trip level depends on the power unit hardware, and the default response for this protection is a fault. The trip level or the response cannot be changed.

Cooling Supervision

Cooling supervision is only available for liquid-cooled AFE units.

Protects of the AFE converter and LCL Filter by monitoring the status of the cooling module through digital inputs.

Cooling supervision can be configured with the digital input No. 2400 Cooling Monitor Input. The response can be configured either as a warning or a fault, or both. Different responses can be configured based on the run/stop state of the converter using No. 2402 Cooling Monitor Response. A delay in seconds can be added for the triggering of the protection using No. 2401 Cooling Monitor Fault Delay.

Filter Temperature Protection

LCL Filter temperatures are monitored using AuxBus nodes and the converter can issue a warning or fault based on the filter temperature measurements. The operator cannot configure this protection.

Missing Phase

The converter stops modulation when it detects one or more of the grid phases is missing.

Quick Stop

Quick Stop stops the converter regardless of the operation condition. Quick Stop allows the converter to make a controlled stop, for example, when the emergency stop is pressed. Usually there are a few seconds to make a controlled stop before the emergency stop forces all breakers to open and makes the system electrically safe. In a Quick Stop, the modulation is stopped immediately and the main circuit breaker is opened.

The Quick Stop function can be initiated from the fieldbus or using digital inputs.

2.2 Start and Stop Sequence

The power-up sequence of the converter system can be configured. The start sequence, and parameters No. 6566 Pre-Charge Ready Level and No. 6559 MCB Closing Mode, affect the startup behavior. The Main Circuit Breaker closing mode can be configured to be one of the following:

- DC-Link Pre-Charge Ready (this is the default selection)
- Start Command
- DC-Link Pre-Charge Ready or Start Command
- LCL Filter Energized

The DC link pre-charging can be started based on a start command or a dedicated digital input. The start- and stop sequence, charging, and the main circuit breaker can be controlled via the fieldbus or the I/O interface.

2.2.1 Starting when DC-Link Pre-Charge Ready is the MCB Closing Mode

In a typical startup sequence, the unit is responsible for controlling the DC-link pre-charging and connecting to the AC grid using the Main Circuit Breaker (MCB) with default settings. The following start and stop sequence illustrations provide an overview on the process conditions and stages.

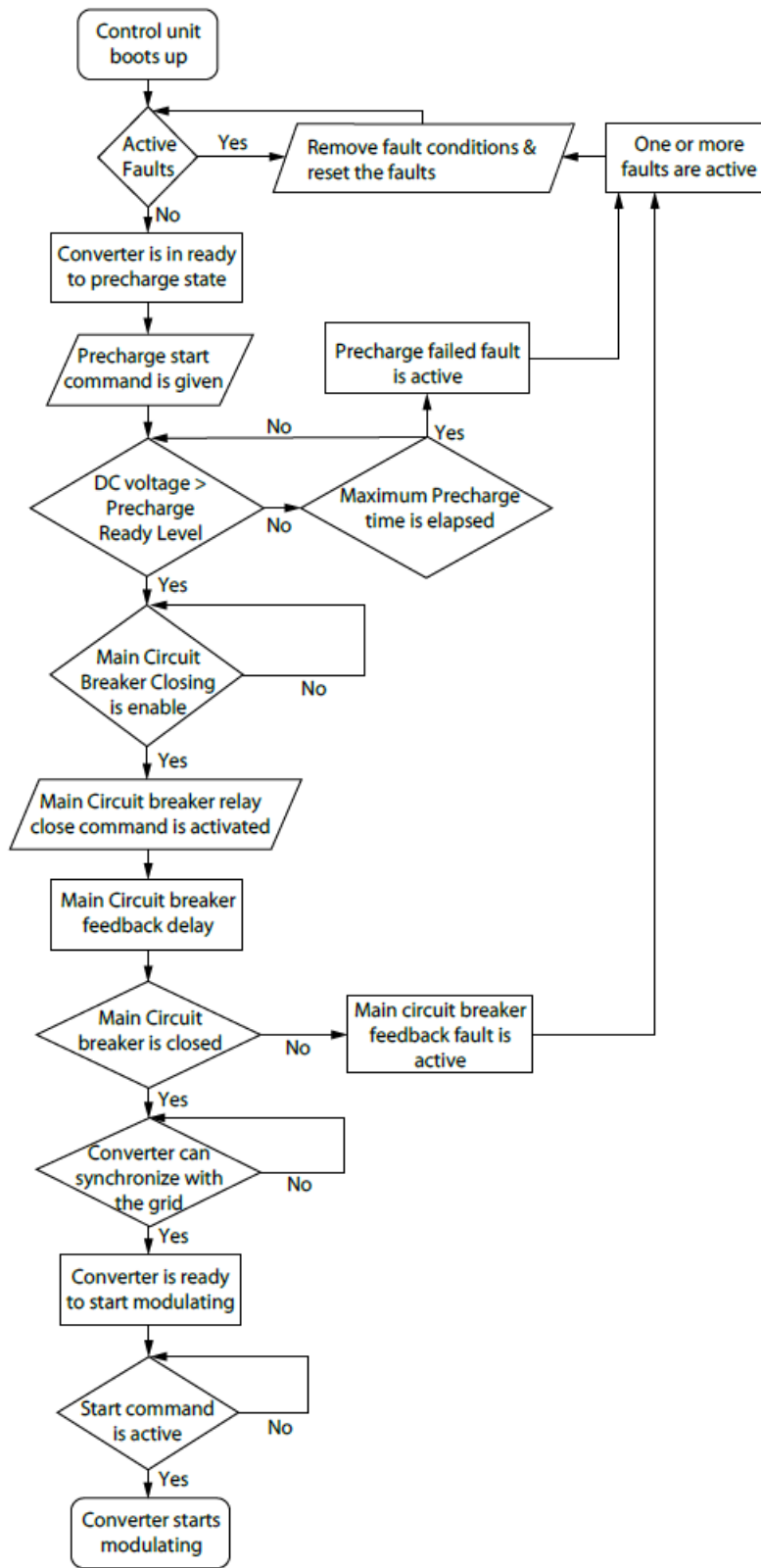

Figure 5: Start sequence flow chart.

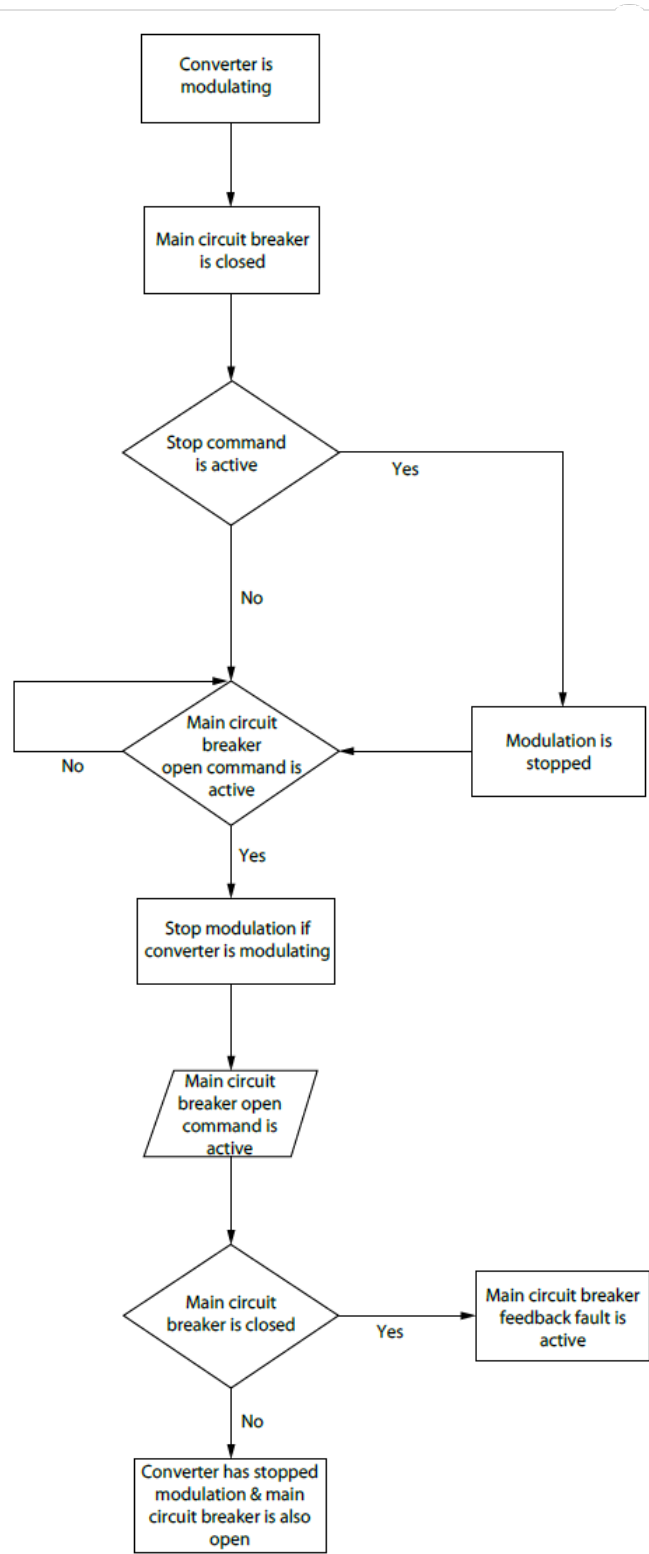

Figure 6: Stop sequence flow chart.

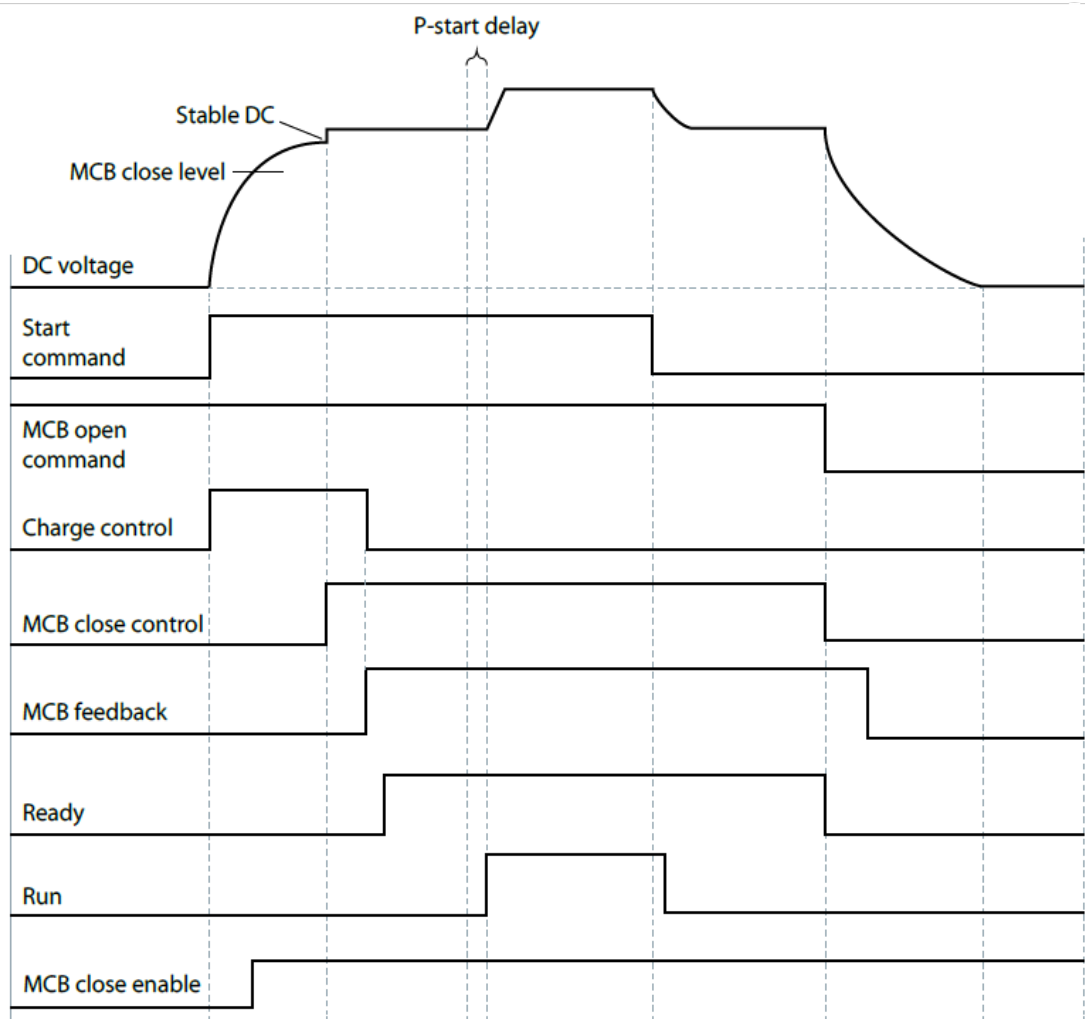

Figure 7: Pre-charge and main circuit breaker operation.

2.2.2 Starting when Filter Energization Ready is the MCB Closing Mode

In this mode, the DC link is charged first, and the converter is allowed to run to pre-energize and synchronize the voltage of the LCL filter before the command to close the main circuit breaker is issued. An external voltage measurement board is required for this mode. The voltage measurement board must be connected behind the main circuit breaker. A typical startup sequence, when the unit is responsible for controlling the DC-link pre-charging and connecting to the AC grid after the filter is energized, is illustrated in the following Figure.

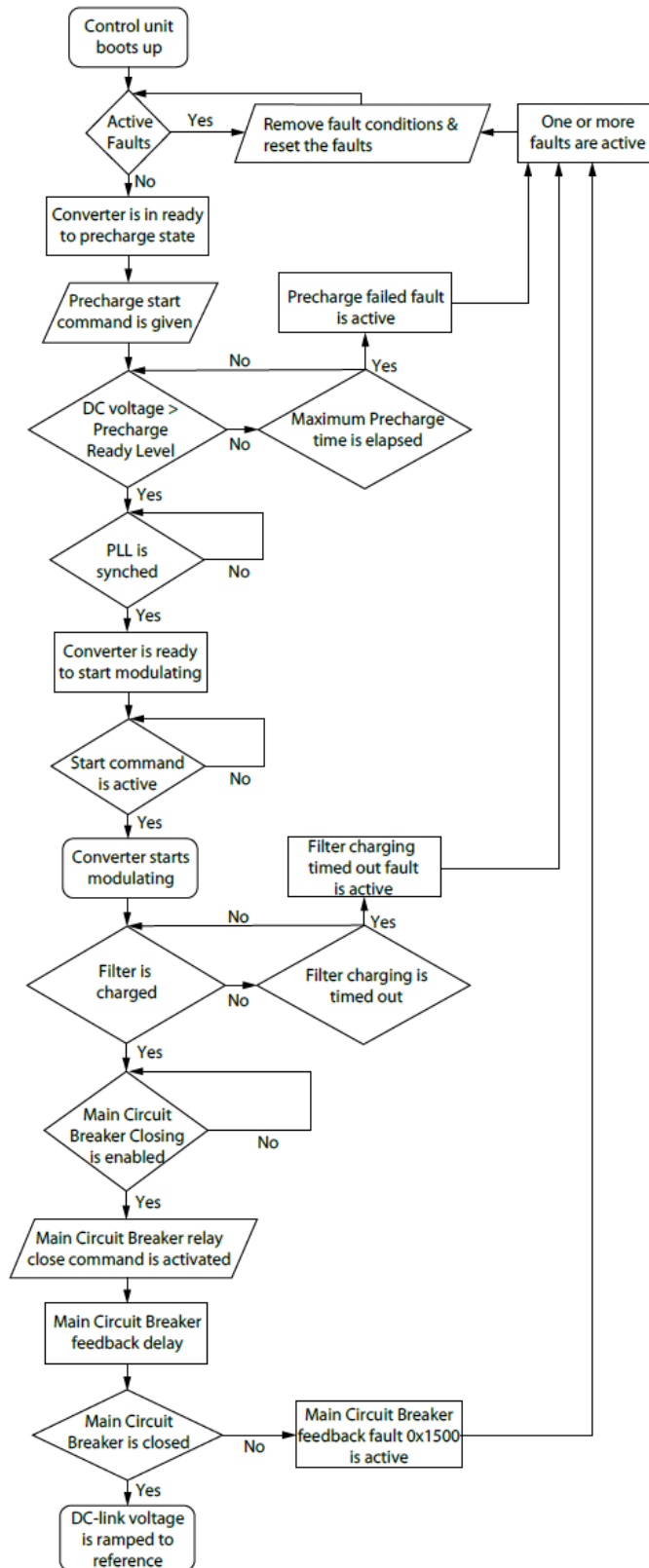

Figure 8: Start sequence when LCL Filter Energized is the MCB Closing Mode.

This mode reduces the inrush current from the grid when the main circuit breaker is closed. Before the main circuit breaker is closed, the filter voltage is ramped up to the measured grid voltage during the time defined by parameter No. 5161. If filter energization takes more than the time defined by parameter No. 5162, the filter energization fails and causes a fault. DC-link pre-charge has a minimum pre-charge time, which can be set using parameter No. 6565. The minimum pre-charge time must be configured according to the dimensioning of the pre-charge circuit.

2.3 Fieldbus Profile Description

The iC7 Series products provide a flexible fieldbus profile which can be mapped according to customer needs. The standard bit configuration is described in this chapter.

The following figures present standard procedures which are only applicable when control is through fieldbus, when bit 10 is true, and fieldbus control place is the active control place. The white boxes show the control word bits which are required to transition between different states. The gray boxes show different states of the fieldbus profile, indicating the value of status word bits, which must be in the state shown.

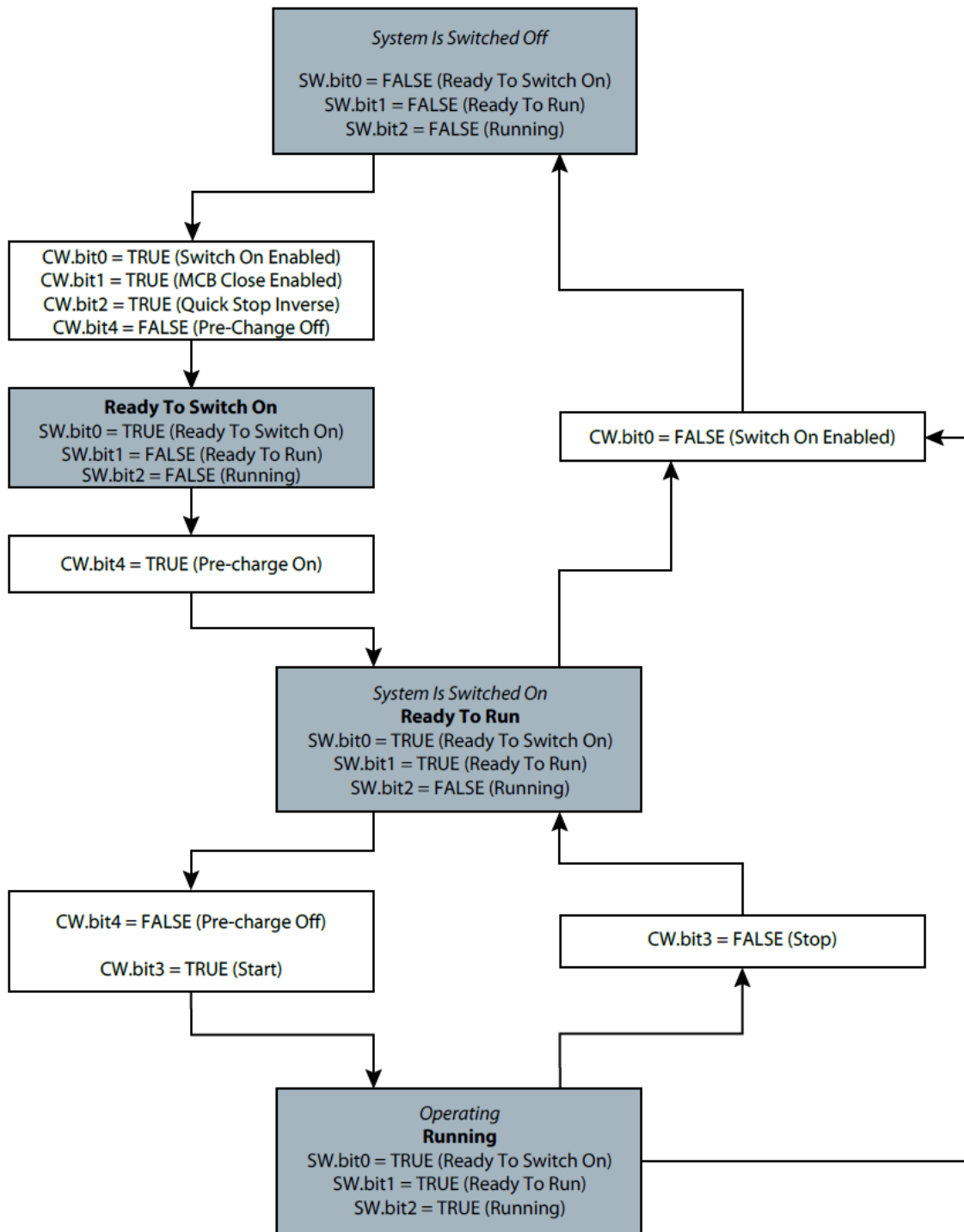

Figure 9: Start- and stop sequence flow chart when using separate commands for pre-charge (CW.bit4) and start (CW.bit3).

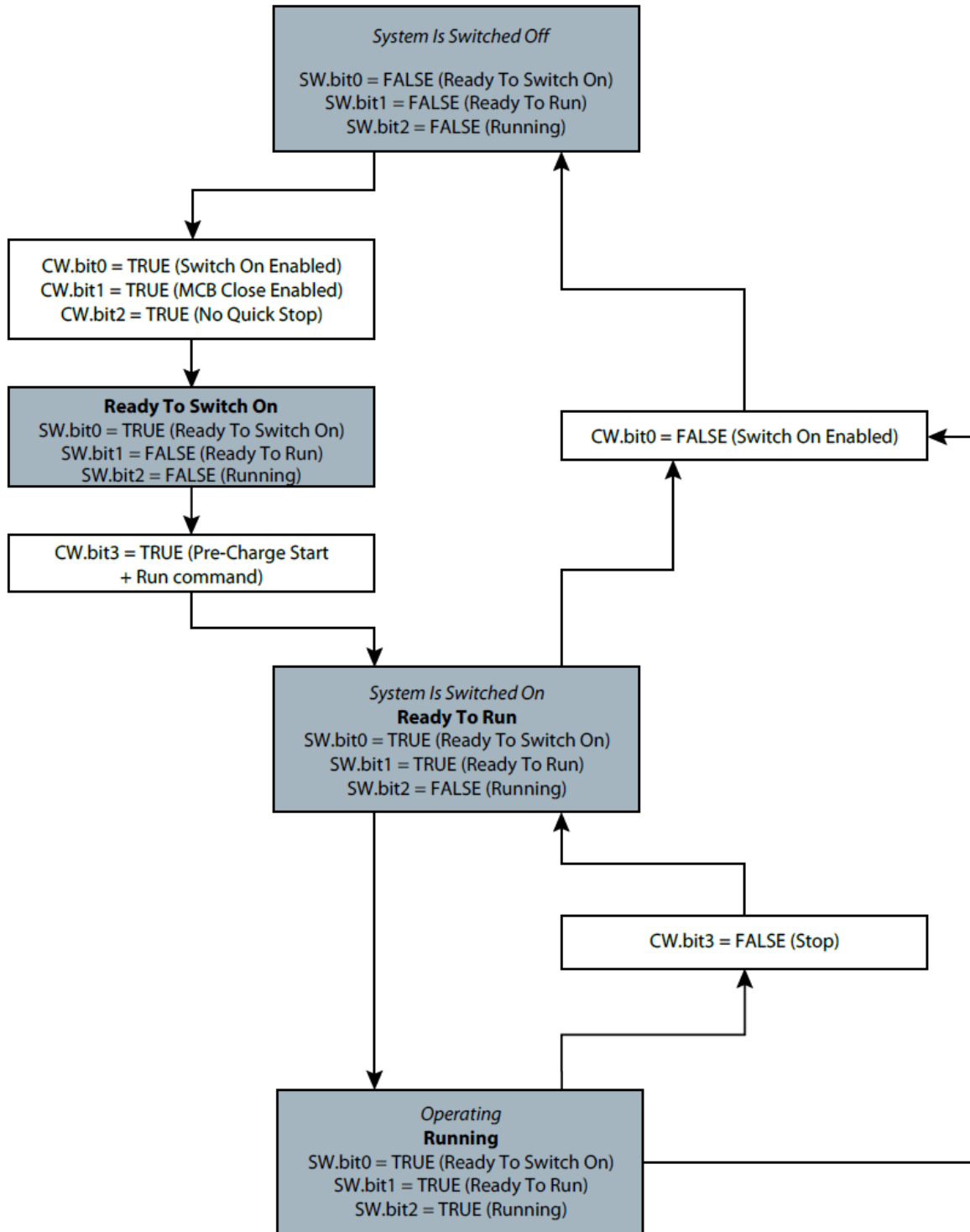

Figure 10: Start- and stop sequence flow chart when start bit (CW.bit3) is used both for pre-charge and start commands.

State	Description
System is switched off	Prohibits the converter from starting.
Ready to switch on	The converter is ready to start charging, with no active faults and no active conditions to inhibit switching on.
System is switched on	The converter is pre-charged and on.
Operating	The converter is running.

2.3.1 Fieldbus Control Word and Bit Description

Bit	Name	Description	Further Information
0	Switch On Enabled	0: DC-link pre-charge, MCB closure, and running are prevented/interrupted, MCB is opened if closed. 1: DC-link pre-charge, MCB closure, and running are not prevented/interrupted, MCB is not opened if closed.	The behavior of this bit is similar to digital input (No. 4728).
1	MCB Close Enabled	0: If pre-charge is completed, the MCB is not allowed to close. Running is also prevented or interrupted. MCB is opened if closed. 1: If pre-charge is completed, the MCB is allowed to close.	
2	Quick Stop Inverse	0: Initiate Quick Stop. 1: Do not initiate Quick Stop.	
3	Start	0: Stop the unit if it is running, or stop the pre-charging sequence if it is not completed. 1: Start running if already pre-charged. Otherwise initiate pre-charging and then start running.	Use the fieldbus start mode (parameter No. 5114) to configure whether a new start command is required after the unit has been stopped or to start running immediately after all stopping conditions (quick stop, faults, and so on) are cleared.
4	Pre-charge	0: Stop the DC-link pre-charge, if ongoing. 1: Start/continue the DC-link pre-charge.	This bit has an effect only if DC-link pre-charging is not externally controlled.
5-6	-	Reserved	
7	Event Reset	0: Do not reset events 1: Reset active events	A rising edge (a transition from false to true) on this bit issues an event reset request.
8-9	-	Reserved	
10	Data Valid	0: Ignore the current incoming process data values, instead use the last processed value when the 'Data Valid' bit was true. 1: Use the current incoming process data values.	For Modbus® TCP protocol, the validity check applies for all the registers that are sent in the same message as the control word.
11	Watchdog	Incoming watchdog bit from customer. Use for monitoring the fieldbus connection.	
12	Vendor Specific Bit 1	Select the value "Control word 1 - bit 12" for any Input parameter to utilize this signal for the activation of a desired function.	

Bit	Name	Description	Further Information
13	Vendor Specific Bit 2	Select the value "Control word 1 - bit 13" for any Input parameter to utilize this signal for the activation of a desired function.	
14	Vendor Specific Bit 3	Select the value "Control word 1 - bit 14" for any Input parameter to utilize this signal for the activation of a desired function.	
15	Vendor Specific Bit 4	Select the value "Control word 1 - bit 15" for any Input parameter to utilize this signal for the activation of a desired function.	

2.3.2 Fieldbus Status Word and Bit Description

Bit	Name	Description	Further Information
0	Ready to Switch On	0: Unit is not ready to run 1: Unit is ready to run	This bit indicates that the unit is ready to start the startup sequence (pre-charging and/or MCB closure, if controlled by the application). There are no active faults and the Switch On Enabled bit is active.
1	Ready to Run	0: Unit is not ready to run 1: Unit is ready to run	When this bit is true, it indicates that the unit can be successfully started with bit 3 of the control word.
2	Running	0: Unit is not running (modulating) 1: Unit is running (modulating)	This bit indicates whether the unit is in running state (modulating).
3	Fault	0: No active faults 1: One or more faults are active	This bit indicates the presence of one or more active fault level events.
4	-	Reserved	
5	Quick Stop Inverse	0: Quick stop is active 1: Quick Stop is not active	This bit indicates whether the quick stop command is active or not
6	-	Reserved	
7	Warning	0: No active warnings 1: One or more warnings are active	This bit indicates the presence of one or more active warning level events.
8	-	Reserved	
9	Controlled by PLC	0: Fieldbus is not the active control place 1: Fieldbus is the active control place	This bit indicates whether the unit is controlled from fieldbus or not.
10	-	Reserved	
11	Run Enabled	0: Run enable signal from dedicated input is missing 1: Run enable signal from dedicated input is present	This bit indicates the state of the Run Enable Input (parameter No. 103)
12-14	-	Reserved	
15	Watchdog	Bit used for the fieldbus watchdog.	Mirroring control word bit 11

3 User Interfaces and How to Configure

3.1 Overview of User Interfaces

To interact with a Danfoss iC7 Series converter, use either the control panel as a simple and direct interface, or the software tool MyDrive® Insight for more advanced interaction with the converter. The control panel can be mounted directly on the converter, or close to the converter by using a control panel mounting kit.

With MyDrive® Insight the converter can be accessed from a remote place if the infrastructure is in place and the network provides the required access rights.

3.2 Control Panel

The chapter provides an overview about the different control panel options, the related elements, important features and functionalities, and quick guidance on how to use the control panel.

3.2.1 iC7 Control Panel Options

The iC7 series offers a broad range of interfaces which suit different connectivity requirements to support wireless regulations.

The iC7 Series offers the following 2 different control panel options. Refer to the relevant Design Guide for information on which control panels are available to your product.

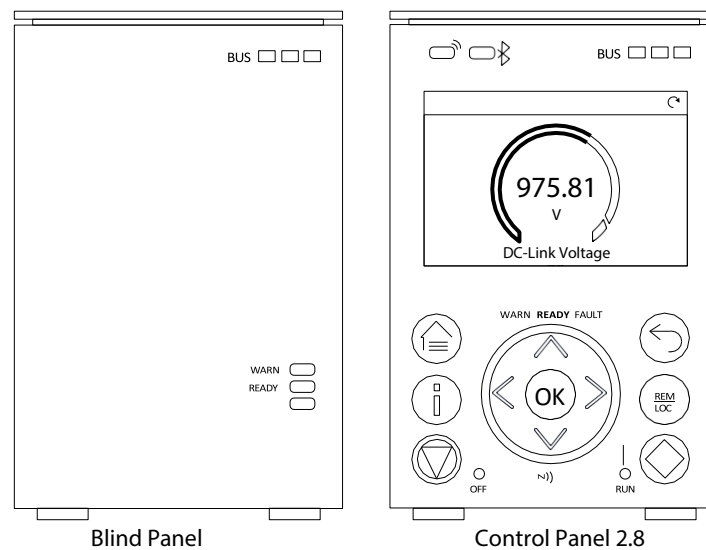

Figure 11: Control Panel options.

- **Blind Panel OPX00:** This panel shows the basic status of the converter and fieldbus indicators. The panel is typically used when only limited interaction with the converter is required after installation and commissioning, or when the converters are controlled by fieldbus.
- **Control Panel 2.8 OPX20:** This panel is the standard user interface, and used when frequent interaction with the converter is required. The panel enables easy setup of the converter via parameters, monitoring the converter status, and shows event notifications.

Control Panel 2.8 0PX20 has the following features:

- 2.8" monochromatic user interface with a display resolution of 240 x 160 pixels.
- Visual LEDs to illustrate converter status and fieldbus communication.
- Halo indicator with 3 colors to illustrate converter status at a glance.
- A display which can be customized to show required or essential information.
- Buttons to control the converter locally, including a toggle button to easily switch between local and remote control.
- Parameter widgets which support alphanumeric and special characters, integers, floating points, date time formats, choice lists, and commands to configure application data.
- Help texts to support operation.

3.2.2 Control Panel Elements

The control panel provides an interface for configuring and controlling the converter easily. The section describes the elements for all control panel options.

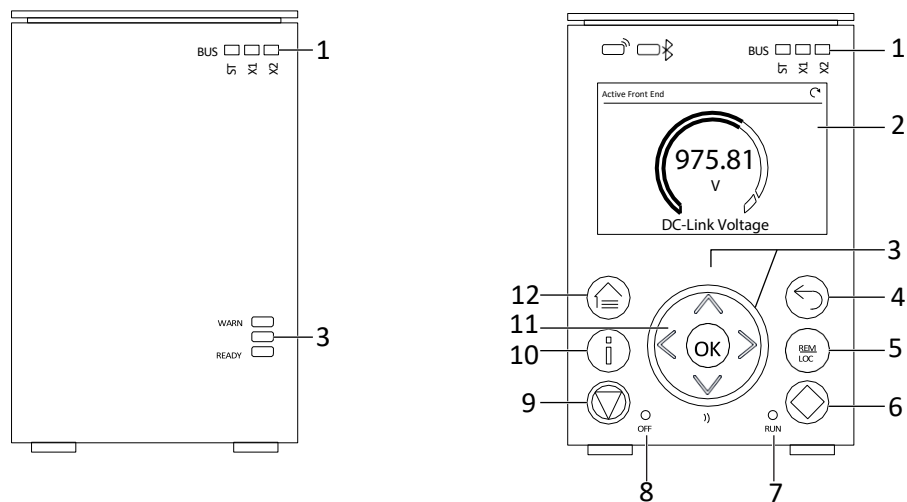

Figure 12: Control Panel elements.

Legend	Name of Element	Description
1	Fieldbus Indicators	<p>The LEDs indicate the status of the communication interface X1 and X2.</p> <ul style="list-style-type: none"> • [ST] <ul style="list-style-type: none"> ○ Green blinking LED indicates that the communication interfaces are in normal operating state. ○ Red blinking LED indicates that an error has occurred, and communication is not possible. • [X1] <ul style="list-style-type: none"> ○ Green blinking LED indicates data exchange on communication interface X1. ○ Red blinking LED indicates an error during data exchange on communication interface X1. • [X2] <ul style="list-style-type: none"> ○ Green blinking LED indicates data exchange on communication interface X2. ○ Red blinking LED indicates an error during data exchange on communication interface X2.
2	Display	Enables access to content and settings. The display provides detailed information about the status of the converter.
3	Converter Status Indicators	<p>The LEDs indicate the status of the converter.</p> <ul style="list-style-type: none"> • [WARN] <ul style="list-style-type: none"> ○ When this text is lit in yellow, it indicates a warning-level event. • [READY] <ul style="list-style-type: none"> ○ When this text is lit in white, it indicates that the converter is ready for operation. ○ When this text is blinking white (1 Hz), it indicates that the converter is powered on but is not ready. • [FAULT] <ul style="list-style-type: none"> ○ When this text is lit in red, it indicates a fault. <p>The status of the converter is also indicated by the Halo, which has the same color indicators as the converter status texts on the control panel.</p>
4	Back button	Navigates to the previously viewed screen or a menu level above the current menu.
5	REM/LOC	Toggles the converter between remote and local operation.
6	Run button	Starts the operation of the converter.
7	RUN LED	<p>The indicator has the following states:</p> <ul style="list-style-type: none"> • On: Start command is applied and the converter is modulating. • Off: The converter has stopped, and the start command is not applied.

Legend	Name of Element	Description
8	OFF LED	<p>The indicator has the following states:</p> <ul style="list-style-type: none"> • Steadily on: The indicator is in this state because of either of the following two reasons: <ul style="list-style-type: none"> ○ The converter is not modulating and is coasted. ○ The stop signal is applied, output is active, and the converter is ramping down until coast or restart. Ramp times, protections, and stopping functions prolong this state. • Flashes for 3 seconds: Indicates that the start command is initiated, but the converter is not able to start. • Off: The converter is in operation, a start signal is applied, and the output is active. This also includes ramping, running on reference, and AMA. <p>Note: When a fault has occurred in the converter, the LED is on though the start command is available. If there is a fault event, and the start command is disabled and reinitiated again, the Off LED blinks.</p>
10	Info button	Provides more detailed information about an event that has occurred in the converter. Pressing Info also shows a context sensitive help for parameters.
11	Arrow buttons	<ul style="list-style-type: none"> • Arrow buttons: Used to navigate within the different screens and menus. • [OK]: Primarily used to confirm selections and data in the control panel display.
12	Home/Menu button	Toggles between Home screen and the current parameter menu, to allow quick access to key status information during parameter setup.

3.2.3 Control Panel Basic Configurations

The basic configurations of the control panel include:

- A readout of the status of the motor and the converter, including warnings and faults.
- Navigable menus, where the parameter settings of the converter can be viewed and changed.

3.2.3.1 Starting the Converter and Control Panel Display

While the converter is powering up until it is ready to operate, the control panel display shows the following:

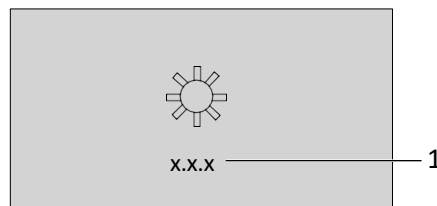

Figure 13: Control Panel display on startup.

Legend	Description
1	The panel software version

NOTICE

When the converter is started, it takes 25–30 s for the converter to be in ready state and for the control panel display to change to the Home screen (default).

3.2.3.2 Understanding Readout Screens

When the converter is in ready state, the control panel display shows the Home screen. By default, the Home screen is shown as follows, however the Home screen can be customized.

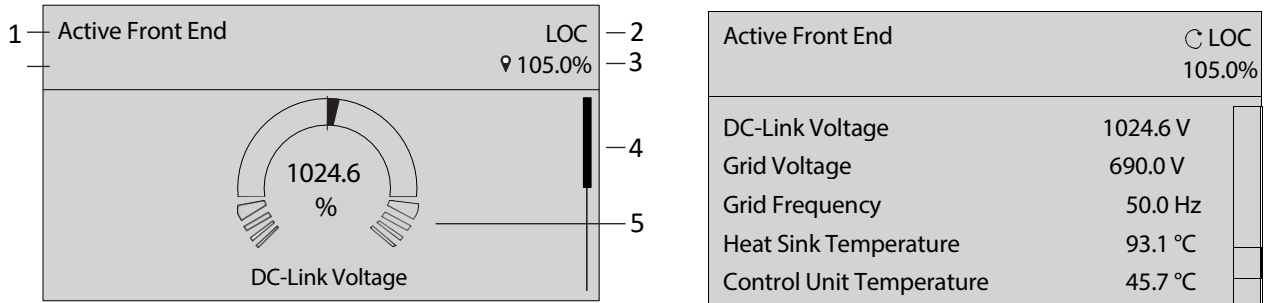

Figure 14: Home screen (Donut View vs. Line view)

Legend	Description
1	The name of the application software
2	The current control place of the converter. REM indicates remote control and LOC indicates local control. The visible arrow indicates that the converter is in running state.
3	The DC-voltage reference. The local reference can only be changed when the converter is in local control.
4	The scroll bar. The scroll bar indicates whether the screen is in the upper Readout Screen 1 or lower Readout Screen 2 position, when in the menu structure or parameters
5	The readout value as a donut infographic view. It is possible to show only a single readout in a donut view. When more than 1 readout is configured, the screen changes to a line view. A minimum of 2 and a maximum of 5 readouts are shown in the line view.

Press the down arrow on the control panel when in Readout Screen 1, and the control panel screen navigates to Readout Screen 2. As a factory default setting, the control panel shows 5 readout values, as shown in the preceding image.

3.2.3.3 Changing the Content of the Readout Screens

This chapter outlines an example procedure for changing or customizing the content of Readout Screen 1. The same procedure is applicable for Readout Screen 2.

1. To start the screen content editing mode, press [OK] for a minimum of 5 seconds. The screen changes as shown in the following image.

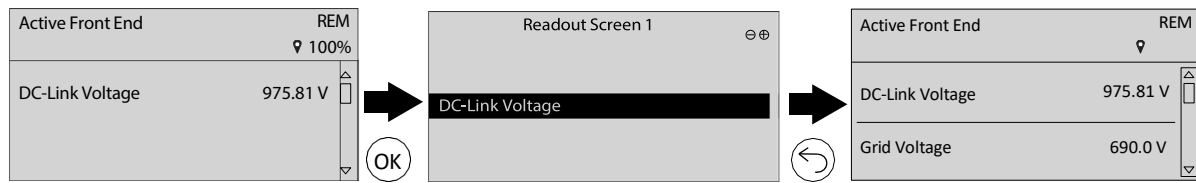

Figure 15: Typical Readout Screen

- Remove an existing readout by pressing the up-arrow button on the control panel and navigating to the Remove readout button (-) on the UI and pressing it.

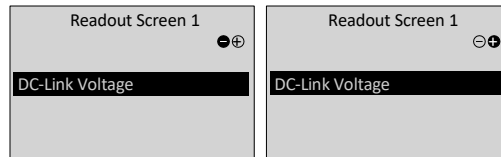

Figure 16: Add and remove readout buttons

NOTICE

When the remove readout button is pressed, the last readout on the list is removed.

- Add a readout to the screen by navigating to the Add readout button (+) on the UI and pressing it. To move between the Add readout and Remove readout buttons, press the left or right arrow buttons on the control panel.
- After pressing the Add readout button, select the readout to be added.

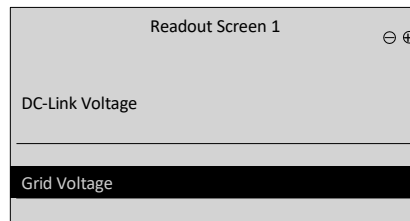

Figure 17: Updating the readout screen

- Add more readouts by pressing the Add readout button and selecting a readout.
- After selecting the readouts to be added or removed from the list, press [OK].
- To exit the screen content editing mode, press the [Home] or [Back] button.

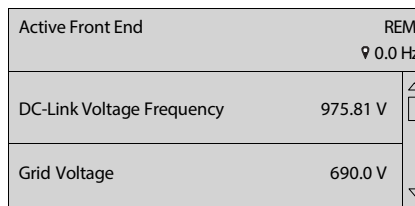

Figure 18: Updated readout screen

NOTICE

The readout screens can also be adjusted using parameter group 5.2 Control Panel. For more information, see Customization (Menu Index 5).

3.2.3.4 Adjusting Display Backlight and Contrast

When in Readout Screen 1 or Readout Screen 2, it is possible to adjust the backlight intensity and contrast of the display.

To adjust the display backlight and contrast settings, press the [Info] button and any of the arrow buttons of the control panel. The settings are shown on the screen:

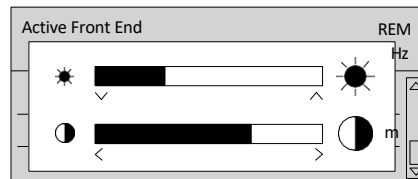

Figure 19: Intensity change of backlight and contrast

- To change the intensity of the backlight, keep pressing the [Info] button along with either the up or down arrow buttons of the control panel.
- To change the contrast, keep pressing the [Info] button along with either the left or right arrow buttons of the control panel.

3.2.3.5 Parameter Group Screen and Overall Navigation

Pressing the [Home/Menu] button toggles between the readout screens and the parameter group screen. The content of the parameter group screen can vary depending on the current level of the parameter group. A typical parameter group screen is shown in the following image.

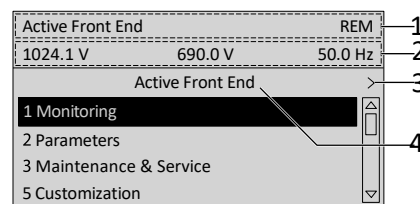

Figure 20: Parameter group screen

Legend	Description
1	Name and control state of the converter.
2	The menu readout header. It shows the DC-link Voltage, Grid Voltage and Grid Frequency (left-to-right)
3	Previous and Next arrow icons. Press the icons to navigate 1 level above or below in the parameter group structure. When the Previous or Next arrow is not shown, it indicates that the view is at the top or bottom of the menu structure, respectively.
4	Name of the application software that is active in the converter.

Basic navigation techniques

To navigate through and within the different parameter groups, use the navigation buttons of the control panel.

- To navigate to different parameter groups, press the up or down arrows of the control panel.

- To navigate to parameter subgroups or parameters within a parameter group, press the left or right arrows of the control panel.
- To navigate to a higher level in the parameter/parameter group screens press the Back button, and to navigate to a lower level press the OK button.

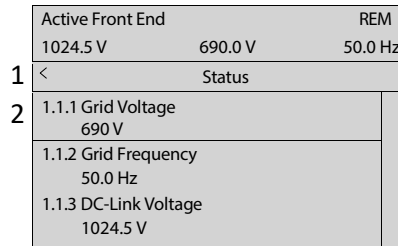

Figure 21: Parameter navigation

Legend	Description
1	Previous button when in a parameter group.
2	When parameters are defined as readout only, the current value is shown below the parameter name. A black outline around the parameter without any highlighting indicates that the value of the parameter cannot be changed.

3.2.3.6 Changing the Selections of a Parameter

When a parameter has selections, the parameter index and name are highlighted in black. The example parameter in this procedure is **P2.1.6 Unit Voltage Class**.

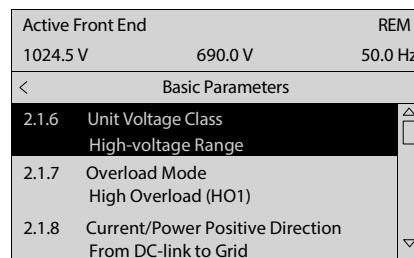

Figure 22: Changing selection in a Parameter

1. To view the selections of the parameter, press the right arrow button or [OK] on the control panel. The selections available for the parameter are shown on the screen.

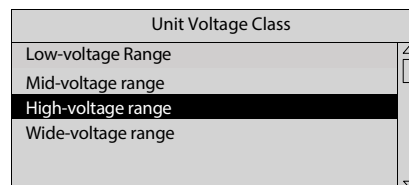

Figure 23: Choice selection for a Parameter

2. To browse through the selections, press the up or down arrow buttons.
3. To select a selection, press [OK].

3.2.3.7 Changing a Parameter Value

The example parameter in this procedure is **P2.1.1 Grid Nominal Frequency**.

1. Go to parameter **P2.1.1 Grid Nominal Frequency** and press [OK].
2. To go to the values before or after the decimals, use the left and right arrow buttons. A black highlight on the digit indicates the location where the cursor is active.
3. To increase or decrease the value, press the up and down arrow buttons.
4. Confirm the changes by pressing [OK].

The following illustration shows the process of changing the value of a parameter.

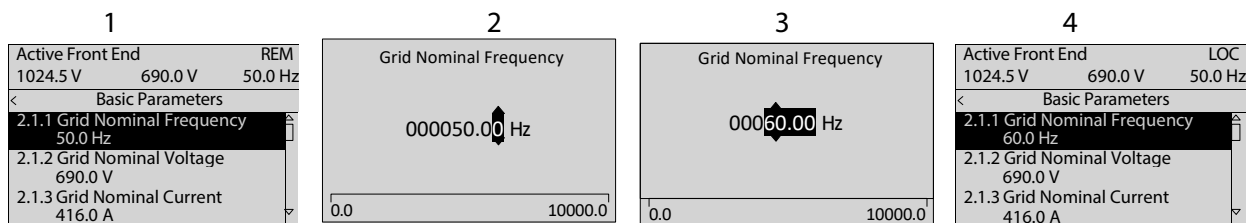

Figure 24: Changing value in a parameter

3.2.3.8 Locking the Control Panel Display

To avoid unintended interaction via the control panel, the control panel display can be locked.

To lock the control panel, press the [Back] button for 3 s. After 3 s, the following screen is shown.

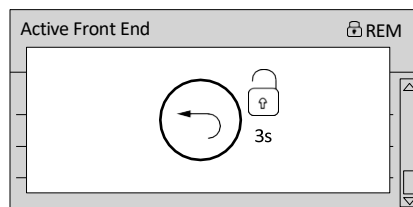

Figure 25: Control Panel lock screen

When the control panel is locked, pressing the control panel buttons has no effect.

To unlock the control panel, press the [Back] button for 3 s.

3.2.4 Control Panel Shortcuts

The following table lists shortcuts in navigating in the control panel.

Action	Precondition	Buttons	Activation Time
Fast scroll	When in a menu or list of choices	Up and down arrows	1 s to activate
Factory reset		Home + Back + down arrow	3 s to activate
Keypad lock		Back	3 s to activate or deactivate
Accessing DC-Link Voltage Reference editor	Local Control Active Home screen active	[OK]	<1 s to activate

Action	Precondition	Buttons	Activation Time
Editing Home screen readouts	Home screen active	[OK]	5 s to activate
Editing the Menu Readout header	Any menu is active	[OK]	5 s to activate
Show active events	Home screen is active	Info	Single press
Adjusting screen contrast and brightness	Home screen is active	Info + arrows	Continuous simultaneous press

3.3 MyDrive® Insight

MyDrive® Insight is a platform-independent software tool that supports the commissioning, engineering, and monitoring of the iC7 series. Some of the key features include:

- Fast and easy configuration and commissioning.
- Monitor the converters as part of daily operations or any others.
- Collect data and information for troubleshooting, maintenance, and service.
- Discovery and access to multiple converters in a network.
- Intuitive user interface.
- Notifications and visualizations on real-time information and events about the converter.
- PC control to perform operations such as starting or stopping the converter, set references, set direction, reset, and coast of the converter.
- Perform updates on single or multiple converters.
- Backup and restore of parameter settings.
- Data logging and analyzing for troubleshooting.

NOTICE

The section is documented for MyDrive® Insight version 2.8.0 or above. Make sure to uninstall lower versions of MyDrive® Insight from the workstation to utilize the latest MyDrive® Insight functions.

NOTICE

The section MyDrive® Insight in the application guide covers basic information such as getting started with MyDrive® Insight, accessing and viewing or changing the parameters, and PC control to operate the converter using MyDrive® Insight. For further information on the different MyDrive® screens, integrated help within MyDrive® Insight will be available in future releases.

NOTICE

The following figures and examples are from the iC7 Automation product. Thus, there are mentions of “iC7 Industry” and parameter and index references that do not apply in this application. However, all the principles do apply.

3.3.1 Getting Started with MyDrive® Insight

As a prerequisite, ensure that MyDrive® Insight is installed on the device (PC or laptop). MyDrive® Insight can be downloaded and installed from MyDrive® Suite, available here:

<https://suite.mydrive.danfoss.com/>.

Procedure:

1. To establish a point-to-point connection between the converter and the device, use the communication interface X0 and the RJ45 Ethernet port on the device by using a standard Ethernet cable.

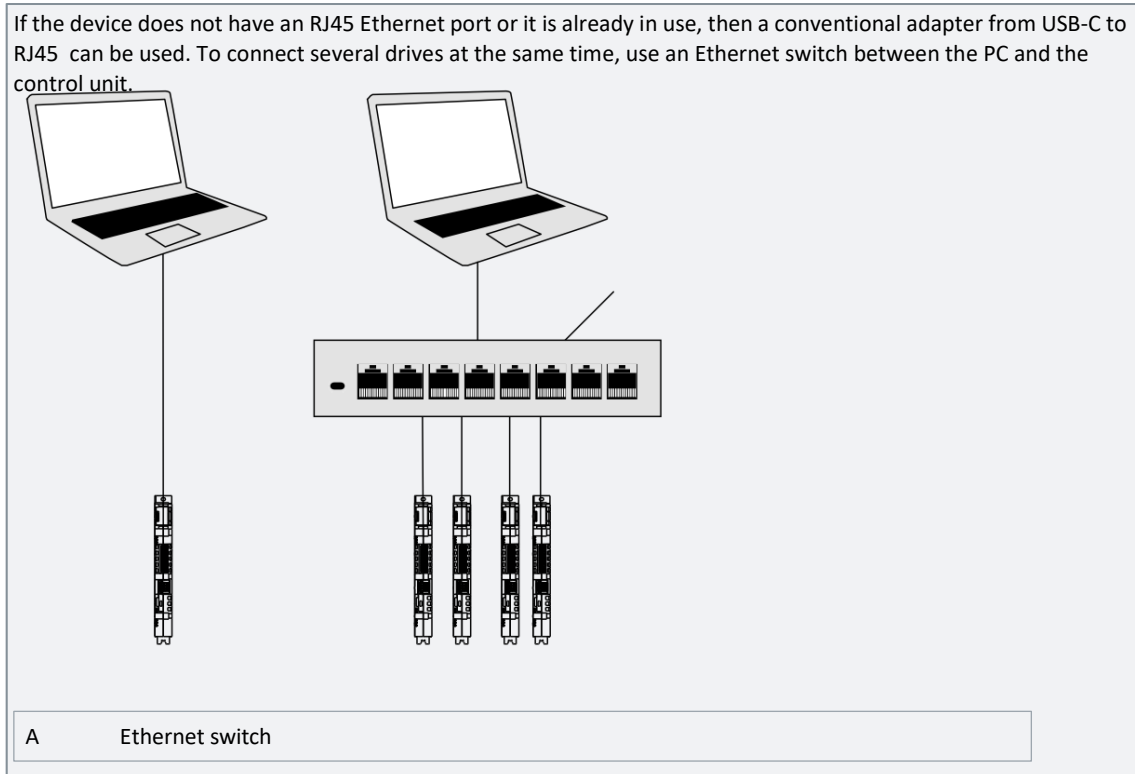

Figure 26: Connection between PC and power converter.

2. When the converter is powered up and in Ready state, open MyDrive® Insight on the device and the converter is recognized.

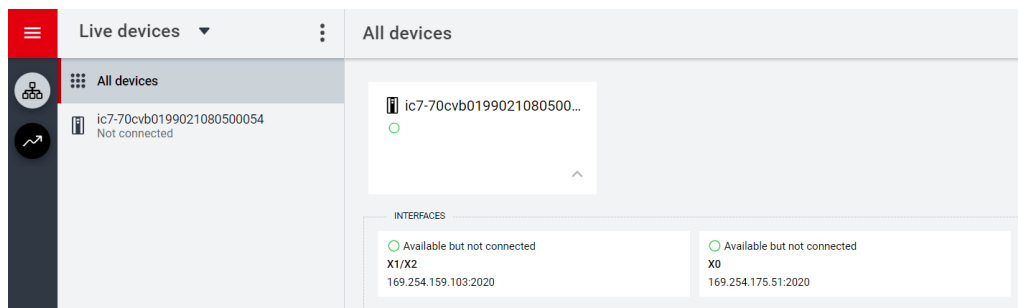

Figure 27: Confirm connection in MyDrive® Insight.

3. To establish or confirm the connection, click the recognized converter(s).

Once the connection is established, the drive is marked with a connection symbol (green color) in MyDrive® Insight, as shown.

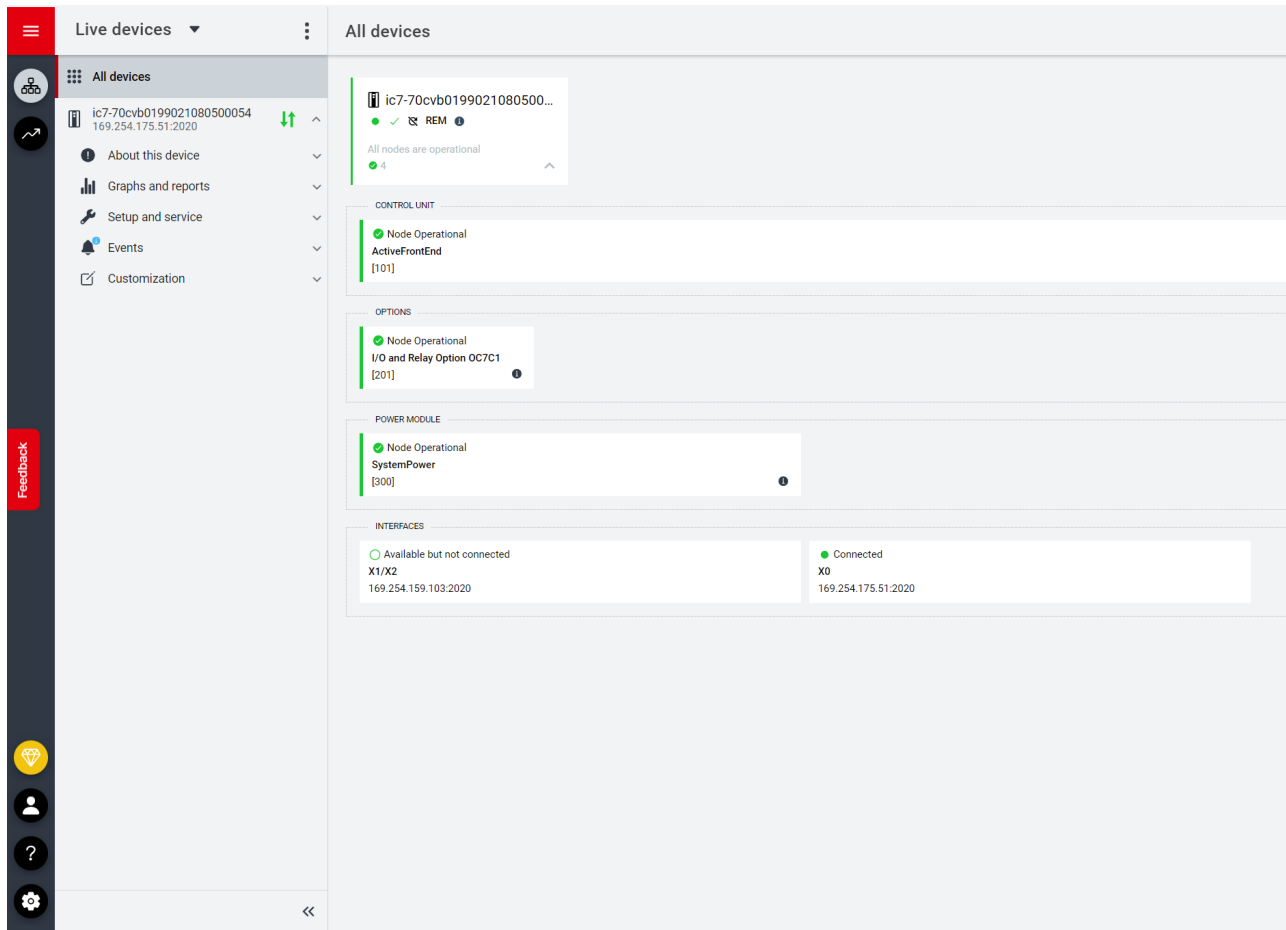

Figure 28: Establish the connection in MyDrive® Insight.

4. Select the required interaction for the converter. In this example, the Device Info (About this device) screen is shown.

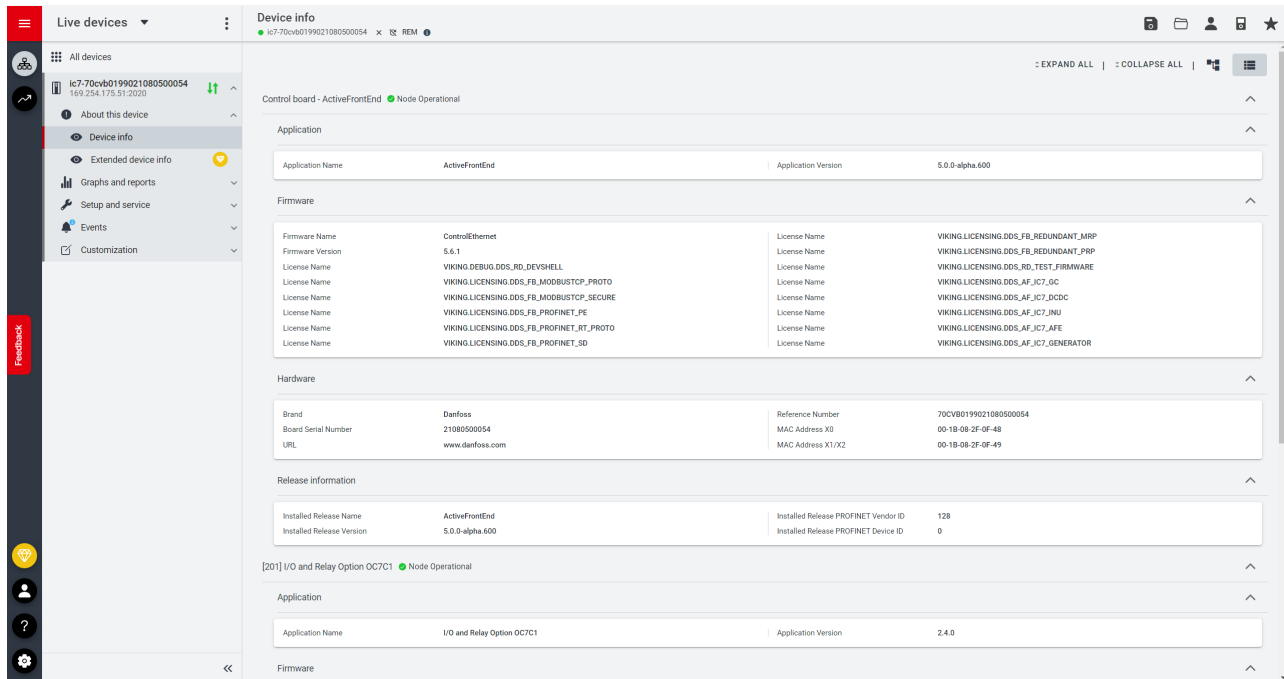

Figure 29: Device info screen in MyDrive® Insight.

NOTICE

The application guide covers basic information such as accessing parameters and using the PC control in MyDrive® In-sight.

3.3.2 Accessing Parameters and Understanding Parameter Screens in MyDrive® Insight

Viewing and Changing Parameters

1. To access the parameters of the connected converter, click Setup and Service.
2. Click Parameters → Live, as shown.

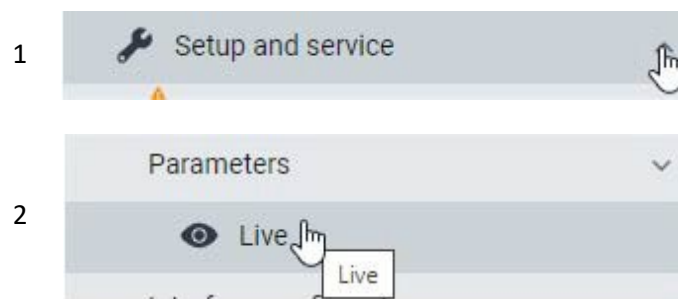

Figure 30: Setup and Service tab in MyDrive® Insight.

Parameter Screen Overview

The following is an overview of the Parameters (Live) screen in MyDrive® Insight. Note that the parameters and groups from the following examples are from the iC7 Industry application and they do not exist in the Active Front End application.

Application Guide

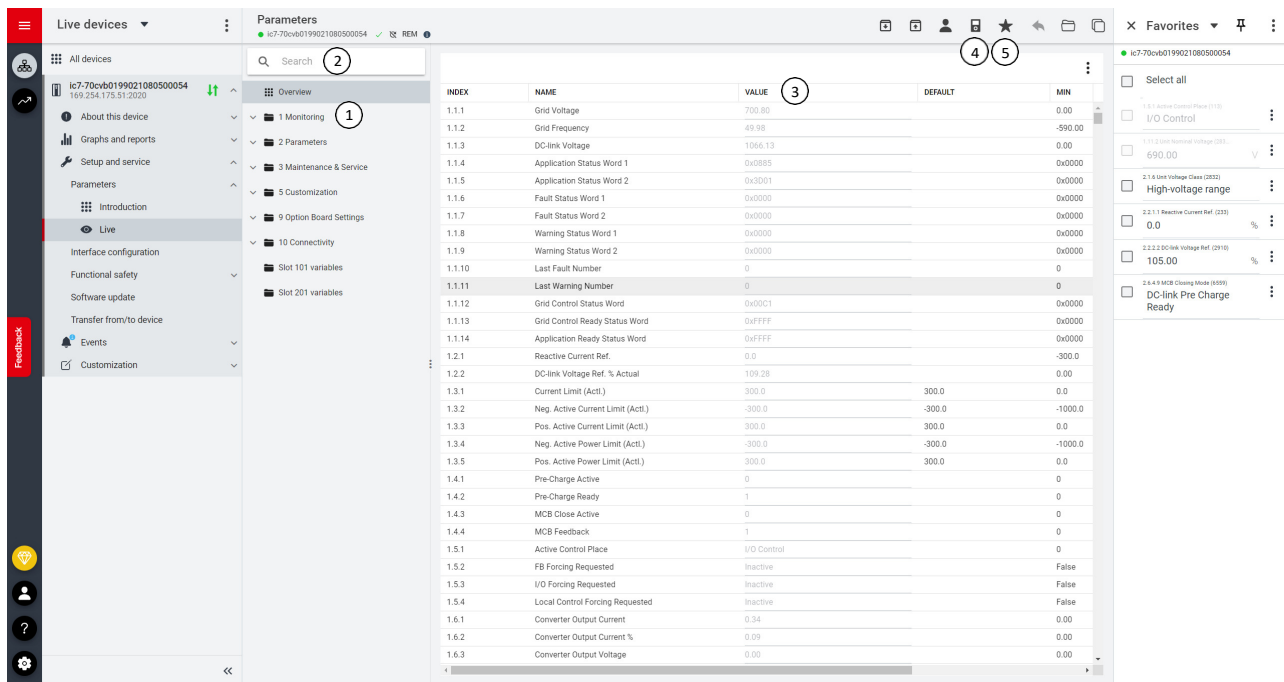

Figure 31: Parameters in the Live view in MyDrive® Insight.

Legend	Name	Description
1	Parameter group	Navigate through the different parameter groups in the converter.
2	Search field	Use the search function to find a specific parameter.
3	Value field	View and change a parameter value or selection. All the parameters for the converter are shown on the Live screen.
4	PC Control button	Switch to PC control to start or stop the converter using MyDrive® Insight.
5	Favorites	Select a parameter as a favorite by clicking the star in its row.

Navigate through different parameter groups

In the following figure, navigating to parameter subgroup 2.2.2 DC-Link Voltage Reference is shown as an example.

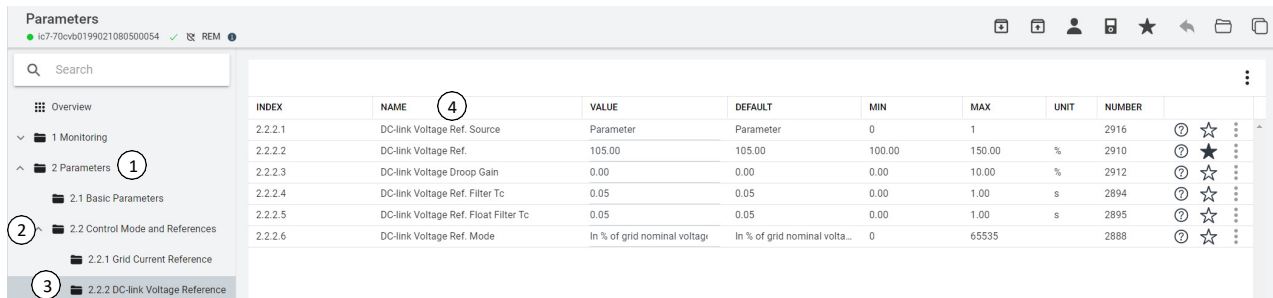

Figure 32: Parameter group navigation in MyDrive® Insight.

1. Click the parameter group (1) from the Live panel.
2. Click the parameter subgroup (2).

- Repeat step 2, until the right level of parameter subgroup (3) is reached to find the specific parameters (4).

NOTICE

When in a specific parameter subgroup, only parameters relevant to the parameter subgroup can be accessed.

Searching for a specific parameter

In the Search field, type the search term. The search returns all parameters that have the search term in the name, index, or number. In the following example, all parameters with DC-Link (1) in the name are listed in the search results (2). Note that in the example the Overview tab is activated, which leads for the search to be conducted within all parameter groups. The search can also be conducted inside a specific group or subgroup by activating the wanted group.

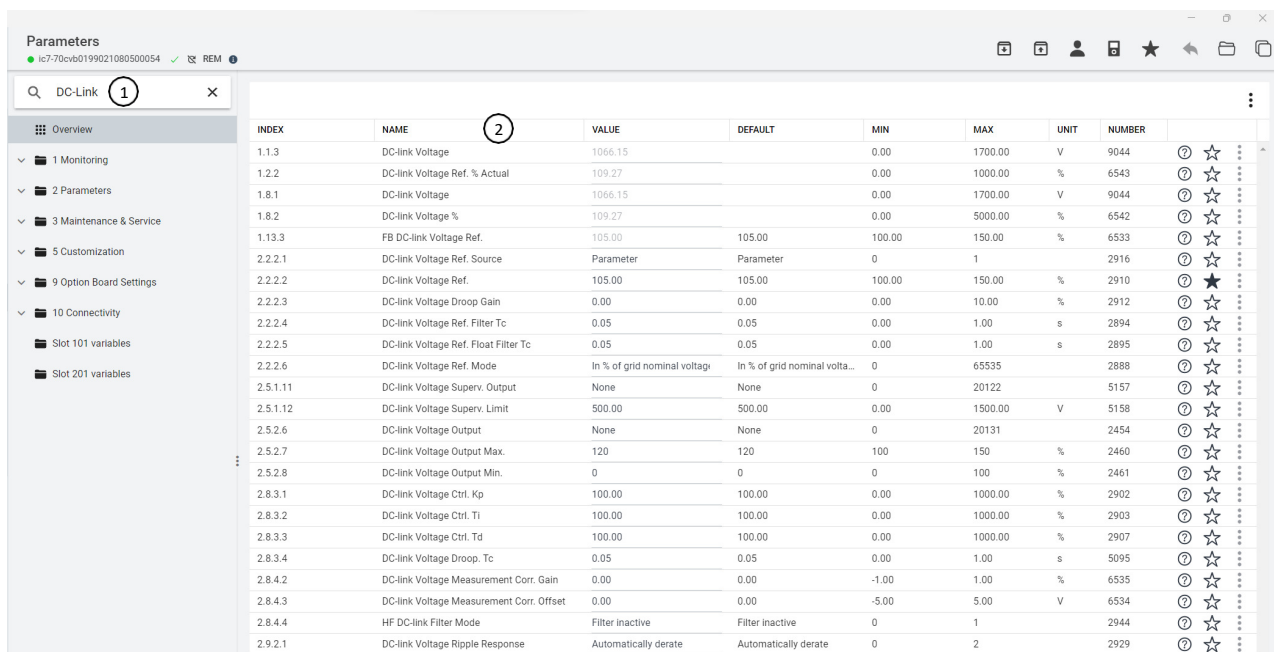

INDEX	NAME	VALUE	DEFAULT	MIN	MAX	UNIT	NUMBER		
1.1.3	DC-link Voltage	1066.15		0.00	1700.00	V	9044	?	☆
1.2.2	DC-link Voltage Ref. % Actual	109.27		0.00	1000.00	%	6543	?	☆
1.8.1	DC-link Voltage	1066.15		0.00	1700.00	V	9044	?	☆
1.8.2	DC-link Voltage %	109.27		0.00	5000.00	%	6542	?	☆
1.13.3	FB DC-link Voltage Ref.	105.00		100.00	150.00	%	6533	?	☆
2.2.2.1	DC-link Voltage Ref. Source	Parameter	Parameter		1		2916	?	☆
2.2.2.2	DC-link Voltage Ref.	105.00	105.00	100.00	150.00	%	2910	?	☆
2.2.2.3	DC-link Voltage Droop Gain	0.00	0.00	0.00	10.00	%	2912	?	☆
2.2.2.4	DC-link Voltage Ref. Filter Tc	0.05	0.05	0.00	1.00	s	2894	?	☆
2.2.2.5	DC-link Voltage Ref. Float Filter Tc	0.05	0.05	0.00	1.00	s	2895	?	☆
2.2.2.6	DC-link Voltage Ref. Mode	In % of grid nominal voltage	In % of grid nominal volta...	0	65535		2888	?	☆
2.5.1.11	DC-link Voltage Superv. Output	None	None	0	20122		5157	?	☆
2.5.1.12	DC-link Voltage Superv. Limit	500.00	500.00	0.00	1500.00	V	5158	?	☆
2.5.2.6	DC-link Voltage Output	None	None	0	20131		2454	?	☆
2.5.2.7	DC-link Voltage Output Max.	120	120	100	150	%	2460	?	☆
2.5.2.8	DC-link Voltage Output Min.	0	0	0	100	%	2461	?	☆
2.8.3.1	DC-link Voltage Ctrl. Kp	100.00	100.00	0.00	1000.00	%	2902	?	☆
2.8.3.2	DC-link Voltage Ctrl. Ti	100.00	100.00	0.00	1000.00	%	2903	?	☆
2.8.3.3	DC-link Voltage Ctrl. Td	100.00	100.00	0.00	1000.00	%	2907	?	☆
2.8.3.4	DC-link Voltage Droop. Tc	0.05	0.05	0.00	1.00	s	5095	?	☆
2.8.4.2	DC-link Voltage Measurement Corr. Gain	0.00	0.00	-1.00	1.00	%	6535	?	☆
2.8.4.3	DC-link Voltage Measurement Corr. Offset	0.00	0.00	-5.00	5.00	V	6534	?	☆
2.8.4.4	HF DC-link Filter Mode	Filter inactive	Filter inactive	0	1		2944	?	☆
2.9.2.1	DC-link Voltage Ripple Response	Automatically derate	Automatically derate	0	2		2929	?	☆

Figure 33: Parameter search in MyDrive® Insight.

Viewing and Changing Parameter Settings

When in a specific parameter group, all parameters related to the parameter group are shown.

Depending on the access type of the parameter, there is a possibility to view the parameter setting or change the current selection or value of the parameter.

In the following picture, parameter group 4 Motor is shown as an example.

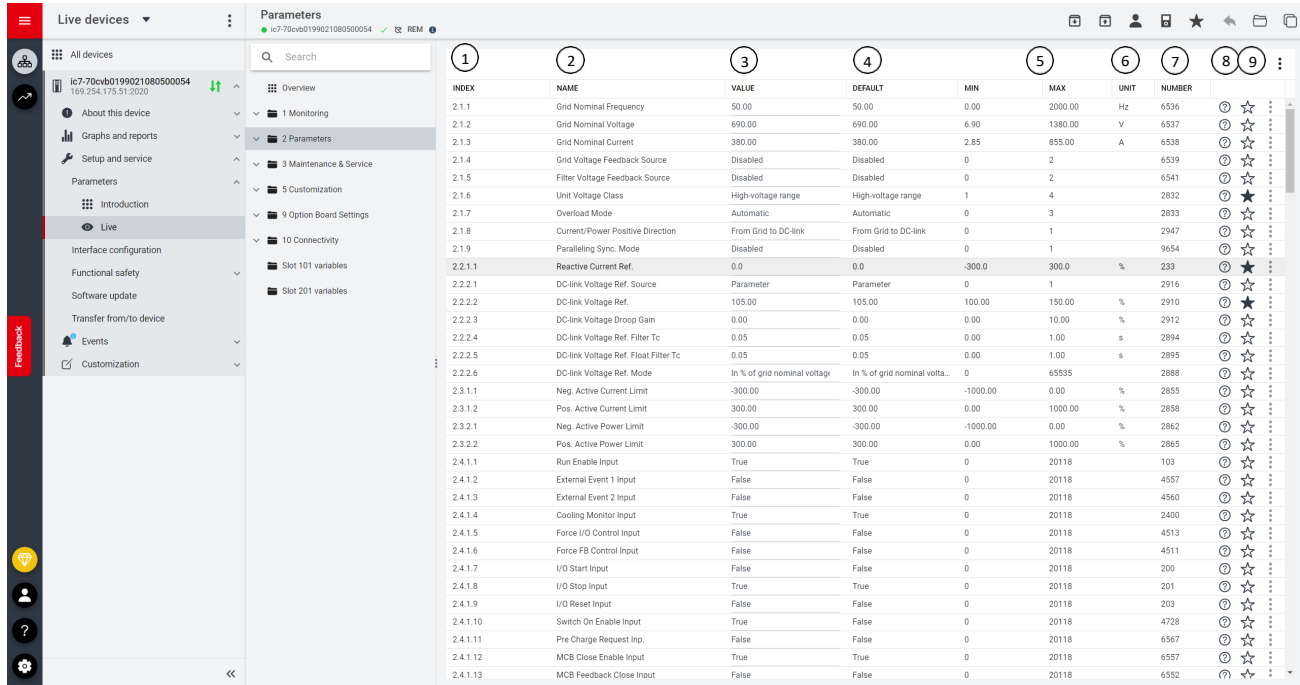

Figure 34: Parameter overview in MyDrive® Insight.

Legend	Name	Description
1	Index	Based on the parameter group structure, the index defines the location of the parameter. The index is not used as a unique identifier of a parameter.
2	Name	Name of the parameter.
3	Value	The current values of the parameters. The values can be edited by clicking the values in the value field.
4	Default	The factory setting (default value) of the parameter.
5	Min and Max	When applicable, the minimum and maximum values of the parameter are shown in the Min and Max fields.
6	Unit	When applicable, the unit of the parameter is shown in the Unit field.
7	Number	The unique identifier for each parameter. The identifier is independent and decoupled from the parameter index values.
8	Help	Click the "?" button to see a description about the parameter. For more detailed descriptions, see chapter 7 Parameter Descriptions of this guide.
9	Favorites (star)	Clicking the Favorites icon adds the parameter to the Favorites tab.

3.3.3 PC Control to Operate the Converter Using MyDrive® Insight

To operate the converter using PC control, click the Control Panel button in MyDrive® Insight. The following illustration shows the different screens to operate the converter via MyDrive® Insight.

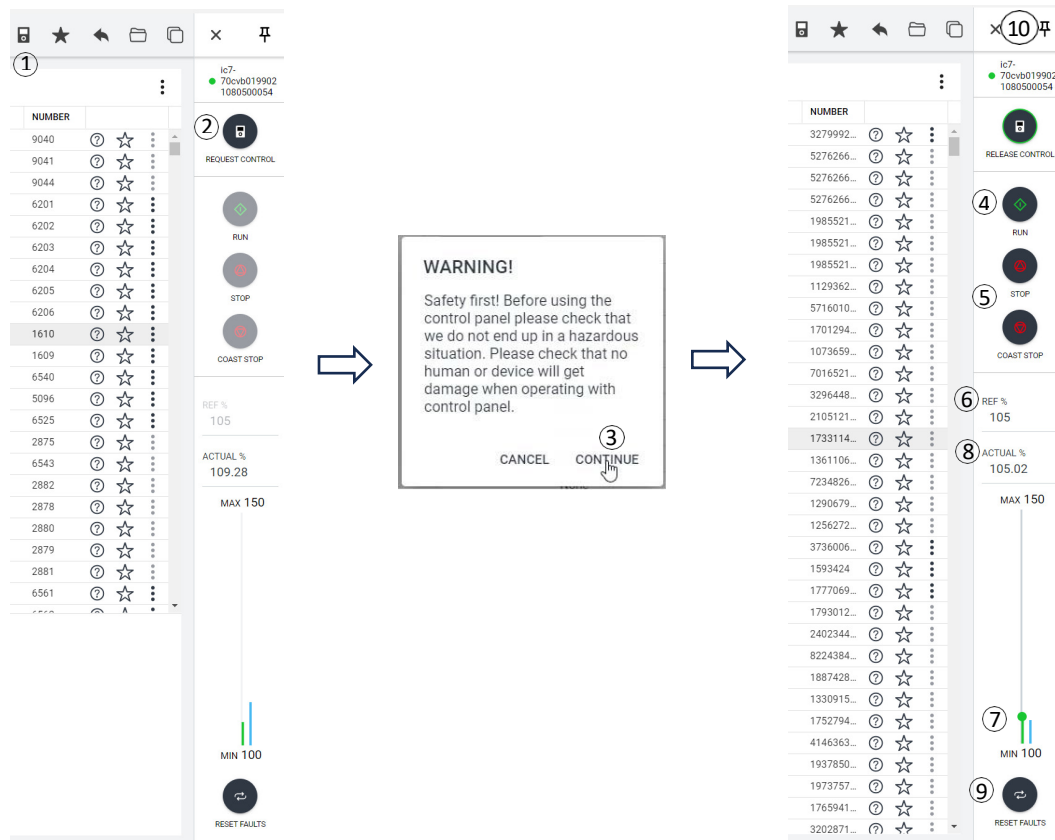

Figure 35: Operating the converter with MyDrive® Insight.

To access PC Control in MyDrive® Insight and operate the converter, perform the following:

1. Activate the PC Control window by pressing the icon in the task bar (1).
2. Click the REQUEST CONTROL button (2).
3. Click Continue (3) to confirm secure operational conditions while controlling the converter using MyDrive® Insight.
4. Use the RUN button (4) to request a converter start. Use the STOP or COAST STOP buttons (5) to request the converter to stop. Note! If COAST STOP is performed, PC Control must be released or the main circuit breaker must be opened in order to restart the converter in PC Control.
5. Use the REF field (6) or the reference slider (7) to adjust the DC-Link Voltage reference. The actual value of the DC-Link Voltage can be monitored from the ACTUAL field (8) or from the blue indicator bar next to the reference slider.
6. To perform a fault reset, click RESET FAULTS (9).
7. For ease of access, click the Pin button (10) to make the control panel be constantly visible on the screen.

3.3.4 Datalogger

The datalogger in MyDrive® Insight enables the monitoring of signals and related information for the selected signals. To access the Datalogger feature, select the converter (1), then go to Graphs and Reports (2) → Datalogger (3).

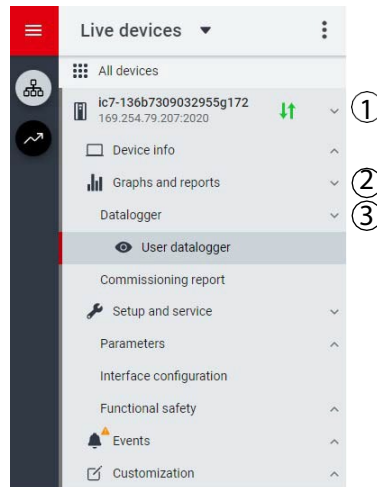

Figure 36: Navigation to the Datalogger in MyDrive® Insight.

The following figure shows the Datalogger main controls.

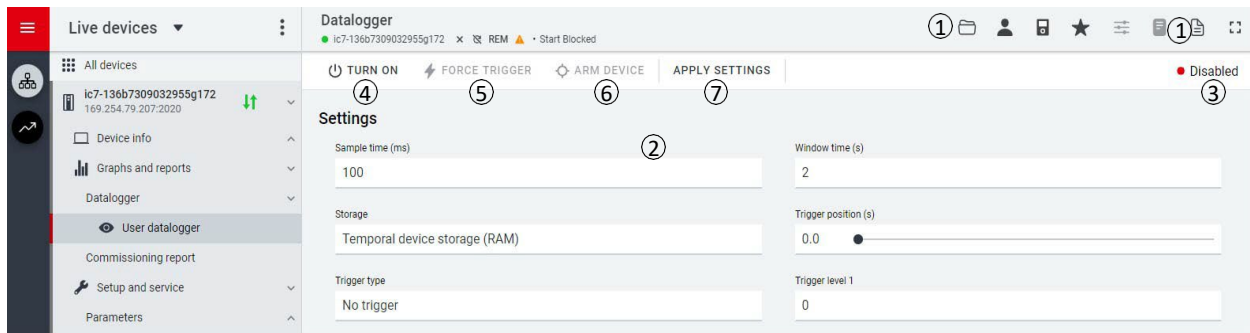

Figure 37: Datalogger screen in MyDrive® Insight.

Legend	Description
1	Opens the window to select available Datalogger files for viewing.
2	Shows the list of Datalogger settings.
3	Shows the Datalogger status.
4	Enables or disables Datalogger. When disabled, all Datalogger configuration settings are inactive. When enabled, Datalogger is active and operates based on the configuration settings.
5	Activates the force trigger. The 0 – 1 transition (rising edge) triggers Datalogger manually. This function is typically used with automatic triggers.
6	Arms Datalogger. The 0 – 1 transition (rising edge) readies Datalogger for triggering.
7	Applies any changed settings.

3.3.4.1 Configuring Datalogger

To configure the datalogger, the following are the 2 main steps:

- Configure the signals to be recorded using the datalogger.
- Configure the datalogger settings.

Procedure:

1. Open Datalogger.

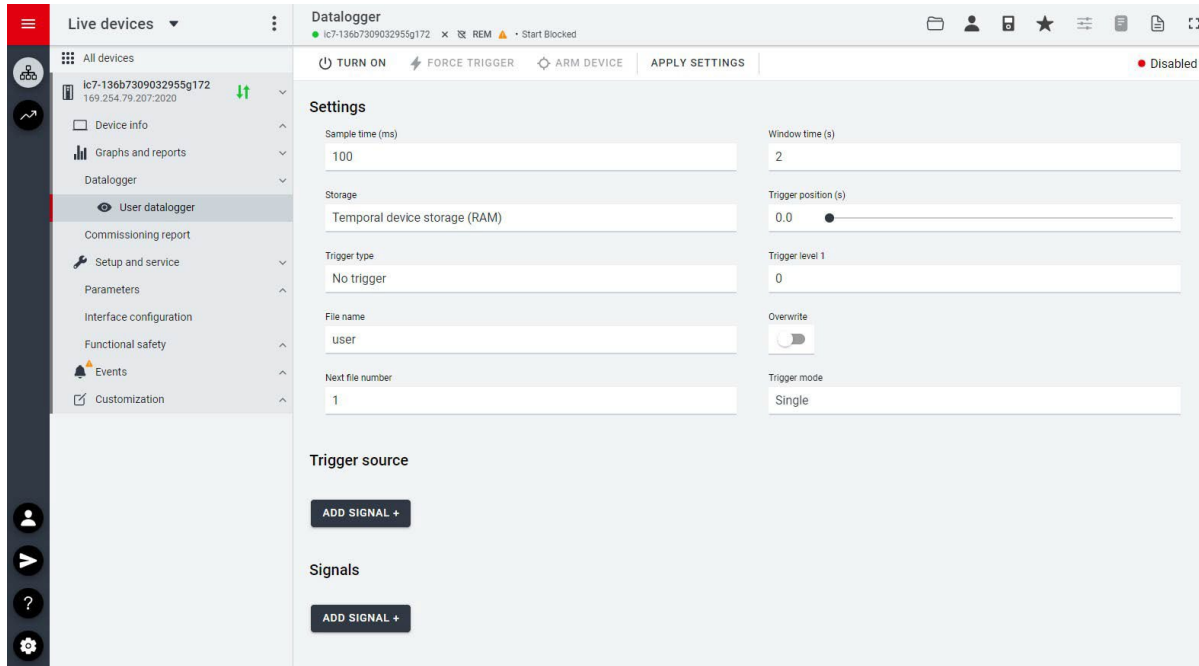
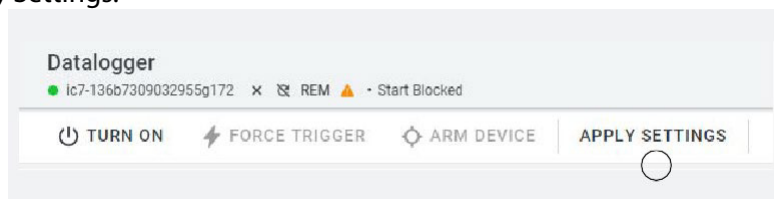

Figure 38: Datalogger settings.

Field name	Field Description
Sample time (ms)	Enter a sample time in ms. The actual sample time depends on the switching frequency. Fast sample rate settings result in data changing slowly in the resulting log.
Window time (s)	Defines the size of the capture window. Enter the window time in seconds. High sample rates and large capture times that result in large capture files may be rejected when the configuration is applied.
Storage	Select the location to which datalogger files are stored. Available selections are: <ul style="list-style-type: none"> • RAM: Settings are stored to the RAM of the converter. • Flash: Settings are stored to the flash of the converter. • SD card: Data is stored on the (optional) microSD card. The microSD cards supported are SD, SDHC, or SDXC which must be formatted for the FAT32 file system. SDHC is the recommended type, as they are delivered preformatted to FAT32.
Trigger position (s)	Adjust the slider to position the trigger. Setting the trigger position to 0 indicates the datalogger recording starts at the time of the trigger. Setting a negative value indicates that the datalogger recording starts after the trigger has occurred. Setting a positive value indicates that the datalogger recording starts before the trigger has occurred.

Field name	Field Description
Trigger type	<p>Following are the trigger types:</p> <ul style="list-style-type: none"> • No trigger (manual trigger only) • Equal triggers when the value of the trigger source variable is equal to trigger level 1. • Not equal triggers when the value of the trigger source variable is not equal to trigger level 1. • Greater than triggers when the value of the trigger source variable is greater than trigger level 1. • Greater than or equal to triggers when the value of the trigger source variable is greater than or equal to trigger level 1. • Less than triggers when the value of the trigger source variable is less than trigger level 1. • Less than or equal to triggers when the value of the trigger source variable is less than or equal to trigger level 1. • Rising edge triggers when the value of the trigger source variable rises above trigger level 1. If the trigger source is already above trigger level 1, the trigger must first drop below the trigger level. • Falling edge triggers when the value of the trigger source variable falls below trigger level 1. If the trigger source is already below trigger level 1, the trigger must first rise above the trigger level.
Trigger level 1	Defines the trigger level associated with the defined trigger type. This level is used for all single-level trigger types. The entry in the field defines the lower trigger level for window trigger types, such as bounds and out of bounds.
File name	Name of the file for datalogger recording.
Overwrite	<p>Click the toggle button to turn the overwrite function on or off.</p> <ul style="list-style-type: none"> • On: Overwrite is enabled. A file number is not appended to the data log file. The datalogger overwrites a previous datalog file. • Off: Overwrite is disabled. A file number is appended to the log file. For each datalog, the datalog file is incremented and the previous datalog file is not overwritten.
Next file number	The number entered in this field is appended to the initial datalog file. Entry in the field is useful when data-logs are previously available in the converter. The number is auto incremented with each datalog recording when the entry in Next file number is enabled.
Trigger mode	<p>Select 1 of the following trigger modes.</p> <ul style="list-style-type: none"> • Single trigger mode: After a datalog recording, the datalogger must be rearmed before another trigger is allowed. • Auto trigger mode: After a datalog recording, the datalogger automatically rearms and starts to accept triggers.
Trigger source	Click the Add signal button under the Trigger source heading. A Trigger source field appears. Click on the Trigger source field to select the signal source which is used for triggering the datalogger recording. The trigger source list opens in a new window:
Signals	<p>Click the Add signal button under the Signals heading. A Signal field appears. Click on the Signal field to select the signals that are logged. The signal list opens in a new window.</p> <p>Add more signals as necessary by clicking the <i>Add signal</i> button again.</p>

2. Click Apply Settings.



After the signal selection and the datalogger settings, the datalogger is ready to record the logs. To view a recorded datalog file, click either one of the icons shown in the figure. The file can be selected from the Captures tab or from the selected file system.

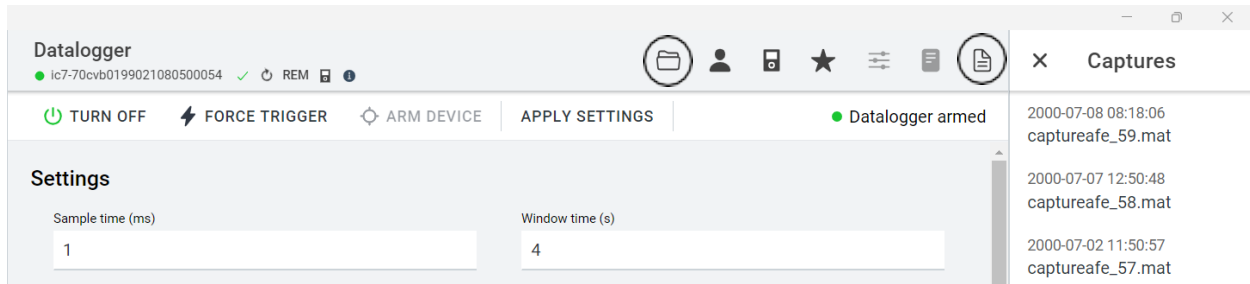

Figure 39: Datalogger log file viewing possibilities.

3.3.5 Backup and Restore

The Backup feature in MyDrive® Insight allows the operator to store the parameter settings of the converter into a new or existing project file, RAM, or Flash memory of the converter, or to an optional microSD card.

To use the microSD card as a storage device, the microSD card must be inserted in the slot on the interface module located behind the control panel, as shown in the following image.

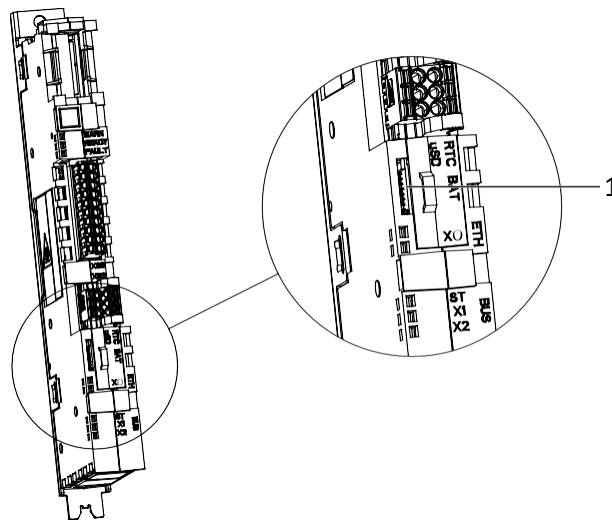

Figure 40: microSD card slot.

Legend	Description
1	The microSD card slot

Following are the types of microSD card supported by the interface module, which must be formatted for the file system FAT32.

- Secure Digital (SD) card
- Secure Digital High Capacity (SDHC)
- Secure Digital Extended Capacity (SDXC)

NOTICE

It is recommended to use SDHC cards as they are delivered as preformatted to FAT32.

3.3.5.1 Backing up the Converter

Procedure

1. To back up the converter, select a converter, go to Setup & Services → Parameters → Live.
2. Click the icon as shown in the figure.

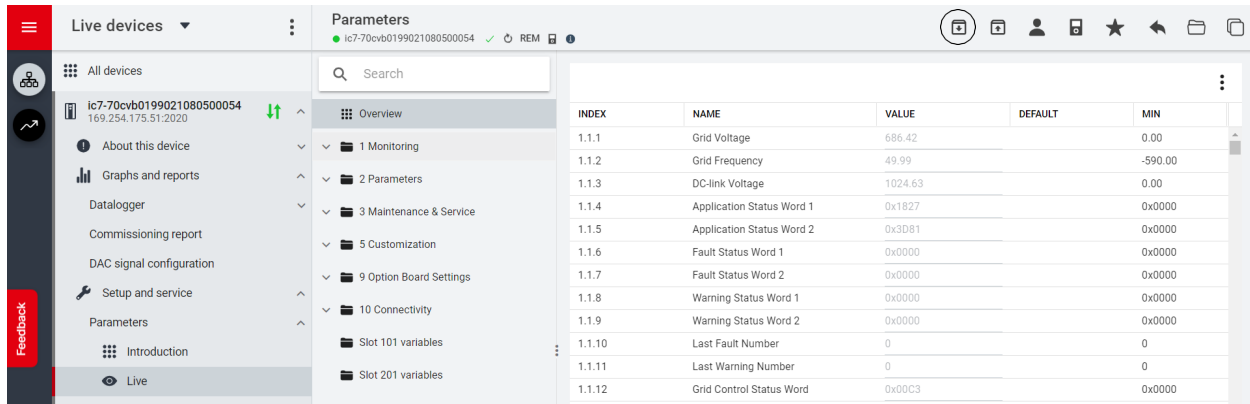

Figure 41: Backup icon.

- This opens a screen to select the backup destination. The destinations to back up are:
 - **Project:** The user can back up an existing project or a new project.
 - **Device file system:** The user can back up to 1 of the available memory devices of the drive.

3. Click Next.
4. If Project was selected, give the backup file a name and description.
If Device file system was selected, select where to save the backup. The selections are flash, RAM, or an (optional) microSD card. It is possible to specify a name for the backup file as well.
5. Click Backup to begin backup.

- Once backup is completed, a notification screen about it appears. If a project file was created, the backup is shown in the device menu under Parameters.

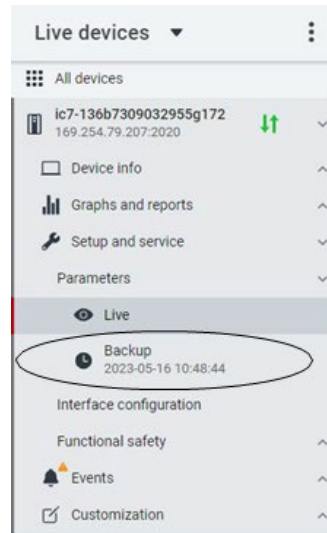

Figure 42: Backup file.

3.3.5.2 Restoring the data into the Converter

Procedure

1. To restore data to the converter, select a converter, go to Setup & Service → Parameters → Live.
2. Click the icon as shown in the following figure.

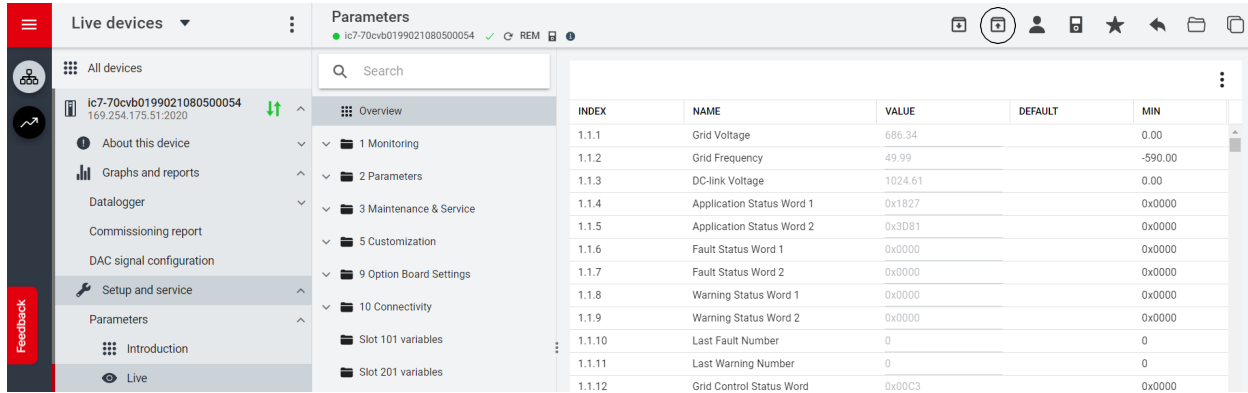

Figure 43: Restore data icon.

3. Select the source of the data which must be restored to the converter.

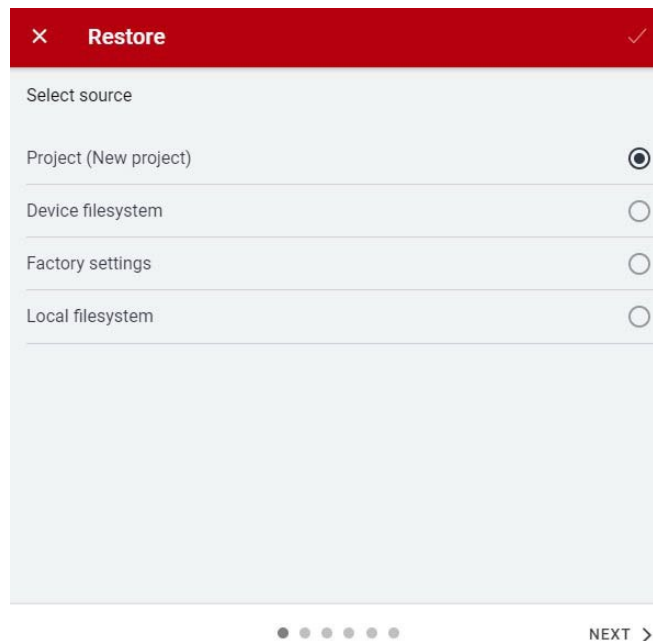

Figure 44: Source of data to be restored.

4. Click Next to select the backup source device and view the available backup files.
5. If Project is the restore source, select the correct backup to restore. Click Next.

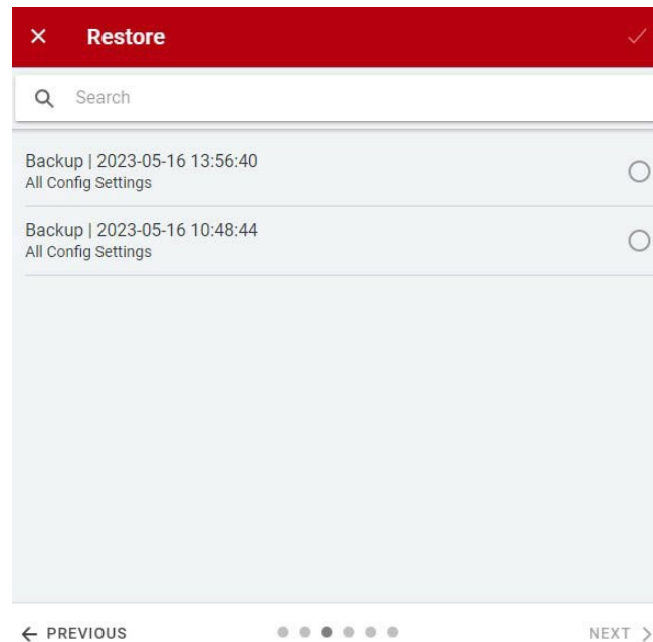

Figure 45: Backup file selection.

6. Select the files for restoring data into the converter, as shown in the following figure, and click Next.

NOTICE

It is possible to exclude Ethernet port settings when restoring data.

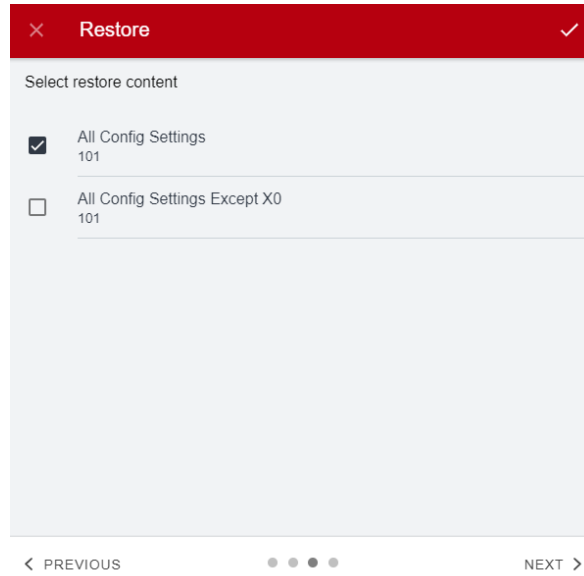

Figure 46: Restore content selection.

7. The system asks confirmation for the restore action. Click Restore.

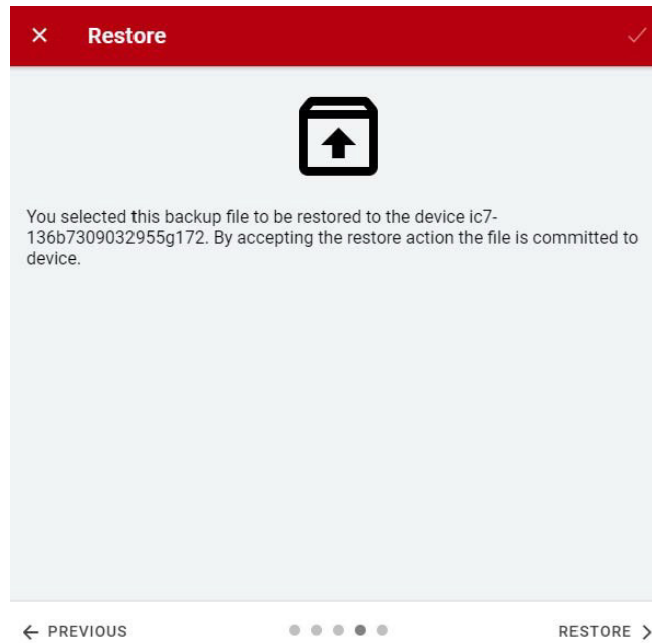

Figure 47: Restore confirmation.

On successful restore of data, a message is shown.

4 Application Software Structure and Overview

4.1 Parameter Groups, Related Content, and Settings

The detailed structure and hierarchy within the parameter groups can vary, depending on the purpose of the parameter group and the total number of parameters. However, the design principle of the structure is to keep the overall sequence while commissioning or setting up the converter, within a logical structure.

- All readouts for monitoring the converter and the application behavior are in group 1 Monitoring.
- Most of the converter configuration, application-specific parameters, and the configuration of external control signals are accessed via parameter group 2 Parameters.
- Features and functions such as Maintenance & Service, Functional Safety, and Customization are in parameter groups 3, 4, and 5.
- The hardware setup for I/O interface, Options, and communication interfaces is done in parameter groups 9 and 10.
- The features and related parameters are grouped in individual parameter groups. Each feature has a parameter group of its own.
- The visibility of some parameters and parameter groups depend on the converter hardware used.
- The following table provides information about the parameter groups.

Index	Parameter group name	Description
1	Monitoring	Contains readout values for monitoring converter and application functions.
2	Parameters	Contains parameters for configuring most of the converter's functions.
3	Maintenance & Service	Contains parameters exclusively related to software information, events, counters, and backup and restore.
4	Functional Safety	Contains parameters for configuring Safe Torque Off, as well as other safety features. <i>Note that this menu appears only if applicable to the system.</i>
5	Customization	Contains parameters to customize and adapt the behavior of the converter and user interface design.
9	Option Board Settings	Contains hardware-related parameters to configure option board related settings.
10	Connectivity	Parameters to configure the inbuilt and optional communication of the converter system.

Application Guide

Parameter Group 1 st level	Parameter Group 2 nd level	Parameter Group 1 st level	Parameter Group 2 nd level	Parameter Group 1 st level	Parameter Group 2 nd level
1. Monitoring	1.1 Basic Monitoring	2. Parameters	2.1 Basic Parameters	3. Maintenance & Service	3.1 Software Information
	1.2 Control Mode and Reference Monitoring		2.2 Control Mode and References		3.2 Events
	1.3 Limit Monitoring		2.3 Limits		3.3 Operational Counters
	1.4 Start and Stop Monitoring		2.4 Digital and Analog Inputs		3.4 Backup and Restore
	1.5 Control Place Monitoring		2.5 Digital and Analog Outputs	4 Functional Safety <i>(not applicable to AFE)</i>	
	1.6 Converter Output Monitoring		2.6 Start and Stop Settings	5 Customization	5.1 Control Panel
	1.7 Grid Monitoring		2.7 Control Places	9. Option Board Settings	*System Specific Menu Content
	1.8 DC-Link Monitoring		2.8 Converter Control	10. Connectivity	Integrated Communication
	1.9 Converter Control Monitoring		2.9 Protections and Responses		
	1.10 Protection Monitoring				
	1.11 Power Unit Monitoring				
	1.12 Cooling Fan Monitoring				
	1.13 Fieldbus Process Data Monitoring				
	* System specific option board monitoring				

5 Configuration Examples

5.1 Introduction and Prerequisites

This section covers the basic configuration steps of an Active Front End converter. The specific application can require more steps such as protection settings. Use the following topics as reference during the converter configuration/commissioning process:

- For control panel related configurations, see 3.2.3 Control Panel Basic Configurations.
- For information on using MyDrive® Insight, see 3.3.1 Getting Started with MyDrive® Insight.
- For detailed information about the parameters, see 6 Parameter Lists and 7 Parameter Descriptions.

The following examples assume that the control unit and pre-charging circuits are powered externally, the converter is controlled through the I/O interface with an OC7C1 I/O and Relay option, in control of pre-charging, and the following wiring configuration is used.

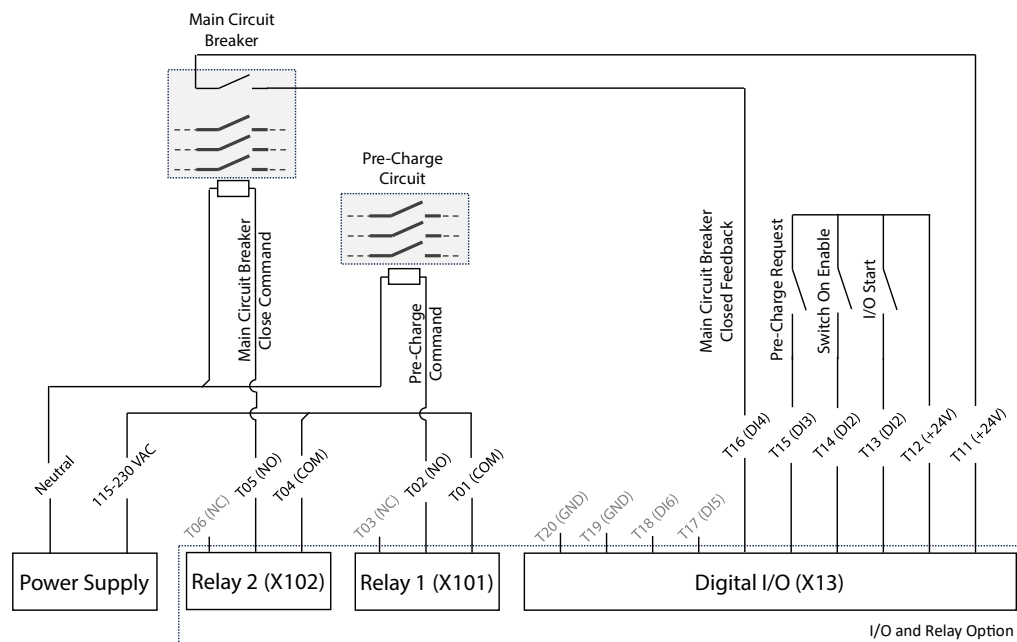

Figure 48: I/O Signal wiring diagram for the example configuration.

Prerequisite:

NOTICE

Ensure that the converter is mounted safely as described in the relevant Operating Guide.

NOTICE

Selection lists with inputs and/or outputs consist of the name of the hardware option and the numbers of the terminals. For example, terminal number 13 of the Basic I/O is named Basic I/O T13 in the selection list.

5.2 Basic Setup of the Converter

The basic setup of the converter consists of the following configuration steps.

1. Configuring the power unit settings.

2. Configuring the grid nominal settings.
3. Configuring the I/O control place and its command inputs.
4. Configuring readouts in the control panel.

Procedure:

1. Configure the power unit settings using the following parameters.

Index	Parameter Name	Example Setting	Parameter Number
2.1.12	Unit Voltage Class*	High Voltage Range	2832
2.1.13	Overload Mode	Automatic	2833
2.6.1.3	Switch On Enable Input	I/O and Relay T14 Digital Input	4728
<p>*Note: The recommended voltage values for the selections depend on the converter type, size, and other such considerations. For example, for T7 units (525–690 V AC):</p> <ul style="list-style-type: none"> • Low Voltage Range: 525–550 V • Medium Voltage Range: 550–600 V • High Voltage Range: 600–690 V • Wide Voltage Range: 525-690 V 			

2. Configure the grid nominal values.

Index	Parameter Name	Example Setting	Parameter Number
2.1.1	Grid Nominal Frequency	50 Hz	6536
2.1.2	Grid Nominal Voltage	690 V	6537
2.1.3	Grid Nominal Current	416 A	6538

3. Configure the control place and command inputs.

Index	Parameter Name	Example Setting	Parameter Number
2.7.1.1	Control Place Selection	I/O Control	114
2.7.3.1	I/O Start Input	I/O and Relay T13 Digital Input	200
2.7.3.4	I/O Start Mode	State High Start	213

4. Configure the readouts in the control panel. See 3.2.3.3 Changing the Content of the Readout Screens.

5.3 Setup of Pre-Charge and Main Circuit Breaker Control

Pre-charging of the DC-link capacitors is required before switching on main power to avoid a high inrush current. The pre-charging function of the converter requires auxiliary voltage for the control unit and the pre-charging circuit, and it must use the digital I/Os and relays of an I/O option. Once pre-charging is done, the converter can close the main circuit breaker and power up the power unit.

The following steps must be taken to configure the control of both the pre-charging circuitry and the main circuit breaker.

1. Configure the pre-charge settings.
2. Configure the main circuit breaker settings.

Procedure:

1. Configure the pre-charge settings. *TODO

Index	Parameter Name	Example Setting	Parameter Number
2.6.3.1	Pre-Charge Request Output	I/O and Relay T02 Relay Output	6563
2.6.3.2	Pre-Charge Ready Level	80.0%	6566
2.6.3.3	Pre-Charge Request Inp.	I/O and Relay T15 Digital Input	6567

2. Configure the main circuit breaker settings.

Index	Parameter Name	Example Setting	Parameter Number
2.6.4.1	MCB Close Output	I/O and Relay T05 Relay Output	6551
2.6.4.2	MCB Feedback Close Input	I/O and Relay T16 Digital Input	6552
2.6.4.9	MCB Closing Mode	DC-link Pre-Charge Ready	6559

5.4 Setup of DC-link Voltage Control

DC-link voltage control is used for bi-directional power transfer and stable DC-link voltage regulation. Control can also limit regenerative power towards the grid, for example in ship grids when required local loads are not available. The following steps can be taken to configure these functionalities.

1. Set a DC-link voltage reference.
2. Set a reactive current reference (if needed).

Procedure:

1. Set a DC-link voltage reference

Index	Parameter Name	Example Setting	Parameter Number
2.2.2.1	DC-link Voltage Ref. Source	Parameter	2916
2.2.2.2	DC-link Voltage Ref.	105.0%	2910

2. Set a reactive current reference (if needed)

Index	Parameter Name	Example Setting	Parameter Number
2.2.1.1	Reactive Current Ref.	0.0%	233



6 Parameter Lists

6.1 How to Read Parameter Lists

The following chapters contain tables presenting the basic attributes of each parameter available in the application software. Each chapter represents a single subgroup within the menu structure.

The tables have the following format:

Index	Name	Num	Min	Max	Default	Unit	Reso	Handling Type	Data Type
1.2.3.4.5	Parameter Name	1234	-10.0 ^[1]	10.0 ^[1]	0.0	Hz	0.01	Config	REAL
6.7.8	Array Parameter Name	5678	0	5	[1,2]		1	Config	UINT

[1]: Value depends on the power unit specification.

- Index: shows the location of the parameter within the menu structure.
- Name: shows the parameter name.
- Num: shows the parameter number.
- Min: shows the minimum value that the parameter can have. For arrays, the single given value applies to all array elements.
- Max: shows the maximum value that the parameter can have. For arrays, the single given value applies to all array elements.
- Default: shows the value that the parameter has with factory default settings. For arrays, each element value is shown comma-separated within square brackets.
- Unit: shows the unit symbol of the parameter. Nothing is shown if the parameter is unitless.
- Reso: shows the resolution or display/edit precision of the parameter.
- Handling Type: shows whether the converter handles the parameter as a constantly changing *process* value or an infrequently changed *configuration* value. Use this field as a guide for evaluating how often to write to parameters when creating custom fieldbus configurations.
- Data type: shows the IEC 61131 elementary data type of the parameter.
- Possible references within any field take note of special conditions that are explained after the table.

6.1.1 Understanding Data Types

The following is an overview of the data types used in the iC7 application software. They are IEC 61131 elementary data types.

Data type	Description	Size (Bits)	Range
BOOL	Boolean	1	0...1
INT	Integer	16	-32,768...32,767
DINT	Double Integer	32	-2,147,483,648 up to 2,147,483,647
USINT	Unsigned short integer	8	0 up to 255
UINT	Unsigned integer	16	0 up to 65,535

Data type	Description	Size (Bits)	Range
UDINT	Unsigned double integer	32	0 up to 4,294,967,295
REAL	Real numbers	32	-3.402823466 E+38 (approximately 7 digits) up to -1.175494351E-38 (approximately 7 digits) and +1.175494351 E-38 (approximately 7 digits) up to +3.402823466 E+38 (approximately 7 digits)
WORD	Bit string of length 16	16	0...65,535 (16#00...16#FFFF)
STRING	Sequence of characters	N/A	1 Byte per character
ULINT	Unsigned long integer	64	0 - 18446744073709551615
DATE_AND_TIME	Date and time information	64	N/A

6.2 Monitoring

6.2.1 Basic Monitoring

Index	Name	Num	Min	Max	Default	Unit	Reso	Handling Type	Data Type
1.1.1	Grid Voltage	9040	0.0	3.4e+38	0.0	V	0.01	Process	REAL
1.1.2	Grid Frequency	9041	-3.4e+38	3.4e+38	0.0	Hz	0.01	Process	REAL
1.1.3	DC-link Voltage	9044	0.0	3.4e+38	0.0	V	0.01	Process	REAL
1.1.4	Application Status Word 1	6201	0x0	0xffff	0x0		1	Process	WORD
1.1.5	Application Status Word 2	6202	0x0	0xffff	0x0		1	Process	WORD
1.1.6	Fault Status Word 1	6203	0x0	0xffff	0x0		1	Process	WORD
1.1.7	Fault Status Word 2	6204	0x0	0xffff	0x0		1	Process	WORD
1.1.8	Warning Status Word 1	6205	0x0	0xffff	0x0		1	Process	WORD
1.1.9	Warning Status Word 2	6206	0x0	0xffff	0x0		1	Process	WORD
1.1.10	Last Fault Number	1610	0	65535	0		1	Process	UINT
1.1.11	Last Warning Number	1609	0	65535	0		1	Process	UINT
1.1.12	Grid Control Status Word	6540	0x0	0xffff	0x0		1	Process	WORD
1.1.13	Grid Control Ready Status Word	5096	0x0	0xffff	0x0		1	Process	WORD
1.1.14	Application Ready Status Word	6525	0x0	0xffff	0x0		1	Process	WORD

6.2.2 Control Mode and Reference Monitoring

Index	Name	Num	Min	Max	Default	Unit	Reso	Handling Type	Data Type
1.2.1	Reactive Current Ref.	2875	-3.4e+38	3.4e+38	0.0	%	0.1	Process	REAL
1.2.2	DC-link Voltage Ref. % Actual	6543	0.0	1000.0	105.0	%	0.01	Process	REAL

6.2.3 Limit Monitoring

Index	Name	Num	Min	Max	Default	Unit	Reso	Handling Type	Data Type
1.3.1	Current Limit (Actl.)	2882	0.0	1000.0	300.0	%	0.1	Process	REAL
1.3.2	Neg. Active Current Limit (Actl.)	2878	-1000.0	0.0	-300.0	%	0.1	Process	REAL
1.3.3	Pos. Active Current Limit (Actl.)	2880	0.0	1000.0	300.0	%	0.1	Process	REAL
1.3.4	Neg. Active Power Limit (Actl.)	2879	-1000.0	0.0	-300.0	%	0.1	Process	REAL
1.3.5	Pos. Active Power Limit (Actl.)	2881	0.0	1000.0	300.0	%	0.1	Process	REAL

6.2.4 Start and Stop Monitoring

Index	Name	Num	Min	Max	Default	Unit	Reso	Handling Type	Data Type
1.4.1	Pre-Charge Active	6561	0	1	0		1	Process	INT
1.4.2	Pre-Charge Ready	6562	0	1	0		1	Process	INT
1.4.3	MCB Close Active	171	0	1	0		1	Process	INT
1.4.4	MCB Feedback	172	0	1	0		1	Process	INT

6.2.5 Control Place Monitoring

Index	Name	Num	Min	Max	Default	Unit	Reso	Handling Type	Data Type
1.5.1	Active Control Place	113	0	3	0		1	Process	UINT
1.5.2	FB Forcing Requested	116	0	1	0		1	Process	BOOL
1.5.3	I/O Forcing Requested	117	0	1	0		1	Process	BOOL
1.5.4	Local Control Forcing Requested	124	0	1	0		1	Process	BOOL

6.2.6 Converter Output Monitoring

Index	Name	Num	Min	Max	Default	Unit	Reso	Handling Type	Data Type
1.6.1	Converter Output Current	9000	0.0	3.4e+38	0.0	A	0.01	Process	REAL
1.6.2	Converter Output Current %	9001	0.0	200.0	0.0	%	0.01	Process	REAL
1.6.3	Converter Output Voltage	9005	0.0	3.4e+38	0.0	V	0.01	Process	REAL

6.2.7 Grid Monitoring

Index	Name	Num	Min	Max	Default	Unit	Reso	Handling Type	Data Type
1.7.1	Grid Frequency	9041	-3.4e+38	3.4e+38	0.0	Hz	0.01	Process	REAL
1.7.2	Grid Voltage	9040	0.0	3.4e+38	0.0	V	0.01	Process	REAL
1.7.3	Grid Voltage Imbalance	9047	0.0	100.0	0.0	%	0.1	Process	REAL
1.7.4	Grid Current	9060	0.0	3.4e+38	0.0	A	0.1	Process	REAL

Index	Name	Num	Min	Max	Default	Unit	Reso	Handling Type	Data Type
1.7.5	Grid Current %	9061	-1000.0	1000.0	0.0	%	0.1	Process	REAL
1.7.6	Grid Active Current %	9062	-1000.0	1000.0	0.0	%	0.01	Process	REAL
1.7.7	Grid Reactive Current %	9063	-300.0	300.0	0.0	%	0.1	Process	REAL
1.7.8	Grid Active Power	9064	-3.4e+38	3.4e+38	0.0	kW	0.01	Process	REAL
1.7.9	Grid Active Power %	9065	-1000.0	1000.0	0.0	%	0.1	Process	REAL
1.7.10	Grid Reactive Power %	9052	-1000.0	1000.0	0.0	%	0.1	Process	REAL

6.2.8 DC-Link Monitoring

Index	Name	Num	Min	Max	Default	Unit	Reso	Handling Type	Data Type
1.8.1	DC-link Voltage	9044	0.0	3.4e+38	0.0	V	0.01	Process	REAL
1.8.2	DC-link Voltage %	6542	0.0	5000.0	0.0	%	0.01	Process	REAL

6.2.9 Converter Control Monitoring

Index	Name	Num	Min	Max	Default	Unit	Reso	Handling Type	Data Type
1.9.1	Actual Switching Frequency	2923	0.0	16000.0	0.0	Hz	0.01	Process	REAL
1.9.2	Modulation Index	5101	0.0	2.0	0.0		0.01	Process	REAL
1.9.3	Control Unit Temperature	2952	-50.0	200.0	0.0	°C	0.01	Process	REAL

6.2.10 Protection Monitoring

6.2.10.1 Measured Temp. Protection Status

Index	Name	Num	Min	Max	Default	Unit	Reso	Handling Type	Data Type
1.10.1.1	Protection 1 Temp.	5200	-300.0	300.0	0.0	°C	0.01	Process	REAL
1.10.1.2	Protection 2 Temp.	5201	-300.0	300.0	0.0	°C	0.01	Process	REAL
1.10.1.3	Protection 3 Temp.	5202	-300.0	300.0	0.0	°C	0.01	Process	REAL
1.10.1.4	Protection 4 Temp.	5203	-300.0	300.0	0.0	°C	0.01	Process	REAL
1.10.1.5	Protection 5 Temp.	5204	-300.0	300.0	0.0	°C	0.01	Process	REAL
1.10.1.6	Protection 6 Temp.	5205	-300.0	300.0	0.0	°C	0.01	Process	REAL
1.10.1.7	Protection 7 Temp.	5273	-300.0	300.0	0.0	°C	0.01	Process	REAL
1.10.1.8	Protection 8 Temp.	5274	-300.0	300.0	0.0	°C	0.01	Process	REAL
1.10.1.9	Protection 9 Temp.	5275	-300.0	300.0	0.0	°C	0.01	Process	REAL
1.10.1.10	Protection 10 Temp.	5276	-300.0	300.0	0.0	°C	0.01	Process	REAL

6.2.11 Power Unit Monitoring

Index	Name	Num	Min	Max	Default	Unit	Reso	Handling Type	Data Type
1.11.1	Power Capacity	2836	0.0	100.0	100.0	%	1	Process	REAL

Index	Name	Num	Min	Max	Default	Unit	Reso	Handling Type	Data Type
1.11.2	Unit Nominal Voltage	2830	0.0	3.4e+38	400.0	V	0.01	Config	REAL
1.11.3	Unit Nominal Current	2831	0.0	3.4e+38	23.0	A	0.01	Config	REAL
1.11.4	Heat Sink Temperature	2950	-50.0	200.0	0.0	°C	0.01	Process	REAL

6.2.12 Cooling Fan Monitoring

Index	Name	Num	Min	Max	Default	Unit	Reso	Handling Type	Data Type
1.12.1	Main Fan Speed	2931	0	32767	0	rpm	1	Process	INT
1.12.2	Internal Fan Speed	2926	0	32767	0	rpm	1	Process	INT

6.2.13 Fieldbus Process Data Monitoring

Index	Name	Num	Min	Max	Default	Unit	Reso	Handling Type	Data Type
1.13.1	Fieldbus Control Word	1335	0x0	0xffff	0x4		1	Process	WORD
1.13.2	FB Status Word	1307	0x0	0xffff	0x0		1	Process	WORD
1.13.3	FB DC-link Voltage Ref.	6533	100.0	150.0	105.0	%	0.01	Process	REAL

6.2.14 I/O and Relay Status

This group appears only if an I/O And Relay OC7C1 option is included in the converter. This menu appears as many times as there are these options in the system. Each menu and its parameters have the suffix of their option slot.

Refer to 6.6.1.1 I/O and Relay Status for the content of this menu.

6.2.15 Temperature Measurement Status

This group appears only if a Temperature Measurement OC7T0 option is included in the converter. This menu appears as many times as there are these options in the system. Each menu and its parameters have the suffix of their option slot.

Refer to 6.6.2.1 Temperature Measurement Status for the content of this menu.

6.2.16 Voltage Measurement Status

This group appears only if a Voltage Measurement OC7V0 option is included in the converter. This menu appears as many times as there are these options in the system. Each menu and its parameters have the suffix of their option slot.

Refer to 6.6.3.1 Voltage Measurement Status for the content of this menu.

6.3 Parameters

6.3.1 Basic Parameters

Index	Name	Num	Min	Max	Default	Unit	Reso	Handling Type	Data Type
2.1.1	Grid Nominal Frequency	6536	0.0	2000.0	50.0	Hz	0.01	Config	REAL
2.1.2	Grid Nominal Voltage	6537	-3.4e+38	3.4e+38	690.0	V	0.01	Config	REAL
2.1.3	Grid Nominal Current	6538	-3.4e+38	3.4e+38	416.0	A	0.01	Config	REAL
2.1.4	Grid Voltage Feedback Source	6539	0	2	0		1	Config	UINT
2.1.5	Filter Voltage Feedback Source	6541	0	2	0		1	Config	UINT
2.1.6	Unit Voltage Class	2832	1	4	1		1	Config	UINT
2.1.7	Overload Mode	2833	0	3	2		1	Config	UINT
2.1.8	Current/Power Positive Direction	2947	0	1	0		1	Config	UINT
2.1.9	Paralleling Sync. Mode	9654	0	2	0		1	Config	UINT

6.3.2 Control Mode and References

6.3.2.1 Grid Current Reference

Index	Name	Num	Min	Max	Default	Unit	Reso	Handling Type	Data Type
2.2.1.1	Reactive Current Ref.	233	-300.0	300.0	0.0	%	0.1	Config	REAL

6.3.2.2 DC-link Voltage Reference

Index	Name	Num	Min	Max	Default	Unit	Reso	Handling Type	Data Type
2.2.2.1	DC-link Voltage Ref. Source	2916	0	1	0		1	Config	UINT
2.2.2.2	DC-link Voltage Ref.	2910	100.0	150.0	105.0	%	0.01	Config	REAL
2.2.2.3	DC-link Voltage Droop Gain	2912	0.0	100.0	0.0	%	0.01	Config	REAL
2.2.2.4	DC-link Voltage Ref. Filter Tc	2894	0.0	1.0	0.05	s	0.01	Config	REAL
2.2.2.5	DC-link Voltage Ref. Float Filter Tc	2895	0.0	1.0	0.05	s	0.01	Config	REAL
2.2.2.6	DC-link Voltage Ref. Mode	2888	0	65535	0		1	Config	UINT

6.3.3 Limits

6.3.3.1 Grid Current Limit

Index	Name	Num	Min	Max	Default	Unit	Reso	Handling Type	Data Type
2.3.1.1	Neg. Active Current Limit	2855	-1000.0	0.0	-300.0	%	0.01	Config	REAL
2.3.1.2	Pos. Active Current Limit	2858	0.0	1000.0	300.0	%	0.01	Config	REAL

6.3.3.2 Grid Power Limit

Index	Name	Num	Min	Max	Default	Unit	Reso	Handling Type	Data Type
2.3.2.1	Neg. Active Power Limit	2862	-1000.0	0.0	-300.0	%	0.01	Config	REAL
2.3.2.2	Pos. Active Power Limit	2865	0.0	1000.0	300.0	%	0.01	Config	REAL

6.3.4 Digital and Analog Inputs

6.3.4.1 Digital Inputs

Index	Name	Num	Min	Max	Default	Unit	Reso	Handling Type	Data Type
2.4.1.1	Run Enable Input	103	0	29999	1		1	Config	UINT
2.4.1.2	External Event 1 Input	4557	0	29999	0		1	Config	UINT
2.4.1.3	External Event 2 Input	4560	0	29999	0		1	Config	UINT
2.4.1.4	Cooling Monitor Input	2400	0	29999	1		1	Config	UINT
2.4.1.5	Force I/O Control Input	4513	0	29999	0		1	Config	UINT
2.4.1.6	Force FB Control Input	4511	0	29999	0		1	Config	UINT
2.4.1.7	I/O Start Input	200	0	29999	0		1	Config	UINT
2.4.1.8	I/O Stop Input	201	0	29999	1		1	Config	UINT
2.4.1.9	I/O Reset Input	203	0	29999	0		1	Config	UINT
2.4.1.10	Switch On Enable Input	4728	0	29999	10114		1	Config	UINT
2.4.1.11	Pre Charge Request Inp.	6567	0	29999	10115		1	Config	UINT
2.4.1.12	MCB Close Enable Input	6557	0	29999	1		1	Config	UINT
2.4.1.13	MCB Feedback Close Input	6552	0	29999	10116		1	Config	UINT
2.4.1.14	MCB Feedback Open Input	6553	0	29999	0		1	Config	UINT
2.4.1.15	MCB Tripped Input	6554	0	29999	0		1	Config	UINT
2.4.1.16	Quick Stop Input	212	0	29999	1		1	Config	UINT
2.4.1.17	Quick Stop Input 2	5104	0	29999	1		1	Config	UINT
2.4.1.18	Input Section Overtemp. Input	5310	0	29999	1		1	Config	UINT

6.3.5 Digital and Analog Outputs

6.3.5.1 Digital Outputs

Index	Name	Num	Min	Max	Default	Unit	Reso	Handling Type	Data Type
2.5.1.1	Ready Output	205	0	65535	0		1	Config	UINT
2.5.1.2	Run Output	206	0	65535	0		1	Config	UINT
2.5.1.3	Static Fault Output	208	0	65535	0		1	Config	UINT
2.5.1.4	Static Warning Output	209	0	65535	0		1	Config	UINT
2.5.1.5	Toggling Fault Output	5180	0	65535	0		1	Config	UINT
2.5.1.6	Toggling Warning Output	5181	0	65535	0		1	Config	UINT
2.5.1.7	FB CTW Bit 12 Output	5193	0	29999	0		1	Config	UINT

Index	Name	Num	Min	Max	Default	Unit	Reso	Handling Type	Data Type
2.5.1.8	FB CTW Bit 13 Output	5194	0	29999	0		1	Config	UINT
2.5.1.9	FB CTW Bit 14 Output	5198	0	29999	0		1	Config	UINT
2.5.1.10	FB CTW Bit 15 Output	5191	0	29999	0		1	Config	UINT
2.5.1.11	DC-link Voltage Superv. Output	5157	0	65535	0		1	Config	UINT
2.5.1.12	DC-link Voltage Superv. Limit	5158	0.0	1500.0	500.0	V	0.01	Config	REAL
2.5.1.13	Local Control Active Output	5178	0	65535	0		1	Config	UINT
2.5.1.14	I/O Control Active Output	5177	0	65535	0		1	Config	UINT
2.5.1.15	Fieldbus Control Active Output	5197	0	65535	0		1	Config	UINT
2.5.1.16	Active Event 1 Output	5189	0	65535	0		1	Config	UINT
2.5.1.17	Event 1 Number	5188	0	65535	0		1	Config	UINT
2.5.1.18	Active Event 2 Output	5190	0	65535	0		1	Config	UINT
2.5.1.19	Event 2 Number	5290	0	65535	0		1	Config	UINT
2.5.1.20	No Warning Output	217	0	65535	0		1	Config	UINT
2.5.1.21	No Fault Output	218	0	65535	0		1	Config	UINT
2.5.1.22	Local Control Forcing Requested Output	125	0	29999	0		1	Config	UINT
2.5.1.23	I/O Forcing Requested Output	121	0	65535	0		1	Config	UINT
2.5.1.24	FB Forcing Requested Output	120	0	65535	0		1	Config	UINT

6.3.5.2 Analog outputs

Index	Name	Num	Min	Max	Default	Unit	Reso	Handling Type	Data Type
2.5.2.1	Output Current Output	2453	0	65535	0		1	Config	UINT
2.5.2.2	Absolute Active Power Output	2456	0	65535	0		1	Config	UINT
2.5.2.3	Active Power Output	2455	0	65535	0		1	Config	UINT
2.5.2.4	Active Power Output Max.	2458	-10000.0	10000.0	3000.0	kW	0.01	Config	REAL
2.5.2.5	Active Power Output Min.	2459	-10000.0	10000.0	-3000.0	kW	0.01	Config	REAL
2.5.2.6	DC-link Voltage Output	2454	0	65535	0		1	Config	UINT
2.5.2.7	DC-link Voltage Output Max.	2460	100.0	150.0	120.0	%	1	Config	REAL
2.5.2.8	DC-link Voltage Output Min.	2461	0.0	100.0	0.0	%	1	Config	REAL
2.5.2.9	Main Fan Speed Output	2462	0	65535	0		1	Config	UINT
2.5.2.10	Main Fan Speed Output Max.	2463	0.0	10000.0	10000.0	rpm	1	Config	REAL
2.5.2.11	Main Fan Speed Output Min.	2464	0.0	10000.0	0.0	rpm	1	Config	REAL

6.3.6 Start and Stop Settings

6.3.6.1 Start Settings

Index	Name	Num	Min	Max	Default	Unit	Reso	Handling Type	Data Type
2.6.1.1	Start Delay	4718	0.0	10.0	0.0	s	0.01	Config	REAL
2.6.1.2	Run Enable Input	103	0	29999	1		1	Config	UINT
2.6.1.3	Switch On Enable Input	4728	0	29999	10114		1	Config	UINT

6.3.6.2 Quick Stop

Index	Name	Num	Min	Max	Default	Unit	Reso	Handling Type	Data Type
2.6.2.1	Quick Stop Input	212	0	29999	1		1	Config	UINT
2.6.2.2	Quick Stop Input 2	5104	0	29999	1		1	Config	UINT
2.6.2.3	Quick Stop Response	4587	0	11	10		1	Config	UINT

6.3.6.3 Pre Charge

Index	Name	Num	Min	Max	Default	Unit	Reso	Handling Type	Data Type
2.6.3.1	Pre-Charge Request Output	6563	0	29999	10102		1	Config	UINT
2.6.3.2	Pre-Charge Ready Level	6566	80.0	120.0	80.0	%	0.01	Config	REAL
2.6.3.3	Pre Charge Request Inp.	6567	0	29999	10115		1	Config	UINT
2.6.3.4	Pre-Charge Allowed Output	6569	0	29999	0		1	Config	UINT
2.6.3.5	Pre-Charge Allowed Level	5510	30.0	3.4e+38	50.0	%	1	Config	REAL

6.3.6.4 Main Circuit Breaker

Index	Name	Num	Min	Max	Default	Unit	Reso	Handling Type	Data Type
2.6.4.1	MCB Close Output	6551	0	29999	10105		1	Config	UINT
2.6.4.2	MCB Feedback Close Input	6552	0	29999	10116		1	Config	UINT
2.6.4.3	MCB Feedback Open Input	6553	0	29999	0		1	Config	UINT
2.6.4.4	MCB Tripped Input	6554	0	29999	0		1	Config	UINT
2.6.4.5	MCB Close Pulse Output	6555	0	29999	0		1	Config	UINT
2.6.4.6	MCB Open Pulse Output	6556	0	29999	0		1	Config	UINT
2.6.4.7	MCB Close Enable Input	6557	0	29999	1		1	Config	UINT
2.6.4.8	MCB Feedback Fault Delay	6558	0.0	5.0	2.0	s	0.01	Config	REAL
2.6.4.9	MCB Closing Mode	6559	0	3	0		1	Config	UINT
2.6.4.10	MCB Opening Mode	6560	0	3	0		1	Config	UINT

6.3.6.5 LCL-Filter Energization

Index	Name	Num	Min	Max	Default	Unit	Reso	Handling Type	Data Type
2.6.5.1	Filter Voltage Ramp Time	5161	0.0	10000.0	0.1	s	0.01	Config	REAL

Index	Name	Num	Min	Max	Default	Unit	Reso	Handling Type	Data Type
2.6.5.2	Max. Filter Energization Time	5162	0.1	50.0	10.0	s	0.1	Config	REAL

6.3.7 Control Places

6.3.7.1 Control Place Settings

Index	Name	Num	Min	Max	Default	Unit	Reso	Handling Type	Data Type
2.7.1.1	Control Place Selection	114	1	3	3		1	Config	UINT
2.7.1.2	Force FB Control Input	4511	0	29999	0		1	Config	UINT
2.7.1.3	Force I/O Control Input	4513	0	29999	0		1	Config	UINT
2.7.1.4	Control Place Forcing Mode	1972	0	3	0		1	Config	UINT
2.7.1.5	Control Place Independent Reset	109	0	1	0		1	Config	BOOL
2.7.1.6	Control Place Release Mode	4800	0	1	1		1	Config	BOOL
2.7.1.7	Control Place Forcing Priority	4732	1	3	[1,3,2]		1	Config	UINT

6.3.7.2 Local Control

Index	Name	Num	Min	Max	Default	Unit	Reso	Handling Type	Data Type
2.7.2.1	Local Control Mode	107	0	2	0		1	Config	UINT
2.7.2.2	Continue Operation in Local Control	108	0	1	0		1	Config	BOOL

6.3.7.3 I/O Control

Index	Name	Num	Min	Max	Default	Unit	Reso	Handling Type	Data Type
2.7.3.1	I/O Start Input	200	0	29999	0		1	Config	UINT
2.7.3.2	I/O Stop Input	201	0	29999	1		1	Config	UINT
2.7.3.3	I/O Reset Input	203	0	29999	0		1	Config	UINT
2.7.3.4	I/O Start Mode	213	0	2	0		1	Config	UINT
2.7.3.5	Continue Operation in I/O Control	5111	0	1	0		1	Config	BOOL

6.3.7.4 Fieldbus Control

Index	Name	Num	Min	Max	Default	Unit	Reso	Handling Type	Data Type
2.7.4.1	Continue Operation in Fieldbus Control	5112	0	1	0		1	Config	BOOL
2.7.4.2	Fieldbus Start Mode	5114	0	1	1		1	Config	UINT

6.3.8 Converter Control

6.3.8.1 Modulation

Index	Name	Num	Min	Max	Default	Unit	Reso	Handling Type	Data Type
2.8.1.1	Switching Frequency	2920	-1.67e+8	16777216.0	1000.0	kHz	0.01	Config	REAL
2.8.1.2	Modulator Options	5093	0x0	0xffff	0x0		1	Config	WORD
2.8.1.3	Modulator Type	5100	1	6	1		1	Config	UDINT

6.3.8.2 Advanced Grid Control

Index	Name	Num	Min	Max	Default	Unit	Reso	Handling Type	Data Type
2.8.2.1	Active Current Kp	2868	0.0	1000.0	100.0	%	0.01	Config	REAL
2.8.2.2	Active Current Ti	2869	0.0	1000.0	100.0	%	0.01	Config	REAL
2.8.2.3	Grid PLL Tc	9659	0.01	1.0	0.1	s	0.01	Config	REAL
2.8.2.4	Active Damping Kp	2871	0.0	10000.0	100.0	%	0.01	Config	REAL
2.8.2.5	Reactive Current Kp	2849	0.001	1000.0	100.0	%	1	Config	REAL
2.8.2.6	Reactive Current Ti	2850	0.0	1000.0	100.0	%	1	Config	REAL
2.8.2.7	Grid Control Options	9658	0x0	0xffff	0x0		1	Config	WORD
2.8.2.8	Paralleling Sync. Run Kp	9655	0.0	1000.0	0.1		0.01	Config	REAL
2.8.2.9	Paralleling Sync. Stop Kp	9656	0.0	1000.0	0.4		0.01	Config	REAL
2.8.2.10	Paralleling Sync. Shift Kp	9657	0.0	1000.0	100.0	%	0.01	Config	REAL
2.8.2.11	Harmonic Current Control Gain	6519	0.0	1000.0	0.0	%	0.01	Config	REAL

6.3.8.3 Advanced DC-link Control

Index	Name	Num	Min	Max	Default	Unit	Reso	Handling Type	Data Type
2.8.3.1	DC-link Voltage Ctrl. Kp	2902	0.0	1000.0	100.0	%	0.01	Config	REAL
2.8.3.2	DC-link Voltage Ctrl. Ti	2903	0.0	1000.0	100.0	%	0.01	Config	REAL
2.8.3.3	DC-link Voltage Ctrl. Td	2907	0.0	1000.0	100.0	%	0.01	Config	REAL
2.8.3.4	DC-link Voltage Droop. Tc	5095	0.0	1.0	0.05	s	0.01	Config	REAL

6.3.8.4 Power Unit Settings

Index	Name	Num	Min	Max	Default	Unit	Reso	Handling Type	Data Type
2.8.4.1	Power Unit Enable Mask	2835	0x0	0xffff	0xffff		1	Config	WORD
2.8.4.2	DC-link Voltage Measurement Corr. Gain	6535	-1.0	1.0	0.0	%	0.01	Config	REAL
2.8.4.3	DC-link Voltage Measurement Corr. Offset	6534	-5.0	5.0	0.0	V	0.01	Config	REAL
2.8.4.4	HF DC-link Filter Mode	2944	0	2	2		1	Config	UINT

6.3.8.5 Cooling Fan Control

Index	Name	Num	Min	Max	Default	Unit	Reso	Handling Type	Data Type
2.8.5.1	Main Fan Minimum Speed	2932	0.0	100.0	0.0	%	0.1	Config	REAL

6.3.8.6 LCL-Filter

Index	Name	Num	Min	Max	Default	Unit	Reso	Handling Type	Data Type
2.8.6.1	LCL Filter L1	2904	0.0	1.0	0.000104	μH	0.01	Config	REAL
2.8.6.2	LCL Filter Cf	2905	0.0	1.0	0.0000825	μF	0.01	Config	REAL
2.8.6.3	LCL Filter L2	2906	0.0	1.0	0.00004	μH	0.01	Config	REAL

6.3.9 Protections and Responses

6.3.9.1 General Settings

Index	Name	Num	Min	Max	Default	Unit	Reso	Handling Type	Data Type
2.9.1.1	Retry after Fault	2927	0	1	1		1	Config	BOOL

6.3.9.2 Misc. Responses

Index	Name	Num	Min	Max	Default	Unit	Reso	Handling Type	Data Type
2.9.2.1	DC-link Voltage Ripple Response	2929	0	2	1		1	Config	UDINT
2.9.2.2	LCL Fan Fail Response	2941	0	11	10		1	Config	UINT

6.3.9.3 External Event

Index	Name	Num	Min	Max	Default	Unit	Reso	Handling Type	Data Type
2.9.3.1	External Event 1 Input	4557	0	29999	0		1	Config	UINT
2.9.3.2	External Event 1 Response	4559	0	11	10		1	Config	UINT
2.9.3.3	External Event 2 Input	4560	0	29999	0		1	Config	UINT
2.9.3.4	External Event 2 Response	4562	0	11	10		1	Config	UINT

6.3.9.4 Cooling Monitor

Index	Name	Num	Min	Max	Default	Unit	Reso	Handling Type	Data Type
2.9.4.1	Cooling Monitor Input	2400	0	29999	1		1	Config	UINT
2.9.4.2	Cooling Monitor Fault Delay	2401	0.0	300.0	10.0	s	0.01	Config	REAL
2.9.4.3	Cooling Monitor Response	2402	0	3	0		1	Config	UINT

6.3.9.5 Measured Temp. Protection

6.3.9.5.1 Temp. 1 Protection

Index	Name	Num	Min	Max	Default	Unit	Reso	Handling Type	Data Type
2.9.5.1.1	Temp. 1 Input	5206	0	29999	0		1	Config	UINT
2.9.5.1.2	Temp. 1 Limit 1	5207	-300.0	300.0	120.0	°C	0.01	Config	REAL
2.9.5.1.3	Temp. 1 Limit 2	5208	-300.0	300.0	150.0	°C	0.01	Config	REAL
2.9.5.1.4	Temp. 1 Limit 2 Response	5209	3	11	11		1	Config	UINT

6.3.9.5.2 Temp. 2 Protection

Index	Name	Num	Min	Max	Default	Unit	Reso	Handling Type	Data Type
2.9.5.2.1	Temp. 2 Input	5210	0	29999	0		1	Config	UINT
2.9.5.2.2	Temp. 2 Limit 1	5211	-300.0	300.0	120.0	°C	0.01	Config	REAL
2.9.5.2.3	Temp. 2 Limit 2	5212	-300.0	300.0	150.0	°C	0.01	Config	REAL
2.9.5.2.4	Temp. 2 Limit 2 Response	5213	3	11	11		1	Config	UINT

6.3.9.5.3 Temp. 3 Protection

Index	Name	Num	Min	Max	Default	Unit	Reso	Handling Type	Data Type
2.9.5.3.1	Temp. 3 Input	5214	0	29999	0		1	Config	UINT
2.9.5.3.2	Temp. 3 Limit 1	5215	-300.0	300.0	120.0	°C	0.01	Config	REAL
2.9.5.3.3	Temp. 3 Limit 2	5216	-300.0	300.0	150.0	°C	0.01	Config	REAL
2.9.5.3.4	Temp. 3 Limit 2 Response	5217	3	11	11		1	Config	UINT

6.3.9.5.4 Temp. 4 Protection

Index	Name	Num	Min	Max	Default	Unit	Reso	Handling Type	Data Type
2.9.5.4.1	Temp. 4 Input	5218	0	29999	0		1	Config	UINT
2.9.5.4.2	Temp. 4 Limit 1	5219	-300.0	300.0	120.0	°C	0.01	Config	REAL
2.9.5.4.3	Temp. 4 Limit 2	5220	-300.0	300.0	150.0	°C	0.01	Config	REAL
2.9.5.4.4	Temp. 4 Limit 2 Response	5221	3	11	11		1	Config	UINT

6.3.9.5.5 Temp. 5 Protection

Index	Name	Num	Min	Max	Default	Unit	Reso	Handling Type	Data Type
2.9.5.5.1	Temp. 5 Input	5222	0	29999	0		1	Config	UINT
2.9.5.5.2	Temp. 5 Limit 1	5223	-300.0	300.0	120.0	°C	0.01	Config	REAL
2.9.5.5.3	Temp. 5 Limit 2	5224	-300.0	300.0	150.0	°C	0.01	Config	REAL
2.9.5.5.4	Temp. 5 Limit 2 Response	5225	3	11	11		1	Config	UINT

6.3.9.5.6 Temp. 6 Protection

Index	Name	Num	Min	Max	Default	Unit	Reso	Handling Type	Data Type
2.9.5.6.1	Temp. 6 Input	5226	0	29999	0		1	Config	UINT
2.9.5.6.2	Temp. 6 Limit 1	5227	-300.0	300.0	120.0	°C	0.01	Config	REAL
2.9.5.6.3	Temp. 6 Limit 2	5228	-300.0	300.0	150.0	°C	0.01	Config	REAL
2.9.5.6.4	Temp. 6 Limit 2 Response	5229	3	11	11		1	Config	UINT

6.3.9.5.7 Temp. 7 Protection

Index	Name	Num	Min	Max	Default	Unit	Reso	Handling Type	Data Type
2.9.5.7.1	Temp. 7 Input	5239	0	29999	0		1	Config	UINT
2.9.5.7.2	Temp. 7 Limit 1	5243	-300.0	300.0	120.0	°C	1	Config	REAL
2.9.5.7.3	Temp. 7 Limit 2	5269	-300.0	300.0	150.0	°C	1	Config	REAL
2.9.5.7.4	Temp. 7 Limit 2 Response	5235	3	11	11		1	Config	UINT

6.3.9.5.8 Temp. 8 Protection

Index	Name	Num	Min	Max	Default	Unit	Reso	Handling Type	Data Type
2.9.5.8.1	Temp. 8 Input	5240	0	29999	0		1	Config	UINT
2.9.5.8.2	Temp. 8 Limit 1	5247	-300.0	300.0	120.0	°C	1	Config	REAL
2.9.5.8.3	Temp. 8 Limit 2	5270	-300.0	300.0	150.0	°C	1	Config	REAL
2.9.5.8.4	Temp. 8 Limit 2 Response	5236	3	11	11		1	Config	UINT

6.3.9.5.9 Temp. 9 Protection

Index	Name	Num	Min	Max	Default	Unit	Reso	Handling Type	Data Type
2.9.5.9.1	Temp. 9 Input	5241	0	29999	0		1	Config	UINT
2.9.5.9.2	Temp. 9 Limit 1	5249	-300.0	300.0	120.0	°C	1	Config	REAL
2.9.5.9.3	Temp. 9 Limit 2	5271	-300.0	300.0	150.0	°C	1	Config	REAL
2.9.5.9.4	Temp. 9 Limit 2 Response	5237	3	11	11		1	Config	UINT

6.3.9.5.10 Temp. 10 Protection

Index	Name	Num	Min	Max	Default	Unit	Reso	Handling Type	Data Type
2.9.5.10.1	Temp. 10 Input	5242	0	29999	0		1	Config	UINT
2.9.5.10.2	Temp. 10 Limit 1	5268	-300.0	300.0	120.0	°C	1	Config	REAL
2.9.5.10.3	Temp. 10 Limit 2	5272	-300.0	300.0	150.0	°C	1	Config	REAL
2.9.5.10.4	Temp. 10 Limit 2 Response	5238	3	11	11		1	Config	UINT

6.3.9.5.11 Common

Index	Name	Num	Min	Max	Default	Unit	Reso	Handling Type	Data Type
2.9.5.11.1	Meas. Valid Range	5230	-300.0	300.0	[200,-50]	°C	0.01	Config	REAL
2.9.5.11.2	Meas. Out of Range Response	5231	0	11	3		1	Config	UINT

6.3.9.6 Thermistor Monitoring

Index	Name	Num	Min	Max	Default	Unit	Reso	Handling Type	Data Type
2.9.6.1	Thermistor Monitoring Response	5232	0	11	10		1	Config	UINT
2.9.6.2	Thermistor Monitor 1 Input	1520	0	29999	0		1	Config	UINT
2.9.6.3	Thermistor Monitor 2 Input	1522	0	29999	0		1	Config	UINT
2.9.6.4	Thermistor Monitor 3 Input	1524	0	29999	0		1	Config	UINT

6.3.9.7 Fieldbus Protections

Index	Name	Num	Min	Max	Default	Unit	Reso	Handling Type	Data Type
2.9.7.1	Fieldbus Fault Response	1304	0	11	10		1	Config	UINT
2.9.7.2	No Fieldbus Connection Response	1305	0	11	0		1	Config	UINT
2.9.7.3	Process Data Timeout Response	1306	1	11	1		1	Config	UINT
2.9.7.4	Process Data Timeout Delay	1340	50.0	3.4e+38	1000.0	s	0.01	Config	REAL
2.9.7.5	Fieldbus Watchdog Response	5244	0	11	3		1	Config	UINT
2.9.7.6	Fieldbus Watchdog Delay	5245	0.0	3000.0	5.0	s	0.01	Config	REAL
2.9.7.7	Fieldbus Watchdog Start Delay	5246	0.0	3000.0	30.0	s	0.01	Config	REAL

6.3.9.8 HMI Connection Loss

Index	Name	Num	Min	Max	Default	Unit	Reso	Handling Type	Data Type
2.9.8.1	HMI Connection Loss	5420	0	11	10		1	Config	UINT

6.3.9.9 Cooling Fan Supervision

Index	Name	Num	Min	Max	Default	Unit	Reso	Handling Type	Data Type
2.9.9.1	Main Fan Fail Response	2939	0	11	3		1	Config	UINT
2.9.9.2	Internal Fan Fail Response	2940	0	11	3		1	Config	UINT

6.3.9.10 Grid Frequency Supervision

Index	Name	Num	Min	Max	Default	Unit	Reso	Handling Type	Data Type
2.9.10.1	High Freq. Instant Fault Limit	2840	0.0	590.0	66.0	Hz	0.01	Config	REAL
2.9.10.2	Low Freq. Instant Fault Limit	2841	0.0	590.0	45.0	Hz	0.01	Config	REAL

6.3.9.11 Grid Voltage Supervision

Index	Name	Num	Min	Max	Default	Unit	Reso	Handling Type	Data Type
2.9.11.1	Grid Overvoltage Instant Fault Limit	2842	-1000.0	1000.0	115.0	%	0.01	Config	REAL
2.9.11.2	Grid Undervoltage Instant Fault Limit	2843	-1000.0	1000.0	80.0	%	0.01	Config	REAL

6.3.9.12 Missing Grid Phase

Index	Name	Num	Min	Max	Default	Unit	Reso	Handling Type	Data Type
2.9.12.1	Phase Fault Limit Run	266	0.0	100.0	10.0	%	0.01	Config	REAL
2.9.12.2	Phase Fault Limit Stop	264	0.0	100.0	60.0	%	0.01	Config	REAL
2.9.12.3	Phase Fault Delay	265	0.0	100.0	0.1	s	0.01	Config	REAL

6.3.9.13 Pre Charge Monitoring

Index	Name	Num	Min	Max	Default	Unit	Reso	Handling Type	Data Type
2.9.13.1	Max. Pre-Charge Time	6564	5.0	50.0	20.0	s	0.01	Config	REAL
2.9.13.2	Min. Pre-Charge Time	6565	0.0	5.0	0.5	s	0.01	Config	REAL
2.9.13.3	Ext. Pre-Charge Monitor Response	6568	0	11	0		1	Config	UINT

6.3.9.14 Input Section Over Temperature

Index	Name	Num	Min	Max	Default	Unit	Reso	Handling Type	Data Type
2.9.14.1	Input Section Overtemp. Input	5310	0	29999	1		1	Config	UINT
2.9.14.2	Input Section Overtemp. Response	5311	0	10	3		1	Config	UINT

6.4 Maintenance & Service

6.4.1 Software Information

Index	Name	Num	Min	Max	Default	Unit	Reso	Handling Type	Data Type
3.1.1	Application Version	151					1	Config	STRING

6.4.2 Events

6.4.2.1 Event Simulation

Index	Name	Num	Min	Max	Default	Unit	Reso	Handling Type	Data Type
3.2.1.1	Simulate Persisting Event	1401	0	10	0		1	Config	UINT
3.2.1.2	Simulate Event Number	1402	0	65535	5260		1	Config	UINT

6.4.3 Operational Counters

Index	Name	Num	Min	Max	Default	Unit	Reso	Handling Type	Data Type
3.3.1	Control Unit On Time	2000	0	4.29e+9	0	h	1	Process	UDINT
3.3.2	Power Unit On Time	2001	0	4.29e+9	0	h	1	Process	UDINT
3.3.3	Energy Consumption	2002	-	-	-	kWh	1	Process	ULINT
3.3.4	Ground Faults	2004	0	50000	0		1	Process	UINT
3.3.5	Overvoltage Faults	2005	0	50000	0		1	Process	UINT
3.3.6	Overcurrent Faults	2006	0	50000	0		1	Process	UINT
3.3.7	Short Circuit Faults	2007	0	50000	0		1	Process	UINT

6.4.4 Backup & Restore

6.4.4.1 Backup

This is a menu screen for creating parameter backups from the control panel. With MyDrive® Insight, similar options are available via the “Backup” button within the “Parameters” screen. Check the available settings via the control panel or MyDrive® Insight.

6.4.4.2 Restore

This is a menu for restoring parameter backups from the control panel. With MyDrive® Insight, similar options are available via the “Restore” button within the “Parameters” screen. Check the available settings via the control panel or MyDrive® Insight.

6.5 Customization

6.5.1 Basic Settings

Index	Name	Num	Min	Max	Default	Unit	Reso	Handling Type	Data Type
5.1.1	Date and Time	2800	-	-	-		1	Config	DATE_AND_TIME

6.5.2 Control Panel

6.5.2.1 Readout Screen 1

Index	Name	Num	Min	Max	Default	Unit	Reso	Handling Type	Data Type
5.2.1.1	Readout Field 1.1	305	0	4.29e+9	9044		1	Config	UDINT
5.2.1.2	Readout Field 1.2	301	0	4.29e+9	0		1	Config	UDINT

Index	Name	Num	Min	Max	Default	Unit	Reso	Handling Type	Data Type
5.2.1.3	Readout Field 1.3	302	0	4.29e+9	0		1	Config	UDINT
5.2.1.4	Readout Field 1.4	303	0	4.29e+9	0		1	Config	UDINT
5.2.1.5	Readout Field 1.5	304	0	4.29e+9	0		1	Config	UDINT

6.5.2.2 Readout Screen 2

Index	Name	Num	Min	Max	Default	Unit	Reso	Handling Type	Data Type
5.2.2.1	Readout Field 2.1	310	0	4.29e+9	9044		1	Config	UDINT
5.2.2.2	Readout Field 2.2	311	0	4.29e+9	9040		1	Config	UDINT
5.2.2.3	Readout Field 2.3	312	0	4.29e+9	9041		1	Config	UDINT
5.2.2.4	Readout Field 2.4	313	0	4.29e+9	2950		1	Config	UDINT
5.2.2.5	Readout Field 2.5	314	0	4.29e+9	2952		1	Config	UDINT

6.6 Option Board Settings

6.6.1 I/O and Relay

This group and its subgroups appear only if an I/O And Relay OC7C1 option is included in the converter. This menu appears as many times as there are these options in the system. Each menu and its parameters have the suffix of their option slot.

6.6.1.1 I/O and Relay Status

Index	Name	Num	Min	Max	Default	Unit	Reso	Handling Type	Data Type
9.3.1	Digital Input Bit Word	1614	0x0	0xffff	0x0		1	Process	WORD
9.3.2	Digital Output Bit Word	1615	0x0	0xffff	0x0		1	Process	WORD
9.3.3	T31 Analog Output Value	1613	-20.0	20.0	0.0		0.01	Process	REAL
9.3.4	T33 Analog Input Value	1611	-20.0	20.0	0.0		0.01	Process	REAL
9.3.5	T34 Analog Input Value	1612	-20.0	20.0	0.0		0.01	Process	REAL

6.6.1.2 Digital Inputs/Outputs

6.6.1.2.1 Input T13

Index	Name	Num	Min	Max	Default	Unit	Reso	Handling Type	Data Type
9.4.1.1	T13 Terminal Mode	2015	0	3	0		1	Config	UINT
9.4.1.2	T13 Signal Inversion	2291	0	1	0		1	Config	UINT
9.4.1.3	T13 Standard Debounce Filtering Time	2024	0.0	0.1	0.0	ms	1	Config	REAL

6.6.1.2.2 Input T14

Index	Name	Num	Min	Max	Default	Unit	Reso	Handling Type	Data Type
9.4.2.1	T14 Terminal Mode	2016	0	3	0		1	Config	UINT

Index	Name	Num	Min	Max	Default	Unit	Reso	Handling Type	Data Type
9.4.2.2	T14 Signal Inversion	2292	0	1	0		1	Config	UINT
9.4.2.3	T14 Standard Debounce Filtering Time	2029	0.0	0.1	0.0	ms	1	Config	REAL

6.6.1.2.3 Input T15

Index	Name	Num	Min	Max	Default	Unit	Reso	Handling Type	Data Type
9.4.3.1	T15 Terminal Mode	2022	0	3	0		1	Config	UINT
9.4.3.2	T15 Signal Inversion	2295	0	1	0		1	Config	UINT
9.4.3.3	T15 Standard Debounce Filtering Time	2297	0.0	0.1	0.0	ms	1	Config	REAL

6.6.1.2.4 Input T16

Index	Name	Num	Min	Max	Default	Unit	Reso	Handling Type	Data Type
9.4.4.1	T16 Terminal Mode	2298	0	3	0		1	Config	UINT
9.4.4.2	T16 Signal Inversion	2296	0	1	0		1	Config	UINT
9.4.4.3	T16 Standard Debounce Filtering Time	2260	0.0	0.1	0.0	ms	1	Config	REAL

6.6.1.2.5 Input T17

Index	Name	Num	Min	Max	Default	Unit	Reso	Handling Type	Data Type
9.4.5.1	T17 Terminal Mode	2017	0	3	0		1	Config	UINT
9.4.5.2	T17 Signal Inversion	2293	0	1	0		1	Config	UINT
9.4.5.3	T17 Standard Debounce Filtering Time	2034	0.0	0.1	0.0	ms	1	Config	REAL

6.6.1.2.6 Input T18

Index	Name	Num	Min	Max	Default	Unit	Reso	Handling Type	Data Type
9.4.6.1	T18 Terminal Mode	2018	0	3	0		1	Config	UINT
9.4.6.2	T18 Signal Inversion	2294	0	1	0		1	Config	UINT
9.4.6.3	T18 Standard Debounce Filtering Time	2039	0.0	0.1	0.0	ms	1	Config	REAL

6.6.1.2.7 Output T21

Index	Name	Num	Min	Max	Default	Unit	Reso	Handling Type	Data Type
9.4.7.1	T21 Terminal Mode	4015	0	1	0		1	Config	UINT
9.4.7.2	T21 Digital Output Type	4013	0	3	3		1	Config	UINT

6.6.1.2.8 Output T22

Index	Name	Num	Min	Max	Default	Unit	Reso	Handling Type	Data Type
9.4.8.1	T22 Terminal Mode	4016	0	1	0		1	Config	UINT
9.4.8.2	T22 Digital Output Type	4014	0	3	3		1	Config	UINT

6.6.1.3 Analog Inputs/Outputs

6.6.1.3.1 Output T31

Index	Name	Num	Min	Max	Default	Unit	Reso	Handling Type	Data Type
9.5.1.1	T31 Terminal Mode	2019	0	5	0		1	Config	UINT
9.5.1.2	T31 Terminal Type	2284	0	2	1		1	Config	UINT
9.5.1.3	T31 Minimum Value	2283	-20.0	20.0	0.0		0.01	Config	REAL
9.5.1.4	T31 Maximum Value	2282	-20.0	20.0	10.0		0.01	Config	REAL

6.6.1.3.2 Input T33

Index	Name	Num	Min	Max	Default	Unit	Reso	Handling Type	Data Type
9.5.2.1	T33 Terminal Mode	2020	0	6	0		1	Config	UINT
9.5.2.2	T33 Terminal Type	2273	1	2	1		0.01	Config	UINT
9.5.2.3	T33 Minimum Value	2272	-20.0	20.0	0.0		0.01	Config	REAL
9.5.2.4	T33 Maximum Value	2271	-20.0	20.0	10.0		0.01	Config	REAL
9.5.2.5	T33 Filter Time	2270	0.0	60.0	0.0	ms	1	Config	REAL
9.5.2.6	T33 Live Zero Threshold Value	2274	-20.0	20.0	-10.0		0.01	Config	REAL
9.5.2.7	T33 Live Zero Timeout Value	2275	0.0	60.0	0.0	s	0.01	Config	REAL

6.6.1.3.3 Input T34

Index	Name	Num	Min	Max	Default	Unit	Reso	Handling Type	Data Type
9.5.3.1	T34 Terminal Mode	2021	0	6	0		1	Config	UINT
9.5.3.2	T34 Terminal Type	2279	1	2	1		0.01	Config	UINT
9.5.3.3	T34 Minimum Value	2278	-20.0	20.0	0.0		0.01	Config	REAL
9.5.3.4	T34 Maximum Value	2277	-20.0	20.0	10.0		0.01	Config	REAL
9.5.3.5	T34 Filter Time	2276	0.0	60.0	0.0	ms	1	Config	REAL
9.5.3.6	T34 Live Zero Threshold Value	2280	-20.0	20.0	-10.0		0.01	Config	REAL
9.5.3.7	T34 Live Zero Timeout Value	2281	0.0	60.0	0.0	s	0.01	Config	REAL

6.6.2 Temperature Measurement

This group and its subgroups appear only if a Temperature Measurement OC7T0 option is included in the converter. This menu appears as many times as there are these options in the system. Each menu and its parameters have the suffix of their option slot.

6.6.2.1 Temperature Measurement Status

Index	Name	Num	Min	Max	Default	Unit	Reso	Handling Type	Data Type
9.3.2	T4 Temperature Value	4040	-1000.0	1000.0	0.0	°C	1	Process	REAL
9.3.3	T8 Temperature Value	4041	-1000.0	1000.0	0.0	°C	1	Process	REAL
9.3.4	T12 Temperature Value	4042	-1000.0	1000.0	0.0	°C	1	Process	REAL
9.3.5	T16 Temperature Value	4043	-1000.0	1000.0	0.0	°C	1	Process	REAL
9.3.6	T20 Temperature Value	4044	-1000.0	1000.0	0.0	°C	1	Process	REAL

6.6.2.2 Temperature Inputs

6.6.2.2.1 Input T4

Index	Name	Num	Min	Max	Default	Unit	Reso	Handling Type	Data Type
9.4.1.1	T4 Terminal Mode	4045	0	7	0		1	Config	UINT
9.4.1.2	T4 Connection Type	4046	0	4	0		1	Config	UINT
9.4.1.3	T4 Temperature Sensor Type	4047	0	19	0		1	Config	UINT
9.4.1.4	T4 Offset	4048	-50.0	50.0	0.0	°C	1	Config	REAL

6.6.2.2.2 Input T8

Index	Name	Num	Min	Max	Default	Unit	Reso	Handling Type	Data Type
9.4.2.1	T8 Terminal Mode	4049	0	7	0		1	Config	UINT
9.4.2.2	T8 Connection Type	4050	0	4	0		1	Config	UINT
9.4.2.3	T8 Temperature Sensor Type	4051	0	19	0		1	Config	UINT
9.4.2.4	T8 Offset	4052	-50.0	50.0	0.0	°C	1	Config	REAL

6.6.2.2.3 Input T12

Index	Name	Num	Min	Max	Default	Unit	Reso	Handling Type	Data Type
9.4.3.1	T12 Terminal Mode	4053	0	7	0		1	Config	UINT
9.4.3.2	T12 Connection Type	4054	0	4	0		1	Config	UINT
9.4.3.3	T12 Temperature Sensor Type	4055	0	19	0		1	Config	UINT
9.4.3.4	T12 Offset	4056	-50.0	50.0	0.0	°C	1	Config	REAL

6.6.2.2.4 Input T16

Index	Name	Num	Min	Max	Default	Unit	Reso	Handling Type	Data Type
9.4.4.1	T16 Terminal Mode	2298	0	7	0		1	Config	UINT
9.4.4.2	T16 Connection Type	4058	0	4	0		1	Config	UINT
9.4.4.3	T16 Temperature Sensor Type	4059	0	19	0		1	Config	UINT
9.4.4.4	T16 Offset	4060	-50.0	50.0	0.0	°C	1	Config	REAL

6.6.2.2.5 Input T20

Index	Name	Num	Min	Max	Default	Unit	Reso	Handling Type	Data Type
9.4.5.1	T20 Terminal Mode	4017	0	7	0		1	Config	UINT
9.4.5.2	T20 Connection Type	4062	0	4	0		1	Config	UINT
9.4.5.3	T20 Temperature Sensor Type	4063	0	19	0		1	Config	UINT
9.4.5.4	T20 Offset	4064	-50.0	50.0	0.0	°C	1	Config	REAL

6.6.3 Voltage Measurement

This group and its subgroups appear only if a Voltage Measurement OC7V0 option is included in the converter. This menu appears as many times as there are these options in the system. Each menu and its parameters have the suffix of their option slot.

6.6.3.1 Voltage Measurement Status

Index	Name	Num	Min	Max	Default	Unit	Reso	Handling Type	Data Type
9.3.1	X52 Voltage	4086	0.0	10000.0	0.0	V	0.1	Process	REAL
9.3.2	X52 Frequency	4087	-400.0	400.0	0.0	Hz	0.01	Process	REAL
9.3.3	X52 Phase Diff.	4088	-180.0	180.0	0.0	°	1	Process	REAL
9.3.4	X52 Voltage L1	4082	-10000.0	10000.0	0.0	V	0.1	Process	REAL
9.3.5	X52 Voltage L3	4083	-10000.0	10000.0	0.0	V	0.1	Process	REAL
9.3.6	X53 Voltage	4089	0.0	10000.0	0.0	V	0.1	Process	REAL
9.3.7	X53 Frequency	4090	-400.0	400.0	0.0	Hz	0.01	Process	REAL
9.3.8	X53 Phase Diff.	4091	-180.0	180.0	0.0	°	1	Process	REAL
9.3.9	X53 Voltage L1	4084	-10000.0	10000.0	0.0	V	0.1	Process	REAL
9.3.10	X53 Voltage L3	4085	-10000.0	10000.0	0.0	V	0.1	Process	REAL

6.6.3.2 Voltage Input X52

Index	Name	Num	Min	Max	Default	Unit	Reso	Handling Type	Data Type
9.4.1	X52 Terminal Mode	4099	0	2	0		1	Config	UINT
9.4.2	X52 Terminal Voltage Range	4100	1.0	3.4e+38	1.0	V	0.1	Config	REAL

Index	Name	Num	Min	Max	Default	Unit	Reso	Handling Type	Data Type
9.4.3	X52 Meas. Transformer Grid-Side Voltage	4101	1.0	1e+05	1.0	V	0.1	Config	REAL
9.4.4	X52 Meas. Transformer Converter-Side Voltage	4102	1.0	1000.0	1.0	V	0.1	Config	REAL
9.4.5	X52 Meas. Transformer Phase Shift	4103	-180.0	180.0	0.0	°	1	Config	REAL

6.6.3.3 Voltage Input X53

Index	Name	Num	Min	Max	Default	Unit	Reso	Handling Type	Data Type
9.5.1	X53 Terminal Mode	4104	0	2	0		1	Config	UINT
9.5.2	X53 Terminal Voltage Range	4105	1.0	3.4e+38	1.0	V	0.1	Config	REAL
9.5.3	X53 Meas. Transformer Grid-Side Voltage	4106	1.0	1e+05	1.0	V	0.1	Config	REAL
9.5.4	X53 Meas. Transformer Converter-Side Voltage	4107	1.0	1000.0	1.0	V	0.1	Config	REAL
9.5.5	X53 Meas. Transformer Phase Shift	4108	-180.0	180.0	0.0	°	1	Config	REAL

6.7 Connectivity

6.7.1 Integrated Communication

6.7.1.1 Communication interfaces

6.7.1.1.1 Host Settings

Index	Name	Num	Min	Max	Default	Unit	Reso	Handling Type	Data Type
10.2.1.1	Fully Qualified Domain Name	7036	-	-	-		1	Config	STRING

6.7.1.1.2 Ethernet Interface X0

6.7.1.1.2.1 IPv4 Settings

This is a menu screen for enabling IP configuration of the X0 interface. Check the available settings via the control panel or MyDrive® Insight.

6.7.1.1.2.2 IPv4 Status

This is a menu screen containing information about the IP configuration of the X0 interface. Check the available information via the control panel or MyDrive® Insight.

6.7.1.1.3 Ethernet Interface X1/X2 Settings

6.7.1.1.3.1 IPv4 Settings

This is a menu screen for enabling IP configuration of the X1/X2 interface. Check the available settings via the control panel or MyDrive® Insight.

6.7.1.1.3.2 IPv4 Status

This is a menu screen containing information about the IP configuration of the X1/X2 interface. Check the available information via the control panel or MyDrive® Insight.

6.7.1.1.4 Ethernet port X0

6.7.1.1.4.1 X0 Settings

Index	Name	Num	Min	Max	Default	Unit	Reso	Handling Type	Data Type
10.2.4.2.5	Link configuration X0	7047	0	4	0		1	Config	USINT

6.7.1.1.5 Ethernet port X1

6.7.1.1.5.1 X1 Settings

Index	Name	Num	Min	Max	Default	Unit	Reso	Handling Type	Data Type
10.2.5.2.5	Link Configuration X1	7048	0	4	0		1	Config	USINT

6.7.1.1.6 Ethernet port X2

6.7.1.1.6.1 X2 Settings

Index	Name	Num	Min	Max	Default	Unit	Reso	Handling Type	Data Type
10.2.6.2.5	Link Configuration X1	7049	0	4	0		1	Config	USINT

6.7.1.1.7 Port Mirroring

This is a menu screen for enabling and disabling the port-mirroring function for network troubleshooting with a network analyzer tool. Check the available configurations via the control panel or MyDrive® Insight.

6.7.1.2 Protocols

6.7.1.2.1 PROFINET®

6.7.1.2.1.1 Status

6.7.1.2.1.1.1 PROFINET® Report

This is the PROFINET® report screen showing active PROFINET® connection and configuration information. Check the available information via the control panel or MyDrive® Insight.

6.7.1.2.1.2 Configuration

Index	Name	Num	Min	Max	Default	Unit	Reso	Handling Type	Data Type
10.3.2.2.1	Name of Station	7080	-	-	-		1	Config	STRING

6.7.1.2.1.3 Diagnosis

Index	Name	Num	Min	Max	Default	Unit	Reso	Handling Type	Data Type
10.3.2.3.1	Diagnostic Fault	7081	0	1	1		1	Config	BOOL
10.3.2.3.2	Diagnostic Warning	7083	0	1	1		1	Config	BOOL

6.7.1.2.2 Modbus® TCP

6.7.1.2.2.1 Configuration

Index	Name	Num	Min	Max	Default	Unit	Reso	Handling Type	Data Type
10.3.3.2.1	Persistent Storage	7061	0	1	0		1	Config	BOOL
10.3.3.2.3	Byte Order	7062	0	1	0		1	Config	USINT
10.3.3.2.4	Word Order	7063	0	1	1		1	Config	USINT

7 Parameter Descriptions

7.1 How to Read Parameter Descriptions

The following chapters contain descriptions for all the parameters in the Active Front End application software. Each chapter represents a single subgroup within the menu structure.

First the group is described. After that all parameters are listed and described. If applicable, the parameter selections are listed in a table, containing further descriptions for each selection.

The following is an example of a parameter description:

P1.2.3^[1] Parameter Name^[2] No. 1234^[3]
 This is a parameter description.^[4]

Number	Name	Description
0 ^[5]	Name of selection 1 ^[6]	Description of selection 1. ^[7]
1	Name of selection 2	Description of selection 2.

[1]: The index number of the parameter, that is, the menu location.

[2]: Name of the parameter.

[3]: Unique identification number of the parameter.

[4]: Description of the parameter.

[5]: Selection number.

[6]: Selection name.

[7]: Description of the selection.

7.2 G1 Monitoring

This group contains readouts for monitoring the operation of the converter.

7.2.1 Basic Monitoring

This group contains readouts for monitoring the basic operation of the converter.

P1.1.1 Grid Voltage No. 9040

Shows grid line-to-line voltage (RMS) at the point of common coupling. If the converter is equipped with a voltage measurement option OC7V0, the voltage is measured via the option board. Otherwise, the voltage is measured from drive output terminals.

P1.1.2 Grid Frequency No. 9041

Shows the actual grid frequency. If the converter is equipped with a voltage measurement option OC7V0, the frequency is measured via the option board. Otherwise, the frequency is measured from drive output terminals.

P1.1.3 DC-Link Voltage No. 9044

Shows the actual DC-link voltage.

P1.1.4 Application Status Word 1 No. 6201

Shows the current status of the Application Status Word 1. The meaning of the bits is described in the following table.

Bit No.	Name	Description
0	Ready to Run	0: The unit is not ready to start modulation. 1: The unit is ready to start modulation.
1	Run	0: The unit is not running (modulating) 1: The unit is running (modulating)
2	Info	0: No info level event is active. 1: One or more info level events are active.
3	Warning	0: No warning level events are active. 1: One or more warning level events are active.
4	Fault	0: No fault level events are active. 1: One or more fault level events are active.
5	PC Control	0: The active control place is not PC. 1: The active control place is PC.
6	CP Control	0: The active control place is not the control panel. 1: The active control place is the control panel.
7	IO Control	0: The active control place is not I/O. 1: The active control place is I/O.
8	Fieldbus Control	0: The active control place is not fieldbus. 1: The active control place is fieldbus.
9	Reserved	--
10	Reserved	--
11	Run Enable	0: Run enable input is false. 1: Run enable input is true.
12	Start Active	0: Start command is not active. 1: Start command is active.
13	Quick Stop	0: Quick stop is not active. 1: Quick stop is active.
14...15	Reserved	--

P1.1.5 Application Status Word 2 No. 6202

Shows the current status of the Application Status Word 2. The meaning of the bits is described in the following table.

Bit No.	Name	Description
0	Toggled Info	0 (steady): No info level event is active. 1: One or more info level events are active. If a new info level event becomes active when this bit is high, it is lowered for one second before being raised again.

Bit No.	Name	Description
1	Toggled warning	0 (steady): No warning level event is active. 1: One or more warning level events are active. If a new warning level event becomes active when this bit is high, it is lowered for one second before being raised again.
2	Toggled Fault	0 (steady): No fault level event is active. 1: One or more fault level events are active. If a new fault level event becomes active when this bit is high, it is lowered for one second before being raised again.
3	Ready to Start Pre-Charge	0 (steady): Pre-charging is not allowed. 1: Pre-charging is allowed.
4	Ready to Close MCB	0 (steady): Closing the main circuit breaker is not allowed when DC Link pre-charging is complete. 1: Closing the main circuit breaker is allowed when DC Link pre-charging is complete.
5	Pre-Charge Detected	0 (steady): Pre-charging is not detected. 1: Pre-charging is detected.
6	Pre-Charge Command	0 (steady): The Pre-Charging relay output command is not active. 1: The Pre-Charging relay output command is active.
7	MCB Close Command	0 (steady): The main circuit breaker closing relay output command is not active. 1: The main circuit breaker closing relay output command is active.
8	MCB Feedback	0 (steady): The main circuit breaker is open. 1: The main circuit breaker is closed.
9	Switch Off Request	0 (steady): Switch off interlock is not active. 1: Switch off interlock is active.
10	Pre-Charge Ready	0: The unit is not pre-charged. 1: The unit is pre-charged.
11...15	Reserved	--

P1.1.6 Fault Status Word 1 **No. 6203**

Shows the fault status word 1. The meaning of the bits is described in the following table.

Bit No.	Name	Description
0	Over Current or IGBT Over Temperature	0: None of the listed fault level events are active. 1: At least one of the listed fault level events is active. Event list: events number 4356, 4370, 4110, 4125, all events in group number 8977.
1	DC Link Over Voltage	0: None of the listed fault level events are active. 1: At least one of the listed fault level events is active. Event list: events number 4144, 4145.

Bit No.	Name	Description
2	DC Link Under Voltage	0: None of the listed fault level events are active. 1: At least one of the listed fault level events is active. Event list: event number 4146.
3	Reserved	--
4	Unit Over Temperature	0: None of the listed fault level events are active. 1: At least one of the listed fault level events is active. Event list: events number 4103, 4104, 4105.
5	Reserved	--
6	Reserved	--
7	Reserved	--
8	Earth Fault	0: None of the listed fault level events are active. 1: At least one of the listed fault level events is active. Event list: all events in group number 9008.
9	Reserved	--
10	Fieldbus Error	0: None of the listed fault level events are active. 1: At least one of the listed fault level events is active. Event list: events number 5120, 5121.
11	HMI Connection Lost	0: None of the listed fault level events are active. 1: At least one of the listed fault level events is active. Event list: events number 5141, 5142.
12	Reserved	--
13	Reserved	--
14	Auxiliary Device Fault	0: None of the listed fault level events are active. 1: At least one of the listed fault level events is active. Event list: events number 4200, 4201, 4204, 4205.
15	Reserved	--

P1.1.7 Fault Status Word 2

No. 6204

Shows the Fault Status Word 2. The meaning of the bits is described in the following table.

Bit No.	Name	Description
0	Reserved	--
1	Pre-Charge Failed	0: None of the listed fault level events are active. 1: At least one of the listed fault level events is active. Event list: event number 5380.
2	MCB Feedback Error	0: None of the listed fault level events are active. 1: At least one of the listed fault level events is active. Event list: event number 5376.
3	Quick Stop Active	0: None of the listed fault level events are active. 1: At least one of the listed fault level events is active. Event list: event number 5130.

Bit No.	Name	Description
4	Thermistor Over Temperature	0: None of the listed fault level events are active. 1: At least one of the listed fault level events is active. Event list: events number 5143, 5144, 5145.
5	MCB Trip	0: None of the listed fault level events are active. 1: At least one of the listed fault level events is active. Event list: event number 5378.
6	External Event	0: None of the listed fault level events are active. 1: At least one of the listed fault level events is active. Event list: events number 5123, 5124.
7	Cooling Supervision Fault	0: None of the listed fault level events are active. 1: At least one of the listed fault level events is active. Event list: event number 1061.
8	Fieldbus Watchdog	0: None of the listed fault level events are active. 1: At least one of the listed fault level events is active. Event list: event number 5120.
9	Line Synchronization Fault	0: None of the listed fault level events are active. 1: At least one of the listed fault level events is active. Event list: events number 4160, 4161, 4166.
10	Not Applicable	Not used for AFE.
11...15	Reserved	--

P1.1.8 Warning Status Word 1 **No. 6203**

Shows the warning status word 1. The meaning of the bits is described in the following table.

Bit No.	Name	Description
0	Over Current or IGBT Over Temperature	0: None of the listed warning level events are active. 1: At least one of the listed warning level events is active. Event list: events number 4356, 4370, 4110, 4125, all events in group number 8977.
1	DC Link Over Voltage	0: None of the listed warning level events are active. 1: At least one of the listed warning level events is active. Event list: events number 4144, 4145.
2	DC Link Under Voltage	0: None of the listed warning level events are active. 1: At least one of the listed warning level events is active. Event list: event number 4146.
3	Reserved	--
4	Unit Over Temperature	0: None of the listed warning level events are active. 1: At least one of the listed warning level events is active. Event list: events number 4103, 4104, 4105.
5	Reserved	--
6	Reserved	--
7	Reserved	--

Bit No.	Name	Description
8	Earth Fault	0: None of the listed warning level events are active. 1: At least one of the listed warning level events is active. Event list: all events in group number 9008.
9	Reserved	--
10	Fieldbus Error	0: None of the listed warning level events are active. 1: At least one of the listed warning level events is active. Event list: events number 5120, 5121.
11	HMI Connection Lost	0: None of the listed warning level events are active. 1: At least one of the listed warning level events is active. Event list: events number 5141, 5142.
12	Reserved	--
13	Reserved	--
14	Auxiliary Device Fault	0: None of the listed warning level events are active. 1: At least one of the listed warning level events is active. Event list: events number 4200, 4201, 4204, 4205.
15	Reserved	--

P1.1.9 Warning Status Word 2 No. 6204

Shows the Warning Status Word 2. The meaning of the bits is described in the following table.

Bit No.	Name	Description
0	Reserved	--
1	Pre-Charge Failed	0: None of the listed warning level events are active. 1: At least one of the listed warning level events is active. Event list: event number 5380.
2	MCB Feedback Error	0: None of the listed warning level events are active. 1: At least one of the listed warning level events is active. Event list: event number 5376.
3	Quick Stop Active	0: None of the listed warning level events are active. 1: At least one of the listed warning level events is active. Event list: event number 5130.
4	Thermistor Over Temperature	0: None of the listed warning level events are active. 1: At least one of the listed warning level events is active. Event list: events number 5143, 5144, 5145.
5	MCB Trip	0: None of the listed warning level events are active. 1: At least one of the listed warning level events is active. Event list: event number 5378.
6	External Event	0: None of the listed warning level events are active. 1: At least one of the listed warning level events is active. Event list: events number 5123, 5124.

Bit No.	Name	Description
7	Cooling Supervision Fault	0: None of the listed warning level events are active. 1: At least one of the listed warning level events is active. Event list: event number 1061.
8	Fieldbus Watchdog	0: None of the listed warning level events are active. 1: At least one of the listed warning level events is active. Event list: event number 5120.
9	Line Synchronization Fault	0: None of the listed warning level events are active. 1: At least one of the listed warning level events is active. Event list: events number 4160, 4161, 4166.
10	Not Applicable	Not used for AFE.
11...15	Reserved	--

P1.1.10 Last Fault Number No. 1610

Shows the number of the most recent active fault.

P1.1.11 Last Warning Number No. 1609

Shows the number of the most recent active warning.

P1.1.12 Grid Ctrl. Status Word No. 6540

Shows the current state of Grid Control Status Word. The meaning of the bits is described in the following table.

Bit No.	Name	Description
0	Ready	0: Converter is not ready (one of the bits of Grid Ctrl. Ready Status word is not true, or McbClosed is false). 1: Converter is ready.
1	Running	0: Converter is not running. 1: Converter is running.
2	Reserved	--
3	Fault Active	0: No faults are active. 1: One or more faults are active.
4	Reserved	--
5	Reserved	--
6	DC-Link Pre-Charge Ready	0: DC-link pre-charge is not ready. 1: DC-link pre-charge is ready.
7	LCL-Filter Pre-Charge Ready	0: LCL-filter pre-charge is not ready. 1: LCL-filter pre-charge is ready.
8...15	Reserved	--

P1.1.13 Grid Ctrl. Ready Status Word No. 5096

Shows the current state of Grid Control Ready Status Word. The meaning of the bits is described in the following table.

Bit No.	Name	Description
0	Run Enabled	0: Run enabled is missing. 1: Run enabled is active.
1	Fault Active Inverse	0: One or more faults are active. 1: No active faults.
2	Pre-Charged	0: Pre-charge is not completed. 1: Pre-charge is completed.
3	DC-Link Voltage Supervision	0: DC-link voltage is not within the undervoltage and overvoltage fault limits. 1: DC-link voltage is within the undervoltage and overvoltage fault limits.
4	Power Unit Ready	0: Power unit is not ready. 1: Power unit is ready.
5	Successful Phase Sync.	0: Error in grid voltage phase-locked loop. 1: No error in grid voltage phase-locked loop.
6	Frequency Supervision	0: Grid frequency is not within the instantaneous trip limits. 1: Grid frequency is within the instantaneous trip limits.
7	Grid Voltage Supervision	0: Grid voltage is not within the instantaneous stop limits. 1: Grid voltage is within the instantaneous stop limits.
8	Correct Voltage Measurement Option Wiring	0: The phase orders of the converter terminal voltage and the voltage measurement option are different. 1: The phase orders of the converter terminal voltage and the voltage measurement option are the same.
9	Valid LCL Filter Values	0: LCL-filter data is not correct. 1: LCL-filter data is correct.
10...15	Reserved	--

P1.1.14 Application Ready Status Word No. 6525

Shows the status of the application in regards to the ability to start modulating.

Bit No.	Name	Description
0	Switch On Enabled	0: The "Switch On Enabled" signal (par. No. 4728) is inactive. 1: The "Switch On Enabled" signal (par. No. 4728) is active.
1	Main Circuit Breaker Close Enabled	0: The "Main Circuit Breaker Close Enable" (par. No. 6557) signal is inactive. 1: The "Main Circuit Breaker Close Enable" (par. No. 6557) signal is active.
2	Main Circuit Breaker Ready	0: Main Circuit Breaker is either open, or the LCL Filter is not energized if the MCB Closing Mode (par. No. 6559) is set to be based on it 1: Main Circuit Breaker is closed, or the LCL Filter is energized if the MCB Closing Mode (par. No. 6559) is set to be based on it.
3	Quick Stop	0: "Quick Stop" signal (par. No. 212) is active. 1: "Quick Stop" signal (par. No. 212) is inactive.
4...15	Reserved	--

7.2.2 Control Mode and Reference Monitoring

P1.2.1 Reactive Current Ref. No. 2875

Reactive current reference in % of grid nominal current.

P1.2.2 DC-link Voltage Ref. % Actual No. 6543

Shows the actual DC-link voltage reference in % of the grid nominal voltage (peak amplitude).

7.2.3 Limit Monitoring

P1.3.1 Current Limit (Actl.) No. 2882

Grid total output current limit in % of the grid nominal current.

P1.3.2 Neg. Active Current Limit (Actl.) No. 2878

Shows the active current limit in negative direction in % of the grid nominal current.
See parameter No. 2947 for sign convention to be used for positive current direction.

P1.3.3 Pos. Active Current Limit (Actl.) No. 2880

Shows the active current limit in positive direction in % of the grid nominal current.
See parameter No. 2947 for sign convention to be used for positive current direction.

P1.3.4 Neg. Active Power Limit (Actl.) No. 2879

Shows the active power limit in negative direction in % of the grid nominal power.
See parameter No. 2947 for sign convention to be used for positive power direction.

P1.3.5 Pos. Active Power Limit (Actl.) No. 2881

Shows the active power limit in positive direction in % of the grid nominal power.
See parameter No. 2947 for sign convention to be used for positive power direction.

7.2.4 Start and Stop Monitoring

P1.4.1 Pre-Charge Active No. 6561

Shows when pre-charge is active.

P1.4.2 Pre-Charge Ready No. 6562

Shows when pre-charge is ready.

P1.4.3 MCB Close Active No. 171

Shows main circuit breaker close request.

P1.4.4 MCB Feedback No. 172

Show Main circuit breaker close feedback.

7.2.5 Control Place Monitoring

P1.5.1 Active Control Place No. 113

Shows the control place that controls the converter. The indication numbers are presented in the following table.

Number	Name	Description
0	PC control	PC (MyDrive® Insight) is the active control place commanding the converter.
1	Local control	Local (control panel) is the active control place commanding the converter.
2	Fieldbus control	Fieldbus is the active control place commanding the converter.
3	I/O control	I/O is the active control place commanding the converter.

P1.5.2 FB Forcing Requested **No. 116**

Shows the status of the fieldbus control place forcing request.

Number	Name	Description
0	Inactive	FB forcing is not requested.
1	Active	FB forcing is requested.

P1.5.3 I/O Forcing Requested **No. 117**

Shows the status of the I/O-control place forcing request.

Number	Name	Description
0	Inactive	I/O forcing is not requested.
1	Active	I/O forcing is requested.

P1.5.4 Local Control Forcing Requested **No. 124**

Shows the status of the local control place forcing request (made from control panel REM/LOC button).

Number	Name	Description
0	Inactive	Local (panel) control forcing is not requested.
1	Active	Local (panel) control forcing is requested.

7.2.6 Converter Output Monitoring

P1.6.1 Converter Output Current **No. 9000**

Shows the converter output current.

P1.6.2 Converter Output Current % **No. 9001**

Shows the converter output current in % of grid nominal current.

P1.6.3 Converter Output Voltage **No. 9005**

Shows the converter output voltage.

7.2.7 Grid Monitoring

P1.7.1 Grid Frequency **No. 9041**

Shows the actual grid frequency. If the converter is equipped with a voltage measurement option OC7V0 the frequency is measured via the option board. Otherwise, the frequency is measured from drive output terminals.

P1.7.2 Grid Voltage **No. 9040**

Shows grid line-to-line voltage (RMS) at the point of common coupling. If the converter is equipped with a voltage measurement option OC7V0 the voltage is measured via the option board. Otherwise, the voltage is measured from drive output terminals.

P1.7.3 Grid Voltage Imbalance **No. 9047**

Shows the grid voltage imbalance in %. A value greater than 3% may indicate grid problems.

P1.7.4 Grid Current **No. 9060**

Shows the current at the point of common coupling.

P1.7.5 Grid Current % **No. 9061**

Shows the current at the point of common coupling in % of grid nominal current. The grid nominal current is defined in Grid Settings.

P1.7.6 Grid Active Current % **No. 9062**

Shows the active current in % of grid nominal current.

P1.7.7 Grid Reactive Current % **No. 9063**

Shows the reactive current in % of grid nominal current.

P1.7.8 Grid Active Power **No. 9064**

Shows grid active power.

P1.7.9 Grid Active Power % **No. 9065**

Shows grid active power in % of grid nominal power.

P1.7.10 Grid Reactive Power % **No. 9052**

Shows grid reactive power in % of grid nominal power.

7.2.8 DC-Link Monitoring**P1.8.1 DC-link Voltage** **No. 9044**

Shows the actual DC-link voltage.

P1.8.2 DC-link Voltage % **No. 6542**

Shows the actual DC-link voltage in % of the grid nominal voltage rectified value.

7.2.9 Converter Control Monitoring**P1.9.1 Actual Switching Frequency** **No. 2923**

Shows the actual switching frequency. The actual switching frequency of the converter can vary because of some of the internal overriding functions (derating, for example). This value shows the actual switching frequency after the override functions.

P1.9.2 Modulation Index **No. 5101**

Shows the modulation index, which is the ratio between the peak value of phase-to-phase voltage fundamental wave and DC-link voltage.

P1.9.3 Control Unit Temperature **No. 2952**

Shows the temperature of the control unit.

7.2.10 Protection Monitoring**7.2.10.1 Measured Temp. Protection Status**

This group contains the readout values for the temperature values measured by the temperature sensors, which are connected to the temperature measurement option board OC7T0.

P1.10.1.1 Protection 1 Temp. **No. 5200**

Shows the temperature measured for the temperature protection.

P1.10.1.2 Protection 2 Temp. **No. 5201**

Shows the temperature measured for the temperature protection.

P1.10.1.3 Protection 3 Temp. **No. 5202**

Shows the temperature measured for the temperature protection.

P1.10.1.4 Protection 4 Temp. **No. 5203**

Shows the temperature measured for the temperature protection.

P1.10.1.5 Protection 5 Temp. **No. 5204**

Shows the temperature measured for the temperature protection.

P1.10.1.6 Protection 6 Temp. **No. 5205**

Shows the temperature measured for the temperature protection.

P1.10.1.7 Protection 7 Temp. **No. 5273**

Shows the temperature measured for the temperature protection.

P1.10.1.8 Protection 8 Temp. **No. 5274**

Shows the temperature measured for the temperature protection.

P1.10.1.9 Protection 9 Temp. **No. 5275**

Shows the temperature measured for the temperature protection.

P1.10.1.10 Protection 10 Temp. **No. 5276**

Shows the temperature measured for the temperature protection.

7.2.11 Power Unit Monitoring**P1.11.1 Power Capacity** **No. 2836**

Shows the power capacity of the converter as a percentage. The value is derived from the number of active power units compared to the nominal power unit count of the converter.

P1.11.2 Unit Nominal Voltage **No. 2830**

Shows the nominal voltage setting as a result of the setting of parameter Unit Voltage Class (No. 2832).

P1.11.3 Unit Nominal Current No. 2831

Shows the nominal current of the unit.

P1.11.4 Heat Sink Temperature No. 2950

Shows the temperature of the power unit heat sink.

7.2.12 Cooling Fan Monitoring

P1.12.1 Main Fan Speed No. 2931

Shows the speed of the main cooling fan.

P1.12.2 Internal Fan Speed No. 2926

Shows the speed of the internal cooling fan.

7.2.13 Fieldbus Process Data Monitoring

P1.13.1 Fieldbus Control Word No. 1335

Shows the fieldbus control word process data signal value. See 2.3.1 Fieldbus Control Word and Bit Description for further information.

P1.13.2 FB Status Word No. 1307

Shows the fieldbus status word process data signal value. See 2.3.2 Fieldbus Status Word and Bit Description for further information.

P1.13.3 FB DC-link Voltage Ref. No. 6533

Shows the incoming fieldbus process data DC-link voltage reference in % of the grid nominal voltage (peak amplitude).

7.3 G2 Parameters

This group houses most of the converter settings.

7.3.1 Basic Parameters

This group contains a collection of the basic parameters needed to get the converter operational. Grid nominal values, converter nominal values, feedback sources for grid and filter voltages, overload mode, current/power positive direction and paralleling synchronization handling are configured in this group.

P2.1.1 Grid Nominal Frequency No. 6536

Set the nominal grid voltage frequency for grid control in Hz.

P2.1.2 Grid Nominal Voltage No. 6537

Set the nominal grid voltage for grid control in V. It is automatically updated if parameter Unit Voltage Class (No. 2832) is changed.

P2.1.3 Grid Nominal Current **No. 6538**

Set the nominal grid current for grid control.

P2.1.4 Grid Voltage Feedback Source **No. 6539**

Set the grid external voltage measurement configuration. Informs whether grid voltage measurement can be used in grid control. AFE can use the grid voltage feedback for the following operations:

- o monitoring of the grid voltage and frequency
- o to help AFE to better handle grid voltage dips without tripping
- o to help AFE to better handle resonance damping (in some special scenarios)

Number	Name	Description
0	Disabled	Local (panel) control forcing is not requested.
1	X52	Channel 1 on voltage measurement option is used for feedback.
2	X53	Channel 2 on voltage measurement option is used for feedback.

NOTICE

This function requires that a voltage measurement option board (OC7V0) is installed in the converter.

P2.1.5 Filter Voltage Feedback Source **No. 6541**

Set the filter external voltage measurement configuration. Informs whether filter voltage measurement can be used in grid control.

Number	Name	Description
0	Disabled	Local (panel) control forcing is not requested.
1	X52	Channel 1 on voltage measurement option is used for feedback.
2	X53	Channel 2 on voltage measurement option is used for feedback.

AFE can use the voltage feedback for the line filter (LCL) energization. AFE can charge the filter capacitors and synchronize to the voltage measured from the other side of the main circuit breaker. This way the inrush currents and voltage transients typically occurring after the breaker closes are effectively avoided.

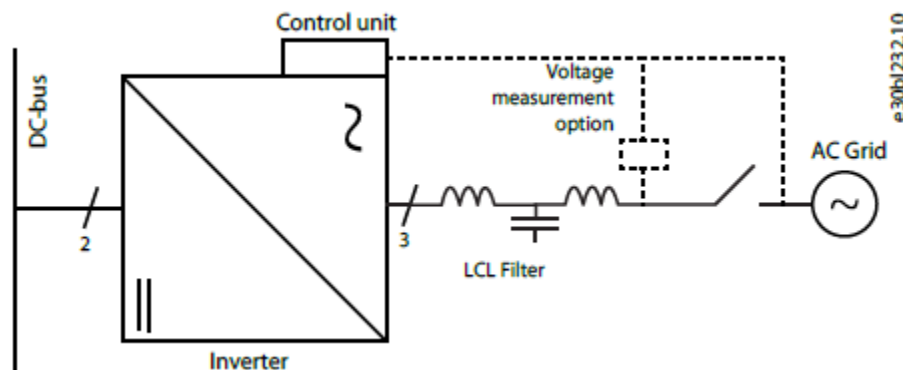

Figure 49. AFE with filter voltage feedback and grid voltage feedback measured by Voltage Measurement option.

NOTICE

This function requires that a voltage measurement option board (OC7V0) is installed to the converter.

P2.1.6 Unit Voltage Class No. 2832

Select the unit voltage class to optimize the performance of the converter. Each power unit is rated for a wide voltage range which the converter can operate in. This parameter is used to specify a narrower band within that range to determine optimized values for the unit's nominal voltage and current. Set this parameter according to the AC mains voltage. The selected voltage class can be seen from readout parameter Unit Nominal Voltage (No. 2830)

No.	Name	Description
1	Low-voltage range	Unit nominal voltage and current are set according to the lowest end of the unit's voltage range. <ul style="list-style-type: none"> • For example for T5-units this range is 380-440 Vac. • For example for T7-units this range is 525-550 Vac.
2	Mid-voltage range	Unit nominal voltage and current are set according to the middle of the unit's voltage range. <ul style="list-style-type: none"> • For example for T5-units this range is 440-480 Vac. • For example for T7-units this range is 550-600 Vac.
3	High-voltage range	Unit nominal voltage and current are set according to the highest end of the unit's voltage range. <ul style="list-style-type: none"> • For example for T5-units this range is 480-500 Vac. • For example for T7-units this range is 600-690 Vac.
4	Wide-voltage range	Unit nominal voltage and current are set according to the unit's whole voltage range. <ul style="list-style-type: none"> • For example for T5-units this range is 380-500 Vac. • For example for T7-units this range is 525-690 Vac.

P2.1.7 Overload Mode No. 2833

Select the overload mode. Overloading mode selects an overtemperature protection profile for the converter, effecting current limits and protection activation times. With a higher overloading mode, the converter operates in a greater degree of overloading before protections take effect. Specific limits and activation delays depend on the conditions.

No.	Name	Description
0	Automatic	The converter automatically determines whether to use the Low or High Overload Mode.
1	Low overload (LO)	The converter uses the lower overloading profile. Overtemperature protection is activated with a lesser degree of overload.
2	High overload (HO1)	The converter uses a higher overloading profile. Overtemperature protection is activated with a higher degree of overload.
3	High overload increased duty (HO2)	The converter uses the highest overloading profile. Overtemperature protection is activated with the highest degree of overload.

P2.1.8 Current/Power Positive Direction No. 2947

Select the sign convention to be used for current and power.

No.	Name	Description
0	From DC-link to Grid	Current and power are positive when flowing from DC-link side to grid side.
1	From Grid to DC-Link	Current and power are positive when flowing from grid side to DC-link side.

P2.1.9 Paralleling Sync. Mode No. 9654

Enable synchronization controller for parallel-connected converters without galvanic isolation to reduce circulating common mode current.

No.	Name	Description
0	Disabled	
1	Enabled	

7.3.2 Control Mode and References

This group contains parameters for configuring the control mode and references for the converter.

7.3.2.1 Grid Current Reference

P2.2.1.1 Reactive Current Ref. No. 233

Set the reactive current reference in % of grid nominal current.

7.3.2.2 DC-Link Voltage Reference

P2.2.2.1 DC-link Voltage Ref. Source No. 2916

Select the source for the DC-link voltage reference. The source of the DC-link voltage reference does not follow the control place selection.

No.	Name	Description
0	Parameter	DC-link voltage reference is taken from parameter No. 2910.
1	Fieldbus	DC-link voltage reference is taken from fieldbus via parameter No. 6533.

P2.2.2.2 DC-link Voltage Ref. No. 2910

Set the DC-link voltage reference. Select the reference mode with parameter No. 2888.

P2.2.2.3 DC-link Voltage Droop Gain No. 2912

Set the DC-link voltage drooping gain; change of DC voltage reference per (active) current change. Refer to chapter 2.1.1 General Features and the subchapter Paralleling AFEs for additional information regarding DC-link voltage drooping.

P2.2.2.4 DC-link Voltage Ref. Filter Tc No. 2894

Set the DC-link voltage reference low pass filter time constant.

P2.2.2.5 DC-link Voltage Ref. Float Filter Tc No. 2895

Filtering time constant of actual grid voltage when floating reference is used.

P2.2.2.6 DC-link Voltage Ref. Mode No. 2888

DC link voltage reference mode selection. This parameter selects the representation of the DC-link Voltage Reference parameter (No. 2910).

No.	Name	Description
0	In % of grid nominal voltage rectified value	DC-link Voltage Reference = $\sqrt{2}$ * Grid Nominal Voltage (No. 6537) * DC-Link Voltage Ref (No. 2910)
1	In % of actual rectified grid voltage (floating)	Dc-Link Voltage Reference = $\sqrt{2}$ * Grid Voltage (No. 9040) * DC-Link Voltage Ref (No. 2910)

7.3.3 Limits

This group contains parameters for configuring different limits for the converter.

7.3.3.1 Grid Current Limit

P2.3.1.1 Neg. Active Current Limit No. 2855

Set the active current limit in negative direction in % of the grid nominal current.

P2.3.1.2 Pos. Active Current Limit No. 2858

Set the active current limit in positive direction in % of the grid nominal current.

7.3.3.2 Grid Power Limit

P2.3.2.1 Neg. Active Power Limit No. 2862

Set the active power limit in negative direction in % of the grid nominal power.

P2.3.2.2 Pos. Active Power Limit No. 2865

Set the active power limit in positive direction in % of the grid nominal power.

7.3.4 Digital and Analog Inputs

7.3.4.1 Digital Inputs

This group is a collection of all the digital input sink selection parameters. All these parameters have the following options:

No.	Name	Description
0	False	No input is selected. A virtual value of FALSE is applied.
1	True	No input is selected. A virtual value of TRUE is applied.
*	Fieldbus control word digital input bits	Fieldbus CTW digital input bits 12-15.
*	Available digital input terminals	A dynamically generated selection of available digital input terminals is presented as an option. The specific set depends on the type and number of I/O options installed in the system.

P2.4.1.1 Run Enable Input No. 103

Select a digital input for enabling the converter to run. This signal must be active for the converter to be in the ready state. If the signal is deactivated while the converter is running, the converter stops modulating immediately.

P2.4.1.2 External Event 1 Input No. 4557

Select an input for the external event.

P2.4.1.3 External Event 2 Input No. 4560

Select an input for the external event.

P2.4.1.4 Cooling Monitor Input No. 2400

Select the input for the negated cooling monitor signal.

P2.4.1.5 Force I/O Control Input No. 4513

Select an input terminal for forcing the control place to I/O.

P2.4.1.6 Force FB Control Input No. 4511

Select an input terminal for forcing the control place to Fieldbus.

P2.4.1.7 I/O Start Input No. 200

Set the input source for starting the unit when the active control place is I/O Control.

P2.4.1.8 I/O Stop Input No. 201

Set the input source for stopping the unit when the active control place is I/O Control. It is activated when the input becomes LOW, FALSE or 0.

P2.4.1.9 I/O Reset Input No. 203

Select the input source for the reset command for when the converter operates in I/O control.

P2.4.1.10 Switch On Enable Input No. 4728

Select a digital input to allow the converter to perform DC-link pre-charging, close the main circuit breaker and to enter running state. If this signal becomes low all these actions are prevented or interrupted and the MCB is opened if closed.

P2.4.1.11 Pre Charge Request Inp. No. 6567

Set the digital input for the pre-charge request.

P2.4.1.12 MCB Close Enable Input No. 6557

Set the digital input for main circuit breaker closing enable.

P2.4.1.13 MCB Feedback Close Input No. 6552

Set the digital input for main circuit breaker closing feedback.

P2.4.1.14 MCB Feedback Open Input No. 6553

Set the digital input for main circuit breaker opening feedback.

P2.4.1.15 MCB Tripped Input No. 6554

Set the digital input for main circuit breaker tripped feedback.

P2.4.1.16 Quick Stop Input No. 212

Select an input terminal for the Quick Stop. It is activated when the input becomes LOW, FALSE or 0.

P2.4.1.17 Quick Stop Input 2 No. 5104

Select an input terminal for the Quick Stop. It is activated when the input becomes LOW, FALSE or 0.

P2.4.1.18 Input Section Overtemp. Input No. 5310

Select an input terminal for the mains input section overtemperature event. It is activated when the input becomes LOW, FALSE or 0.

7.3.5 Digital and Analog Outputs**7.3.5.1 Digital Outputs**

This group is a collection of all the digital output sink selection parameters. All these parameters have the following options:

No.	Name	Description
0	None	No output is selected.
*	Available digital output and relay terminals	A dynamically generated selection of available digital output and relay terminals is presented as an option. The specific set depends on the type and number of I/O options installed in the system.

P2.5.1.1 Ready Output No. 205

Select an output for the Ready-signal.

P2.5.1.2 Run Output No. 206

Select an output for the Run-signal.

P2.5.1.3 Static Fault Output No. 208

Select an output for the Static Fault Active-signal.

P2.5.1.4 Static Warning Output No. 209

Select an output for the Static Warning Active-signal.

P2.5.1.5 Toggling Fault Output No. 5180

Select an output for the Toggling Fault-signal. This signal goes down for 1 second whenever a new fault is registered while another fault was already active.

P2.5.1.6 Toggling Warning Output No. 5181

Select an output for the Toggling Warning-signal. This signal goes down for 1 second whenever a new warning is registered while another warning was already active.

P2.5.1.7 FB CTW Bit 12 Output No. 5193

Select an output for the status of the fieldbus control word bit 12.

P2.5.1.8 FB CTW Bit 13 Output No. 5194

Select an output for the status of the fieldbus control word bit 13.

P2.5.1.9 FB CTW Bit 14 Output No. 5198

Select an output for the status of the fieldbus control word bit 14.

P2.5.1.10 FB CTW Bit 15 Output No. 5191

Select an output for the status of the fieldbus control word bit 15.

P2.5.1.11 DC-link Voltage Superv. Output No. 5157

Select an output for the status of the DC-link Voltage Supervision. Output is activated when the DC-link voltage exceeds Param. DC-link Voltage Superv. Limit (No. 5158).

P2.5.1.12 DC-link Voltage Superv. Limit No. 5158

Set the DC-link Voltage Supervision Limit for monitoring the DC-link Voltage with a digital output (No. 5157).

P2.5.1.13 Local Control Active Output No. 5178

Select an output terminal indicating that the converter is in local control.

P2.5.1.14 I/O Control Active Output No. 5177

Select an output terminal indicating that the converter is in I/O control.

P2.5.1.15 Fieldbus Control Active Output No. 5197

Select an output terminal indicating that the converter is in fieldbus control.

P2.5.1.16 Active Event 1 Output No. 5189

Select an output for monitoring the event activation status (output high = event active).

P2.5.1.17 Event 1 Number No. 5188

Set the number of the event to be assigned for Active Event 1 output.

P2.5.1.18 Active Event 2 Output No. 5190

Select an output for monitoring the event activation status (output high = event active).

P2.5.1.19 Event 2 Number No. 5290

Set the number of the event to be assigned for Active Event 2 output.

P2.5.1.20 No Warning Output No. 217

Select an output for the No Warning Active-signal.

P2.5.1.21 No Fault Output No. 218

Select an output for the No Fault Active-signal.

P2.5.1.22 Local Control Forcing Requested Output No. 125

Select an output terminal for the indication that the control place forcing to Local Control has been requested with REM/LOC button of control panel (output high = requested).

P2.5.1.23 I/O Forcing Requested Output No. 121

Select an output terminal for the indication that the control place forcing to I/O Control has been requested (output high = requested).

P2.5.1.24 FB Forcing Requested Output No. 120

Select an output terminal for the indication that the control place forcing to Fieldbus Control has been requested (output high = requested).

7.3.5.2 Analog Outputs

This group is a collection of all the analog output terminal selection parameters of the converter. All these parameters have the following options:

No.	Name	Description
0	None	No output is selected for the associated parameter.
*	Available analog output terminals	A dynamically generated selection of available analog output terminals is presented as an option. The specific set depends on the type and number of I/O options installed in the system.

P2.5.2.1 Output Current Output No. 2453

Select an analog output for the output current %.

Scaling:

- -200% = Terminal Minimum Value
- 200% = Terminal Maximum Value

P2.5.2.2 Absolute Active Power Output No. 2456

Select an analog output for the grid active power %.

Scaling:

- 0% = Terminal Minimum Value
- 100% = Terminal Maximum Value

P2.5.2.3 Active Power Output No. 2455

Select an analog output for the grid active power (kW). Define the scaling with parameters No. 2458 and 2459.

P2.5.2.4 Active Power Output Max. No. 2458

Set the maximum active power value for analog output scaling maximum.

P2.5.2.5 Active Power Output Min. No. 2459

Set the minimum active power value for analog output scaling minimum.

P2.5.2.6 DC-link Voltage Output No. 2454

Select an analog output for the DC-link voltage %. Define the scaling with parameters No. 2460 and 2461.

P2.5.2.7 DC-link Voltage Output Max. No. 2460

Set the maximum DC-link voltage value for analog output scaling maximum.

P2.5.2.8 DC-link Voltage Output Min. No. 2461

Set the minimum DC-link voltage value for analog output scaling minimum.

P2.5.2.9 Main Fan Speed Output No. 2462

Select an analog output for the main fan speed signal. Define the scaling with parameters No. 2463 and 2464.

P2.5.2.10 Main Fan Speed Output Max. No. 2463

Set the maximum main fan speed value for analog output scaling maximum.

P2.5.2.11 Main Fan Speed Output Min. No. 2464

Set the minimum main fan speed value for analog output scaling minimum.

7.3.6 Start and Stop Settings

7.3.6.1 Start Settings

This group contains parameters for start related settings. For general information about starting the unit, refer to section 2.2 Start and Stop Sequence.

P2.6.1.1 Start Delay No. 4718

Set a delay to start the converter. This delay is applied after all “Ready to Run” conditions have been met (check parameter No. 6525).

P2.6.1.2 Run Enable Input No. 103

Select a digital input for enabling the converter to run. This signal must be active for the converter to be in the ready state. If the signal is deactivated while the converter is running, the converter stops modulating immediately.

No.	Name	Description
0	False	No input is selected. A virtual value of FALSE is applied.
1	True	No input is selected. A virtual value of TRUE is applied.
*	Fieldbus control word digital input bits	Fieldbus CTW digital input bits 12-15.
*	Available digital input terminals	A dynamically generated selection of available digital input terminals is presented as an option. The specific set depends on the type and number of I/O options installed in the system.

P2.6.1.3 Switch On Enable Input

No. 4728

Select a digital input to allow the converter to perform DC-link pre-charging, close the main circuit breaker and to enter running state. All these actions are prevented or interrupted if this signal becomes low.

No.	Name	Description
0	False	No input is selected. A virtual value of FALSE is applied.
1	True	No input is selected. A virtual value of TRUE is applied.
*	Fieldbus control word digital input bits	Fieldbus CTW digital input bits 12-15.
*	Available digital input terminals	A dynamically generated selection of available digital input terminals is presented as an option. The specific set depends on the type and number of I/O options installed in the system.

7.3.6.2 Quick Stop

The Quick Stop function can be used as a special stop method in exceptional situations, for instance in emergencies. With parameters No. 212 and No. 5104, the operator can select two inverted inputs for activating this function. Besides these inputs the operator can also give a quick stop command via fieldbus control word bit 2.

Quick Stop can also be configured to trigger an event, the type of which the operator can configure with parameter No. 4587. Note that the quick stop command is a separate function from the quick stop event.

NOTICE

Once activated, Quick Stop blocks starting, until all active start commands are removed. In other words, a new start command is always required after a Quick Stop.

Quick Stop is not a Functional Safety feature.

P2.6.2.1 Quick Stop Input

No. 212

Select an input terminal for the Quick Stop. The functionality is inverted so Quick Stop is activated when the input becomes low.

No.	Name	Description
0	False	No input is selected. A virtual value of FALSE is applied.
1	True	No input is selected. A virtual value of TRUE is applied.
*	Fieldbus control word digital input bits	Fieldbus CTW digital input bits 12-15.
*	Available digital input terminals	A dynamically generated selection of available digital input terminals is presented as an option. The specific set depends on the type and number of I/O options installed in the system.

P2.6.2.2 Quick Stop Input 2 No. 5104

Select a second input terminal for Quick Stop. The functionality is inverted so quick stop is activated when the input becomes low.

No.	Name	Description
0	False	No input is selected. A virtual value of FALSE is applied.
1	True	No input is selected. A virtual value of TRUE is applied.
*	Fieldbus control word digital input bits	Fieldbus CTW digital input bits 12-15.
*	Available digital input terminals	A dynamically generated selection of available digital input terminals is presented as an option. The specific set depends on the type and number of I/O options installed in the system.

P2.6.2.3 Quick Stop Response No. 4587

Select the response to a Quick Stop event. The converter stops regardless of the event setting.

No.	Name	Description
0	No response	Quick stop does not trigger an event. Note that a quick stop command can still be given to stop the converter.
1	Info	The converter issues an info event and stop modulation.
3	Warning	The converter issues a warning event and stop modulation.
10	Fault	The converter issues a fault event and stop modulation.
11	Fault, Open MCB	The converter issues a fault event, stop modulation, and open the main circuit breaker.

7.3.6.3 Pre Charge

This group contains parameters for pre-charge related settings. For general information about pre-charging the unit, refer to section 2.2 Start and Stop Sequence.

P2.6.3.1 Pre-Charge Request Output No. 6563

Set the pre-charge command digital output.

No.	Name	Description
0	None	No output is selected.
*	Available digital output and relay terminals	A dynamically generated selection of available digital output and relay terminals is presented as an option. The specific set depends on the type and number of I/O options installed in the system.

P2.6.3.2 Pre-Charge Ready Level No. 6566

Set the DC-link voltage level in % of nominal voltage above which the pre-charge becomes ready.

P2.6.3.3 Pre Charge Request Inp.**No. 6567**

Set the digital input for the pre charge request.

No.	Name	Description
0	False	No input is selected. A virtual value of FALSE is applied.
1	True	No input is selected. A virtual value of TRUE is applied.
*	Fieldbus control word digital input bits	Fieldbus CTW digital input bits 12-15.
*	Available digital input terminals	A dynamically generated selection of available digital input terminals is presented as an option. The specific set depends on the type and number of I/O options installed in the system.

P2.6.3.4 Pre-charge Allowed Output**No. 6569**

Set the digital output terminal for pre-charge allowed.

No.	Name	Description
0	None	No output is selected.
*	Available digital output and relay terminals	A dynamically generated selection of available digital output and relay terminals is presented as an option. The specific set depends on the type and number of I/O options installed in the system.

P2.6.3.5 Pre-Charge Allowed Level**No. 5510**

Set the level (DC Voltage in % of the nominal dc voltage) below which pre-charge is allowed.

7.3.6.4 Main Circuit Breaker

The main circuit breaker control allows the operator to open, close, and monitor the main circuit breaker installed between the converter and the grid.

P2.6.4.1 MCB Close Output**No. 6551**

Set the digital output for the main circuit breaker closing command.

No.	Name	Description
0	None	No output is selected.
*	Available digital output and relay terminals	A dynamically generated selection of available digital output and relay terminals is presented as an option. The specific set depends on the type and number of I/O options installed in the system.

P2.6.4.2 MCB Feedback Close Input No. 6552

Set the digital input for main circuit breaker closed-status feedback.

No.	Name	Description
0	False	No input is selected. A virtual value of FALSE is applied.
1	True	No input is selected. A virtual value of TRUE is applied.
*	Fieldbus control word digital input bits	Fieldbus CTW digital input bits 12-15.
*	Available digital input terminals	A dynamically generated selection of available digital input terminals is presented as an option. The specific set depends on the type and number of I/O options installed in the system.

P2.6.4.3 MCB Feedback Open Input No. 6553

Set the digital input for the main circuit breaker open-status feedback.

No.	Name	Description
0	False	No input is selected. A virtual value of FALSE is applied.
1	True	No input is selected. A virtual value of TRUE is applied.
*	Fieldbus control word digital input bits	Fieldbus CTW digital input bits 12-15.
*	Available digital input terminals	A dynamically generated selection of available digital input terminals is presented as an option. The specific set depends on the type and number of I/O options installed in the system.

P2.6.4.4 MCB Tripped Input No. 6554

Set the digital input for main circuit breaker tripped feedback.

No.	Name	Description
0	False	No input is selected. A virtual value of FALSE is applied.
1	True	No input is selected. A virtual value of TRUE is applied.
*	Fieldbus control word digital input bits	Fieldbus CTW digital input bits 12-15.
*	Available digital input terminals	A dynamically generated selection of available digital input terminals is presented as an option. The specific set depends on the type and number of I/O options installed in the system.

P2.6.4.5 MCB Close Pulse Output No. 6555

Set the digital output for main circuit breaker closing pulse command.

No.	Name	Description
0	None	No output is selected.
*	Available digital output and relay terminals	A dynamically generated selection of available digital output and relay terminals is presented as an option. The specific set depends on the type and number of I/O options installed in the system.

P2.6.4.6 MCB Open Pulse Output No. 6556

Set the digital output for main circuit breaker opening pulse command.

No.	Name	Description
0	None	No output is selected.
*	Available digital output and relay terminals	A dynamically generated selection of available digital output and relay terminals is presented as an option. The specific set depends on the type and number of I/O options installed in the system.

P2.6.4.7 MCB Close Enable Input No. 6557

Set the digital input for main circuit breaker closing enable.

No.	Name	Description
0	False	No input is selected. A virtual value of FALSE is applied.
1	True	No input is selected. A virtual value of TRUE is applied.
*	Fieldbus control word digital input bits	Fieldbus CTW digital input bits 12-15.
*	Available digital input terminals	A dynamically generated selection of available digital input terminals is presented as an option. The specific set depends on the type and number of I/O options installed in the system.

P2.6.4.8 MCB Feedback Fault Delay No. 6558

Delay in seconds after which the main circuit feedback fault becomes active when the feedback is missing.

P2.6.4.9 MCB Closing Mode No. 6559

Set the main circuit breaker closing mode configuration.

No.	Name	Description
0	DC-link Pre-Charge Ready	MCB close command is given after the DC-link pre-charge is ready.
1	Start Command	MCB close command is given after the DC-link pre-charge is ready and a start command is given.
2	DC-link Pre-Charge Ready or Start Command	In normal operation MCB close command is given after both the DC-link is pre-charged and a start command is active. When recovering from a fault, the MCB is immediately closed if the DC-link voltage is still above the pre-charge level.
3	LCL Filter Energized	MCB close command is given after the DC-link pre-charge is ready, start command is given, and the LCL filter has been energized.

P2.6.4.10 MCB Opening Mode No. 6560

Set the main circuit breaker opening mode.

No.	Name	Description
0	DC Voltage Level	MCB open command is sent if the DC-link voltage is below the Pre-Charge Ready Level (No. 6566).
1	Stop Command or DC Voltage Level	MCB open command is sent if the stop command is given or the DC-link voltage is below the Pre-Charge Ready Level (No. 6566).
2	Fault Active or DC Voltage Level	MCB open command is sent if a fault is active or the DC-link voltage is below the Pre-Charge Ready Level (No. 6566).
3	Fault Active or Stop Command or DC Voltage Level	MCB open command is sent if a fault is active, a stop command is given, or the DC-link voltage is below the Pre-Charge Ready Level (No. 6566).

7.3.6.5 LCL-Filter Energization

This group contains parameters for LCL-Filter energization-related settings. For general information about pre-charging the unit, refer to section 2.2 Start and Stop Sequence.

P2.6.5.1 Filter Voltage Ramp Time No. 5161

Set the ramp time (from 0 V to nominal grid voltage) for the filter voltage. The ramping is performed during LCL-filter energization when it is controlled by the converter.

P2.6.5.2 Max. Filter Energization Time No. 5162

Set maximum allowed time for filter energization. If this is exceeded a filter pre-charge timeout fault is declared and the main circuit breaker is opened.

7.3.7 Control Places

The AFE application features four different control places for determining how basic converter commands and references are interfaced. These control places are the MyDrive® Insight (PC Control), Local Control (via control panel), Fieldbus Control, and I/O Control.

Selection:

There are two methods for selecting which control place is active, or in other words in command of the converter. The first is a simple parameter selection, while the second is a set of signals that can be used to force or request for a specific control place to be in command.

Commands:

A control place is a source for basic control commands (start, stop, reset, and so on). When operating in I/O control, for instance, the converter cannot be started from the local or fieldbus control places. Control places do not dictate all possible commands. Specific features such as Quick Stop can be used regardless of the control place and must be configured separately.

7.3.7.1 Control Place Settings

This group contains general control place settings that mainly have to do with control place selection. The following figure presents the control place selection chain diagram. The default method for

selecting the control place is by using the parameter No. 114 Control Place Selection. It can be used to select the active control place between Local, Fieldbus, and I/O control.

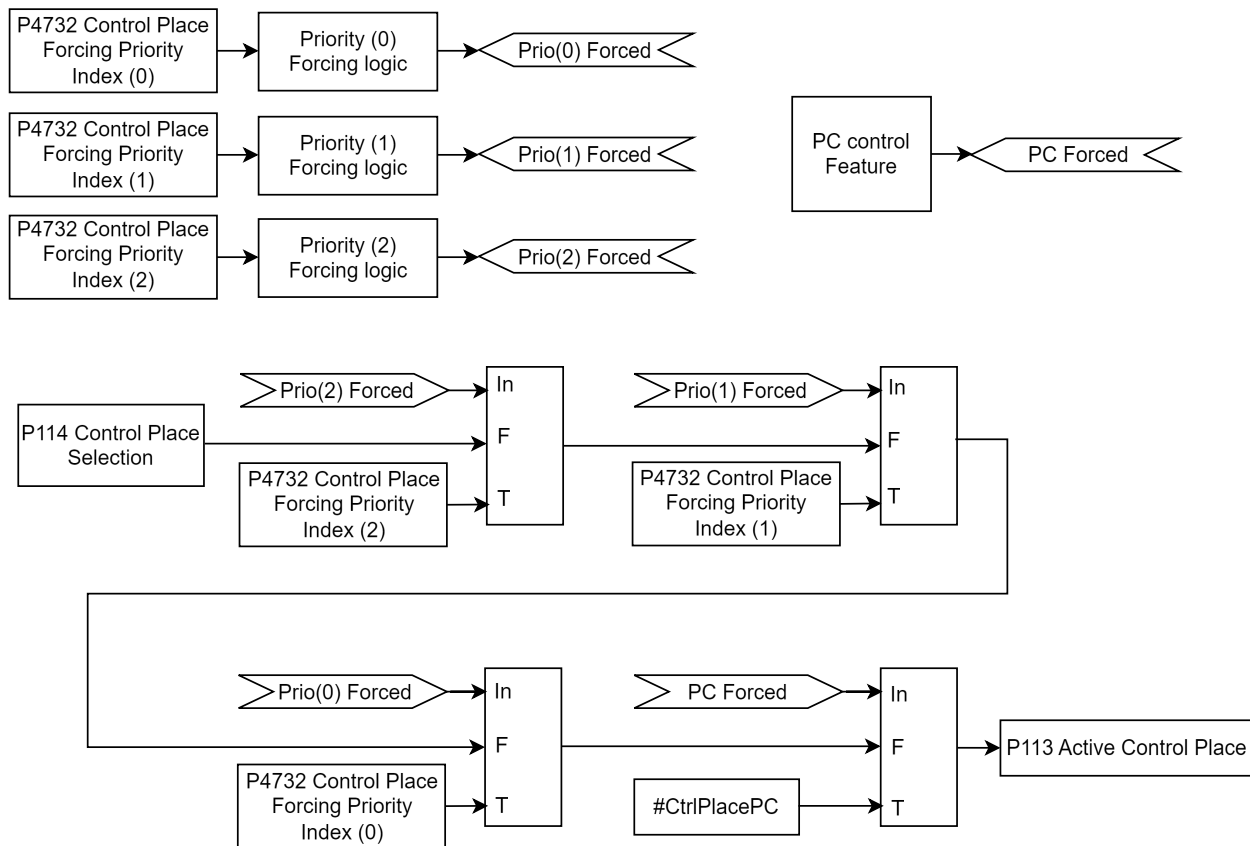

Figure 50: Control place selection chain diagram.

The second option for control place selection is to use control place forcing signals, which overrides the selection made with the parameter, and can be used to swap between different control places, for example via external push buttons or switches. The forcing signals for Fieldbus and I/O control can be mapped to digital inputs or fieldbus, and the Local control forcing is activated with the REM/LOC button of the control panel.

The priority order for the forceable control places is configured with parameter No. 4732. The priority order affects the final control place selection if two or more control places are forced on simultaneously. For example: if Fieldbus is selected for highest priority with Index-0, and I/O for the next highest priority with index-1, and both control places are forced on simultaneously, fieldbus is selected as the active control place. After Fieldbus forcing is removed, the control place falls to I/O because it has higher priority than the parameter selection.

The only control place which can take over the control from any other control place regardless of forcing inputs is the MyDrive® Insight. Control is overtaken by requesting it via the tool itself. By default, the converter uses the following control place priority order:
MyDrive® Insight > Local Control > I/O > Fieldbus > Parameter Selection

Forcing can be further configured with parameter No. 1972 which defines whether each forcing signal is treated as a state sensitive or toggled signal.

Parameter No. 4800 can also be used to define how the converter behaves when an active control place releases control. The options are to either release control immediately or only if another control place requests control.

When a control place is changed, the converter either stops or continues operating (modulation) based on the settings defined with parameters No. 108, No. 5112, and No. 5111, respectively for each control place.

P2.7.1.1 Control Place Selection No. 114

Select the active control place.

No.	Name	Description
0	PC control	
1	Local control	
2	Fieldbus control	
3	I/O control	

P2.7.1.2 Force FB Control Input No. 4511

Select an input terminal for forcing the control place to Fieldbus.

No.	Name	Description
0	False	No input is selected. A virtual value of FALSE is applied.
1	True	No input is selected. A virtual value of TRUE is applied.
*	Fieldbus control word digital input bits	Fieldbus CTW digital input bits 12-15.
*	Available digital input terminals	A dynamically generated selection of available digital input terminals is presented as an option. The specific set depends on the type and number of I/O options installed in the system.

P2.7.1.3 Force I/O Control Input No. 4513

Select an input terminal for forcing the control place to I/O.

No.	Name	Description
0	False	No input is selected. A virtual value of FALSE is applied.
1	True	No input is selected. A virtual value of TRUE is applied.
*	Fieldbus control word digital input bits	Fieldbus CTW digital input bits 12-15.
*	Available digital input terminals	A dynamically generated selection of available digital input terminals is presented as an option. The specific set depends on the type and number of I/O options installed in the system.

P2.7.1.4 Control Place Forcing Mode **No. 1972**

Select whether each control place forcing signal is treated as a state sensitive or a toggled signal. With toggling enabled, the forcing is activated by the first rising edge, and deactivated by the second rising edge of the forcing signal.

No.	Name		Description
0	FB: State	I/O: State	
1	FB: Toggle	I/O: State	
2	FB: State	I/O: Toggle	
3	FB: Toggle	I/O: Toggle	

P2.7.1.5 Control Place Independent Reset **No. 109**

Enable faults to be reset from all control places. The reset command goes through regardless of whether it was given from the active control place or not.

No.	Name	Description
0	Disabled	Reset goes through only from active control place.
1	Enabled	Reset goes through from all control places regardless of whether it was given from the active control place or not.

P2.7.1.6 Control Place Release Mode **No. 4800**

Select the action after the control place is released from the forced control places, as well as from control panel or PC control. When set to "Change After Release" the control place is changed after releasing to other forced place highest in priority order, or in case no forced places are used, to the place defined with parameter "Control Place Selection". When set to "Retain After Release" the control place is not changed after releasing, but only after the operator changes the control place by forcing or from parameter "Control Place Selection".

No.	Name	Description
0	Retain After Release	When the forcing of the currently active control place is released, a new forcing command is required from another control place, for the active control place to change.
1	Change After Release	When the forcing of the currently active control place is released, the control place is changed immediately.

P2.7.1.7 Control Place Forcing Priority No. 4732

Set the control place priority when using control place forcing inputs. The parameter is an array where the priority is specified in decreasing order of the array members (Index 0-2). Therefore, in case multiple control places are requested simultaneously, the selection made with Index 0 prevails on the selection made with Index 1, and so on. If a control place is not assigned any priority, its forcing signal is disabled.

Index	Name	Description
0	Highest priority control place	Select the control place with the highest priority from the following list: <ul style="list-style-type: none"> • Local control • Fieldbus • I/O
1	2nd highest priority control place	Select the control place with the second highest priority from the following list: <ul style="list-style-type: none"> • Local control • Fieldbus • I/O
2	Lowest priority control place	Select the control place with the lowest priority from the following list: <ul style="list-style-type: none"> • Local control • Fieldbus • I/O

7.3.7.2 Local Control

Local control, also known as panel control, can be selected by the Selection parameter or by overriding control by pressing the REM/LOC button on the panel. When control is released from the panel, the control place is determined by the Selection parameter or forcing signals. The converter offers a protection feature for monitoring the connection between the converter and the panel (parameter No. 5420). If the connection is lost while the panel is in control of the converter, the converter will force-release the control to the next control place in line. Do note that if Local control has not been given any priority with parameter No. 4732 the change to Local control is disabled with the REM/LOC button.

P2.7.2.1 Local Control Mode No. 107

Select restrictions of local control by the control panel. Use this parameter to influence the amount of control anyone accessing the control panel can have on the operation of the converter.

No.	Name	Description
0	Allow Local Control	Local Control can become the active control place. Local control can both start and stop the converter.
1	Deny Local Start	Local Control can become the active control place. Local control cannot start the converter, but it can stop it.
2	Deny Local Control	Local Control cannot become the active control place.

P2.7.2.2 Continue Operation in Local Control No. 108

Select whether the start request is retained when the converter is running, and the control place is changed to local control.

No.	Name	Description
0	Disabled	The drive stops when the active control place is changed.
1	Enabled	The drive continues operating through the control place transition.

7.3.7.3 I/O Control

The I/O control place is designed to give basic commands (start, stop, reset, and so on) to the converter via a set of digital input signals.

P2.7.3.1 I/O Start Input No. 200

Set the input source for starting the unit when the active control place is I/O Control.

No.	Name	Description
0	False	No input is selected. A virtual value of FALSE is applied.
1	True	No input is selected. A virtual value of TRUE is applied.
*	Fieldbus control word digital input bits	Fieldbus CTW digital input bits 12-15.
*	Available digital input terminals	A dynamically generated selection of available digital input terminals is presented as an option. The specific set depends on the type and number of I/O options installed in the system.

P2.7.3.2 I/O Stop Input No. 201

Set the input source for stopping the unit when the active control place is I/O Control. The functionality is inverted so stop is activated when the input becomes low.

No.	Name	Description
0	False	No input is selected. A virtual value of FALSE is applied.
1	True	No input is selected. A virtual value of TRUE is applied.
*	Fieldbus control word digital input bits	Fieldbus CTW digital input bits 12-15.
*	Available digital input terminals	A dynamically generated selection of available digital input terminals is presented as an option. The specific set depends on the type and number of I/O options installed in the system.

P2.7.3.3 I/O Reset Input **No. 203**

Select the input source for the reset command for when the converter operates in I/O control.

No.	Name	Description
0	False	No input is selected. A virtual value of FALSE is applied.
1	True	No input is selected. A virtual value of TRUE is applied.
*	Fieldbus control word digital input bits	Fieldbus CTW digital input bits 12-15.
*	Available digital input terminals	A dynamically generated selection of available digital input terminals is presented as an option. The specific set depends on the type and number of I/O options installed in the system.

P2.7.3.4 I/O Start Mode **No. 213**

Select whether start commands for I/O control are state, rising-edge, or pulse sensitive.

No.	Name	Description
0	State High Start	<p>A start is requested based on the high state of the signal.</p> <p>When the start signal is removed the converter stops modulation.</p> <p>In case the start signal is high when a fault is cleared, or a separate stop signal (quick stop, for example) is removed, the converter starts running immediately.</p> <p>If the converter is stopped from the control panel, a new start signal is needed.</p> <p>Any active stop signal blocks the start.</p>
1	Rising Edge Start	<p>A start is requested based on the combination of the rising-edge and the high-state of the signal.</p> <p>When the start signal is removed, the converter stops modulation.</p> <p>The converter does not start running in case the start signal is high when a fault is cleared, or a separate stop signal (quick stop, for example) is removed.</p> <p>Any active stop signal blocks the start.</p>
2	High Pulse Start	<p>A start is requested based on the rising edge of the signal.</p> <p>The converter is stopped with a rising edge of a separate stop signal.</p> <p>The converter does not start running in case the start signal is high when a fault is cleared, or a separate stop signal (quick stop, for example) is removed.</p> <p>Any active stop signal blocks the start.</p>

P2.7.3.5 Continue Operation in I/O Control No. 5111

Select whether the start request is retained when the converter is running and the control place is changed to I/O, while using edge-sensitive start modes. Any active stop command or auxiliary function such as quick stop can still prohibit continuing the operation.

No.	Name	Description
0	Disabled	The converter stops when the active control place is changed.
1	Enabled	The converter continues operating through the control place transition.

7.3.7.4 Fieldbus Control

The converter can be controlled through a fieldbus master. When fieldbus is selected as the active control place, the converter monitors active fieldbus connections for control commands.

P2.7.4.1 Continue Operation in Fieldbus Control No. 5112

Select whether the start request is retained when the converter is running and the control place is changed to fieldbus. Any active stop command or auxiliary function such as quick stop can still prohibit continuing operation. Continuation is possible only if the start is requested from fieldbus before the control place is changed to it.

No.	Name	Description
0	Disabled	The converter stops when the active control place is changed.
1	Enabled	The drive continues operating through the control place transition.

P2.7.4.2 **Fieldbus Start Mode** **No. 5114**

Select whether start commands for Fieldbus Control are state or rising-edge sensitive.

No.	Name	Description
0	State High Start	<p>A start is requested based on the high state of the signal.</p> <p>When the start signal is removed the converter stops modulation.</p> <p>In case the start signal is high when a fault is cleared, or a separate stop signal (quick stop, for example) is removed, the converter starts running immediately.</p> <p>If converter is stopped from control panel a new start signal is needed.</p> <p>Any active stop signal blocks the start.</p>
1	Rising Edge Start	<p>A start is requested based on the combination of the rising-edge and the high-state of the signal.</p> <p>When the start signal is removed the converter stops modulation.</p> <p>The converter does not start running in case the start signal is high when a fault is cleared, or a separate stop signal (quick stop, for example) is removed.</p> <p>Any active stop signal blocks the start.</p>

7.3.8 **Converter Control**

This group holds settings related to the converter's modulation, advanced grid and DC-link control, power unit, fan control, and LCL-Filter.

7.3.8.1 **Modulation**

This group contains parameters for fine-tuning modulation settings.

P2.8.1.1 **Switching Frequency** **No. 2920**

Set the switching frequency. The actual switching frequency is regulated by the converter itself, and it can be derated by some protection functions.

P2.8.1.2 Modulator Options **No. 5093**

Advanced modulator options.

Bit. No.	Name	Description
0	Disable compensation of non-linearities	
1	Disable deadtime compensation based on feedback	
2	Use filtered DC voltage over the whole speed range	
3	Prohibit pulse dropping when reaching voltage ceiling	
4	Optimized minimum pulse logic for carrier synchronization	

P2.8.1.3 Modulator Type **No. 5100**

Select the modulator type.

No.	Name	Description
1	SVPWM	Standard Space Vector Pulse Width Modulation. Use in special applications, where automatic change of PWM carrier frequency and modulation pattern can cause issues. Drive derating is required.
4	CMRPWM	The CMR modulator optimizes the common-mode voltage waveform. Can be useful with certain drive configurations to minimize motor or generator voltage spikes. The modulator does not support independent paralleling. If paralleling sync. is enabled (with param No. 9654) the modulator type is internally forced to Grid Converter. Recommended selection for Active Front-End drives.
5	Grid Converter	The modulator optimizes the trade-off between losses and harmonics. Recommended selection for most power conversion applications. Modulation parameters are automatically set.

7.3.8.2 Advanced Grid Control

This group contains parameters for fine-tuning grid control settings.

P2.8.2.1 Active Current Kp **No. 2868**

Set scaling of internally computed active current controller proportional gain.

P2.8.2.2 Active Current Ti **No. 2869**

Set scaling of internally computed active current controller integral time.

P2.8.2.3 Grid PLL Tc **No. 9659**

Time constant defining the bandwidth of the grid synchronization PLL.

P2.8.2.4 Active Damping Kp No. 2871

Scaling of internally computed active damping gain used to control LCL filter resonance.

P2.8.2.5 Reactive Current Kp No. 2849

Scaling of internally computed reactive current controller proportional gain.

P2.8.2.6 Reactive Current Ti No. 2850

Scaling of internally computed reactive current controller integral time.

P2.8.2.7 Grid Control Options No. 9658

Set the grid control options word.

Bit. No.	Name	Description
0	Disable observer in control	
1	Enable LCL filter pre-charge	
2	Enable AFE current control voltage feedforward based on an external voltage measurement	

P2.8.2.8 Paralleling Sync. Run Kp No. 9655

Proportional gain of the PWM carrier synchronization control in run state.

P2.8.2.9 Paralleling Sync. Stop Kp No. 9656

Proportional gain of the PWM carrier synchronization control in stop state.

P2.8.2.10 Paralleling Sync. Shift Kp No. 9657

Proportional gain of the common mode current control.

P2.8.2.11 Harmonic Current Control Gain No. 6519

Integrator gain of the Harmonic current control.

7.3.8.3 Advanced DC-Link Control

This group contains parameters for fine-tuning DC-link voltage control settings.

P2.8.3.1 DC-link Voltage Ctrl. Kp No. 2902

Scaling of internally computed DC voltage control proportional gain.

P2.8.3.2 DC-link Voltage Ctrl. Ti No. 2903

Scaling of internally computed DC-link voltage control integral time.

P2.8.3.3 DC-link Voltage Ctrl. Td No. 2907

Scaling of internally computed DC-link voltage control differential time.

P2.8.3.4 DC-link Voltage Droop. Tc No. 5095

Filtering time constant of active current when DC-link voltage drooping is used. Refer to chapter 2.1.1 General Features and the subchapter Paralleling AFEs for additional information regarding DC-link voltage drooping.

7.3.8.4 Power Unit Settings

This group contains parameters for setting up the converter's power units.

P2.8.4.1 Power Unit Enable Mask **No. 2835**

Select which of the commissioned power units are enabled.

The value is given bitwise per each unit. Bit 0 corresponds to the first port in the star coupler board, and bit 15 to the 16th port and so on. An active bit enables the corresponding power unit, and an inactive bit disables it.

This parameter is relevant only for drives with multiple power units, connected to the control board with the star coupler board. Faulty or redundant power units can be disabled temporarily to allow running with reduced capacity. All internal protection functions adjust to the number of enabled power units.

WARNING

Depending on the system's hardware configuration, it might be necessary to galvanically isolate the disabled units and all associated filters from the system. Failing to do so can increase the risk of resonance and damage the rest of the system. Contact Danfoss technical support for further instructions before using this functionality.

NOTICE

This parameter cannot be edited when the drive is running.

NOTICE

After Factory Reset or Node Commissioning, the drive automatically sets this parameter to activate the nominal number of power units starting sequentially from the first port of the star coupler board. If the drive has several power units, but this parameter does not have the correct value at initial start, it is recommended to run Factory Reset and power-cycle the drive. This operation resets the Power Unit Enable Mask to correspond with the nominal number of power units.

P2.8.4.2 DC-link Voltage Measurement Corr. Gain **No. 6535**

Set the DC-link voltage measurement correction gain for parallel units.

P2.8.4.3 DC-link Voltage Measurement Corr. Offset **No. 6534**

Set the DC-link voltage measurement correction offset for parallel units.

P2.8.4.4 HF DC-link Filter Mode **No. 2944**

Select the mode of the high-frequency filter in the DC link.

Bit. No.	Name	Description
0	Filter inactive	
1	Filter active	

7.3.8.5 Cooling Fan Control

This group contains parameters for setting up the control of the converter's cooling fans. These parameters are relevant only for air-cooled units.

P2.8.5.1 Main Fan Minimum Speed **No. 2932**

Set the minimum speed of the main cooling fan. The main cooling fans handle the cooling demand for the power modules and passive components placed in the cooling channel. The fan's actual speed depends on the operating conditions of the drive.

7.3.8.6 LCL-Filter

This group contains parameters for the LCL-Filter inductors and capacitors.

P2.8.6.1 LCL Filter L1 **No. 2904**

Set the converter side filter inductance.

P2.8.6.2 LCL Filter Cf **No. 2905**

Set the filter capacitance.

P2.8.6.3 LCL Filter L2 **No. 2906**

Set the grid side filter inductance.

7.3.9 Protections and Responses

This group contains parameters for applying most the converter's protection related configurations.

7.3.9.1 General Settings

P2.9.1.1 Retry after Fault **No. 2927**

Enables retry functionality (ride-through) functionality for the following fault type events. The number of retry attempts and the retry window depend on the event and the size and rating of the power unit.

No.	Name	Description
0	Disabled	
1	Enabled	

The following fault type events are retry-capable:

Name	Number	Name	Number	Name	Number
Ground Fault 2	4354	Output Current High 1	4369	Output Current High 2	4370
Brake Ch. Switch Shorted	4403	DC-link Voltage Low	4146	DC-link Voltage High 2	4144

7.3.9.2 Misc. Responses

P2.9.2.1 DC-link Voltage Ripple Response No. 2929

Select the mode of excessive DC-link voltage ripple protection. Excessive voltage ripples are detected when the peak-to-peak amplitude of the DC voltage exceeds the converter's internal limit for too long a time. Both the limit and time depend on the power unit type and rating.

No.	Name	Description
0	Disabled	Effectively nothing is done when excessive rippling is detected.
1	Fault	After detecting excessive ripples for too long, the converter will issue a fault and stop modulation.
2	Automatically derate + Fault	After detecting excessive ripples, the converter will derate the maximum allowed output frequency. If the derating does not reduce the rippling soon enough, the converter issues a fault and stop modulation. The derating is released if the ripple amplitude is reduced below the detection limit.

P2.9.2.2 LCL Fan Fail Response No. 2941

Select the converter response to an LCL Fan Fail.

No.	Name	Description
0	No response	-
1	Info	The converter issues an info event.
3	Warning	The converter issues a warning event.
10	Fault	The converter issues a fault event and stops modulation.
11	Fault, Open MCB	The converter issues a fault event, stops modulation, and opens the main circuit breaker.

7.3.9.3 External Event

External events are protection functions which the operator can configure to trigger converter events (warnings, faults, and so on) through inputs. Two separate events are available, both can be triggered with an active-high or active-low signals.

P2.9.3.1 External Event 1 Input No. 4557

Select an input for the external event.

No.	Name	Description
0	None (False)	No input is selected. A virtual value of FALSE is applied.
1	None (True)	No input is selected. A virtual value of TRUE is applied.
*	Fieldbus control word 1 digital input bits	Fieldbus CTW1 digital input bits 12-15 are presented as options.
*	Available digital input terminals	A dynamically generated selection of available digital input terminals is presented as an option. The specific set depends on the type and number of I/O options installed in the system.

P2.9.3.2 Ext. Event 1 Inverse Input **No. 4558**

Select an inverted input for the external event 1 function.

No.	Name	Description
0	None (False)	No input is selected. A virtual value of FALSE is applied.
1	None (True)	No input is selected. A virtual value of TRUE is applied.
*	Fieldbus control word 1 digital input bits	Fieldbus CTW1 digital input bits 12-15 are presented as options.
*	Available digital input terminals	A dynamically generated selection of available digital input terminals is presented as an option. The specific set depends on the type and number of I/O options installed in the system.

P2.9.3.3 External Event 1 Response **No. 4559**

Select the response to an external event.

No.	Name	Description
0	No response	-
1	Info	The converter issues an info event.
3	Warning	The converter issues a warning event.
10	Fault	The converter issues a fault event and stops modulation.
11	Fault, Open MCB	The converter issues a fault event, stops modulation, and opens the main circuit breaker.

P2.9.3.4 External Event 2 Input **No. 4560**

Select an input for the external event.

No.	Name	Description
0	None (False)	No input is selected. A virtual value of FALSE is applied.
1	None (True)	No input is selected. A virtual value of TRUE is applied.
*	Fieldbus control word 1 digital input bits	Fieldbus CTW1 digital input bits 12-15 are presented as options.
*	Available digital input terminals	A dynamically generated selection of available digital input terminals is presented as an option. The specific set depends on the type and number of I/O options installed in the system.

P2.9.3.5 Ext. Event 2 Inverse Input **No. 4561**

Select an inverted input for the external event 2 function.

No.	Name	Description
0	None (False)	No input is selected. A virtual value of FALSE is applied.
1	None (True)	No input is selected. A virtual value of TRUE is applied.
*	Fieldbus control word 1 digital input bits	Fieldbus CTW1 digital input bits 12-15 are presented as options.
*	Available digital input terminals	A dynamically generated selection of available digital input terminals is presented as an option. The specific set depends on the type and number of I/O options installed in the system.

P2.9.3.6 External Event 2 Response **No. 4562**

Select the response to an external event.

No.	Name	Description
0	No response	-
1	Info	The converter issues an info event.
3	Warning	The converter issues a warning event.
10	Fault	The converter issues a fault event and stops modulation.
11	Fault, Open MCB	The converter issues a fault event, stops modulation, and opens the main circuit breaker.

7.3.9.4 Cooling Monitor

The cooling monitor feature is relative for liquid-cooled converters. It is designed to allow the converter to receive a single digital signal from the cooling unit when it experiences errors. The converter then acts as the operator has configured.

P2.9.4.1 Cooling Monitor Input **No. 2400**

Select the input for the negated cooling monitor signal.

No.	Name	Description
0	None (False)	No input is selected. A virtual value of FALSE is applied.
1	None (True)	No input is selected. A virtual value of TRUE is applied.
*	Fieldbus control word 1 digital input bits	Fieldbus CTW1 digital input bits 12-15 are presented as options.
*	Available digital input terminals	A dynamically generated selection of available digital input terminals is presented as an option. The specific set depends on the type and number of I/O options installed in the system.

P2.9.4.2 Cooling Monitor Fault Delay **No. 2401**

Set a delay before the cooling monitor issues a fault. Only valid if fault is selected.

P2.9.4.3 Cooling Monitor Response No. 2402

Select the response to a missing cooling monitor signal. The response is selected for both stopped and running states.

No.	Name	Description
0	Warning while running	The converter issues a warning if the cooling signal is lost, and the converter is running.
1	Warning	The converter issues a warning if the cooling signal is lost.
2	Warning, Fault after Timeout while running	The converter issues a warning if the cooling signal is lost. If the converter is running the event is escalated into a fault after the fault delay (No. 2401).
3	Warning and Fault after Timeout while running	The converter issues a warning if the cooling signal is lost, and the converter is running. After the fault delay (No. 2401) the event is escalated into a fault.

7.3.9.5 Measured Temp. Protection

The measured temperature protection offers 10 individual protection channels for monitoring temperatures of external devices like filters or motor windings through temperature probes. Each protection can be configured to trigger an individual event, which can be used to identify the source of the high temperature measurement.

Each protection has two configurable stages, as illustrated in the following figure. Stage 1 is used to trigger a warning, while stage 2 can be used to trigger a more severe event, which can possibly stop the converter (fault). The operator can configure the activation levels of both stages and the event response of stage 2. The levels of both stages can be configured to be the same, if two stages are unnecessary.

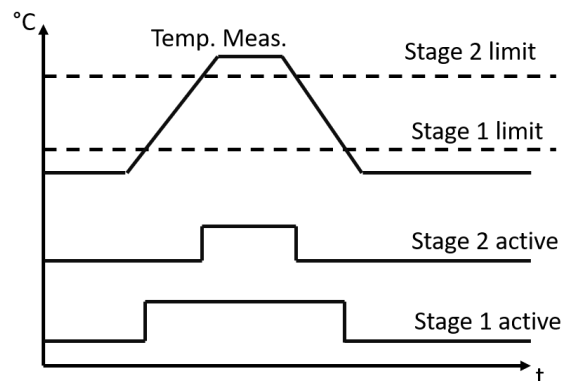

Figure 51: Operation principle of temperature measurement protection function.

Additionally, a temperature measurement range check feature is also available, as presented in the following figure. A range can be defined for checking the validity of each measured temperature protection. If the absolute measurement value of any protection exceeds this range, a separate event can be triggered.

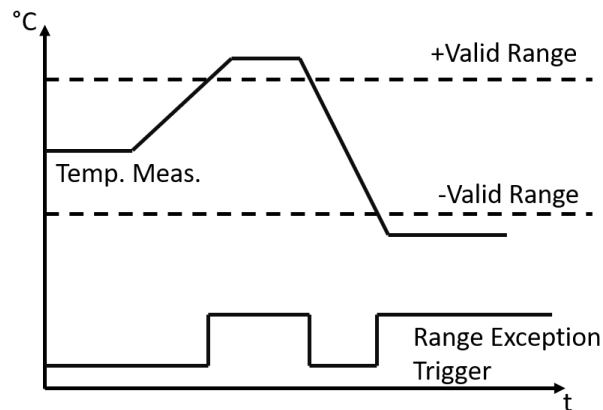

Figure 52: Operation principle of temperature measurement range check.

7.3.9.5.1 Temp. 1 Protection

P2.9.5.1.1 Temp. 1 Input **No. 5206**

Select the temperature sensor input for the temperature protection.

P2.9.5.1.2 Temp. 1 Limit 1 **No. 5207**

Set the temperature level for issuing a warning.

P2.9.5.1.3 Temp. 1 Limit 2 **No. 5208**

Set the temperature level for issuing a protection response.

P2.9.5.1.4 Temp. 1 Limit 2 Response **No. 5209**

Select the response for exceeding the limit.

No.	Name	Description
0	No response	-
1	Info	The converter issues an info event.
3	Warning	The converter issues a warning event.
10	Fault	The converter issues a fault event and stops modulation.
11	Fault, Open MCB	The converter issues a fault event, stops modulation, and opens the main circuit breaker.

7.3.9.5.2 Temp. 2 Protection

P2.9.5.2.1 Temp. 2 Input **No. 5210**

Select the temperature sensor input for the temperature protection.

P2.9.5.2.2 Temp. 2 Limit 1 **No. 5211**

Set the temperature level for issuing a warning.

P2.9.5.2.3 Temp. 2 Limit 2 **No. 5212**

Set the temperature level for issuing a protection response.

P2.9.5.2.4 Temp. 2 Limit 2 Response**No. 5213**

Select the response for exceeding the limit.

No.	Name	Description
0	No response	-
1	Info	The converter issues an info event.
3	Warning	The converter issues a warning event.
10	Fault	The converter issues a fault event and stops modulation.
11	Fault, Open MCB	The converter issues a fault event, stops modulation, and opens the main circuit breaker.

7.3.9.5.3 Temp. 3 Protection**P2.9.5.3.1 Temp. 3 Input No. 5214**

Select the temperature sensor input for the temperature protection.

P2.9.5.3.2 Temp. 3 Limit 1**No. 5215**

Set the temperature level for issuing a warning.

No.	Name	Description
0	No response	-
1	Info	The converter issues an info event.
3	Warning	The converter issues a warning event.
10	Fault	The converter issues a fault event and stops modulation.
11	Fault, Open MCB	The converter issues a fault event, stops modulation, and opens the main circuit breaker.

P2.9.5.3.3 Temp. 3 Limit 2**No. 5216**

Set the temperature level for issuing a protection response.

P2.9.5.3.4 Temp. 3 Limit 2 Response**No. 5217**

Select the response for exceeding the limit.

No.	Name	Description
0	No response	-
1	Info	The converter issues an info event.
3	Warning	The converter issues a warning event.
10	Fault	The converter issues a fault event and stops modulation.
11	Fault, Open MCB	The converter issues a fault event, stops modulation, and opens the main circuit breaker.

7.3.9.5.4 Temp. 4 Protection**P2.9.5.4.1 Temp. 4 Input No. 5218**

Select the temperature sensor input for the temperature protection.

P2.9.5.4.2 Temp. 4 Limit 1 No. 5219

Set the temperature level for issuing a warning.

P2.9.5.4.3 Temp. 4 Limit 2 No. 5220

Set the temperature level for issuing a protection response.

P2.9.5.4.4 Temp. 4 Limit 2 Response No. 5221

Select the response for exceeding the limit.

No.	Name	Description
0	No response	-
1	Info	The converter issues an info event.
3	Warning	The converter issues a warning event.
10	Fault	The converter issues a fault event and stops modulation.
11	Fault, Open MCB	The converter issues a fault event, stops modulation, and opens the main circuit breaker.

7.3.9.5.5 Temp. 5 Protection

P2.9.5.5.1 Temp. 5 Input No. 5222

Select the temperature sensor input for the temperature protection.

P2.9.5.5.2 Temp. 5 Limit 1 No. 5223

Set the temperature level for issuing a warning.

P2.9.5.5.3 Temp. 5 Limit 2 No. 5224

Set the temperature level for issuing a protection response.

P2.9.5.5.4 Temp. 5 Limit 2 Response No. 5225

Select the response for exceeding the limit.

No.	Name	Description
0	No response	-
1	Info	The converter issues an info event.
3	Warning	The converter issues a warning event.
10	Fault	The converter issues a fault event and stops modulation.
11	Fault, Open MCB	The converter issues a fault event, stops modulation, and opens the main circuit breaker.

7.3.9.5.6 Temp. 6 Protection

P2.9.5.6.1 Temp. 6 Input No. 5226

Select the temperature sensor input for the temperature protection.

P2.9.5.6.2 Temp. 6 Limit 1 No. 5227

Set the temperature level for issuing a warning.

P2.9.5.6.3 Temp. 6 Limit 2 No. 5228

Set the temperature level for issuing a protection response.

P2.9.5.6.4 Temp. 6 Limit 2 Response No. 5229

Select the response for exceeding the limit.

No.	Name	Description
0	No response	-
1	Info	The converter issues an info event.
3	Warning	The converter issues a warning event.
10	Fault	The converter issues a fault event and stops modulation.
11	Fault, Open MCB	The converter issues a fault event, stops modulation, and opens the main circuit breaker.

7.3.9.5.7 Temp. 7 Protection

P2.9.5.7.1 Temp. 7 Input No. 5239

Select the temperature sensor input for the temperature protection.

P2.9.5.7.2 Temp. 7 Limit 1 No. 5243

Set the temperature level for issuing a warning.

P2.9.5.7.3 Temp. 7 Limit 2 No. 5269

Set the temperature level for issuing a protection response.

P2.9.5.7.4 Temp. 7 Limit 2 Response No. 5235

Select the response for exceeding the limit.

No.	Name	Description
0	No response	-
1	Info	The converter issues an info event.
3	Warning	The converter issues a warning event.
10	Fault	The converter issues a fault event and stops modulation.
11	Fault, Open MCB	The converter issues a fault event, stops modulation, and opens the main circuit breaker.

7.3.9.5.8 Temp. 8 Protection

P2.9.5.8.1 Temp. 8 Input No. 5240

Select the temperature sensor input for the temperature protection.

P2.9.5.8.2 Temp. 8 Limit 1 No. 5247

Set the temperature level for issuing a warning.

P2.9.5.8.3 Temp. 8 Limit 2 No. 5270

Set the temperature level for issuing a protection response.

P2.9.5.8.4 Temp. 8 Limit 2 Response**No. 5236**

Select the response for exceeding the limit.

No.	Name	Description
0	No response	-
1	Info	The converter issues an info event.
3	Warning	The converter issues a warning event.
10	Fault	The converter issues a fault event and stops modulation.
11	Fault, Open MCB	The converter issues a fault event, stops modulation, and opens the main circuit breaker.

7.3.9.5.9 Temp. 9 Protection**P2.9.5.9.1 Temp. 9 Input No. 5241**

Select the temperature sensor input for the temperature protection.

P2.9.5.9.2 Temp. 9 Limit 1 No. 5249

Set the temperature level for issuing a warning.

P2.9.5.9.3 Temp. 9 Limit 2 No. 5271

Set the temperature level for issuing a protection response.

P2.9.5.9.4 Temp. 9 Limit 2 Response No. 5237

Select the response for exceeding the limit.

No.	Name	Description
0	No response	-
1	Info	The converter issues an info event.
3	Warning	The converter issues a warning event.
10	Fault	The converter issues a fault event and stops modulation.
11	Fault, Open MCB	The converter issues a fault event, stops modulation, and opens the main circuit breaker.

7.3.9.5.10 Temp. 10 Protection**P2.9.5.10.1 Temp. 10 Input No. 5242**

Select the temperature sensor input for the temperature protection.

P2.9.5.10.2 Temp. 10 Limit 1 No. 5268

Set the temperature level for issuing a warning.

P2.9.5.10.3 Temp. 10 Limit 2 No. 5272

Set the temperature level for issuing a protection response.

P2.9.5.10.4 Temp. 10 Limit 2 Response**No. 5238**

Select the response for exceeding the limit.

No.	Name	Description
0	No response	-
1	Info	The converter issues an info event.
3	Warning	The converter issues a warning event.
10	Fault	The converter issues a fault event and stops modulation.
11	Fault, Open MCB	The converter issues a fault event, stops modulation, and opens the main circuit breaker.

7.3.9.5.11 Common**P2.9.5.11.1 Meas. Valid Range****No. 5230**

Set a valid reading range for the temperature probe measurements. The first element of the array is the higher and the second element the lower limit. An event is triggered if 1 of the readings goes above the higher, or below the lower limit.

P2.9.5.11.2 Meas. Out of Range Response**No. 5231**

Select the converter response when 1 or more of the probes exceed the valid range.

No.	Name	Description
0	No response	-
1	Info	The converter issues an info event.
3	Warning	The converter issues a warning event.
10	Fault	The converter issues a fault event and stops modulation.
11	Fault, Open MCB	The converter issues a fault event, stops modulation, and opens the main circuit breaker.

7.3.9.6 Thermistor Monitoring

The thermistor monitoring function provides three input channels that can be connected to a Positive Temperature Coefficient (PTC) type sensor. After a threshold of 4 kilo-ohms is exceeded in the input, an event is triggered. The event response can be configured.

P2.9.6.1 Thermistor Monitoring Response**No. 5232**

Select the response to all thermistor monitoring events.

No.	Name	Description
0	No response	-
1	Info	The converter issues an info event.
3	Warning	The converter issues a warning event.
10	Fault	The converter issues a fault event and stops modulation.
11	Fault, Open MCB	The converter issues a fault event, stops modulation, and opens the main circuit breaker.

P2.9.6.2 Thermistor Monitor 1 Input **No. 1520**

Select a thermistor input for the thermistor monitor 1.

No.	Name	Description
0	None (False)	No input is selected. A virtual value of FALSE is applied.
1	None (True)	No input is selected. A virtual value of TRUE is applied.
*	Available thermistor input terminals	A dynamically generated selection of available thermistor input terminals is presented as an option. The specific set depends on the type and number of I/O options installed in the system.

P2.9.6.3 Thermistor Monitor 2 Input **No. 1522**

Select a thermistor input for the thermistor monitor 2.

No.	Name	Description
0	None (False)	No input is selected. A virtual value of FALSE is applied.
1	None (True)	No input is selected. A virtual value of TRUE is applied.
*	Available thermistor input terminals	A dynamically generated selection of available thermistor input terminals is presented as an option. The specific set depends on the type and number of I/O options installed in the system.

P2.9.6.4 Thermistor Monitor 3 Input **No. 1524**

Select a thermistor input for the thermistor monitor 3.

No.	Name	Description
0	None (False)	No input is selected. A virtual value of FALSE is applied.
1	None (True)	No input is selected. A virtual value of TRUE is applied.
*	Available thermistor input terminals	A dynamically generated selection of available thermistor input terminals is presented as an option. The specific set depends on the type and number of I/O options installed in the system.

7.3.9.7 Fieldbus Protections

This group contains parameters for setting responses, delays, and other settings for fieldbus related protections.

P2.9.7.1 Fieldbus Fault Response**No. 1304**

Select the behavior when a fieldbus fault occurs.

No.	Name	Description
0	No response	-
1	Info	The converter issues an info event.
3	Warning	The converter issues a warning event.
10	Fault	The converter issues a fault event and stops modulation.
11	Fault, Open MCB	The converter issues a fault event, stops modulation, and opens the main circuit breaker.

P2.9.7.2 No Fieldbus Connection Response**No. 1305**

Select the response in case there is no fieldbus connection.

No.	Name	Description
0	No response	-
1	Info	The converter issues an info event.
3	Warning	The converter issues a warning event.
10	Fault	The converter issues a fault event and stops modulation.
11	Fault, Open MCB	The converter issues a fault event, stops modulation, and opens the main circuit breaker.

P2.9.7.3 Process Data Timeout Response**No. 1306**

Select the response to a process data timeout.

No.	Name	Description
0	No response	-
1	Info	The converter issues an info event.
3	Warning	The converter issues a warning event.
10	Fault	The converter issues a fault event and stops modulation.
11	Fault, Open MCB	The converter issues a fault event, stops modulation, and opens the main circuit breaker.

P2.9.7.4 Process Data Timeout Delay**No. 1340**

Set a delay for the triggering of the Process Data Timeout event. If process data has not been updated within this delay time the event is triggered.

P2.9.7.5 Fieldbus Watchdog Response No. 5244

Select the converter response for the fieldbus watchdog event.

No.	Name	Description
0	No response	-
1	Info	The converter issues an info event.
3	Warning	The converter issues a warning event.
10	Fault	The converter issues a fault event and stops modulation.
11	Fault, Open MCB	The converter issues a fault event, stops modulation, and opens the main circuit breaker.

P2.9.7.6 Fieldbus Watchdog Delay No. 5245

Set a delay for activating the fieldbus watchdog event.

P2.9.7.7 Fieldbus Watchdog Start Delay No. 5246

Set startup delay time for activating the fieldbus watchdog event. Counter begins when converter wakes up.

7.3.9.8 HMI Connection Loss

Selects the converter response for losing connection to MyDrive® Insight or the control panel while they are in control of the converter. Regardless of the response, the control is released to the control place with the next highest control priority.

P2.9.8.1 HMI Connection Loss No. 5420

Select the response after lost connection to control panel or PC tool while they are in control. The timeout occurs after 5 s.

No.	Name	Description
0	No response	-
2	Info – persistent	The converter issues an info event that requires acknowledgment to reset.
4	Warning – persistent	The converter issues a warning event that requires acknowledgment to reset.
10	Fault	The converter issues a fault event and stops modulation.
11	Fault, Open MCB	The converter issues a fault event, stops modulation, and opens the main circuit breaker.

7.3.9.9 Cooling Fan Supervision

P2.9.9.1 Main Fan Fail Response **No. 2939**

Select the converter response to a main fan fail.

No.	Name	Description
0	No response	-
1	Info	The converter issues an info event.
3	Warning	The converter issues a warning event.
10	Fault	The converter issues a fault event and stops modulation.
11	Fault, Open MCB	The converter issues a fault event, stops modulation, and opens the main circuit breaker.

P2.9.9.2 Internal Fan Fail Response **No. 2940**

Select the converter response to an internal fan fail.

No.	Name	Description
0	No response	-
1	Info	The converter issues an info event.
3	Warning	The converter issues a warning event.
10	Fault	The converter issues a fault event and stops modulation.
11	Fault, Open MCB	The converter issues a fault event, stops modulation, and opens the main circuit breaker.

7.3.9.10 Grid Frequency Supervision

P2.9.10.1 High Freq. Instant Fault Limit **No. 2840**

Set high limit for grid frequency. The converter trips when the actual grid frequency exceeds the limit; active only in run state.

P2.9.10.2 Low Freq. Instant Fault Limit **No. 2841**

Low limit for grid frequency; trips instantly if actual grid frequency is below this level; active only in run state.

7.3.9.11 Grid Voltage Supervision

P2.9.11.1 Grid Overvoltage Instant Fault Limit **No. 2842**

Overvoltage limit for grid voltage in % of nominal grid voltage; trips instantly if actual grid voltage exceeds this level; active only in run state.

P2.9.11.2 Grid Undervoltage Instant Fault Limit **No. 2843**

Undervoltage limit for grid voltage in % of nominal grid voltage; trips instantly if actual grid voltage is below this level; active only in run state.

7.3.9.12 Missing Grid Phase

P2.9.12.1 Phase Fault Limit Run **No. 266**

Imbalance needed in run state for missing phase condition to be true.

P2.9.12.2 Phase Fault Limit Stop No. 264

Imbalance needed in stop state for missing phase condition to be true.

P2.9.12.3 Phase Fault Delay No. 265

Time required for missing phase condition is true until trip is generated.

7.3.9.13 Pre-Charge Monitoring

P2.9.13.1 Max. Pre-Charge Time No. 6564

Set maximum allowed pre-charge time in seconds.

P2.9.13.2 Min. Pre-Charge Time No. 6565

Set minimum allowed pre-charge time in seconds.

P2.9.13.3 Ext. Pre-Charge Monitor Response No. 6568

Set the response of external pre-charge monitoring exception.

No.	Name	Description
0	No response	-
1	Info	The converter issues an info event.
3	Warning	The converter issues a warning event.
10	Fault	The converter issues a fault event and stops modulation.
11	Fault, Open MCB	The converter issues a fault event, stops modulation, and opens the main circuit breaker.

7.3.9.14 Input Section Over Temperature

P2.9.14.1 Input Section Overtemp. Input No. 5310

Select an input terminal for the mains input section overtemperature event. It is activated when the input becomes LOW, FALSE or 0.

P2.9.14.2 Input Section Overtemp. Response No. 5310

Select the response to the mains input section overtemperature event.

No.	Name	Description
0	No response	-
1	Info	The converter issues an info event.
3	Warning	The converter issues a warning event.
10	Fault	The converter issues a fault event and stops modulation.

7.4 G3 Maintenance & Service

This group contains auxiliary parameters for monitoring, commissioning, and servicing the converter.

7.4.1 Software Information

This group houses details about the software.

P3.1.1 Application Version No. 151

Shows the version of the application software.

7.4.1.1 Manifest

This is the manifest screen showing detailed software information in the control panel. With MyDrive® Insight, the same information is available in the “Device Info” screen. Check the available information via the control panel or MyDrive® Insight.

7.4.2 Events

When encountering issues, the converter can issue events of the Info, Warning, or Fault response type. This group contains information and parameters for monitoring and simulating these events.

7.4.2.1 Active Events

This is an active events screen shown only in the control panel. With MyDrive® Insight, the same information is available in the “Events” screen. Check the available information via the control panel or MyDrive® Insight.

7.4.2.2 Event History

This is the event history screen shown only in the control panel. With MyDrive® Insight, the same information is available in the “Events” screen. Check the available information via the control panel or MyDrive® Insight.

7.4.2.3 Event Simulation

The event simulation feature can be used to trigger any converter event without meeting the event criteria. This can be used to safely preview how the converter behaves during specific events. For instance, some events may trigger other functions, such as indications through digital outputs. This feature is useful for checking the setup, configuration, and validity of such functions during specific events.

NOTICE

This feature is for commissioning and testing purposes. It is not meant for functional use.

WARNING

This feature can stop the converter and possibly trigger external events. Do not use without proper knowledge of the system.

How to simulate an event:

1. Refer to the Events Summary Table to get the event number and details for the specific event you are interested in.
2. Set the event number with parameter No. 1402.
3. Activate the simulation by setting parameter No. 1401 to your desired simulation response.
4. When you want to end the simulation, set parameter No. 1401 back to “Disabled”.
5. If required, give a Fault Reset command to acknowledge a simulated event.
6. If required, reboot the converter to acknowledge “Trip Locked” events.

P3.2.3.1 Event Simulation No. 1401

Simulates the selected event with the selected response. Simulation begins when changing value from Disabled. To reset a simulated event, this parameter must be set back to Disabled first.

No.	Name	Description
0	Disabled	Event simulator is inactive
1	Lowest Response	The event selected with parameter No. 1402 is activated with its lowest event response. Note that if the event can be configured with a response parameter, the response parameter's setting will apply to the simulation.
10	Highest Response	The event selected with parameter No. 1402 is activated with its highest event response. Note that if the event can be configured with a response parameter, the response parameter's setting will apply to the simulation.

P3.2.3.2 Event Sim. Number No. 1402

Select an event to be simulated by its number. Refer to the **Error! Reference source not found.** section to check the number of each event.

7.4.3 Operational Counters

This group shows readouts of converter's operational counters.

P3.3.1 Control Unit On Time No. 2000

Shows the total operating time for the control unit.

P3.3.2 Power Unit On Time No. 2001

Shows the total operating time for the power unit. The counter only increments if the DC link is powered.

P3.3.3 Energy Consumption No. 2002

Shows the energy consumed.

P3.3.4 Ground Faults No. 2004

Shows the total number of ground faults.

P3.3.5 Overvoltage Faults No. 2005

Shows the total number of overvoltage faults.

P3.3.6 Overcurrent Faults No. 2006

Shows the total number of overcurrent faults.

P3.3.7 Short Circuit Faults No. 2007

Shows the total number of short-circuit faults.

7.4.4 Backup & Restore

This menu is used to access the backup and restore functions from the control panel.

7.4.4.1 Backup

This is a menu screen for creating parameter backups from the control panel. With MyDrive® Insight, similar options are available via the “Backup” button within the “Parameters” screen. Check the available settings via the control panel or MyDrive® Insight.

7.4.4.2 Restore

This is a menu for restoring parameter backups from the control panel. With MyDrive® Insight, similar options are available via the “Restore” button within the “Parameters” screen. Check the available settings via the control panel or MyDrive® Insight.

7.5 G5 Customization

7.5.1 Basic Settings

P5.1.1 Date and Time **No. 2800**

Set the actual time and date. Format is YYYY-MM-DD and HH:MM:SS.

7.5.2 Control Panel

The parameters in this group allow the operator to select 1-5 signals for monitoring in the two control panel readout screens. These screens are visible in the panel’s home screen, which can be accessed by pressing the “Home”-button (the house icon). Readout Screen 1 appears first. By navigating downwards with the arrow buttons, Readout Screen 2 appears.

7.5.2.1 Readout Screen 1

P5.2.1.1 Readout Field 1.1 **No. 300**

Select the parameter for readout field (screen 1 field 1).

No.	Name	Description
0	None	
9044	DC-link Voltage	
9041	Grid Frequency	
9040	Grid Voltage	
2950	Heat Sink Temperature	
2952	Control Unit Temperature	
9053	Grid Power Factor	
5115	DC-link Current	
5117	DC-link Power	
9060	Grid Current	
9064	Grid Active Power	
9051	Grid Reactive Power	

P5.2.1.2 Readout Field 1.2 No. 301

Select the parameter for readout field (screen 1 field 2).
Same selection as Field 1.1 (No. 300).

P5.2.1.3 Readout Field 1.3 No. 302

Select the parameter for readout field (screen 1 field 3).
Same selection as Field 1.1 (No. 300).

P5.2.1.4 Readout Field 1.4 No. 303

Select the parameter for readout field (screen 1 field 4).
Same selection as Field 1.1 (No. 300).

P5.2.1.5 Readout Field 1.5 No. 304

Select the parameter for readout field (screen 1 field 5).
Same selection as Field 1.1 (No. 300).

7.5.2.2 Readout Screen 2**P5.2.2.1 Readout Field 2.1 No. 310**

Select the parameter for readout field (screen 2 field 1).
Same selection as Field 1.1 (No. 300).

P5.2.2.2 Readout Field 2.2 No. 311

Select the parameter for readout field (screen 2 field 2).
Same selection as Field 1.1 (No. 300).

P5.2.2.3 Readout Field 2.3 No. 312

Select the parameter for readout field (screen 2 field 3).
Same selection as Field 1.1 (No. 300).

P5.2.2.4 Readout Field 2.4 No. 313

Select the parameter for readout field (screen 2 field 4).
Same selection as Field 1.1 (No. 300).

P5.2.2.5 Readout Field 2.5 No. 314

Select the parameter for readout field (screen 2 field 5).
Same selection as Field 1.1 (No. 300).

7.6 G9 Option Board Settings

This group contains readouts and parameters for setting up input and output options such as digital and analog I/O, feedback signals, or thermal measurements. The associated parameters appear in this menu based on the options connected to the converter. The following is not a definitive set of all iC7 compatible options, but just a collection of the most common and relevant options for the Active Front End application.

7.6.1 I/O And Relay

Note that this group and its subgroups appear only if an I/O And Relay OC7C1 option is included in the converter. This menu appears as many times as there are these options in the system. Each menu and its parameters have the suffix of their option slot.

7.6.1.1 I/O And Relay Status

P9.3.1 Digital Input Bit Word **No. 1614**

Shows the bitwise status of each digital input of this card.

Bit No.	Name	Description
0	Digital Input T13	TRUE = Over 15 Vdc is applied between X13 T13 and Digital Input GND. FALSE = Less than 5 Vdc is applied between X13 T13 and Digital Input GND.
1	Digital Input T14	TRUE = Over 15 Vdc is applied between X13 T14 and Digital Input GND. FALSE = Less than 5 Vdc is applied between X13 T14 and Digital Input GND.
2	Digital Input T15	TRUE = Over 15 Vdc is applied between X13 T15 and Digital Input GND. FALSE = Less than 5 Vdc is applied between X13 T15 and Digital Input GND.
3	Digital Input T16	TRUE = Over 15 Vdc is applied between X13 T16 and Digital Input GND. FALSE = Less than 5 Vdc is applied between X13 T16 and Digital Input GND.
4	Digital Input T17	TRUE = Over 15 Vdc is applied between X13 T17 and Digital Input GND. FALSE = Less than 5 Vdc is applied between X13 T17 and Digital Input GND.
5	Digital Input T18	TRUE = Over 15 Vdc is applied between X13 T18 and Digital Input GND. FALSE = Less than 5 Vdc is applied between X13 T18 and Digital Input GND.
6-11	Reserved	
12	Thermistor T71	TRUE = More than 4 k Ω is connected between X51 T71 and T72. FALSE = Less than 4 k Ω is connected between X51 T71 and T72.
13-15	Reserved	

P9.3.2 Digital Output Bit Word **No. 1615**

Shows the bitwise status of each digital output of this card.

Bit No.	Name	Description
0-1	Reserved	
2	Digital Output T21	TRUE = Connection between X13 T21 and I/O GND is active. FALSE = Connection between X13 T21 and I/O GND is active.
3	Digital Output T22	TRUE = Connection between X13 T22 and I/O GND is active. FALSE = Connection between X13 T22 and I/O GND is active.
4-11	Reserved	
12	Relay T02	TRUE = Connection between X101 T01 (COM) and T02 (NO) is active. FALSE = Connection between X101 T01 (COM) and T03 (NC) is active.
13	Relay T05	TRUE = Connection between X102 T04 (COM) and T05 (NO) is active. FALSE = Connection between X102 T04 (COM) and T06 (NC) is active.
14	Relay T08	TRUE = Connection between X103 T04 (COM) and T08 (NO) is active. FALSE = Connection between X103 T04 (COM) and T08 (NO) is inactive.
15	Reserved	

P9.3.3 T31 Analog Output Value **No. 1613**

Shows the actual value of the terminal.

P9.3.4 T33 Analog Input Value **No. 1611**

Shows the actual value of the terminal.

P9.3.5 T34 Analog Input Value **No. 1612**

Shows the actual value of the terminal.

7.6.1.2 Digital Inputs/Outputs

7.6.1.2.1 Input T13

P9.4.1.1 T13 Terminal Mode **No. 2015**

Select the mode for the terminal.

No.	Name	Description
0	Inactive	
3	Digital Input	

P9.4.1.2 T13 Signal Inversion **No. 2291**

Select whether the signal of the terminal is inverted.

No.	Name	Description
0	Non-Inverted	
1	Digital Inverted	

P9.4.1.3 T13 Standard Debounce Filtering Time**No. 2024**

Set the standard debounce filtering time for the terminal.

7.6.1.2.2 Input T14**P9.4.2.1 T14 Terminal Mode No. 2016**

Select the mode for the terminal.

No.	Name	Description
0	Inactive	
3	Digital Input	

P9.4.2.2 T14 Signal Inversion No. 2292

Select whether the signal of the terminal is inverted.

No.	Name	Description
0	Non-Inverted	
1	Digital Inverted	

P9.4.2.3 T14 Standard Debounce Filtering Time**No. 2029**

Set the standard debounce filtering time for the terminal.

7.6.1.2.3 Input T15**P9.4.3.1 T15 Terminal Mode No. 2022**

Select the mode for the terminal.

No.	Name	Description
0	Inactive	
3	Digital Input	

P9.4.3.2 T15 Signal Inversion No. 2295

Select whether the signal of the terminal is inverted.

No.	Name	Description
0	Non-Inverted	
1	Digital Inverted	

P9.4.3.3 T15 Standard Debounce Filtering Time**No. 2297**

Set the standard debounce filtering time for the terminal.

7.6.1.2.4 Input T16

P9.4.4.1 T16 Terminal Mode **No. 2298**

Select the mode for the terminal.

No.	Name	Description
0	Inactive	
3	Digital Input	

P9.4.4.2 T16 Signal Inversion **No. 2296**

Select whether the signal of the terminal is inverted.

No.	Name	Description
0	Non-Inverted	
1	Digital Inverted	

P9.4.4.3 T16 Standard Debounce Filtering Time **No. 2260**

Set the standard debounce filtering time for the terminal.

7.6.1.2.5 Input T17

P9.4.5.1 T17 Terminal Mode **No. 2017**

Select the mode for the terminal.

No.	Name	Description
0	Inactive	
3	Digital Input	

P9.4.5.2 T17 Signal Inversion **No. 2293**

Select whether the signal of the terminal is inverted.

No.	Name	Description
0	Non-Inverted	
1	Digital Inverted	

P9.4.5.3 T17 Standard Debounce Filtering Time **No. 2034**

Set the standard debounce filtering time for the terminal.

7.6.1.2.6 Input T18

P9.4.6.1 T18 Terminal Mode **No. 2018**

Select the mode for the terminal.

No.	Name	Description
0	Inactive	
3	Digital Input	

P9.4.6.2 T18 Signal Inversion No. 2294

Select whether the signal of the terminal is inverted.

No.	Name	Description
0	Non-Inverted	
1	Digital Inverted	

P9.4.6.3 T18 Standard Debounce Filtering Time No. 2039

Set the standard debounce filtering time for the terminal.

7.6.1.2.7 Output T21

P9.4.7.1 T21 Terminal Mode No. 4015

Select the mode for the terminal.

No.	Name	Description
0	Inactive	
1	Digital Output	

P9.4.7.2 T21 Digital Output Type No. 4013

Select the operating logic for the digital output.

No.	Name	Description
0	Tri state	
1	Open collector sink (NPN)	
2	Open collector source (PNP)	
3	Push pull	

7.6.1.2.8 Output T22

P9.4.8.1 T22 Terminal Mode No. 4016

Select the mode for the terminal.

No.	Name	Description
0	Inactive	
1	Digital Output	

P9.4.8.2 T22 Digital Output Type**No. 4014**

Select the operating logic for the digital output.

No.	Name	Description
0	Tri state	
1	Open collector sink (NPN)	
2	Open collector source (PNP)	
3	Push pull	

7.6.1.3 Analog Inputs/Outputs**7.6.1.3.1 Output T31****P9.5.1.1 T31 Terminal Mode****No. 2019**

Select the mode for the terminal.

No.	Name	Description
0	Inactive	
5	Analog Output	

P9.5.1.2 T31 Terminal Type**No. 2284**

Select the type of the terminal. If voltage is selected, the unit is V. If current is selected, the unit is mA.

No.	Name	Description
0	Off	
1	Voltage	
2	Current	

P9.5.1.3 T31 Minimum Value**No. 2283**

Set the voltage or current representing 0% of the signal.

P9.5.1.4 T31 Maximum Value**No. 2282**

Set the voltage or current representing 100% of the signal.

7.6.1.3.2 Input T33**P9.5.2.1 T33 Terminal Mode****No. 2020**

Select the mode for the terminal.

No.	Name	Description
0	Inactive	
6	Analog Input	

P9.5.2.2 T33 Terminal Type No. 2273

Select the type of the terminal. If voltage is selected, the unit is V. If current is selected, the unit is mA.

No.	Name	Description
1	Voltage	
2	Current	

P9.5.2.3 T33 Minimum Value No. 2272

Set the voltage or current representing 0% of the signal.

P9.5.2.4 T33 Maximum Value No. 2271

Set the voltage or current representing 100% of the signal.

P9.5.2.5 T33 Filter Time No. 2270

Set the filter time for the terminal.

P9.5.2.6 T33 Live Zero Threshold Value No. 2274

Set the live zero threshold value for the terminal. The response to a live zero event is defined with parameter No. 4555 "Live Zero Response".

P9.5.2.7 T33 Live Zero Timeout Value No. 2275

Set the live zero timeout value for the terminal. The response to a live zero event is defined with parameter No. 4555 "Live Zero Response".

7.6.1.3.3 Input T34

P9.5.3.1 T34 Terminal Mode No. 2021

Select the mode for the terminal.

No.	Name	Description
0	Inactive	
6	Analog Input	

P9.5.3.2 T34 Terminal Type No. 2279

Select the type of the terminal. If voltage is selected, the unit is V. If current is selected, the unit is mA.

No.	Name	Description
1	Voltage	
2	Current	

P9.5.3.3 T34 Minimum Value No. 2278

Set the voltage or current representing 0% of the signal.

P9.5.3.4 T34 Maximum Value No. 2277

Set the voltage or current representing 100% of the signal.

P9.5.3.5 T34 Filter Time No. 2276

Set the filter time for the terminal.

P9.5.3.6 T34 Live Zero Threshold Value No. 2280

Set the live zero threshold value for the terminal. The response to a live zero event is defined with parameter No. 4555 "Live Zero Response".

P9.5.3.7 T34 Live Zero Timeout Value No. 2281

Set the live zero timeout value for the terminal. The response to a live zero event is defined with parameter No. 4555 "Live Zero Response".

7.6.2 Temperature Measurement

This group and its subgroups appear only if a Temperature Measurement OC7T0 option is included in the converter. This menu appears as many times as there are these options in the system. Each menu and its parameters have the suffix of their option slot.

7.6.2.1 Temperature Measurement Status

P9.3.2 T4 Temperature Value No. 4040

Shows the measured temperature of the terminal.

P9.3.3 T8 Temperature Value No. 4041

Shows the measured temperature of the terminal.

P9.3.4 T12 Temperature Value No. 4042

Shows the measured temperature of the terminal.

P9.3.5 T16 Temperature Value No. 4043

Shows the measured temperature of the terminal.

P9.3.6 T20 Temperature Value No. 4044

Shows the measured temperature of the terminal.

7.6.2.2 Temperature inputs

7.6.2.2.1 Input T4

P9.4.1.1 T4 Terminal Mode No. 4045

Select the mode for the terminal.

No.	Name	Description
0	Inactive	
7	Temperature input	

P9.4.1.2 T4 Connection Type No. 4046

Select the connection type for the sensor.

No.	Name	Description
0	No sensor	
2	2-wire	
3	3-wire	
4	4-wire	

P9.4.1.3 T4 Temperature Sensor Type No. 4047

Select which type of temperature sensor is connected to the terminal.

No.	Name	Description
0	No sensor	
1	Pt100	
2	2xPt100	
3	3xPt100	
4	Pt1000	
5	Ni1000Tk5000	
6	Ni1000Tk6180	
7	KTY84-1x0	
8	KTY84-151	
9	KTY84-152	
10	KTY81/82-1x0	
11	KTY81/82-121	
12	KTY81/82-122	
13	KTY81/82-151	
14	KTY81/82-152	
15	KTY81/82-2x0	
16	KTY81/82-221	
17	KTY81/82-222	
18	KTY81/82-251	
19	KTY81/82-252	

P9.4.1.4 T4 Offset No. 4048

Set the offset of the temperature measured.

7.6.2.2.2 Input T8

P9.4.2.1 T8 Terminal Mode No. 4049

Select the mode for the terminal.

No.	Name	Description
0	Inactive	
7	Temperature input	

P9.4.2.2 T8 Connection Type No. 4050

Select the connection type for the sensor.

No.	Name	Description
0	No sensor	
2	2-wire	
3	3-wire	
4	4-wire	

P9.4.2.3 T8 Temperature Sensor Type No. 4051

Select which type of temperature sensor is connected to the terminal.

No.	Name	Description
0	No sensor	
1	Pt100	
2	2xPt100	
3	3xPt100	
4	Pt1000	
5	Ni1000Tk5000	
6	Ni1000Tk6180	
7	KTY84-1x0	
8	KTY84-151	
9	KTY84-152	
10	KTY81/82-1x0	
11	KTY81/82-121	
12	KTY81/82-122	
13	KTY81/82-151	
14	KTY81/82-152	
15	KTY81/82-2x0	
16	KTY81/82-221	
17	KTY81/82-222	
18	KTY81/82-251	
19	KTY81/82-252	

P9.4.2.4 T8 Offset No. 4052

Set the offset of the temperature measured.

7.6.2.2.3 Input T12

P9.4.3.1 T12 Terminal Mode No. 4053

Select the mode for the terminal.

No.	Name	Description
0	Inactive	
7	Temperature input	

P9.4.3.2 T12 Connection Type No. 4054

Select the connection type for the sensor.

No.	Name	Description
0	No sensor	
2	2-wire	
3	3-wire	
4	4-wire	

P9.4.3.3 T12 Temperature Sensor Type**No. 4055**

Select which type of temperature sensor is connected to the terminal.

No.	Name	Description
0	No sensor	
1	Pt100	
2	2xPt100	
3	3xPt100	
4	Pt1000	
5	Ni1000Tk5000	
6	Ni1000Tk6180	
7	KTY84-1x0	
8	KTY84-151	
9	KTY84-152	
10	KTY81/82-1x0	
11	KTY81/82-121	
12	KTY81/82-122	
13	KTY81/82-151	
14	KTY81/82-152	
15	KTY81/82-2x0	
16	KTY81/82-221	
17	KTY81/82-222	
18	KTY81/82-251	
19	KTY81/82-252	

P9.4.3.4 T12 Offset**No. 4056**

Set the offset of the temperature measured.

7.6.2.2.4 Input T16**P9.4.4.1 T16 Terminal Mode****No. 2298**

Select the mode for the terminal.

No.	Name	Description
0	Inactive	
7	Temperature input	

P9.4.4.2 T16 Connection Type No. 4058

Select the connection type for the sensor.

No.	Name	Description
0	No sensor	
2	2-wire	
3	3-wire	
4	4-wire	

P9.4.4.3 T16 Temperature Sensor Type No. 4059

Select which type of temperature sensor is connected to the terminal.

No.	Name	Description
0	No sensor	
1	Pt100	
2	2xPt100	
3	3xPt100	
4	Pt1000	
5	Ni1000Tk5000	
6	Ni1000Tk6180	
7	KTY84-1x0	
8	KTY84-151	
9	KTY84-152	
10	KTY81/82-1x0	
11	KTY81/82-121	
12	KTY81/82-122	
13	KTY81/82-151	
14	KTY81/82-152	
15	KTY81/82-2x0	
16	KTY81/82-221	
17	KTY81/82-222	
18	KTY81/82-251	
19	KTY81/82-252	

P9.4.4.4 T16 Offset No. 4060

Set the offset of the temperature measured.

7.6.2.2.5 Input T20

P9.4.5.1 T20 Terminal Mode No. 4017

Select the mode for the terminal.

No.	Name	Description
0	Inactive	
7	Temperature input	

P9.4.5.2 T20 Connection Type No. 4062

Select the connection type for the sensor.

No.	Name	Description
0	No sensor	
2	2-wire	
3	3-wire	
4	4-wire	

P9.4.5.3 T20 Temperature Sensor Type No. 4063

Select which type of temperature sensor is connected to the terminal.

No.	Name	Description
0	No sensor	
1	Pt100	
2	2xPt100	
3	3xPt100	
4	Pt1000	
5	Ni1000Tk5000	
6	Ni1000Tk6180	
7	KTY84-1x0	
8	KTY84-151	
9	KTY84-152	
10	KTY81/82-1x0	
11	KTY81/82-121	
12	KTY81/82-122	
13	KTY81/82-151	
14	KTY81/82-152	
15	KTY81/82-2x0	
16	KTY81/82-221	
17	KTY81/82-222	
18	KTY81/82-251	
19	KTY81/82-252	

P9.4.5.4 T20 Offset No. 4064

Set the offset of the temperature measured.

7.6.3 Voltage Measurement

This group and its subgroups appear only if a Voltage Measurement OC7V0 option is included in the converter. This menu appears as many times as there are these options in the system. Each menu and its parameters have the suffix of their option slot.

7.6.3.1 Voltage Measurement Status**P9.3.1 X52 Voltage No. 4086**

Shows the voltage vector length in the external voltage measurement board channel X52.

P9.3.2 X52 Frequency No. 4087

Shows the frequency in the external voltage measurement board channel X52.

P9.3.3 X52 Phase Diff. No. 4088

Shows the phase difference between external voltage measurement board channel X52 phase and control's coordinate system.

P9.3.4 X52 Voltage L1 No. 4082

Shows the voltage of pin L1 of connector X52 of the external voltage measurement board.

P9.3.5 X52 Voltage L3 No. 4083

Shows the voltage of pin L3 of connector X52 of the external voltage measurement board.

P9.3.6 X53 Voltage No. 4089

Shows the voltage vector length in the external voltage measurement board channel X53.

P9.3.7 X53 Frequency No. 4090

Shows the frequency in the external voltage measurement board channel X53.

P9.3.8 X53 Phase Diff. No. 4091

Shows the phase difference between external voltage measurement board channel X53 phase and control's coordinate system.

P9.3.9 X53 Voltage L1 No. 4084

Shows the voltage of pin L1 of connector X53 of the external voltage measurement board.

P9.3.10 X53 Voltage L3 No. 4085

Shows the voltage of pin L3 of connector X53 of the external voltage measurement board.

7.6.3.2 Voltage Input X52

P9.4.1 X52 Terminal Mode **No. 4099**

Select operation mode of terminals on connector X52.

No.	Name	Description
0	Inactive	Connector X52 does not measure anything.
1	AC Voltage	Connector X52 is configured to measure AC voltage.
2	DC Voltage	Connector X52 is configured to measure DC voltage.

P9.4.2 X52 Terminal Voltage Range **No. 4100**

Set the terminal voltage range for voltage measurement option connector X52.

P9.4.3 X52 Meas. Transformer Grid-Side Voltage **No. 4101**

Set the grid-side winding nominal voltage of measurement transformer connected to voltage measurement option X52.

P9.4.4 X52 Meas. Transformer Converter-Side Voltage **No. 4102**

Set the converter-side winding nominal voltage of measurement transformer connected to voltage measurement option X52.

P9.4.5 X52 Meas. Transformer Phase Shift **No. 4103**

Set the phase shift of converter-side voltage to grid-side voltage of measurement transformer connected to voltage measurement option X52. Positive values (counterclockwise) phase-lead. Negative values (clockwise) phase-lag.

7.6.3.3 Voltage Input X53

P9.5.1 X53 Terminal Mode **No. 4104**

Select the operation mode of terminals on connector X53.

No.	Name	Description
0	Inactive	Connector X53 does not measure anything.
1	AC Voltage	Connector X53 is configured to measure AC voltage.
2	DC Voltage	Connector X53 is configured to measure DC voltage.

P9.5.2 X53 Terminal Voltage Range **No. 4105**

Set the terminal voltage range for voltage measurement option connector X53.

P9.5.3 X53 Meas. Transformer Grid-Side Voltage **No. 4106**

Set the grid-side winding nominal voltage of measurement transformer connected to voltage measurement option X53.

P9.5.4 X53 Meas. Transformer Converter-Side Voltage **No. 4107**

Set the converter-side winding nominal voltage of measurement transformer connected to voltage measurement option X53.

7.7.1.1.4 Ethernet port X0

7.7.1.1.4.1 X0 Settings

P10.1.1.4.1.1 Link configuration X0 **No. 7047**

Select the configuration of the Ethernet link parameters.

No.	Name	Description
0	Auto negotiation	
1	10 Mbps full duplex	
2	10 Mbps half duplex	
3	100 Mbps full duplex	
4	100 Mbps half duplex	

7.7.1.1.5 Ethernet port X1

7.7.1.1.5.1 X1 Settings

P10.1.1.5.1.1 Link Configuration X1 **No. 7048**

Select the configuration of the Ethernet link parameters.

No.	Name	Description
0	Auto negotiation	
1	10 Mbps full duplex	
2	10 Mbps half duplex	
3	100 Mbps full duplex	
4	100 Mbps half duplex	

7.7.1.1.6 Ethernet port X2

7.7.1.1.6.1 X2 Settings

P10.1.1.6.1.1 Link Configuration X2 **No. 7049**

Select the configuration of the Ethernet link parameters.

No.	Name	Description
0	Auto negotiation	
1	10 Mbps full duplex	
2	10 Mbps half duplex	
3	100 Mbps full duplex	
4	100 Mbps half duplex	

7.7.1.1.7 Port Mirroring

This is a menu screen for enabling and disabling the port-mirroring function for network troubleshooting with a network analyzer tool. Check the available configurations via the control panel or MyDrive® Insight.

7.7.1.2 Protocols

7.7.1.2.1 PROFINET®

7.7.1.2.1.1 Status

7.7.1.2.1.1.1 PROFINET® Report

This is the PROFINET® report screen showing active PROFINET® connection and configuration information. Check the available information via the control panel or MyDrive® Insight.

7.7.1.2.1.1.2 Configuration

P10.1.2.1.2.1 Name of Station **No. 7080**

Set the name of station. The PROFINET® device is identified by its name of station. Each name must be unique in the network.

7.7.1.2.1.1.3 Diagnosis

P10.1.2.1.3.1 Diagnostic Fault **No. 7081**

Enables diagnostic fault. When disabled the device will not send any PROFINET® diagnosis message with severity "Fault" when a fault is present on device.

No.	Name	Description
0	Disabled	Fault diagnosis messages are not sent.
1	Enabled	Fault diagnosis messages are sent.

P10.1.2.1.3.2 Diagnostic Warning **No. 7083**

Enables diagnostic warning. When disabled the device will not send any PROFINET® diagnosis message with severity "Maintenance required" when a warning is present on device.

No.	Name	Description
0	Disabled	Warning diagnosis messages are not sent.
1	Enabled	Warning diagnosis messages are sent.

7.7.1.2.1.2 Modbus® TCP

7.7.1.2.1.2.1 Configuration

P10.1.2.2.1.1 Persistent Storage **No. 7061**

Select if persistent storage is active for Modbus® writes.

No.	Name	Description
0	Disabled	When writing to configuration parameters via a Modbus® protocol, the latest written value is not stored to memory. If the converter is rebooted the latest written value is lost.
1	Enabled	When writing to configuration parameters via a Modbus® protocol, the latest written value is stored to memory. If the converter is rebooted the latest written value is retained.

P10.1.2.2.1.2 Byte Order**No. 7062**

Select the byte order.

No.	Name	Description
0	Big Endian	<ul style="list-style-type: none"> Decreasing byte order. The value being read/written starts from the most significant byte and ends with the least significant byte of the source value.
1	Little Endian	<ul style="list-style-type: none"> Increasing byte order. The value being read/written starts from the least significant byte and ends with the most significant byte of the source value.

P10.1.2.2.1.3 Word Order**No. 7063**

Select the word order.

No.	Name	Description
0	Big Endian	<ul style="list-style-type: none"> Decreasing word order. The value being read/written starts from the most significant word and ends with the least significant word of the source value.
1	Little Endian	<ul style="list-style-type: none"> Increasing word order. The value being read/written starts from the least significant word and ends with the most significant word of the source value.

8 Troubleshooting

8.1 Viewing and Resetting Events

The iC7 power converter series can produce three types of events. Info, Warning, and Fault type events.

Info events are events for mainly notifying the user of a situation, or to log events into the history log. Info events are not highlighted through any indicator LEDs, for example. An active info and its details can be viewed in the Active Events list and the same information is stored into the Event History. An info event is reset automatically once the triggering conditions are no longer active.

When a warning event occurs, status indicators on the control panel and control board LEDs turn yellow, and a yellow, triangular warning symbol appears in the device status panel of MyDrive® Insight. An active warning and its details can be viewed in the Active Events list and the same information is stored into the Event History. When a warning is active the converter remains operational. A warning event is reset automatically once the triggering conditions are no longer active.

When a fault event occurs, status indicators on the control panel and control board LEDs turn red, and a red, bell-shaped fault symbol appears in the device status panel of MyDrive® Insight. An active fault and its details can be viewed in the Active Events list and the same information is stored into the Event History. When a fault becomes active, the converter stops operation. Depending on the fault and user settings, the main circuit breaker can also be opened. To reset a fault event, the fault triggering conditions must be inactive, and a reset command (fault acknowledgment) must be given to the converter.

To access the Active Events on the control panel, press the info button on the home screen, or navigate to **“3.2.1 Active Events”** in the parameter menu. With MyDrive® Insight, establish a connection to the drive and navigate to “Events > Live”.

To access the Event History on the control panel, navigate to **“3.2.2 Event History”** in the parameter menu. With MyDrive® Insight, establish a connection to the drive and navigate to “Events > Live”.

8.2 Reading the Event Summary Table

The following chapter contains a summarized table of all the events in an Active Front End converter.

Events in iC7 converters have 2 different identifiers: Group numbers and Individual numbers. The group numbers for iC7 converters follow the DRIVECOM industry standard error code specification. The specification originated with the Interbus communication profile. The [Interbus V3.0 base profile](#) was released on 2018-04-19. The [inverter specific profile](#) was released on 1997-12-15. The error code specification was adopted by CAN in Automation and ODVA and is used within their respective Converter Profile. The list of standardized error codes can be found within [IEC 61800-7-201](#).

Unlike individual numbers, the group numbers are not unique since multiple errors can be related to each other. An example is different ground faults which share the Group Number 0x2330.

The rest of the table shows a display name, a brief description, possible causes for the event, and associated mitigation actions (if applicable).

8.3 Events Summary for Active Front End

Group	Number	Name	Description	Possible causes	Mitigation Actions
0x2110	4379	CM Current High	An excessive common mode current has been detected in the LCL-filter.	Faulty components. Loose cable connection. Faulty cables.	Check the components, cables, and connections.
0x2212	4374	DC-link Resonance	A resonance on the DC link with excessive RMS current values has been detected.	Switching frequency or its 2nd multiple is in the range of system resonance frequency.	Contact Danfoss service.
0x2221	4384	Thermal Overload Rectifier	The rectifier is thermally overloaded. Mission profile is too demanding.	Too high loading on the rectifier.	Check the load profile.
0x2222	4373	DC-link Overcurrent	An overcurrent on the main DC-link capacitors has been detected.	Faulty DC-link capacitor.	Contact Danfoss service.
0x2311	4097	Inverter Overload	Thermal overload is detected in the inverter of the drive.	Too high loading of the inverter.	Reduce the output load. Consider applying limits.
	4368	Output Current High 0	The output current of the drive has exceeded its normal range at low speed.	Shock load or too fast acceleration with high-inertia loads can cause this fault.	Check that the motor size matches the drive, and the motor data is correct.
	4369	Output Current High 1	The output current of the drive has exceeded its normal range.		Check that the motor shaft can be turned.
	4375	Excessive Current Limiting	The output current of the drive has exceeded the current limit multiple times.	Motor and drive mismatch. Motor misconfiguration. Too high loading of the inverter. Blocked motor shaft.	Check that the motor size matches the drive, and the motor data is correct. Check that the motor shaft can be turned.
	4377	Smart Derating Fault	A Smart Derating fault is detected.	The load is too demanding for the current derating level.	Lower the switching frequency if possible.
	4380	Current Limit Setting Fault	The actual current limit setting is too high relative to the selected constant control frequency level.	Incorrect current limit or modulation settings.	Reduce the control frequency setting or reduce the current limit setting.
	5129	Overload Event	Overload is detected based on motor current, torque, or power.	Too high loading of the inverter.	Reduce the output load. Consider applying limits.

Application Guide

Group	Number	Name	Description	Possible causes	Mitigation Actions
0x2330	4352	Ground Fault 0	A high-impedance ground fault is detected on the output.	Damaged motor cable or motor.	Check the insulation of motor cable and motor.
	4353	Ground Fault 1			
	4354	Ground Fault 2	A low-impedance ground fault is detected on the output.		
	4355	Ground Fault 21	A high or low-impedance ground fault is detected on the output.		
0x2340	4356	Inverter Short Circuit	A short circuit at the inverter output is detected.	Damaged motor cable or motor.	Check the motor and motor cable.
	4370	Output Current High 2	A critical output overcurrent has been detected.	Damaged motor cable or motor.	Check for short circuits on the output.
	4649	Desat Gate Driver	The gate driver has detected desaturation condition.	Faulty component. Extremely high overcurrent.	Contact your local Danfoss service. If the fault occurs the same time as Overcurrent fault, check installations and components from AC output to load.
0x23fe	4371	Current Imbalance	A current imbalance between paralleled power units has been detected.	Faulty current measurement. Impedance mismatch from parallel modules to point of common coupling. Transistor switching time compensation disabled.	Check installation connections. Contact your local Danfoss distributor.
0x3110	4162	Grid Voltage Spikes	Excessive spikes on the grid voltage have been detected.	Faulty grid supply. Loose cable connection. Faulty cables or fuses.	Check the grid supply, cables, connections, and fuses.
	4164	Grid Voltage High	Grid voltage (RMS) above the normal operating range is detected.	Faulty grid supply. Loose cable connection. Faulty cables or fuses. Wrong unit voltage class selection.	Check unit voltage class selection. Check the grid supply, cables, connections, and fuses.
0x3120	4165	Grid Voltage Low	A grid voltage (RMS) below the normal operating range is detected.	Faulty grid supply. Loose cable connection. Faulty cables or fuses. Wrong unit voltage class selection.	Check unit voltage class selection. Check the grid supply, cables, connections, and fuses.
0x3130	4160	Missing Grid Phase	A missing phase is	Faulty grid supply.	Check the grid supply,

Application Guide

Group	Number	Name	Description	Possible causes	Mitigation Actions
	4163	Grid Imbalance	detected on the grid side. A large imbalance of the grid voltages is detected.	Loose cable connection. Faulty cables or fuses.	cables, connections, and fuses.
0x3140	4161	Grid Frequency Out of Range	A grid frequency outside the normal operating range is detected.	Input line phase is missing. Rated current of supply is too low compared to the AFE unit.	Check the grid supply, cables, connections, and fuses.
	4166	Grid Synchronization Error	The drive is unable to maintain the synchronization to the grid voltage.	Grid frequency is too high or too low. Main Circuit Breaker is open.	
0x3211	4145	DC-link Voltage High 1	The voltage of the DC link is above the normal operating range and has reached a critical level.	Too fast motor braking. Grid transients.	Increase deceleration time, enable the overvoltage controller, use AC brake, or use a brake resistor while braking.
0x3212	4144	DC-link Voltage High 2	The voltage of the DC link is above the normal operating range and has reached a critical level.		
0x3221	4146	DC-link Voltage Low	The DC-link voltage is below the normal operating range.	Fault in DC-voltage supply (rectifier or front-end converter).	Check the DC-supply unit. Try to enable undervoltage protection to keep the drive running as long as possible.
0x32ff	4147	DC-link Voltage Ripple	Excessive voltage ripple has been detected on the main DC-link capacitors.	Grid voltage imbalance.	Reduce the output power.
	4148	DC-link Imbalance	An imbalance across the DC-link capacitors is detected. If the fault remains after resetting the drive, service is required.	The imbalance can be caused by a component fault of the DC link.	Try resetting the drive. Inspect the drive. Service the drive. Contact Danfoss service.
0x4110	4099	Ambient Temp. High	The ambient temperature is too high.	Excessive heating or insufficient cooling of the drive's ambient temperature.	Check the temperature and cooling conditions. Lower the temperature or improve the cooling conditions.
0x4280	5132	Temp. Protection 1	Temperature protection 1 is triggered. The temperature has exceeded the configured value.		Check the status of the monitored device. Check the probe connection.

Group	Number	Name	Description	Possible causes	Mitigation Actions
	5133	Temp. Protection 2	Temperature protection 2 is triggered. The temperature has exceeded the configured value.	The device under measurement is heating up. The probe connection is faulty.	
	5134	Temp. Protection 3	Temperature protection 3 is triggered. The temperature has exceeded the configured value.		
	5135	Temp. Protection 4	Temperature protection 4 is triggered. The temperature has exceeded the configured value.		
	5136	Temp. Protection 5	Temperature protection 5 is triggered. The temperature has exceeded the configured value.		
	5137	Temp. Protection 6	Temperature protection 6 is triggered. The temperature has exceeded the configured value.		
	5147	Temp. Protection 7	Temperature protection 7 is triggered. The temperature has exceeded the configured value.		
	5148	Temp. Protection 8	Temperature protection 8 is triggered. The temperature has exceeded the configured value.		
	5149	Temp. Protection 9	Temperature protection 9 is triggered. The temperature has exceeded the configured value.		
	5154	Temp. Protection 10	Temperature protection 10 is triggered. The temperature has exceeded the configured value.		
	5138	Temperature Sensor Out of Range	One of the temperature sensor readings is outside of set range.		
	5241	Input Section	An overtemperature is	Insufficient enclosure	Check the enclosure

Application Guide

Group	Number	Name	Description	Possible causes	Mitigation Actions
		Overtemperature	detected in the mains input section of the enclosure.	cooling. Converter overloading. Faulty overtemperature signal wiring or connection.	cooling. Reduce converter load. Check the signal wiring and connection.
0x4281	5143	Thermistor Monitor 1	The input of thermistor monitor 1 has exceeded the 4 kilo ohm threshold.	The device under measurement is heating up. The thermistor connection is faulty.	Check the status of the monitored device. Check the thermistor connection.
	5144	Thermistor Monitor 2	The input of thermistor monitor 2 has exceeded the 4 kilo ohm threshold.		
	5145	Thermistor Monitor 3	The input of thermistor monitor 3 has exceeded the 4 kilo ohm threshold.		
0x42ff	4200	Power Option Temp. High 1	The temperature of a power option has exceeded the normal temperature range.	Excessive loading of the power option. Insufficient cooling of the ambient temperature around the power option.	Check the cooling conditions. Reduce the load or the ambient temperature.
	4201	Power Option Temp. High 2	The temperature of a power option has reached a critical level.		
	4202	Power Option Temp. Low	The temperature of a power option component is too low.	Excessive heating or insufficient cooling of the ambient temperature around the power option.	Check the ambient temperature. Increase the ambient temperature around the power option.
	4203	Power Option Temp. Limit	The temperature of a power option component is at the upper limit of the normal temperature.	Excessive loading of the power option. Insufficient cooling of the ambient temperature around the power option.	Check the cooling conditions. Reduce the load or the ambient temperature.
	4204	Power Option Temp. Imbal. 1	The thermal imbalance between the power option components exceeds the normal operating range.	Faulty installation of the power option or its thermal measurement components. Defective power option or its thermal measurement components.	Check the power option component for installation errors or defects.
	4205	Power Option Temp. Imbal. 2	An excessive thermal imbalance between power option components has been detected.		Check the option's thermal measurement components for installation errors, connection issues or defects.
	4206	Power Option Temp. Imbal. Limit	The thermal imbalance between the power option components is at the upper limit of the normal operating range.		

Application Guide

Group	Number	Name	Description	Possible causes	Mitigation Actions
0x4310	4103	Inverter Temp. Limit	The temperature of the inverter heat sink is at the upper limit of the normal temperature range.	High ambient temperature. Insufficient cooling. Overloading of the drive.	Check cooling and heat sink conditions. Reduce the output current or ambient temperature. The drive may derate if the temperature is not lowered.
	4104	Inverter Temp. High 1	The temperature of the inverter heat sink has exceeded the normal temperature level. Check cooling and heat sink conditions. Reduce the output current or ambient temperature.	High ambient temperature. Insufficient cooling. Overloading of the drive.	Check cooling and heat sink conditions. Reduce the output current to avoid a protected fault.
	4105	Inverter Temp. High 2	The temperature of the inverter heat sink has reached a critical level.		
	4110	IGBT Temp. High	An inverter IGBT overtemperature has been detected.	High ambient temperature. Insufficient cooling. Overloading of the drive.	Reduce the ambient temperature, the output current and/or the switching frequency. Check the cooling and the condition of the heat sink.
	4113	Rectifier Temp. Limit	The temperature of the rectifier heat sink is at the upper limit of the normal temperature range.	High ambient temperature. Insufficient cooling. Overloading of the drive.	Check cooling and heat sink conditions. Reduce the output power (torque, speed) or the ambient temperature.
	4114	Rectifier Temp. High 1	The temperature of the rectifier heat sink has exceeded the normal temperature range.		
	4115	Rectifier Temp. High 2	The temperature of the rectifier heat sink has reached a critical level.		
	4117	Power Unit Temp. Limit	The internal air temperature of the drive is at the upper limit of the normal temperature range.		
	4118	Power Unit Temp. High 1	The internal air temperature of the drive has exceeded its normal temperature range.	High ambient temperature. Insufficient cooling. Overloading of the drive.	Check cooling and heat sink conditions. Reduce the output power (torque, speed) or the ambient temperature.
	4119	Power Unit Temp. High 2	The internal air temperature of the drive has reached a critical value.		

Application Guide

Group	Number	Name	Description	Possible causes	Mitigation Actions
	4125	IGBT Temp. High	An inverter IGBT temperature has reached a critical value.	High ambient temperature. Insufficient cooling. Overloading of the drive.	Reduce the drive's output current if possible to avoid a protected fault.
0x4320	4102	Ambient Temp. Low	The drive is operated at a too low ambient temperature.	Low ambient temperature. Insufficient heating or excessive cooling.	Check the ambient temperature. Increase the ambient temperature or consider an external heater to increase the temperature around the drive.
	4112	Rectifier Temp. Low	The temperature of the rectifier heat sink is too low.	Low ambient temperature. Insufficient heating or excessive cooling.	Check the ambient temperature. Increase the ambient temperature or consider an external heater to increase the temperature around the drive.
	4116	Power Unit Temp. Low	The internal air temperature of the drive is below the normal operating range.	Low ambient temperature. Insufficient heating or excessive cooling.	The drive is operated at a too low ambient temperature. Consider an external heater to avoid this warning or fault.
0x4380	5240	Cooling Monitor	The cooling signal to an external cooling unit is missing.	Faulty external cooling unit. Faulty external cooling unit signal.	Check the external cooling unit. Check the signal wiring and connections to the cooling unit.
0x43fe	4120	Control Board Temp. Low	The temperature of the control board is below the normal temperature range.	Low ambient temperature. Insufficient heating or excessive cooling.	Check the ambient temperature. Increase the ambient temperature or consider an external heater to increase the temperature at the drive.
	4121	Control Board Temp. Limit	The temperature of the control board is at the upper limit of the normal temperature range.	High ambient temperature. Insufficient cooling. Overloading of the control board.	Check cooling conditions and load of the control board. Reduce the load on the control board or the ambient temperature. To reduce load, consider reducing switching frequency or number of active features.
	4122	Control Board Temp. High 1	The temperature of the control board has exceeded its normal temperature range.		
	4123	Control Board Temp. High 2	The temperature of the control board has		

Application Guide

Group	Number	Name	Description	Possible causes	Mitigation Actions
			reached a critical level.		
	4126	IGBT Temperature Imbalance	There is a temperature imbalance between 1 or more IGBTs.	Defective IGBTs. Insufficient cooling.	Check the condition of IGBT modules and their connections.
	4127	IGBT Temperature Imbalance	An excessive thermal imbalance between the IGBT modules has been detected.	Defective driver boards.	Check the cooling of the power unit. Check the driver boards.
0x5100	4641	24V Backup Mode	The drive is in 24V backup mode. The control section (including parameter configurations) and installed options are kept operational.	No connection to the power unit.	Establish or inspect the connection to the power unit.
0x5110	4224	Analog Input Overload	Analog input overload detected.	High input voltage or current from external source. Short circuit.	Check the input voltage supply and prefer using the I/O option's own 10V source for analog inputs. Check the connections.
0x5112	4640	24V Supply Fault	The 24V supply is outside its normal operating range for the control board.	Faulty supply, connection, or cables in the control board +24V external power supply.	Inspect the supply source. Inspect the supply connections and cables.
	4226	Supply Overload 24V	24V supply overload detected in an I/O option board.	Short circuit in the digital I/O +24V control voltage terminal.	Check the connections.
0x5114	4642	3.3V Supply Low	The voltage of the power board internal 3.3V supply is below its normal operating range.	Faulty or insufficient supply voltage for the power board.	Check the power board power supply. Check the power board.
0x5118	4643	28V Supply Low	The voltage of the power board internal 28V supply is below its normal operating range.	Defective power board components.	Contact Danfoss service.
0x511a	4227	Supply Overload 10V	10V supply overload detected in an I/O option.	Short circuit in the analog I/O +10V reference voltage terminal.	Check the connections.
0x5160	4225	Digital Output Overload	Digital output overload detected.	Overcurrent in the output due to low resistive loading or short circuit.	Inspect the output connections. Consider adding pull-down resistors to reduce the current.
0x51fe	4644	Gate Driver Voltage Fault	The gate driver supply voltage is outside its normal operating range.	Faulty IGBT driver board.	Contact Danfoss service.
	4653	Gate Driver Fault	A gate driver fault is	Faulty IGBT driver board	Contact Danfoss service.

Application Guide

Group	Number	Name	Description	Possible causes	Mitigation Actions
			detected or a link to the gate driver is broken.	or its connection	
0x51ff	4645	Power Board Supply Fault	A power supply fault on the power board has been detected.	Faulty supply, connection, or cables in the power board +24V auxiliary power supply.	Inspect the supply source. Inspect the supply connections and cables.
	4646	Power Supply Voltage	A power supply voltage is outside its normal operating range.		
0x5210	4378	Current Sensor Fault	A defective current sensor or an error in the calibration of the current sensors has been detected.	A defective current sensor. Sensor calibration error.	Service the drive. Contact Danfoss service.
0x54fd	4647	Function Disabled	The protection logic keeps the trip active until the configuration of the power unit protection levels is ready.	The Functional Safety module is misconfigured.	Check the Functional Safety Settings.
0x54fe	4628	STO Activated	The Safe Torque-Off (STO) is activated and an unintended restart is prevented until the STO-request has been reset.	An STO command was given to the drive. The STO signal or its connection is faulty. Functional Safety module is faulty or installed incorrectly.	Check the validity of the command from its source. Check the health and connection of the STO signal and the Functional Safety module.
	4629	STO Fault Ch. A	The Safe Torque-Off (STO) is activated due to a discrepancy fault: Channel A is not activated, while channel B is activated.		
	4630	STO Fault Ch. B	The Safe Torque-Off (STO) is activated due to a discrepancy fault: Channel B is not activated, while channel A is activated.		
0x54ff	4149	DC-link Short Circuit	An internal short circuit is detected in the DC link.	Faulty DC-link components.	Service the drive. Contact Danfoss service.
	4150	DC Capacitor Short Circuit	A short circuit in a DC-link capacitor is detected.		
	4151	DC-link Short Circuit 2	A short circuit in the DC-link capacitor is detected.		
0x5530	4790	Control Data Error	A data error is detected in the control data database EEPROM.	Control Data does not match what the current version of the control software expects.	Contact Danfoss service.

Group	Number	Name	Description	Possible causes	Mitigation Actions
	4791	Invalid PUD	A data error has been detected in the power unit database EEPROM.	Power Unit Data does not match what the current version of the control software expects.	Contact Danfoss service.
0x6100	4134	System Time Adjust	System time has been adjusted.	Event for logging.	No action.
	4135	Real Time Clock Hardware Error	Hardware error has been detected in the real-time clock.	RTC battery missing or with low charge.	Install or replace RTC battery.
	4304	License Missing	A required license is missing.	A fieldbus connection from an unlicensed protocol was attempted.	Use a licensed protocol. Acquire a license.
	4349	Authenticity Error	Files authenticity verification error occurred.	The application within the drive is either missing or unauthenticated.	Upload an authenticated application.
	4351	System Fault	A system fault has been detected. See additional information for details.	Software issue. Control board overloading.	Cycle power. Check that all boards are properly powered, installed, connected, and wired together.
	4357	Firmware Crash	A firmware crash occurred and detailed information is provided.	Faulty connection to one or more nodes. Faulty circuit boards.	Check the condition of all circuit boards. Reduce control board loading. Contact the Danfoss supplier or the service department if the fault persists.
	4567	Restore Status	Provides information about the restore operation of a setting.	Event for logging.	No action.
	4568	Automatic Reset	All event conditions have cleared and triggered events have been automatically reset.	Event for logging.	No action.
	4816	PLC Task Overrun	The high CPU load is inhibiting normal operation of the application (PLC task overrun).	Software issue. Control board overloading. Faulty connection to one or more nodes.	Cycle power. Check that all boards are properly powered, installed, connected, and wired together.
	4817	PLC Runtime Error	The PLC runtime has stopped responding. The application has been halted.	Faulty circuit boards.	Check the condition of all circuit boards. Reduce control board loading. Contact the Danfoss

Group	Number	Name	Description	Possible causes	Mitigation Actions
					supplier or the service department if the fault persists.
	4832	Node Discovery	Node discovery and configuration are in progress. The modulation is inhibited.	Event for logging.	No action.
	4833	Node Commissioning	Nodes are being commissioned.	Event for logging.	No action.
	4834	Node Missing	A previously commissioned node is no longer available. The drive is waiting for the node to be available.	Node is without power. Connection to node is faulty.	Check that the node is powered on. Check the connection to the node. If the node has been intentionally removed, recommission the drive.
	4851	Restart Required	A configuration change requires a soft-cycle or power-cycle to take effect. Modulation is inhibited.	Configuration change.	Soft- or power-cycle the drive.
	4855	Internal Fault	An internal fault has been detected related to temporal operations. Note the occurrence number for further troubleshooting directions.	Software issue. Control board overloading. Faulty connection to one or more nodes. Faulty circuit boards.	Cycle power. Check that all boards are properly powered, installed, connected, and wired together. Check the condition of all circuit boards.
	4856	Internal Fault	An internal fault has been detected related to asynchronous operations. Note the occurrence number for further troubleshooting directions.		Reduce control board loading. Contact the Danfoss supplier or the service department if the fault persists.
	4857	Software Update	The drive is currently performing an update of the software.	Event for logging.	No action.
	5130	Quick Stop Event	A quick stop has been requested.	The user has requested a quick stop, or the quick stop signal is faulty.	Check why quick stop was requested. Check the fieldbus or digital input signal health and connection.
0x6180	5260	Event Simulation	The event with the number 5260 is simulated.	The event simulator was activated with its dedicated test event.	No action.
0x6181	4980	A Digital Input terminal is unknown by system	A digital input terminal has been selected that is unknown by system.	An I/O option has been moved or removed.	Check I/O options. Reconfigure the

Group	Number	Name	Description	Possible causes	Mitigation Actions
	4981	A Digital Output terminal is unknown by system	A digital output terminal has been selected that is unknown by system.		function that is using the terminal in question.
	4982	An Analog Input terminal is unknown by system	An analog input terminal has been selected that is unknown by system.		
	4983	An Analog Output terminal is unknown by system	An analog output terminal has been selected that is unknown by system.		
	4984	A Digital Output occupied	A digital output is in use by another function or fieldbus. If a Fieldbus has taken control over a terminal, it has priority over parameter selection.	Several entities (fieldbus or I/O) have been configured to use the same terminal.	Reconfigure I/O and fieldbus functions to use their individual terminals.
	4985	An Analog Output occupied	An analog output is in use by another function or fieldbus. If a Fieldbus has taken control over a terminal, it has priority over parameter selection.		
0x61f7	4800	Low Storage Space	The available storage space for the file system is low.	Too many parameter backups, datalogger or event log files within the drive's file system.	Transfer parameter backups, logs and or datalogger files to external memory to free up space.
	4801	Data Logger Storage	Volume restriction limits are preventing additional datalogger capture files from being stored.	Low storage space. Demanding datalogger settings.	Transfer files to external memory to free up space. Reduce the sampling time, logging window or number of signals.
	4802	Event Logger Storage	Volume restriction limits are preventing additional event log capture files from being stored.	Low storage space.	Transfer files to external memory to free up space.
0x61fb	4600	Option Communication Fault	A fault of the communication with an option or other node has been detected. Note the occurrence number for further troubleshooting directions.	Faulty connection to the node. Faulty circuit boards.	Cycle power. Check that all boards are properly powered, installed, connected, and wired together. Check the condition of all circuit boards. Contact the Danfoss
	4601	Internal Communication	An internal		

Group	Number	Name	Description	Possible causes	Mitigation Actions
		Fault	communication fault has been detected in the auxiliary bus. Note the occurrence number for further troubleshooting directions.		supplier or the service department if the fault persists.
	4602	Option Communication Fault	A fault of the communication with an option has been detected.		
	4607	Internal Communication Fault	An internal communication fault has been detected between different nodes. Note the occurrence number for further troubleshooting directions.		
	4631	Internal Communication Fault	An internal communication fault to a power node has been detected. Note the occurrence number for further troubleshooting directions.		
	4632	Internal Communication Fault	An internal communication fault to an optional node has been detected. Note the occurrence number for further troubleshooting directions.		
	4654	Control Node Disconnected	Internal communication route to one or more control nodes have been disconnected in a drive-to-drive system.	Control board or extender board is not powered. Faulty connection. Faulty control node or extender board.	Check the control board and associated extender board for power, connection, or defect issues.
0x61fc	4605	Internal Communication Fault	An internal communication fault has been detected with high-speed bus to power system. Note the occurrence number for further troubleshooting directions.	Faulty connection to the node. Faulty circuit boards.	Cycle power. Check that all boards are properly powered, installed, connected, and wired together. Check the condition of all circuit boards.
	4606	Internal Communication Fault	An internal communication fault has been detected. Cycle power, check the		Contact the Danfoss supplier or the service department if the fault persists.

Group	Number	Name	Description	Possible causes	Mitigation Actions
			wiring if applicable, contact the Danfoss supplier or the service department if the fault persists. Note the occurrence number for further troubleshooting directions.		
	4639	High Speed Bus Sync Error	Internal synchronization error detected with high-speed bus connection to parallel control unit.		
	4648	High Speed Bus Error	Internal error detected with high-speed bus connection to parallel control unit. Unexpected time adjustment.		
	4858	Internal Fault	An internal fault has been detected. The power system has not received the required reference for modulation. Note the occurrence number for further troubleshooting directions.		
	4859	Internal Fault	An internal fault (connection from power system) has been detected. Note the occurrence number for further troubleshooting directions.		
	4860	Unexpected Time Adjust	An internal fault (unexpected time adjustment) has been detected. Note the occurrence number for further troubleshooting directions.		
	4861	Synchronization Fault	An internal fault (time synchronization error between controller and power system) has been detected. Note the occurrence number for further troubleshooting directions.		
	4862	PDS	Internal error detected with high-speed bus		

Application Guide

Group	Number	Name	Description	Possible causes	Mitigation Actions
	4863	Internal Fault	connection from controller. An internal fault (connection with power system) has been detected. Note the occurrence number for further troubleshooting directions.		
0x6320	4350	Configuration Error	An invalid system configuration has been detected.	Incompatible motor type and control principle.	Check motor type and motor control principle.
	5301	Invalid Control Config.	An invalid control configuration is preventing operation.	Too narrow DC-link voltage bandwidth.	Check DC-link voltage controller levels.
0x7180	5380	Pre-Charge Failed	DC-link voltage failed to reach the minimum level within the allowed pre-charge time	Fault in the pre-charge circuit. Faulty wiring or connection in the pre-charge command. Timing issue.	Check the pre-charge circuit. Check the pre-charge command wiring and connection. Adjust the pre-charge time.
	5250	Filter energization failure	The filter failed to energize within the timeout period.	Faulty filter components or connections. Timing issue.	Check the filter and its connections. Adjust the filter energization time.
	5381	External Pre-Charge Failed	DC-link is expected to be externally pre-charged, but the voltage level failed to rise within the timeout period.	Faulty in the external charging system. Timing issue.	Check the external system. Adjust the pre-charge time.
0x7082	5378	Main Circuit Breaker Tripped	An external main circuit breaker tripping signal is active.	Fault in the circuit breaker. Tripping signal's wiring or connection is faulty.	Check the circuit breaker. Check the tripping signal's wiring and connection.
	5377	Main Circuit Breaker Feedback Conflict	The two main circuit breaker feedback signals conflict with each other.	Fault in the circuit breaker. One or both feedback signals have faulty wiring or connections. Signal timing issue.	Check the circuit breaker. Check the feedback signals' wiring and connection. Adjust the feedback fault delay.
	5376	Main Circuit Breaker Feedback Failure	The main circuit breaker feedback was not received within the timeout limit, or it was lost during operation.	Fault in the circuit breaker. Feedback signal has faulty wiring or connections.	Check the circuit breaker. Check the feedback signal's wiring and connection.

Group	Number	Name	Description	Possible causes	Mitigation Actions
				Signal timing issue.	Adjust the feedback fault delay.
0x70ff	4128	Control Fan Failure	The control board cooling fan is not running at the commanded speed.	Blocked or faulty fan. Faulty fan wiring.	Check the fan's wiring and whether its blocked or polluted. Replace the fan if necessary.
	4129	Main Fan Failure	The main cooling fan is not following its reference speed.		
	4130	Internal Fan Failure	The internal fan is running below its reference speed. Check the fan's wiring and whether its blocked or polluted. Replace the fan if necessary.		
	4133	LCL Fan Speed Fault	LCL cooling fan not tracking commanded output.		
0x7500	4638	Drive to Drive Connection Lost	Drive to drive connection is lost.	Fault in the connection between drives. Fault in the extender board.	Check the connection between the drives. Check the status of the extender boards.
0x7502	4416	Analog Input Live Zero	A live zero event detected in an analog input terminal.	A faulty wire or connection.	Check the analog input wiring or connections.
0x7580	5141	Control Panel Connection Lost	The connection to the control panel was lost. Panel control has been released.	Fault in the panel connection. Error in the panel.	Check the connection to the panel. Check the panel.
	5142	PC Tool Connection Lost	The connection to the PC tool was lost. PC control has been released.	Fault in the PC connection. Error in the PC software or software was closed.	Check the connection to the PC. Check the status of the PC software.
0x8080	5125	Limit Supervision Event 1	A user define signal is over/under a supervision limit.	The drive is in an undesirable operating point.	Check the operating point. Consider applying speed, current, torque, or power limits.
	5126	Limit Supervision Event 2			
	5127	Limit Supervision Event 3			
0x8100	4256	Address Conflict	The fieldbus has identified an Address Conflict on the network which made the device back off.	Two or more devices in the service or fieldbus networks have the same address.	Change the address of the conflicting devices.
	4257	Ethernet Cable Fault	At link down a measurement is done to measure the distance to the far end of the cable,	The service or fieldbus ethernet connection is faulty due to cable or connection issues.	Check the cables and connections. Utilize the detailed event info.

Group	Number	Name	Description	Possible causes	Mitigation Actions
			indicating where the fault has occurred. This warning occurs at distances > 4 m and Link State Change Down. Actual distance shown in detailed info.		
	4258	Invalid Fieldbus Configuration	An issue due to an invalid configuration of the fieldbus connection has been detected. See additional detail info.	Features not supported by the device. Mismatch between configured and available features. Modules not available in the device.	Depending on the protocol: Check the custom Modbus® mapping. Check for mismatches in the used device and device description files.
	4260	Redundant Controller Missing	One or more of the expected fieldbus controllers are missing.		Check the fieldbus connection or the status of the fieldbus master.
	4261	Fieldbus Topology Mismatch	The current fieldbus topology does not match the topology provided at commissioning time.	Wiring mistake. Fieldbus master configuration mistake.	Reconfigure the fieldbus master or change the connection between X1/X2 ports.
	4263	Ethernet Link Status Changed	There has been detected a change of the Ethernet link status. Additional info has details about which port and state.	Event for logging.	No action.
	4265	Ethernet Redundancy Error	Primary or backup physical path has been detected to be missing.	Connection or cable fault. Wrong interface settings	Check the connection. Check the interface settings.
	4266	X1 Cable Redundancy	Indicates that physical path from X1 interface to the controller is missing or wrongly configured.		
	4267	X2 Cable Redundancy	Indicates that physical path from X2 interface to the controller is missing or wrongly configured.		
	4269	Network Time Protocol	Information of Network Time Protocol server. See detailed info.	Event for logging.	No action.
	4280	Controller Not in Run	Controller not in RUN state.	Event for logging.	No action.
	4281	Interface Configuration Change	Interface configuration changed. See detailed info.	Event for logging.	No action.

Application Guide

Group	Number	Name	Description	Possible causes	Mitigation Actions
0x8100	5161	Fieldbus Watchdog Supervision	Fieldbus watchdog supervision has detected too long delay between fieldbus data updates.	Fieldbus master has lost control, or the current transferred I/O data from the master is not valid. The fieldbus master is not updating the data.	Check the fieldbus connection, the status of any ethernet switches or the status of the fieldbus master.
0x8100	5163	Primary Process Data Timeout	The fieldbus I/O data has not been updating any of the process data monitored by the primary process data monitor (Watchdog1).	This can happen when the direct fieldbus connection to the drive has lost control, or the current received I/O data is not valid.	Check the fieldbus connection directly to the drive or the status of the fieldbus master.
0x8100	5165	Fieldbus Faulted	One or more of the Fieldbus IO connections has failed from any protocol.	An established Fieldbus I/O Connection has been disrupted by e.g cable break or power cut of PLC or other infrastructure components.	Check the fieldbus connection or the status of the fieldbus master.
0x81fd	4270	No Modbus® TCP Connection	No Modbus® TCP communication is currently established.	Can happen during startup until first connection is established or if all connections have stopped (gracefully or disruptive).	Establish a connection.
	4271	No PROFINET® Connection	No PROFINET® I/O communication is currently established.		
	4272	No EtherNet/IP® Connection	No EtherNet/IP® communication is currently established.		
	4273	No EtherCAT® Connection	No EtherCAT® communication is currently established.		
	4282	No Modbus® TCP Connection	No Modbus® RTU communication is currently established.		
0x81fe	4274	Loss of Modbus TCP I/O	One or more of the Fieldbus I/O connections has failed.	Event for logging.	No action.
	4275	Loss of PROFINET® I/O			
	4276	Loss of EtherNet/IP® I/O			
	4277	Loss of EtherCAT® Connection			
	4283	Loss of Modbus® RTU Connection			
0x81ff	4278	Primary Process Data Timeout	The fieldbus I/O data has not been updating any of the process data monitored by the primary process data monitor (Watchdog1/2).	Event for logging.	No action.
	4279	Secondary Process Data Timeout			

Application Guide

Group	Number	Name	Description	Possible causes	Mitigation Actions
0xff01	5123	External Event 1	An external signal has activated an event.	An external system is requesting for the drive to log an event or to stop running.	Check the external system.
	5124	External Event 2		The event triggering signal is faulty.	Check the health of the signal.

Danfoss A/S
Ulsnaes 1
DK-6300 Graasten
drives.danfoss.com

.....
Any information, including, but not limited to information on selection of product, its application or use, product design, weight, dimensions, capacity or any other technical data in product manuals, catalog descriptions, advertisements, etc. and whether made available in writing, orally, electronically, online or via download, shall be considered informative, and is only binding if and to the extent, explicit reference is made in a quotation or order confirmation. Danfoss cannot accept any responsibility for possible errors in catalogs, brochures, videos and other material. Danfoss reserves the right to alter its products without notice. This also applies to products ordered but not delivered provided that such alterations can be made without changes to form, fit or function of the product. All trademarks in this material are property of Danfoss A/S or Danfoss group companies. Danfoss and the Danfoss logo are trademarks of Danfoss A/S. All rights reserved.
.....

M0020401

