



130R1341

# VLT® AutomationDrive FC 360

0.37–90 kW, Enclosure Sizes J1–J7

## 1 Introduction

This operating guide provides necessary information for qualified personnel to install and commission the AC drive. Read and follow the instructions to use the drive safely and professionally.

Do not dispose of equipment containing electrical components together with domestic waste. Collect it separately in accordance with local and currently valid legislation.

## 2 Safety

Pay particular attention to the safety instructions and general warnings to avoid the risk of death, serious injury, and equipment or property damage.

### ⚠ WARNING ⚠

#### HIGH VOLTAGE

AC drives contain high voltage when connected to AC mains input, DC supply, or load sharing.

#### UNINTENDED START

The motor may start from control panel, I/O inputs, or fieldbus at any time, when the drive is connected to the AC mains, DC supply, or load sharing.

#### DISCHARGE TIME

The drive contains DC-link capacitors, which can remain charged even when the drive is not powered. High voltage can be present even when the warning indicator lights are off.

- Stop the motor, and disconnect AC mains, permanent magnet type motors, and remove DC-link supplies, including battery backups, UPS, and DC-link connections to other drives.

- Wait for the capacitors to discharge fully and measure it before performing any service or repair work.

- The minimum waiting time is 4 minutes for 0.37–7.5 kW (0.5–10 hp) drives and 15 minutes for 11–90 kW (15–125 hp) drives.

#### LEAKAGE CURRENT

Leakage currents of the drive exceed 3.5 mA. Make sure that the minimum size of the ground conductor complies with the local safety regulations for high-touch-current equipment.

## 3 Installation

### 3.1 Mechanical Dimensions

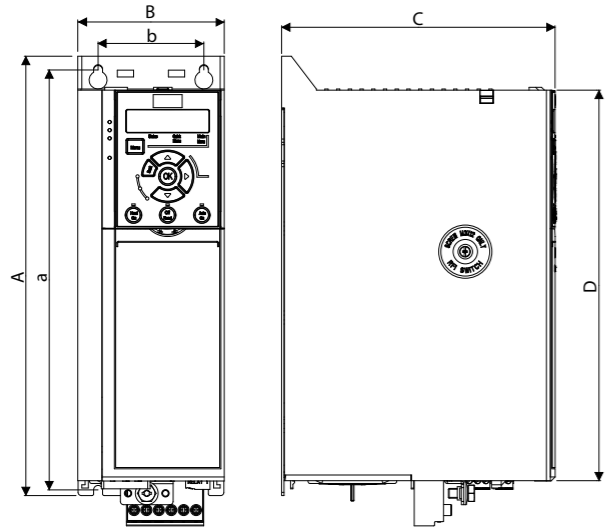

Illustration 1: Mechanical Dimensions, Enclosure Sizes J1–J7

Table 1: Power Ratings and Dimensions for Enclosure Sizes J1–J7

Enclosure size 380–480 V	J1	J2	J3	J4	J5	J6	J7
Power size [kW (hp)]	0.37–2.2 (0.5–3)	3.0–5.5 (4.0–7.5)	7.5 (10)	11–15 (15–20)	18.5–22 (25–30)	30–45 (40–60)	55–90 <sup>(2)</sup> (75–125)
Height A [mm (in)]	210 (8.3)	272.5 (10.7)	272.5 (10.7)	317.5 (12.5)	410 (16.1)	515 (20.3)	550 (21.7)
Width B [mm (in)]	75 (3.0)	90 (3.5)	115 (4.5)	133 (5.2)	150 (5.9)	233 (9.2)	308 (12.1)
Depth C [mm (in)]	168 (6.6)	168 (6.6)	168 (6.6)	245 (9.6)	245 (9.6)	241 (9.5)	323 (12.7)
Depth C <sup>(1)</sup> [mm (in)]	173 (6.8)	173 (6.8)	173 (6.8)	250 (9.8)	250 (9.8)	241 (9.5)	323 (12.7)
D [mm (in)]	180 (7.1)	240 (9.4)	240 (9.4)	270 (10.6)	364.7 (14.4)	452 (17.8)	484.5 (19.0)
<b>Mounting holes</b>							
a [mm (in)]	198 (7.8)	260 (10.2)	260 (10.2)	297.5 (11.5)	390 (15.4)	495 (19.5)	521 (20.5)
b [mm (in)]	60 (2.4)	70 (2.8)	90 (3.5)	105 (4.1)	120 (4.7)	200 (7.9)	270 (10.6)
Mounting screw	M4	M5	M5	M6	M6	M8	M8

Note: (1) With option B. (2) 90 kW (125 hp) is only for normal overload.

### 3.2 Removing the Front Cover

#### Procedure:

Remove the front cover with a screwdriver.

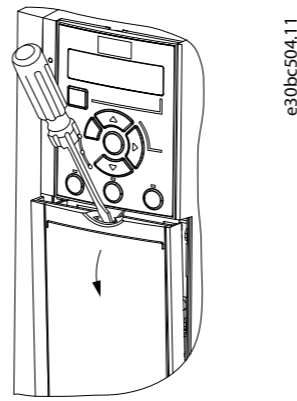

Illustration 2: Removing the Front Cover

### 3.3 Connecting to Mains, Motor, Control Terminals, and Relays

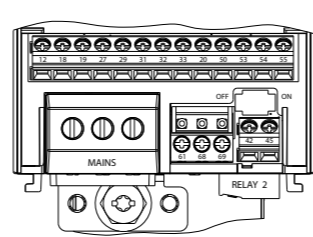

Illustration 3: Control Terminals and Relays Connections (Enclosure Sizes J1–J5)

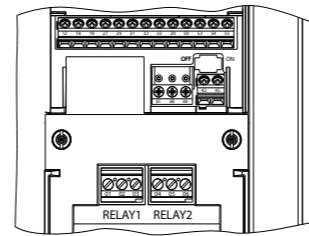

Illustration 4: Control Terminals and Relays Connections (Enclosure Sizes J6–J7)

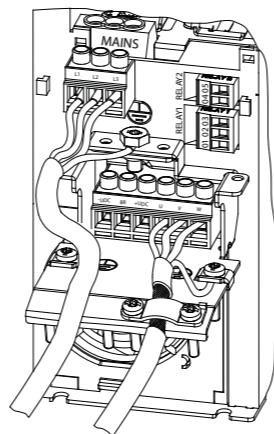

Illustration 5: Mains, Motor, and Ground Connections (Enclosure Sizes J1–J5)

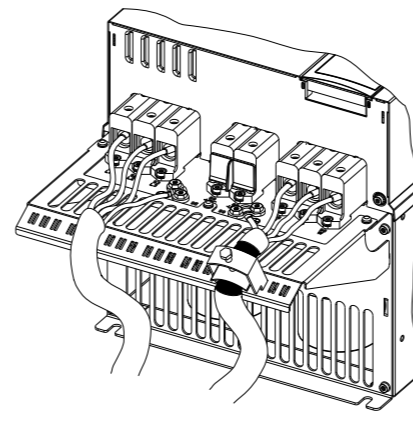

Illustration 6: Mains, Motor, and Ground Connections (Enclosure Sizes J6–J7)

### 3.4 Control Terminals

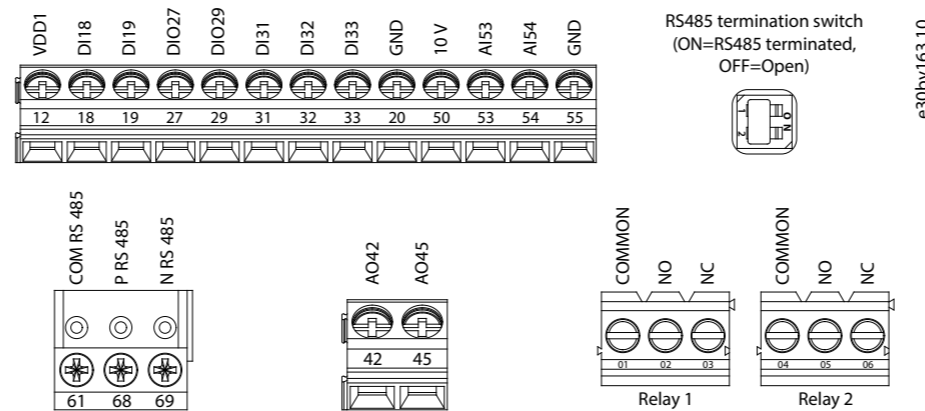

Illustration 7: Control Terminals

## 4 Specifications

Table 2: Electrical Data for Enclosure Size J1–J3, Mains Supply 3x380–480 V AC

High overload/normal overload	HK37/QK37	HK55/QK55	HK75/QK75	H1K1/Q1K1	H1K5/Q1K5	H2K2/Q2K2	H3K0/Q3K0	H4K0/Q4K0	H5K5/Q5K5	H7K5/Q7K5
Enclosure size	J1	J1	J1	J1	J1	J1	J2	J2	J2	J3
<b>High overload=160 % current during 60 s; normal overload=110% current during 60 s</b>										
Typical shaft output [kW]	0.37	0.55	0.75	1.1	1.5	2.2	3	4	5.5	7.5
Typical shaft output [hp]	0.5	0.75	1	1.5	2	3	4	5.5	7.5	10
<b>Output current (3-phase)</b>										
Continuous (3x380–440 V) [A]	1.2	1.7	2.2	3	3.7	5.3	7.2	9	12	15.5
Continuous (3x441–480 V) [A]	1.1	1.6	2.1	2.8	3.4	4.8	6.3	8.2	11	14
Intermittent (60 s overload) [A]	1.9/1.3	2.7/1.9	3.5/2.4	4.8/3.3	5.9/4.1	8.5/5.8	11.5/7.9	14.4/9.9	19.2/13.2	24.8/17.1
Continuous kVA (400 V AC) [kVA]	0.84	1.18	1.53	2.08	2.57	3.68	4.99	6.24	8.32	10.74
Continuous kVA (480 V AC) [kVA]	0.9	1.3	1.7	2.5	2.8	4.0	5.2	6.8	9.1	11.6
<b>Maximum input current</b>										
Continuous (3x380–440 V) [A]	1.2	1.6	2.1	2.6	3.5	4.7	6.3	8.3	11.2	15.1
Continuous (3x441–480 V) [A]	1.0	1.2	1.8	2.0	2.9	3.9	4.3	6.8	9.4	12.6
Intermittent (60 s overload)	1.9/1.3	2.6/1.8	3.4/2.3	4.2/2.9	5.6/3.9	7.5/5.2	10.1/6.9	13.3/9.1	17.9/12.3	24.2/16.6
Maximum cable size (mains, motor, brake, and load sharing) [mm <sup>2</sup> (AWG)]	4 (12)									
Estimated power loss at rated maximum load [W]	20.88	25.16	30.01	40.01	52.91	73.97	94.81	115.5	157.54	192.83
Weight [kg (lb)] (Enclosure protection rating IP20)	2.3 (5.1)	2.3 (5.1)	2.3 (5.1)	2.3 (5.1)	2.3 (5.1)	2.5 (5.5)	3.6 (7.9)	3.6 (7.9)	3.6 (7.9)	4.1 (9.0)
Efficiency [%]	96.2	97.0	97.2	97.4	97.4	97.6	97.5	97.6	97.7	98.0

Table 3: Electrical Data for Enclosure Size J4–J7, Mains Supply 3x380–480 V AC

High overload/normal overload	H11K/Q11K	H15K/Q15K	H18K/Q18K	H22K/Q22K	H30K/Q30K	H37K/Q37K	H45K/Q45K	H55K/Q55K	H75K/Q75K	Q90K
Enclosure size	J4	J4	J5	J5	J6	J6	J6	J7	J7	J7
<b>High overload=150 % current during 60 s; normal overload=110% current during 60 s</b>										
Typical shaft output [kW]	11	15	18.5	22	30	37	45	55	75	90
Typical shaft output [hp]	15	20	25	30	40	50	60	75	100	125
<b>Output current (3-phase)</b>										
Continuous (3x380–440 V) [A]	23	31	37	42.5	61	73	90	106	147	177
Continuous (3x441–480 V) [A]	21	27	34	40	52	65	77	96	124	160
Intermittent (60 s overload) [A]	34.5/25.3	46.5/34.1	55.5/40.7	63.8/46.8	91.5/67.1	109.5/80.3	135/99	159/116.6	220.5/161.7	194.7
Continuous kVA (400 V AC) [kVA]	15.94	21.48	25.64	29.45	42.3	50.6	62.4	73.4	101.8	122.6
Continuous kVA (480 V AC) [kVA]	17.5	22.4	28.3	33.3	43.2	54.0	64.0	79.8	103.1	133
<b>Maximum input current</b>										
Continuous (3x380–440 V) [A]	22.1	29.9	35.2	41.5	57	70.3	84.2	102.9	140.3	165.6
Continuous (3x441–480 V) [A]	18.4	24.7	29.3	34.6	49.3	60.8	72.7	88.8	121.1	142.7
Intermittent (60 s overload)	33.2/24.3	44.9/32.9	52.8/38.7	62.3/45.7	85.5/62.7	105.5/77.3	126.3/92.6	154.4/113.2	210.5/154.3	182.2
Maximum cable size (mains, motor, brake, and load sharing) [mm <sup>2</sup> (AWG)]	16 (6)			50 (1/0)			95 (3/0)		120 (4/0)	
Estimated power loss at rated maximum load [W]	289.53	393.36	402.83	467.52	630	848	1175	1250	1507	1781
Weight [kg (lb)] (Enclosure protection rating IP20)	9.4 (20.7)	9.5 (20.9)	12.3 (27.1)	12.5 (27.6)	22.4 (49.4)	22.5 (49.6)	22.6 (49.8)	37.3 (82.2)	38.7 (85.3)	40.7 (89.7)
Efficiency [%]	97.8	97.8	98.1	97.9	98.1	98.0	97.7	98.0	98.2	98.3

## 5 Ambient Conditions

J1–J7 enclosure size	IP20
Vibration test	1.0 g
Relative humidity	5%–95% (IEC 721-3-3; Class 3K3 (non-condensing) during operation)
Aggressive environment (IEC 60068-2-43) H <sub>2</sub> S test	Class Kd
Test method according to IEC 60068-2-43	H <sub>2</sub> S (10 days)

Ambient temperature (at 60 AVM switching mode) - with derating - at full continuous output current	Maximum 55 °C (131 °F) Maximum 45 °C (113 °F) <sup>(1)</sup>
Minimum ambient temperature during full-scale operation	-15 °C (5 °F)
Minimum ambient temperature at reduced performance	-20 °C (-4 °F)
Temperature during storage/transport	-25 to +65/70 °C (-13 to +149/158 °F)
Maximum altitude above sea level without derating	1000 m (3281 ft)
Maximum altitude above sea level with derating	3000 m (9842 ft)

Note: (1) Drive of 90 kW (125 hp) normal overload operates at 40 °C (104 °F).

## 6 Mounting Clearance

Enclosure size	J1–J5	J6–J7
Clearance above and below the unit (mm (in))	100 (3.94)	200 (7.87)

## 7 EMC Compatibility and Motor Cable Length

EMC standard, Emission/Immunity	Category C3/EN/IEC 61800-3	
Maximum motor cable length, shielded	50 m (164 ft)	
Maximum motor cable length, shielded, with EMC category C3	0.37–22 kW (0.5–30 hp)	5 m (16.4 ft)
	30–90 kW (40–125 hp)	25 m (82 ft)
Maximum motor cable length, unshielded	0.37–22 kW (0.5–30 hp)	75 m (246 ft)
	30–90 kW (40–125 hp)	100 m (328 ft)
Maximum cross-section to control terminals, flexible/rigid wire	2.5 mm <sup>2</sup> /14 AWG	
Minimum cross-section to control terminals	0.55 mm <sup>2</sup> /30 AWG	

## 8 Programming

### 8.1 Local Control Panel (LCP)

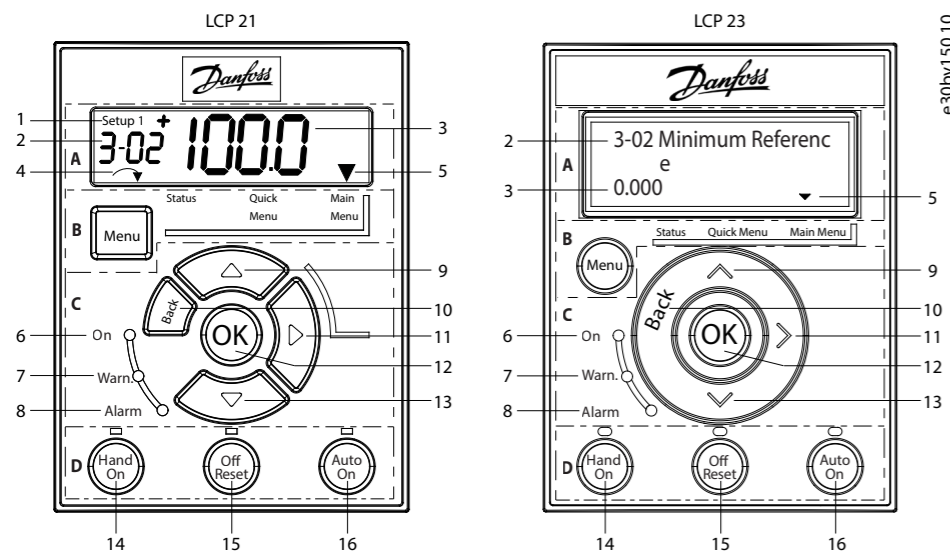

Illustration 8: Local Control Panel (LCP 21 and LCP 23)

### Functional Section A: Display

Table 4: Display Function

Number	Function
1	The setup number shows the active setup and the edit setup. • For LCP 21: The setup number shows the active setup and the edit setup. If the same setup acts as both active and edit setup, only that setup number is shown (factory setting). • For LCP 23, the setup number shows on the upper right corner in the status mode. For example, "1(2)" means the active setup is "1" and the editing setup is "2".
2	• LCP 21 shows only parameter number. • LCP 23 shows both parameter number and name.
3	Parameter value.
4	Motor direction indicated by a small arrow pointing either clockwise or counterclockwise. For LCP 23, it only shows in status mode on the upper right corner of the screen.
5	The triangle indicates if the LCP is in Status, Quick Menu, or Main Menu.

### Functional Section B: Menu Key

Press [Menu] to select among Status, Quick Menu, or Main Menu.

### Functional Section C: Indicator Lights (LEDs) and Navigation Keys

Table 5: Indicator Lights (LEDs)

Number	Indicator	Light	Function
6	On	Green	Turns on when the drive receives power from the mains voltage, a DC-bus terminal, or a 24 V external supply.
7	Warn.	Yellow	Turns on when warning conditions are met. Text is shown in the display area identifying the warning.
8	Alarm	Red	Flashes when a fault condition occurs. Text is shown in the display area identifying the alarm.

Table 6: Navigation Keys

Number	Key	Function
9/13	Up/Down	(1) Switches among parameter groups, parameters, and within parameters. (2) Increases or decreases parameter values. (3) Sets local reference.
10	[Back]	Moves to the previous step or layer in the navigation structure.
11	Right	Moves from left to right within the parameter value to change each digit individually.
12	[OK]	Selects a parameter and accepts changes to parameter settings.

### Functional Section D: Operation Keys and Indicator Lights (LEDs)

Table 7: Operation Keys and Indicator Lights (LEDs)

Number	Key	Function
14	[Hand On]	(1) Starts the drive in local control. (2) An external stop signal via control input or serial communication overrides the local hand on command.
15	[Off/Reset]	(1) Stops the motor but does not remove power to the drive. (2) Resets the drive manually after a fault has been cleared. (3) In alarm mode, the alarm is reset when the alarm condition is removed.
16	[Auto On]	Puts the system in remote operational mode, in which the drive only respond to an external start command via control terminals or bus communication.

## NOTICE

[2] Coast inverse is the default option for parameter 5-12 Terminal 27 Digital Input. If there is no 24 V supply to terminal 27, [Hand On] does not start the motor. Connect terminal 12 to terminal 27.

### 8.2 Automatic Motor Adaptation (AMA)

- Via running AMA in VVC+ mode, the drive builds a mathematical model of the motor to optimize compatibility between drive and motor, and thus enhances the motor control performance.
- Some motors may be unable to run the complete version of the test. In that case, select [2] Enable Reduced AMA in parameter 1-29 Automatic Motor Adaptation (AMA).
- For best results, run the following procedure on a cold motor.

#### Procedure:

1. Set motor data in parameter group 1-\*\* Load and Motor according to the motor nameplate.
2. Connect terminal 27 to terminal 12 (24 V voltage) or choose [0] No operation in parameter 5-12 Terminal 27 Digital Input.
3. Set [1] Enable Complete AMA or [2] Enable Reduced AMA for parameter 1-29 Automatic Motor Adaptation (AMA).
4. Press the [Hand On] key, the test runs automatically and the main display indicates when it is completed.

## 9 Troubleshooting

Table 8: Warning and Alarm Code List

Number	Description	Warning	Alarm	Trip lock	Cause
2	Live zero error	X	X	-	Signal on terminal 53 or 54 is less than 50% of the values set in parameter 6-10 Terminal 53 Low Voltage, parameter 6-12 Terminal 53 Low Current, parameter 6-20 Terminal 54 Low Voltage, and parameter 6-22 Terminal 54 Low Current.
3	No motor	X	-	-	No motor has been connected to the output of the drive, or 1 motor phase is missing.
4	Mains phase loss <sup>(1)</sup>	X	X	X	Missing phase on the supply side, or the voltage imbalance is too high. Check the supply voltage.
7	DC overvoltage <sup>(1)</sup>	X	X	-	DC-link voltage exceeds the limit.
8	DC undervoltage <sup>(1)</sup>	X	X	-	DC-link voltage drops below the voltage warning low limit.
9	Inverter overloaded	X	X	-	More than 100% load for too long.
10	Motor ETR overtemperature	X	X	-	Motor is too hot due to more than 100% load for too long.
11	Motor thermistor overtemperature	X	X	-	Thermistor or thermistor connection is disconnected, or the motor is too hot.
12	Torque limit	X	X	-	Torque exceeds value set in either parameter 4-16 Torque Limit Motor Mode or parameter 4-17 Torque Limit Generator Mode.
13	Overcurrent	X	X	X	Inverter peak current limit is exceeded. For J1–J6 units, if this alarm occurs on power-up, check whether power cables are mistakenly connected to the motor terminals.
14	Ground fault	-	X	X	Discharge from output phases to ground.
16	Short circuit	-	X	X	Short circuit in motor or on motor terminals. For J7 units, if this alarm occurs on power-up, check whether power cables are mistakenly connected to the motor terminals.
17	Control word timeout	X	X	-	No communication to the drive.
18	Start failed	-	X	-	-
25	Brake resistor short-circuited	-	X	X	Brake resistor is short-circuited, thus the brake function is disconnected.
26	Brake overload	X	X	-	The power transmitted to the brake resistor over the last 120 s exceeds the limit. Possible corrections: Decrease brake energy via lower speed or longer ramp time.
27	Brake IGBT/Brake chopper short-circuited	-	X	X	Brake transistor is short-circuited, thus brake function is disconnected.
28	Brake check	-	X	-	Brake resistor is not connected/working.
30	U phase loss	-	X	X	Motor phase U is missing. Check the phase.
31	V phase loss	-	X	X	Motor phase V is missing. Check the phase.
32	W phase loss	-	X	X	Motor phase W is missing. Check the phase.
34	Fieldbus fault	X	X	-	PROFIBUS communication issues have occurred.

Number	Description	Warning	Alarm	Trip lock	Cause
35	Option fault	-	X	-	Fieldbus or option B detects internal faults.
36	Mains failure	X	X	-	This warning/alarm is only active if the supply voltage to the drive is lost and parameter 14-10 Mains Failure is NOT set to [0] No Function.
38	Internal fault	-	X	X	Contact the local supplier.
40	Overload T27	X	-	-	Check the load connected to terminal 27 or remove short-circuit connection.
41	Overload T29	X	-	-	Check the load connected to terminal 29 or remove short-circuit connection.
46	Gate drive voltage fault	-	X	X	-
47	24 V supply low	X	X	X	24 V DC may be overloaded.
50	AMA calibration	-	X	-	-
51	AMA check U <sub>nom</sub> and I <sub>nom</sub>	-	X	-	Wrong setting for motor voltage and/or motor current.
52	AMA low I <sub>nom</sub>	-	X	-	Motor current is too low. Check the settings.
53	AMA big motor	-	X	-	The power size of the motor is too large for the AMA to operate.
54	AMA small motor	-	X	-	The power size of the motor is too small for the AMA to operate.
55	AMA parameter range	-	X	-	The parameter values of the motor are outside of the acceptable range. AMA does not run.
56	AMA interrupt	-	X	-	The AMA is interrupted.
57	AMA timeout	-	X	-	-
58	AMA internal	-	X	-	Contact the local supplier.
59	Current limit	X	X	-	The drive is overloaded.
60	External Interlock	-	X	-	-
61	Encoder loss	X	X	-	-
63	Mechanical brake low	-	X	-	Actual motor current has not exceeded release brake current within start delay time window.
65	Control card temp	X	X	X	The cutout temperature of the control card is 80 °C (176 °F).
67	Option module configuration has changed	-	X	-	One or more options have either been added or removed since the last power-down.
69	Power card temp	X	X	X	-
70	Illegal FC config	-	X	X	-
80	Drive initialized to default value	-	X	-	All parameter settings are initialized to default settings.
87	Auto DC brake	X	-	-	Occurs in IT mains when the drive coasts and the DC voltage is higher than 830 V. Energy on DC-link is consumed by the motor. This function can be enabled/disabled in parameter 0-07 Auto DC Braking.
88	Option detection	-	X	-	A change in the option layout is detected. Parameter 14-89 Option Detection is set to [0] Frozen configuration and the option layout has been changed. • To apply the change, enable option layout changes in parameter 14-89 Option Detection. • Alternatively, restore the correct option configuration.
90	Feedback monitor	X	X	-	A feedback fault is detected by option B.
95	Broken belt	X	X	-	-
99	Locked rotor	-	X	-	-
101	Flow/pressure information missing	-	X	X	-
120	Position control fault	-	X	-	-
124	Tension limit	-	X	-	-
126	Motor rotating	-	X	-	-
127	Back EMF too high <sup>(2)</sup>	X	-	-	Try to start PM motor which is rotating in an abnormal high speed.
250	New spare part	-	X	X	-
251	New type code	-	X	X	-

Note: (1) These faults may be caused by mains distortions. Installing a Danfoss line filter may rectify this problem. (2) For enclosure size J7, the warning can also be caused by high UDC voltage. (3) An (X) marked in the above table indicates that the warning or alarm has occurred. A warning precedes an alarm. (4) Table 8 lists the main warning and alarm code of the drive, refer to the programming guide for the full list.

## 10 Accessories and Spare Parts

Accessories and spare parts		Code number	Accessories and spare parts		Code number
(1)	VLT® encoder input MCB 102	132B0282	(6)	Remote mounting kit for LCP with cable, 3 m	132B0102
(2)	VLT® resolver input MCB 103	132B0283	(7)	LCP remote mounting cable, 3 m	132B0132
(3)	VLT® 24 V DC supply MCB 106	132B0368	(8)	Standard control cassette	132B0255
(4)	VLT® graphical control panel LCP 23	132B0801	(9)	Control cassette (with Profibus)	132B0256
(5)	VLT® numeric control panel LCP 21	132B0254	(10)	Control cassette (with ProfiNet)	132B2183

Note: (1)-(7) are accessories, (8)-(10) are spare parts. For more accessories and spare parts, refer to the design guide.

## 11 Technical Documentation

Scan the QR code to access more technical documents for the drive. Or, after scanning the QR code, click **Global English** on the website to select your local region's website, search **FC 360** to find the documents with your own languages.



Danfoss A/S  
Ulsnaes 1  
DK-6300 Graasten  
drives.danfoss.com

Danfoss can accept no responsibility for possible errors in catalogs, brochures, and other printed material. Danfoss reserves the right to alter its products without notice. This also applies to products already on order provided that such alterations can be made without consequential changes being necessary in specifications already agreed. All trademarks in this material are property of the respective companies. Danfoss and the Danfoss logotype are trademarks of Danfoss A/S. All rights reserved.