

Application paper: VLT® drives with integrated condition-based monitoring

Increase the productivity of your application with **condition-based monitoring**

24/7/365

Maximize uptime





Maximizing uptime

Did you know that Danfoss intelligent drives monitor operating conditions for maximum uptime? That the drives continually monitor how the application is running and send a notification when behavior is moving in an undesirable direction?

All this “edge” computing is performed by the drive itself, based on real-time application data. There is no need for an Internet connection, nor expensive cloud service agreements.

The intelligent drive with integrated condition-based monitoring (CBM) functionality handles these tasks in one compact software package.



Table of contents

Maximize uptime and productivity	5
Monitoring of real application data	7
Baseline recording of real application performance.....	7
Baseline for “hand-over” and “up-time” service	7
How CBM monitors the application	9
Monitoring of motor winding insulation	9
Load-envelope monitoring	9
Application monitoring via external sensors	9
Vibration and bearing monitoring	9
Operate condition-based monitoring in 3 simple steps	11
Features and benefits of condition-based monitoring	13
Specifications	14



HEAT

K 40802
K 90802
Line BB
EPL4
POSITION 4

Maximize uptime and productivity

Condition-based monitoring (CBM) is often the best way to maximize the operational hours of an application. The intelligent drive continually evaluates the operating conditions to indicate an upcoming problem that may affect the performance of the application. It does this by analyzing signals from the motor connection and external sensors. CBM follows the VDMA specification 24582 where 4 “traffic lights” define the condition of the application.

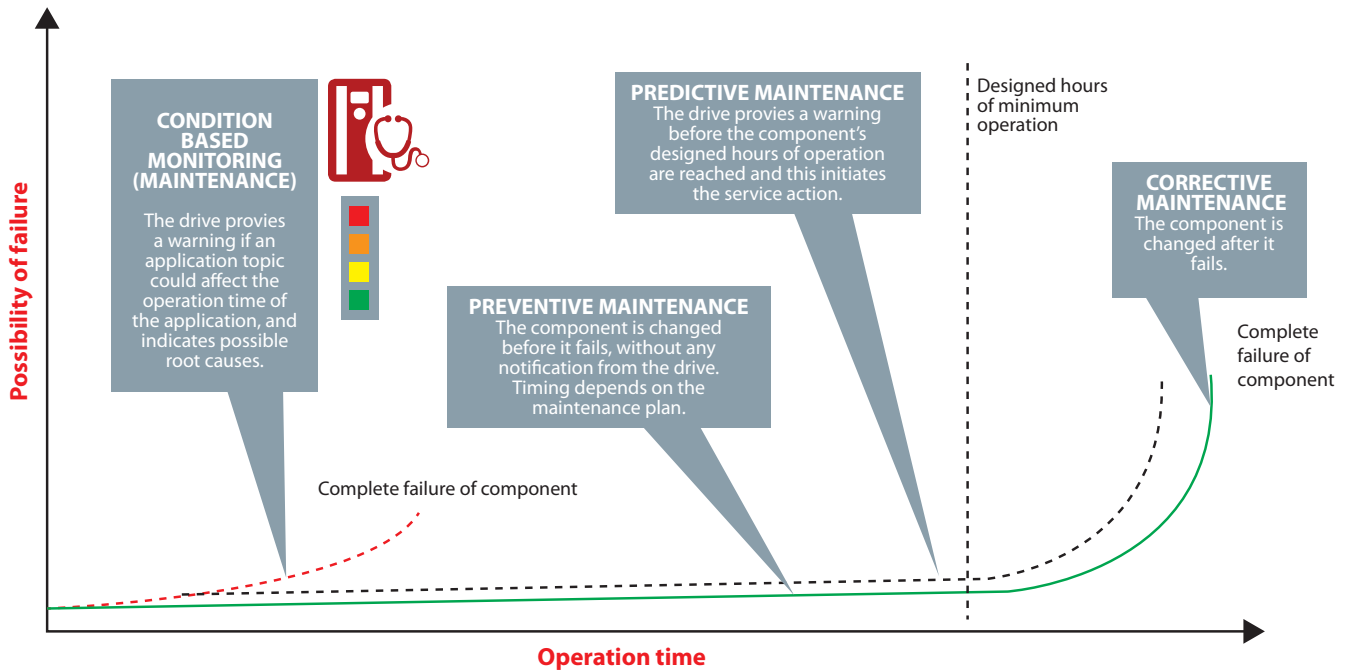

Different maintenance strategies to support your application for maximize the operation.

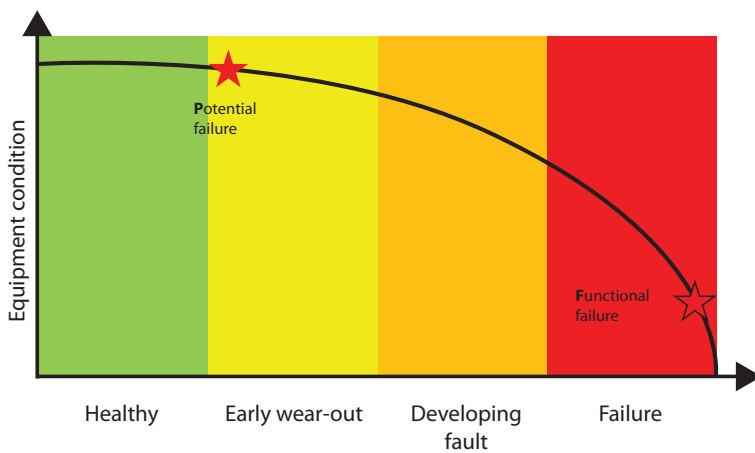

Green: Indicates the equipment is in good condition and performs efficiently.

Yellow: Indicates Warning 1 stage and signifies the first threshold is exceeded. A maintenance action can be planned by maintenance personnel.

Orange: Indicates Warning 2 or critical stage and signifies the second threshold is exceeded. Immediate maintenance action must be carried out by maintenance personnel.

Red: Indicates an alarm and signifies the machine will stop and corrective maintenance is needed.

Scope of monitoring

Condition-based monitoring is the first indication of an upcoming problem and possible downtime. The Danfoss Intelligent drives monitor:

- Insulation of the motor winding to replace the motor in time before total damage
- Load condition where too high or too low energy consumption indicates an abnormal operation condition
- Vibration, flow and pressure, via external sensors connected to the application



Monitoring of real application data

The CBM function monitors real application data where a baseline records the operation behavior of the application, and defines thresholds for sending notifications that operation is moving in an undesirable direction.

Baseline recording of real application performance

An effective monitoring of the application is based on real measurement of the performance and operation of the actual application, from minimum to maximum speed and from manual to fully automated control.

This is called the baseline and is the first indication of the stability and operation performance of the application.

Baseline for "hand-over" and "up-time" service



The application baseline documents the actual operation of the application. This documents the stability and performance of the application and could be the first documentation when handing over the solution to the end-user, as a proof of a trouble-free operation start.

The drive has two baselines which over time can document the real change in the application and thereby support the analysis and actions for changes, to secure maximum uptime of the application.

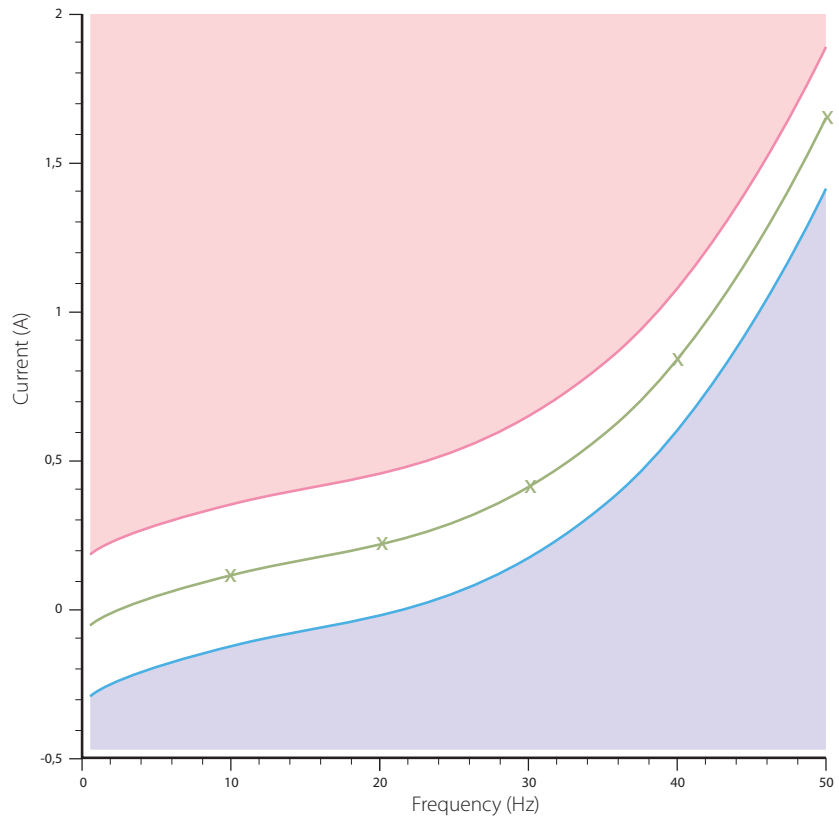
The baseline can also be used as a "benchmark" tool to validate performance of equivalent applications in different locations.



Baseline - Load envelope monitoring of ..current consumption at different speeds.

-  Energy consumption above the thresholds limit
-  Recorded baseline
-  Energy consumption below the thresholds limit

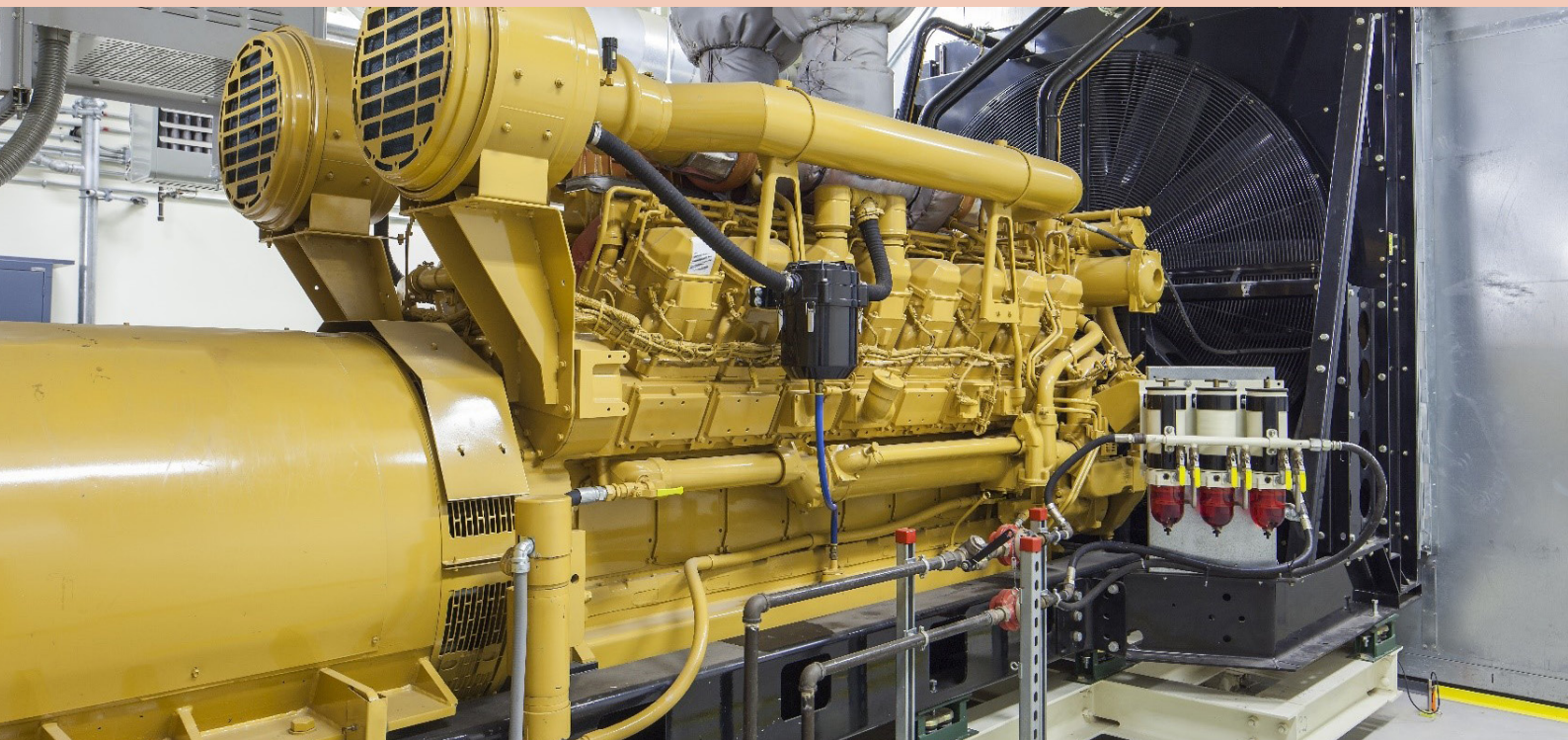
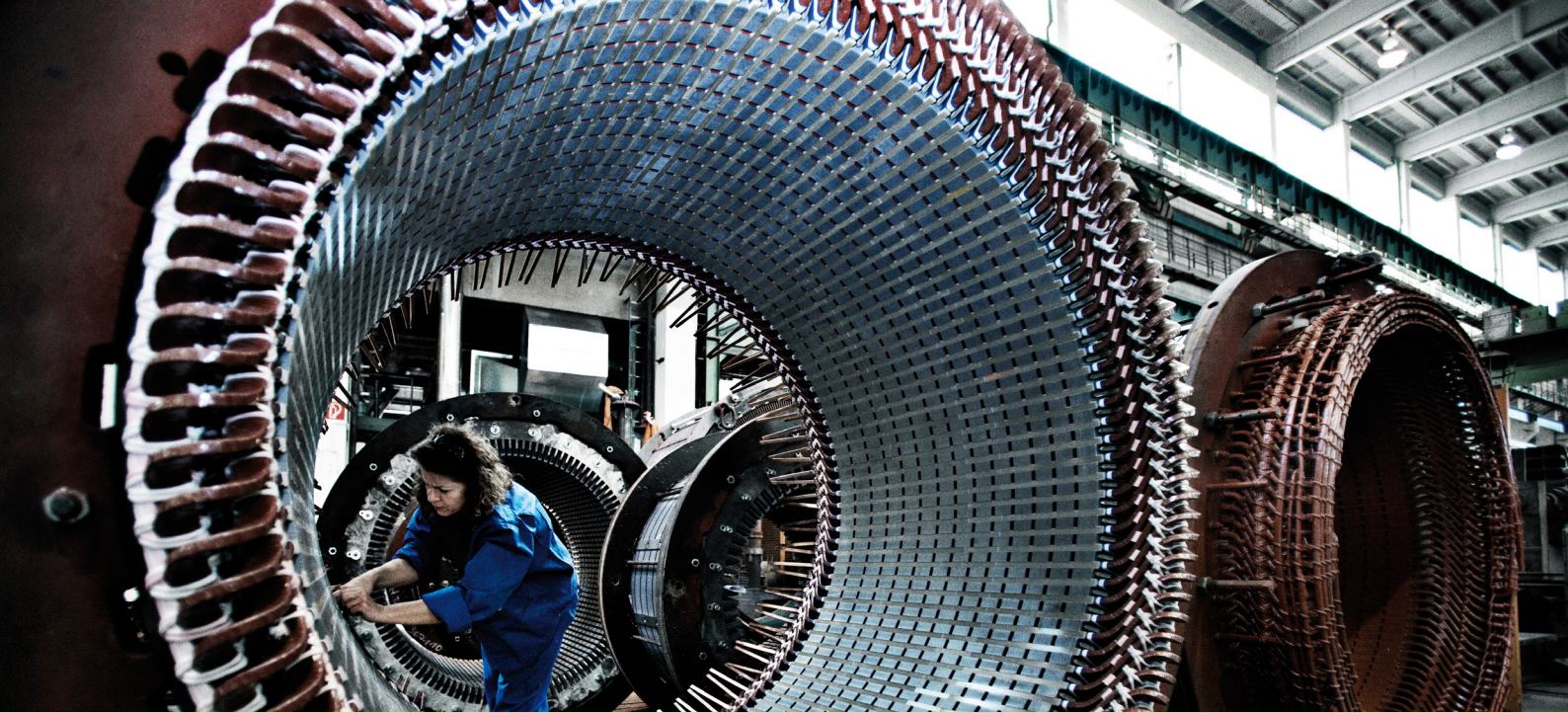

How CBM monitors the application

Monitoring of motor winding insulation

By analyzing the motor current signature, the drive can detect motor winding damage at an early stage. It triggers an early warning that allows you to shift from reactively performing corrective maintenance of faulty motors, to proactively detecting motor isolation faults at an early stage and dealing with them during scheduled maintenance to avoid unplanned downtime. It may also reduce your needs for spare part stock.

Load-envelope monitoring

The baseline defines the expected load condition of the application at different speeds, and the CBM function informs you as soon these minimum and maximum load conditions are challenged during operation. It could be a leakage, a fouled or clogged application that suddenly changes the expected load in the system. It could be parts that are worn out and change the load curve. Changes in the load curve trigger a maintenance warning, allowing you to remedy the issue quickly and effectively.

Load-envelope monitoring can also help you to save energy by ensuring the equipment always runs in optimal conditions, and that the application around the system is optimized relative to the real demand. The baseline can be used as a "benchmark" tool to validate performance of different applications.

Load-envelope monitoring also indicates important information to secure both the operational process and material handling, as these processes may have different baselines and thus different trigger levels.

Application monitoring via external sensors

Each application has its own important sensor to monitor the operation condition and the CBM concept can handle up to 4 sensor signals simultaneously. Each sensor signal is handled individually and is related to the speed of the application.

The application baseline and the sensor signal are the first indications of stability. These measurements show whether the system is stable, or whether improvements are required to establish stability from first power up.

CBM is prepared to receive signals from vibration, flow and pressure sensors, including signals related to the speed of the application.

Vibration and ball-bearing monitoring

CBM continually measures vibration and compares the values obtained against thresholds defined for the different speed ranges. Vibration sensors are split into two categories related to the detection technology.

- monitoring imbalance and eccentricity, looseness, misalignment, and mechanical resonance
- monitoring ball-bearing changes

Vibration monitoring is performed according to standards such as ISO13373: Condition Monitoring and Diagnostics of Machines or ISO10816/20816: Measurement and Classification of Mechanical Vibration.

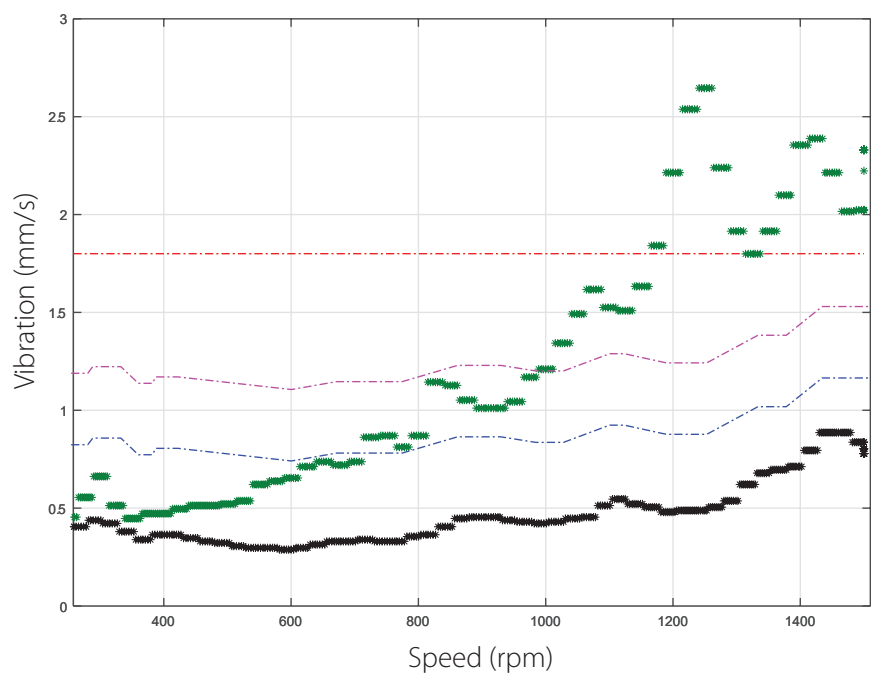

Application example showing changes in vibration signal

- Baseline data
- Faulty data
- - - Alarm Level
- - - Warning Stage 2 Level
- - - Warning Stage 1 Level



Local operation when enabling the CBM monitoring.

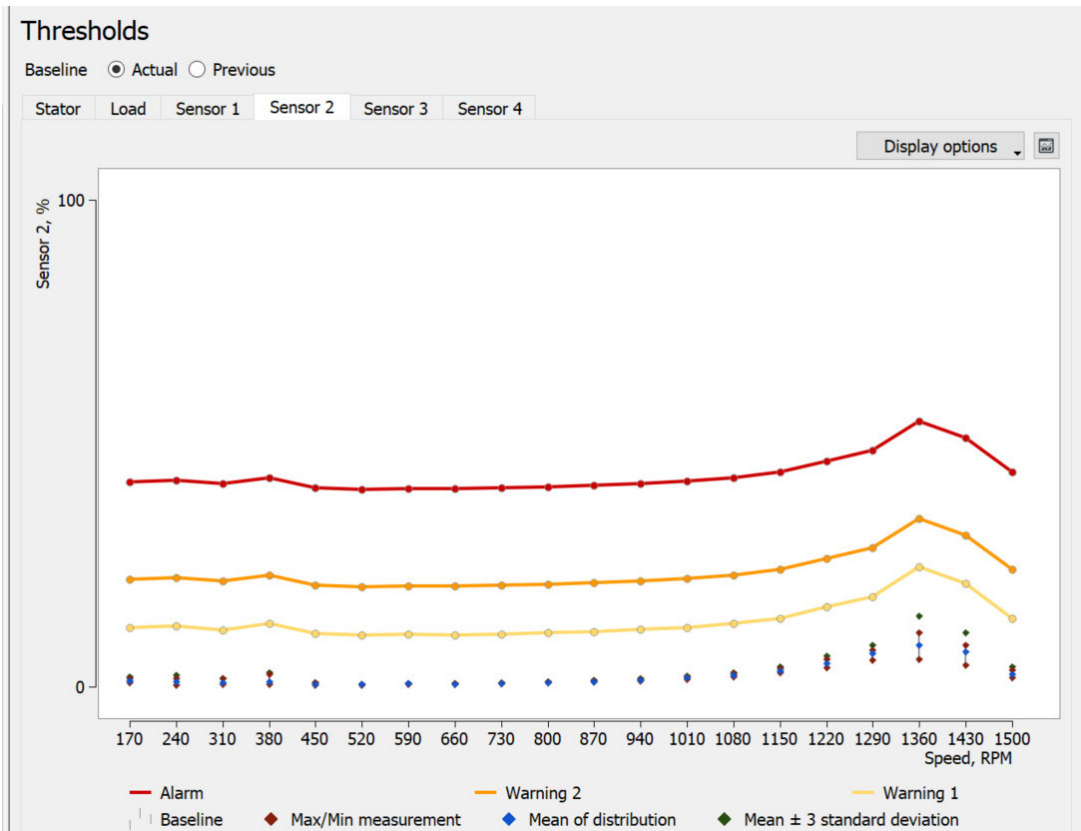

An example of a CBM monitoring curves for vibration versus speed including variation in the recorded baseline application values.

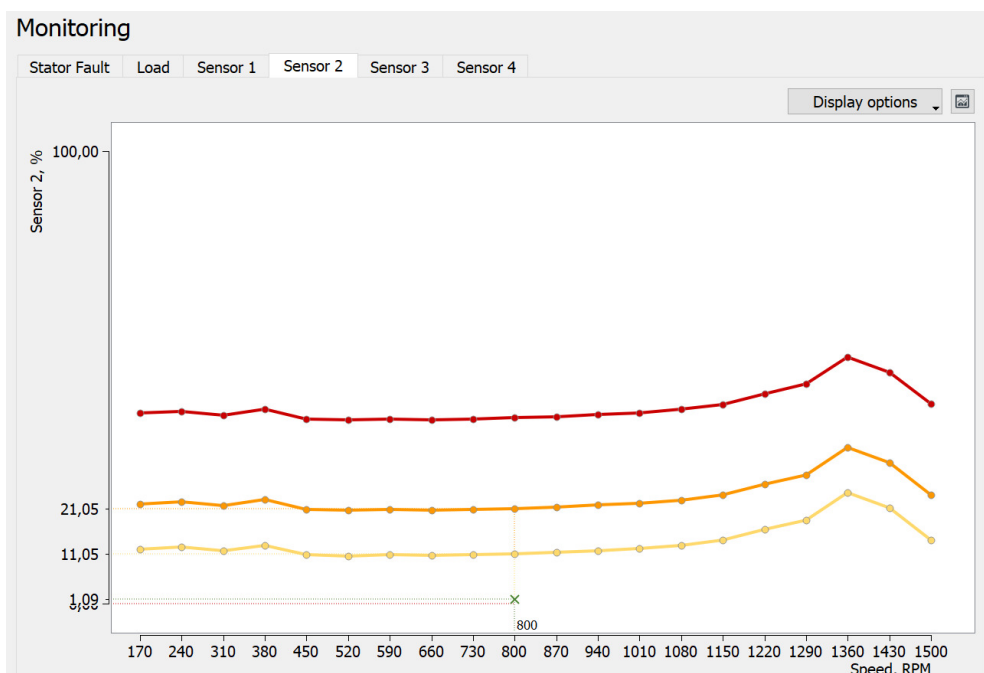

An example of actual CBM monitoring of vibration signal versus define thresholds levels.

Operate condition-based monitoring in 3 simple steps

The intelligence inside the drive and the supporting tools ensure that it's straightforward for you to get started with CBM.

There are just 3 simple steps:

1. Generate the individual baseline in one step
2. Define thresholds based on the individual baselines (default values are included)
3. Enabling the monitoring and notification

To enable CBM, choose from different workflows, from a simple "Easy CBM" configuration via local display to a more advanced solution using programming tool VLT® Motion Control Tool MCT 10, which gives feedback on the actual CBM values and the application stability.

Step 1 - Generate individual application baseline

The CBM baseline generation collects relevant application data for each of the selected functions in one step. It displays the collected information to provide the first indication of the application stability, such as minimum, maximum, and average values; and how the application operates in the different speed ranges.

Step 2 - Generate monitoring CBM values

After successfully generating an application baseline, CBM generates a monitoring graph to compare the threshold values against this recorded baseline. In most applications, the auto-generation process is perfect for enabling CBM monitoring. Since applications differ, a final evaluation of the monitoring graph is beneficial in obtaining optimal settings for CBM monitoring. The graphical display in the MCT10 programming tool makes it easy to evaluate and draw conclusions.

Step 3 Enable monitoring and notification

The CBM monitoring are individual selected for each of the functions, as the level for monitoring on warning and alarms.

The intelligent drive ensures continual monitoring of the CBM values in all operation modes and from minimum to maximum speed.

Monitoring is only beneficial when notifications reaches personnel, so they can act to maintain maximum uptime. The Danfoss CBM solution includes notifications, from local indication of a problem, to communication via different fieldbus systems, web-server connection to automation and building management systems, in order to reach service and maintenance personnel, so they can take action. Danfoss also provides cloud connections for remote access to real-time CBM values. CBM triggers an email alert when defined monitoring values are crossed.

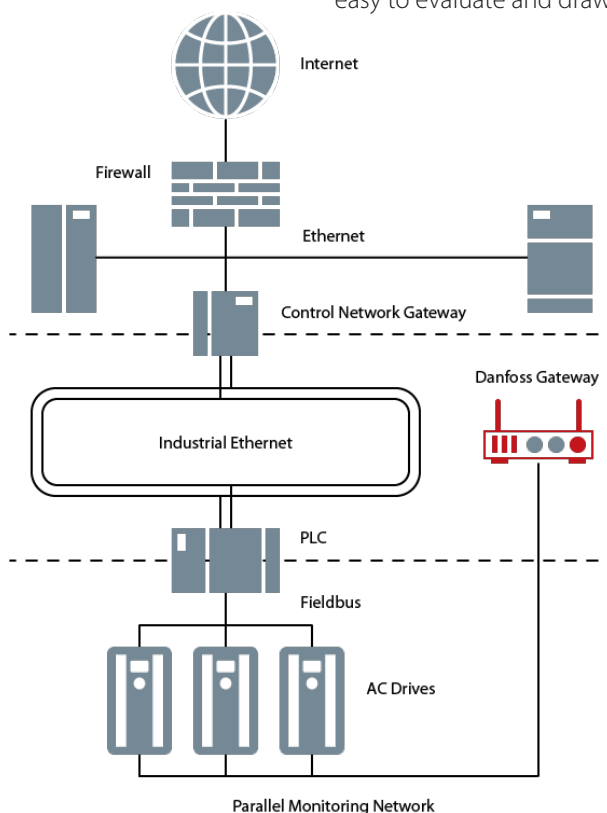

Communication channels to notified service and maintenance personnel.

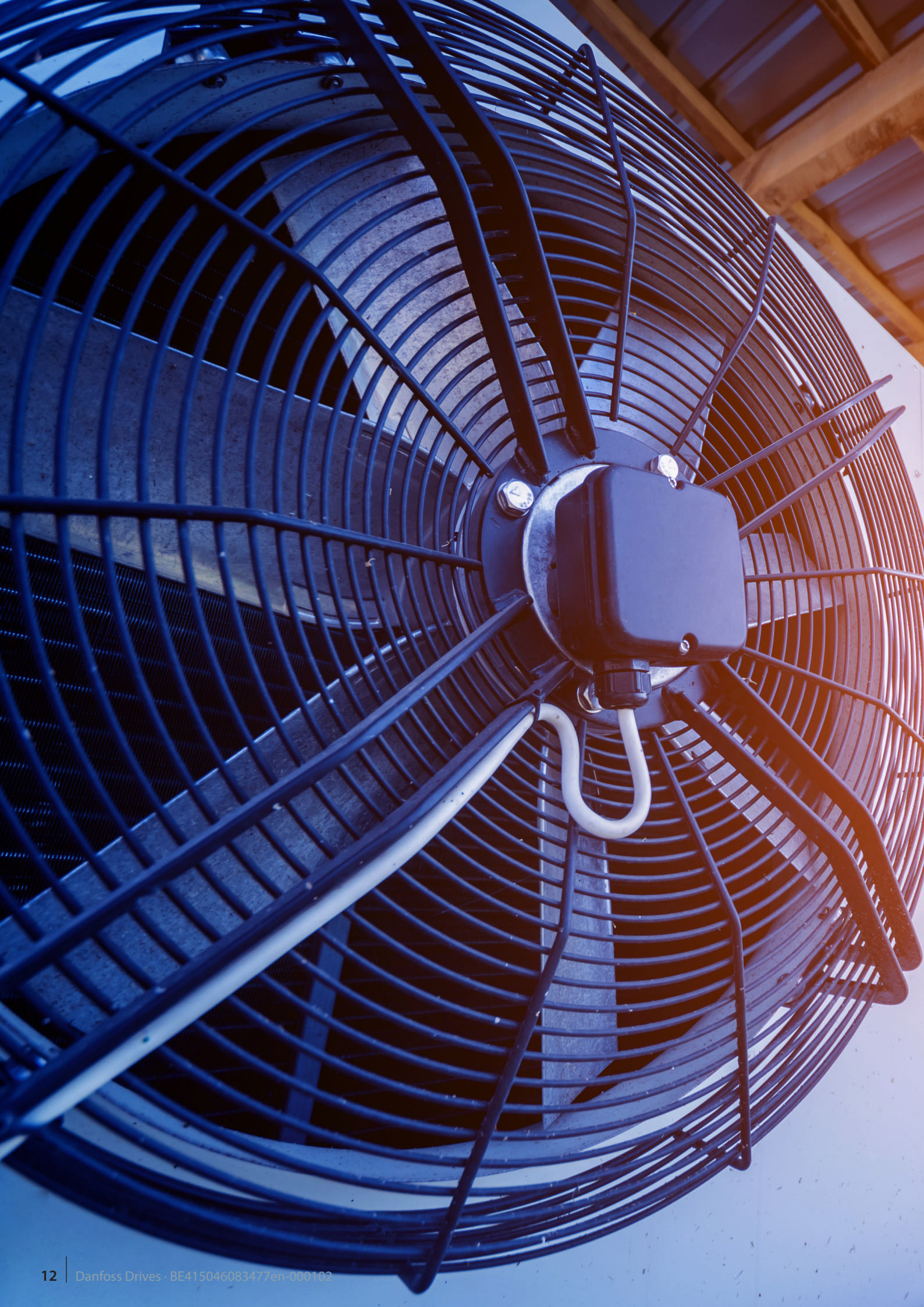

Features and benefits

of condition-based monitoring

Features	Benefits
Condition-based monitoring.	<ul style="list-style-type: none"> ■ Increase uptime of your application ■ Detect failure at an early stage ■ Evaluate on real application baseline data ■ Document system stability ■ Optimize use of resources and enables advance planning ■ Reduce cost of unexpected downtime ■ Reduce stock of spare parts ■ Benchmark tool for optimal operation
Condition-based monitoring embedded in the drive	<ul style="list-style-type: none"> ■ Permanent monitoring removing regular checks ■ Monitoring at all speed and operation conditions ■ Cost-effective solution by using installed drive ■ No cloud connection required, giving a high security level and no subscription fee ■ Reduced installation costs, <ul style="list-style-type: none"> ■ no external controller to generate the application observation and notification ■ reduced cable installation as sensors are often mounted close to the drive ■ Monitoring is related to the actual speed of the application
Motor - Stator-winding insulation	<ul style="list-style-type: none"> ■ Early detection and action on faults in the motor stator winding insulation, before the fault develops into a crippling failure and unscheduled operational stop ■ Reduced spare part stock of expensive motor
Load-envelope monitoring	<ul style="list-style-type: none"> ■ Secure operation condition inside expected load conditions, to ensure load is not too high nor too low ■ Application monitoring as qualification of the production process and the product quality.
Sensor application monitoring (external)	<ul style="list-style-type: none"> ■ Any sensor could be connected to monitor a specific condition in the application, that will have a relation to speed in the monitoring. ■ Ensure vibration levels are within the defined limits. Detects change of condition in ball-bearings and checks for imbalance and eccentricity, looseness, misalignment, and mechanical resonance ■ Flow and pressure sensors are also important in some applications, with the same benefit of early detection of changes in the application. ■ Higher precision of fault detection as sensor monitoring relates to motor speed.
Application baseline	<ul style="list-style-type: none"> ■ Real operation values for generation of threshold values for monitoring ■ Two baselines to compare development in the application over time or in a service case ■ Optimization of the operation including connected elements ■ Benchmarking tool to compare different installations, optimize operation conditions, and reduce energy consumption. ■ Real application baseline as handover documentation between installer and end-user.
Notification	<ul style="list-style-type: none"> ■ Dedicated information to relevant persons: from local indication to remote solutions, and notifications to enable the person to take action

Specifications

System integration	
Condition Based Monitoring license key ordering code ¹⁾	LX1X software choice in drive configurator, activated from factory, or field update via <ul style="list-style-type: none"> ■ 130S0001 for drives 0-7.5 kW ■ 130S0002 for drives 11-90 kW ■ 130S0003 for drives > 90 kW
Application monitoring	Monitoring is normal generated on the actual application baseline performance, from minimum to maximum speed with default values for threshold generation. The CBM function can handle two baselines and it includes minimum and maximum, mean and 3 standard deviation values, as operation counts inside each of the 20 speed ranges. OEMs will often program the settings from the factory, based on their knowledge of correct baseline behavior in the defined application.
The CBM function complies with relevant standards and guidelines	<ul style="list-style-type: none"> ■ ISO 13373 standard for Condition Monitoring and Diagnostics of Machines ■ VDMA 24582 guideline for condition monitoring ■ ISO 10816/20186 standards for measurement and evaluation of mechanical vibration.
Stator winding	Monitoring of the winding insulation of IM and PM motors, with the VCC+ motor control. This function is deselected in Flux and other motor technologies.
Load – envelope	Monitoring of excessive and/or inadequate torque consumption.
Sensor monitoring (External sensors)	<p>4 sensor inputs via analogue 0/4-20 mA and/or 0-10 V inputs.</p> <ul style="list-style-type: none"> ■ Vibration sensors are the most used sensor for early detection of problems in the application: <ul style="list-style-type: none"> ■ Velocity RMS sensor monitors imbalance and eccentricity, looseness, misalignment, and mechanical resonance. ■ Accelerator G-Peak sensor detects change of condition in the motor, fan and gearbox ball-bearings, as well as any lack of lubrication. ■ Other sensor inputs: flow, pressure, or other sensors related to speed of the application <p>Sensor ordering numbers</p> <ul style="list-style-type: none"> ■ Velocity RMS sensor 0-25 mm/s / 4-20 mA (134B8493) ■ Accelerator G-Peak sensor 0-10 G / 4-20 mA (134B8492) ■ Sensor cable 10 m with straight M16 female connector (134B8496)
Option I/O modules	The drive has 2 standard analogue inputs for sensors and other inputs via option modules: <ul style="list-style-type: none"> ■ VLT® General Purpose I/O MCB 101 (130B1125) + 2 * 0-10 V input ■ VLT® Analog I/O MCB 109 (130B1143) + 3 * 0-10 V input ■ VLT® Programmable I/O MCB 115 (130B1266) + 3 * 0-10 V or 0/4-20 mA input
System integration	CBM values, warnings and alarms are available on fieldbus – see CBM programming guidelines for more information.
Software compatibility ¹⁾	CBM is continually optimized to provide more functionality and ease of use. We therefore recommend you update to the newest software, both for the drive and the VLT® Motion Control Tool MCT 10. CBM is available for a wide variety of drives. Check the range here

¹⁾ For software update or upgrade of installed drives, please **contact Danfoss Drives**.