

User Guide

Temperature controller
for walk-in coolers and freezers
Type **AK-RC 305W-SD**



Contents	1. Versions and references	3
	2. Warnings	3
	3. Maintenance	3
	4. Description	3
	5. Installation	4
	6. Wiring	5
	7. Installation of the probes	5
	8. Initial configuration (wizard)	6
	9. Operation	7
	9.1 Cold regulation	9
	9.2 Door management	12
	9.3 Defrost	12
	9.4 Defrost control	13
	9.5 Evaporator fans	14
	9.6 Alarms	15
	9.7 Alerts	16
	9.8 Light control	16
	9.9 Password	16
	9.10 Remote Stand-by mode	16
	9.11 Operation of the auxiliary relays	16
	10. Configuration	17
	11. Troubleshooting	21
	12. Technical specifications	22
	13. Ordering	22

1. Versions and references

Model	Description	Power supply	Circuit Breaker Protection
AK-RC 305W-SD	AK-RC 305W-SD Gen. 2,5 O/P, Single phase	100 – 240 V~ 50/60 Hz	-

2. Warnings

- If the equipment is used without adhering to the manufacturer's instructions, the device safety requirements could be compromised. Only probes supplied by Danfoss must be used for the unit to operate correctly.
- From -40 – +20 °C, if the NTC probe is extended to 1000 m with at least 0.5 mm² cable, the maximum deviation will be 0.25 °C
- It should be installed in a place protected from vibrations, water and corrosive gases, where the ambient temperature does not exceed the value indicated in the technical data.
- For the reading to be correct, the probe should be used in a place without heat influences apart from the temperature you want to measure or control.
- IP65 protection degree is only valid with the protection cover closed.
- IP65 protection degree is only valid if the cables enter the device using a tube for electric conductions + gland with IP65 or above. The size of the glands should be suitable for the diameter of the tube used.
- Do not spray the unit directly with high-pressure hoses, as this could cause damage.

Important:

- **Before starting the installation, you must take the advice of local regulations in force.**
- The AUXILIARY relays are programmable, and their operation depends on the configuration.
- The function of the digital inputs depends on the configuration.
- The recommended currents and powers are the maximum working currents and powers.

3. Maintenance

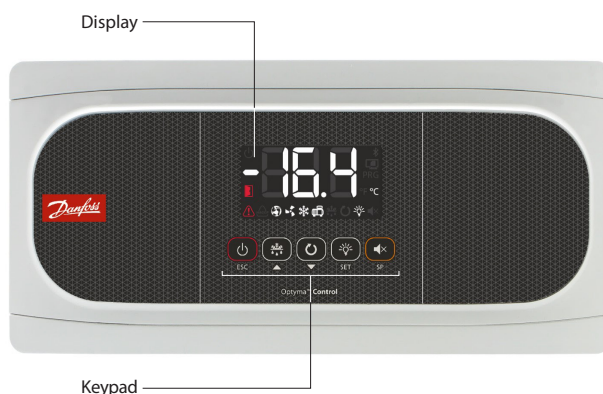

- Clean the surface of the unit with a soft cloth, water and soap.
- Do not use abrasive detergents, petrol, alcohol or solvents, as this might damage the unit.

4. Description





- | | | | |
|--|--|-------|--|
| | Fixed: Stand-by Mode activated. Regulation is paused.
Flashing: Controlled shutdown process for the regulation in progress. | | Fixed: The cold solenoid is active.
Flashing: The solenoid should be active but a delay or protection is preventing this. |
| | Fixed: Cold room door open.
Flashing: The door has been open for a greater time than has been defined in parameter A12 . | | Fixed: Compressor active.
Flashing: The compressor should be active but a delay or protection is preventing this. |
| | There is an active alarm, but not an active HACCP alarm. | | Defrost relay active. |
| | Fixed: HACCP alarm active.
Flashing: HACCP alarm registered and unconfirmed. Press the key to confirm an HACCP alarm. | | Continuous cycle mode active. |
| | Fixed: The ADAPTIVE mode is active.
Flashing: An error has been detected in the ADAPTIVE mode. | | Cold room light active. |
| | Fixed: Evaporator fans active.
Flashing: The evaporator fans should be active but a delay is preventing this. | | Alarm in progress muted. |
| | | °F °C | Temperature displayed in ° Fahrenheit / ° Centigrade. |
| | | PRG | Programming mode active. |

4.1 Keypad

 Pressing it for 3 seconds activates/deactivates Stand-By mode. In this mode, regulation is paused and the  icon is displayed. In the programming menu, this exits the parameter without saving changes, returns to previous level or exits programming.

 Pressing once without holding displays the temperature of probe S2 for 2 seconds (if it is enabled). Pressing it for 3 seconds starts/stops the defrost. In the programming menu, this allows scrolling around the different levels, or, during the setting of a parameter, changing its value.

 A brief press shows the ADAPTIVE mode operating alerts. Pressing it for 3 seconds activates/deactivates continuous cycle mode. In the programming menu, this allows scrolling around the different levels, or, during the setting of a parameter, changing its value.

STAND-BY
 If the temperature regulation cannot be instantly stopped due to its configuration, a controlled stop process starts and the  icon flashes. To stop the controlled stop process and force the step to Stand-by, press the Stand-by key again for 3 seconds.

 Pressing once without holding activates/deactivates the cold room light. Pressing it for 3 seconds accesses the condensed programming menu. Pressing it for 6 seconds accesses the expanded programming menu. In the programming menu, this accesses the level shown on the display or, during the setting of a parameter, accepts the new value.

 Pressing once without holding displays the current effective value of the Set Point, taking into consideration temporary modifications by other parameters (**C10** or **C12**). When an alarm is in progress, pressing once without holding mutes the acoustic alarm. Pressing for 3 seconds accesses the Set Point setting.

5. Installation

- Remove the bezels (1)
- Make a 1/4 turn of the screws (2) anti-clockwise and open the door (3).
- Install the necessary glands (4 / 5) by drilling holes in the points indicated on the box.
- Mark and make the holes in the wall with the aid of the template included.
- Fix the device to the wall. If it is a brick wall, use the screws and plugs supplied; if the wall is made of sheet metal (cold room store), use the screws provided without plugs (6).
- Wire the device by following the recommendations indicated on page 5.
- Close the cover (3), tighten the screws (2) and replace the bezels (1).

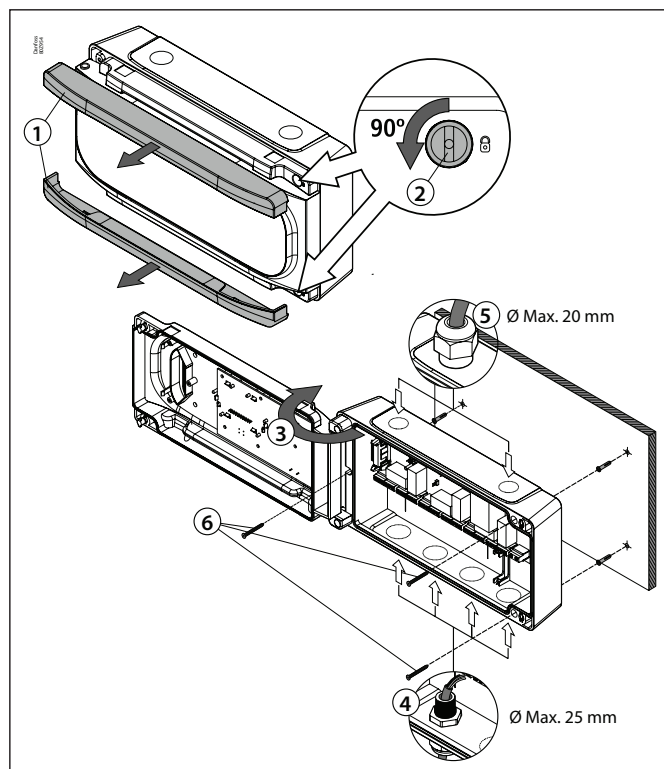

6. Wiring

 Always disconnect the power supply to do the wiring. The probes and their cables should **NEVER** be installed in a conduit together with power, control or power supply cables.

For disconnection, the power supply circuit must be equipped with a switch of at least 2 A, 230 V, located near the device. The power supply cable will be H05VV-F or NYM 1x16/3. The section to be used will depend on the local standard in force but must never be less than 1.5 mm².

Cables for relay or contactor outputs should have a section of 2.5 mm², allow working temperatures equal to or over 70 °C and be installed with as few bends as possible.

The 230 V~ wiring must be kept clear of any other external element.

- The specific wiring to be performed depends on the option selected in the initial configuration wizard.
- Use the appropriate diagram based on the option selected.
- Check the available options on the diagram sheet included with your device.

Important:

- Before starting the installation, you must take the advice of local regulations in force.
- The AUXILIARY relays are programmable, and their operation depends on the configuration.
- The function of the digital inputs depends on the configuration.
- The recommended currents and powers are the maximum working currents and powers.

7. Installation of the probes

To achieve maximum performance from the advanced controller, the correct installation of the probes is key, as they are responsible for calculating the evaporator's thermal transfer coefficient, evaluating the start and end of the defrosts and diagnosing problems in the evaporator.

Material included

- 4 mm hermetic evaporator probe, 1.5 m of cable.
- Ambient probe
- 1 mounting clip for 10 – 13 mm coil
- 1 mounting clip for 14 – 18 mm coil
- 1 mounting clip for 19 – 21 mm coil
- 1 mounting clip for 22 – 25 mm coil

Location of the ambient probe

The probe should be located in a place that does not directly receive the flow of cold air from the evaporator. Preferably in its air aspiration area.

Location of the evaporator probe

The probe must be located as near as possible to the inlet of refrigerant from the evaporator (close to the expansion valve) in the finned area. In certain evaporators, for example cubic ones, this inlet may be located on the front part of the battery, just behind the fan.

If defrost is done by electric heat, the probe must be located far away from them and, if possible, in the area of the evaporator where defrosting is slower, in other words, in the last area to defrost.

If the two conditions are not possible, the best possible compromise must be looked for.

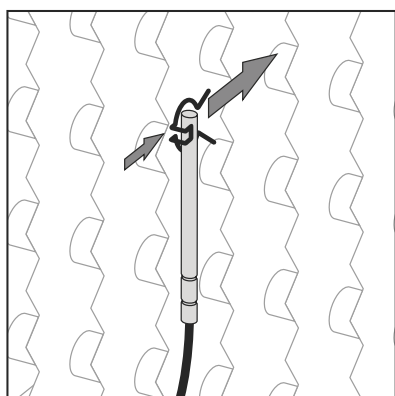

Select the appropriate clip depending on the size of its evaporator pipe.

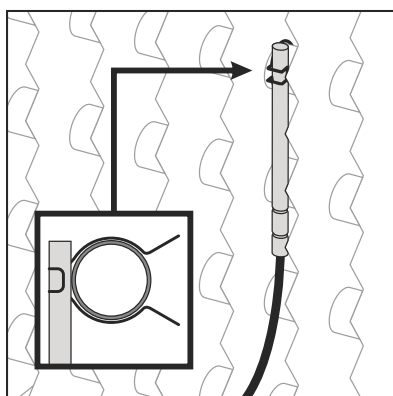

Attach the probe to the pipe using the clip, making sure that its end is in direct contact with the tube.

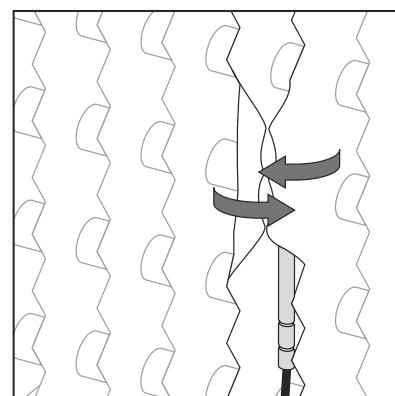

Bend the fins of both ends of the probe to increase the fixing and contact surface.

8. Initial configuration (wizard)

The first time the unit receives the power supply, it will enter into ASSISTANT mode. The display will show the message *InI* flashing with **0**.

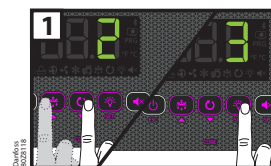

Step 1:

Select the most suitable InI option based on the type of installation to be carried out and press **SET**. The available options will be shown in the following table:

InI	Type of installation				Parameters										Diagram to be used
	Cold regulation	Pump Down	Defrost	Evap. fans	Pd	o00	I00	I10	I11	I20	I21	d1	d7	F3	
0	Demo Mode: it displays the temperature but does not regulate the temperature or activate relays														
1	Solenoid	No	Electric	Yes	0	0	2	0	0	0	0	20	0	0	A
2	Solenoid + compressor	Yes	Electric	Yes	1	1	2	7	1	0	0	20	0	0	B
3	Solenoid + compressor	No	Electric	Yes	0	1	2	0	0	0	0	20	0	0	B
4	Solenoid	No	Air	Yes	0	0	1	0	0	0	0	20	1	1	A
5	Solenoid + compressor	Yes	Air	Yes	1	1	1	7	1	0	0	20	1	1	B
6	Solenoid + compressor	No	Air	Yes	0	1	1	0	0	0	0	20	1	1	B
7	Solenoid + compressor	Yes	Hot gas	Yes	1	1	2	7	1	9	1	5	2	0	C
8	Solenoid + compressor	No	Hot gas	Yes	0	1	2	0	0	9	1	5	2	0	C

Note: If options 2, 5, or 7 are chosen, check the configuration of parameter I11 according to the pressure switch type used. (See diagram included with the device).

Step 2:

Use keys ▲ and ▼ to enter the desired Temperature Set Point value and press **SET**. The configuration wizard has finished. The unit will begin to regulate the temperature.

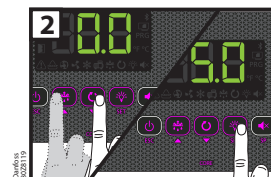

If this is not the first time you use the wizard, after completing the last step the display will show the message **dFp** (default parameters). You may choose between two options:

0: Only changing the parameters which affect the wizard. The other parameters will remain the same.

1: All parameters return to their factory setting except those which have been modified by the wizard.

Important: The wizard will not reactivate. To enter the wizard mode, initiate Stand-by mode by pressing the ⏻ key for 3 seconds and wait until the unit completely halts the temperature regulation (the ⏻ indicator will light up permanently) and press the following keys in sequence one after the other, ▲, ▼, **SET**.

Stand-by: If the regulation cannot be instantly stopped due to its configuration, a controlled stop process starts and the ⏻ icon flashes. To stop the controlled stop process and force the step to Stand-by, press the Stand-by key again for 3 seconds.

9. Operation

Display messages	
	Pump down malfunction error (stop), the time configured in parameter C20 has been exceeded. Only displayed on screen.
	Pump down malfunction error (start-up), the time configured in parameter C19 has been exceeded. Only displayed on screen.
	Probe 1/2/3 failure (open circuit, crossed circuit or temperature outside the limits of the probe) (Equivalent limits in °F). Only E2 and E3: Damp evaporator probe. Activates the alarm relay and the audible alarm. Flashing with temperature: Probe error 1/2/3 in ADAPTIVE mode. Flashing with CAL: Probe error 1/2/3 during the calibration.
	Open door alarm. Only if the door remains open for a longer time than defined in parameter A12. Activates the alarm relay and the audible alarm.
	Maximum temperature in control probe alarm. The temperature value programmed in A1 has been reached. Activates the alarm relay and the audible alarm.
	Minimum temperature in control probe alarm. The temperature value programmed in A2 has been reached. Activates the alarm relay and the audible alarm.
	External alarm activated (by digital input). Activates the alarm relay and the audible alarm.
	Severe external alarm activated (by digital input). Activates the alarm relay and the audible alarm.
	Alarm for defrost completed due to time-out. The time set in d1 has been exceeded. Activates the alarm relay and the audible alarm.
	HACCP alarm. The temperature has reached the value of parameter h1 during a longer period than established in h2. Activates the alarm relay and the audible alarm.
	HACCP alarm due to a power supply failure. The temperature established in h1 has been reached, following a power supply failure. Activates the alarm relay and the audible alarm.
	Indicates that a defrost is being performed. Only displayed on screen.
	Password request. See parameters b10 and PAS. Only displayed on screen.
	Shown sequentially with the temperature: The controller is in demo mode, the configuration has not been made.
	Calibration ongoing, therefore, avoid, as far as possible, opening the cold room during the process.
	Flashing with temperature: Configuration has been changed from 1 to 2 evaporators or vice versa.

ADAPTIVE MODE ALERT MESSAGES (Only shown pressing the ▼ key)	
	Defrost end error in 1/2 evaporator during the calibration, defrost has not ended due to temperature.
	Error during calibration in 1/2 evaporator. There is not enough difference in temperature between the cold room probe and the evaporator probe.
	It has not been possible to carry out the calibration due to a lack of stability in the system (Excessive door opening, excessive oscillations in the lower pressure, etc.).
	Error during normal operation (ADAPTIVE Mode active) in 1/2 evaporator. There is not enough difference in temperature between the cold room probe and the evaporator probe.
	A lack of stability has been detected in the system (Excessive door opening, excessive oscillations in the low pressure, etc.) during normal operation (ADAPTIVE Mode active).
	The persistent lack of stability has led to the deactivation of the ADAPTIVE mode.
	Excessive door openings have been detected during calibration and it has not been possible to calibrate.
	Excessive door openings have been detected and the device cannot regulate in ADAPTIVE mode.

ADAPTIVE mode

If the ADAPTIVE mode is activated (default configuration), the device periodically evaluates the evaporator's heat transfer, managing the available resources to maximise it.

The defrosts are minimised, adapting to the changing conditions of the cold room, reducing heat input into the refrigerated space, thermal stress in the evaporator and energy consumption.

Operation of the evaporate fans is optimised taking into account the compressor status, evaporate temperature, frost level, opening of the door, etc.

The control function of the drainage resistor minimises its activation (moments before starting a defrost), thereby reducing energy consumption.

To achieve correct operation of the ADAPTIVE mode, it is very important for the probes to be correctly installed, as described on page 5.

Calibration



During the first hours of operation, the device performs two calibrations automatically, during which the display shows the **CAL** message. Calibration may take several hours and include several refrigeration and defrost cycles.

During the calibration processes, the following should be avoided:

- Opening the cold room door
- Turning the controller off or putting it on stand-by
- Changing controller parameters, including the set point

IMPORTANT:

While the calibration process is active:

- Manual defrost cannot be activated (key)
- The continuous cycle cannot be activated
- The set point change function cannot be activated

If calibration cannot be performed, or if an important part of the installation is replaced (compressor, evaporator, etc.) it is advisable to perform a manual calibration.

It is also recommended (not essential) to perform a manual calibration, once the installation has completed its commissioning, with a load inside it and when its operating temperature has been stabilised, after several days of operation, in this way calibration is optimal.

In the event of changing the set point or hysteresis, the device performs a calibration again automatically, except if the set point change is made using the "set point change mode" function.

To perform a manual calibration, access the parameter menu and follow the sequence indicated below:

- Access parameter **b30**
- A security code is requested, enter code 63
- Using keys ▲ and ▼, select option 1 and press **SET**

9.1 Cold regulation

Solenoid control (COOL Relay)

Cold production is regulated by means of opening / closing the solenoid valve.

When the temperature in probe S1 reaches the set point (SP) value plus the probe's differential (C1), the solenoid opens and causes the temperature to drop. Once the set point (SP) value is reached, the solenoid closes.

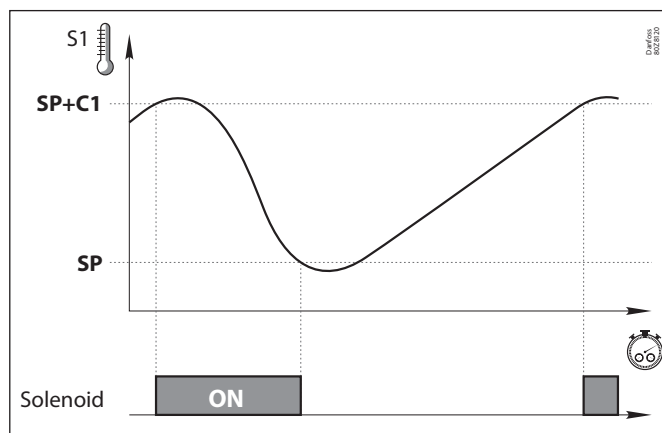

Compressor control (Relay AUX 1)

With Pump Down (Inl: 2, 5, 7)

Requires the connection of a low pressure switch in digital input 1.

When the temperature in probe S1 reaches the set point (SP) value plus the probe's differential (C1), the solenoid opens, causing the pressure in the evaporator to increase and, therefore, the low pressure switch deactivates and the compressor starts up.

Once the set point (SP) value is reached, the solenoid closes, causing the pressure in the evaporator to decrease, triggering the low pressure switch and stopping the compressor.

For further details of the process, see page 10.

Without Pump Down (Inl: 3, 6, 8)

The compressor operates simultaneously with the solenoid valve, starting up when the latter opens and stopping when it closes.

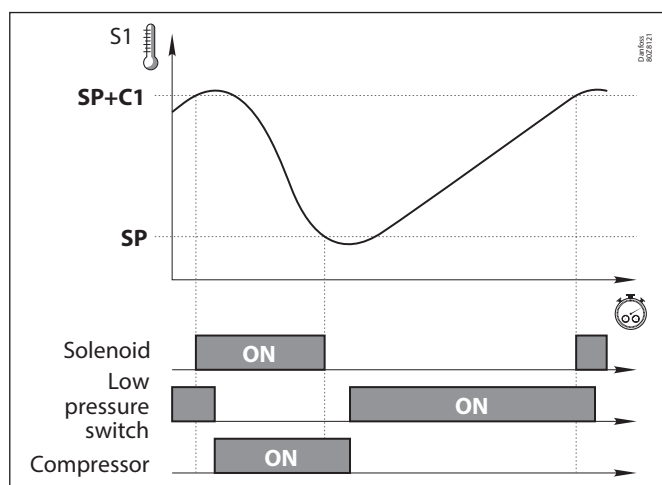

Operation in the event of a fault in probe S1

If probe S1 fails (fault, disconnection, etc.), compressor behavior will depend on parameter C6, with one of 3 options available:

- C6=0:** The compressor is stopped until probe S1 begins to operate again.
- C6=1:** The compressor is started-up until probe S1 begins to operate again.
- C6=2:** The compressor operates in line with the average operation during the 24 hours prior to the error, taking into account the number of start-ups and stops and the average time in each state (stop-start). If 24 hours have not elapsed without a probe error, the device moves to C6=3 mode.
- C6=3:** The compressor operates in line with the times programmed in C7 (ON) and C8 (OFF).

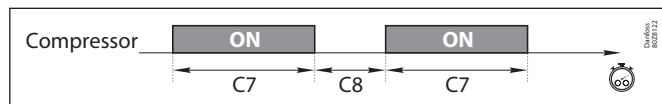

Regulation of cold with two temperature probes (S1 + S3)

This requires configuration of digital input 2 as cold room temperature (**I20=10**).

The device regulates the temperature of the cold room taking into account the reading of both probes. Using parameter **C25**, the influence of probe S3 is determined in the regulation.

- Examples: **C25=0** (S1: 100 %, S3: 0 %)
- C25=75** (S1: 25 %, S3: 75 %)
- C25=60** (S1: 40 %, S3: 60 %)
- C25=95** (S1: 5 %, S3: 95 %)

This mode is particularly useful in large volume cold room stores, where there may be significant variations of temperature.

In the event of an error in probe 3 (E3), the controller only uses the reading of probe 1. If both probes break (E1+E3), the controller acts according to parameter **C6**.

Continuous cycle mode

This is used to quickly cool the cold room stores before products are loaded and is activated by pressing the **⏻** key for 3 seconds.

Upon activating this mode, the compressor begins to operate until the temperature in probe S1 reaches the set point value, minus the variation indicated in parameter **C10**. The value of **C10** is always negative, unless it is 0.

The unit will immediately return to normal operation. Should it not be possible to reach this point, the device will return to normal operation once the time configured in **C9** has elapsed, or by pressing the **⏻** key again for 5 seconds.

Calibration of probe 1

Parameter **C0** allows for correction of the temperature detected by probe 1; this is particularly useful when the probe cannot be located in the ideal place.

Set Point locking

Parameters **C2** and **C3** allow for an upper and lower limit to be established for the set point (**SP**), to protect the product or installation from Set Point manipulation.

Product temperature

This function allows using a temperature probe to display the product temperature. To activate it, input 2 must be configured as "Product temperature" (**I20=11**), and the display of all the probes activated sequentially (**C21=0**).

Set Point change mode

This allows for quick alternation between two working temperatures in the cold room store, modifying the Set Point in line with the value indicated in parameter **C12**. The aforementioned value may be negative or positive, which allows for the Set Point to be reduced or increased. If it is configured in 0, the mode is disabled.

It can be activated as follows:

- By means of an external switch connected to one of the digital inputs. The digital input should be configured as Set Point change (**I10** or **I20=4**). Activation through this method cancels any other activation and can only be deactivated using the same method.
- By Modbus: this requires the device to be connected to a Modbus network.

IMPORTANT:

While the ADAPTIVE mode is active:

- It is recommended for calibration to be performed with the lowest set point value.
- It is recommended that the difference between set points is not greater than 5 °C in negative cold rooms and 2 °C in positive cold rooms.

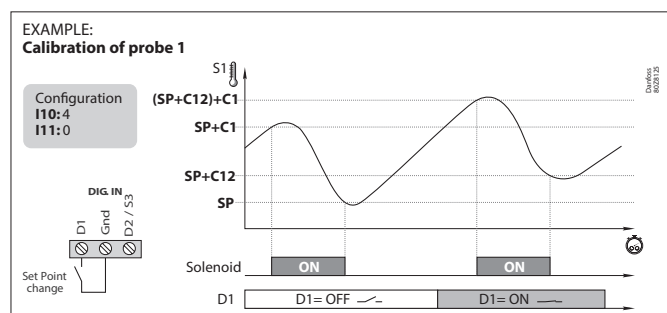
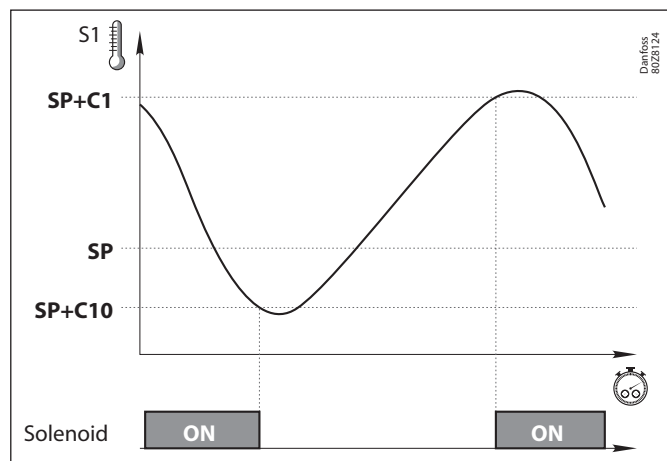

Compressor protection timing

Parameter **C4** allows for selection of the type of timing to be applied to protect the compressor. These delays prevent continuous compressor starts and stops.

These timings affect the COOL and AUX 1 relays (if **o00=1**)

OFF-ON (C4=0): Minimum time in OFF mode before each start-up.

OFF-ON / ON-OFF (C4=1): Minimum time in ON and OFF mode for each cycle. The delay time is defined by means of parameter **C5**; if **C5=0**, timing is disabled.

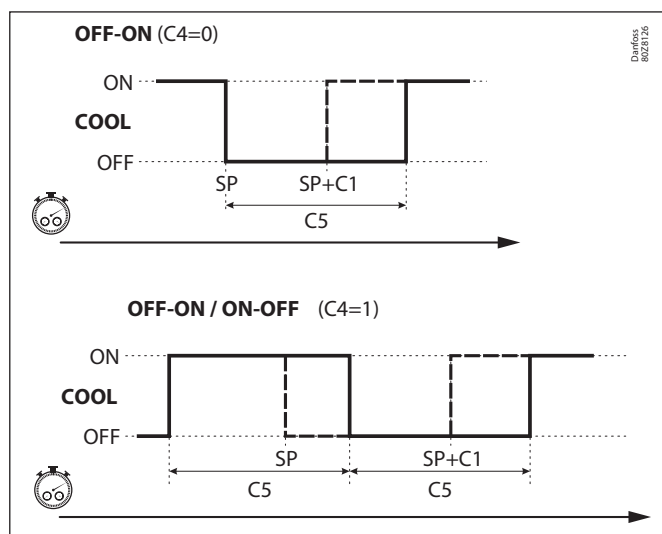

Pump down function

This function foresees problems in the compressor caused by movements of coolant, using a stop/start technique for the installation, controlled via the liquid solenoid, the low pressure switch and the compressor itself.

This function is only available for **Inl** options 2, 5 and 7 and requires the connection of a low pressure switch in digital input 1 (**I10=7**).

STOP

When the temperature in probe S1 reaches the set point (**SP**) value, the COOL relay deactivates, closing the liquid solenoid. Because the compressor continues to operate, pressure in the evaporator quickly drops. Upon reaching a given value, the low pressure switch activates, changing the status of digital input 1, which stops the compressor (relay AUX 1).

This action isolates all of the refrigerant in the high-pressure line, far from the compressor crankcase, preventing serious faults upon start-up.

Should the low pressure switch fail, the controller stops the compressor once the safety interval defined in **C20** has elapsed, displaying the message "Pd" (an informative message that does not affect the unit's operation).

If **C20** time is 0 (default value), the compressor will not stop until the low pressure switch is activated, but it will display the "Pd" message after 15 minutes.

START

When the temperature in probe S1 reaches the set point value plus the differential (**SP+C1**), the COOL relay activates, opening the liquid solenoid. This increases the pressure in the evaporator, deactivating the low pressure switch, which turns the compressor on.

If, some time (determined by **C19**) after the liquid solenoid is opened (COOL relay set to ON), the low pressure switch does not deactivate, the controller will once again close the solenoid (COOL relay set to OFF) and the "LP" message will be displayed. This action will be repeated every 2 minutes, indefinitely, until the pressure switch is deactivated and the installation reverts to its normal operation.

If **C19** time is 0 (default value), the solenoid will remain open until the low pressure switch deactivates, but it will display the "LP" message after 5 minutes.



STAND-BY

If the pump down function is active, a certain amount of time may elapse between starting the stand-by function and the controller stopping; this is because certain installation control phases cannot be interrupted.

To force the stop of the controller, press the Stand-by key again for 3 seconds.

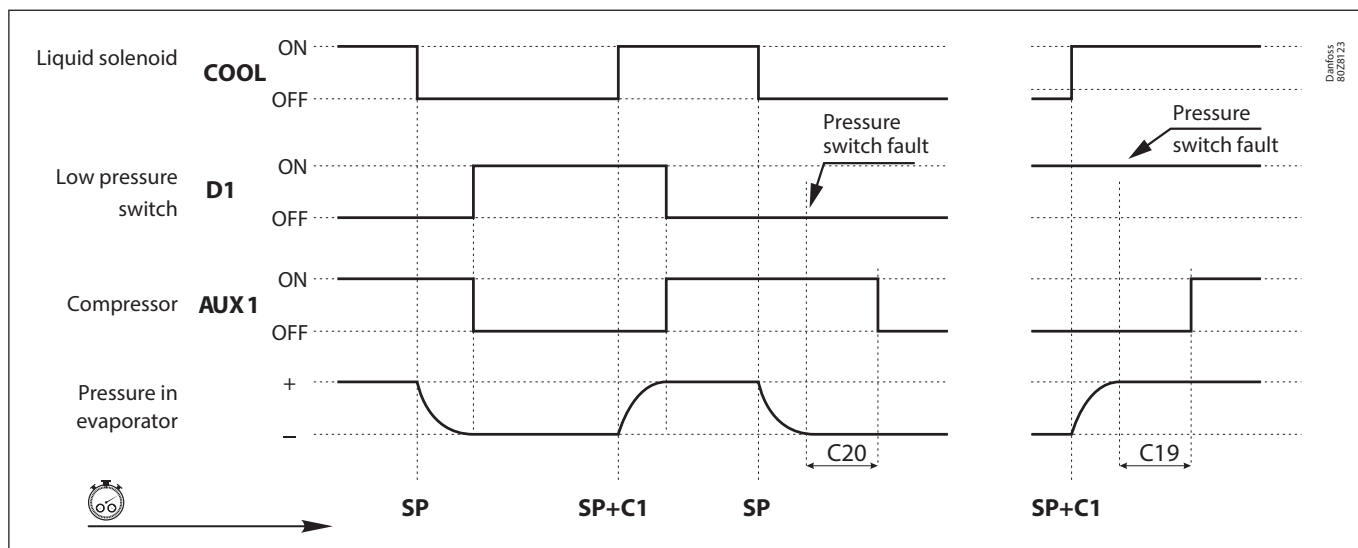

9.2 Door management

Door management requires configuring one of the digital inputs as "Door contact" (**I10** ó **I20**=1).

Standard operating mode (CE=0)

Door management allows for the installation's behavior to be controlled, should the cold room door open through parameters **C22** and **C23**.

Parameter **C22** defines whether cooling should be stopped if the door opens. If **C22**=1, when the door opens, the fans stop and, 15 seconds later, the solenoid closes (COOL relay).

Parameter **C23** defines the maximum time, in minutes, that the installation can remain without cooling whilst the door is open. If **C23**=0, cooling does not occur with the door open.

ADAPTIVE operating mode (CE=1)

If the **ADAPTIVE** mode is active, in the case of opening the door, the fans stop, or do not stop, depending on parameter **C22**. If the door does not close, when the time set in parameter **C24** has passed, cold production stops and does not activate again until the time set in **C23** has passed.

If, when the door is opened, cold is not being produced, only parameter **C23** is taken into account.

Management of door frame resistor

If the Set Point is equal to or below $-4\text{ }^{\circ}\text{C}$ and the relay AUX 2 has been configured as "door frame resistor" (**o10**=4), the resistor is activated (relay ON) when the temperature of the cold room drops below $-3\text{ }^{\circ}\text{C}$, and is deactivated (relay OFF) when $0\text{ }^{\circ}\text{C}$ is reached.

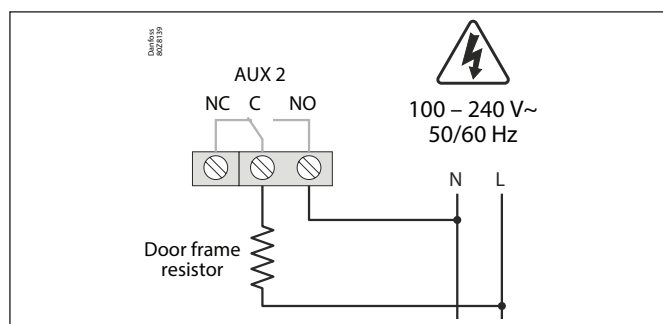
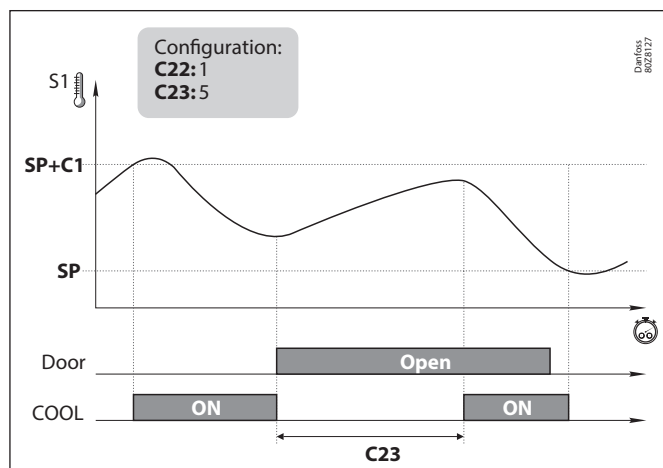

9.3 Defrost

Types of defrost

There are 3 possible defrost types, depending on the option selected in the wizard (InI):

Electric (InI=1, 2 and 3) (d7=0)

Defrost is performed through electrical resistors, supplying the evaporator with heat. The operation of fans in this mode depends on parameter F3; the compressor and solenoid are stopped.

By air (InI=4, 5 and 6) (d7=1)

Usually used in positive cold rooms ($> 3\text{ }^{\circ}\text{C}$), since the inside temperature of the cold room is sufficient to melt evaporator ice. By default, the fans are activated so that air may circulate through the evaporator; to stop them, change parameter F3 to 0. The compressor and solenoid are stopped.

Hot gas (InI=7 and 8) (d7=2)

The hot gas from compressor discharge is used to melt evaporator ice and, to this end, two valves are necessary: one at the condenser input (A) (SSV relay) and another between the compressor output and the evaporator input (B) (DEF relay).

During the process, the liquid solenoid valve (C) and the condenser input valve are closed and the evaporator input valve is opened, forcing hot gas to pass through the latter and melting the ice.

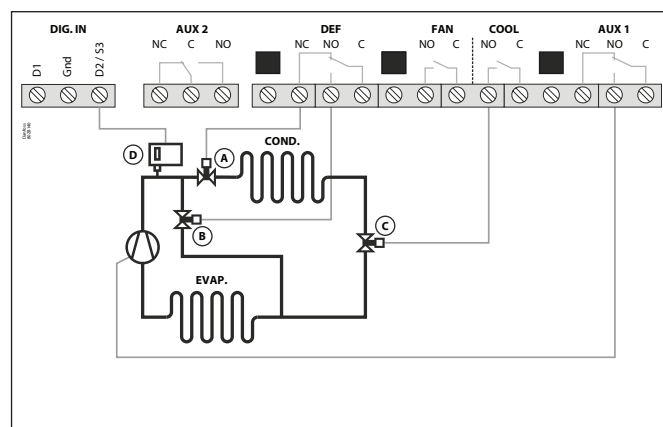

Optionally, a high pressure switch (D) can be added to control the solenoid valve (digital input D2, **I20**=9) during the defrost process using hot gas. If the pressure decreases, the solenoid opens to allow liquid into the tank; when the pressure rises again, the solenoid closes.

9.4 Defrost control

9.4.1 Control of defrost in standard mode (CE=0)

Defrost start

Defrost will start if:

- The time programmed in parameter **d0** has elapsed since the start of the last defrost.
- We press the key for 3 seconds.
- By means of an external push-button (**I10** / **I11**=5).
- Through the Modbus

Defrost completion

Defrost will complete if:

- The temperature programmed in parameter **d4** has been reached in probe 2. This requires a 2nd probe (**I00**=2) to be available, located in the evaporator.
- The time configured in parameter **d1** has elapsed (maximum defrost duration).
- We press the key for 5 seconds.
- By means of an external push-button (**I10** / **I11**=5).
- Through the Modbus.

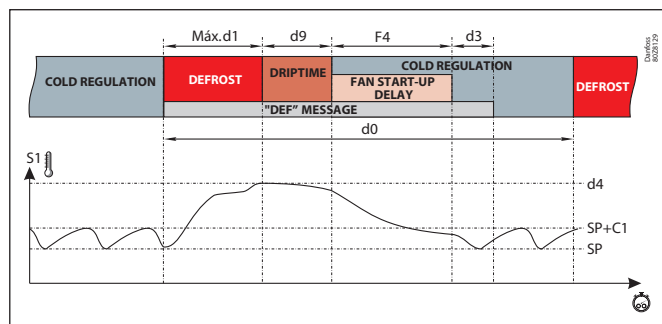

9.4.2 Control of defrost in ADAPTIVE mode (CE=1)

Defrosts in ADAPTIVE mode are not programmed, but rather the device evaluates the operation of the cold room and manages defrosts depending on the needs of the installation.

If a drop in the performance of the cold room is detected due to formation of ice in the evaporator, defrost is activated and it is supervised until its completion.

Using parameter **d30**, the defrost strategy is defined, a lower value allows less formation of frost in the evaporator, while a higher value acts with lower frequency allowing more frost to accumulate in the evaporator.

As a rule, a more aggressive strategy provides the system with greater efficiency allowing more frost to accumulate.

Adapting the value of this parameter to the type of evaporator used and to the type of defrost configured according to the table is recommended.

Parameter **d31** allows establishing a time limit without making defrosts, if the cold room does not require defrosts set it to 0, if the cold room can generate frost it is recommended to set a security time of between 2 and 7 days.

Parameter **d32** defines the maximum time permitted of the cold room without reaching the Set Point, after which an emergency defrost starts to unlock the evaporator.

Parameter **d4** defines the final defrost temperature.

Important: It is advisable to configure all the parameters relating to defrost since, in the event of a calibration or operating error of the ADAPTIVE mode, the controller then temporarily regulates in standard mode.

		Type of Defrost								
		Electric			Air			Hot Gas		
Fin spacing of the evaporator in mm	< 3	0	1	2	1	3	4	0	1	2
	3.5	0	1	2	1	3	4	0	1	2
	4	1	2	3	2	4	5	0	1	2
	4.5	2	3	4	3	5	6	1	2	3
	5	2	3	5	3	5	7	1	2	3
	5.5	2	3	5	3	5	7	1	2	4
	6	3	4	6	4	6	8	1	3	4
	6.5	3	4	6	4	6	8	1	3	4
	7	4	5	7	5	7	9	2	3	4
	7.5	4	6	7	5	8	9	2	3	4
	8	4	6	8	5	8	10	3	4	5
	8.5	5	7	8	6	9	10	3	4	5
	9	5	7	8	6	9	10	4	5	6
	9.5	5	8	9	6	10	10	4	5	6
10	6	8	9	7	10	10	4	5	6	
10.5	6	8	10	7	10	10	4	5	6	
≥11	6	9	10	7	10	10	4	5	6	

Strategy: Conservative Moderate Aggressive

Other defrost parameters

(they affect in standard and ADAPTIVE mode):

Drip time

This is established through parameter **d9** and sets the time added at the end of defrost to allow for the removal of surplus water from melted evaporator ice, during which there is no cold regulation.

Fan start-up delay

This is established through parameter **F4** and allows for the possible drops left in the evaporator to freeze before the fans activate, preventing them from being projected into the cold room. It also prevents heat being supplied to the cold room due to defrost in the evaporator.

Note: If defrost is cancelled before 1 minute has elapsed, the drip time (**d9**) is not applied and the fans are activated without taking into account the start-up delay (**F4**).

If defrost is by air or is static, the drip time (**d9**) and fan start-up delay (**F4**) are deactivated.

Message displayed during defrost

This is established using parameter **d2**, and you can choose between displaying the real temperature captured by probe 1 (**d2=0**), showing the temperature captured by probe 1 at the start of the defrost (**d2=1**), or displaying the dEF (**d2=2**) message. Parameter **d3** defines the time during which the aforementioned message will be displayed once the drip time (**d9**) and fan stop time (**F4**) are complete.

Remote defrost

This function allows defrost of the unit to be activated using an external button, connecting it to one of the digital inputs that must be configured as remote defrost (**I10** or **I20=5**).

Defrost locking

This prevents defrost starting at unusual points by means of an external switch, which may be useful for ensuring that the installation's load does not excessively increase, exceeding the permitted limits.

The external switch must be connected to one of the digital inputs, which should be configured as "Defrost locking" (**I10** or **I20=6**).

Miscellaneous

Using parameter **d5**, you can configure whether the unit performs a defrost (**d5=1**) or not (**d5=0**) when it receives power (first start-up or after a power supply failure). Should the option YES (**d5=1**) be selected, defrost will begin once the delay time defined in **d6** has elapsed.

9.5 Evaporator fans

Control of fans in standard mode (CE=0)

Fans are controlled through probe 2 (evaporator) and parameters **F0** (stop temperature) and **F1** (probe differential).

If probe 2 is not connected or an error in the probe (**E2**) is detected, the fans continuously operate without taking into account parameters **F0** and **F1**, but taking the remaining parameters (**F2** to **F4**) into account.

- Using parameter **F2**, the status of the fans during compressor stops is defined.
- Using parameter **F3**, the status of the fans during defrost is defined.
- Parameter **F4** defines the fan start-up delay time after defrost (see page 13).
- Parameter **C22** defines whether fans stop when the door is opened.

Using parameter **d8**, we define the time tally established in **d0**, choosing between total time elapsed (**d8=0**) or the sum of compressor operation time (**d8=1**).

Note: If parameter **d1** is configured to 0, no defrosts are performed.

Management of the drainage resistor

Activates the drainage resistor before the start of defrost and deactivates it one hour after finishing, avoiding unnecessary energy consumption in the absence of defrosts.

For this function to be active, parameter **o10** (Relay AUX 2) should be set to 8.

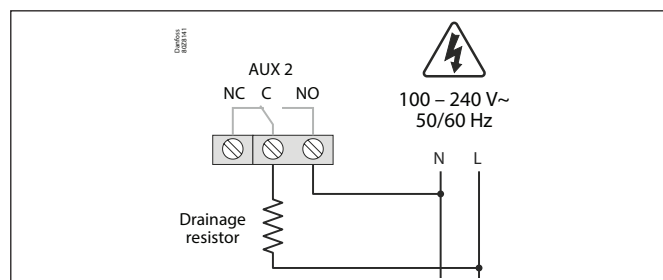

Defrost of a second evaporator

This function allows for defrost to be controlled in a second evaporator, provided that defrost is by electric heat, by air or is static. The same type of defrost should be used for the first and second evaporators.

This requires configuration of input 2 as a 2nd evaporator probe (**I20=8**). In the event of an error in the 2nd evaporator probe, defrost completes once the time defined in **d1** has elapsed.

Electric defrosting

This requires configuration of relay AUX 2 as 2nd evaporator defrost (**o10=5**). Defrost begins simultaneously in both evaporators. When the probe of evaporator 1 reaches the temperature defined in **d4**, the DEF relay deactivates, completing defrost of evaporator 1. Defrost of evaporator 2 is completed when the evaporator 2 probe reaches the temperature defined in **d4**. Drip time begins when both defrosts are complete.

Defrost by air

The fans of both evaporators are connected in parallel to the FAN relay. Defrost begins simultaneously in both evaporators and does not complete until both probes reach the temperature defined in **d4**. Drip time subsequently begins.

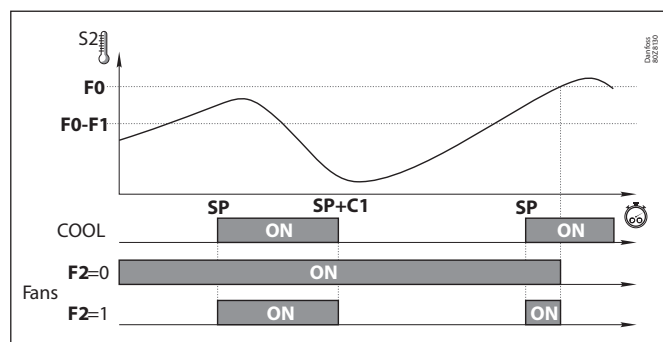

Control of fans in ADAPTIVE mode (CE=1)

With the ADAPTIVE mode active, fan control is performed taking into account the evaporator temperature, compressor, frost level, the cold room temperature and if the door is open or not, optimising its operation. In this way its operation is optimised to obtain the greatest energy efficiency of the cold room. With

Fan cycling when compressor off:

When the compressor is off, the controller will operate the evaporator fan according to the duty cycle set by parameters **F6** and **F7**. This helps to maintain a uniform temperature and postpones the need for the compressor start. Additionally, the system monitors the evaporator temperature and will halt the fan cycling if the evaporator temperature reaches the **F5** limit to prevent hot air from being recirculated into the room.

this mode active, only parameters **F0**, **F1** and **F4** need to be configured.

Important: It is advisable to configure all parameters relating to the fans since, in the event of a calibration or operating error of the ADAPTIVE mode, the controller then temporarily regulates in standard mode.

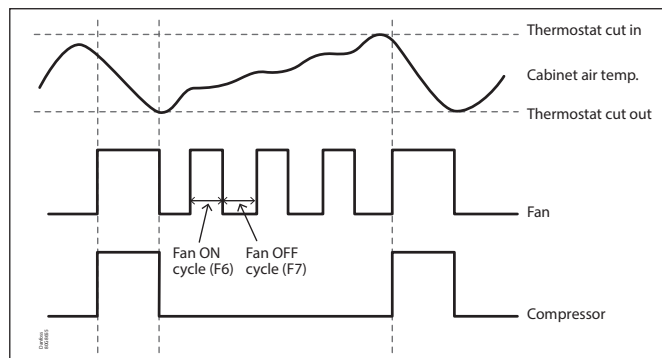

9.6 Alarms

The device warns the user through an on-screen message, activation of a relay (only if **o10=1**) and a sound alarm when the criteria programmed in the parameters are met.

Maximum / minimum temperature alarm



It shows the message "AH" or "AL" when the temperature in probe 1 reaches the value configured in parameters **A1** (maximum temperature) and **A2** (minimum temperature).

This value may be:

- Absolute (**A0=1**): The temperature at which the alarm should activate must be indicated in **A1/A2**.
- Relative to the SP (**A0=0**): The increase or decrease in the number of degrees necessary for the alarm to activate, in relation to the set point, must be indicated in **A1/A2**. This option enables us to change the set point without having to reset the maximum and minimum alarms.

Parameter **A10** establishes the differential of both parameters (Hysteresis).

Note: We configure the following parameters in a controller: **SP=2**, **A1=10**, **A10=2**

- If **A0=0** (Relative to the SP), the maximum temperature alarm will activate when 12 degrees are reached in probe 1, and will deactivate when 10 degrees are reached.
- If **A0=1** (Absolute), the maximum temperature alarm will activate when 10 degrees are reached in probe 1, and will deactivate when 8 degrees are reached.

External alarm / severe external alarm



The message **AE** (External alarm) or **AES** (Severe external alarm) is displayed when the digital input configured as external alarm or severe external alarm is activated.

The severe external alarm also deactivates all the loads and, therefore, temperature regulation stops. When this alarm disappears, the device returns to its normal operation.

At least one of the digital inputs must be configured as an external alarm (**I10** or **I20=2**) or as a severe external alarm (**I10** or **I20=3**).

Probe error alarm



If one of the enabled probes is crossed, in open circuit or out of range, the message

E1, **E2** or **E3** will be shown, depending on whether probe S1, S2 or S3 is involved.

Evaporator probe error alarm due to moisture ingress



If, at the start of defrost, the temperature in probe S2 is 20°C higher than the temperature in probe S1, the defrost ignores probe S2 and completes due to time-out.

The display shows the message **E2**, activates the alarm relay (only devices with 5 relays and if **o10=1**) and sound alarm.

The alarm can be silenced, but the alarm icon will not disappear until:

- The controller is switched off and then on again.
- Defrost without error is started in probe **S2**.

If the 2nd evaporator probe (**I20=8**) has been enabled, it will behave in the same way, but displaying the message **E3**.

Open door alarm



The door has been open for a longer time than defined in parameter **A12**, the open door alarm is activated.

In order to detect the open door, configuration is required of one of the digital inputs as "door contact" (**I10** or **I20=1**).

Activates alarm relay (only if **o10=1**) and sound alarm.

HACCP alarm



The alarm is activated should situations be detected which could endanger the integrity of the products stored in the cold room. If the temperature of the cold room is higher than that defined in parameter **h1** for a length of time exceeding that defined in parameter **h2**, the alarm activates, displaying the message **HCP** on screen.

Upon pressing the mute key, the sound alarm switches off, but the alarm remains.

Once the temperature drops below parameter **h1**, if the mute key has been pressed, the alarm disappears. If the mute key has not been pressed, the audible alarm deactivates but the HACCP indicator remains in flashing mode, indicating that a non-confirmed HACCP alarm has occurred.

Press the mute key to confirm an HACCP alarm.

If, during a power failure, a HACCP alarm occurs, when the power supply returns, the HACCP alarm is activated and the display shows the messages **HCP** and **PF** (power failure) alternately.

Alarm delays

These delays prevent certain alarms from being shown, to allow the installation to recover its normal operation after certain events.

- Delays in start-up (A3): This delays the activation of the temperature alarms upon receiving power (at start-up or after a power supply failure) or when exiting Stand-by mode. This allows for the installation to start up avoiding alarms.
- Delay after a defrost (A4): This delays the activation of the temperature alarms when a defrost completes.
- Delay to minimum and maximum temperature alarm (A5): This delays the activation of the maximum (A1) and minimum (A2) temperature alarms, from when the temperature in probe 1 reaches the programmed value.
- Delay to activation of external alarm (A6): This delays the activation of the external alarm, from when the digital input becomes active.
- Delay to deactivation of external alarm (A7): This delays the deactivation of the external alarm, from when the digital input becomes active.
- Delay to open door alarm (A12): This delays the activation of the alarm upon detecting that the door is open.

Configuration of alarm relay (only devices with 5 relays)

Should relay AUX 2 have been configured as an alarm (**o10=1**), parameter **A9** allows for the relay status to be defined when an alarm is triggered:

- **A9=0** Relay active (ON) in the event of an alarm (OFF without alarm)
- **A9=1** Relay inactive (OFF) in the event of an alarm (ON without alarm)

9.7 Alerts

The device alerts the user through an on-screen message when an event occurs which requires his/her attention. However, it does not activate the sound alarm or the alarm relay (if active).

Defrost finished by time alarm



The message **Adt** is displayed when a defrost has completed due to time-out, if parameter **A8=1**.

Pump down malfunction error (stop)



The message **Pd** is displayed if a malfunction is detected when the refrigeration system is stopped using the pump down action. (See page 11).

Pump down malfunction error (start-up)



Displays the **LP** message if a malfunction is detected when the refrigeration cycle is started up using the pump down action. (See page 11).

9.8 Light control

Relay AUX 1 or AUX 2 must be configured as "Light" (**o00** or **o10=2**).

Switching the lights on or off is controlled using:

The push-button: One press switches the lights on or off.

The cold room door: When the door is opened, the lights remain on for the time defined by parameter **b01**. If the value is 0, when the door closes the lights go out. (One of the digital inputs must be configured as door contact (**i10** or **i20=1**).

The control even occurs with the equipment in Stand-by.

9.9 Password



It allows protecting the configuration of the unit using a 2 digit code (from 01 to 99). If it is active a code is requested when you try to access the programming menu. This menu cannot be accessed if a wrong value is entered. The code is set via the **PAS** parameter. Parameter **b10** defines the operation of this code.

9.10 Remote Stand-by mode

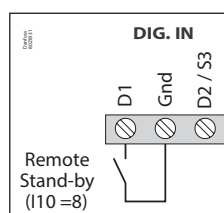

This allows activating Stand-by mode using a switch connected to one of the digital inputs. Said digital input must be set to Stand-by remote activation (**i10=8** or **i20=12**).

9.11 Operation of the auxiliary relays

Depending on the controller model, it may have 1 or 2 auxiliary relays. The function of these relays is configurable through the parameters menu.

AUX 1 relay

- **Deactivated** (**o00=0**): It does not carry out any function.
- **Compressors / crankcase resistor** (**o00=1**): Controls compressor operation. When the compressor is not in operation, it powers the crankcase resistor. This function can only be selected via the initial wizard (Ini).
- **Light** (**o00=2**): This regulates the operation of cold room light.
- **Virtual control** (**o00=3**): The relay can be remotely activated and deactivated by Modbus

AUX 2 relay

- **Deactivated (o10=0):** It does not carry out any function.
- **Alarm (o10=1):** This activates the relay every time that an alarm occurs
- **Light (o10=2):** This regulates the operation of cold room light
- **Virtual control (o00=3):** The relay can be remotely activated and deactivated by Modbus
- **Door frame resistor (o10=4):** This controls the operation of the cold room's door frame resistor.

- **Defrost 2° evaporator (o10=5):** This controls the defrost resistors of a second evaporator.
- **Same as solenoid status (o10=6):** Imitates solenoid status: active if the solenoid is in ON mode, inactive if the solenoid is in OFF mode.
- **Same as unit status (o10=7):** Indicates the unit's status: active if the unit is in ON mode, inactive if the unit is in Stand-by mode.
- **Drainage resistor (o10=8):** Controls the activation/deactivation of the evaporator drainage resistor (see page 14).

10. Configuration

Condensed programming menu

This allows for the most-used parameters to be quickly configured. Press the **SET** key for 3 seconds to access it.

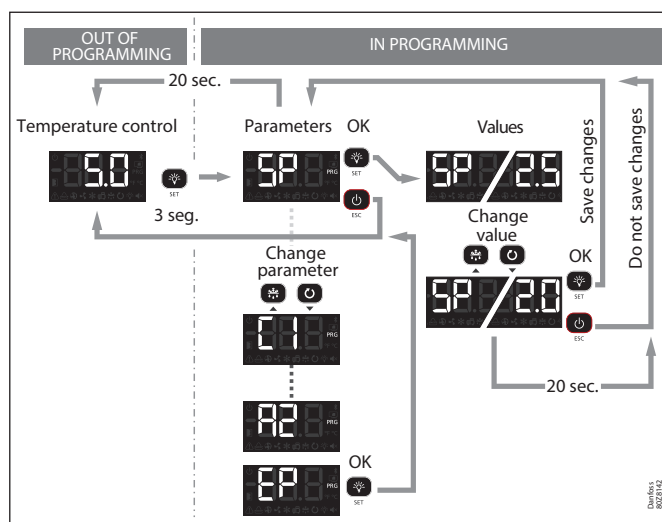

Parameters

Level 2	Description	Values	Min.	Def.	Max.
SP	Temperature setting (Set Point)	°C/°F	-50	0.0	99
CE	ADAPTIVE Mode (0=Deactivated; 1= Activated)		0	1	1
C1	Probe 1 differential (Hysteresis)	°C/°F	0.1	2.0	20.0
d0	Defrost frequency (Time between 2 starts)	H.	0	6	96
d1	Maximum defrost duration (0=defrost deactivated)	Min.	0	*	255
d4	Final defrost temperature (by probe) (If P4 ≠ 1)	°C/°F	-50	8.0	50
F3	Status of the fans during the defrost (0=Shut down; 1=Running)		0	0	1
A1	Alarm for maximum in probe 1 (It should be higher than the SP)	°C/°F	A2	99	99
A2	Alarm for minimum in probe 1 (It should be lower than the SP)	°C/°F	-50	-50	A1
d30	Defrost strategy in ADAPTIVE mode		0	5	10

Extended programming menu

Use the extended programming menu to configure all of the unit's parameters in order to adapt it to your installation requirements. Press the **SET** key for 6 seconds to access it.

Important:

- If the password function has been configured as a keypad lock (b10=2), or as an access to parameters block (b10=1), you will be requested to enter the password programmed in **PAS** when attempting to access either of the two functions. If the entered password is not correct, the unit will go back to showing the temperature.
- Certain parameters or menus may not be visible depending on the configuration of the rest of the parameters.

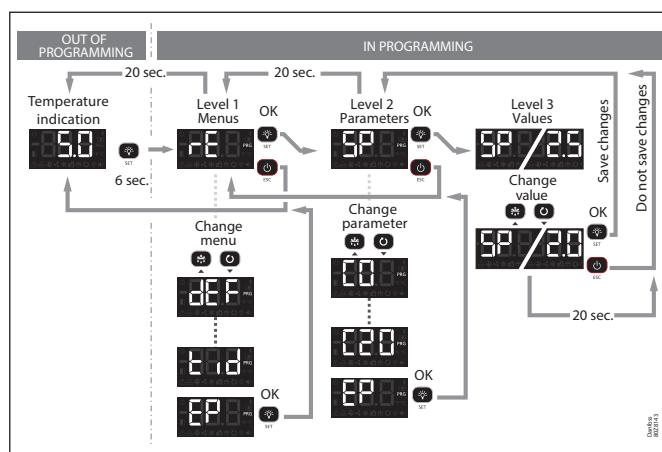

Regulation and control

Level 1	Level 2	Description	Values	Min.	Def.	Max.
rE	SP	Temperature setting (Set Point)	°C/°F	-50	0.0	99
	CE	ADAPTIVE Mode: 0 =Deactivated, 1 = Activated		0	1	1
	C0	Probe 1 & 2 calibration (Offset)	°C/°F	-4.0	0.0	4.0
	C1	Probe 1 differential (Hysteresis)	°C/°F	0.1	2.0	20.0
	C2	Set Point top locking (it cannot be set above this value)	°C/°F	C3	99	99
	C3	Set Point bottom locking (it cannot be set below this value)	°C/°F	-50	-50	C2
	C4	Type of delay for the protection of the compressor: 0 =Minimum time of compressor in OFF 1 =Minimum time of compressor in OFF and in ON in each cycle		0	0	1
	C5	Protection delay time (value of the option selected in parameter C4)	Min.	0	0	120
	C6	COOL relay status with fault in probe 1: 0 =OFF; 1 =ON; 2 =Average according to last 24 h prior to probe error 3 =ON-OFF according to prog. C7 and C8		0	2	3
	C7	Relay time in ON in the event of probe 1 failure (If C7=0 and C8≠0, the relay will always be disconnected in OFF)	Min.	0	10	120
	C8	Relay time in OFF in the event of probe 1 failure (If C8=0 and C7≠0, the relay will always be connected in ON)	Min.	0	5	120
	C9	Maximum duration of the continuous cycle mode (0 =deactivated)	H.	0	0	48
	C10	Variation of the Set Point (SP) in continuous cycle mode. When it reaches this point (SP+C10), it reverts to the normal mode. (SP+C10 ≥ C3). The value of this parameter is always negative, unless it is 0. (0 =OFF)	°C/°F	0	-50	C3-SP
	C12	Variation of the Set Point (SP) when the change Set Point function is active. (SP+C12 ≤ C2) (0 = deactivated)	°C/°F	C3-SP	0.0	C2-SP
	C19	Maximum start time from Pump Down (Values between 1 and 9 seconds will not be accepted) (0 =deactivated)	Sec.	0	0	120
	C20	Maximum time for pump down (0 = deactivated)	Min.	0	0	15
	C21	Probe to be displayed: 0 =All probes (sequential), 1 =Probe 1 (Cold Room), 2 =Probe 2 (Evaporator), 3 =Probe 3 (According to I20), 4 =Weighted temperature of the cold room		0	1	3
	C22	Stop fans and compressor on opening door 0 =No, 1 =Yes		0	0	1
	C23	Start-up delay for fans and compressor with door open	Min.	0	0	999
	C24	Delay time of cold stop with door open.	Seg.	0	0	C23
C25	Influence of probe S3 when regulating with two temperature probes (I20 =10)	%	0	0	95	
C27	Probe 3 calibration (Offset)	°C/°F	-4.0	0.0	4.0	
EP	Exit to level 1					

Defrost

Level 1	Level 2	Description	Values	Min.	Def.	Max.
dEF	d0	Defrost frequency (Time between 2 starts)	H.	0	6	96
	d1	Maximum defrost duration (0 =defrost deactivated)	Min.	0	*	255
	d2	Type of message during the defrost: 0 =Displays the real temperature; 1 =Displays the temperature at the start of the defrost; 2 =Displays the dEF message		0	2	2
	d3	Maximum duration of the message (Time added at the end of the defrost process)	Min.	0	5	255
	d4	Final defrost temperature (by probe) (If I00 ≠ 1)	°C/°F	-50	8.0	50
	d5	Defrost on connecting the unit: 0 =NO First defrost according to d0; 1 =YES, First defrost according to d6		0	0	1
	d6	Delay of the defrost start on connecting the unit	Min.	0	0	255
	d7 ¹⁾	Type of defrost: 0 =Resistors; 1 =Air/fans, 2 =Hot gas; 3 =Reversal of cycle		0	*	3

* According to wizard.

¹⁾ It can only be modified using the configuration wizard (InI).

dEF	d8	Count of time between defrost periods: 0 =Total real time, 1 =Sum of compressor connected time		0	0	1
	d9	Drip time when completing defrost (Shutdown of compressor and fans)	Min.	0	1	255
	d30	Defrost strategy in ADAPTIVE mode		0	5	10
	d31	Maximum time without defrosting (0 =Deactivated)	H.	0	96	999
	d32	Maximum time of cold room outside the temperature regulation range (0 =Deactivated)	H.	0	2	10
	EP	Exit to level 1				

Evaporator fans

Level 1	Level 2	Description	Values	Min.	Def.	Max.
FAan	F0	Fan stop due to high evaporator temperature (during normal operation)	°C/°F	-50	45	50
	F1	Probe 2 differential if fans are shut down	°C/°F	0.1	2.0	20
	F2	Status of fans during compressor off cycle, 0 =shut down, 1 = running, 2 =cycling		0	0	1
	F3	Status of the fans during the defrost: 0 =Shut down, 1 =Running		0	0	1
	F4	Delay of start-up after defrost (If F3=0) It will only actuate if it is higher than d9	Min.	0	2	99
	F5	Fan stop evaporator temperature (during fan cycling)	°C/°F	-50	50	50
	F6	Fan ON cycle	Min.	0	2	15
	F7	Fan OFF cycle	Min.	0	2	15
EP	Exit to level 1					

Alarms

Level 1	Level 2	Description	Values	Min.	Def.	Max.
AL	A0	Configuration of the temperature alarms: 0 =Relative to SP, 1 =Absolute		0	1	1
	A1	Alarm for maximum in probe 1 (It should be higher than the SP)	°C/°F	A2	99	99
	A2	Alarm for minimum in probe 1 (It should be lower than the SP)	°C/°F	-50	-50	A1
	A3	Delay of temperature alarms in the start-up	Min.	0	0	120
	A4	Delay of temperature alarms from the end of a defrost	Min.	0	0	99
	A5	Delay of temperature alarms from when the A1 or A2 value is reached		0	30	99
	A6	Delay of the external alarm/Severe external alarm on receiving a signal in digital input (I10 or I20 = 2 or 3)	Min.	0	0	120
	A7	Delay of external alarm deactivation/Severe external alarm deactivation when the signal in digital input disappears (I10 or I20 = 2 or 3)	Min.	0	0	120
	A8	Show warning if the defrost ends for maximum time: 0 =No, 1 =Yes		0	0	1
	A9	Relay alarm polarity 0 = Relay ON in alarm (OFF without alarm); 1 = Relay OFF in alarm (ON without alarm)		0	0	1
	A10	Differential of temperature alarms (A1 and A2)	°C/°F	0.1	1.0	20.0
	A12	Delay of open door alarm (If I10 or I20 =1)	Min.	0	10	120
EP	Exit to level 1					

Basic configuration

Level 1	Level 2	Description	Values	Min.	Def.	Max.
bcn	b00	Delay of all functions on receiving power supply	Min.	0	0	255
	b01	Cold room light timing	Min.	0	0	999
	b10	Function of password 0 =Inactive, 1 =Block access to parameters, 2 =Block keypad		0	0	2
	PAS	Access code (Password)		0	0	99
	b20	MODBUS address		0	0	247
	b21	Communication speed: 0 =9600 bps, 1 =19200 bps, 2 =38400 bps, 3 =57600 bps	bps	0	2	3
	b22	Acoustic alarm enabled: 0 = No, 1 =Yes		0	1	1
	b30	Activation of manual calibration: 0 =Deactivated, 1 =Activated Requires security code, see page 8.		0	0	1
	Unt	Work units: 0 =°C, 1 =°F		0	1	1
	EP	Exit to level 1				

Inputs and outputs

Level 1	Level 2	Description	Values	Min.	Def.	Max.
In0	I00	Connected probes 1 =Probe 1 (Cold room), 2 =Probe 1 (Cold room) + Probe 2 (Evaporator)		1	2	2
	I10 ¹⁾	Configuration of digital input 1 0 = Deactivated, 1 =Door contact, 2 =External alarm, 3 =Severe external alarm, 4 =Change of SP, 5 =Remote defrost, 6 =Defrost block, 7 = Low pressure switch, 8 =Remote Stand-by		0	*	8
	I11	Polarity of the digital input 1 0 =Activates on closing contact; 1 =Activates on opening contact		0	*	1
	I20	Configuration of digital input 2 0 = Deactivated, 1 =Door contact, 2 =External alarm, 3 =Severe external alarm, 4 =Change of SP, 5 =Remote defrost, 6 =Defrost block, 7 =Register probe, 8 =Probe 2° evaporator ²⁾ , 9 =High pressure switch for Hot Gas, 10 =2nd cold room temperature probe, 11 =Product temperature, 12 =Remote Stand-by		0	0	12
	I21	Polarity of the digital input 2 0 =Activates on closing contact; 1 =Activates on opening contact		0	0	1
	o00 ¹⁾	Configuration of relay AUX1 0 =Deactivated, 1 =Compressor/Resistor sump, 2 =Light, 3 =Virtual control		0	*	3
	o10	Configuration of relay AUX2 0 =Deactivated, 1 =Alarm, 2 =Light, 3 =Virtual control, 4 =Door frame resistance, 5 =Defrost 2° evaporator, 6 =Same as solenoid status, 7 =Same as unit status, 8 =Drainage resistor		0	2	8
	EP	Exit to level 1				

* According to wizard.

¹⁾ It can only be modified using the configuration wizard (InI).

²⁾ Option not available in AK-RC 305W-SD

HACCP alarm

Level 1	Level 2	Description	Values	Min.	Def.	Max.
HCP	h1	Maximum temperature of HACCP alarm	°C/°F	-50	99	99
	h2	Maximum permitted time for activation of the HACCP alarm (0 =Disabled)	H.	0	0	255
	EP	Exit to level 1				

Information (reading only)

Level 1	Level 2	Description	Values	Min.	Def.	Max.
tid	InI	Option chosen in the configuration wizard				
	Pd ¹⁾	Pump down active? 0 =No, 1 =Yes				
	PU	Program version				
	Pr	Program revision				
	bU	Bootloader version				
	br	Bootloader revision				
	PAr	Parameter map revision				
	EP	Exit to level 1				

¹⁾ It can only be modified using the configuration wizard (InI).

11. Troubleshooting

Errors during calibration

The error message is displayed alternately with the CAL message. The icon flashes.

Error	Description	Solution
E1/E2/E3	Probe error 1 / 2 / 3	Check condition and wiring of affected probe.
E10	Evaporator defrost error	Check defrost operation, it must end by temperature (d4).
E20	Idem for E10 but relating to the second evaporator	
E11	Similar temperature in probes S1 and S2	Check position of both probes following recommendations on page 3.
E20	Idem for E11 but relating to probe S3	
E12	It has not been possible to carry out the calibration due to a lack of stability in the system	Avoid opening cold room door during calibration. Check main components of the refrigeration circuit, in particular the aspiration part.
E22	Idem for E12 but relating to the second evaporator	
E17	Excessive door openings have been detected during calibration and it has not been possible to calibrate.	Avoid opening cold room door during calibration.

Errors during operation

The error message is displayed alternately with the temprature. The icon flashes.

Error	Description	Solution
E1/E2/E3	Probe error 1 / 2 / 3	Check condition and wiring of affected probe.
E13	Similar temperature in probes S1 and S2	Check position of both probes following recommendations on page 3.
E23	Idem for E11 but relating to probe S3	
E14	A lack of stability has been detected in the system	Check main components of the refrigeration circuit, in particular the aspiration part.
E24	Idem for E14 but relating to the second evaporator	
E15	Persistent lack of system stability has led to deactivation of the ADAPTIVE mode	Check main components of the refrigeration circuit, in particular the aspiration part and the position of probe 2 or 3. To return to the ADAPTIVE mode restart the device.
E25	Idem for E15 but relating to the second evaporator	
E16	Configuration has been changed from 1 to 2 evaporators or vice versa.	If the configuration change is correct, start a manual calibration.
E18	Excessive door openings have been detected and the device cannot regulate in ADAPTIVE mode.	Check that the door has not been left open or that it does not open more than necessary.

12. Technical specifications

Features	Specifications	
Power supply	100 – 240 V~ 50/60 Hz	
Maximum input power in the operation	6.3 VA	
Maximum nominal current	15 A	
Relay SSV / DEFROST - SPDT - 20 A	NO	EN60730-1: 15 (15) A 250 V~
	NC	EN60730-1: 15 (13) A 250 V~
Relay FAN - SPST - 16 A	EN60730-1: 12 (9) A 250 V~	
Relay COOL - SPST - 16 A	EN60730-1: 12 (9) A 250 V~	
Relay AUX 1 - SPDT - 20 A	NO	EN60730-1: 15 (15) A 250 V~
	NC	EN60730-1: 15 (13) A 250 V~
Relay AUX 2 - SPDT - 16 A	NO	EN60730-1: 12 (9) A 250 V~
	NC	EN60730-1: 10 (8) A 250 V~
No. of relay operations	EN60730-1:100.000 operations	
Probe temperature range	-50.0 – +99.9 °C	
Resolution, setting and differential	0.1 °C	
Thermometric precision	±1 °C	
Loading tolerance of the NTC probe at 25 °C	±0.4 °C	
Working ambient temperature	-10 – +50 °C	
Storage ambient temperature	-30 – +60 °C	
Protection degree	IP 65	
Installation category	II s/ EN 60730-1	
Pollution degree	II s/ EN 60730-1	
Control device classification	Built-in assembly, with Type 1.B automatic operation action feature, for use in clean situations, logical support (Software) class A and continuous operation. Degree of contamination 2 acc. to UNE-EN 60730-1. Double isolation between power supply, secondary circuit and relay output.	
Temperature during ball-pressure test	Accessible parts: 75 °C Parts which position active elements: 125 °C	
Current of radio jamming suppression tests	270 mA	
Voltage and current as per EMC tests	207 V, 17 mA	
Type of assembly	Fixed internal	
MODBUS address	Shown on label	
Dimensions	290 mm (W) x 141 mm (H) x 84.4 mm (D)	
Internal buzzer	Yes	

13. Ordering

Controller

Model	Description	Comments	Code no.
AK-RC 305W-SD	AK-RC 305W-SD Gen. 2,5 O/P, Single phase	Include: 2 x 1.5 m, NTC 10K sensor	080Z5003

Accessory (for spares and replacement purposes):

Name	Features	Qty	Code no.
NTC sensors	10K, High Prec. 1.5 m	1	080Z3216

Danfoss A/S

Climate Solutions • danfoss.com • +45 7488 2222

Any information, including, but not limited to information on selection of product, its application or use, product design, weight, dimensions, capacity or any other technical data in product manuals, catalogues descriptions, advertisements, etc. and whether made available in writing, orally, electronically, online or via download, shall be considered informative, and is only binding if and to the extent, explicit reference is made in a quotation or order confirmation. Danfoss cannot accept any responsibility for possible errors in catalogues, brochures, videos and other material. Danfoss reserves the right to alter its products without notice. This also applies to products ordered but not delivered provided that such alterations can be made without changes to form, fit or function of the product.

All trademarks in this material are property of Danfoss A/S or Danfoss group companies. Danfoss and the Danfoss logo are trademarks of Danfoss A/S. All rights reserved.