

ENGINEERING
TOMORROW



User Guide

Heavy duty filter

EC-LCL1200B-350

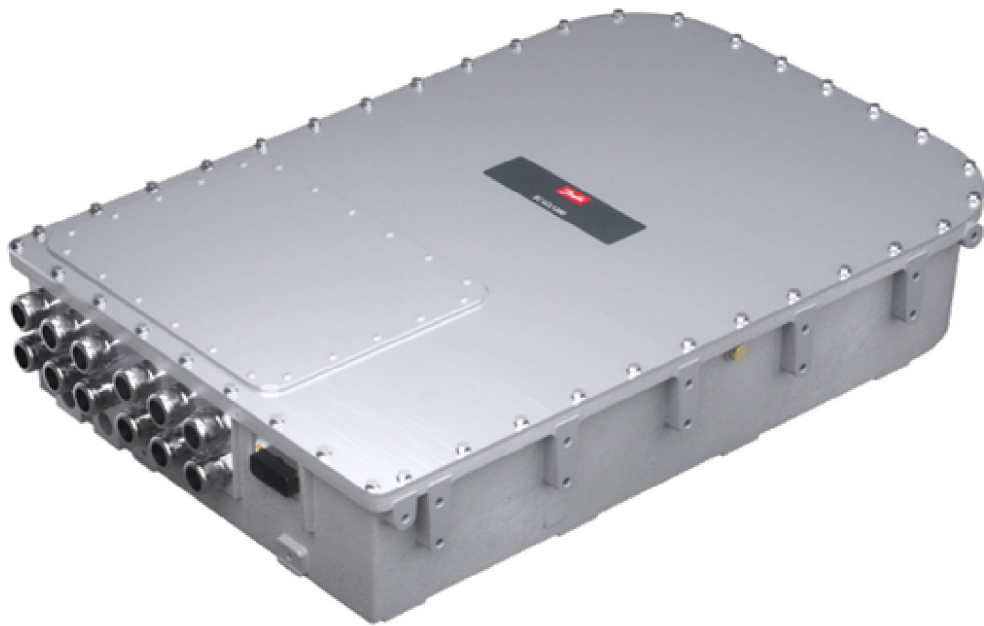

Revision history

Table of revisions

Date	Changed	Rev
September 2024	First edition	0101

Contents

General information

Intended use of the user guide.....	5
Product naming convention.....	5
Conformity according to standards.....	5
Warranty.....	6
Terms and abbreviations.....	6
Responsibility of the manufacturer.....	7

Safety information

General safety statement.....	8
Safety message signal words.....	8
Safety symbols.....	8
Personal protective equipment.....	9
Safety features.....	10
Electromagnetic compatibility (EMC).....	10
Installation safety.....	10
Operation safety.....	12

Product overview

Intended use of the electric device.....	15
System introduction.....	16
Cooling.....	17
Rating plate.....	17
Tightening torques.....	18

Transportation and storage

Transportation.....	20
Packaging.....	20
Receiving and unpacking.....	20
Lifting.....	20
Handling.....	23
Storage.....	23

Installation

Required tools.....	25
Insulation resistance test.....	25
Mechanical installation.....	27
Allowed mounting position.....	27
Installation procedure.....	29
Cooling connections.....	31
Recommended coolants.....	32
Electrical installation.....	32
Electrical connections.....	32
Grounding.....	33
Cable gland assembly and power line connection.....	35
Cabling and wiring.....	43
High voltage connections.....	44
Low voltage connections.....	44

Operation

Operation conditions.....	48
Condition monitoring during operation.....	48

Maintenance

Regular maintenance.....	49
Cooling system maintenance.....	50
Cleaning.....	50

Dismounting and disposal of the electric device

Troubleshooting

Aftersales

Contents

Service policy.....56

General information

Intended use of the user guide

This user guide contains the installation, operation and maintenance instructions for the EC-LCL1200B-350 liquid cooled heavy duty LCL-filter.

This user guide contains instructions necessary to safely and properly handle, install and maintain the electric device. They should be brought to the attention of anyone who installs or maintains the electric device or associated equipment.

All of the safety warnings and instructions in this user guide must be followed to prevent injury to personnel or damage to property. Only qualified and authorized personnel, familiar with health and safety requirements and national legislation, shall be permitted to handle, install and maintain the device.

This user guide must be kept for future reference during installation, operation and maintenance.

This user guide uses illustrations as examples only. Illustrations in this user guide may not necessarily reflect all system features.

Product naming convention

In this user guide, the EC-LCL filter is referred to as the electric device.

The following naming convention is used to refer to electric device type code and options:

- EC-LCL1200B-350

Part of the name	Explanation
EC	Electric Converter
LCL1200B	Type code part 1
350	Type code part 2

The rating plate of the electric device has the correct name of that particular electric device.

Options are presented in the Table below. Standard options are indicated by a star (*).

EC-LCL1200B-350 options

Variant	Code	Description	Additional information
Cable glands	*	No cable glands	No cable glands, plugs, screws, springs or washers
	+CG1	Default M25/M32 cable glands	With 3x M32 to M25 adapters and 3x M25 cable glands (3x for phases) on inverter side, 3x M32 cable glands on grid side. Unused threads plugged with 6x M32 plugs. Screws, springs and washers for cable lugs included in the delivery packed in a plastic bag. Screws 6x M8x20, TX, ISO14580 with washers and preapplied thread locker
	+CG2	Default M25/M32 cable glands	With 6x M32 to M25 adapters and 6x M25 cable glands (6x for phases) on inverter side, 6x M32 cable glands on grid side and 6x copper bushings for double connection. Screws, springs and washers for cable lugs included in the delivery packed in a plastic bag. Screws 6x M8x60, TX, ISO14583, spring disc D8, DIN 2093, 8.2x16x0.9, washer D8, DIN 125, zinked

Conformity according to standards

The electric device has been designed in accordance with the essential parts of the following directives and to meet the requirements of the standards:

General information

Applicable directives and standards

Directives / Standards	Explanation
Low Voltage Directive 2014/35/EU	The low voltage directive (LVD) (2014/35/EU) ensures that electrical equipment within certain voltage limits provides a high level of protection for European citizens, and benefits fully from the single market. It has been applicable since 20 April 2016.
EN 62477-1:2012 + A11:2014 + A1:2017 + A12:2021	Safety requirements for power electronic converter systems and equipment – Part 1: General
EN IEC 61800-3:2018	Adjustable speed electrical power drive systems - Part 3: EMC requirements and specific test methods Applicable part: Category C3 conductive EMC limits (DUT I > 100 A)

Warranty

Danfoss offers warranty against defects in workmanship and materials for its products for a period of twelve (12) months from commissioning or eighteen months (18) from delivery (Incoterms-EXW), whichever occurs first.

In order for the warranty to be valid, the customer must follow the requirements of this and all related documents, especially those set out in the product installation and maintenance documents, as well as the applicable standards and regulations in force in each country.

Defects arising from the improper or negligent use, operation, and/or installation of the equipment, non-execution of regular preventive maintenance, as well as defects resulting from external factors or equipment and components not supplied/recommended by Danfoss, will not be covered by the warranty.

The warranty will not apply if the customer at its own discretion makes repairs and/or modifications to the equipment without prior written consent from Danfoss.

Terms and abbreviations

Following symbols, terms and abbreviations may exist in this user guide.

Term/ Abbreviation	Explanation
AC	Alternating current
DC	Direct current
EMC	Electromagnetic compatibility
EMI	Electromagnetic interference
GND	Ground in electrical connections
HV	High voltage
I/O	Input / Output
LV	Low voltage
MCB	Miniature circuit breaker
RCD	Residual current device

Symbol	Variable	Unit
U_{DC}	DC link voltage	V
U_{ac}	AC output voltage	V
I_n	Rated current	A_{rms}
P_n	Rated power	kW
$f_{in/out}$	Input / Output frequency	Hz
f_{switch}	Switching frequency	kHz

General information

Symbol	Variable	Unit
I_{peak}	Overcurrent limit	A
Q_c	Rated coolant liquid flow	l/min
T_c	Rated coolant liquid input temperature	°C
T_{amb}	Rated ambient temperature	°C
R	Resistance	Ω

Responsibility of the manufacturer

Danfoss is responsible for the safety, reliability and performance of the electric device only if:

- Handling, mounting, installation, operation and maintenance are carried out by qualified and authorized service personnel.
- The installation of the system complies with the requirements of the appropriate regulations.
- The electric device is used in accordance with the instructions in this user guide.
- The electric device is installed, maintained and serviced in accordance with the instructions in this user guide.

Safety information

General safety statement

The electric device is intended for use as a component for industrial and commercial installations. The end product containing the electric device must conform with all related regulations.

The use of the electric device is prohibited in hazardous areas unless it is expressly designed for such use.

The electric device is intended for installation, use and maintenance by qualified personnel, familiar with health and safety requirements and national legislation. Ignoring these instructions may invalidate all applicable warranties.

These instructions must be followed to ensure safe and proper installation, operation and maintenance of the electric device. They should be brought to the attention of anyone who installs, operates or maintains the electric device or associated equipment.

High voltage and rotating parts can cause serious or fatal injuries. For the electric device covered by this user guide, it is important to observe safety precautions to protect personnel from possible injury.

Safety message signal words

Safety message signal words indicate the severity of a potential hazard.

DANGER Indicates an imminently hazardous situation which, if not avoided, will result in death or serious injury.





WARNING Indicates a potentially hazardous situation which, if not avoided, could result in death or serious injury.

CAUTION Indicates a potentially hazardous situation which, if not avoided, may result in minor or moderate injury. CAUTION may also alert against unsafe practices

NOTICE Indicates a potentially hazardous situation which, if not avoided, could result in property damage.

Safety symbols

The following safety and information related symbols may exist in this user guide and on the electric device.

	<p>Danger This symbol is identified by a yellow background, red octagonal band and a black STOP text. It indicates a hazardous situation that causes severe injury or death. Action indicated by this symbol may not be executed.</p>
	<p>General warning This symbol is identified by a yellow background, black triangular band, and a black exclamation point symbol. It indicates a general potentially hazardous situation.</p>
	<p>Electric shock warning The symbol is identified by a yellow background, black triangular band, and a black arrowhead symbol. It indicates dangerous electrical voltage that could cause an electric shock to a person.</p>
	<p>Burn warning The symbol is identified by a yellow background, black triangular band, and a black wavy lines- symbol. It indicates a hot device that could cause burns to a person. The symbol also indicates that the device should be placed and installed so that contact with its potentially hot surface is not possible.</p>

Safety information

	<p>Magnet warning The symbol is identified by a yellow background, black triangular band, and a black magnet symbol. It indicates strong magnetic field that could cause harm to a person or property.</p>
	<p>Poison warning The symbol is identified by a yellow background, black triangular band, and a skull and crossbones symbol. It indicates a poisonous substance that could kill or cause an injury to a person.</p>
	<p>Electric shock warning - Read the instructions in the user guide.</p>
	<p>General Information.</p>
	<p>Read the instructions in the manual.</p>

Personal protective equipment

Personal protective equipment shall be used when necessary during handling, installation and maintenance of the electric device to avoid injury.

	<p>Use eye protective equipment like safety goggles or mask when you work with the electric device. Permanent damage to the eye could be caused if bearing grease, melted nitrile rubber (radial lip seal), glycol or other fluids splash.</p>
	<p>Use hearing protective equipment when you work on the electric device. Hearing injuries can be caused by too loud noise (noise in excess of 85 dBA).</p>
	<p>Use head protective equipment like helmet when you lift the electric device! Head injuries can be caused by object impact.</p>
	<p>Use cut resistant gloves when you handle and maintain the electric device. There is a risk of cut injuries.</p>
	<p>Use protective footwear when you lift or move the electric device! Foot injuries could be caused if lifting system or lifting brackets fail.</p>

Safety information

Safety features

Protection type	Built-in	Information
Phase-loss detection	Yes	Detects loss of single grid phase
Grid detection	Yes	Detects presence of grid
Grid voltage dip detection	Yes	Detects if grid-side voltage drops below parametrized limit
Overcurrent protection	Yes	Detects overcurrent situation
Main contactor fault detection	Yes	Detects failure to control the main contactors
Power supply power good	Yes	Detects LCL control circuitry fault
Pre-charge protections	Yes	Detects short-circuit on pre-charge circuitry Stops pre-charging after parametrized waiting time

Electromagnetic compatibility (EMC)

	<p>When interfacing other equipment, connect only equipment that are specified as part of the system and that are compatible.</p>
	<p>Magnetic and electromagnetic fields generated near the current-carrying conductors and permanent magnets in electric machines represent a health danger to persons with heart pacemakers, metal implants and hearing aids. Persons with a heart pacemaker, metal implants or hearing aids must consult a doctor before they enter the following areas:</p> <ul style="list-style-type: none"> • areas in which electric equipment and parts are operated • areas in which electric equipment with permanent magnets are stored, mounted, operated or repaired <p>If necessary, perform a special electromagnetic compatibility (EMC) test on the installation.</p>

EMC stands for Electromagnetic compatibility. It is the ability of electric equipment to operate without problems within an electromagnetic environment. Likewise, the equipment must not disturb or interfere with any other product or system within its locality. This is a legal requirement for all equipment taken into service within the European Economic Area (EEA).

Our products are designed with high standards of EMC in mind. Connect the power lines and groundings along the instructions in this user guide to achieve the required level of EMI protection.

It is the responsibility of the installer to make sure that the equipment or system into which the product is incorporated complies with the EMC legislation of the country of use. Within the European Union, equipment into which this product is incorporated must comply with the EMC Directive 2014/30/EU.

Installation safety

	<p>Only trained and qualified personnel familiar with the relevant safety requirements can install the electric device. If the electric device is installed incorrectly it may lead to safety hazard.</p>
--	--

Safety information

	<p>Disconnect and isolate the electric device before you start any work on it. High voltages are present at the terminals and within the inverter. Passive discharging of the DC-link capacitor is done by the discharge resistor. Discharging below 50 Volts is completed within 8 minutes after the power is disconnected. Make sure that voltage is not present on any inverter power terminals prior you start any work on it.</p>
	<p>Make sure of correct grounding connections. Do not run the electric device without correctly attached protective earth conductor. The grounding cable must be sufficient to carry the maximum supply fault current which is normally limited by the fuses or Miniature Circuit Breaker (MCB). Suitably rated fuses or MCB should be fitted in the mains supply of the electric device, by the local legislation and recommendations.</p>
	<p>Use only correct (type and value) protective fuses with the high voltage DC-system.</p>
	<p>Do not do any work on the electric device control cables when the power is applied to the electric device or to the external control circuits.</p>
	<p>The control input functions of the electric device – for example stop/start must be secured using independent channel protection in safety critical applications. All applications where malfunction could cause injury or loss of life must be subject to a risk assessment and improve control signal protection if needed.</p>
	<p>Do not activate the automatic fault reset function on any system, where this may cause a potentially dangerous situation. Reason for every fault situation should be determined before resetting the fault.</p>
	<p>Make sure that the supply voltage corresponds to the specification of the electric device.</p>
	<p>Do not attempt to repair the electric device. In the case of suspected fault or malfunction, contact Danfoss or Danfoss authorized service center for further assistance.</p>
	<p>When you install the electric device, make sure that the cooling system and the used coolant meet the specifications of the manufacturer. Make sure that the cooling system is in use when the DC-link is powered.</p>
	<p>If the control cabling is installed close with the power cabling, make sure that minimum separation distance is 100 mm and crossings are at 90 degrees. Make sure that all terminal connections are tightened correctly by the instructions.</p>
	<p>Electric device must not be opened (excluding the connection box lid). Any attempt causes loss of warranty.</p>



Safety information

	<p>Within the European Union, all machinery in which this product is used must comply with Directive 98/37/EC, Safety of Machinery. In particular, the machine manufacturer is responsible for providing a main switch and ensuring the electrical equipment complies with EN60204-1.</p>
	<p>Use correct personal protective equipment when you are near the electric device.</p>
	<p>Read the instructions in this user guide before you start to install the electric device.</p>

Operation safety

	<p>Do not use the electric device without correctly dimensioned and operating cooling system.</p>
	<p>Maximum operation temperature must not be exceeded to avoid permanent damage to the electrical device.</p>
	<p>The requirements of this user guide and other related instructions and standards must be followed.</p>

Safety information

	<p>Do not touch the electric device during operation. The surface of the electric device can be hot.</p>
	<p>This electric device is intended for professional use as complete equipment or system and as part of a fixed installation. The electric device uses high voltages and currents, and it has large amounts of stored electrical energy. Close attention is required to system design and electrical installation to avoid hazards in either normal operation or in the event of equipment malfunction.</p>
	<p>The electric device can only be used in the applications it is intended for. The rated nominal values and operational conditions are shown in the rating plate.</p>

Product overview

The electric device is a liquid cooled heavy duty LCL-filter

The advantages and features of the electric device:

- Compact design including all filter components rated for 300 A_{RMS} and 250 kVA
- Liquid cooled with water-glycol mixture
- High enclosure class IP67, IP6K9K – sealed from moisture and dust
- Ambient temperature -40...+85°C
- Allowed coolant temperature up to +65°C
- Robust design withstanding high levels of mechanical vibration and shocks
- EN 62477-1:2012 Protective class I

Main dimensions

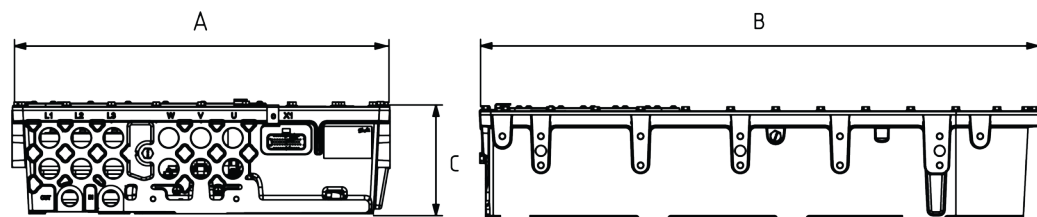

A	590 mm
B	874 mm
C	178 mm

Main components

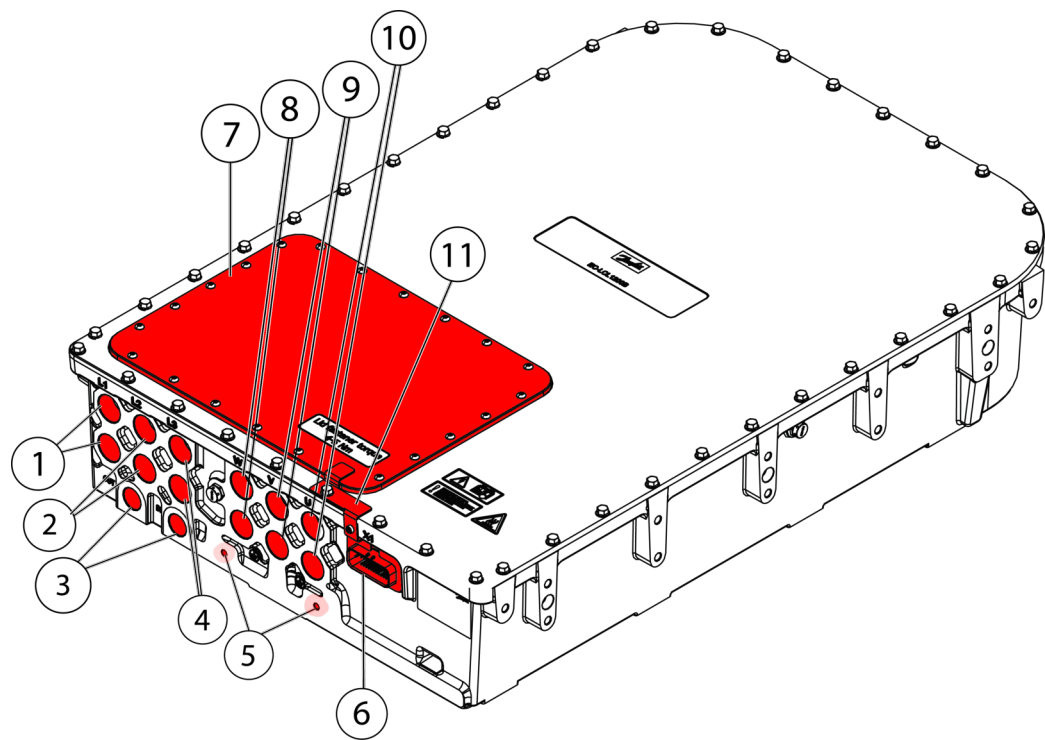

1	L1 connection M32 x 1,5 threads or cable gland (Optional)
2	L2 connection M32 x 1,5 threads or cable gland (Optional)
3	Coolant inlet/outlet G3/4; DEEP 18,5 mm

Product overview

4	L3 connection M32 x 1,5 threads or cable gland (Optional)
5	Protective Earth (PE)
6	X1 signal connector
7	Connection box cover
8	W (grid) connection M32 x 1,5 threads or cable gland (Optional)
9	V (grid) connection M32 x 1,5 threads or cable gland (Optional)
10	U (grid) connection M32 x 1,5 threads or cable gland (Optional)
11	Safety plate

System schematic

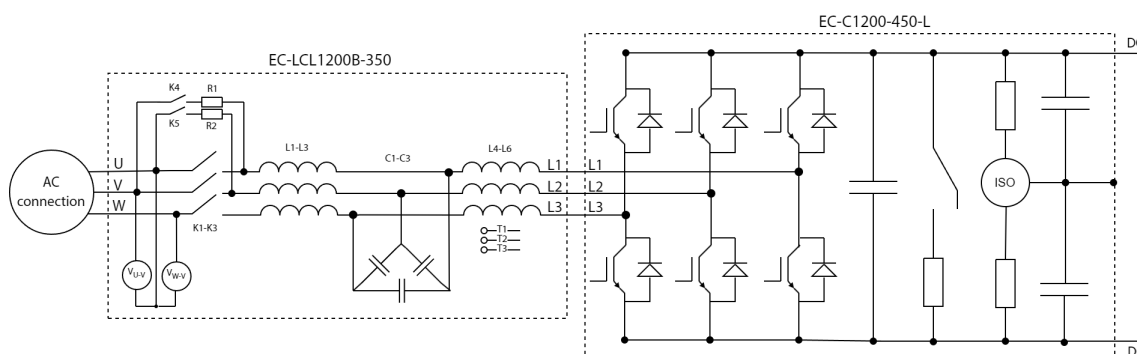

Intended use of the electric device

	<p>The electric device is intended only for professional use. Installation, operation and maintenance of the electric device is permitted only for trained personnel and professionals.</p>
	<p>The electric device is intended for fixed installation, as a part of complete power generation equipment or system.</p>

Typical applications for the electric device:

- Grid filter for Active Front End (AFE) used to convert energy from AC grid to DC grid
- Grid filter for frequency converter applications
- Grid filter for grid or generator set powered work machines

Prohibited use of the electric device

It is prohibited to use, handle, maintain and store the electric device in the following ways (including but not limited to):

- Using the electric device for other purposes than defined in the user guide.
- Disregarding the obligation to comply with the user guide, safety signs and rating plate of the electrical device.
- Using the electric device, making adjustments and maintenance without first reading the user guide.
- Exceeding the designed limits during the operation.
- Using non-original service parts of wrong material causing corrosion problems and mechanical failures in time.

Product overview

- Operating and performing maintenance on the electric device without appropriate personal protective equipment.
- Using the electric device for supporting other structures or indirect movements.
- Causing any kind of impact forces to the electric device (for example hitting or hammering or dropping objects).
- Operating the electric device with electric connections other than defined in the user guide.
- Operating the electric device with insufficiently tightened connections or cable glands.
- Operating the electric device with power cables routed against the instructions.
- Operating the electric device without properly dimensioned and operating cooling system.
- Accessing the connection box(es) of the electric device, performing maintenance or adjustment operations without securing that the electricity is disconnected and electric device is discharged as defined in the user guide.
- Lifting the electric device with additional load attached.
- Using the electric device in potentially explosive environment.
- Allowing dirt or liquid to enter into the electric device or connection box.
- Using cables that can not withstand the maximum current values of the electric device.
- Using dirty cable lugs or broken tools.
- Connecting power cables so that there is less than 10 mm air gap between the cable lug and other metallic structure (including the braid of the cable).
- Storing the electric device contrary to the guidelines presented in this user guide, for example, outdoors in wet or dusty conditions.
- Storing the electric device without proper support that prevents overturning and falling.

For product specific and up to date information see product data sheets at <https://www.danfoss.com/>.

System introduction

Danfoss provides electric drivetrains for applications in heavy mobile work machines, marine vessels and transportation vehicles. The drivetrains include all essential components for converting from traditional to hybrid electric (HEV) or electric vehicle (EV) solutions. This technology saves fuel and lowers emission and noise levels.

The electrical devices are an essential part of the electric drivetrain system. Typically they are used as a speed and torque controller for electric motors and as a current converter, converting alternating current (AC) from electric generator to direct current (DC) for energy storage.

The electric device is capable for supplying three-phase alternating current, powering and controlling electric machines, for example the EM-PMI product family electric machines.

Electric converter products are designed for controlling the flow of power in heavy-duty, marine and transportation applications.

Product overview

Overview of the drivetrain system (for reference only).

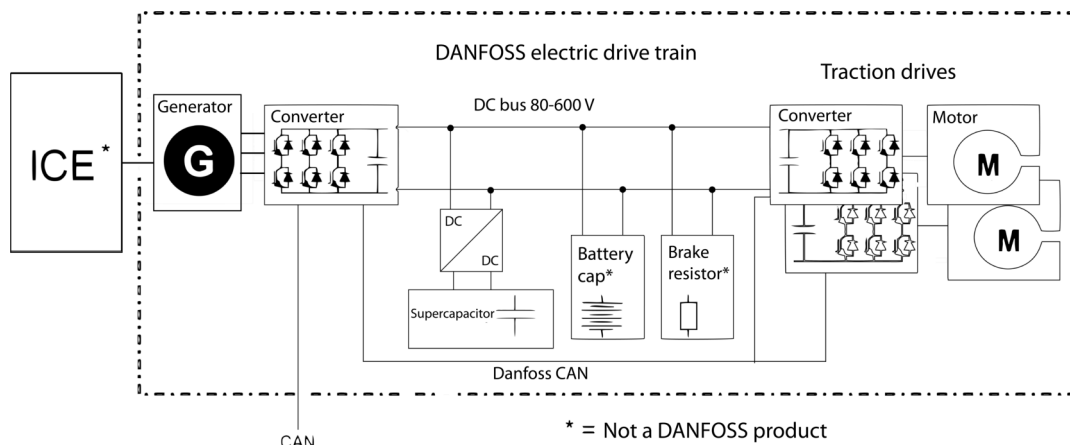

The electric device is a heavy duty LCL-filter designed as an accessory for EC-C inverters. Combined with EC-C, it can act as active front end (AFE) by taking power from grid and feeding power back to grid. If DC-link is available, it can also be used to generate a standalone microgrid from the DC-voltage.

The electric device is a heavy duty LCL-filter designed as an accessory for EC-C inverters. Combined with EC-C it can act as active front end (AFE) by taking power from grid and feeding power back to grid. If DC-link is available, it can also be used to generate standalone microgrid from the DC-voltage.

Cooling

Cooling system requirements

Cooling system properties	Specification
Cooling type	Liquid cooling
Coolant type	Water-glycol mixture (nominal 50 %, max. 52 % corrosive inhibitor).
Coolant temperature	-40°C...+65°C
Coolant flow minimum	20 l/min
Maximum operating pressure	2 bar
Pressure drop	220 mbar, 20 l/min, +20°C coolant

See detailed information and specifications from the product data sheet. Rated values can be found from the rating plate.

Rating plate

Each electric device has a rating plate (also called product label) which can be found on top of the electric device. The rating plate contains device rating and identification details. The figure below shows an example of a rating plate. For exact information, see the product-specific data sheet at <https://www.danfoss.com/> or the rating plate on the electric device.

Product overview

Rating plate example

EC-LCL				MADE IN FINLAND
EC-LCL1200B-350+CG1				
Serial No. 12345678-V123456789				
In/Out 1	In/Out 2	IP class:	IP67, IP6K9K	
n ph: 3	3	Mass:	126,5 kg	
U nom: 500 VAC	500 VAC	Tamb:	-40...85 °C	
UAC: 200-560 VAC	200-560 VAC	Tstorage:	-40...85 °C	
I nom: 300 A rms	300 A rms	Duty:	I	
f2: 45-65 Hz	45-65 Hz	Cooling:	Water/Glycol	
P nom: 250 kVA		Tc:	65 °C	
		Qc:	20 l/min	
		Max. Pressure:	2 bar	
		Manuf.: 37/2024 Danfoss A/S, 6430 Nordborg, DK		
		Danfoss Ltd., Oxford Road, Denham, UB9 4LH, UK		

Rating plate fields

Field	Explanation	Unit
1	Electric device product family	
2	Electric device full type code including possible options	
Serial No.	Serial number	
n ph	Number of phases	
U nom	Nominal voltage	V
U range	Voltage range	V
f	Frequency	Hz
I nom	Nominal current	A
P nom	Nominal power	VA
Manuf.	Manufacturing year	
Duty	Duty class	
Cooling	Cooling type	
T _c	Coolant temperature	°C
Q _c	Coolant flow	l/min
IP rating	Enclosure class according to IEC60034-5	
Mass	Total weight of the electric device	kg
T _{amb}	Ambient temperature limits	°C
T _{storage}	Storage temperature limits	°C
Max. pressure	Coolant maximum pressure	bar

The rating plate and its values shown here may not all be relevant for every electric device.

Tightening torques

For correct and safe operation, it is essential to use specified tightening torques for the electric device screws. Tightening torques (screw preloads) used in the electric device are shown in the Table below.

Product overview

	<p>Tightening torque tolerance is +/- 5% of the specified tightening torque.</p>
---	---

Tightening torques

Connection	Torque
Electric device mounting screws, M10	30 Nm
Connection box lid (power terminal cover) mounting screws	4 Nm
Cable lug mounting screws	15 Nm
Grounding cable mounting screws, M8	12 Nm
Cable gland (tighten from the frame of the gland)	15 Nm
Coolant connection	Tightening torque according to the cooling connector manufacturer specification. Maximum tightening torque 50 Nm

Transportation and storage

Transportation

	<p>Heavy electric device, handle with care. Use applicable lifting equipment for lifting and supporting the electric device during transportation and handling. Inspect the condition of the lifting equipment before attempting to start any work. Weight information can be found on the rating plate of the electric device and product data sheets.</p>
	<p>Do not apply any excess weight on the electric device during transportation.</p>
	<p>See the weight of the electric device from the product Data sheet.</p>

The electric device is shipped in first class condition. Products are inspected and packed correctly to prevent damage from ordinary handling during the transportation. Transportation conditions must be in accordance with the product specification and shocks of any kind must be avoided.

Plug and seal the cabling and cooling connections for transportation.

Packaging

Preferably, use the original packaging in which the electric device was received in for packing. If the original packaging is not available, use similar packaging.

Lift the electric device according to the instructions in this user guide when packing or unpacking.

Do not stack the electric devices.





Receiving and unpacking

Inspect the electric device and the package immediately upon arrival. Ensure that the rating plate data in the cover letter complies with the purchase order. All external damage in the package or in the electric device must be photographed and reported to Danfoss immediately.

Lifting

	<p>Use correct, adequately dimensioned lifting devices and inspect them before lifting.</p>
	<p>Do not apply any excess weight on the electric device when lifting it.</p>

Transportation and storage

	<p>Use correct lifting slings. Use correct position and angle of lifting. The maximum permissible range of lifting angles is shown in lifting figures. Make sure that lifting slings are correctly routed so that they do not cause momentum on any of the signal connectors.</p>
	<p>See the rating plate and data sheets for weight information.</p>
	<p>Lift the electric device using the correct lifting lugs/eyes only. See the lifting Figures in this Chapter.</p>
	<p>Do not go under a lifted load.</p>

Correct lifting and incorrect lifting

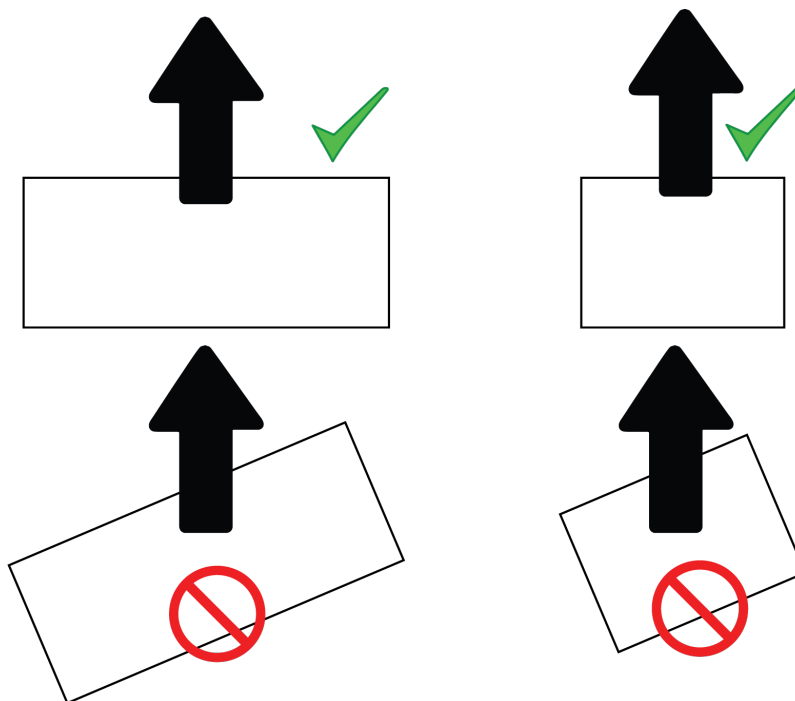

Transportation and storage

Vertical lifting, front end

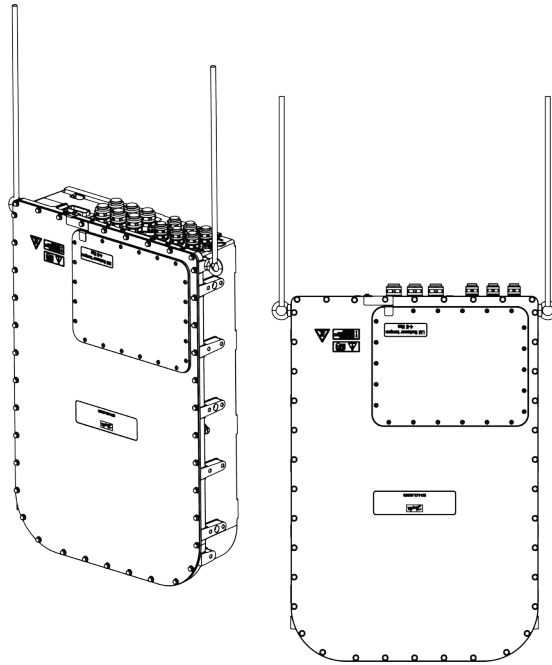

- M10 lifting eye (max. 16 mm deep), 2 pcs (not included in the delivery)

Vertical lifting, back end

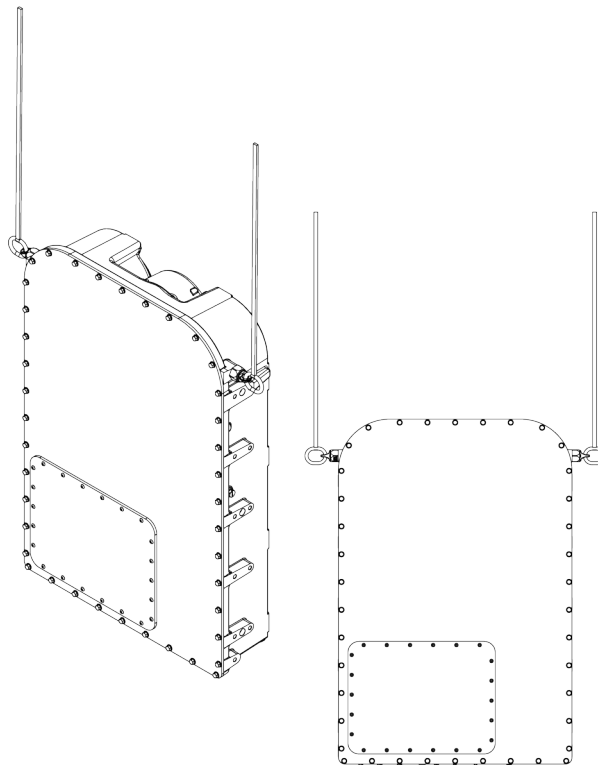

Transportation and storage

Horizontal lifting

Horizontal lifting

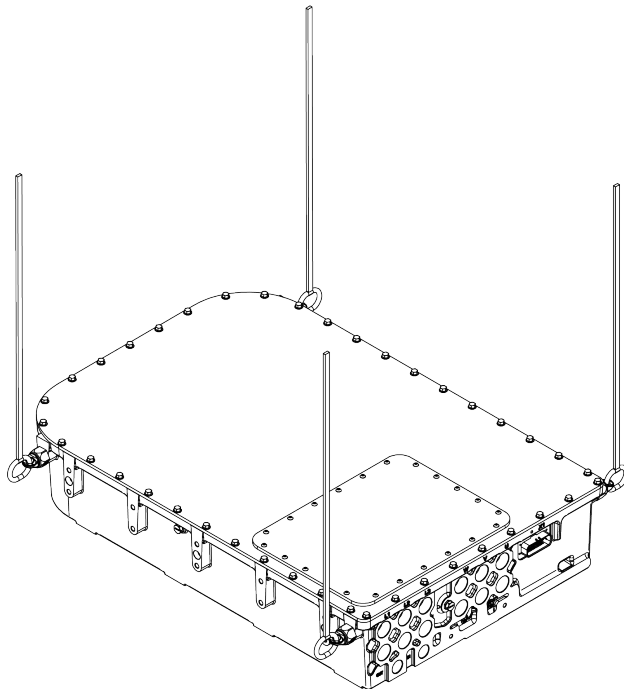

- M10 lifting eye (max. 16 mm deep), 4 pcs (not included in the delivery).

Handling

	<p>When turning or lifting the electric device, lift it in the air in order to prevent damage to the frame or other parts of the electric device.</p>
--	--

Although the electric device is designed to operate in harsh and demanding environment, any misuse or improper handling of the electric device is prohibited to avoid malfunctions later.

Storage

	<p>Heavy equipment. Store on appropriate base. Support the electric device to prevent accidental turning and falling.</p>
	<p>Do not apply any excess weight on the electric device during storage.</p>

Always store the electric device indoors. The storage temperature should preferably be above -20°C and the relative humidity less than 60 %. Storage conditions must be dry and dust free.

Make sure that the cabling and cooling connections are plugged and sealed before storage.

Transportation and storage

The electric device must not be subjected to any external vibrations during storage to avoid possible hidden structural damages.

Installation

Required tools



	Risk of electric shock during electrical installations. Use insulated tools.
---	---

To install the electric device, the following tools are required:

- Ratchet torque wrench.
- Hex head wrench kit with different metric sizes.
- Socket wrench kit with different metric sizes.
- Heavy duty cable cutter for the power cables.
- Small wire cutters for trimming the cable shield wires.
- Cable gland tightening tool. Size according to cable glands.
- Cable skinning knife.
- Crimping tool for cable lugs.

For more detailed information, see appropriate sections in this user guide and product data sheets at <https://www.danfoss.com>.

Insulation resistance test

	Before performing the insulation resistance measurement, disconnect all cables and connectors from the device under test.
	Do not touch the electric device during the test and make sure you discharge the electric device afterwards.
	Measure the insulation resistance of the electric device before and after the installation of the electric device.

Measure the insulation resistance of the electric device before and after the installation of the electric device.

The reference value 100 MΩ has to be exceeded at reference ambient temperature +25°C (measured with 500 V_{DC} / 1 min insulation resistance test). Contact Danfoss Editron service if the reference value is not exceeded.

Measuring the insulation resistance

	Insulation resistance testers generate lethal voltages. Only qualified personnel should perform insulation resistance measurements.
---	--

Installation

The insulation resistance is measured between terminals and the converter enclosure. When measuring the main circuit, the auxiliary circuits are grounded. When measuring the auxiliary circuits, the main circuit is grounded.

The following tables show test conditions and pass criteria for the EC-LCL1200B-350 heavy duty filter.

Main circuit

Test voltage	Test duration	Pass criteria
500 V _{DC}	60 s	> 100 MΩ

Measurement procedure:

1. Connect main circuits L1, L2, L3, U, V and W together.
2. Connect all pins of X1 connector to the filter enclosure.
3. Connect the measurement device ground cable to the filter enclosure.
4. Connect the measurement probe to the main circuits.

Main circuit measurement

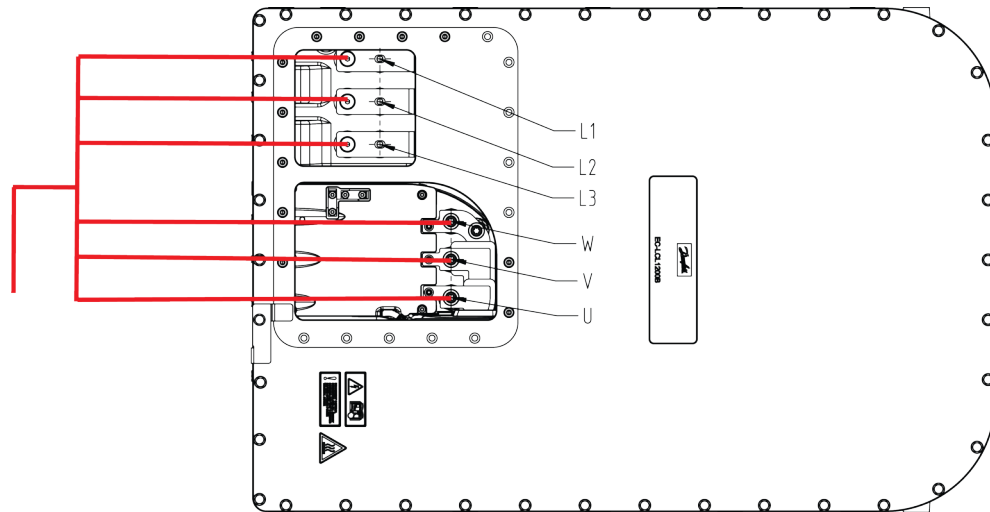

Auxiliary circuit

Test voltage	Test duration	Pass criteria
50 V _{DC}	60 s	> 10 MΩ

Measurement procedure:

1. Connect main circuits L1, L2, L3, U, V and W to the filter enclosure.
2. Connect all pins of X1 connector together, except pin 35 (enclosure ground).
3. Connect the measurement devices ground cable to the filter enclosure.
4. Connect measurement probe to X1 connector pins 1-34.

Installation

Auxiliary circuit measurement

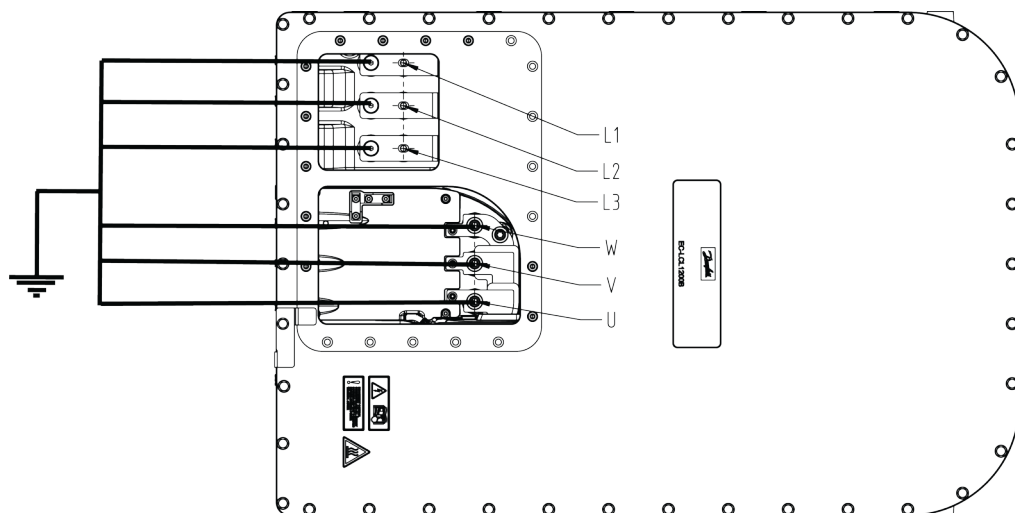

Mechanical installation

Allowed mounting position

	<p>Do not place the electric device on the ground without proper mounting or protective structure.</p>
	<p>The electric device must be mounted in a way that no other object or structure, which can cause compression, pull, torsion, rotation etc., touches the enclosure of the electric device. In addition, the electric device should not be used to support any other structure of the system.</p>

Installation

- The electric device must be mounted on a flat, heat- and flame-resistant mounting place (for example on a bracket).

Location of the mounting points

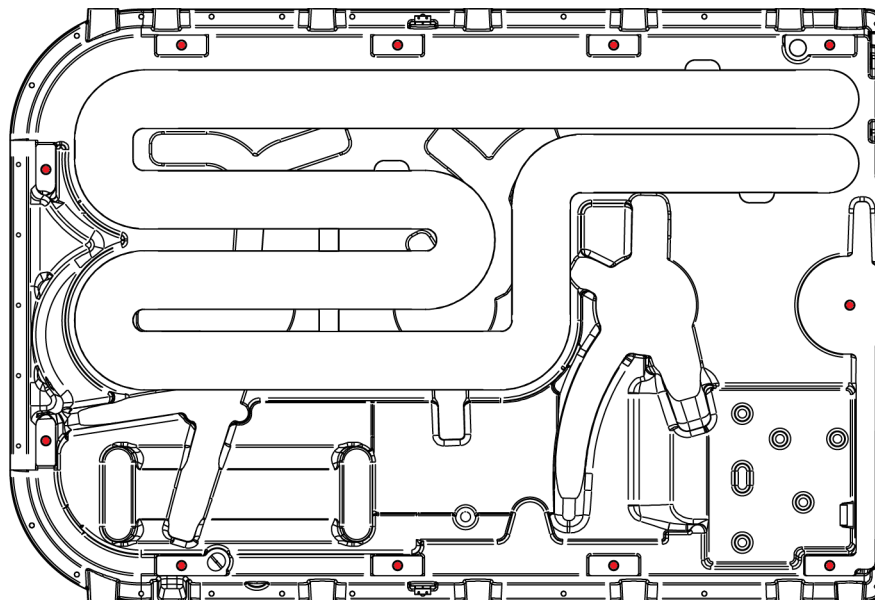

- Points for mounting M10 (15 mm deep), 11 pcs on the bottom of the electric device.

Location of mounting and lifting points

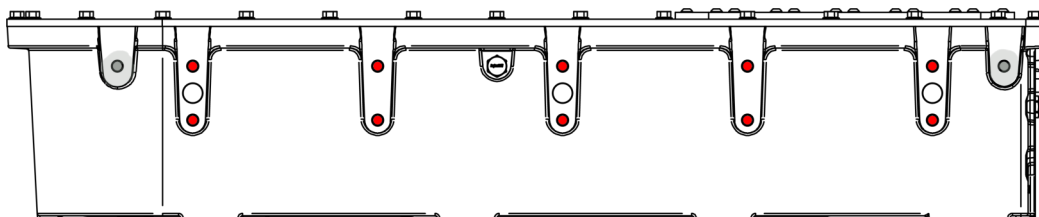

- Points for mounting (red) and lifting (gray) M10 (16 mm deep), 12 pcs on both sides.

Selected mounting position must allow the cooling system to work properly. Bleed the air away from the cooling channels to prevent air pockets.

Breather plug

Make sure that the breather plugs (2 pcs) are clean and the selected installation place and mounting direction do not allow water, dust or dirt to block them.

Installation

Location of the breather plug(s)

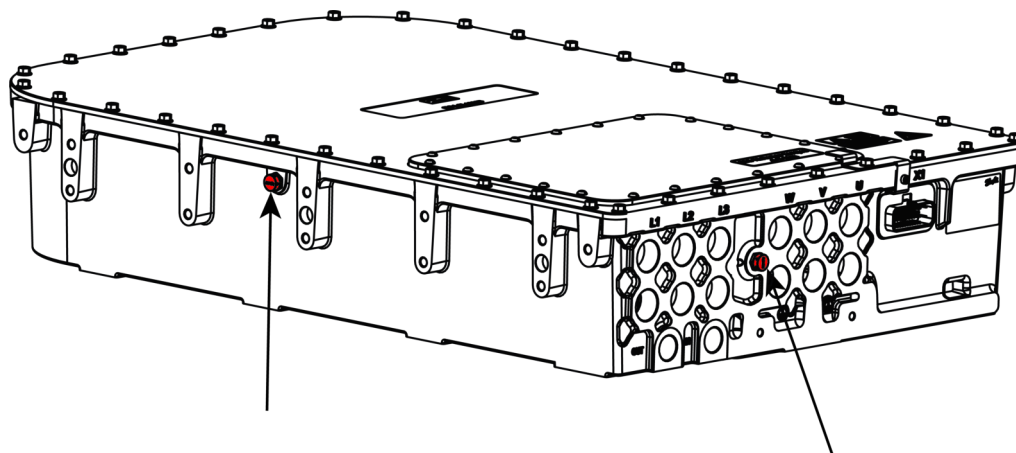

Installation procedure

	<p>Risk of electric shock when the connection box lid is open. Make sure that the electric device is discharged; measure the voltage to make sure of safety.</p>
	<p>Do not touch the exposed circuit board under the connection box lid when installing electrical connections or performing maintenance. An ESD could damage the circuitry.</p>
	<p>Heavy electric device. Handle with care. Handle the electric device correctly when you install it to the correct mounting position. See Chapter Handling on page 23.</p>
	<p>When installing the connection box lid, make sure there are no foreign particles between the connection box lid and the insulation and that all connection box fasteners are in place. Missing or loose screws can compromise the insulation.</p>
	<p>Do not use excessive force when installing and removing the X1-connector because the plastic housing of the X1-connector can break. See the Figure below for more information.</p>
	<p>Always check the compatibility of the X1-connector and the counterpart. Never alter the connector in any way.</p>

Preparations

Installation

- Make sure that the chosen installation place fulfills the environmental requirements specified for the electric device.
- Protect the electric device against corrosive gases, liquids, conductive contaminants (such as condensation, carbon dust, and metallic particles) and sprays or splashing water from all directions.
- Protect the electric device from excess humidity, salt and chemicals with suitable additional enclosure.
- The mounting place and mounting interfaces should be sufficient to carry the weight of the electric device.
- Make sure that the electric device has sufficient mounting and operating clearances for maintenance work.
- Measure the insulation resistance of the electric device before and after the installation of the electric device. For more information, see [Insulation resistance test](#) on page 25.
- Installation procedure may vary from that shown in this user guide. All steps must be included in the procedure, although the order of the steps can be different.

Installation procedure

1. Prepare the installation place and make sure that it meets the requirements for the product.
2. Lift and support the electrical device for the mounting. Refer to Chapter [Lifting](#) on page 20.
3. Install all appropriate mounting screws, do not tighten the screws until they are aligned and pre-installed. See the tightening torques from Chapter [Tightening torques](#) on page 18.
4. Connect the cooling system. See Chapter [Cooling connections](#) on page 31 or the *Main dimension drawing* for connection details. Make sure that there are no air pockets in the cooling channels and that the coolant goes freely in and out. Coolant flow direction is shown next to the coolant inlet/outlet. Make sure that the cooling system operates correctly.

Vacuum filling is recommended.

Cooling system connections

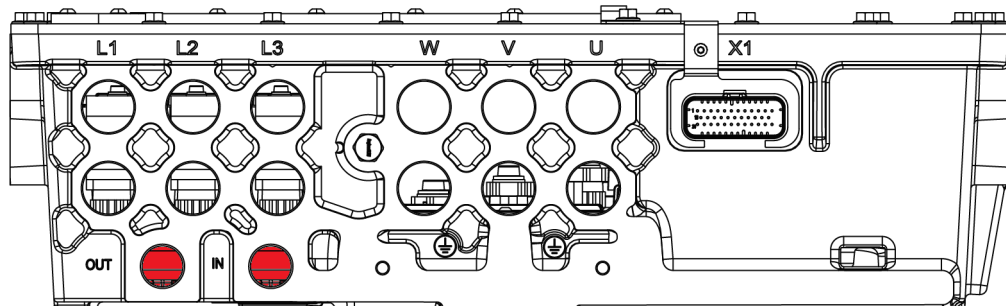

5. Make sure that the devices and machines you will connect to the electric device have no voltage.
6. Make the grounding of the frame of the electric device by direct contact between it and the metal bracket and / or from the protective earth contacts. The grounding and mounting contacts must be paint-free. See Chapter [Grounding](#) on page 33.
7. Dismount the safety plate (item 2 in the figure below).
8. Dismount the connection box lid (item 1 in the figure below).
9. Connect the power cabling. Refer to Chapter [Electrical connections](#) on page 32.
10. Install the connection box lid.
11. Mount the safety plate.

Installation

Connection box lid

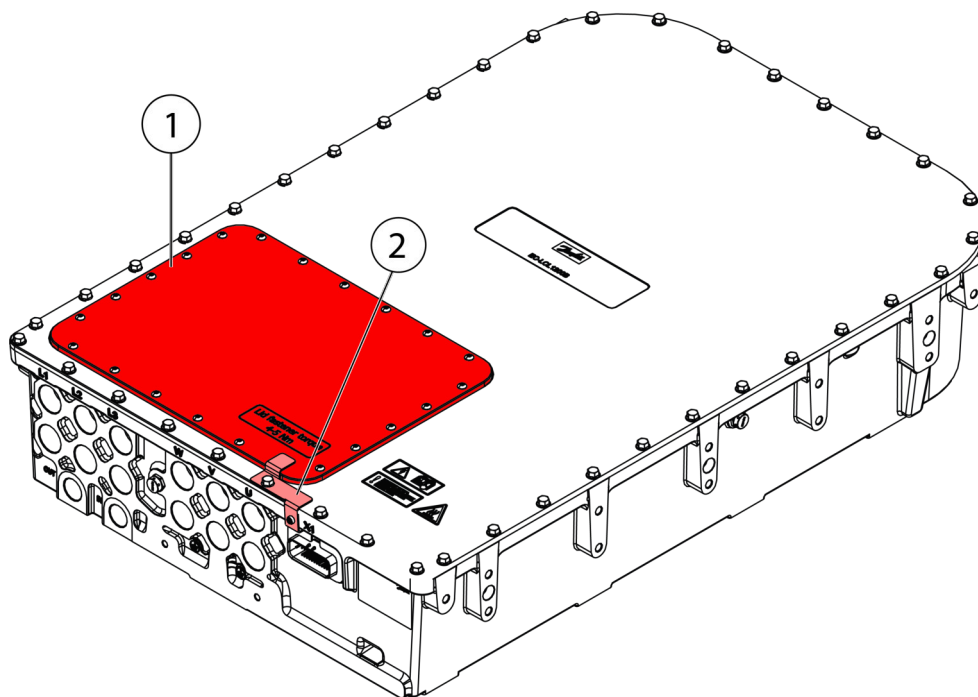

12. Connect the X1 connector (control signal connector).

X1 connector

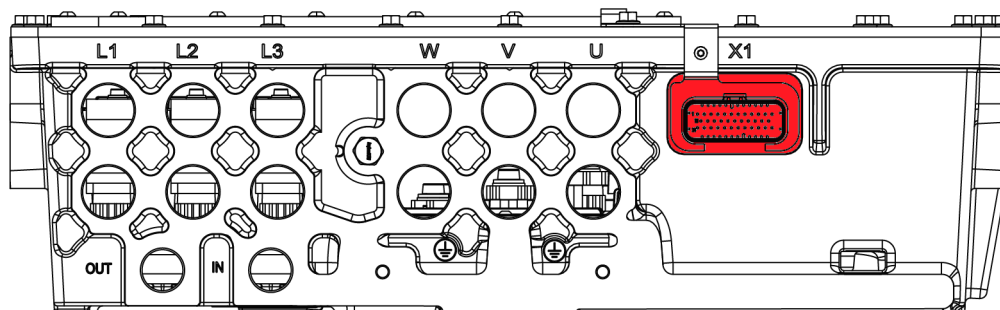

Cooling connections

	<p>Make sure that cooling liquid runs freely in and out from the electric device.</p>
	<p>When selecting cooling liquid nipples, choose nipples that can resist galvanic corrosion.</p>
	<p>To prevent damage to the cooling connectors, refer to the documentation of the manufacturer for the correct tightening torque of the cooling liquid nipples.</p>

Installation

- Connect the electric device directly to the cooling circuit.
- Make sure that the coolant flow is equal or higher than rated and the coolant temperature at the inlet of the electric device is lower or equal to the rated temperature.
- For more information, see Chapter [Recommended coolants](#) on page 32 and product data sheets. Rated values can be found on the rating plate of the electric device.
- Coolant connections: 2 x G3/4" female threads.
- It is recommended to fix the hose on the coolant connection with a hose clamp or a hose clip after the protection cap has been removed.
- Use water-glycol mixture with appropriate corrosion inhibitor as coolant.

Recommended coolants

	<p>Ethylene glycol is a toxic compound. Avoid exposure to the coolant.</p>
	<p>Handle with care. Use appropriate personal protective equipment when you handle the coolant.</p>

The electric device works correctly with water based coolant. Plain water and glycol mixture with appropriate corrosive inhibitor is acceptable, for example, plain water with 50 % glycol coolant content. Maximum allowed glycol content is 52 %. For more information, see the product data sheet.

Electrical installation

Electrical connections

	<p>Before you start the electrical installation, make sure that the frame of the electric device is grounded correctly. Refer to Chapter Grounding on page 33.</p>
	<p>Risk of electric shock is always present when operating high voltage equipment. Before working with the power connections make sure that electricity has been disconnected and the electric device has discharged.</p>
	<p>Before you start the electrical installation, make sure that the environment is dry and free from conductive dust particles.</p>
	<p>Minimum cable temperature withstand is +95°C.</p>

Installation



Cable lugs are not included in the delivery.

Electrical connections

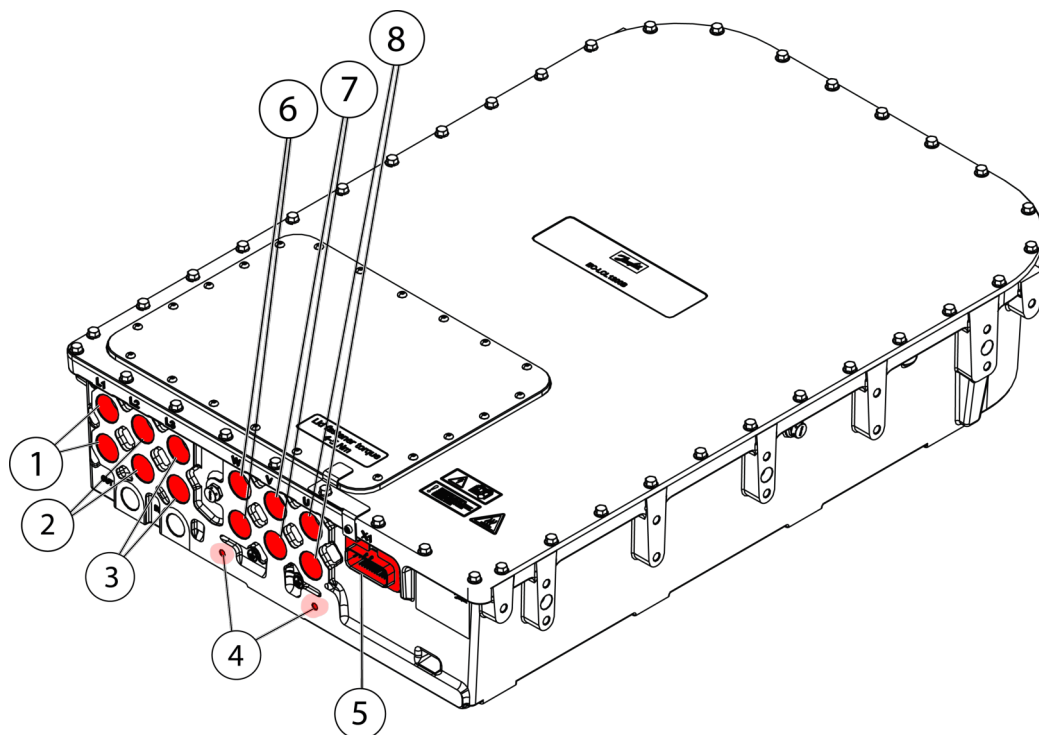

1	L1 connection M32 x 1,5 threads or cable gland (optional, check phase markings on the device)
2	L2 connection M32 x 1,5 threads or cable gland (optional, check phase markings on the device)
3	L3 connection M32 x 1,5 threads or cable gland (optional, check phase markings on the device)
4	Protective Earth (PE)
5	X1 signal connector
6	W (grid) connection M32 x 1,5 threads or cable gland (optional, check phase markings on the device)
7	V (grid) connection M32 x 1,5 threads or cable gland (optional, check phase markings on the device)
8	U (grid) connection M32 x 1,5 threads or cable gland (optional, check phase markings on the device)

Grounding

	Make sure that the electric device is correctly grounded. Do not operate the electric device without correctly attached protective earth conductor. Obey the installation instructions and the guidelines for component selection given in this user guide.
	The grounding cable must be able to carry the maximum supply fault current which normally will be limited by the fuses or the Miniature Circuit Breaker (MCB). Put correctly rated fuses or MCB in the mains supply of the electrical device: obey the local legislation and recommendations.

Installation

	<p>Obey the installation instructions and the guidelines for component selection given in this user guide.</p>
	<p>Make sure that the safety grounding is correct. Refer to Chapter Mechanical installation.</p>

Generic grounding guidelines

- Connect the ground terminal of each electric device individually to the site grounding bus bar.
- The grounding connections cannot loop from one electric device to another electric device, or to any other piece of equipment, or from any other piece of equipment.
- Ground impedance must be compliant with local industrial safety regulations.
- The protective ground of the unit must be connected to the system ground. Ground impedance must meet with the requirements of national and local industrial safety regulations and electrical requirements. The condition of the grounding connections must be checked periodically.
- Make sure that all grounding surfaces are clean and remove paint from the contact areas.
- For detailed information, see appropriate Chapters in this user guide.

Main frame

The best grounding is achieved when the main frame of each electric device is directly connected to the ground. If this is not possible, the electric device must be grounded at least from one of the safety grounding points with an appropriate grounding cable. For good functional grounding use wide flat grounding braid. Round grounding wires are adequate for safety grounding but it does not provide very good functional grounding because of its higher impedance at high frequencies. The grounding points are marked to the electric device.

Grounding point(s)

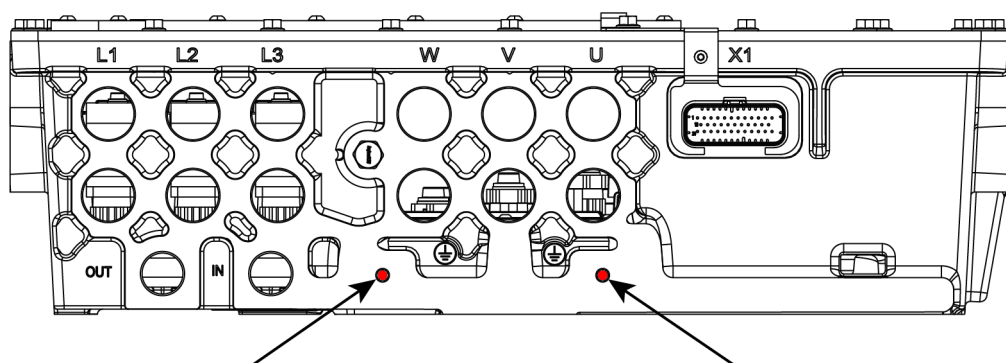

Grounding connection M8 (12 mm deep). Refer to *Main dimension drawing* if necessary.

Safety grounding points and protective earth conductor

	<p>Touch current in the protective earth conductor exceeds 3,5 mA AC and 10 mA DC.</p>
--	---

Installation

	<p>This product can cause a DC current in the PE conductor. Where a residual current-operated protective device (RCD) is used for protection against electrical shock, only an RCD of Type B is allowed on the supply side of this product.</p>
	<p>The cross sectional area of the protective earth conductor must be at least equal to that of the incoming supply conductor.</p>
	<p>Maximum fuse rating (speed and current) 500 V_{AC} 630 A gG size NH3.</p>

One of the safety groundings must be connected to an appropriate grounding point. Grounding points must comply with national and local industrial safety regulations and/or electrical codes.

Cabling and wiring

To make sure that the electric device functions correctly and to minimize the radiated emissions, all connected cables and wires must be EMC-shielded. Shieldings must be connected to the ground at both ends of the cable or wire. All power connections must be secured with cable lugs and cable glands. EMC-shielded cable glands are used in all Danfoss products for the power connections. Make sure that the low voltage cable (control signal cable) shield is also grounded from the both ends.

Cable gland assembly and power line connection

	<p>Risk of electric shock when the connection box lid is not installed.</p>
	<p>When you work with the power connections make sure that electricity has been disconnected and the electric device has discharged. Measure the level of the remaining voltage before you touch the power terminals.</p>

Blueglobe cable gland tightening torques

Metric thread	Nominal torque
M10 x 1.0	3.0 Nm
M12 x 1.5	5.0 Nm
M16 x 1.5	8.0 Nm
M20 x 1.5	10.0 Nm
M25 x 1.5	15.0 Nm
M32 x 1.5	15.0 Nm
M40 x 1.5	20.0 Nm
M50 x 1.5	30.0 Nm
M63 x 1.5	35.0 Nm
M75 x 1.5	80.0 Nm
M85 x 2.0	100.0 Nm

Installation

All electrical connections must be done according to instructions. It is essential to make sure that all terminal connections are installed properly and the intended application is suitable for the product in terms of electrical requirements/characteristics.

The cable harness for electric connections needs to be terminated with cable lugs and cable glands. It is recommended to use IP67/68 rated, 360° shielded cable glands and single core automotive rated screened cable.

The cable gland has three functions, it works as a stress relief, it seals the connection against water and dirt and provides appropriate EMI shielding. Advanced cable glands could achieve high EMI attenuation over a wide frequency range.

The cable lug and cable gland must be assembled according to instructions. For correct assembly of the cable gland, it is recommended to use a torque key with a turnkey head and a key to adapt the cable gland. The cable lug is connected to terminal with a M8 screw. Shielding of the power cable must be connected to the electric device body by the cable gland. Recommendations for the tightening torques must be followed. See the manufacturer's instructions on how to install the cable glands and the cable lugs. The following instructions may not apply to every type of connection this electric device has.

Cable harness connection with the cable lug and the cable gland (for illustration only)

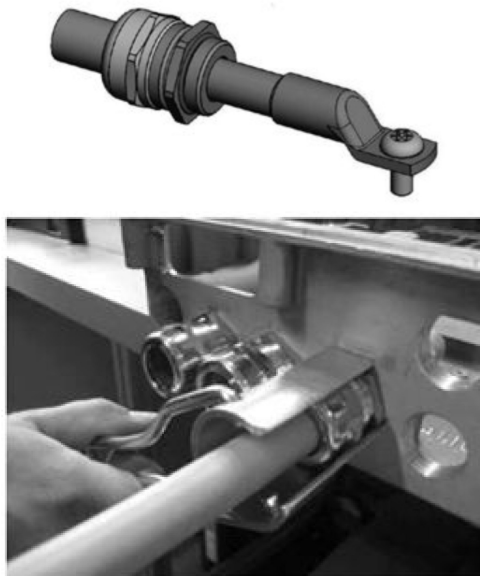

It is recommended to use screw size M8 x 16 and a washer combination of wave and regular washers.

Installation

Maximum protrusion of the screw through washer and cable lug

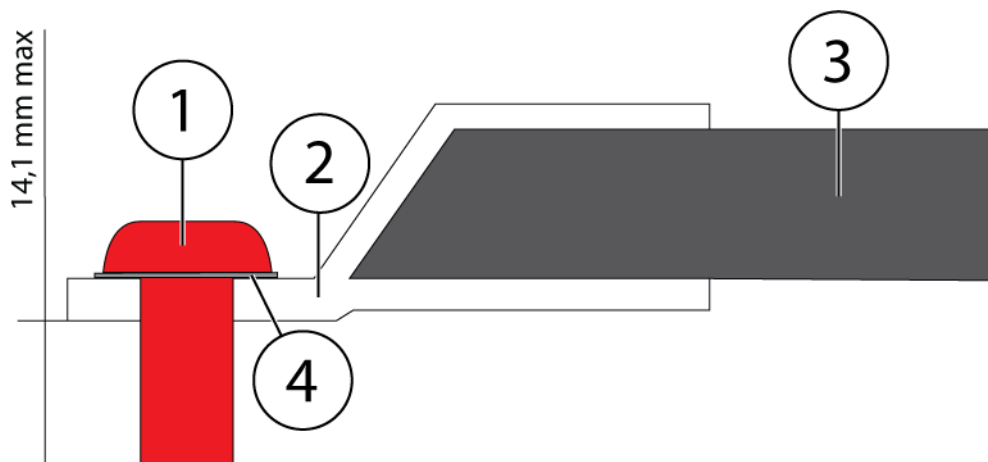

	Description
1	Screw
2	Cable lug
3	Cable
4	Washer

Pflitsch BlueGlobe-series cable glands and HUBER+SUHNER Radox Elastomer S, screened, single core, automotive cables are recommended.

The information below describes how to assemble screened power cables to the electric device.

Cable gland assembly instruction can also be found from Pflitsch cable gland catalogue available at <https://www.pflitsch.de>.

Correct cable gland type for the high voltage cables is Pflitsch blueglobe TRI bg XXXms tri (depending on option 225ms tri max. cable Ø 20 mm, max. screen Ø 16 mm or 232ms tri max. cable Ø 25 mm, max. screen Ø 20 mm).

Cable lug and cable gland assembly steps

Note that these instructions apply only for components that are recommended for this product.

1. Remove the small hexagonal piece from the BlueGlobe-sealing insert as shown in Figure below.

BlueGlobe-sealing

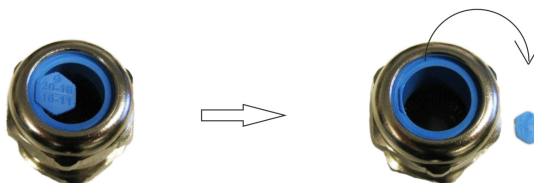

2. Cut the cable sheath at the distance A from the end of the cable, see Figure below. Pull the cut part of the sheath partly (length B is from 10 to 15 mm) off the cable as shown in the figure. Distance A depends of the length of the used cable lug. Measure with the cable lug that is used and cut to suitable length.

Installation

	<p>Do not remove the cable sheath completely at this point and do not cut the braid screen of the cable.</p>
--	---

Cut length of the cable sheath

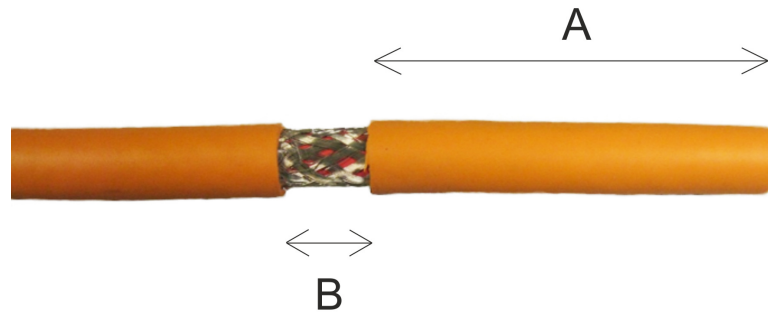

3. Wrap two layers of copper tape on the cable so that the distance B is covered. Use 3M™ Copper Foil Tape 1181 or similar. Contrary to the image below and depending on the cable and the cable gland size, you can leave the length A sheath in place for the next step to help the placement of the cable gland and remove the sheath only after the next step.

Cover the cable with copper tape

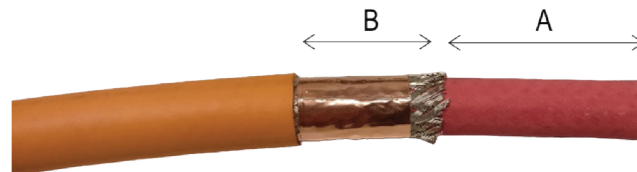

4. Insert the cable to the cable gland with slight turning motion. This helps the cable go through the spring inside the cable gland. Push the cable gland against the sheath of the cable as shown in Figure below.

Installation

Cable to the gland assembly



5. After the cable gland is in place remove the length A piece of the sheath and cut the braid screen (cover) from 10 mm (distance C) from the gland bottom as shown in Figure below.

	<p>Make sure that the cable gland spring is against the cable sheath (that is protected with copper tape) before cutting the braid screen.</p>
--	---

Cut the braid screen

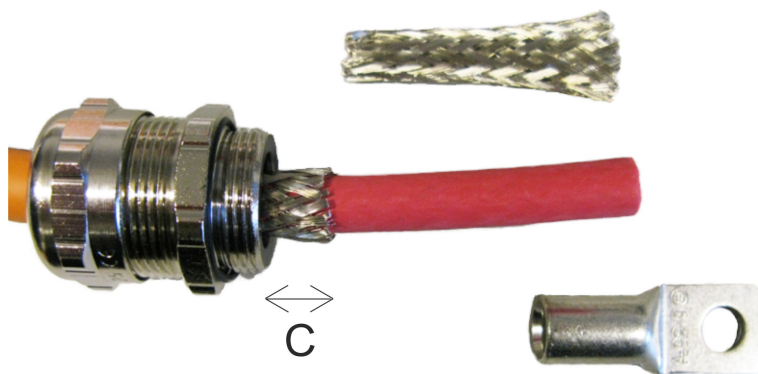

6. Cut a piece of length D of the inner sheath shown in Figure below. The length D must be equal to the length of the cable lug body.

Installation

Cutting the inner sheath

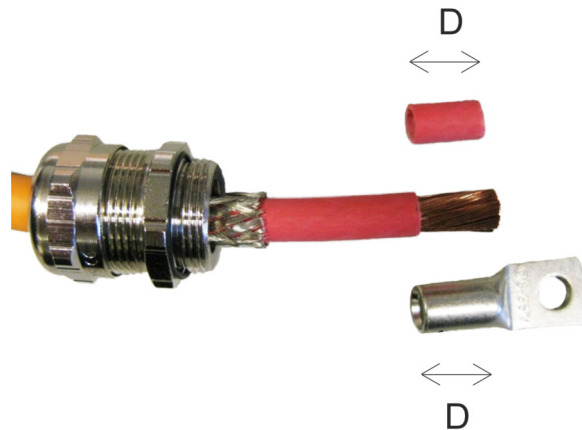

7. a) Make sure that the conducting strands of the cable are completely free of silicone and other impurities. Insert cable conductors fully into cable lug. Make sure that the cable lug is not too loose and that all conductors fit inside the lug. If not, check from the part list that you are using the correct cable lugs.
- b) Always use the crimping tool of the cable lug manufacturer. Before crimping, check the cable lug size from the lug (e.g. 35-8 is 35 mm²) and select the same size dies for the crimping tool. Use hexagonal dies.
- c) Crimp the cable lug at least twice in different places starting as near to the flat part of the lug as possible and towards the barrel part of the lug. Make sure that the cable does not slip out from the lug while crimping.
- d) Remove any excess compound emerging from the sides of the cable lugs after the crimping. Verify that the cable lug is evenly compressed with clear hexagonal crimps and that no conductors are broken. See Figure below.

Connecting cable lug

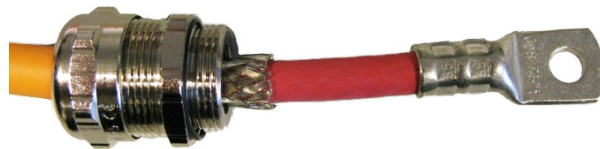

8. Cut piece of shrink tube and shrink it over the cable lug and braid screen as shown in Figure below. This is done to keep the braid screen in place and for extra insulation.

Installation

	<p>The shrink tube must be specified for operating temperature range from -40°C to +150°C. Self adhesive shrink tube is recommended.</p>
---	---

Shrink tube



9. Insert the cable through the corresponding hole in the electric device frame and connect the cable lug to the power terminal with the correct screw. Use spring washer between the cable lug and the connection screw or nut. Do not tighten the cable lug screw at this point to ensure fitting of the cable gland.

	<p>Make sure that there is at least 10 mm air gap between the cable lug and other metallic structures including the braid of the cable. If the air gap is smaller, use extra insulation shrink tube to cover the lug.</p>
---	--

10. Screw the cable gland to the power terminals of the electric device according to instructions. Tighten the cable gland with the specified torque.

	<p>Tighten the cable gland from the cable gland body to enclosure with torque 15 Nm. Then tighten the cap of the cable gland according to the instructions provided by cable gland manufacturer (recommendation Pflitsch).</p>
---	---

11. Tighten the cable lug using the specified torque.
12. Repeat the procedure to the other cables and connections.
13. Close the power terminal cover and install the connector shield.
14. Make sure that the power cable shields are grounded properly.

Installation

Cable lug and cable gland assembly cross section

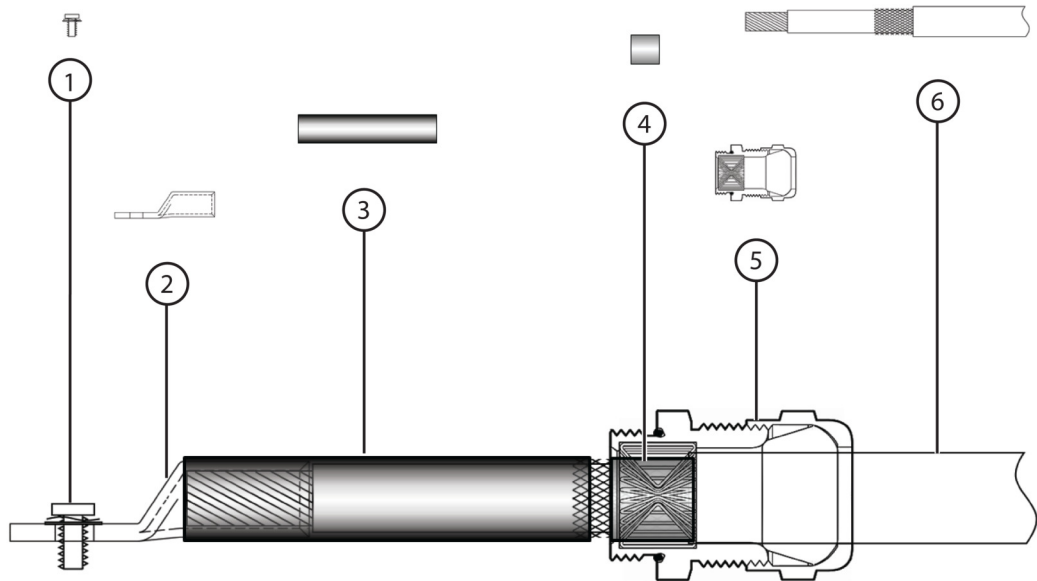

1	Cable lug bolt
2	Cable lug
3	Shrink wrap
4	Copper tape
5	Cable gland
6	Cable

Example of the equipment needed for the assembly

	Description	Manufacturer's homepage	Art.No./Part No.
Assembly equipment (example)	Torque key and turnkey head	http://www.pflitsch.de	730N/10-50
	Key	http://www.pflitsch.de	SE30
Assembly example for a 70 mm ² cable	Cable with nominal cross-section of 70 mm ²	http://www.hubersuhner.com	Radox Elastomer S
	Cable lug	http://www.druseidt.de	Druseidt with narrow flange 03906
	Cable gland	http://www.pflitsch.de	Pflitsch blueglobe TRI bg 225ms tri
	Screw	-	DIN 912 M8x20
	Washer	-	DIN 2093, 8.2 x 16 x 0.9
	Washer	-	DIN 125 D8

Installation

Example of the equipment needed for the assembly (continued)

	Description	Manufacturer's homepage	Art.No./Part No.
Assembly example for a 50 mm ² cable	Cable with nominal cross-section of 50 mm ²	http://www.hubersuhner.com	Radox Elastomer S
	Cable lug	http://www.druseidt.de	Druseidt with narrow flange 03903
	Cable gland	http://www.pflitsch.de	Pflitsch blueglobe TRI bg 225ms tri
	Screw	-	DIN 912 M8x20
	Washer	-	DIN 2093, 8.2 x 16 x 0.9
	Washer	-	DIN 125 D8
Assembly example for a 35 mm ² cable	Cable with nominal cross-section of 35 mm ²	http://www.hubersuhner.com	Radox screened multi core cable
	Cable lug	http://www.druseidt.de	Druseidt with narrow flange 03901
	Cable gland	http://www.pflitsch.de	Pflitsch blueglobe TRI bg 225ms tri
	Screw	-	DIN 912 M8x20
	Washer	-	DIN 2093, 8.2 x 16 x 0.9
	Washer	-	DIN 125 D8

Cablings and wiring

	Route the power cables as far from the control signal wires as possible. The minimum separating distance is 100 mm. The crossings must be in an angle of 90°. Power cables and control wires should be routed near the frame of the application. Make sure that all terminal connections are tightened correctly.
	Make sure that all terminal connections are tightened correctly and all cables are supported appropriately for vibration endurance. First mounting position should be 150 mm from the device.

Install the electric device following the instructions. Make sure that all the applications of the system, for example, the batteries are connected to the electric device according to the instructions in this user guide and the product specific guidelines.

Cabling

- For the power cables, it is recommended to use Radox Elastomer S, screened automotive cable or equivalent cable with similar specifications.
- Cable cross section can be 35 mm², 50 mm², 70 mm², 95 mm² or max. 120 mm² depending on the maximum current of the electric device.
- Use only EMI shielded power cables to make sure the correct operation of the electric device and to minimize the radiated emissions. Cable shields must be connected to the electric device ground at both ends of the cable.

All Danfoss products use EMI shielded cable glands for power connections.

Installation

Wiring

To ensure correct and steady operation, use EMI shielded cables for the control signals of the electric device. Cable shields must be connected to the electric device ground at both ends of the cable.

Recommendations for control signal cables

Cable	Cable type and properties
CAN cabling	Shielded cable (twisted pair)
Other signals	Shielded multistrand wire
External temperature measurement (PT100/PT1000)	Shielded cable (twisted pair)

High voltage connections

	The high voltage connections have a common ground connector. Check connector manufacturer's instructions for plugging in, unplugging and locking the connectors. Incorrect procedure can damage the connectors or reduce their lifetime.
	Do not place any excess weight on the connection box lid(s).

- The electric device must be installed and connected according to the instructions.
- Make sure that all the connected applications are connected to the electric device according to the product specific operating voltage.
- The electric device is delivered with the power terminal cover mounted. To access the power connections, remove the mechanical safety feature and the connection box lid.

For more information, see appropriate chapters in this user guide and the product data sheets.

Low voltage connections

	The durability of the X1-connector is limited to 10 installations / removals by the connector manufacturer.
	Always check the compatibility of the X1-connector and the counterpart. Never try to alter the connector in any way.
	When powering OFF the electric device, use the POWER_ON input. The power supply (VIN_N and/or VIN_P) can be disconnected, if desired, after time t_{min} has elapsed from the deactivation of POWER_ON (see Figure <i>Disconnecting the power supply</i> in this section). A safe value for t_{min} is 5 seconds.
	See the correct signal connections and product specific pin-layout from product data sheets at http://www.danfoss.com.

Installation



For information about the assembly of the control signal connectors, see the manufacture's web page.

Control signals

The control signals of the electric device are operated with the X1-connector.

To make sure of correct operation of the control signal, use compatible connector interface (male/female) and appropriate shielded wiring.

Control signal connector information

Description	Part number	Supplier example
X1-Control signal connector (in the enclosure) Tyco Electronics/AMPSEAL, 35-pin (male)	1-776163-1	http://www.te.com/usa-en/product-1-776163-1.html
X1-Cable connector (mating connector) Tyco Electronics/AMPSEAL, 35-pin (female)	Case:776164-1	http://www.te.com/usa-en/product-776164-1.html
	Pins: 770854-3 (wire 0.5-1.25mm ²)	http://www.te.com/usa-en/product-770854-3.html

Make sure that the part number ends with -1 and not with any other number.

Tools and accessories

Description	Part number	Supplier example
Crimping Tool Assembly 58529-1 with Die Assembly 58529-2	58529-1	http://fi.mouser.com/ProductDetail/TE-Connectivity/58529-1/?qs=Xf%252b3Aw93yEM%2FQReWlgzu%252bw%3D%3D
Connector seal plug (for storage and transportation)	770678-1	http://www.te.com/usa-en/product-770678-1.html
35-position wire relief	776463-1	http://www.te.com/usa-en/product-776463-1.html

Detailed and up to date information can be found at the manufacturer's website. Connector assembly should be done according to the connector manufacturer's instructions (for example contact crimping).



For IP6K9K, the signal connector requires the use of backshell. See connector manufacturer's website for further details.

Installation

Example of signal cabling between the EC-C1200-450 and EC-LCL1200B units

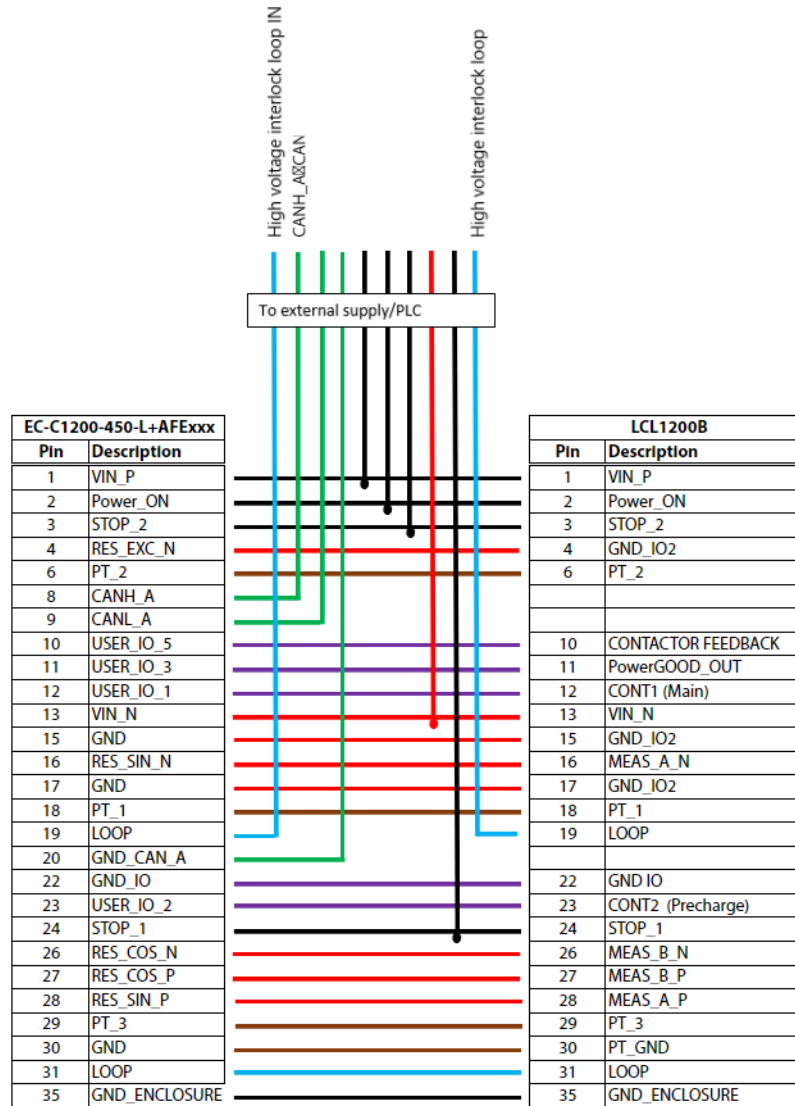

In the example:

- CAN bus is used to control the EC-C1200-450-L+AFExxx and read out the measurements and status information.
- Signal power supply (VIN_P, VIN_N) will provide power to the EC-C1200-450 and EC-LCL1200B units.
- PowerON signal is used to turn the units ON allowing the CAN communication between the EC-C1200-450-L+AFExxx and the Controller/PLC.
- STOP inputs can be used to force the IGBTs to open on EC-C1200-450-L+AFExxx and contactors to open on EC-LCL1200B. Note that this should only be used in case of emergency since activation of stop inputs might damage the units especially contactors on the LCL filter if done under high current.
- High voltage interlock loop can be used to detect the removal of the signal connectors on EC-C1200-450 and EC-LCL1200B units by using a Controller or PLC to feed a current or PWM signal through the units and monitoring HVIL output.

Installation

Disconnecting the power supply

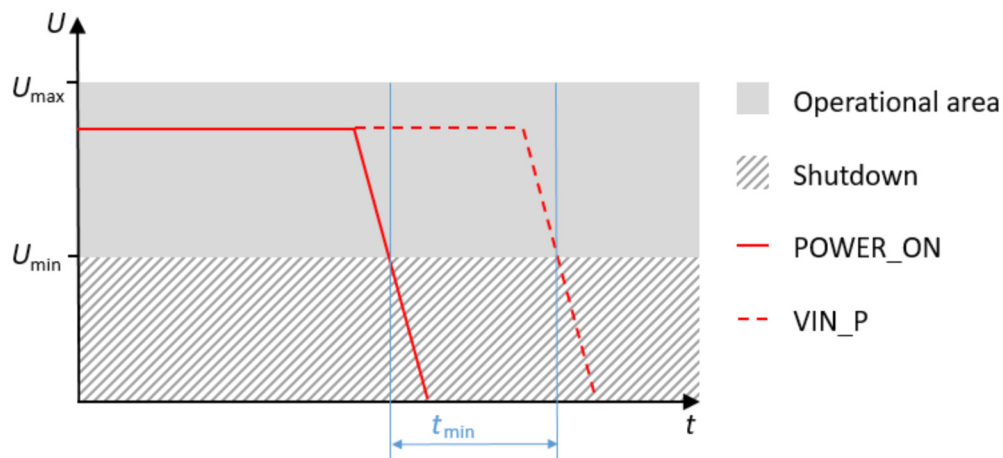

Sufficient time should elapse between bringing the POWER_ON voltage down and bringing VIN_P down.

Signals for monitoring, diagnostics and set-up

Monitoring, diagnostics and setting up of the electric device takes place through the converter. For more information, see *User Guide EC-C Software*.

Operation

Operation conditions

The electric device should be used for its intended purpose only and within limits specified by the manufacturer, concerning:

- Loading.
- Cooling.
- Service interval.
- Ambient conditions such as temperature and moisture.

The electric device is designed for these conditions:

- Ambient temperature limits: -40°C...+85°C.
- Maximum altitude 4000 m above sea level.
- Maximum coolant liquid temperature: +65°C (for details, see the product data sheet).
- Coolant liquid must be a mixture of water and glycol with maximum of 52 % glycol content. See chapter [Recommended coolants](#) on page 32.
- Maximum enclosure temperature +90°C (in worst conditions).

If the operation limits are exceeded and the electric device is damaged, please contact local Danfoss representative.

Condition monitoring during operation

	<p>Risk of permanent damage to the electric device. Use the electric device only if the technical guidelines and ambient conditions given in this user guide and in the data sheet are met.</p>
	<p>Risk of permanent damage to the electric device. If you notice deviations from the normal operation (for example: high temperatures or noise), stop the electric device. Find the reason for the deviation and refer to Chapter Troubleshooting on page 54 for more information.</p>
	<p>Electrical safety of the system and the end application has to be guaranteed using appropriate methods, like external insulation resistance monitoring for IT grids or residual current monitoring for TN grids, depending on the application.</p>

Monitor the electric device regularly during operation to make sure of reliable operation, to foresee possible upcoming failures and to help to reach the designed lifetime of the product.

Maintenance

Regular maintenance

	<p>Do not disassemble the electric device. You can do only procedures described in this user guide. For further information contact Danfoss representative.</p>
	<p>Only trained and qualified personnel that are familiar with the relevant safety requirements can do any maintenance to the electric device.</p>
	<p>Risk of electric shock when the connection box lid is removed.</p>
	<p>Inspect the electric device at regular intervals. Use the regular maintenance checklists in the inspections.</p>
	<p>Do not attempt to tighten or release any screws, nuts or joints which are not shown in this user guide and that are not involved in the normal installation and maintenance procedures.</p>
	<p>Use correct personal protective equipment when you are near the electric device.</p>
	<p>Read the instructions in the user guide before you install the electric device. To ensure safe and reliable operation of the electric device, obey the maintenance instructions.</p>

Maintenance

Maintenance intervals

Object		Check/Task	Weekly	Monthly	Yearly
General construction	Operation	Abnormal phenomenon, for example noise or heating. If clearly increased, contact Danfoss representative.	X		
	Mounting	Tightness of the screws. Tighten to proper value if necessary. Applies to screws that are presented in this user guide. See Chapter Tightening torques on page 18.			X
	Enclosure and connected parts	Check cleanliness. Clean if necessary. See Chapter Cleaning on page 50.		X	
Electrical system	Cables	Visual check, for example wear. Replace if necessary.		X	
	Electrical connections	Check connections. Ensure that sufficient tightening torque is applied to cable glands and lugs. See Chapter Tightening torques on page 18.			X
	Groundings (earthings)	Check groundings (earthings). Ensure that the connection resistance is valid. Re-connect if necessary.			X
Cooling system	Operation	Functioning. Cooling system functions as specified.	X		
	Tubing and connection tightness	No visible leakage. If leaking, tighten connections appropriately, or replace parts.		X	
	Ventilation plug	Cleanliness. Clean if necessary. See Chapter Cleaning on page 50.		X	
	Coolant quality	Use the coolant as specified (water-glycol mixture appropriate). Refill if necessary. See Chapter Recommended coolants on page 32 and Cooling system maintenance on page 50.			X

Cooling system maintenance

The cooling system of the electric device requires regular observation and maintenance activities. Observe weekly that the cooling system operates correctly and check monthly that there are no leakages in the cooling system. The quality of the coolant must be checked yearly. The mixture of water and glycol as well as the type of the glycol used must be as specified. See Chapter [Recommended coolants](#) on page 32.

Cleaning

	Do not use pressure washer for cleaning. High water pressure may damage the gaskets allowing water to go in to the electric device.
	Never open or remove the watertight breather plugs. Clean them only from the outside.







Maintenance



Risk of electric shock if the electric device is cleaned against instructions allowing water to go in to the electric device.

Keep the electric device clean. For cleaning, use non-abrasive and non-corrosive cleaning products. Make sure that the detergent can be used for aluminum.

Dismounting and disposal of the electric device

	Risk of electric shock if dismounting steps are continued before the electric device is discharged and a safe voltage level has been measured.
	Do not touch the electric device or continue to work with the electric device until it cools down.
	Do not use excessive force when you disconnect the connector, because the plastic housing of the connector can break. Release the retaining clip of the connector before you disconnect the connector. Do not try to unplug the X1 connector by pulling from its wires.
	Support the electric device during dismounting, handle it with care.
	When the device is dismantled and stored and packed for delivery, measure that there is no voltage and then install short circuit wire between high voltage connection points to prevent charge from building up.
	Refer to Chapter Installation procedure on page 29 for additional information.

Dismounting procedure

1. Switch off the electric device.
2. Make sure that the cooling system remains operational.
3. Release the retaining clip of the X1-connector (control signal connector, low voltage, 35-pin) and disconnect the connector.
4. Wait until the electric device has fully discharged. Always measure that no voltage is present on the power terminals before you proceed.
5. Wait until the temperature of the electric device and cooling liquid has decreased below +40°C.
6. Disconnect the power terminal cabling.
7. Disconnect grounding cables (protective earth).
8. Disconnect the liquid cooling system.
9. Remove the mounting screws and dismount the electric device from the mounting base.
10. Install the connection box lid and other parts and plug all electrical and cooling connections for longer storage.
11. Lift of the electric device according to Chapter [Lifting](#) on page 20.

Disposal of the electric device

Dispose of the electric device and any of its parts by appropriate means in accordance with local laws and regulations.

Dismounting and disposal of the electric device

	<p>Electric device must not be opened (excluding the connection box lid). Any attempt causes loss of warranty.</p>
---	---

Troubleshooting

	<p>Do not activate the automatic fault reset function on any system where it can be the cause of a potentially dangerous situation.</p>
	<p>Do not try to repair the electric device. In the case of suspected fault or malfunction, contact Danfoss or authorized service centre for further assistance.</p>
	<p>For the reason of general safety and correct operative actions, read the instructions carefully before you start any analyses or work with the electric device.</p>
	<p>Use correct personal protective equipment when you are near the electric device.</p>

Some unexpected situations may occur while operating the electric device. Some of the possible causes and actions are given in table below. If an unexpected situation occurs, it should be corrected as soon as possible.

These instructions do not cover all details or variations in the equipment nor provide information for every possible condition to be met in connection with installation, operation or maintenance.

Troubleshooting

Fault description	Possible cause	Action
Electric device overheating	Cooling system failure.	Inspect the cooling system operation and functionality, especially possible leaks, flow rate and fluid temperature. Change the cooling flow direction to flush the cooling system from sediment possibly accumulated.
	Leakage in the cooling system.	Inspect the cooling system circuit and connections.
	Rigid particle inside the cooling channel of the electric device.	Try to pulsate coolant to open the channels. Contact Danfoss representative.
Significant coolant leak	Loose connection in the cooling system.	Inspect, clean and tighten the connections. Replace them if necessary.
	Broken cooling hose.	Replace the cooling hose.

Troubleshooting

Troubleshooting (continued)

Fault description	Possible cause	Action
Electric device does not work correctly or the performance is poor	Poor powerline contacts (high voltage)	Inspect, clean and tighten the contacts. Ensure correct high voltage cabling (shielding). See section <i>Electrical installation</i> for more information.
	Poor control signal contacts (low voltage)	Inspect the X1-connector mounting and individual wire connection. Ensure correct signal cabling (shielding, twisted pair). See section <i>Electrical installation</i> for more information.

Aftersales

Service policy

For further information, go to <https://danfosseditron.zendesk.com/hc/en-gb> or send email to editron.service@danfoss.com.

Products we offer:

- Cylinders
- Electric converters, machines, and systems
- Electronic controls, HMI, and IoT
- Hoses and fittings
- Hydraulic power units and packaged systems
- Hydraulic valves
- Industrial clutches and brakes
- Motors
- PLUS+1® software
- Pumps
- Steering
- Transmissions

Danfoss Power Solutions designs and manufactures a complete range of engineered components and systems. From hydraulics and electrification to fluid conveyance, electronic controls, and software, our solutions are engineered with an uncompromising focus on quality, reliability, and safety.

Our innovative products makes increased productivity and reduced emissions a possibility, but it's our people who turn those possibilities into reality. Leveraging our unsurpassed application know-how, we partner with customers around the world to solve their greatest machine challenges. Our aspiration is to help our customers achieve their vision — and to earn our place as their preferred and trusted partner.

Go to www.danfoss.com or scan the QR code for further product information.

**Hydro-Gear**

www.hydro-gear.com

Daikin-Sauer-Danfoss

www.daikin-sauer-danfoss.com

**Danfoss
Power Solutions (US) Company**
2800 East 13th Street
Ames, IA 50010, USA
Phone: +1 515 239 6000

**Danfoss
Power Solutions GmbH & Co. OHG**
Krokamp 35
D-24539 Neumünster, Germany
Phone: +49 4321 871 0

**Danfoss
Power Solutions ApS**
Nordborgvej 81
DK-6430 Nordborg, Denmark
Phone: +45 7488 2222

**Danfoss
Power Solutions Trading
(Shanghai) Co., Ltd.**
Building #22, No. 1000 Jin Hai Rd
Jin Qiao, Pudong New District
Shanghai, China 201206
Phone: +86 21 2080 6201

Danfoss can accept no responsibility for possible errors in catalogues, brochures and other printed material. Danfoss reserves the right to alter its products without notice. This also applies to products already on order provided that such alterations can be made without subsequent changes being necessary in specifications already agreed. All trademarks in this material are property of the respective companies. Danfoss and the Danfoss logotype are trademarks of Danfoss A/S. All rights reserved.