

VACON[®] 100 INDUSTRIAL
VACON[®] 100 X
AC DRIVES

SOLAR PUMP
APPLICATION GUIDE

TABLE OF CONTENTS

Document: DPD01602E

Version release date: 24.9.24

Corresponds to software package AMIT1181_V207.vcx

1. Preface.....	6
1.1 Specific functions of VACON® Solar pump application	6
1.2 Version history	7
2. Safety.....	8
2.1 Danger	8
2.2 Warnings	8
3. Installation.....	9
3.1 Danger	9
3.2 Warning	9
3.3 Type code.....	10
3.3.1 Model number	10
3.4 Lifting the AC drive.....	10
3.4.1 Weight of the AC drive.....	11
3.4.2 Lifting enclosure sizes MM4–MM6 and MR4–MR9.....	12
3.4.3 Lifting VACON® 100 IP00 Drive Modules MR10/MR12 without options	12
3.4.4 Lifting VACON® 100 IP00 Drive Modules MR10/MR12 with an options module	13
3.5 DC Fuse selection	14
3.6 Manufacturers of gPV fuses	16
3.7 Parallel diode selection	17
3.8 Photovoltaic system dimensioning	20
3.9 Power ratings	23
3.10 Grounding.....	25
3.10.1 Pole Grounding	25
3.10.2 Drive Grounding	25
3.10.3 Earth fault alarm.....	25
3.11 AC grid or generator connection	25
3.11.1 More than one source of supply	25
3.11.2 Toggle between AC and DC.....	25
3.11.3 Dual supply functionality.....	25
3.11.4 Overvoltage category	26
3.12 External +24 V supply.....	27
3.13 DC power connection	27
3.13.1 VACON® 100 X drives	27
3.13.2 VACON® 100 INDUSTRIAL drives.....	28
4. Startup.....	32
4.1 First Startup	32
4.2 Description of the applications	35
4.2.1 M1 Quick setup parameter group.....	35
4.2.2 Standard application	40
4.2.3 Local/Remote application	41
4.2.4 Multi-step application	42
4.2.5 PID Control application	43
4.2.6 Multi-purpose application.....	46
4.2.7 Motor potentiometer application	48
5. User interfaces	49
5.1 Keypad of the drive.....	49
5.1.1 Buttons	49
5.1.2 Display.....	49
5.1.3 Navigation on keypad	49

5.1.4	Graphical keypad.....	50
5.1.5	Text keypad	56
5.2	VACON® live	60
5.3	Menu structure	61
5.3.1	Quick setup.....	62
5.3.2	Monitor	62
5.3.3	Parameters	64
5.3.4	Diagnostics.....	64
5.3.5	I/O and hardware.....	67
5.3.6	User settings	77
5.3.7	Favorites.....	78
5.3.8	User levels	78
5.4	Example of control connections	79
5.4.1	Relay and thermistor input terminals	80
5.4.2	Safe Torque off (STO) terminals	80
6.	Monitoring menu.....	81
6.1	Monitor group.....	81
6.1.1	Multimonitor.....	81
6.1.2	Trend curve	81
6.1.3	Basic.....	83
6.1.4	I/O	84
6.1.5	Extras & advanced	85
6.1.6	Timer functions	87
6.1.7	PID Controller	87
6.1.8	ExtPID Controller	88
6.1.9	Mainten. counters	88
6.1.10	Fieldbus data.....	88
6.1.11	Solar	89
6.1.12	Flow	90
7.	Parameters.....	91
7.1	Application parameter lists	91
7.1.1	Column explanations	92
7.1.2	Group 3.1: Motor settings	92
7.1.3	Group 3.2: Start/Stop setup	97
7.1.4	Group 3.3: References	99
7.1.5	Group 3.4: Ramps And Brakes.....	102
7.1.6	Group 3.5: I/O Config.....	103
7.1.7	Group 3.6: Fieldbus DataMap	110
7.1.8	Group 3.7: Prohibit Freq	111
7.1.9	Group 3.8: Supervisions	111
7.1.10	Group 3.9: Protections	112
7.1.11	Group 3.10: Automatic reset.....	119
7.1.12	Group 3.11: Appl. Settings	119
7.1.13	Group 3.12: Timer functions	120
7.1.14	Group 3.13: PID Controller	125
7.1.15	Group 3.14: ExtPID Controller	133
7.1.16	Group 3.16: Mainten. Counters.....	136
7.1.17	Group 3.21: Pump Control	137
7.1.18	Group 3.22: Solar	138
7.1.19	Group 3.23: Flow meter	139
7.1.20	Group 3.24: Dual Supply.....	140
7.2	Additional parameter information	142
7.2.1	Motor Control	142
7.2.2	Open Loop	146

7.2.3	Start/Stop Setup.....	148
7.2.4	References	151
7.2.5	Preset Freqs.....	152
7.2.6	Motor Potentiom.	154
7.2.7	Ramps And Brakes	155
7.2.8	Flux Braking	156
7.2.9	Digital inputs	156
7.2.10	Analog inputs	157
7.2.11	Digital Outputs	160
7.2.12	Analog outputs	162
7.2.13	Prohibit Freq	164
7.2.14	Protections	165
7.2.15	Automatic Reset	169
7.2.16	Feedbacks	170
7.2.17	FeedForward	171
7.2.18	Sleep Function	172
7.2.19	Feedback Superv.....	173
7.2.20	Press.Loss.Comp	174
7.2.21	Soft fill	176
7.2.22	Auto-Cleaning	177
7.2.23	Solar	178
7.2.24	Dual supply parameters	182
8.	Faults	185
8.1	Fault Tracing	185
8.2	Fault appears	185
8.3	Fault History.....	186
8.4	Fault codes	187

1. PREFACE

The VACON® AC drive contains a preloaded VACON® 100 Solar Pump application for instant use.

The instructions in this manual are intended only for VACON® 100 X (MM4–MM6) and VACON® 100 INDUSTRIAL (MR5–MR12) drives using the solar pump application. See the corresponding operating guide/installation manual for more instructions.

1.1 SPECIFIC FUNCTIONS OF VACON® SOLAR PUMP APPLICATION

The VACON® 100 Solar Pump application allows flexible use of VACON® 100 frequency converters. This dedicated application software was developed to drive a solar pump with an optimized MPPT (Maximum Power Point Tracking) for VACON® 100 supplied by solar panels.

The MPPT is based on 4 parallel algorithms:

- Feed-Forward Controller (to follow the radiation variations)
- Correction Controller (to compensate the temperature variations)
- Oscillation Damping Regulator (to prevent the panel entering in the “current source” branch of the characteristic)
- Local Maxima logic (to prevent the regulator from being trapped in a local maximum lower than absolute maximum)

Features

- The MPP Tracker controls DC voltage reference in order to find the maximum power.
- **Extensive wizards** for start-up, PID-control used to facilitate commissioning
- **‘Funct’ button** for easy change between Local (keypad) and Remote control place. The remote control place is selectable by parameter (I/O or Fieldbus)
- **8 preset frequencies**
- **Motor potentiometer** functions
- 2 programmable **ramp times**, 2 **supervisions** and 3 ranges of **prohibited frequencies**
- **Control page** for easy operation and monitoring of the most essential values.
- **Fieldbus** data mapping
- **Automatic reset**
- Different **pre-heat modes** used to avoid condensation problems
- **Maximum output frequency 320 Hz**
- **Real-time clock and timer functions** available (optional battery required). Possible to program 3 time channels to achieve different functions on the drive (e.g. Start/Stop and Preset frequencies)
- **External PID-controller** available. Can be used to control e.g. a valve using the AC drive I/O
- **Sleep mode function** which automatically enables and disables drive running with user defined levels to save energy.
- **2-zone PID-controller** (2 different feedback signals; minimum and maximum control)
- **Two setpoint sources** for the PID-control. Selectable with digital input
- **PID setpoint boost function**
- **Feedforward function** to improve the response to the process changes
- **Process value supervision**
- **Maintenance** counter
- **Underload protection** can be managed by measuring Motor torque (standard sensorless mode) or by measuring the water flow with a flow meter sensor. This sensor can be an analogue signal or a digital input. With this sensor it is possible to measure the water flow [litres/min] and the total volume of the water flow [m³].
- **Sleep mode** can be enabled or disabled with a parameter.
- Digital inputs can be used to **measure water levels** (minimum and maximum).

The firmware version of the Solar Pump application can be found in the Software info parameter group 4.6. For more information, see Chapter 5.3.4.6.

1.2 VERSION HISTORY

This guide is regularly reviewed and updated. All suggestions for improvement are welcome. The original language of this guide is English.

Table 1. Version history

Edition	Remarks
DPD01602D	Added lifting instructions to Chapter 3.4. Updated DC fuse selection information in Chapter 3.5. Updated Photovoltaic system dimensioning information in Chapter 3.8. Added power ratings to Chapter 3.9. Added over voltage category information to Chapter 3.11.4. Updated DC power connection information in Chapter 3.13.
DPD01602E	Added information about type codes. Added information about earth fault alarms. Minor changes throughout the manual.

2. SAFETY

This manual contains clearly marked warning information which is intended for your personal safety and to avoid any unintentional damage to the product or connected appliances.

Before installing, commissioning or using the frequency converter, please read the warning information contained in the corresponding operating guide/installation manual.

Please read the following additional safety instructions carefully.

Only Danfoss authorized, trained and qualified personnel are allowed to install, operate and maintain the drive.

2.1 DANGER

These warnings are intended to personnel responsible for grounding the frequency converter.



Ignoring the following instructions can be **extremely dangerous and may cause death or severe injury.**



Ground the frequency converter to ensure personnel **safety and to reduce electromagnetic interference.**



After disconnecting the AC drive from the mains or from the DC input supply, **wait** until the indicators on the keypad go out (if no keypad is attached, see the indicators on the cover). Wait an additional 60 seconds before starting any work on the connections of the drive. After expiration of this time, use measuring equipment to absolutely ensure that no voltage is present. **Always ensure absence of voltage before starting any electrical work!**

2.2 WARNINGS



The **touch current** of the drive exceeds 3.5 mA AC. According to standard EN61800-5-1, **a reinforced protective ground connection** must be ensured. See the Installation Manual/Operating Guide of your product for further information.



Never work on the photovoltaic generator or frequency converter and its input/output cables when the frequency converter is connected to the mains or to the photovoltaic generator.



Before performing any measurement on the frequency converter, disconnect or isolate the mains supply voltage or the DC input supply.



Do not touch the components on the frequency converter or on the string box cabinet that have high DC voltage.





The photovoltaic generator **cells exposed to light supply DC voltage** even at low light intensity.

3. INSTALLATION

The installation instructions in this chapter are intended only for VACON® 100 X (MM4–MM6) and VACON® 100 INDUSTRIAL (MR5–MR12) drives with additional solar pump application. See the corresponding operating guide/installation manual for more installation instructions.

NOTE! The Solar pump application is active only with a plus code: +A1181. The drive can be ordered from factory using this plus code or it can be activated afterwards by license key.

3.1 DANGER

	The terminals are live when the drive is connected to a photovoltaic system. Photovoltaic cells generate DC voltage even at low intensity of sunlight.
	Wait 60 seconds until the drive is discharged, before switching between AC and DC supply (photovoltaic system) and vice versa.

3.2 WARNING

	Do not remove the EMC screws in the solar pump application. IT (impedance-grounded) AC supply network is not allowed in the solar pump application.
--	---

3.3 TYPE CODE

VACON[®] type code is formed of a model number and optional +codes. Each segment of the type code uniquely corresponds to the product and options you have ordered. The code is of the following format:

VACON0100-3L-0061-4-X +xxxx +yyyy

VACON	This segment is common for all products.
0100	Product range: 0100 = VACON [®] 100 Product family
3L	Input/Function: 3L = 3-phase input
0061	Rated continuous current of the drive in ampere; e.g. 0061 = 61 A. For all the drive ratings, see the corresponding operating guide/installation manual.
4	Supply voltage: 2 = 208-240 V 4 = 380-480 V 5 = 380-500 V
X	Enclosure type: Empty = Wall mounted X = Decentral, IP66/ Type 4X
+xxxx	Additional options (several options possible).
+yyyy	For more information about the available options, see the VACON [®] 100 Wall-mounted Drives Operating Guide or VACON [®] 100 X Installation Manual.

3.3.1 MODEL NUMBER

In the type code, the section without the additional options, is called the model number, which defines the AC drive type. For example:

VACON0100-3L-0061-4-X

For more information, see the VACON[®] 100 Wall-mounted Drives Operating Guide or VACON[®] 100 X Installation Manual.

3.4 LIFTING THE AC DRIVE

	<p>LIFTING HEAVY LOAD</p> <p>Not following the safe lifting instructions can result in death or serious injury.</p> <ul style="list-style-type: none"> • Do not walk under suspended loads. • Use lifting devices that are appropriate for the weight of the unit. • Use the recommended lifting method.
---	--

The AC drive is delivered horizontally in a cardboard box or on a wooden pallet. Open the package only when you install the drive. Do not keep the drive in storage in the vertical position.

3.4.1 WEIGHT OF THE AC DRIVE

The weights of AC drives of different enclosure sizes are different. It can be necessary for you to use a lifting device to move the drive from its package. See the weights of the different enclosure sizes in below table.

Table 2. Weights of VACON® 100 X drives (MM4–MM6)

Enclosure size	Weight	
	[kg]	[lb]
MM4	8.8	19.4
MM5	14.9	32.8
MM6	31.5	69.4

Table 3. Weights of VACON® 100 Wall-mounted Drives (MR4–MR9)

Enclosure size	Weight	
	[kg]	[lb]
MR4	6.0	13.2
MR5	10.0	20.0
MR6	20.0	44.1
MR7	37.5	82.7
MR8	66.0	145.5
MR9	119.5	263.5

Table 4. Weights of VACON® 100 IP00 Drive Modules (MR8–MR12)

Enclosure size or item	Weight	
	[kg]	[lb]
MR8 IP00 drive module	50	110
MR9 IP00 drive module	107	214
MR10 IP00 drive module	221	487
MR10 IP00 drive module and the options module with the brake chopper	252	556
MR10 IP00 drive module and the options module with the brake chopper and the common-mode filter	258	569
MR10 IP00 drive module and the options module with the brake chopper, the common-mode filter, and the dU/dt filter	289	637
MR10 IP00 drive module and the options module with AC fuses and fuse switch (+CIFD)	332	732
MR11 IP00 drive module	214	472
MR12 IP00 drive module	442	974
MR12 IP00 drive module and the options module with the brake chopper	504	1111
MR12 IP00 drive module and the options module with the brake chopper and the common-mode filter	516	1138

Table 4. Weights of VACON® 100 IP00 Drive Modules (MR8-MR12)

MR12 IP00 drive module and the options module with the brake chopper, the common-mode filter, and the dU/dt filter	578	1274
MR12 IP00 drive module and the options module with AC fuses and fuse switch (+CIFD)	570	1257

3.4.2 LIFTING ENCLOSURE SIZES MM4-MM6 AND MR4-MR9

1	Remove the drive from the cardboard box or the pallet where it was bolted to.
2	Use a lifting device that is sufficiently strong for the weight of the drive.
3	Put the lifting hooks symmetrically in a minimum of 2 holes.
4	The maximum lifting angle is 45°.

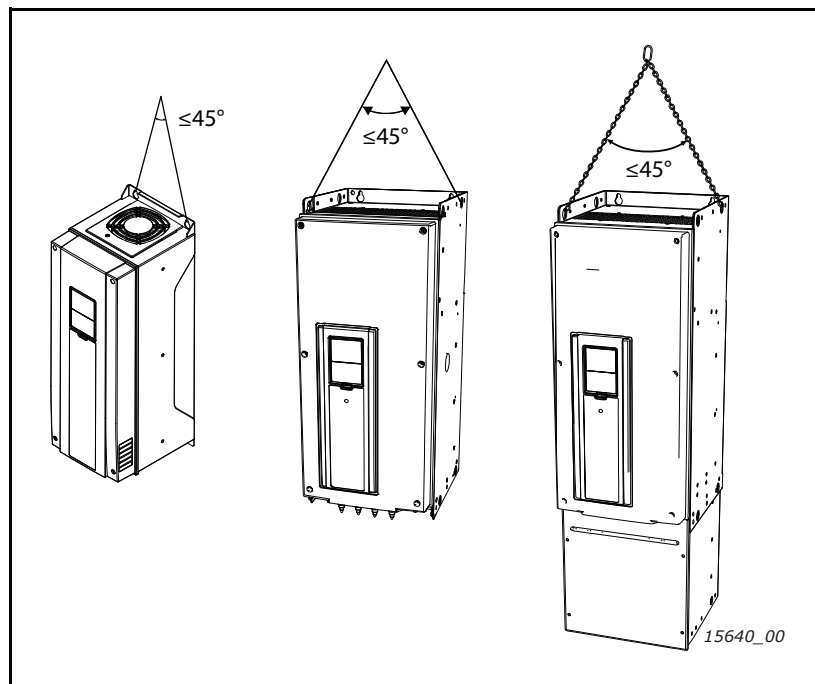

Figure 1. Lifting enclosure sizes MM4-MM6 and MR4-MR9

3.4.3 LIFTING VACON® 100 IP00 DRIVE MODULES MR10/MR12 WITHOUT OPTIONS

1	Remove the drive from the package.
2	Make sure that the support (A in Figure 2) is attached to the bottom of the drive. It gives the terminals protection when you lift the drive or put it vertically on the floor.
3	Use a lifting device that is sufficiently strong for the weight of the drive.
4	Put the lifting hooks in the holes on the top of the cabinet. The maximum lifting angle is 60°.
5	After the lifting, you can remove the support if necessary. You can also use it as a fixing bracket.

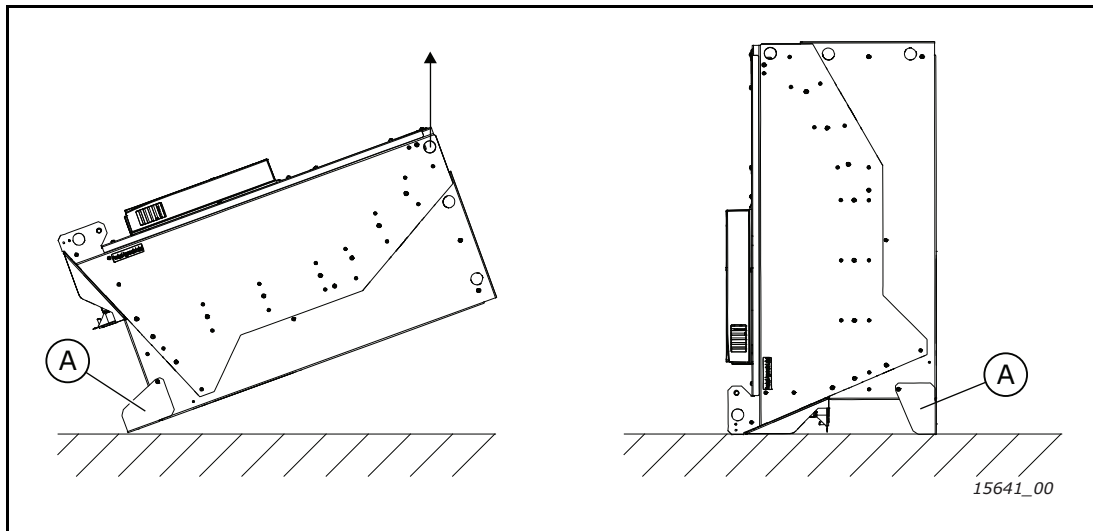

Figure 2. Lifting VACON® 100 IP00 Drive Modules MR10/MR12 without options

3.4.4 LIFTING VACON® 100 IP00 DRIVE MODULES MR10/MR12 WITH AN OPTIONS MODULE

1	Remove the drive from the package.
2	Use a lifting device that is sufficiently strong for the weight of the drive.
3	Put the lifting hooks in the holes on the top of the cabinet. The maximum lifting angle is 60°.
4	Lift the drive into a vertical position.

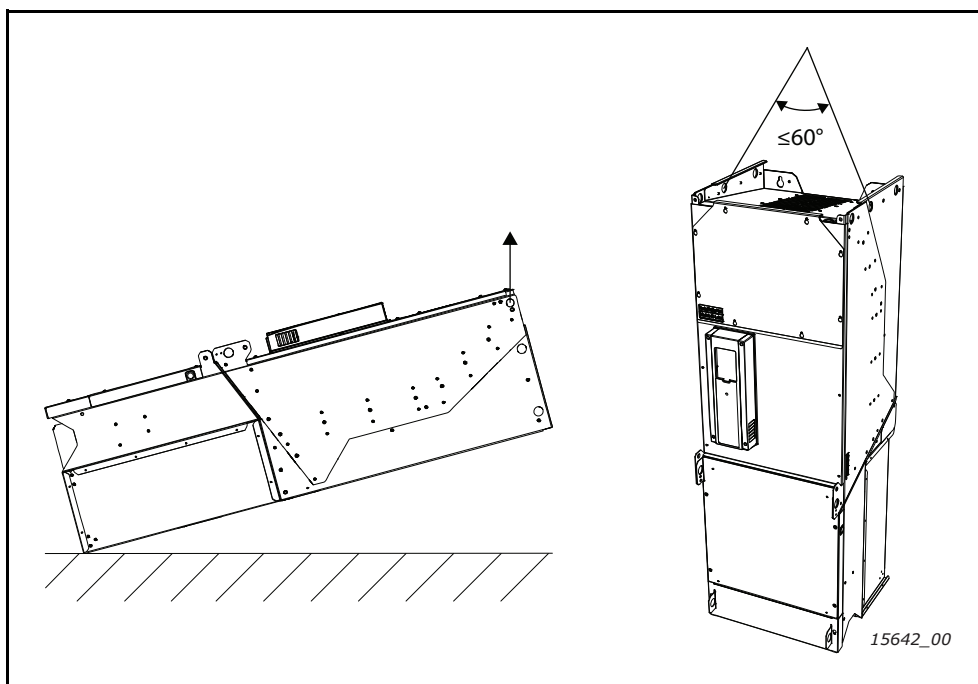

Figure 3. Lifting VACON® 100 IP00 Drive Modules MR10/MR12 with options module

3.5 DC FUSE SELECTION

The fuses on the DC input of the inverter must have the following characteristics:

Table 5. Fuse characteristics

Fuse type	Minimum Voltage rating
DC current	1000 V

It is recommended to use gPV fuses, which are developed for solar application, in order to protect cables and panels against reverse over current, when multiple strings are connected in parallel. See chapter 3.6. for recommended gPV fuse manufacturer.

The photovoltaic fuses have to meet the IEC 60269-6 or the UL 2579 standard.

The maximum I_{SC} PV and inverter back-feed current depend on the used DC fuses. Make sure that the breaking capacity of the fuses is sufficient for the final application. Also, local regulations must be taken into account.

See the tables below for recommended fuse sizes:

Table 6. Recommended fuse sizes, Mains voltage 3AC 208-240 V, 50/60 Hz, up to 400 V in V DC

Enclosure size	AC drive type VACON0100-3L-	Rated continuous current [A]	IEC60269-6 Fuse size [A]	UL-2579 Fuse size [A]	Total number of fuses
MM4	0007-2-X	6.6	12	12	2
	0008-2-X	8.0	15	15	2
	0011-2-X	11.0	20	20	2
	0012-2-X	12.5	20	25	2
MM5	0018-2-X	18.0	30	40	2
	0024-2-X	24.0	40	50	2
	0031-2-X	31.0	50	63	2
MM6	0048-2-X	48.0	80	100	2
	0062-2-X	62.0	100	125	2
MR5	0018-2	18.0	30	40	2
	0024-2	24.0	40	50	2
	0031-2	31.0	50	63	2
MR6	0048-2	48.0	80	100	2
	0062-2	62.0	100	125	2
MR7	0075-2	75.0	125	160	2
	0088-2	88.0	160	200	2
	0105-2	105.0	200	200	2
MR8	0140-2	140.0	250	315	2
	0170-2	170.0	315	400	2
	0205-2	205.0	400	400	2
MR9A	0261-2	261.0	500	500	2
	0310-2	310.0	600	630	2

Table 7. Recommended fuse sizes, Mains voltage 3AC 380–480/500 V, 50/60 Hz, up to 800 V in V DC

Enclosure size	AC drive type VACON0100-3L-	Rated continuous current [A]	IEC60269-6 Fuse size [A]	UL-2579 Fuse size [A]	Total number of fuses
MM4	0003-5-X	3.4	6	6	2
	0004-5-X	4.8	8	8	2
	0005-5-X	5.6	10	10	2
	0008-5-X	8.0	12	15	2
	0009-5-X	9.6	15	16	2
	0012-5-X	12.0	20	20	2
MM5	0016-5-X	16.0	25	30	2
	0023-5-X	23.0	40	40	2
	0031-5-X	31.0	50	63	2
MM6	0038-5-X	38.0	63	63	2
	0046-5-X	46.0	80	80	2
	0061-5-X	61.0	100	100	2
	0072-5-X	72.0	125	125	2
MR5	0016-5	16.0	30	30	2
	0023-5	23.0	40	50	2
	0031-5	31.0	50	63	2
MR6	0038-5	38.0	63	80	2
	0046-5	46.0	80	100	2
	0061-5	61.0	100	125	2
MR7	0072-5	72.0	125	150	2
	0087-5	87.0	160	200	2
	0105-5	105.0	200	200	2
MR8	0140-5	140.0	250	315	2
	0170-5	170.0	315	400	2
	0205-5	205.0	400	400	2
MR9A	0261-5	261.0	500	500	2
	0310-5	310.0	600	630	2
MR9B	0386-5	385.0	2 x 350	2 x 400	4
MR10	0385-5	385.0	2 x 350	2 x 400	4
	0460-5	460.0	2 x 500	2 x 500	4
	0520-5	520.0	2 x 500	2 x 500	4
	0590-5	590.0	2 x 600	2 x 600	4
MR11	0651-5	650.0	4 x 350	4 x 400	8
	0731-5	730.0	4 x 400	4 x 400	8

Table 7. Recommended fuse sizes, Mains voltage 3AC 380–480/500 V, 50/60 Hz, up to 800 V in V DC

Enclosure size	AC drive type VACON0100-3L-	Rated continuous current [A]	IEC60269-6 Fuse size [A]	UL-2579 Fuse size [A]	Total number of fuses
MR12	0650-5	650.0	4 x 350	4 x 400	8
	0730-5	730.0	4 x 400	4 x 400	8
	0820-5	820.0	4 x 400	4 x 500	8
	0920-5	920.0	4 x 500	4 x 500	8
	1040-5	1040.0	4 x 600	4 x 600	8
	1180-5	1180.0	4 x 600	4 x 630	8

3.6 MANUFACTURERS OF gPV FUSES

Recommended manufacturers of gPV type fuses:

- Littelfuse
- Siba
- Bussmann
- Mersen
- ETI
- DF Electric

3.7 PARALLEL DIODE SELECTION

When VACON® 100 X (MM4–MM6) or VACON® 100 INDUSTRIAL (MR5–MR12) is used in the Solar Pump application, a diode must be connected between DC+ and DC- to protect the inverter against reverse voltage. See tables below for diode specification.

Table 8. Diode specification, Mains voltage 3AC 208–240 V, 50/60 Hz, up to 400 V in V DC

AC drive		Diode specifications		
Enclosure size	AC drive type VACON0100-3L-	min. IFav [A]	Min. Voltage rating [V]	Max. Vf [V] @ IFav [A]
MM4	0007-2-X	15	1200	1.5
	0008-2-X	18		
	0011-2-X	25		
	0012-2-X	28		
MM5	0018-2-X	40		
	0024-2-X	54		
	0031-2-X	70		
MM6	0048-2-X	110		
	0062-2-X	140		
MR5	0018-2	50		
	0024-2	63		
	0031-2	80		
MR6	0048-2	125		
	0062-2	160		
MR7	0075-2	200		
	0088-2	250		
	0105-2	250		
MR8	0140-2	400		
	0170-2	500		
	0205-2	500		
MR9A	0261-2	625		
	0310-2	800		

Table 9. Diode specification, Mains voltage 3AC 380–480/500 V, 50/60 Hz, up to 800 V in V DC

AC drive		Diode specifications		
Enclosure size	AC drive type VACON0100-3L-	min. IFav [A]	Min. Voltage rating [V]	Max. Vf [V] @ IFav [A]
MM4	0003-5-X	8	1200	1.5
	0004-5-X	12		
	0005-5-X	12		
	0008-5-X	18		
	0009-5-X	22		
	0012-5-X	28		
MM5	0016-5-X	36		
	0023-5-X	50		
	0031-5-X	70		
MM6	0038-5-X	85		
	0046-5-X	100		
	0061-5-X	140		
	0072-5-X	160		
MR5	0016-5	40	1200	1.5
	0023-5	63		
	0031-5	80		
MR6	0038-5	100		
	0046-5	125		
	0061-5	160		
MR7	0072-5	200		
	0087-5	250		
	0105-5	250		
MR8	0140-5	400		
	0170-5	500		
	0205-5	500		
MR9A	0261-5	625		
	0310-5	800		
MR9B	0386-5	1000		
MR10	0385-5	1000		
	0460-5	1250		
	0520-5	1250		
	0590-5	1500		
MR11	0651-5	2 x 1000		
	0731-5	2 x 1000		

Table 9. Diode specification, Mains voltage 3AC 380–480/500 V, 50/60 Hz, up to 800 V in V DC

AC drive		Diode specifications		
Enclosure size	AC drive type VACON0100-3L-	min. IFav [A]	Min. Voltage rating [V]	Max. Vf [V] @ IFav [A]
MR12	0650-5	2 x 1000	1200	1.5
	0730-5	2 x 1000		
	0820-5	2 x 1250		
	0920-5	2 x 1250		
	1040-5	2 x 1500		
	1180-5	2 x 1575		

3.8 PHOTOVOLTAIC SYSTEM DIMENSIONING

The photovoltaic system has to be dimensioned in order to not exceed the values specified in the tables below. The VACON® 100 X enclosure sizes are MM4-MM6, and VACON® 100 INDUSTRIAL enclosure sizes are MR5–MR12.

Non-isolated inverters must be used with PV modules that have an IEC 61730 Class A rating.

Table 10. AC drive (208–240 V 3AC 50/60 Hz, up to 400 V DC) DC-link input ratings

Enclosure size	AC drive type VACON0100-3L-	DC supply [V DC]	Max. Recommended PV Array Power [kW]	V _{max} PVa (absolute maximum) [V DC]	PV input operating voltage range [V DC]	Maximum operating PV input current [A DC]				
MM4	0007-2-X	234-400 No tolerance permissible, 0%	2.2	400	234-400	7.0				
	0008-2-X		3.0	400	234-400	9.0				
	0011-2-X		4.4	400	234-400	12.0				
	0012-2-X		6.0	400	234-400	14.0				
MM5	0018-2-X		234-400 No tolerance permissible, 0%	8.0	400	234-400	20.0			
	0024-2-X			11.0	400	234-400	27.0			
	0031-2-X			15.0	400	234-400	35.0			
MM6	0048-2-X			234-400 No tolerance permissible, 0%	22.0	400	234-400	54.0		
	0062-2-X				30.0	400	234-400	69.0		
MR5	0018-2				234-400 No tolerance permissible, 0%	8.0	400	234-400	20.0	
	0024-2					11.0	400	234-400	27.0	
	0031-2					15.0	400	234-400	35.0	
MR6	0048-2	234-400 No tolerance permissible, 0%				22.0	400	234-400	54.0	
	0062-2					30.0	400	234-400	71.0	
MR7	0075-2					234-400 No tolerance permissible, 0%	37.0	400	234-400	85.0
	0088-2						44.0	400	234-400	101.0
	0105-2		60.0				400	234-400	121.0	
MR8	0140-2		234-400 No tolerance permissible, 0%				74.0	400	234-400	161.0
	0170-2						90.0	400	234-400	198.0
	0205-2			110.0			400	234-400	239.0	
MR9A	0261-2			234-400 No tolerance permissible, 0%			150.0	400	234-400	304.0
	0310-2				180.0		400	234-400	361.0	

Table 11. AC drive (380–480/500 V 3AC 50/60Hz, up to 800 V DC) DC-link input ratings

Enclosure size	AC drive type VACON0100-3L-	DC supply [V DC]	Max. Recommended PV Array Power [kW]	V _{max} PVa (absolute maximum) [V DC]	PV input operating voltage range [V DC]	Maximum operating PV input current [A DC]
MM4	0003-5-X	300/436*-800 No tolerance permissible, 0%	2.2	800	300/436*-800	4.0
	0004-5-X		3.0	800	300/436*-800	5.0
	0005-5-X		4.4	800	300/436*-800	6.0
	0008-5-X		6.0	800	300/436*-800	9.0
	0009-5-X		8.0	800	300/436*-800	11.0
	0012-5-X		11.0	800	300/436*-800	13.0
MM5	0016-5-X		15.0	800	300/436*-800	18.0
	0023-5-X		22.0	800	300/436*-800	26.0
	0031-5-X		30.0	800	300/436*-800	34.0
MM6	0038-5-X		37.0	800	300/436*-800	42.0
	0046-5-X		44.0	800	300/436*-800	51.0
	0061-5-X		60.0	800	300/436*-800	68.0
	0072-5-X	74.0	800	300/436*-800	80.0	

Table 11. AC drive (380–480/500 V 3AC 50/60Hz, up to 800 V DC) DC-link input ratings

Enclosure size	AC drive type VACON0100-3L-	DC supply [V DC]	Max. Recommended PV Array Power [kW]	V _{max} PVa (absolute maximum) [V DC]	PV input operating voltage range [V DC]	Maximum operating PV input current [A DC]
MR5	0016-5	436-800 No tolerance permissible, 0%	15.0	800	436-800	18.0
	0023-5		22.0	800	436-800	26.0
	0031-5		30.0	800	436-800	35.0
MR6	0038-5		37.0	800	436-800	43.0
	0046-5		44.0	800	436-800	52.0
	0061-5		60.0	800	436-800	69.0
MR7	0072-5		74.0	800	436-800	82.0
	0087-5		90.0	800	436-800	100.0
	0105-5		110.0	800	436-800	121.0
MR8	0140-5		150.0	800	436-800	161.0
	0170-5		180.0	800	436-800	198.0
	0205-5		220.0	800	436-800	239.0
MR9A	0261-5		264.0	800	436-800	304.0
	0310-5		320.0	800	436-800	361.0
MR9B	0386-5		400.0	800	436-800	454.0
MR10	0385-5	500.0	800	436-800	542.0	
	0460-5	500.0	800	436-800	613.0	
	0520-5	630.0	800	436-800	695.0	
MR11	0590-5	710.0	800	436-800	766.0	
	0651-5	800.0	800	436-800	860.0	
MR12	0731-5	900.0	800	436-800	966.0	
	0650-5	1000.0	800	436-800	1084.0	
	0730-5	1120.0	800	436-800	1225.0	
	0820-5	1260.0	800	436-800	1390.0	

* The minimum value is 300 V when the application version is AMIT1181_V205 and the drive is manufactured after June 2019.

3.9 POWER RATINGS

Table 12. AC drive (208–240 V 3AC 50/60 Hz, up to 400 V DC) output ratings

Enclosure size	AC drive type VACON0100-3L-	Voltage (nominal or range) [V AC]	Current (maximum continuous) [A AC]	Current (inrush) [A AC] (2 s)	Frequency (nominal or range) [Hz]	Power (maximum continuous) [W] (230 V)	Power factor range	Max. output fault current [A AC]	Max. output over current protection [A AC]
MM4	0007-2-X	0-240	6.6	13.2	0-320	1100	0.3-1	19.9	19.9
	0008-2-X	0-240	8.0	16.0	0-320	1500	0.3-1	26.3	26.3
	0011-2-X	0-240	11.0	22.0	0-320	2200	0.3-1	33.1	33.1
	0012-2-X	0-240	12.5	25.0	0-320	3000	0.3-1	39.8	39.8
MM5	0018-2-X	0-240	18.0	36.0	0-320	4000	0.3-1	72.3	72.3
	0024-2-X	0-240	24.2	48.4	0-320	5500	0.3-1	72.3	72.3
	0031-2-X	0-240	31.0	62.0	0-320	7500	0.3-1	91.1	91.1
MM6	0048-2-X	0-240	48.0	96.0	0-320	11000	0.3-1	154.3	154.3
	0062-2-X	0-240	62.0	124.0	0-320	15000	0.3-1	185.7	185.7
MR5	0018-2	0-240	18.0	25.0	0-320	4000	0.3-1	50.0	50.0
	0024-2	0-240	24.0	36.0	0-320	5500	0.3-1	72.0	72.0
	0031-2	0-240	31.0	46.0	0-320	7500	0.3-1	100.0	100.0
MR6	0048-2	0-240	48.0	62.0	0-320	11000	0.3-1	124.0	124.0
	0062-2	0-240	62.0	96.0	0-320	15000	0.3-1	192.0	192.0
MR7	0075-2	0-240	75.0	124.0	0-320	18500	0.3-1	248.0	248.0
	0088-2	0-240	88.0	150.0	0-320	22000	0.3-1	300.0	300.0
	0105-2	0-240	105.0	176.0	0-320	30000	0.3-1	352.0	352.0
MR8	0140-2	0-240	140.0	210.0	0-320	37000	0.3-1	456.0	456.0
	0170-2	0-240	170.0	280.0	0-320	45000	0.3-1	560.0	560.0
	0205-2	0-240	205.0	340.0	0-320	55000	0.3-1	680.0	680.0
MR9A	0261-2	0-240	261.0	410.0	0-320	75000	0.3-1	844.0	844.0
	0310-2	0-240	310.0	502.0	0-320	90000	0.3-1	1004.0	1004.0

Table 13. AC drive (380–480/500 V 3AC 50/60 Hz, up to 800 V in VDC) output ratings

Enclosure size	AC drive type VACON0100-3L-	Voltage (nominal or range) [V AC]	Current (maximum continuous) [A AC]	Current (inrush) [A AC] (2 s)	Frequency (nominal or range) [Hz]	Power (maximum continuous) [W] (400 V)	Power factor range	Max. output fault current [A AC]	Max. output over current protection [A AC]
MM4	0003-5-X	0-500	3.4	6.8	0-320	1100	0.3-1	13.1	13.1
	0004-5-X	0-500	4.8	9.6	0-320	1500	0.3-1	16.6	16.6
	0005-5-X	0-500	5.6	11.2	0-320	2200	0.3-1	19.9	19.9
	0008-5-X	0-500	8.0	16.0	0-320	3000	0.3-1	26.3	26.3
	0009-5-X	0-500	9.6	19.2	0-320	4000	0.3-1	33.1	33.1
	0012-5-X	0-500	12.0	24.0	0-320	5500	0.3-1	39.8	39.8
MM5	0016-5-X	0-500	16.0	32.0	0-320	7500	0.3-1	51.0	51.0
	0023-5-X	0-500	23.0	46.0	0-320	11000	0.3-1	72.3	72.3
	0031-5-X	0-500	31.0	62.0	0-320	15000	0.3-1	91.1	91.1
MM6	0038-5-X	0-500	38.0	76.0	0-320	18500	0.3-1	122.5	122.5
	0046-5-X	0-500	46.0	92.0	0-320	22000	0.3-1	154.3	154.3
	0061-5-X	0-500	61.0	122.0	0-320	30000	0.3-1	185.7	185.7
	0072-5-X	0-500	72.0	108.0	0-320	37000	0.3-1	185.7	185.7
MR5	0016-5	0-500	16.0	24.0	0-320	7500	0.3-1	48.0	48.0
	0023-5	0-500	23.0	32.0	0-320	11000	0.3-1	64.0	64.0
	0031-5	0-500	31.0	46.0	0-320	15000	0.3-1	92.0	92.0
MR6	0038-5	0-500	38.0	62.0	0-320	18500	0.3-1	124.0	124.0
	0046-5	0-500	46.0	76.0	0-320	22000	0.3-1	152.0	152.0
	0061-5	0-500	61.0	92.0	0-320	30000	0.3-1	184.0	184.0
MR7	0072-5	0-500	72.0	122.0	0-320	37000	0.3-1	244.0	244.0
	0087-5	0-500	87.0	144.0	0-320	45000	0.3-1	288.0	288.0
	0105-5	0-500	105.0	174.0	0-320	55000	0.3-1	348.0	348.0
MR8	0140-5	0-500	140.0	210.0	0-320	75000	0.3-1	420.0	420.0
	0170-5	0-500	170.0	280.0	0-320	90000	0.3-1	560.0	560.0
	0205-5	0-500	205.0	340.0	0-320	110000	0.3-1	680.0	680.0
MR9A	0261-5	0-500	261.0	410.0	0-320	132000	0.3-1	820.0	820.0
	0310-5	0-500	310.0	502.0	0-320	160000	0.3-1	1004.0	1004.0
MR9B	0386-5	0-500	385.0	620.0	0-320	200000	0.3-1	1240.0	1240.0
MR10	0385-5	0-500	460.0	770.0	0-320	250000	0.3-1	1540.0	1540.0
	0460-5	0-500	520.0	920.0	0-320	250000	0.3-1	1840.0	1840.0
	0520-5	0-500	590.0	1040.0	0-320	315000	0.3-1	2080.0	2080.0
MR11	0590-5	0-500	650.0	1180.0	0-320	355000	0.3-1	2360.0	2360.0
	0651-5	0-500	730.0	1300.0	0-320	400000	0.3-1	2600.0	2600.0
MR12	0731-5	0-500	820.0	1460.0	0-320	450000	0.3-1	2920.0	2920.0
	0650-5	0-500	920.0	1640.0	0-320	500000	0.3-1	3280.0	3280.0
	0730-5	0-500	1040.0	1840.0	0-320	560000	0.3-1	3680.0	3680.0
	0820-5	0-500	1180.0	1840.0	0-320	630000	0.3-1	3680.0	3680.0

3.10 GROUNDING

3.10.1 POLE GROUNDING

It is prohibited to connect any pole, DC+ or DC-, of the photovoltaic system directly to PE.

3.10.2 DRIVE GROUNDING

All non-current-carrying metal parts (module frames, enclosures) and also the midpoint of the current carrying conductors of the photovoltaic system must be connected to the PE of the drive.

3.10.3 EARTH FAULT ALARM

The earth fault can be retrieved through:

- drive keypad
- fieldbus communication
- relay output

Select one of these methods to provide a fault or alarm, in accordance with the requirements of AS/NZS 5033.

3.11 AC GRID OR GENERATOR CONNECTION



WARNING! AC grid connection is not permitted in Australia. Only generator supply used alongside solar PV is suitable for products installed in Australia.

3.11.1 MORE THAN ONE SOURCE OF SUPPLY

It is not recommended to supply the drive simultaneously from the photovoltaic cell and from AC grid or generator.

3.11.2 TOGGLE BETWEEN AC AND DC

If both the DC input and the AC input are used (for example, when the energy from the photovoltaic system is not sufficient), it is not allowed to switch directly between AC and DC supply. When switching from one supply to the other, it is mandatory to wait until the drive is discharged.

The minimum AC-DC switchover delay is 30 s for VACON® 100 X MM4–MM6 and VACON® 100 MR5–MR6.

The minimum AC-DC switchover delay is 60 s for VACON® 100 MR7–MR12.



DANGER! To completely isolate the equipment, use a two-pole disconnect switch for the photovoltaic input (suitable for DC) and for the AC grid or generator input (AC switch). Only one of these switches is allowed to be on at a time. The delay time must be respected when changing from one switch to the other. Failure to follow these instructions can lead to death or serious injury.



DANGER! If it is necessary to connect the drive simultaneously on AC and DC supply, note that if the AC supply is lost, the drive must be separated from the AC supply grid or generator. Failure to follow these instructions can lead to death or serious injury.

3.11.3 DUAL SUPPLY FUNCTIONALITY

Sometimes a back up from the AC mains is needed in case the power from the photovoltaic supply is not enough, for example, during night time and cloudy weather. The connection can be created in several different ways. In this chapter, three alternative solutions are described.

Common safety related topic in every solution is to make sure that in case of possible malfunction of drive there is no DC voltage connected into AC side. DC voltage from photovoltaic system can

make AC supply side parts energized having dangerous voltage, in case AC power is down. DC voltage can go very far distance wise into AC side, as far as galvanically possible. This can be very dangerous especially during AC grid or generator service. System must have a way to prevent this happening.

3.11.3.1 Changeover switch

Using a manually operated changeover switch is the most recommended way to make the switchover between AC and DC supply. In this case, a digital input can be programmed to select normal reference when using AC supply or MPPT when using DC supply. The changeover switch must have a potential free auxiliary contact. See parameter P3.5.1.53 Mains Supply On. In case of a failure, the changeover switch also prevents the DC voltage from going into the AC side.

3.11.3.2 AC and DC connected simultaneously without control

In this case, there is no possibility to have any control if AC or DC supply is used for energy source. Supply always comes automatically from the source where the voltage is higher. Therefore, photovoltaic dimensioning is very critical. In addition to that, a blocking diode on the DC side is needed to protect solar panels in case their voltage is low. On the AC side, function of the blocking diode is made by drive rectifier diodes. However, in case of malfunction of rectifier diodes also electromechanics separation is needed in case AC supply goes down. It is mandatory to separate the drive from AC supply in case of power down. There are different methods to make the separation. See one example in chapter 3.8.3.3.

3.11.3.3 Automatic Dual supply control

This functionality can be used by activating the drive relay output to control additional contactor on the AC supply side. See the related programming in chapter 7.2.23.3. The functionality can have three different operation modes:

0 - Always active (supply from AC and DC used together)

Works in the same way as described in chapter 3.8.3.2, but AC supply is only used when the drive is at Run state.

1 - Closed loop Irradiation

Controls the AC supply contactor based on irradiation measurement on analog input.

2 - Closed loop Sensorless

Controls the AC supply contactor based on periodic PV capacity checks.

In this case, the AC contactor can also be used to separate the drive from mains automatically when the AC supply goes down. For this, it is mandatory to have a separate control relay on the AC side to detect supply voltage. This relay can be used to force contactor to switch off. The contactor auxiliary contact should be connected into the drive digital input configured in P3.5.1.60, to tell contactor status.

3.11.3.4 Power up and shut down procedure

For powering up, follow this procedure:

1. Turn on the DC switches between the PV supply and the inverter.
2. Turn on the AC switch between the inverter and the load, if applicable.

For the shut down procedure, follow the steps in reverse order.

3.11.4 OVERVOLTAGE CATEGORY

The overvoltage category of the AC drive is Category III.

3.12 EXTERNAL +24 V SUPPLY

Using external supply can be used to keep control energized when mains power is down. System software version FW0072V030 or newer should be used.

3.13 DC POWER CONNECTION

The external DC switch must comply with Australian regulations, particularly with AS 60947.3:2018.

3.13.1 VACON® 100 X DRIVES

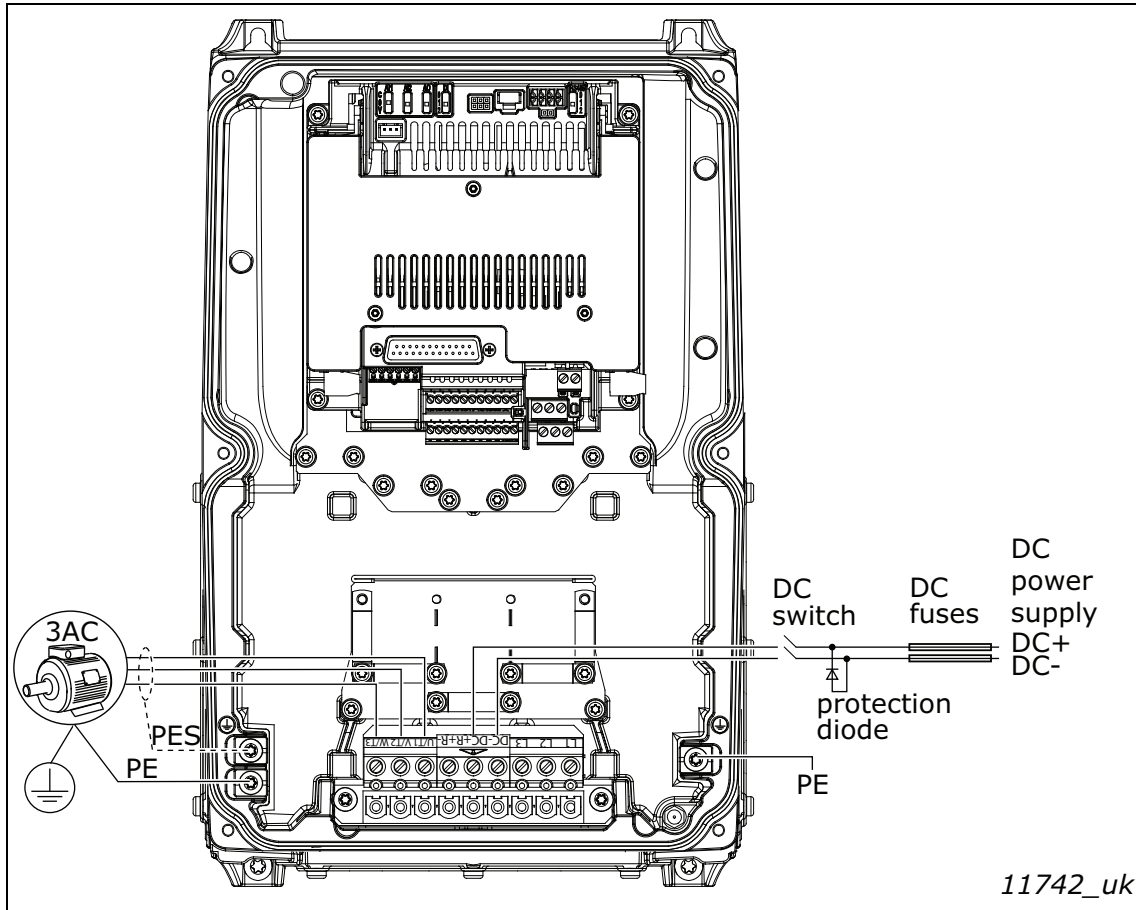

Figure 4. Example of the power connections: MM4/MM5

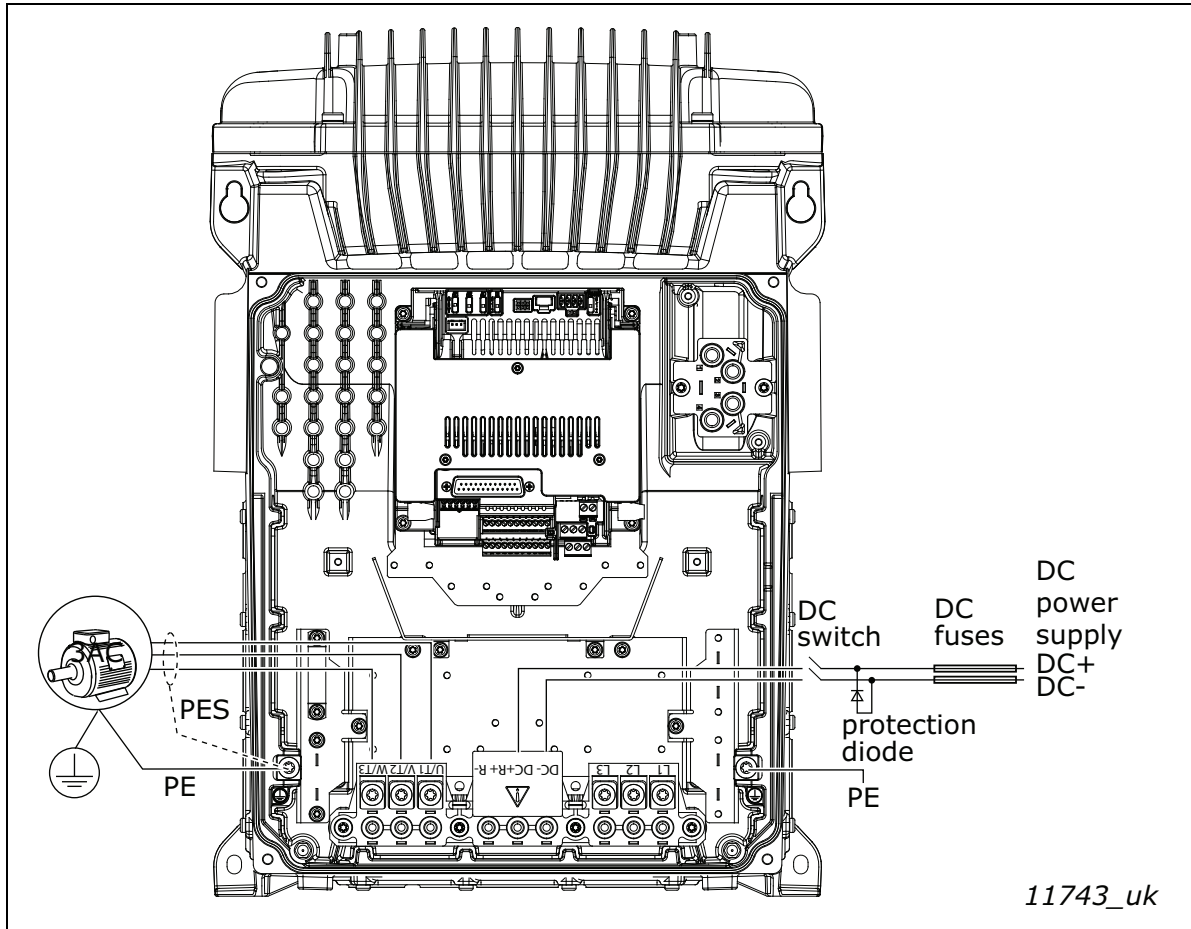

Figure 5. Example of the power connections: MM6

3.13.2 VACON® 100 INDUSTRIAL DRIVES

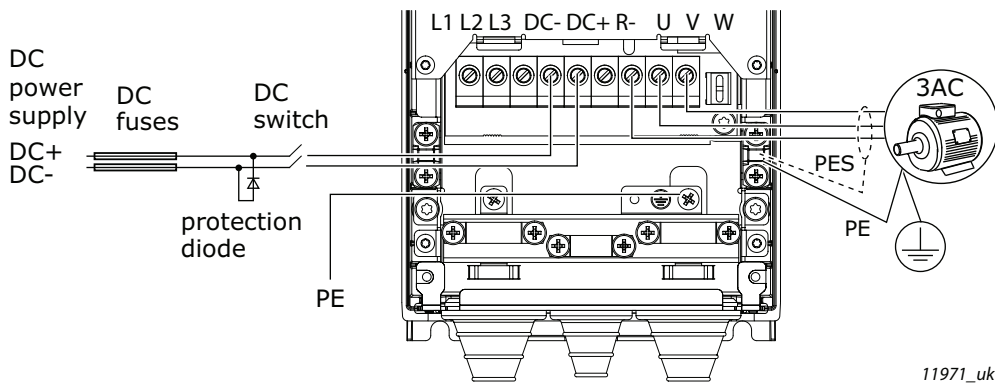
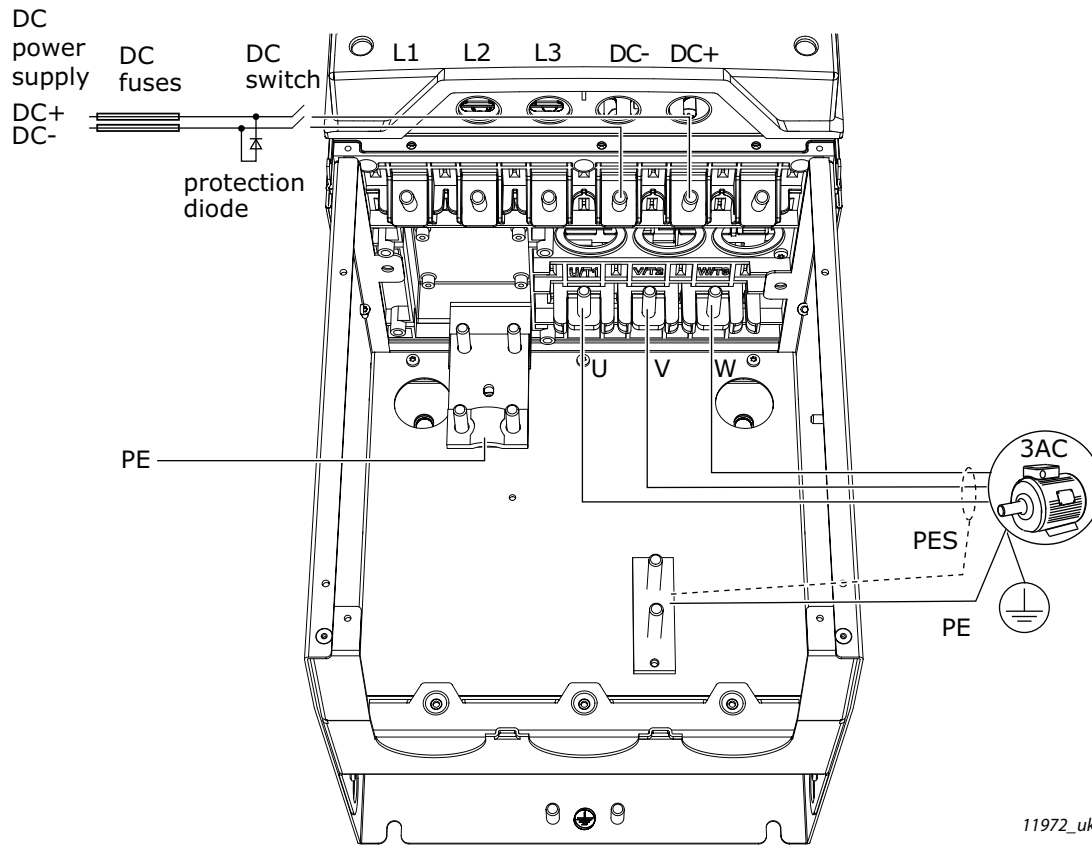
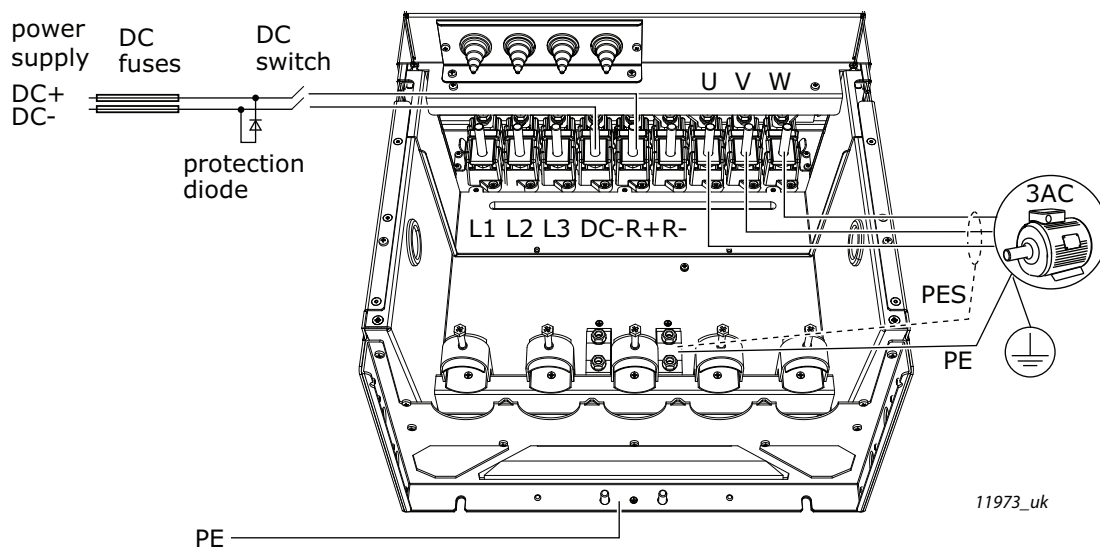

Figure 6. Example of the power connections: MR5-MR7



11972_uk

Figure 7. Example of the power connections: MR8



11973_uk

Figure 8. Example of the power connections: MR9

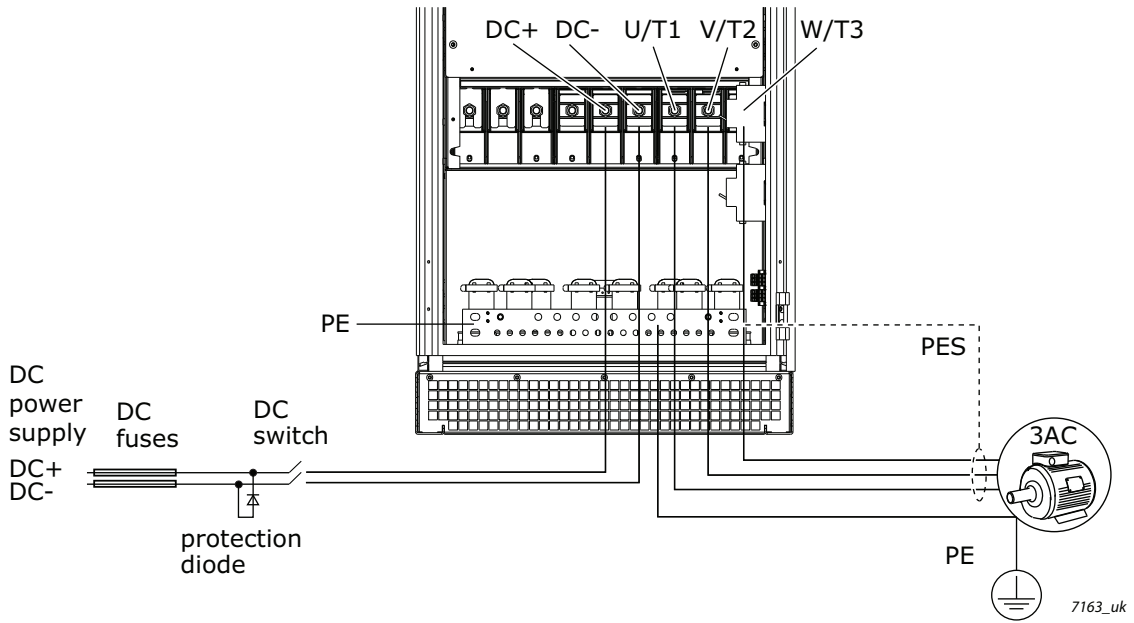

Figure 9. Example of the power connections: MR10 without extension box

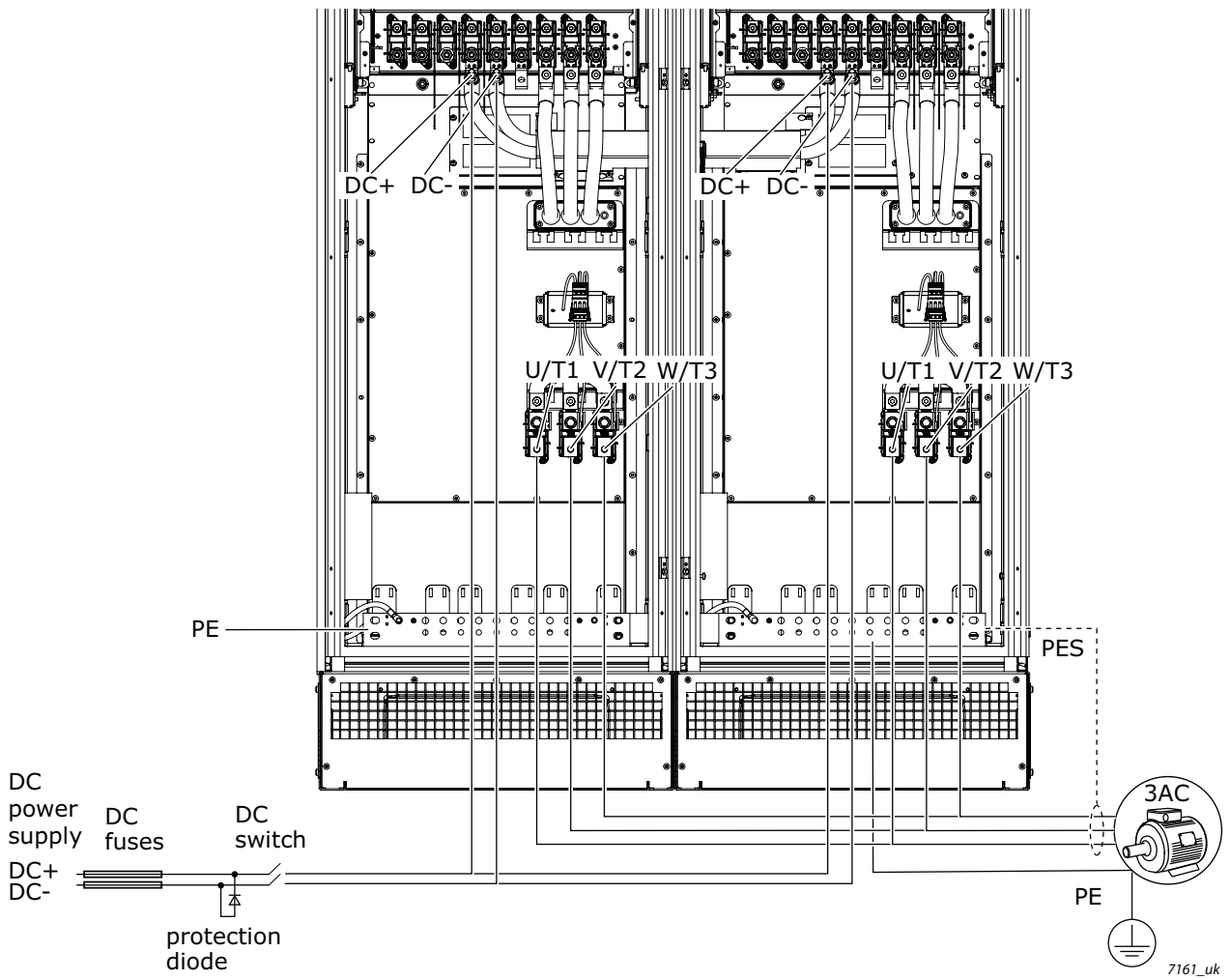

Figure 10. Example of the power connections: MR11 without extension box

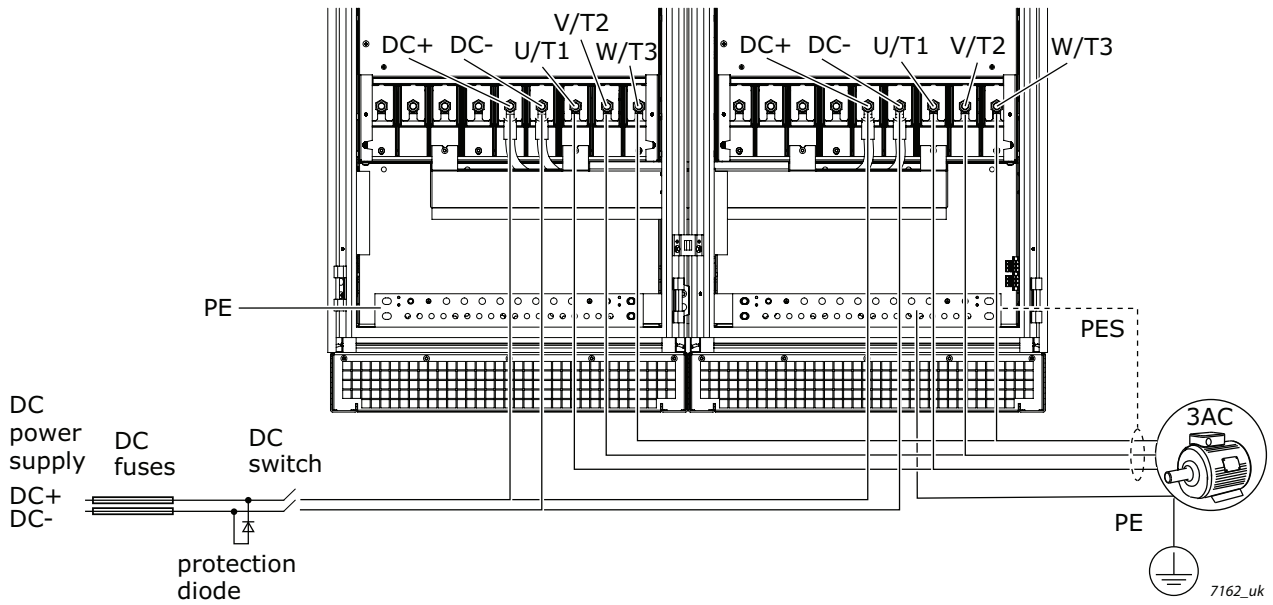

Figure 11. Example of the power connections: MR12 without extension box

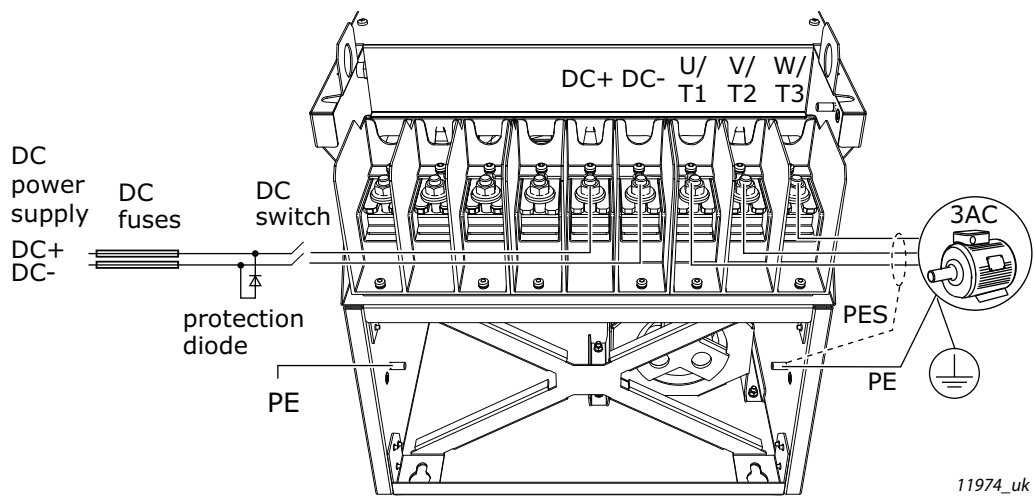

Figure 12. Example of the power connections: MR10 and MR12 with extension box

4. STARTUP

4.1 FIRST STARTUP

In the *Startup Wizard*, you will be prompted for essential information needed by the drive so that it can start controlling your process. In the Wizard, you will need the following keypad buttons:



Left/Right arrows. Use these to easily move between digits and decimals.



Up/Down arrows. Use these to move between options in menu and to change value.



OK button. Confirm selection with this button.



Back/Reset button. Pressing this button, you can return to the previous question in the Wizard. If pressed at the first question, the Startup Wizard will be canceled.

Once you have connected power to your VACON® 100 AC drive, follow these instructions to easily set up your drive.

NOTE: You can have your AC drive equipped with a keypad with either a graphical or a text keypad.

1	Language selection (P6.1)	Depends on language package
----------	---------------------------	-----------------------------

2	Daylight saving* (P5.5.5)	Russia US EU OFF
3	Time* (P5.5.2)	hh:mm:ss
4	Year* (P5.5.4)	yyyy
5	Date* (P5.5.3)	dd.mm.

* These questions appear if battery is installed

6	Run Startup Wizard?	Yes No
----------	---------------------	-----------

Push the OK button unless you want to set all parameter values manually.

7	Make a selection of an application (P1.2 Application, ID212)	Standard Local/Remote Multi-step speed PID control Multi-purpose Motor potentiometer
8	Set a value for P3.1.2.2 Motor Type (so that it agrees with the nameplate)	PM motor Induction motor
9	Set value for <i>P3.1.1.1 Motor Nom Voltg</i> (according to nameplate)	<i>Range: Varies</i>
10	Set value for <i>P3.1.1.2 Motor Nom Freq</i> (according to nameplate)	8.00...320.00 Hz
11	Set value for <i>P3.1.1.3 Motor Nom Speed</i> (according to nameplate)	<i>Range: 24...19.200 rpm</i>
12	Set value for <i>P3.1.1.4 Motor Nom Currnt</i> (according to nameplate)	<i>Range: Varies</i>
13	Set value for <i>P3.1.1.5 Motor Cos Phi</i> (according to nameplate)	<i>Range: 0.30...1.00</i>
14	Set value for <i>P3.3.1.1 Minimum frequency reference</i>	<i>Range: 0.00...50.00 Hz</i>
15	Set value for <i>P3.3.1.2 MaxFreqReference</i>	<i>Range: 0.00...320.00 Hz</i>
16	Set value for <i>P3.4.1.2 Accel Time 1</i>	<i>Range: 0.1...300.0 s</i>
17	Set value for <i>P3.4.1.3 Decel Time 1</i>	<i>Range: 0.1...300.0 s</i>

If you set Motor Type to Induction Motor, you see the next question. If your selection is PM Motor, the value of parameter P3.1.1.5 Motor Cos Phi is set to 1.00 and the wizard goes directly to question 18.

18	Set value for <i>P3.3.1.1 MinFreqReference</i>	<i>Range: 0.00...50.00 Hz</i>
19	Set value for <i>P3.3.1.2 MaxFreqReference</i>	<i>Range: 0.00...320.00 Hz</i>
20	Set value for <i>P3.4.1.2 Accel Time 1</i>	<i>Range: 0.1...300.0 s</i>
21	Set value for <i>P3.4.1.3 Decel Time 1</i>	<i>Range: 0.1...300.0 s</i>

22	Run the Application wizard?	Yes
		No

To continue to the application wizard, set the selection to Yes and push the OK button.

After these selections, the Start-up wizard is completed. To start the Start-up wizard again, you have 2 alternatives. Go to the parameter P6.5.1 Restore Factory Defaults or to the parameter B1.1.2 Start-up Wizard. Then set the value to Activate.

4.2 DESCRIPTION OF THE APPLICATIONS

Use the parameter P1.2 (Application) to make a selection of an application for the drive. Immediately when the parameter P1.2 changes, a group of parameters get their preset values.

4.2.1 M1 QUICK SETUP PARAMETER GROUP

In the Quick Setup parameter group you will find the different wizards of the VACON® 100 X Solar Pump Application. The wizards help you to quickly set up your drive for use prompting you for a number of essential data.

Table 14. Quick setup parameter group

Code	Parameter	Min	Max	Unit	Default	ID	Description
B1.1	Startup wizard	0	1		0	1170	0 = Do not activate 1 = Activate Choosing <i>Activate</i> initiates the Startup Wizard (see chapter 4.1).
P1.2	Application	0	5		0	212	0 = Standard 1 = Local/Remote 2 = Multi-Step Speed 3 = PID Control 4 = Multi-Purpose 5 = Motor Potentiometer
P1.3	MinFreqReference	0.00	P1.4	Hz	0.00	101	Minimum allowed frequency reference
P1.4	MaxFreqReference	P1.3	320.00	Hz	50.00	102	Maximum allowed frequency reference
P1.5	Accel Time 1	0.1	300.0	s	5.0	103	Defines the time required for the output frequency to increase from zero frequency to maximum frequency
P1.6	Decel Time 1	0.1	300.0	s	5.0	104	Defines the time required for the output frequency to decrease from maximum frequency to zero frequency
P1.7	Current limit	Varies	Varies	A	Varies	107	Maximum motor current from AC drive
P1.8	Motor type	0	1		0	650	0 = Induction motor 1 = PM motor
P1.9	Motor Nom Voltg	Varies	Varies	V	Varies	110	Find this value U_n on the rating plate of the motor. Note also used connection (Delta/Star).
P1.10	Motor Nom Freq	8.00	320.00	Hz	Varies	111	Find this value f_n on the rating plate of the motor.
P1.11	Motor Nom Speed	24	19200	rpm	Varies	112	Find this value n_n on the rating plate of the motor.
P1.12	Motor Nom Currnt	Varies	Varies	A	Varies	113	Find this value I_n on the rating plate of the motor.
P1.13	Motor Cos Phi	0.30	1.00		0.74	120	Find this value on the rating plate of the motor

Table 14. Quick setup parameter group

P1.14	Energy optimization	0	1		0	666	The drive searches for the minimum motor current in order to save energy and to lower the motor noise. This function can be used e.g. in fan and pump applications 0 = Disabled 1 = Enabled
P1.15	Identification	0	1		0	631	The identification run calculates or measures the motor parameters that are necessary for a good control of the motor and speed. 0 = No action 1 = At standstill 2 = With rotation Before you do the identification run, you must set the motor nameplate parameters.
P1.16	Start function	0	1		0	505	0=Ramping 1=Flying start
P1.17	Stop function	0	1		0	506	0=Coasting 1=Ramping
P1.18	Automatic reset	0	1		0	731	0 = Disabled 1 = Enabled
P1.19	External fault	0	3		2	701	0 = No action 1 = Alarm 2 = Fault (Stop according to stop mode) 3 = Fault (Stop by coasting)
P1.20	AI Low Fault	0	5		0	700	Response when an analogue signal in use goes below 50% of the minimum signal range. 0 = No action 1 = Alarm 2 = Alarm, Preset Freq 3 = Alarm, Previous Freq 4 = Fault (Stop according to stop mode) 5 = Fault (Stop by coasting)
P1.21	Rem.Ctrl. Place	0	1		0	172	Selection of remote control place (start/stop). Can be used to change back to remote control from VACON® Live e.g. in case of a broken panel. 0=I/O control 1=Fieldbus control
P1.22	I/O A Ref sel	1	9		5	117	Selection of ref source when control place is I/O A 1 = Preset Frequency 0 2 = Keypad reference 3 = Fieldbus 4 = AI1 5 = AI2 6 = AI1+AI2 7 = PID reference 8 = Motor potentiometer 9 = Max Power

Table 14. Quick setup parameter group

P1.23	Keypad Ref sel	1	9		2	121	Selection of ref source when control place is keypad: See P1.22
P1.24	Fieldbus Ref sel	1	9		3	122	Selection of ref source when control place is Fieldbus: See P1.22
P1.25	AI1 signal range	0	1		0	379	0 = 0...10 V / 0...20 mA 1 = 2...10 V / 4...20 mA
P1.26	AI2 signal range	0	1		1	390	0 = 0...10 V / 0...20 mA 1 = 2...10 V / 4...20 mA

Table 14. Quick setup parameter group

P1.27	R01 function	0	60		2	11001	Function selection for Basic R01: 0 = None 1 = Ready 2 = Run 3 = General fault 4 = General fault inverted 5 = General alarm 6 = Reversed 7 = At speed 8 = Thermistor fault 9 = Motor regulator active 10 = Start signal active 11 = Keypad control active 12 = I/O B control activated 13 = Limit supervision 1 14 = Limit supervision 2 15 = SinglePowerOn 16 = No function 17 = Preset speed active 18 = No function 19 = PID in Sleep mode 20 = PID soft fill active 21 = PID supervision limits 22 = Ext. PID superv. limits 23 = Input press. alarm/fault 24 = Frost prot. alarm/fault 25 - 30 = No function 31 = RTC time chnl 1 control 32 = RTC time chnl 2 control 33 = RTC time chnl 3 control 34 = FB ControlWord B13 35 = FB ControlWord B14 36 = FB ControlWord B15 37 = FB ProcessData1.B0 38 = FB ProcessData1.B1 39 = FB ProcessData1.B2 40 = Maintenance alarm 41 = Maintenance fault 42 = No function 43 = No function 44 = Block Out.1 45 = Block Out.2 46 = Block Out.3 47 = Block Out.4 48 = Block Out.5 49 = Block Out.6 50 = Block Out.7 51 = Block Out.8 52 = Block Out.9 53 = Block Out.10 54 = No function 55 = No function 56 = Auto-cleaning active 57 = Motor Switch Open 58 = TEST (Always Closed) 59 = No function 60 = DualSupply AC switch
P1.28	Basic R02 function	0	46		3	11004	See P1.27

Table 14. Quick setup parameter group

P1.30	A01 function	0	19	2	10050	0=TEST 0% (Not used) 1=TEST 100% 2=Output freq (0 -fmax) 3=Freq reference (0-fmax) 4=Motor speed (0 - Motor nominal speed) 5=Output current (0-I _{nMotor}) 6=Motor torque (0-T _{nMotor}) 7=Motor power (0-P _{nMotor}) 8=Motor voltage (0-U _{nMotor}) 9=DC link voltage (0-1000 V) 10=PID1 output (0-100%) 11=Ext.PID output (0-100%) 12=ProcessDataIn1 (0-100%) 13=ProcessDataIn2 (0-100%) 14=ProcessDataIn3 (0-100%) 15=ProcessDataIn4 (0-100%) 16=ProcessDataIn5 (0-100%) 17=ProcessDataIn6 (0-100%) 18=ProcessDataIn7 (0-100%) 19=ProcessDataIn8 (0-100%)
-------	--------------	---	----	---	-------	---

4.2.2 STANDARD APPLICATION

You can use the Standard application in speed-controlled processes where no special functions are necessary, for example pumps, fans, or conveyors.

It is possible to control the drive from the keypad, Fieldbus or I/O terminal.

When you control the drive with the I/O terminal, the frequency reference signal is connected to AI1 (0...10 V) or AI2 (4...20 mA). The connection depends the type of the signal. There are also 3 preset frequency references available. You can activate the preset frequency references with DI4 and DI5. The start/stop signals of the drive are connected to DI1 (start forward) and DI2 (start reverse).

It is possible to configure all the drive outputs freely in all the applications. There are 1 analogue output (Output Frequency) and 3 relay outputs (Run, Fault, Ready) available on the basic I/O board.

4.2.2.1 M1.31 Standard

Table 15. Standard start-up wizard menu

Code	Parameter	Min	Max	Unit	Default	ID	Description
P1.31.1	Preset Freq 1	P1.3	P1.4	Hz	10.0	105	Make the selection of a preset frequency with the digital input DI4.
P1.31.2	Preset Freq 2	P1.3	P1.4	Hz	15.0	106	Make the selection of a preset frequency with the digital input DI5.
P1.31.3	Preset Freq 3	P1.3	P1.4	Hz	20.0	126	Make the selection of a preset frequency with the digital input DI4 and DI5.

4.2.3 LOCAL/REMOTE APPLICATION

Use the Local/Remote application when, for example, it is necessary to switch between 2 different control places.

To change between the Local and the Remote control place, use DI6. When Remote control is active, you can give the start/stop commands from Fieldbus or from I/O terminal (DI1 and DI2). When Local control is active, you can give the start/stop commands from the keypad, Fieldbus or I/O terminal (DI4 and DI5).

For each control place, you can make a selection of the frequency reference from the keypad, Fieldbus or I/O terminal (AI1 or AI2).

It is possible to configure all the drive outputs freely in all the applications. There are 1 analogue output (Output Frequency) and 3 relay outputs (Run, Fault, Ready) available on the basic I/O board.

4.2.3.1 M1.33 Local/Remote

Table 16. Local/Remote start-up wizard menu

Code	Parameter	Min	Max	Unit	Default	ID	Description
P1.32.1	I/O B Ref sel	1	9		9	131	Selection of ref source when control place is I/O B. See above. NOTE: I/O B control place can only be forced active with digital input (P3.5.1.7).
P1.32.2	I/O B Ctrl force				DigIN SlotA.6	343	TRUE = Used frequency reference is specified by I/O reference B parameter (P3.3.1.6).
P1.32.3	I/O B Ref force				DigIN SlotA.6	411	Force control to fieldbus
P1.32.4	Ctrl signal 1 B				DigIN SlotA.4	423	Start signal 1 when control place is I/O B
P1.32.5	Ctrl signal 2 B				DigIN SlotA.5	424	Start signal 2 when control place is I/O B
P1.32.6	Keypad Ctrl force				DigIN Slot0.1	410	Force control to keypad
P1.32.7	Fieldbus Ctrl force				DigIN Slot0.1	411	Force control to fieldbus
P1.32.8	Ext fault close				DigIN SlotA.3	405	FALSE = OK TRUE = External fault
P1.32.9	Ext fault open				DigIN Slot0.2	406	FALSE = External fault TRUE = OK

4.2.4 MULTI-STEP APPLICATION

You can use the Multi-step speed application with processes where more than 1 fixed frequency reference is necessary (for example test benches).

It is possible to use 1 + 7 frequency references: 1 basic reference (AI1 or AI2) and 7 preset references.

Make a selection of the preset frequency references with digital signals DI4, DI5 and DI6. If none of these inputs are active, the frequency reference is removed from the analogue input (AI1 or AI2). Give the start/stop commands from the I/O terminal (DI1 and DI2).

It is possible to configure all the drive outputs freely in all the applications. There are 1 analogue output (Output Frequency) and 3 relay outputs (Run, Fault, Ready) available on the basic I/O board.

4.2.4.1 M1.33 Multi-step speed

Table 17. Multi-step speed start-up wizard menu

Code	Parameter	Min	Max	Unit	Default	ID	Description
P1.33.1	Preset Freq 1	P1.3	P1.4	Hz	10.0	105	
P1.33.2	Preset Freq 2	P1.3	P1.4	Hz	15.0	106	
P1.33.3	Preset Freq 3	P1.3	P1.4	Hz	20.0	126	
P1.33.4	Preset Freq 4	P1.3	P1.4	Hz	25.0	127	
P1.33.5	Preset Freq 5	P1.3	P1.4	Hz	30.0	128	
P1.33.6	Preset Freq 6	P1.3	P1.4	Hz	40.0	129	
P1.33.7	Preset Freq 7	P1.3	P1.4	Hz	50.0	130	
P1.33.8	PresetFreqMode	0	1		0	182	0 = Binary coded 1 = Number of inputs. Preset frequency is selected according to how many of preset speed digital inputs are active
P1.33.9	Ext fault close				DigIN SlotA.3	405	FALSE = OK TRUE = External fault
P1.33.10	Ext fault open				DigIN Slot0.2	406	FALSE = External fault TRUE = OK

4.2.5 PID CONTROL APPLICATION

You can use the PID control application with processes where you control the process variable (for example pressure) through control of the speed of the motor.

In this application, the internal PID controller of the drive is configured for 1 setpoint and 1 feedback signal.

It is possible to use 2 control places. Make the selection of the control place A or B with DI6. When control place A is active, the start/stop commands are given by DI1, and the PID controller gives the frequency reference. When control place B is active, start/stop commands are given by DI4, and AI1 gives the frequency reference.

It is possible to configure all the drive outputs freely in all the applications. There are 1 analogue output (Output Frequency) and 3 relay outputs (Run, Fault, Ready) available on the basic I/O board.

4.2.5.1 M1.34 PID Control

Table 18. PID Control start-up wizard menu

Code	Parameter	Min	Max	Unit	Default	ID	Description
P1.34.1	Gain	0.00	1000.00	%	100.00	118	If the value of the parameter is set to 100% a change of 10% in the error value causes the controller output to change by 10%.
P1.34.2	Integration Time	0.00	600.00	s	1.00	119	If this parameter is set to 1,00s a change of 10% in the error value causes the controller output to change by 10.00%/s.
P1.34.3	Derivation Time	0.00	100.00	s	0.00	132	If this parameter is set to 1,00s a change of 10% in the error value during 1.00 s causes the controller output to change by 10.00%.

Table 18. PID Control start-up wizard menu

P1.34.4	FB 1 Source	0	20		2	334	<p>0 = Not used 1 = AI1 2 = AI2 3 = AI3 4 = AI4 5 = AI5 6 = AI6 7 = ProcessDataIn1 8 = ProcessDataIn2 9 = ProcessDataIn3 10 = ProcessDataIn4 11 = ProcessDataIn5 12 = ProcessDataIn6 13 = ProcessDataIn7 14 = ProcessDataIn8 15 = Temperature input 1 16 = Temperature input 2 17 = Temperature input 3 18 = Temperature input 4 19 = Temperature input 5 20 = Temperature input 6 AI's and ProcessDataIn are handled as % (0.00-100.00%) and scaled according to Feedback min and max. NOTE: ProcessDataIn use two decimals.</p>
P1.34.5	SP 1 Source	0	22		1	332	<p>0 = Not used 1 = Keypad setpoint 1 2 = Keypad setpoint 2 3 = AI1 4 = AI2 5 = AI3 6 = AI4 7 = AI5 8 = AI6 9 = ProcessDataIn1 10 = ProcessDataIn2 11 = ProcessDataIn3 12 = ProcessDataIn4 13 = ProcessDataIn5 14 = ProcessDataIn6 15 = ProcessDataIn7 16 = ProcessDataIn8 17 = Temperature input 1 18 = Temperature input 2 19 = Temperature input 3 20 = Temperature input 4 21 = Temperature input 5 22 = Temperature input 6 AI's and ProcessDataIn are handled as percent (0.00-100.00%) and scaled according to Setpoint minimum and maximum. NOTE: ProcessDataIn signals use 2 decimals.</p>
P1.34.6	Keypad SP 1	Varies	Varies	Varies	0	167	

Table 18. PID Control start-up wizard menu

P1.34.7	SP 1 Sleep Freq	0.00	320.00	Hz	0.00	1016	Drive goes to sleep mode when the output frequency stays below this limit for a time greater than that defined by parameter <i>Sleep delay</i> .
P1.34.8	SP 1 Sleep Delay	0	3000	s	0	1017	The minimum amount of time the frequency has to remain below the Sleep level before the drive is stopped.
P1.34.9	SP 1 WakeUpLevel			Varies	0.00	1018	Defines the level for the PID feedback value wake-up supervision. Uses selected process units.
P1.34.10	Preset Freq 1	P1.3	P1.4	Hz	10.0	105	Preset Frequency 1

4.2.6 MULTI-PURPOSE APPLICATION

You can use the Multi-purpose application for different processes (for example conveyors) where a wide range of motor control functions is necessary.

It is possible to control the drive from the keypad, Fieldbus or I/O terminal. When you use I/O terminal control, the start/stop commands are given through DI1 and DI2, and the frequency reference from AI1 or AI2.

There are 2 acceleration/deceleration ramps available. The selection between Ramp1 and Ramp2 is made by DI6.

It is possible to configure all the drive outputs freely in all the applications. There are 1 analogue output (Output Frequency) and 3 relay outputs (Run, Fault, Ready) available on the basic I/O board.

4.2.6.1 M1.35 Multi-purpose

Table 19. Multi-purpose start-up wizard menu

Code	Parameter	Min	Max	Unit	Default	ID	Description
P1.35.1	Control mode	0	1		0	600	0 = U/f Freq ctrl open loop 1 = Speed control open loop
P1.35.2	Auto TorqueBoost	0	1		0	109	Automatic torque boost can be used in application where starting torque due to starting friction is high. 0= Disabled 1= Enabled
P1.35.3	Start Acceleration Time	0.1	3000.0	s	2.0	502	Start Acceleration Time
P1.35.5	Preset Freq 1	P1.3	P1.4	Hz	10.0	105	Preset Frequency 1
P1.35.6	U/f ratio	0	2		0	108	Type of U/f curve between zero frequency and the field weakening point. 0=Linear 1=Squared 2=Programmable
P1.35.7	Field WeakngPnt	8.00	P3.3.1.2	Hz	Varies	602	The field weakening point is the output frequency at which the output voltage reaches the field weakening point voltage
P1.35.8	Voltage at FWP	10.00	200.00	%	100.00	603	Voltage at field weakening point in % of motor nominal voltage
P1.35.9	U/f Mid Freq	0.00	P3.1.4.2	Hz	Varies	604	Provided that the programmable U/f curve has been selected (par. P3.1.4.1), this parameter defines the middle point frequency of the curve.
P1.35.10	U/f Mid Voltg	0.0	100.0	%	100.0	605	Provided that the programmable U/f curve has been selected (par. P3.1.4.1), this parameter defines the middle point voltage of the curve.

Table 19. Multi-purpose start-up wizard menu

P1.35.11	Zero Freq Voltg	0.00	40.00	%	Varies	606	This parameter defines the zero frequency voltage of the U/f curve. The default value varies according to unit size.
P1.35.12	StartMagnCurrent	0.00	Varies	A	Varies	517	Defines the DC current fed into motor at start. Disabled if set to 0.
P1.35.13	StartMagnTime	0,00	600,00	s	0,00	516	This parameter defines the time for how long DC current is fed to motor before acceleration starts.
P1.35.14	DC Brake Current	Varies	Varies	A	Varies	507	Defines the current injected into the motor during DC-braking. 0 = Disabled
P1.35.15	DC BrakeTime	0,00	600,00	s	0,00	508	Determines if braking is ON or OFF and the braking time of the DC-brake when the motor is stopping.
P1.35.16	DC Start Freq	0,10	10,00	Hz	1,50	515	The output frequency at which the DC-braking is applied.
P1.35.17	Load drooping	0.00	50.00	%	0.00	620	The drooping function enables speed drop as a function of load. Drooping will be defined in percent of nominal speed at nominal load.
P1.35.18	Load drooping time	0.00	2.00	s	0.00	656	Load drooping is used in order to achieve a dynamic speed drooping because of changing load. This parameter defines the time during which the speed is restored to the level it was before the load increase.
P1.35.19	Load drooping mode	0	1		0	1534	0 = Normal; Load drooping factor is constant through the whole frequency range 1 = Linear removal; Load drooping is removed linearly from nominal frequency to zero frequency

4.2.7 MOTOR POTENTIOMETER APPLICATION

Use the Motor potentiometer application for the processes where the frequency reference of the motor is controlled (that is, increased and decreased) through digital inputs.

In this application, the I/O terminal is set to the default control place. The start/stop commands are given with DI1 and DI2. The frequency reference of the motor is increased with DI5 and decreased with DI6.

It is possible to configure all the drive outputs freely in all the applications. There are 1 analogue output (Output Frequency) and 3 relay outputs (Run, Fault, Ready) available on the basic I/O board.

4.2.7.1 M1.36 Motor Potentiometer

Table 20. Motor Potentiometer start-up wizard menu

Code	Parameter	Min	Max	Unit	Default	ID	Description
P1.36.1	MotPot ramp time	0.1	500.0	Hz/s	10.0	331	Rate of change in the motor potentiometer reference when increased or decreased with parameters P3.3.4.1 or P3.3.4.2.
P1.36.2	MotPot Reset	0	2		1	367	Motor potentiometer frequency reference reset logic. 0 = No reset 1 = Reset if stopped 2 = Reset if powered down
P1.36.3	Preset Freq 1	P1.3	P1.4	Hz	20.0	105	Make the selection of a preset frequency with the digital input DI4 and DI5.

5. USER INTERFACES

5.1 KEYPAD OF THE DRIVE

The control keypad is the interface between the VACON® 100 AC drive and the user. With the control keypad it is possible to control the speed of a motor, to supervise the state of the equipment and to set the AC drive's parameters.

There are two keypad types you can choose for your user interface: *Keypad with graphical display* and *Text keypad*.

5.1.1 BUTTONS

The button section of the keypad is identical for both keypad types.

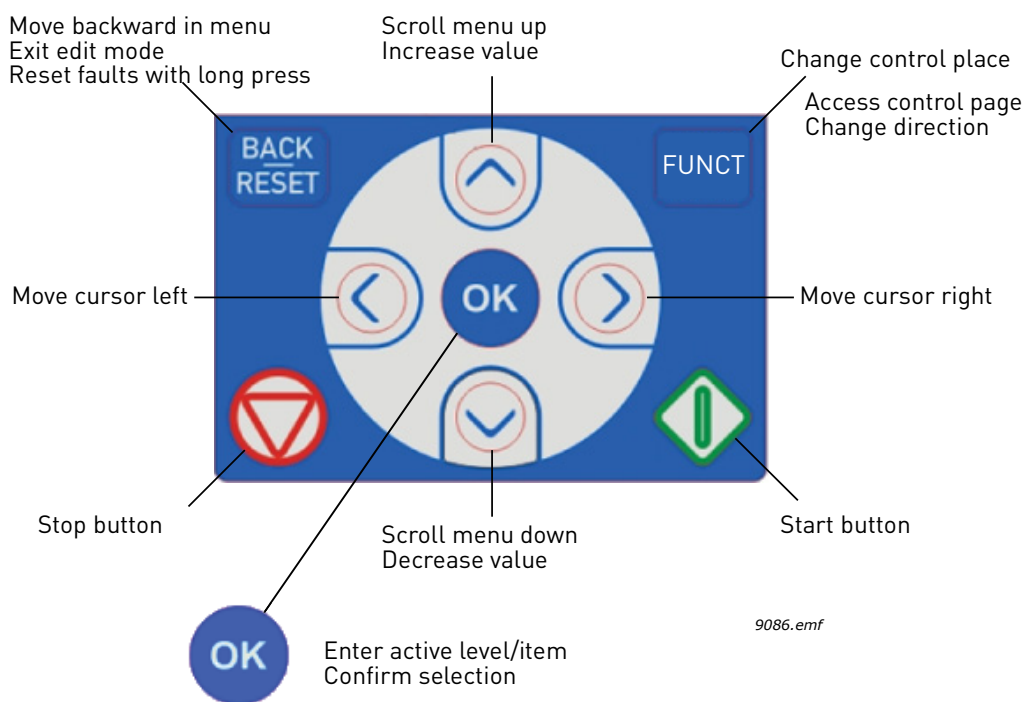

Figure 13. Keypad buttons

5.1.2 DISPLAY

The keypad display indicates the status of the motor and the drive and any irregularities in motor or drive functions. On the display, the user sees information about the drive and his present location in the menu structure and the item displayed.

5.1.3 NAVIGATION ON KEYPAD

The data on the control keypad are arranged in menus and submenus. Use the Up and Down arrows to move between the menus. Enter the group/item by pressing the OK button and return to the former level by pressing the Back/Reset button.

The *Location field* indicates your current location. The *Status field* gives information about the present status of the drive. See Figure 13.

5.1.4 GRAPHICAL KEYPAD

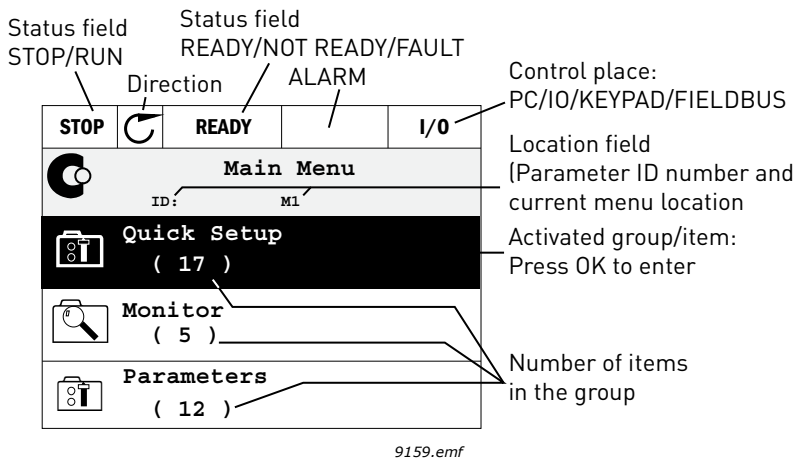

Figure 14. Main menu

5.1.4.1 Using the graphical keypad

Editing values

The selectable values can be accessed and edited in two different ways on the graphical keypad.

Parameters with one valid value

Typically, one parameter is set one value. The value is selected either from a list of values (see example below) or the parameter is given a numerical value from a defined range (e.g. 0.00...50.00 Hz).

Change value of a parameter following the procedure below:

1. Locate the parameter.
2. Enter the *Edit* mode.
3. Set new value with the arrow buttons up/down. You can also move from digit to digit with the arrow buttons left/right if the value is numerical and then change the value with the arrow buttons up/down.
4. Confirm change with OK button or ignore change by returning to previous level with Back/Reset button.

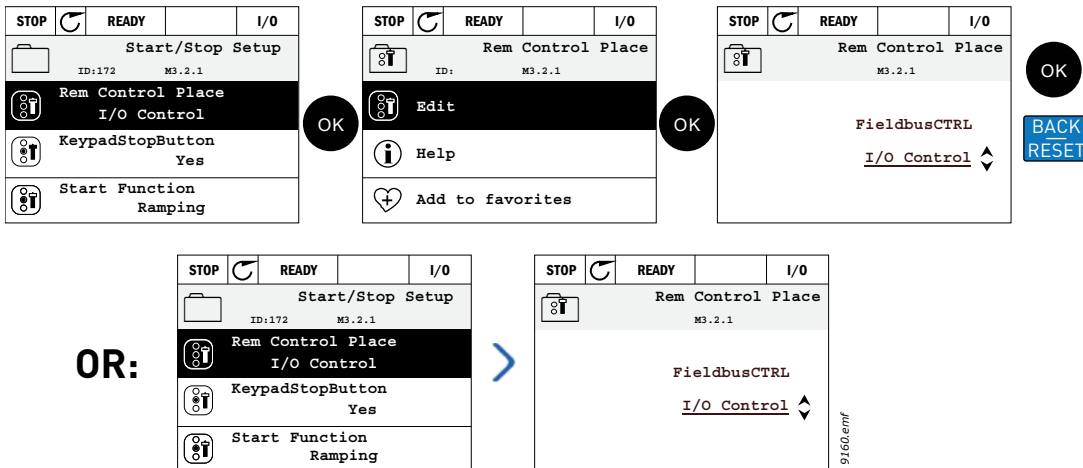

Figure 15. Typical editing of values on graphical keypad (text value)

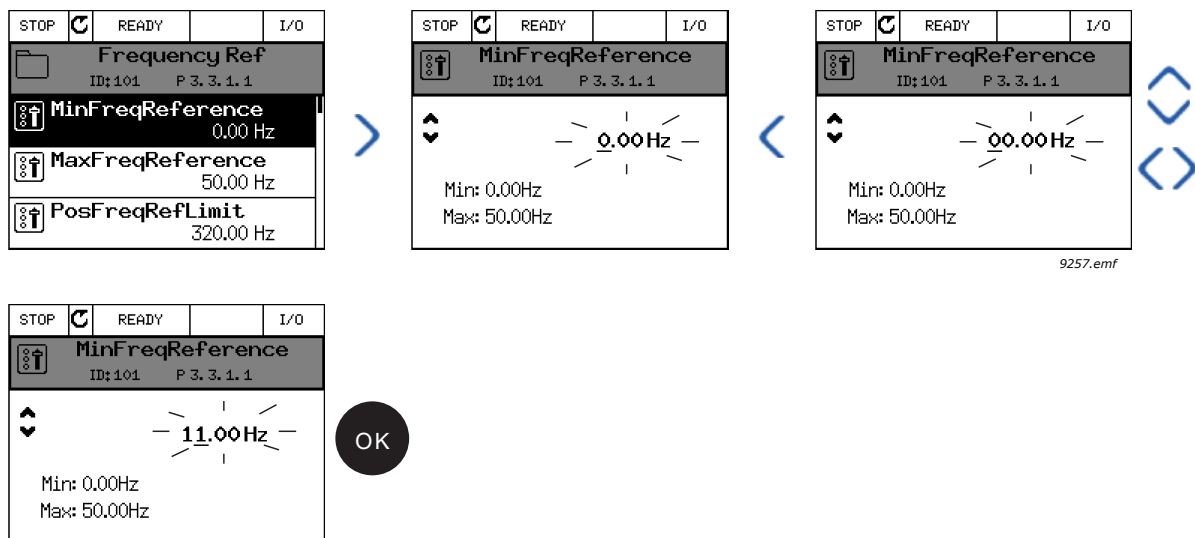
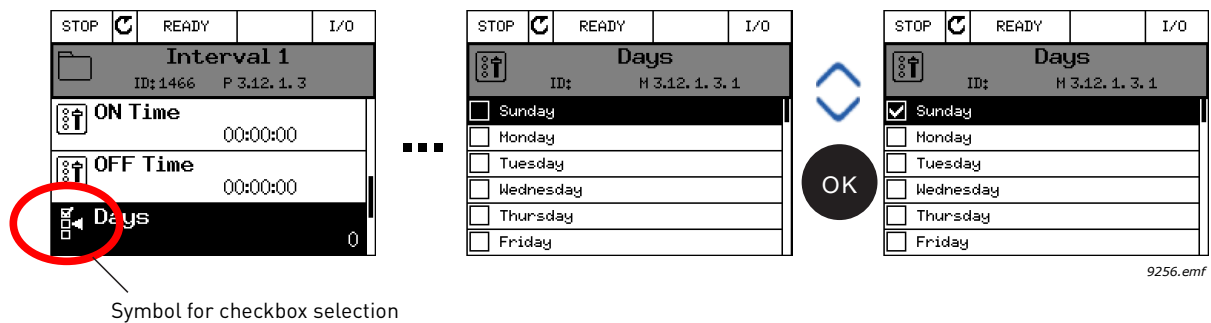

Figure 16. Typical editing of values on graphical keypad (numerical value)

Parameters with checkbox selection

Some parameters allow selecting several values. Make a check box selection at each value you wish to activate as instructed below.



Symbol for checkbox selection

Figure 17. Applying the checkbox value selection on graphical keypad

Resetting fault

Instructions for how to reset a fault can be found in chapter 8 .

Function button

The FUNCT button is used for four functions:

1. to quickly access the Control page,
2. to easily change between the Local (Keypad) and Remote control places,
3. to change the rotation direction and
4. to quickly edit a parameter value.

Control places

The *control place* is the source of control where the drive can be started and stopped. Every control place has its own parameter for selecting the frequency reference source. The *Local control place* is always the keypad. The *Remote control place* is determined by parameter P3.2.1 (I/O or Field-bus). The selected control place can be seen on the status bar of the keypad.

Remote control place

I/O A, I/O B and Fieldbus can be used as remote control places. I/O A and Fieldbus have the lowest priority and can be chosen with parameter P3.2.1 (*Rem Control Place*). I/O B, again, can bypass the remote control place selected with parameter P3.2.1 using a digital input. The digital input is selected with parameter P3.5.1.7 (*I/O B Ctrl Force*).

Local control

Keypad is always used as control place while in local control. Local control has higher priority than remote control. Therefore, if, for example, bypassed by parameter P3.5.1.7 through digital input while in *Remote*, the control place will still switch to Keypad if *Local* is selected. Switching between Local and Remote Control can be done by pressing the FUNCT-button on the keypad or by using the "Local/Remote" (ID211) parameter.

Changing control places

Change of control place from *Remote* to *Local* (keypad).

1. Anywhere in the menu structure, push the *FUNCT* button.
2. Push the *Arrow up* or the *Arrow down* button to select *Local/Remote* and confirm with the *OK* button.
3. On the next display, select *Local* or *Remote* and again confirm with the *OK* button.
4. The display will return to the same location as it was when the *FUNCT* button was pushed. However, if the Remote control place was changed to Local (Keypad) you will be prompted for keypad reference.

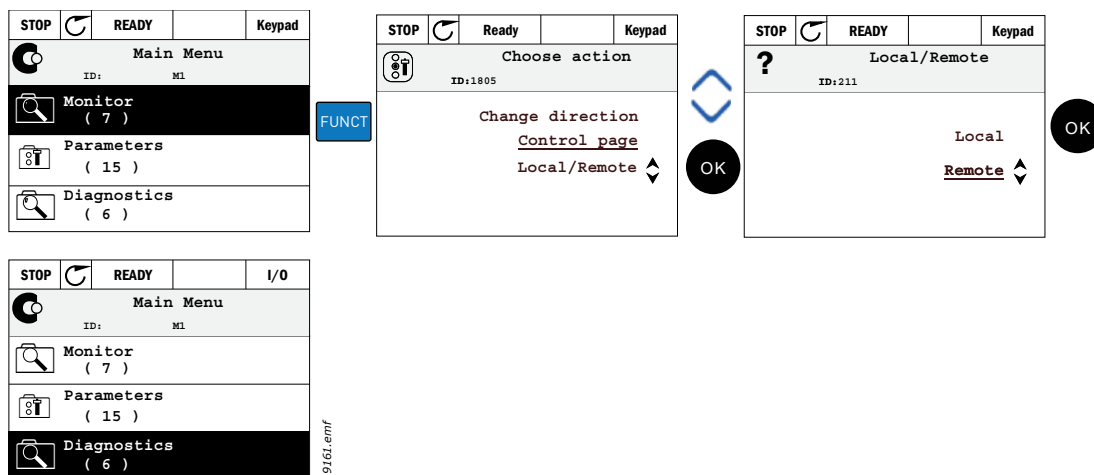

Figure 18. Changing control places

Accessing the control page

The *Control page* is meant for easy operation and monitoring of the most essential values.

1. Anywhere in the menu structure, push the *FUNCT* button.
2. Push the *Arrow up* or the *Arrow down* button to select *Control page* and confirm with the *OK* button.
3. The control page appears
 If keypad control place and keypad reference are selected to be used you can set the *Keypad Reference* after having pressed the *OK* button. If other control places or reference values are used the display will show Frequency reference which is not editable. The other values on the page are Multimonitoring values. You can choose which values appear here for monitoring (for this procedure, see page 62).

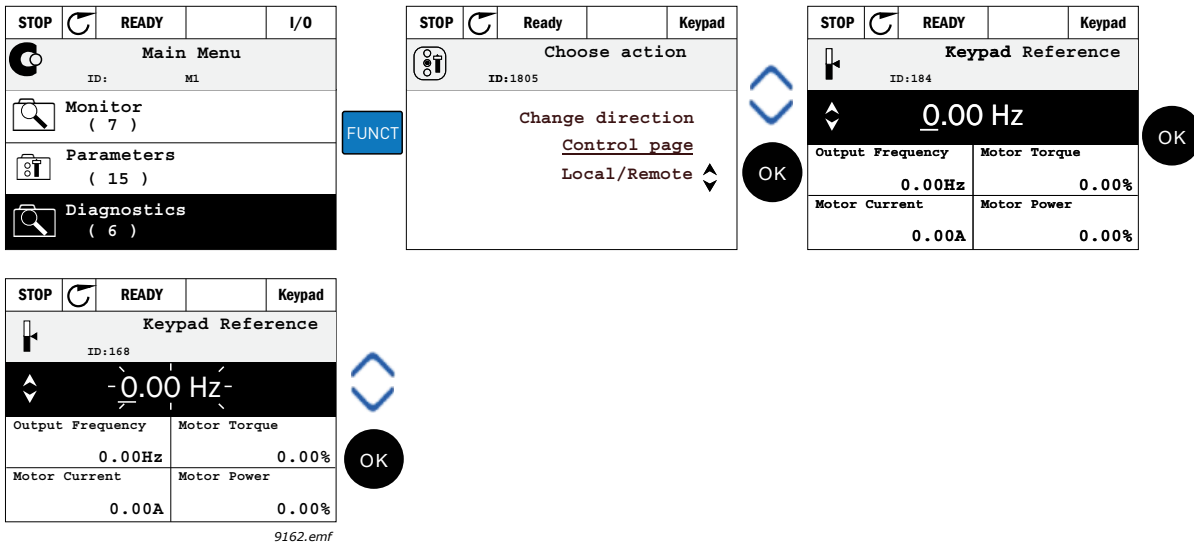
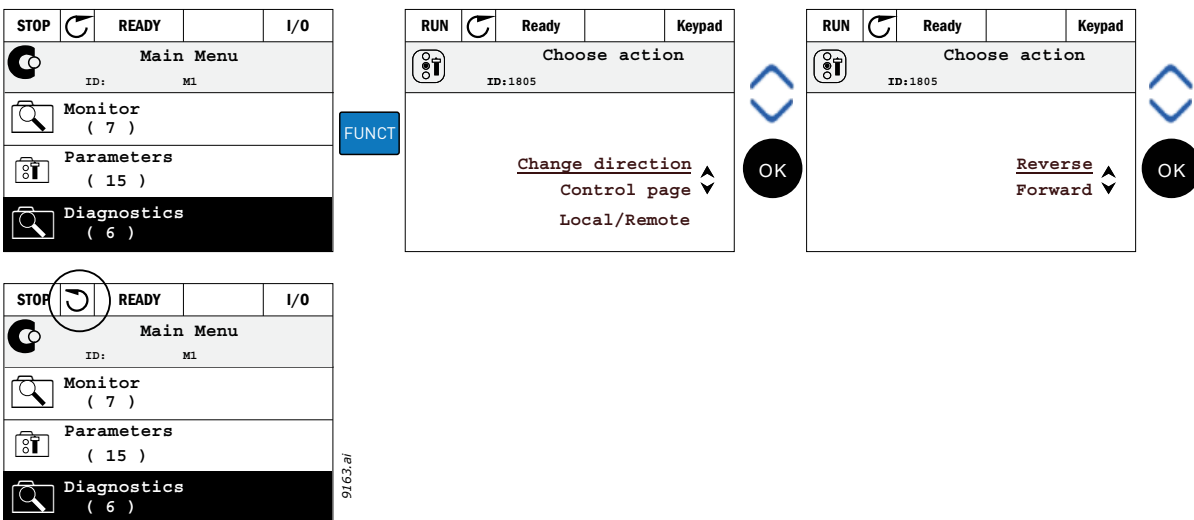

Figure 19. Accessing Control page

Changing direction

Rotation direction of the motor can quickly be changed by applying the FUNCT button. **NOTE!** *Changing direction* command is not visible in the menu unless the selected control place is *Local*.

1. Anywhere in the menu structure, push the Funct button.
2. Push the Arrow up or the Arrow down button to select Change direction and confirm with the OK button.
3. Then choose the direction you wish to run the motor to. The actual rotation direction is blinking. Confirm with the OK button.
4. The rotation direction changes immediately and the arrow indication in the status field changes.



Quick edit

Through the *Quick edit* functionality you can quickly access the desired parameter by entering the parameter's ID number.

1. Anywhere in the menu structure, push the FUNCT button.
2. Push the Arrow up or the Arrow down buttons to select Quick Edit and confirm with the OK button.

3. Then enter the ID number of parameter or monitoring value you wish to access. Press OK button to confirm.
4. Requested Parameter/Monitoring value appears on the display (in editing/monitoring mode.)

Copying parameters

NOTE: This feature is available in graphical keypad only.

The parameter copy function can be used to copy parameters from one drive to another.

The parameters are first saved to the keypad, then the keypad is detached and connected to another drive. Finally the parameters are downloaded to the new drive restoring them from the keypad.

Before any parameters can successfully be copied from the keypad to the drive, the drive **has to be stopped** before the parameters are uploaded.

- First go into *User settings* menu and locate the *Parameter backup* submenu. In the *Parameter backup* submenu, there are three possible functions to be selected:
- *Restore factory defaults* will re-establish the parameter settings originally made at the factory.
- By selecting *Save to keypad* you can copy all parameters to the keypad.
- *Restore from keypad* will copy all parameters from keypad to a drive.

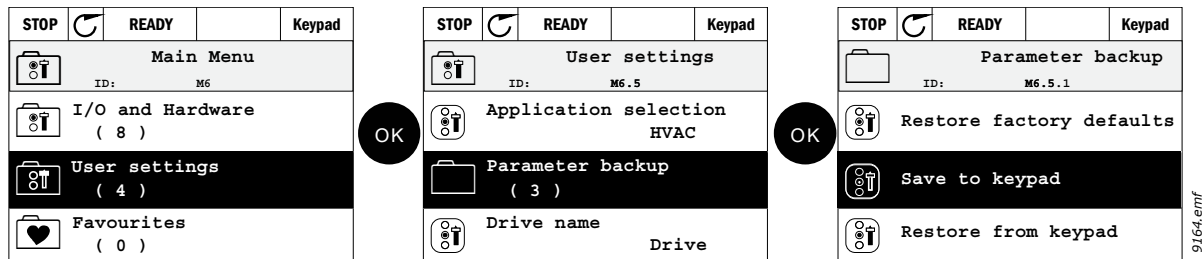

Figure 20. Parameter copy

NOTE: If the keypad is changed between drives of different sizes, the copied values of these parameters will not be used:

- Motor nominal current (P3.1.1.4)
- Motor nominal voltage (P3.1.1.1)
- Motor nominal speed (P3.1.1.3)
- Motor nominal power (P3.1.1.6)
- Motor nominal frequency (P3.1.1.2)
- Motor cos phi (P3.1.1.5)
- Switching frequency (P3.1.2.3)
- Motor current limit (P3.1.3.1)
- Stall current limit (P3.9.3.2)
- Stall time limit (P3.9.3.3)
- Stall frequency (P3.9.3.4)
- Maximum frequency (P3.3.1.2)

Help texts

The graphical keypad features instant help and information displays for various items.

All parameters offer an instant help display. Select Help and press the OK button.

Text information is also available for faults, alarms and the startup wizard.

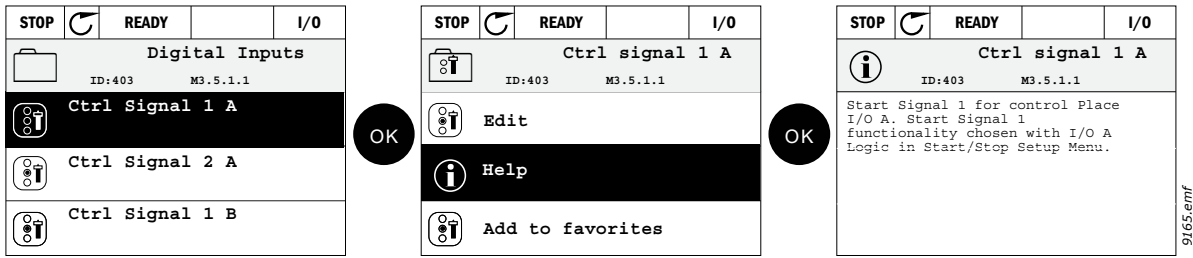

Figure 21. Help text example

Adding item to favorites

You might need to refer to certain parameter values or other items often. Instead of locating them one by one in the menu structure, you may want to add them to a folder called *Favorites* where they can easily be reached.

To remove an item from the Favorites, see chapter 5.3.7.

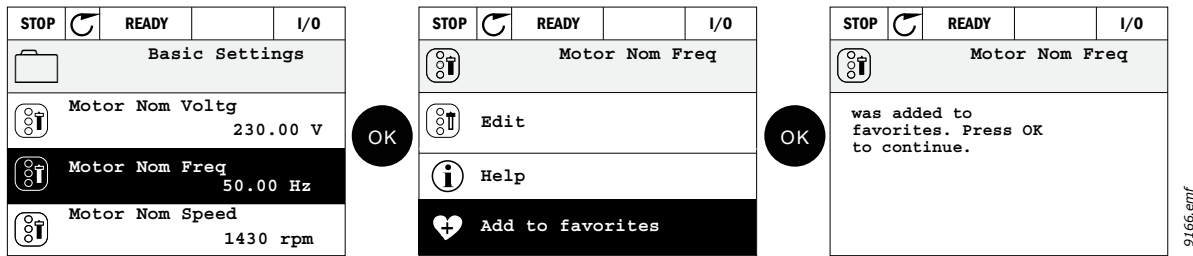

Figure 22. Adding item to Favorites

5.1.5 TEXT KEYPAD

You can also choose a so-called *Text keypad* for your user interface. It has mainly the same functionalities as the graphical keypad although some of these are somewhat limited.

5.1.5.1 Keypad display

The keypad display indicates the status of the motor and the drive and any irregularities in motor or drive functions. On the display, the user sees information about the drive and his present location in the menu structure and the item displayed. If the text on the text line is too long to fit in the display, the text will scroll from left to right to reveal the whole text string.

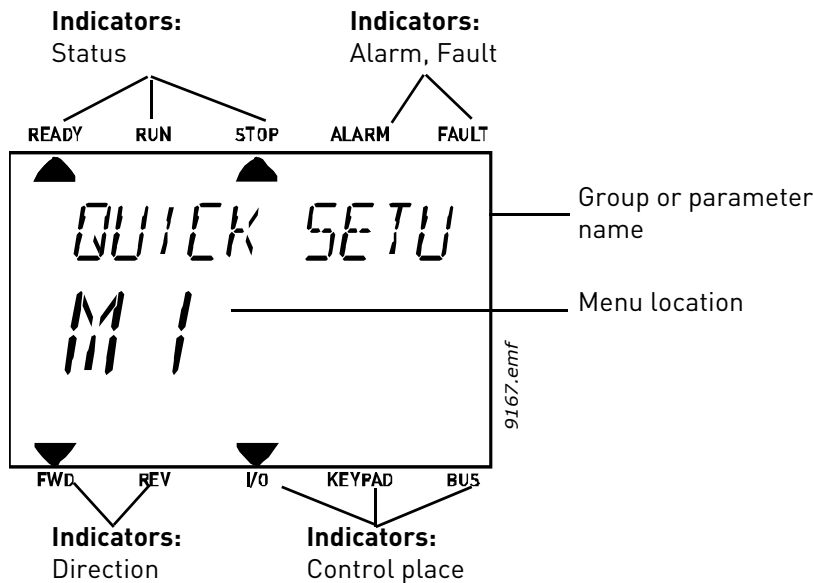

5.1.5.2 Using the text keypad

Editing values

Change value of a parameter following the procedure below:

1. Locate the parameter.
2. Enter the Edit mode by pressing OK.
3. Set new value with the arrow buttons up/down. You can also move from digit to digit with the arrow buttons left/right if the value is numerical and change then the value with the arrow buttons up/down.
4. Confirm change with OK button or ignore change by returning to previous level with Back/Reset button.

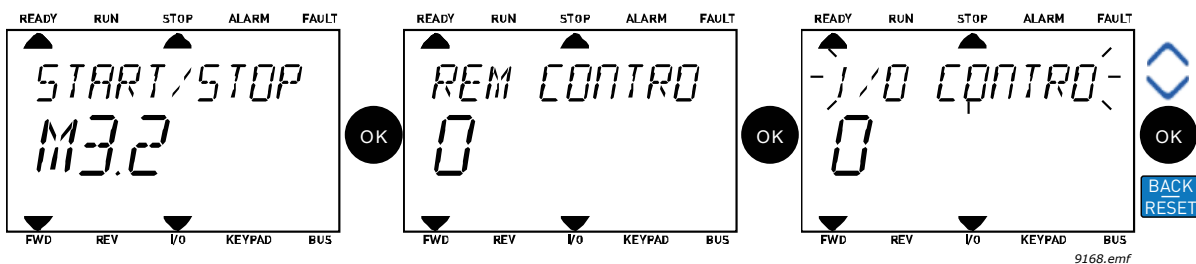

Figure 23. Editing values

Resetting fault

Instructions for how to reset a fault can be found in chapter 8 on page 185.

Function button

The FUNCT button is used for four functions:

Control places

The *control place* is the source of control where the drive can be started and stopped. Every control place has its own parameter for selecting the frequency reference source. The *Local control place* is always the keypad. The *Remote control place* is determined by parameter P3.2.1 (I/O or Fieldbus). The selected control place can be seen on the status bar of the keypad.

Remote control place

I/O A, I/O B and Fieldbus can be used as remote control places. I/O A and Fieldbus have the lowest priority and can be chosen with parameter P3.2.1 (*Rem Control Place*). I/O B, again, can bypass the remote control place selected with parameter P3.2.1 using a digital input. The digital input is selected with parameter P3.5.1.7 (*I/O B Ctrl Force*).

Local control

Keypad is always used as control place while in local control. Local control has higher priority than remote control. Therefore, if, for example, bypassed by parameter P3.5.1.7 through digital input while in *Remote*, the control place will still switch to Keypad if *Local* is selected. Switching between Local and Remote Control can be done by pressing the FUNCT-button on the keypad or by using the "Local/Remote" (ID211) parameter.

Changing control places

Change of control place from *Remote* to *Local* (keypad).

1. Anywhere in the menu structure, push the *FUNCT* button.
2. Using the arrow buttons, select *Local/Remote* and confirm with the *OK* button.
3. On the next display, select *Local* or *Remote* and again confirm with the *OK* button.
4. The display will return to the same location as it was when the *FUNCT* button was pushed. However, if the *Remote* control place was changed to *Local* (Keypad) you will be prompted for keypad reference.



Figure 24. Changing control places

Accessing the control page

The *Control page* is meant for easy operation and monitoring of the most essential values.

1. Anywhere in the menu structure, push the *FUNCT* button.
2. Push the *Arrow up* or the *Arrow down* button to select *Control page* and confirm with the *OK* button.
3. The control page appears
If keypad control place and keypad reference are selected to be used you can set the *Keypad Reference* after having pressed the *OK* button. If other control places or reference values are used the display will show *Frequency reference* which is not editable.



Figure 25. Accessing Control page

Changing direction

Rotation direction of the motor can quickly be changed by applying the *FUNCT* button. **NOTE!** *Changing direction* command is not visible in the menu unless the selected control place is *Local*.

1. Anywhere in the menu structure, push the *Funct* button.
2. Push the *Arrow up* or the *Arrow down* button to select *Change direction* and confirm with the *OK* button.
3. Then choose the direction you wish to run the motor to. The actual rotation direction is blinking. Confirm with the *OK* button.
4. The rotation direction changes immediately and the arrow indication in the status field changes.

Quick edit

Through the *Quick edit* functionality you can quickly access the desired parameter by entering the parameter's ID number.

1. Anywhere in the menu structure, push the FUNCT button.
2. Push the Arrow up or the Arrow down buttons to select Quick Edit and confirm with the OK button.
3. Then enter the ID number of parameter or monitoring value you wish to access. Press OK button to confirm.
4. Requested Parameter/Monitoring value appears on the display (in editing/monitoring mode.)

5.2 VACON® LIVE

VACON® Live is a PC tool for commissioning and maintenance of the VACON® 10, VACON® 20, and VACON® 100 AC drives). You can download VACON® Live from www.danfoss.com.

The VACON® Live PC tool includes these functions.

- Parametrization, monitoring, drive info, data logger, etc.
- The software download tool VACON® Loader
- RS-422 and Ethernet support
- Windows XP, Vista 7 and 8 support
- 17 languages: English, German, Spanish, Finnish, French, Italian, Russian, Swedish, Chinese, Czech, Danish, Dutch, Polish, Portuguese, Romanian, Slovak and Turkish You can make the connection between the AC drive and the PC tool with the black USB/RS-422 cable from VACON or the VACON® 100 Ethernet cable. The RS-422 drivers are installed automatically during the installation of VACON® Live. After you installed the cable, VACON® Live finds the connected drive automatically.

See more on how to use VACON® Live in the help menu of the program.

5.3 MENU STRUCTURE

Click on and select the item you wish to receive more information about (electronic manual).

Table 21. Keypad menus

Quick setup	See chapter 4.
Monitor	Multi-monitor*
	Trend curve*
	Basic
	I/O
	Extras/Advanced
	Timer functions
	PID Controller
	ExtPID controller
	Mainten. counters
	Fieldbus data
	Solar
Parameters	See chapter 7.
Diagnostics	Active faults
	Reset faults
	Fault history
	Total counters
	Trip counters
	Software info
I/O and hardware	Basic I/O
	Slot D
	Slot E
	Real time clock
	Power unit settings
	Keypad
	RS-485
	Ethernet
User settings	Language selections
	Application selection
	Parameter backup*
	Drive name
Favorites*	See chapter .
User levels	See chapter 5.3.8.

*. Not available in text keypad

5.3.1 QUICK SETUP

In the Quick Setup parameter group you will find the different wizards of the VACON® 100 X Solar Pump Application. More detailed information on the parameters of this group you will find in chapter 4.

5.3.2 MONITOR

Multi-monitor

NOTE: This menu is not available in text keypad.

On the multi-monitor page, you can collect four to nine values that you wish to monitor.

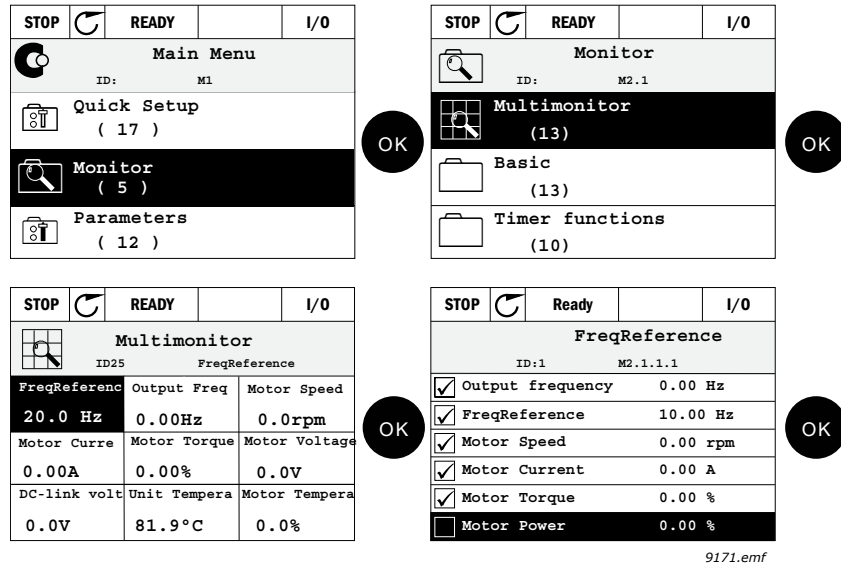

Figure 26. Multi-monitoring page

Change the monitored value by activating the value cell (with arrow buttons left/right) and clicking OK. Then choose a new item on the Monitoring values list and click OK again. More detailed information on the monitor items can be found in chapter 6.

Trend curve

The *Trend Curve* feature is a graphical presentation of two monitor values at a time.

Basic

The basic monitoring values are the actual values of selected parameters and signals as well as statuses and measurements.

I/O

Statuses and levels of various input and output signal values can be monitored here.

Extras/Advanced

Monitoring of different advanced values, e.g. fieldbus values.

Timer functions

Monitoring of timer functions and the Real Time Clock.

PID Controller

Monitoring of PID controller values.

External PID Controller

Monitoring of external PID controller values.

Maintenance counters

Monitoring of values related to Maintenance counters.

Fieldbus data

Fieldbus data shown as monitor values for debugging purposes at e.g. fieldbus commissioning.

Solar

Monitoring of values related to Solar specific application.

5.3.3 PARAMETERS

Through this submenu, you can reach the application parameter groups and parameters. More information on parameters in chapter 7.

5.3.4 DIAGNOSTICS

Under this menu, you can find *Active faults*, *Reset faults*, *Fault history*, *Counters* and *Software info*.

5.3.4.1 Active faults

Table 22.

Menu	Function	Note
Active faults	When a fault/faults appear(s), the display with the name of the fault starts to blink. Press OK to return to the Diagnostics menu. The <i>Active faults</i> submenu shows the number of faults. Select the fault and push OK to see the fault-time data.	The fault remains active until it is cleared with the Reset button (push for 2 s) or with a reset signal from the I/O terminal or fieldbus or by choosing <i>Reset faults</i> (see below). The memory of active faults can store the maximum of 10 faults in the order of appearance.

5.3.4.2 Reset faults

Table 23.

Menu	Function	Note
Reset faults	In this menu you can reset faults. For closer instructions, see chapter 8.	CAUTION! Remove external Control signal before resetting the fault to prevent unintentional restart of the drive.

5.3.4.3 Fault history

Table 24.

Menu	Function	Note
Fault history	40 latest faults are stored in the Fault history.	Entering the Fault history and clicking OK on the selected fault shows the fault time data (details).

5.3.4.4 Total counters

Table 25. Diagnostics menu, Total counters parameters

Code	Parameter	Min	Max	Unit	Default	ID	Description
V4.4.1	Energy counter			Varies		2291	Amount of energy taken from supply network. No reset. NOTE FOR TEXT KEYPAD: The highest energy unit shown on the standard keypad is MW. Should the counted energy exceed 999.9 MW, no unit is shown on the keypad.
V4.4.3	Operating time (graphical keypad)			a d hh:min		2298	Control unit operating time
V4.4.4	Operating time (text keypad)			a			Control unit operating time in total years

Table 25. Diagnostics menu, Total counters parameters

V4.4.5	Operating time (text keypad)			d			Control unit operating time in total days
V4.4.6	Operating time (text keypad)			hh:min:ss			Control unit operating time in hours, minutes and seconds
V4.4.7	Run time (graphical keypad)			a d hh:min		2293	Motor running time
V4.4.8	Run time (text keypad)			a			Motor running time in total years
V4.4.9	Run time (text keypad)			d			Motor running time in total days
V4.4.10	Run time (text keypad)			hh:min:ss			Motor running time in hours, minutes and seconds
V4.4.11	Power on time (graphical keypad)			a d hh:min		2294	Amount of time the power unit has been powered so far. No reset.
V4.4.12	Power on time (text keypad)			a			Power on time in total years
V4.4.13	Power on time (text keypad)			d			Power on time in total days
V4.4.14	Power on time (text keypad)			hh:min:ss			Power on time in hours, minutes and seconds
V4.4.15	Start command counter					2295	The number of times the power unit has been started.

5.3.4.5 Trip counters

Table 26. Diagnostics menu, Trip counters parameters

Code	Parameter	Min	Max	Unit	Default	ID	Description
P4.5.1	Energy trip counter			Varies		2296	Resettable energy counter. NOTE: The highest energy unit shown on the standard keypad is <i>MW</i> . Should the counted energy exceed 999.9 MW, no unit is shown on the keypad. To reset the counter: <u>Standard text keypad:</u> Apply a long (4 s) push on the OK button. <u>Graphical keypad:</u> Push OK once. <i>Reset counter</i> page will appear. Push OK once again.
P4.5.3	Operating time (graphical keypad)			a d hh:min		2299	Resettable. See P4.5.1.
P4.5.4	Operating time (text keypad)			a			Operating time in total years
P4.5.5	Operating time (text keypad)			d			Operating time in total days
P4.5.6	Operating time (text keypad)			hh:min:ss			Operating time in hours, minutes and seconds

5.3.4.6 *Software info*

Table 27. Diagnostics menu, Software info parameters

Code	Parameter	Min	Max	Unit	Default	ID	Description
V4.6.1	Software package (graphical keypad)						Code for software identification
V4.6.2	Software package ID (text keypad)						
V4.6.3	Software package version (text keypad)						
V4.6.4	System load	0	100	%		2300	Load on control unit CPU.
V4.6.5	Application name (graphical keypad)						Name of application.
V4.6.6	Application ID						Application code.
V4.6.7	Application version						

5.3.5 I/O AND HARDWARE

Various options-related settings are located in this menu. Note that the values in this menu are raw values i.e. not scaled by the application.

5.3.5.1 *Basic I/O*

Monitor here the statuses of inputs and outputs.

Table 28. I/O and Hardware menu, Basic I/O parameters

Code	Parameter	Min	Max	Unit	Default	ID	Description
V5.1.1	Digital input 1	0	1		0		Status of digital input signal
V5.1.2	Digital input 2	0	1		0		Status of digital input signal
V5.1.3	Digital input 3	0	1		0		Status of digital input signal
V5.1.4	Digital input 4	0	1		0		Status of digital input signal
V5.1.5	Digital input 5	0	1		0		Status of digital input signal
V5.1.6	Digital input 6	0	1		0		Status of digital input signal
V5.1.7	Analogue input 1 mode	1	3		3		Shows the selected (with jumper) mode for Analogue input signal 1 = 0...20 mA 3 = 0...10 V
V5.1.8	Analogue input 1	0	100	%	0.00		Status of analogue input signal
V5.1.9	Analogue input 2 mode	1	3		3		Shows the selected (with jumper) mode for Analogue input signal 1 = 0...20 mA 3 = 0...10 V
V5.1.10	Analogue input 2	0	100	%	0.00		Status of analogue input signal
V5.1.11	Analogue output 1 mode	1	3		1		Shows the selected (with jumper) mode for Analogue output signal 1 = 0...20 mA 3 = 0...10 V
V5.1.12	Analogue output 1	0	100	%	0.00		Status of analogue output signal
V5.1.13	Relay output 1	0	1		0		Status of relay output signal
V5.1.14	Relay output 2	0	1		0		Status of relay output signal
V5.1.15	Relay output 3	0	1		0		Status of relay output signal

5.3.5.2 Option board slots

The parameters of this group depend on the option board installed. If no option board is placed in slots D or E, no parameters are visible.

As an option board is removed, info text 39 *Device removed* will appear on the display.

Table 29. Option board-related parameters

Menu	Function	Note
Slot D	Settings	Option board related settings.
	Monitoring	Monitor option board-related info.
Slot E	Settings	Option board related settings.
	Monitoring	Monitor option board-related info.

5.3.5.3 Programming of digital and analogue inputs

The programming of inputs in the VACON® 100 Solar Pump Application is very flexible. The available inputs on the standard and optional I/O can be used for various functions according to the operator's choice.

The available I/O can be expanded with optional boards to be inserted in board slots D and E. More information about the installation of optional boards you will find in the VACON® 100 Installation manual.

5.3.5.4 Digital inputs

The applicable functions for digital inputs are arranged as parameters in parameter group M3.5.1. The value given to the parameter is a reference to the digital input you choose to use for the function. The list of functions that you can assign to the available digital inputs is presented on Digital Inputs group.

Example

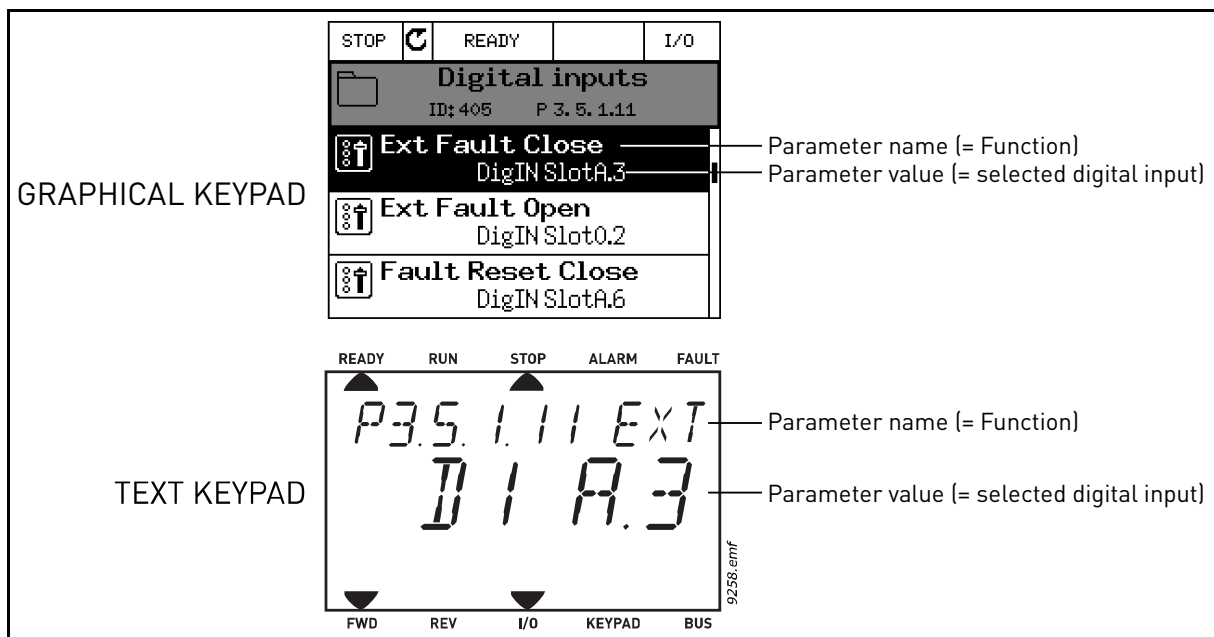

Figure 27.

Given the standard I/O board compilation on the VACON® 100 AC drive, there are 6 digital inputs available (Slot A terminals 8, 9, 10, 14, 15 and 16). In the programming view, these inputs are referred to as follows:

Table 30.

Input type (Graphical keypad)	Input type (Text keypad)	Slot	Input #	Explanation
DigIN	dl	A.	1	Digital input #1 (terminal 8) on board in Slot A (standard I/O board).
DigIN	dl	A.	2	Digital input #2 (terminal 9) on board in Slot A (standard I/O board).
DigIN	dl	A.	3	Digital input #3 (terminal 10) on board in Slot A (standard I/O board).
DigIN	dl	A.	4	Digital input #4 (terminal 14) on board in Slot A (standard I/O board).
DigIN	dl	A.	5	Digital input #5 (terminal 15) on board in Slot A (standard I/O board).
DigIN	dl	A.	6	Digital input #6 (terminal 16) on board in Slot A (standard I/O board).

In the example Figure 27, the function *External fault close* located in menu M3.5.1 as parameter P3.5.1.11, is by default given the value *DigIN SlotA.3* (graphical keypad) or *dI A.3* (text keypad). This means that the function *External fault close* is now controlled with a digital signal to digital input DI3 (terminal 10).

This is what is shown in the parameter list.

Code	Parameter	Default	ID	Description
P3.5.1.11	External fault close	DigIN SlotA.3	405	FALSE = OK TRUE = External fault

Assume you need to change the selected input. Instead of DI3 you wish to use DI6 (terminal 16) on the standard I/O. Do as instructed here:

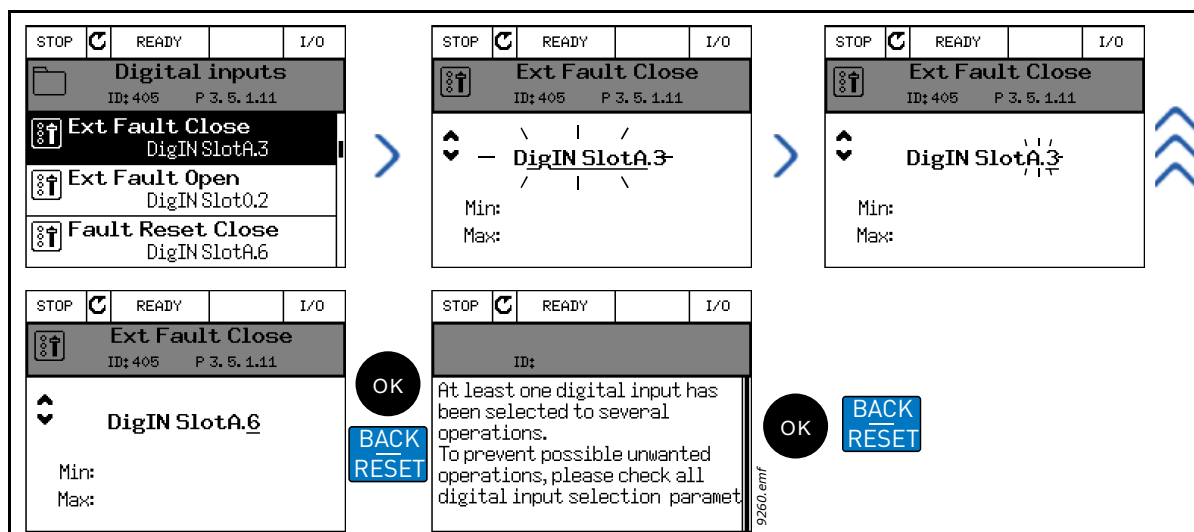

Figure 28. Programming digital inputs with graphical keypad

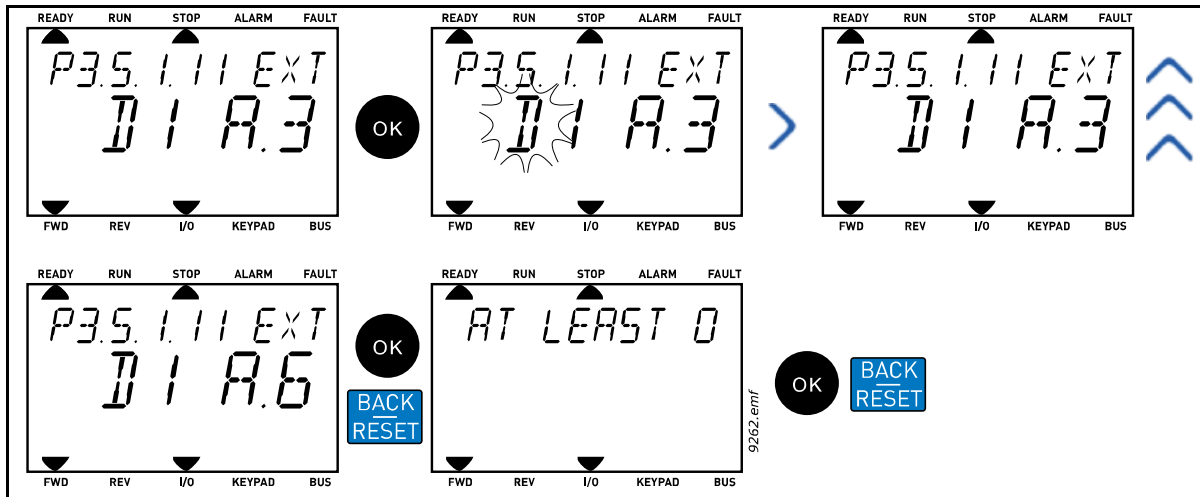

Figure 29. Programming digital inputs with text keypad

Table 31. Programming digital inputs

PROGRAMMING INSTRUCTIONS	
Graphical keypad	Text keypad
1. Select the parameter and push the <i>Arrow right</i> button.	1. Select the parameter and push the <i>OK</i> button.
2. You are now in the <i>Edit</i> mode as the slot value <i>DigIN SlotA.</i> is blinking and underlined. (Should you have more digital inputs available in your I/O, for example, through inserted option boards in slots D or E , they can also be selected here.)	2. You are now in the <i>Edit</i> mode as the letter <i>d</i> is blinking. (Should you have more digital inputs available in your I/O, for example, through inserted option boards in slots D or E , they can also be selected here.)
3. Push the <i>Arrow right</i> button again to activate the terminal value 3.	3. Push the <i>Arrow right</i> button to activate the terminal value 3. The letter <i>d</i> stops blinking.
4. Push the <i>Arrow up</i> button three times to change the terminal value to 6. Confirm with <i>OK</i> button.	4. Push the <i>Arrow up</i> button three times to change the terminal value to 6. Confirm with <i>OK</i> button.
5. NOTE! If the digital input DI6 was already used for some other function a message is displayed. You might then want to change either of these selections.	5. NOTE! If the digital input DI6 was already used for some other function a message will scroll through the display. You might then want to change either of these selections.

Now, the function *External fault close* is controlled with a digital signal to digital input DI6 (terminal 16).

NOTE!	The function is not assigned to any terminal, or, the the input is set to be always FALSE, if its value is <i>DigIN Slot0.1</i> (graphical keypad) or <i>dI 0.1</i> (text keypad). This is the default value of the majority of parameters in group M3.5.1.
NOTE!	On the other hand, some inputs have been by default set to be always TRUE. Their value shows <i>DigIN Slot0.2</i> (graphical keypad) or <i>dI 0.2</i> (text keypad).
NOTE!	Also <i>Time Channels</i> can be assigned to digital inputs. See more information on page 120.

5.3.5.5 Analogue inputs

The target input for the analogue frequency reference signal can also be chosen from the available analogue inputs.

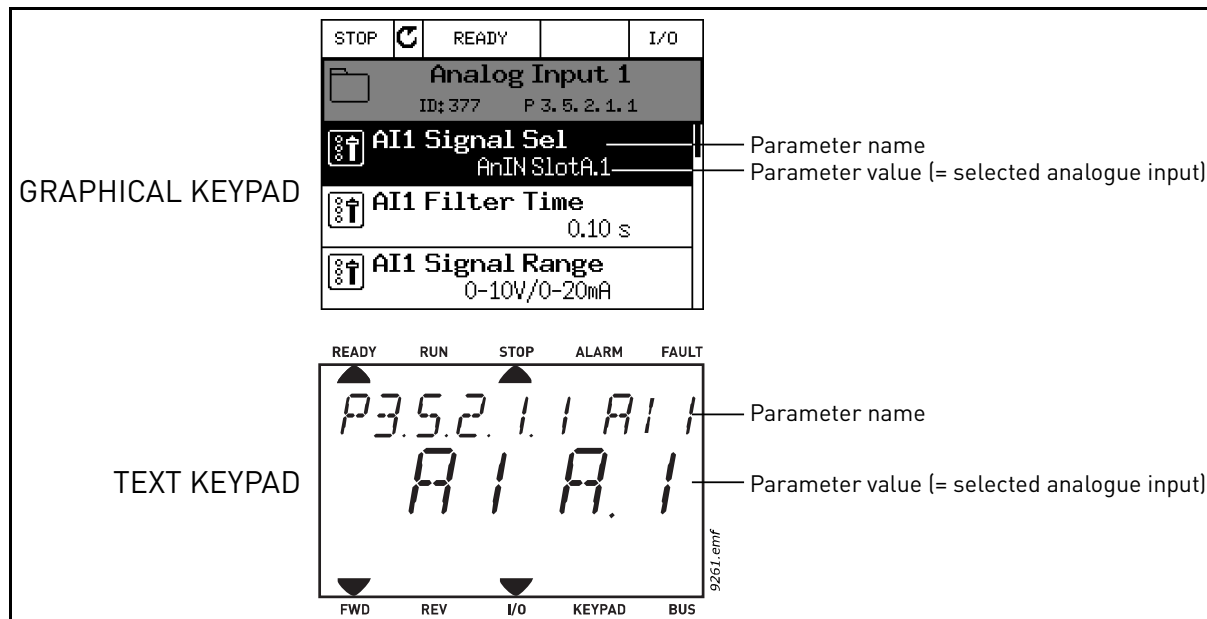

Figure 30.

Given the standard I/O terminals on the VACON® 100 X AC drive, there are 2 analogue inputs available. In the programming view, these inputs are referred to as follows:

Table 32. Programming analogue inputs

Input type (Graphical keypad)	Input type (Text keypad)	Slot	Input #	Explanation
AnIN	AI	A.	1	Analogue input #1 (terminals 2/3) on board in Slot A (standard I/O terminals).
AnIN	AI	A.	2	Analogue input #2 (terminals 4/5) on board in Slot A (standard I/O terminals).

In the example Figure 30, the parameter *AI1 signal selection* located in menu M3.5.2.1 with parameter code P3.5.2.1.1, is by default given the value *AnIN SlotA.1* (graphical keypad) or *AI A.1* (text keypad). This means that the target input for the analogue frequency reference signal AI1 is now the analogue input in terminals 2/3. Whether the signal is voltage or current, must be determined with the *dip switches*. See the Installation manual for more information.

This is what is shown in the parameter list on page 105:

Code	Parameter	Min	Max	Unit	Default	ID	Description
P3.5.2.1.1	AI1 signal selection				AnIN SlotA.1	377	Connect the AI1 signal to the analogue input of your choice with this parameter. Programmable. See page 105.

Assume you need to change the selected input. Instead of AI1 you wish to use the analogue input on your option board in slot D. Do as instructed here:

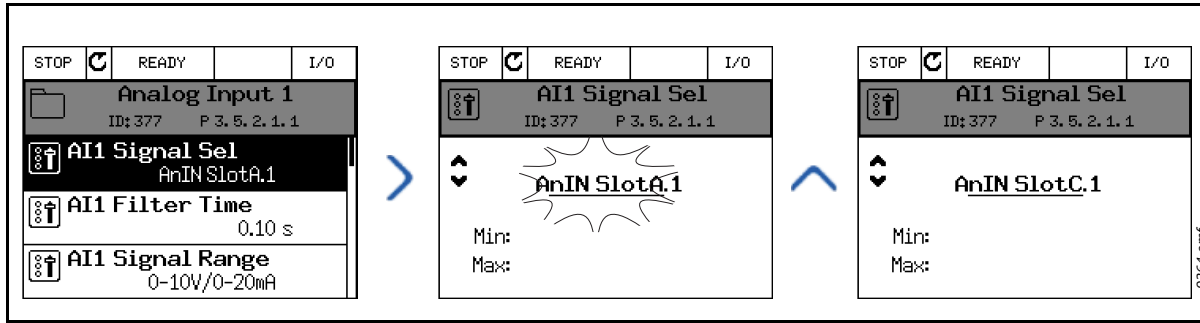

Figure 31. Programming analogue inputs with graphical keypad

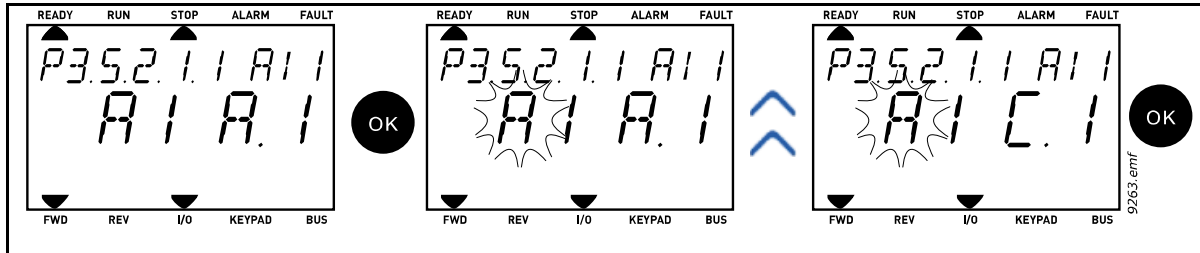

Figure 32. Programming analogue inputs with text keypad

PROGRAMMING INSTRUCTIONS	
Graphical keypad	Text keypad
1. Select the parameter and push the <i>Arrow right</i> button.	1. Select the parameter and push the <i>OK</i> button.
2. You are now in the <i>Edit</i> mode as the slot value <i>AnIN SlotA.</i> is blinking and underlined.	2. You are now in the <i>Edit</i> mode as the letter <i>A</i> is blinking.
3. Push the <i>Arrow up</i> button once to change the slot value to <i>AnIN SlotC.</i> Confirm with <i>OK</i> button.	3. Push the <i>Arrow up</i> button once to change the slot value to <i>C.</i> Confirm with <i>OK</i> button.

5.3.5.6 *Descriptions of signal sources*

Table 33. Descriptions of signal sources

Source	Function
Slot0.#	<p>Digital inputs: A digital signal can be forced to a constant FALSE or TRUE state using this functionality. For example, some signals have been set to be always in TRUE state by manufacturer, e.g parameter P3.5.1.15 (Run enable). Unless changed, Run enable signal is always on. # = 1: Always FALSE # = 2-10: Always TRUE</p> <p>Analogue inputs (used for testing purposes): # = 1: Analogue input = 0% signal strength # = 2: Analogue input = 20% signal strength # = 3: Analogue input = 30% signal strength etc. # = 10: Analogue input = 100% signal strength</p>
SlotA.#	Number (#) corresponds to digital input in slot A(Standard terminals).
SlotD.#	Number (#) corresponds to digital input in slot D.
SlotE.#	Number (#) corresponds to digital input in slot E.
TimeChannel.#	Number (#) corresponds to: 1=Time Channel1, 2=Time Channel2, 3=Time Channel3
Fieldbus CW.#	Number (#) refers to Control Word bit number.
FieldbusPD.#	Number (#) refers to Process Data 1 bit number.

5.3.5.7 *Default assignments of digital and analogue inputs in VACON® 100 application*

Digital and analogue inputs are assigned certain functions by the factory. In this application, the default assignments are:

Table 34. Default assignments of inputs

Input	Terminal(s)	Reference	Assigned function	Parameter code
DI1	8	A.1	Control signal 1 A	P3.5.1.1
DI2	9	A.2	Control signal 2 A	P3.5.1.2
DI3	10	A.3	External fault close	P3.5.1.11
DI4	14	A.4	Preset Freq Sel0	P3.5.1.21
DI5	15	A.5	Preset Freq Sel1	P3.5.1.22
DI6	16	A.6	External fault close	P3.5.1.13
AI1	2/3	A.1	AI1 signal selection	P3.5.2.1.1
AI2	4/5	A.2	AI2 signal selection	P3.5.2.2.1

5.3.5.8 *Real time clock*

Table 35. I/O and Hardware menu, Real time clock parameters

Code	Parameter	Min	Max	Unit	Default	ID	Description
V5.5.1	Battery state	1	3		2	2205	Status of battery. 1 = Not installed 2 = Installed 3 = Change battery
P5.5.2	Time			hh:mm:ss		2201	Current time of day
P5.5.3	Date			dd.mm.		2202	Current date
P5.5.4	Year			yyyy		2203	Current year
P5.5.5	Daylight saving	1	4		1	2204	Daylight saving rule 1 = Off 2 = EU; Starts on last Sunday in March, ends last Sunday in October 3 = US; Start on 2nd Sunday in March, ends on 1st Sunday in November 4 = Russia (permanent)

5.3.5.9 *Power unit settings*

Fan control

The fan operates in speed-controlled mode. The speed is controlled according to the drive's internal logic that receives data from temperature measurements.

Table 36. Power unit settings, Fan control

Code	Parameter	Min	Max	Unit	Default	ID	Description
V5.6.1.3	Fan stop	0	1		1	826	If enabled, the fan will stop in 5 minutes when the drive is in Ready state. 0 = Disabled 1 = Enabled

Brake chopper

Table 37. Power unit settings, Brake chopper

Code	Parameter	Min	Max	Unit	Default	ID	Description
V5.6.2.1	Brake chopper mode	0	3		0		0 = Disabled 1 = Enabled (Run) 2 = Enabled (Run & Stop) 3 = Enabled (Run, no testing)

Sine filter

Table 38. Power unit settings, Sine filter

Code	Parameter	Min	Max	Unit	Default	ID	Description
V5.6.4.1	Sine filter	0	1		0		0 = Disabled 1 = Enabled

5.3.5.10 Keypad

Table 39. I/O and Hardware menu, Keypad parameters

Code	Parameter	Min	Max	Unit	Default	ID	Description
P5.7.1	Timeout time	0	60	min	0		Time after which the display returns to page defined with parameter P5.7.2. 0 = Not used
P5.7.2	Default page	0	4		0		The page the keypad shows when the drive is powered on or when the time defined with P5.7.1 has expired. If the value is set to 0 the page last visited is shown. 0 = None 1 = Enter menu index 2 = Main menu 3 = Control page 4 = Multimonitor
P5.7.3	Menu index						Set menu index for desired page and activate with parameter P5.7.2 = 1.
P5.7.4	Contrast*	30	70	%	50		Set contrast of the display (30...70%).
P5.7.5	Backlight time	0	60	min	5		Set the time until the back light of the display turns off (0...60 min). If set to 0 s, back light is always on.

*. Only available with graphical keypad

5.3.5.11 *Fieldbus*

Parameters related to different fieldbus boards can also be found in the *I/O and Hardware* menu. These parameters are explained in more detail in the respective fieldbus manual.

Table 40.

Submenu level 1	Submenu level 2	Submenu level 3	Submenu level 4	
RS-485	Common settings	Protocol	NA	
Ethernet	Common settings	IP address mode	NA	
		IP address	NA	
		Subnet mask	NA	
		Default gateway	NA	
		MAC address	NA	
	Modbus/TCP	Common settings	Connection limit	
			Slave address	
			Communication timeout	
	BacNet IP	Settings	Instance number	
			Communication timeout	
			Protocol in use	
			BBMD IP	
			BBMD port	
			Time to live	
		Monitoring		FB protocol status
Communication status				
Actual instance				
Control Word				
		Status Word		

5.3.6 USER SETTINGS

Table 41. User settings menu, General settings

Code	Parameter	Min	Max	Unit	Default	ID	Description
P6.1	Language selections	Varies	Varies		Varies	802	Depends on language package.
P6.2	Application selection					801	
M6.5	Parameter backup	See chapter 5.3.6.1 below.					
P6.7	Drive name						Give name of drive if needed.

5.3.6.1 *Parameter backup*

Table 42. User settings menu, Parameter backup parameters

Code	Parameter	Min	Max	Unit	Default	ID	Description
P6.5.1	Restore factory defaults					831	Restores default parameter values and initiates the Startup Wizard when activated
P6.5.2	Save to keypad*	0	1		0		Save parameter values to keypad to e.g. copy them to another drive. 0 = No 1 = Yes
P6.5.3	Restore from keypad*						Load parameter values from keypad to the drive.
B6.5.4	Save to Set 1						Store a customized parameter set (all parameters included in the application)
B6.5.5	Restore from Set 1						Load the customized parameter set to the drive.
B6.5.6	Save to Set 2						Store another customized parameter set (all parameters included in the application)
B6.5.7	Restore from Set 2						Load the customized parameter set 2 to the drive.

*. Only available with graphical keypad

5.3.7 FAVORITES

NOTE: This menu is not available in text keypad.

Favorites are typically used to collect a set of parameters or monitoring signals from any of the keypad menus. You can add items or parameters to the Favorites folder, see chapter .

To remove an item or a parameter from the Favorites folder, do the following:

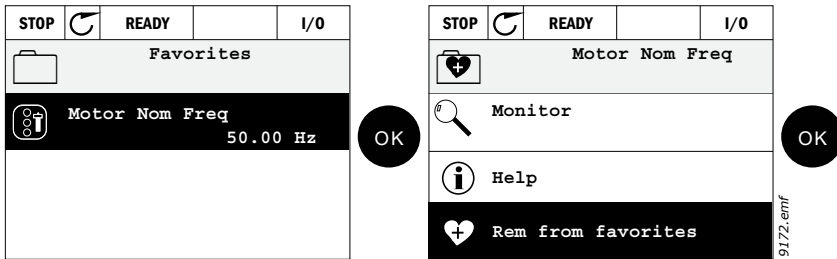

5.3.8 USER LEVELS

User level parameters are intended to restrict the visibility of parameters and to prevent unauthorized and inadvertent parameterization on the keypad.

Table 43. User level parameters

Code	Parameter	Min	Max	Unit	Default	ID	Description
P8.1	User level	1	3		1	1194	1 = Normal; All menus visible in the Main menu 2 = Monitoring; Only Monitor, Favorites and User Levels menus are visible in the main menu 3 = Favorites; Only Favorites and User Levels menus are visible in the Main menu
P8.2	Access code	0	99999		0	2362	If set to other value than 0 before switching to monitoring when e.g. user level <i>Normal</i> is active, the access code will be asked when trying to switch back to <i>Normal</i> . Can therefore be used to prevent unauthorized parameterization on the keypad.

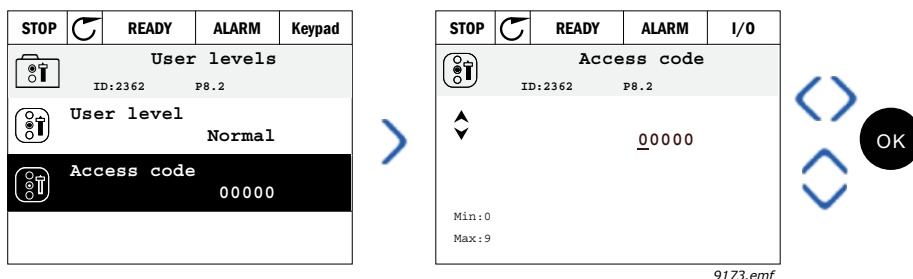

5.4 EXAMPLE OF CONTROL CONNECTIONS

The terminals of the *Standard I/Os* and the *Relays* are described below. The terminals shown on shadowed background are assigned for signals with optional functions selectable with DIP switches. See more information in VACON® 100 X Installation Manual.

Table 44. Control I/O terminal signals and connection example.

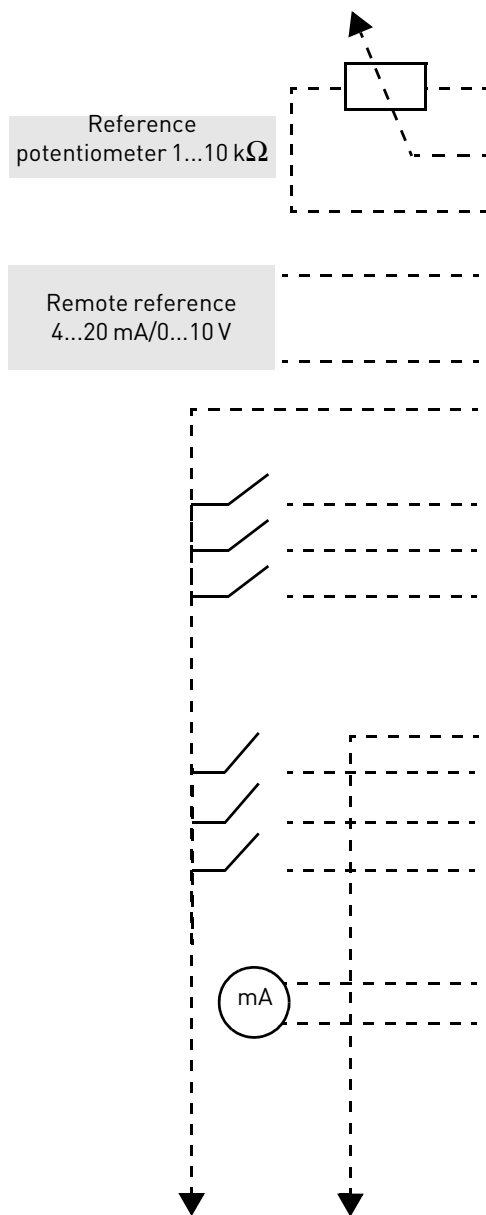

Standard I/O		
Terminal	Terminal	Signal
1	+10 Vref	Reference output
2	AI1+	Analogue input, voltage or current
3	AI1-	Analogue input common
4	AI2+	Analogue input, voltage or current
5	AI2-	Analogue input common
6	24 Vout	24 V aux. voltage
7	GND	I/O ground
8	DI1	Digital input 1
9	DI2	Digital input 2
10	DI3	Digital input 3
11	CM	Common for DI1-DI6*
12	24 Vout	24 V aux. voltage
13	GND	I/O ground
14	DI4	Digital input 4
15	DI5	Digital input 5
16	DI6	Digital input 6
17	CM	Common for DI1-DI6*
18	AO1+	Analogue output, voltage or current
19	AO-/GND	Analogue output common
30	+24 Vin	24 V auxiliary input voltage
A	RS485	Serial bus, negative
B	RS485	Serial bus, positive

*. Can be isolated from ground, see VACON® 100 X Installation Manual.

5.4.1 RELAY AND THERMISTOR INPUT TERMINALS

Table 45. I/O terminal signals for relay and thermistor terminals and connection example.

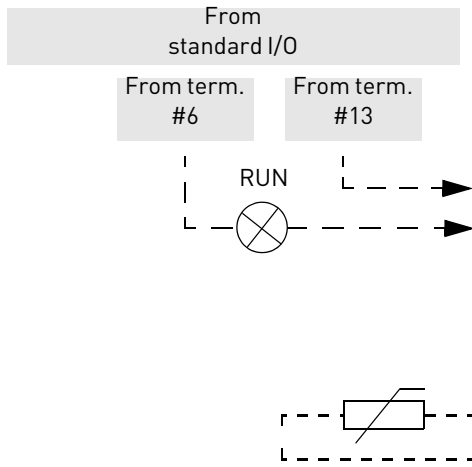

Relays and thermistor		
Terminal		Signal
21	R01/1	Relay output 1
22	R01/2	
23	R01/3	
24	R02/1	Relay output 2
25	R02/2	
26	R02/3	
28	TI1+	Thermistor input
29	TI1-	

5.4.2 SAFE TORQUE OFF (STO) TERMINALS

For more information on the functionalities of the Safe Torque Off (STO), see VACON® 100 X Installation Manual.

Table 46. I/O terminal signals for the STO functions.

Safe Torque Off terminals	
Terminal	Signal
S1	Isolated digital input 1 (interchangeable polarity); +24 V ±20%, 10...15 mA
G1	
S2	Isolated digital input 2 (interchangeable polarity); +24 V ±20%, 10...15 mA
G2	
F+	Isolated feedback (CAUTION! Polarity to be respected); +24 V ±20%
F-	Isolated feedback (CAUTION! Polarity to be respected); GND

6. MONITORING MENU

6.1 MONITOR GROUP

VACON® 100 X AC drive provides you with a possibility to monitor the actual values of parameters and signals as well as statuses and measurements. Some of the values to be monitored are customizable.

6.1.1 MULTIMONITOR

On the multi-monitor page, you can collect four to nine values that you wish to monitor.

6.1.2 TREND CURVE

The *Trend Curve* feature is a graphical presentation of two monitor values at a time.

Selecting values to monitor starts logging the values. In the Trend curve submenu, you can view the trend curve, make the signal selections, give the minimum and maximum settings, Sampling interval and choose whether to use Autoscaling or not.

Change values to monitor following the procedure below:

1. Locate the *Trend curve* menu in the *Monitor* menu and press OK.
2. Further enter the menu *View trend curve* by pressing OK again.
3. The current selections to monitor are *FreqReference* and *Motor speed* visible at the bottom of the display.
4. Only two values can be monitored as trend curves simultaneously. Select the one of the current values you wish to change with the arrow buttons and press OK.
5. Browse the list of given monitoring values with the arrow buttons, select the one you wish and press OK.
6. The trend curve of the changed value can be seen on the display.

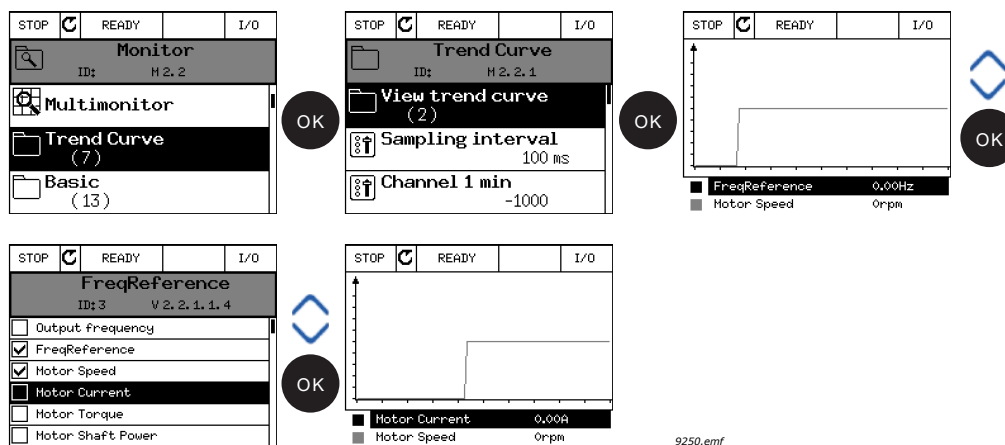

The *Trend Curve* feature also allows you to halt the progression of the curve and read the exact individual values.

1. In Trend curve view, select the display with the arrow button up (the frame of the display turns bold) and press OK at the desired point of the progressing curve. A vertical hairline appears on the display.
2. The display freezes and the values at the bottom of the display correspond to the location of the hairline.
3. Use the arrow buttons left and right to move the hairline to see the exact values of some other location.

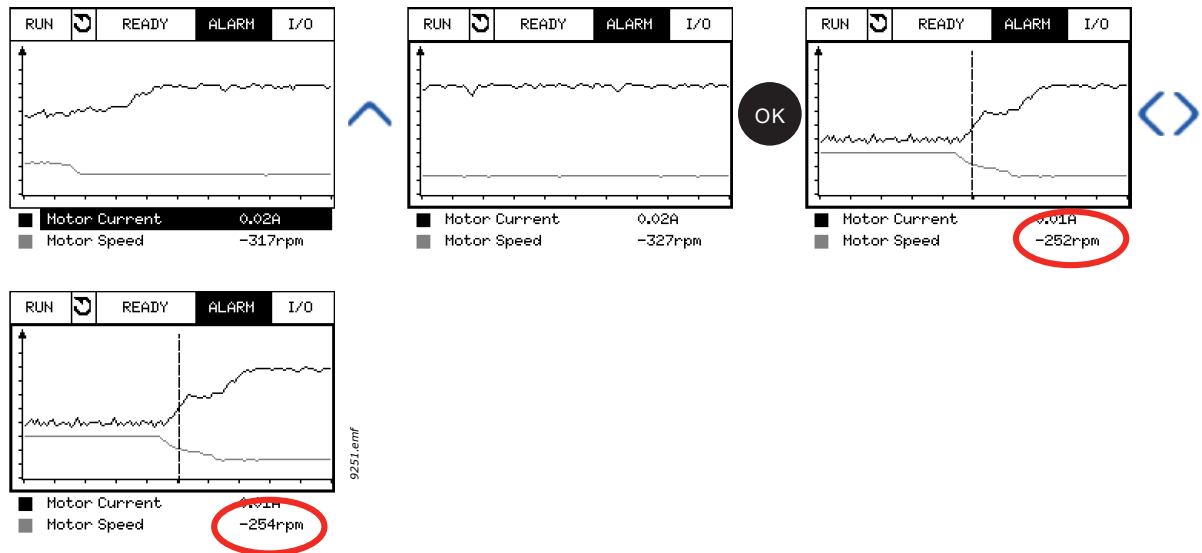

Table 47. Trend curve parameters

Code	Parameter	Min	Max	Unit	Default	ID	Description
M2.2.1	View Trend curve						Enter this menu to select and monitor values for viewing in curve form.
P2.2.2	Sampling interval	100	432000	ms	100	2368	Set here the sampling interval.
P2.2.3	Channel 1 min	-214748	1000		-1000	2369	Used by default for scaling. Adjustments might be necessary.
P2.2.4	Channel 1 max	-1000	214748		1000	2370	Used by default for scaling. Adjustments might be necessary.
P2.2.5	Channel 2 min	-214748	1000		-1000	2371	Used by default for scaling. Adjustments might be necessary.
P2.2.6	Channel 2 max	-1000	214748		1000	2372	Used by default for scaling. Adjustments might be necessary.
P2.2.7	Autoscale	0	1		0	2373	The selected signal is automatically scaled between min and max values if this parameter is given value 1.

6.1.3 BASIC

See Table 48 in which the basic monitoring values are presented.

NOTE!

Only standard I/O board statuses are available in the Monitor menu. Statuses for all I/O board signals can be found as raw data in the I/O and Hardware system menu.

Check expander I/O board statuses when required in the I/O and Hardware system menu.

Table 48. Basic monitoring menu items

Code	Monitoring value	Unit	Scale	ID	Description
V2.3.1	Output frequency	Hz	0.01	1	Output frequency to motor
V2.3.2	FreqReference	Hz	0.01	25	Frequency reference to motor control
V2.3.3	Motor speed	rpm	1	2	Motor actual speed in rpm
V2.3.4	Motor current	A	Varies	3	
V2.3.5	Motor torque	%	0.1	4	Calculated shaft torque
V2.3.7	Motor shaft power	%	0.1	5	Calculated motor shaft power in %
V2.3.8	Motor shaft power	kW/hp	Varies	73	Calculated motor shaft power in kW or hp. Units depends on the unit selection parameter.
V2.3.9	Motor voltage	V	0.1	6	Output voltage to motor
V2.3.10	DC link voltage	V	1	7	Measured voltage in the drive's DC-link
V2.3.11	Unit temperature	°C	0.1	8	Heat sink temperature in °C or °F
V2.3.12	Motor temperature	%	0.1	9	Calculated motor temperature in percent of nominal working temperature.
V2.3.13	Motor Preheat		1	1228	Status of Motor preheat function. 0 = OFF 1 = Heating (feeding DC-current)

6.1.4 I/O

Table 49. I/O signal monitoring

Code	Monitoring value	Unit	Scale	ID	Description
V2.4.1	Slot A DIN 1, 2, 3		1	15	Shows the status of digital inputs 1-3 in slot A (standard I/O)
V2.4.2	Slot A DIN 4, 5, 6		1	16	Shows the status of digital inputs 4-6 in slot A (standard I/O)
V2.4.3	Slot B RO 1, 2, 3		1	17	Shows the status of relay inputs 1-3 in slot B
V2.4.4	Analogue input 1	%	0.01	59	Input signal in percent of used range. Slot A.1 as default.
V2.4.5	Analogue input 2	%	0.01	60	Input signal in percent of used range. Slot A.2 as default.
V2.4.6	Analogue input 3	%	0.01	61	Input signal in percent of used range. Slot D.1 as default.
V2.4.7	Analogue input 4	%	0.01	62	Input signal in percent of used range. Slot D.2 as default.
V2.4.8	Analogue input 5	%	0.01	75	Input signal in percent of used range. Slot E.1 as default.
V2.4.9	Analogue input 6	%	0.01	76	Input signal in percent of used range. Slot E.2 as default.
V2.4.10	Slot A AO1	%	0.01	81	Analog output signal in percent of used range. Slot A (standard I/O)

6.1.5 EXTRAS & ADVANCED

Table 50. Advanced values monitoring

Code	Monitoring value	Unit	Scale	ID	Description
V2.6.1	DriveStatusWord		1	43	Bit coded word B1=Ready B2=Run B3=Fault B6=RunEnable B7=AlarmActive B10=DC Current in stop B11=DC Brake Active B12=RunRequest B13=MotorRegulatorActive
V2.6.2	Ready status		1	78	Bit coded information about ready criteria. Useful for debugging when the drive is not in ready status. Values are visible as checkboxes on graphical keypad. If checked (☑), the value is active. B0: RunEnable high B1: No fault active B2: Charge switch closed B3: DC voltage within limits B4: Power manager initialized B5: Power unit is not blocking start B6: System software is not blocking start
V2.6.3	Appl.StatusWord1		1	89	Bit coded statuses of application. Values are visible as checkboxes on graphical keypad. If checked (☑), the value is active. B0=Interlock 1 B1=Interlock 2 B2=Reserved B3=Ramp 2 active B4=Mechanical brake control B5=I/O A control active B6=I/O B control active B7=Fieldbus Control Active B8=Local control active B9=PC control active B10=Preset frequencies active B11=Inching active B12=Fire Mode active B13=Motor Preheat active B14=Forced stop active B15=Drive stopped from keypad
V2.6.4	Appl.StatusWord2		1	90	Bit coded status of application. Values are visible as checkboxes on graphical keypad. If checked (☑), the value is active. B0=Acc/Dec prohibited B1=Motor switch open B5=Jockey pump active B6=Priming pump active B7=Input pressure supervision (Alarm/Fault) B8=Frost protection (Alarm/Fault) B9=Autocleaning active
V2.6.5	DIN StatusWord1		1	56	16-bit word where each bit represents the status of one digital input. 6 digital inputs from every slot are read. Word 1 starts from input 1 in slot A (bit0) and goes all the way to input 4 in slot C (bit15).

Table 50. Advanced values monitoring

Code	Monitoring value	Unit	Scale	ID	Description
V2.6.6	DIN StatusWord2		1	57	16-bit word where each bit represents the status of one digital input. 6 digital inputs from every slot are read. Word 1 starts from input 5 in slot C (bit0) and goes all the way to input 6 in slot E (bit13).
V2.6.7	MotCurrent1 deci.		0.1	45	Motor current monitor value with fixed number of decimals and less filtering. Can be used e.g. for fieldbus purposes to always get the right value regardless of frame size, or for monitoring when less filtering time is needed for the motor current.
V2.6.8	FreqRef Source		1	1495	Shows the momentary frequency reference source. 0=PC 1=Preset Freqs 2=Keypad Reference 3=Fieldbus 4=AI1 5=AI2 6=AI1+AI2 7=PID Controller 8=Motor Potentiom. 9=Joystick 10=Inching 100=Not defined 101=Alarm,PresetFreq 102=Autocleaning
V2.6.9	LastActiveFaultCode		1	37	The fault code of latest activated fault that has not been reset.
V2.6.10	LastActiveFault ID		1	95	The fault ID of latest activated fault that has not been reset.
V2.6.11	LastActiveAlarmCode		1	74	The alarm code of latest activated alarm that has not been reset.
V2.6.12	LastActiveAlarm ID		1	94	The alarm ID of latest activated alarm that has not been reset.
V2.6.13	MotorRegulat.Status		1	77	Motor limit controller status. Checked = limit controller is active, Unchecked = limit controller is not active

6.1.6 TIMER FUNCTIONS

Here you can monitor values of timer functions and the Real Time Clock.

Table 51. Monitoring of timer functions

Code	Monitoring value	Unit	Scale	ID	Description
V2.7.1	TC 1, TC 2, TC 3		1	1441	Possible to monitor the statuses of the three Time Channels (TC)
V2.7.2	Interval 1		1	1442	Status of timer interval
V2.7.3	Interval 2		1	1443	Status of timer interval
V2.7.4	Interval 3		1	1444	Status of timer interval
V2.7.5	Interval 4		1	1445	Status of timer interval
V2.7.6	Interval 5		1	1446	Status of timer interval
V2.7.7	Timer 1	s	1	1447	Remaining time on timer if active
V2.7.8	Timer 2	s	1	1448	Remaining time on timer if active
V2.7.9	Timer 3	s	1	1449	Remaining time on timer if active
V2.7.10	Real time clock			1450	hh:mm:ss

6.1.7 PID CONTROLLER

Table 52. PID Controller value monitoring

Code	Monitoring value	Unit	Scale	ID	Description
V2.8.1	PID setpoint	Varies	According to P3.13.1.7	20	PID controller setpoint value in process units. Process unit is selected with a parameter.
V2.8.2	PID feedback	Varies	According to P3.13.1.7	21	PID controller feedback value in process units. Process unit is selected with a parameter.
V2.8.3	PID error	Varies	According to P3.13.1.7	22	PID controller error value. Deviation of feedback from setpoint in process units. Process unit is selected with a parameter.
V2.8.4	PID output	%	0.01	23	PID output in percent (0...100%). This value can be fed e.g. to Motor Control (Frequency reference) or Analogue output
V2.8.5	PID status		1	24	0=Stopped 1=Running 3=Sleep mode 4=In dead band

6.1.8 EXTPID CONTROLLER

Table 53. External PID Controller value monitoring

Code	Monitoring value	Unit	Scale	ID	Description
V2.9.1	ExtPID setpoint	Varies	According to P3.14.1.10	83	External PID controller setpoint value in process units. Process unit is selected with a parameter.
V2.9.2	ExtPID feedback	Varies	According to P3.14.1.10	84	External PID controller feedback value in process units. Process unit is selected with a parameter.
V2.9.3	ExtPID error	Varies	According to P3.14.1.10	85	External PID controller Error value. Deviation of feedback from setpoint in process units. Process unit is selected with a parameter.
V2.9.4	ExtPID output	%	0.01	86	External PID controller output in percent (0..100%). This value can be fed e.g. to Analogue output.
V2.9.5	ExtPID status		1	87	0=Stopped 1=Running 4=In dead band

6.1.9 MAINTEN. COUNTERS

Table 54. Maintenance counter monitoring

Code	Monitoring value	Unit	Scale	ID	Description
V2.11.1	MaintenCounter 1	h/ kRev	Varies	1101	Status of maintenance counter in revolutions multiplied by 1000, or hours. For configuration and activation of this counter, see chapter Group 3.16: Maintenance counters.

6.1.10 FIELDBUS DATA

Table 55. Fieldbus data monitoring

Code	Monitoring value	Unit	Scale	ID	Description
V2.12.1	FB Control Word		1	874	Fieldbus control word used by application in bypass mode/format. Depending on the fieldbus type or profile the data can be modified before sent to application.
V2.12.2	FB Speed Reference		Varies	875	Speed reference scaled between minimum and maximum frequency at the moment it was received by the application. Minimum and maximum frequencies can be changed after the reference was received without affecting the reference.
V2.12.3	FB data in 1		1	876	Raw value of process data in 32-bit signed format
V2.12.4	FB data in 2		1	877	Raw value of process data in 32-bit signed format
V2.12.5	FB data in 3		1	878	Raw value of process data in 32-bit signed format
V2.12.6	FB data in 4		1	879	Raw value of process data in 32-bit signed format
V2.12.7	FB data in 5		1	880	Raw value of process data in 32-bit signed format
V2.12.8	FB data in 6		1	881	Raw value of process data in 32-bit signed format
V2.12.9	FB data in 7		1	882	Raw value of process data in 32-bit signed format
V2.12.10	FB data in 8		1	883	Raw value of process data in 32-bit signed format

Table 55. Fieldbus data monitoring

Code	Monitoring value	Unit	Scale	ID	Description
V2.12.11	FB Status Word		1	864	Fieldbus status word sent by application in bypass mode/format. Depending on the FB type or profile the data can be modified before sent to the FB.
V2.12.12	FB Speed Actual		0.01	865	Actual speed in %. 0 and 100% correspond to minimum and maximum frequencies respectively. This is continuously updated depending on the momentary min and max frequencies and the output frequency.
V2.12.13	FB data out 1		1	866	Raw value of process data in 32-bit signed format
V2.12.14	FB data out 2		1	867	Raw value of process data in 32-bit signed format
V2.12.15	FB data out 3		1	868	Raw value of process data in 32-bit signed format
V2.12.16	FB data out 4		1	869	Raw value of process data in 32-bit signed format
V2.12.17	FB data out 5		1	870	Raw value of process data in 32-bit signed format
V2.12.18	FB data out 6		1	871	Raw value of process data in 32-bit signed format
V2.12.19	FB data out 7		1	872	Raw value of process data in 32-bit signed format
V2.12.20	FB data out 8		1	873	Raw value of process data in 32-bit signed format

6.1.11 SOLAR

Table 56. Solar monitoring items

Code	Monitoring value	Unit	Scale	ID	Description
V2.15.1	Vmp ref	V		1914	DC voltage reference for MPP regulation
V2.15.2	Vmp ref correct	V		1942	Present correction on DC voltage reference (P&O + oscillation)
V2.15.3	Motor power	kW		1938	Motor shaft power
V2.15.4	Energy counter	MWh		1937	Counter of energy taken by the supply
B2.15.5	Energy counter reset			1932	To reset V2.15.4
V2.15.6	Irradiation measure	W/m ²		1982	Measurement from irradiation signal.

6.1.12 FLOW

Table 57. Flow monitoring items

Code	Monitoring value	Unit	Scale	ID	Description
V2.16.1	Actual flow	l/min		1956	Actual flow: it is measured by transducer define with P3.23.1
V2.16.2	Volume counter 1*	m ³		1955	Cumulative water volume counter.
V2.16.3	Volume counter 2*	10 ⁴ x m ³		1962	Cumulative water volume counter.
B2.16.4	Volume counters reset			1961	To reset V2.16.2 and V2.16.3

NOTE!

* The total volume of water in [m³] is given by: V2.16.2 + (V2.16.3 x 10000).

7. PARAMETERS

The VACON® AC drive contains a preloaded VACON® 100 X Solar Pump application for instant use. The parameters of this application are listed in this chapter.

7.1 APPLICATION PARAMETER LISTS

Find the parameter menu and the parameter groups as guided below.



The VACON® 100 X Solar Pump Application embodies the following parameter groups:

Table 58. Parameter groups

Menu and Parameter group	Description
Group 3.1: Motor settings	Basic and advanced motor settings
Group 3.2: Start/Stop setup	Start and stop functions
Group 3.3: References	Parameters for setting references and preset speeds.
Group 3.4: Ramps And Brakes	Acceleration/Deceleration setup
Group 3.5: I/O Config	I/O programming
Group 3.6: Fieldbus DataMap	Process data in/out mapping
Group 3.7: Prohibit Freq	Prohibit frequencies programming
Group 3.8: Supervisions	Programmable limit controllers
Group 3.9: Protections	Protections configuration
Group 3.10: Automatic reset	Auto reset after fault configuration
Group 3.11: Appl. Settings	Application settings
Group 3.12: Timer functions	Configuration of 3 timers based on Real Time Clock.
Group 3.13: PID Controller	Parameters for PID Controller 1.
Group 3.14: ExtPID Controller	Parameters for external PID Controller.
Group 3.16: Mainten. Counters	Parameters related to Maintenance counters.
Group 3.21: Pump Control	Pump function parameters
Group 3.22: Solar	Solar specific function parameters
Group 3.23: Flow meter	Flow meter parameters

7.1.1 COLUMN EXPLANATIONS

- Code = Location indication on the keypad; Shows the operator the parameter number.
- Parameter= Name of parameter
- Min = Minimum value of parameter
- Max = Maximum value of parameter
- Unit = Unit of parameter value; Given if available
- Default = Value preset by factory
- ID = ID number of the parameter
- Description= Short description of parameter values or its function
-  = More information on this parameter available; Click the parameter name

7.1.2 GROUP 3.1: MOTOR SETTINGS

7.1.2.1 Group 3.1.1: Motor nameplate

Table 59. Motor nameplate parameters

Code	Parameter	Min	Max	Unit	Default	ID	Description
P3.1.1.1	Motor Nom Voltg	Varies	Varies	V	Varies	110	Find this value U_n on the rating plate of the motor. Note also used connection (Delta/Star).
P3.1.1.2	Motor Nom Freq	8.00	320.00	Hz	Varies	111	Find this value f_n on the rating plate of the motor.
P3.1.1.3	Motor Nom Speed	24	19200	rpm	Varies	112	Find this value n_n on the rating plate of the motor.
P3.1.1.4	Motor Nom Currnt	Varies	Varies	A	Varies	113	Find this value I_n on the rating plate of the motor.
P3.1.1.5	Motor Cos Phi	0.30	1.00		0.74	120	Find this value on the rating plate of the motor
P3.1.1.6	Motor Nom Power	Varies	Varies	kW	Varies	116	Find this value P_n on the rating plate of the motor.

7.1.2.2 Group 3.1.2: Motor Control

Table 60. Motor control

Code	Parameter	Min	Max	Unit	Default	ID	Description
P3.1.2.1	Control mode	0	1		0	600	0 = U/f Freq ctrl open loop 1 = Speed control open loop
P3.1.2.2	Motor type	0	1		0	650	0 = Induction motor 1 = PM motor
P3.1.2.3	Switching Freq	1.5	Varies	kHz	Varies	601	Increasing the switching frequency reduces the capacity of the AC drive. It is recommended to use a lower frequency when the motor cable is long in order to minimize capacitive currents in the cable. Motor noise can also be minimised using a high switching frequency.

Table 60. Motor control

Code	Parameter	Min	Max	Unit	Default	ID	Description
P3.1.2.4	Identification	0	1		0	631	The automatic motor identification calculates or measures the motor parameters that are needed for optimum motor and speed control. 0 = No action 1 = At standstill
P3.1.2.5	Magnetizing current	0.0	2*IH	A	0.0	612	Motor magnetizing current (no-load current). The values of the U/f parameters are identified by the magnetizing current if given before the identification run. If this value is set to zero, magnetizing current will be internally calculated.
P3.1.2.6	Motor switch	0	1		0	653	Enabling this function prevents the drive from tripping when the motor switch is closed and opened e.g. using flying start. 0 = Disabled 1 = Enabled
P3.1.2.7	Load drooping	0.00	50.00	%	0.00	620	The drooping function enables speed drop as a function of load. Drooping will be defined in percent of nominal speed at nominal load.
P3.1.2.8	Load drooping time	0.00	2.00	s	0.00	656	Load drooping is used in order to achieve a dynamic speed drooping because of changing load. This parameter defines the time during which the speed is restored to the level it was before the load increase.
P3.1.2.9	Load drooping mode	0	1		0	1534	0 = Normal; Load drooping factor is constant through the whole frequency range 1 = Linear removal; Load drooping is removed linearly from nominal frequency to zero frequency
P3.1.2.11	Under Volt. Control	0	1		1	608	0 = Disabled 1 = Enabled
P3.1.2.12	Energy optimization	0	1		0	666	The drive searches for the minimum motor current in order to save energy and to lower the motor noise. This function can be used e.g. in fan and pump applications 0 = Disabled 1 = Enabled
P3.1.2.13	StatorVoltAdjust	50.0	150.0	%	100.0	659	Parameter for adjusting the stator voltage in permanent magnet motors.
P3.1.2.14	Overmodulation	0	1		1		Maximizes drive output voltage, but increases motor current harmonics. 0= Disabled 1= Enabled

7.1.2.3 *Group 3.1.3: Limits*

Table 61. Motor limit settings

Code	Parameter	Min	Max	Unit	Default	ID	Description
P3.1.3.1	Current limit	Varies	Varies	A	Varies	107	Maximum motor current from AC drive
P3.1.3.2	MotorTorqueLimit	0.0	300.0	%	300.0	1287	Maximum motoring side torque limit
P3.1.3.3	GenerTorqueLimit	0.0	300.0	%	300.0	1288	Maximum generating side torque limit
P3.1.3.4	MotorPowerLimit	0.0	300.0	%	300.0	1290	Maximum motoring side power limit
P3.1.3.5	GenerPowerLimit	0.0	300.0	%	300.0	1289	Maximum generating side power limit

7.1.2.4 *Group 3.1.4: Open loop*

Table 62. Open loop settings

Code	Parameter	Min	Max	Unit	Default	ID	Description
P3.1.4.1	U/f ratio	0	2		0	108	Type of U/f curve between zero frequency and the field weakening point. 0=Linear 1=Squared 2=Programmable
P3.1.4.2	Field WeakngPnt	8.00	P3.3.1.2	Hz	Varies	602	The field weakening point is the output frequency at which the output voltage reaches the field weakening point voltage
P3.1.4.3	Voltage at FWP	10.00	200.00	%	100.00	603	Voltage at field weakening point in % of motor nominal voltage
P3.1.4.4	U/f Mid Freq	0.00	P3.1.4.2	Hz	Varies	604	Provided that the programmable U/f curve has been selected (par. P3.1.4.1), this parameter defines the middle point frequency of the curve.
P3.1.4.5	U/f Mid Voltg	0.0	100.0	%	100.0	605	Provided that the programmable U/f curve has been selected (par. P3.1.4.1), this parameter defines the middle point voltage of the curve.
P3.1.4.6	Zero Freq Voltg	0.00	40.00	%	Varies	606	This parameter defines the zero frequency voltage of the U/f curve. The default value varies according to unit size.
P3.1.4.7	Flying Start Options	0	1		0	1590	Check box selection: B0 = Search shaft frequency from same direction as frequency reference. B1 = Disable AC scanning B4 = Use frequency reference for initial guess B5 = Disable DC pulses

Table 62. Open loop settings

Code	Parameter	Min	Max	Unit	Default	ID	Description
P3.1.4.8	FlyStartScanCurrent	0.0	100.0	%	45.0	1610	Defined in percentage of motor nominal current.
P3.1.4.9	Auto TorqueBoost	0	1		0	109	Automatic torque boost can be used in application where starting torque due to starting friction is high. 0= Disabled 1= Enabled
P3.1.4.10	Torque boost motor gain	0.0	100.0	%	100.0	667	Scaling factor for motoring side IR-compensation when torque boost is used.
P3.1.4.11	Torque boost generator gain	0.0	100.0	%	0.0	665	Scaling factor for generating side IR-compensation when torque boost is used.

7.1.2.5 Group 3.1.4.12: I/f start

The *I/f Start* function is typically used with permanent magnet synchronous motors (PMSM) to start the motor with constant current control. This is useful with high power motors in which the resistance is low and the tuning of the U/f curve difficult.

The *I/f Start* function can be used with induction motors (IM), too, e.g. if the tuning of the U/f curve is difficult at low frequencies.

Applying the *I/f Start* function may also prove useful in providing sufficient torque for the motor at startup.

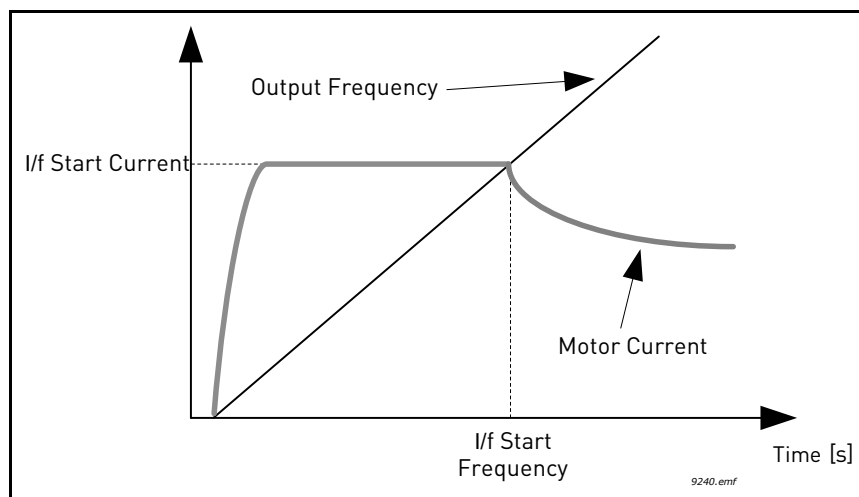

Figure 33. I/f start

Table 63. I/f start parameters

Code	Parameter	Min	Max	Unit	Default	ID	Description
P3.1.4.12.1	I/f start	0	1		0	534	0 = Disabled 1 = Enabled
P3.1.4.12.2	I/f start frequency	0.0	P3.1.1.2	%	15.0	535	Output frequency limit below which the defined I/f start current is fed to motor.
P3.1.4.12.3	I/f start current	0.0	100.0	%	80.0	536	The current fed to the motor when the I/f start function is activated.

7.1.2.6 Group 3.1.4.13: Stabilizers

Code	Parameter	Min	Max	Unit	Default	ID	Description
P3.1.4.13.1	TorqStabGain	0.0	500.0	%	50.0	1412	Gain of the torque stabilator in open loop motor control operation.
P3.1.4.13.2	TorqStabGainFWP	0.0	500.0	%	50.0	1414	Gain of the torque stabilator at field weakening point in open loop motor control operation.
P3.1.4.13.3	TorqStabDampTC	0.0005	1.0000	s	0.0050	1413	Damping time of torque stabilizer
P3.1.4.13.4	TorqStabDampTC PMM	0.0005	1.0000	s	0.0500	1735	Damping time constant of torque stabilizer for PM-motor.

7.1.3 GROUP 3.2: START/STOP SETUP

Start/Stop commands are given differently depending on the control place.

Remote control place (I/O A): Start, stop and reverse commands are controlled by 2 digital inputs chosen with parameters P3.5.1.1 and P3.5.1.2. The functionality/logic for these inputs is then selected with parameter P3.2.6 (in this group).

Remote control place (I/O B): Start, stop and reverse commands are controlled by 2 digital inputs chosen with parameters P3.5.1.4 and P3.5.1.5. The functionality/logic for these inputs is then selected with parameter P3.2.7 (in this group).

Local control place (Keypad): Start and stop commands come from the keypad buttons, while the direction of rotation is selected by the parameter P3.3.1.9.

Remote control place (Fieldbus): Start, stop and reverse commands come from fieldbus.

Table 64. Start/Stop Setup menu

Code	Parameter	Min	Max	Unit	Default	ID	Description
P3.2.1	Rem.Ctrl. Place	0	1		0	172	Selection of remote control place (start/stop). Can be used to change back to remote control from VACON® Live e.g. in case of a broken panel. 0=I/O control 1=Fieldbus control
P3.2.2	Local/Remote	0	1		0	211	Switch between local and remote control places 0=Remote 1=Local
P3.2.3	Keypad stop button	0	1		0	114	0=Stop button always enabled (Yes) 1=Limited function of Stop button (No)
P3.2.4	Start function	0	1		0	505	0=Ramping 1=Flying start
P3.2.5	Stop function	0	2		0	506	0: coasting 1: ramp to min frequency 2: ramp to zero frequency
P3.2.6	I/O A logic	0	4		1	300	Logic = 0: Start sign 1 = Start Forward Start sign 2 = Start Backward Logic = 1: Start sign 1 = Start Start sign 2 = Reverse Logic = 2: Double Start Logic = 3: Start sign 1 + Analogue sign Logic = 4: Solar only
P3.2.7	I/O B logic	0	4		1	363	See above.
P3.2.8	FB Start logic	0	1		0	889	0=Rising edge required 1=State

Table 64. Start/Stop Setup menu

Code	Parameter	Min	Max	Unit	Default	ID	Description
P3.2.10	Rem to Loc Funct	0	2		2	181	Choose whether to copy the Run state and Reference when changing from Remote to Local (keypad) control: 0 = Keep Run 1 = Keep Run & Reference 2 = Stop
P3.2.11	Start Analogue Signal	0	1		0	1810	0= AI1 1= AI2
P3.2.12	Start Analogue Level	0.00	100.00	%	10.00	1857	Start is set below this level (unscaled signal). Start-stop logic is reversed if > P3.2.13
P3.2.13	Stop Analogue Level	0.00	100.00	%	80.00	1856	Start is set above this level (unscaled signal). Start-stop logic is reversed if < P3.2.12

7.1.4 GROUP 3.3: REFERENCES

7.1.4.1 Frequency reference

The frequency reference source is programmable for all control places except *PC*, which always takes the reference from the *PC* tool.

Remote control place (I/O A): The source of frequency reference can be selected with parameter P3.3.1.5.

Remote control place (I/O B): The source of frequency reference can be selected with parameter P3.3.1.6.

Local control place (Keypad): If the default selection for parameter P3.3.1.7 is used the reference set with parameter P3.3.1.8 applies.

Remote control place (Fieldbus): The frequency reference comes from fieldbus if the default value for parameter P3.3.1.11 is kept.

Table 65. Frequency reference parameters

Code	Parameter	Min	Max	Unit	Default	ID	Description
P3.3.1.1	MinFreqReference	0.00	P3.3.1.2	Hz	0.00	101	Minimum allowed frequency reference
P3.3.1.2	MaxFreqReference	P3.3.1.1	320.00	Hz	50.00	102	Maximum allowed frequency reference
P3.3.1.3	PosFreqRefLimit	-320.0	320.0	Hz	320.00	1285	Final frequency reference limit for positive direction.
P3.3.1.4	NegFreqRefLimit	-320.0	320.0	Hz	-320.00	1286	Final frequency reference limit for negative direction. NOTE: This parameter can be used e.g. to prevent motor from running in reverse direction.
P3.3.1.5	I/O A Ref sel	1	9		5	117	Selection of ref source when control place is I/O A 1 = Preset Frequency 0 2 = Keypad reference 3 = Fieldbus 4 = AI1 5 = AI2 6 = AI1+AI2 7 = PID reference 8 = Motor potentiometer 9 = Max Power
P3.3.1.6	I/O B Ref sel	1	9		9	131	Selection of ref source when control place is I/O B. See above. NOTE: I/O B control place can only be forced active with digital input (P3.5.1.7).
P3.3.1.7	Keypad Ref Sel	1	9		2	121	Selection of ref source when control place is keypad: 1 = Preset Frequency 0 2 = Keypad reference 3 = Fieldbus 4 = AI1 5 = AI2 6 = AI1+AI2 7 = PID reference 8 = Motor potentiometer 9 = Max Power

Table 65. Frequency reference parameters

Code	Parameter	Min	Max	Unit	Default	ID	Description
P3.3.1.8	Keypad Reference	0.00	P3.3.1.2	Hz	0.00	184	The frequency reference can be adjusted on the keypad with this parameter.
P3.3.1.9	Keypad Direction	0	1		0	123	Motor rotation when control place is keypad 0 = Forward 1 = Reverse
P3.3.1.10	Fieldbus Ref Sel	1	9		3	122	Selection of ref source when control place is Fieldbus: 1 = Preset Frequency 0 2 = Keypad reference 3 = Fieldbus 4 = AI1 5 = AI2 6 = AI1+AI2 7 = PID reference 8 = Motor potentiometer 9 = Max Power
P3.3.1.11	Adapt To AC Volt.	No	Yes		No	1931	Parameter enables the possible limitation on maximum output frequency when connected to AC mains (digital input from P3.5.1.53 is active), in case the available voltage is not sufficient to reach the motor nominal U/f ratio (from P3.1.1.1 and P3.1.1.2). The function can be useful if the motor has been chosen depending on high DC voltage from solar modules, but this voltage is not reachable with AC supply.

7.1.4.2 Group 3.3.3: Preset Freqs

Table 66. Preset frequencies parameters







Code	Parameter	Min	Max	Unit	Default	ID	Description
 P3.3.3.1	PresetFreqMode	0	1		0	182	0 = Binary coded 1 = Number of inputs. Preset frequency is selected according to how many of preset speed digital inputs are active
 P3.3.3.2	Preset Freq 0	P3.3.1.1	P3.3.1.2	Hz	5.00	180	Basic preset frequency 0 when selected by Control reference parameter (P3.3.1.5).
 P3.3.3.3	Preset Freq 1	P3.3.1.1	P3.3.1.2	Hz	10.00	105	Select with digital input: Preset frequency selection 0 (P3.3.3.10)
 P3.3.3.4	Preset Freq 2	P3.3.1.1	P3.3.1.2	Hz	15.00	106	Select with digital input: Preset frequency selection 1 (P3.3.3.11)
 P3.3.3.5	Preset Freq 3	P3.3.1.1	P3.3.1.2	Hz	20.00	126	Select with digital inputs: Preset frequency selection 0 & 1
 P3.3.3.6	Preset Freq 4	P3.3.1.1	P3.3.1.2	Hz	25.00	127	Select with digital input: Preset frequency selection 2 (P3.3.3.12)

Table 66. Preset frequencies parameters

Code	Parameter	Min	Max	Unit	Default	ID	Description
P3.3.3.7	Preset Freq 5	P3.3.1.1	P3.3.1.2	Hz	30.00	128	Select with digital inputs: Preset frequency selection 0 & 2
P3.3.3.8	Preset Freq 6	P3.3.1.1	P3.3.1.2	Hz	40.00	129	Select with digital inputs: Preset frequency selection 1 & 2
P3.3.3.9	Preset Freq 7	P3.3.1.1	P3.3.1.2	Hz	50.00	130	Select with digital inputs: Preset frequency selection 0 & 1 & 2
P3.3.3.10	Preset Freq Sel0				DigIN SlotA.4	419	Binary selector for Preset speeds (0-7). See parameters P3.3.3.2 to P3.3.3.9.
P3.3.3.11	Preset Freq Sel1				DigIN SlotA.5	420	Binary selector for Preset speeds (0-7). See parameters P3.3.3.2 to P3.3.3.9.
P3.3.3.12	Preset Freq Sel2				DigIN Slot0.1	421	Binary selector for Preset speeds (0-7). See parameters P3.3.3.2 to P3.3.3.9.

7.1.4.3 Group 3.3.4: Motor Potentiom

With a motor potentiometer function, the user can increase and decrease the output frequency. By connecting a digital input to parameter P3.3.4.1 (*MotPot UP*) and having the digital input signal active, the output frequency will rise as long as the signal is active. The parameter P3.3.4.2 (*MotPot DOWN*) works vice versa, decreasing the output frequency.

The rate how the output frequency either rises or falls when Motor Potentiometer Up or Down is activated is determined by the *Motor potentiometer ramp time* (P3.3.4.3)

The Motor potentiometer reset parameter (P3.3.4.4) is used to choose whether to reset (set to Min-Freq) the Motor Potentiometer frequency reference when stopped or when powered down.

Motor potentiometer frequency reference is available in all control places in menu Group 3.3: References. The motor potentiometer reference can be changed only when the drive is in run state.

Table 67. Motor potentiometer parameters

Code	Parameter	Min	Max	Unit	Default	ID	Description
P3.3.4.1	MotPot UP				DigIN Slot0.1	418	FALSE = Not active TRUE = Active (Motor potentiometer reference INCREASES until the contact is opened)
P3.3.4.2	MotPot DOWN				DigIN Slot0.1	417	FALSE = Not active TRUE = Active (Motor potentiometer reference DECREASES until the contact is opened)
P3.3.4.3	MotPot Ramp Time	0.1	500.0	Hz/s	10.0	331	Rate of change in the motor potentiometer reference when increased or decreased with parameters P3.3.4.1 or P3.3.4.2.
P3.3.4.4	MotPot Reset	0	2		1	367	Motor potentiometer frequency reference reset logic. 0 = No reset 1 = Reset if stopped 2 = Reset if powered down

7.1.5 GROUP 3.4: RAMPS AND BRAKES

7.1.5.1 Group 3.4.1: Ramp 1

Table 68. Ramp 1 setup

Code	Parameter	Min	Max	Unit	Default	ID	Description
P3.4.1.2	Accel Time 1	0.1	3000.0	s	5.0	103	Defines the time required for the output frequency to increase from zero frequency to maximum frequency
P3.4.1.3	Decel Time 1	0.1	3000.0	s	5.0	104	Defines the time required for the output frequency to decrease from maximum frequency to zero frequency
P3.4.1.4	Start Acceleration Time	0.1	3000.0	s	2.0	502	Time from 0 to min frequency

7.1.5.2 Group 3.4.3: Start Magnetizat

Table 69. Start magnetization parameters

Code	Parameter	Min	Max	Unit	Default	ID	Description
P3.4.3.1	StartMagnCurrent	0.00	Varies	A	Varies	517	Defines the DC current fed into motor at start. Disabled if set to 0.
P3.4.3.2	StartMagnTime	0,00	600,00	s	0,00	516	This parameter defines the time for how long DC current is fed to motor before acceleration starts.

7.1.5.3 Group 3.4.3: DC brake

Table 70. DC-brake parameters

Code	Parameter	Min	Max	Unit	Default	ID	Description
P3.4.4.1	DC Brake Current	Varies	Varies	A	Varies	507	Defines the current injected into the motor during DC-braking. 0 = Disabled
P3.4.4.2	DC BrakeTime	0,00	600,00	s	0,00	508	Determines if braking is ON or OFF and the braking time of the DC-brake when the motor is stopping.
P3.4.4.3	DC Start Freq	0,10	10,00	Hz	1,50	515	The output frequency at which the DC-braking is applied.

7.1.5.4 Group 3.4.5: Flux Braking

Table 71. Flux braking parameters

Code	Parameter	Min	Max	Unit	Default	ID	Description
P3.4.5.1	Flux Braking	0	1		0	520	0=Disabled 1=Enabled
P3.4.5.2	Braking Current	0	Varies	A	Varies	519	Defines the current level for flux braking.

7.1.6 GROUP 3.5: I/O CONFIG

7.1.6.1 *Default assignments of programmable inputs*

Table 72 below presents the default assignments of programmable digital and analogue inputs in VACON® 100 X Solar Pump application.

Table 72. Default assignments of inputs

Input	Terminal(s)	Reference	Assigned function	Parameter code
D11	8	A.1	Ctrl signal 1 A	P3.5.1.1
D12	9	A.2	Ctrl signal 2 A	P3.5.1.2
D13	10	A.3	External fault close	P3.5.1.11
D14	14	A.4	Preset frequency selection 0	P3.5.1.21
D15	15	A.5	Preset frequency selection 1	P3.5.1.22
D16	16	A.6	External fault close	P3.5.1.13
A11	2/3	A.1	A11 signal selection	P3.5.2.1.1
A12	4/5	A.2	A12 signal selection	P3.5.2.2.1

7.1.6.2 *Group 3.5.1: Digital inputs*

Digital inputs are very flexible to use. Parameters are functions that are connected to the required digital input terminal (see chapter 5). The digital inputs are represented as, for example, *DigIN Slot A.2*, meaning the second input on slot A.

It is also possible to connect the digital inputs to time channels which are also represented as terminals.

NOTE! The statuses of digital inputs and the digital output can be monitored in the Multimonitoring view.

Table 73. Digital input settings

Code	Parameter	Default	ID	Description
P3.5.1.1	Ctrl signal 1 A	DigIN SlotA.1	403	Ctrl signal 1 when control place is I/O A (FWD)
P3.5.1.2	Ctrl signal 2 A	DigIN SlotA.2	404	Ctrl signal 2 when control place is I/O A (REV)
P3.5.1.4	Ctrl signal 1 B	DigIN Slot0.1	423	Start signal 1 when control place is I/O B
P3.5.1.5	Ctrl signal 2 B	DigIN Slot0.1	424	Start signal 2 when control place is I/O B
P3.5.1.7	I/O B Ctrl Force	DigIN Slot0.1	425	TRUE = Force the control place to I/O B
P3.5.1.8	I/O B Ref Force	DigIN Slot0.1	343	TRUE = Used frequency reference is specified by I/O reference B parameter (P3.3.1.6).
P3.5.1.9	Fieldbus Ctrl Force	DigIN Slot0.1	411	Force control to fieldbus
P3.5.1.10	Keypad Ctrl Force	DigIN Slot0.1	410	Force control to keypad
P3.5.1.11	Ext Fault Close	DigIN SlotA.3	405	FALSE = OK TRUE = External fault
P3.5.1.12	Ext Fault Open	DigIN Slot0.2	406	FALSE = External fault TRUE = OK
P3.5.1.13	Fault Reset Close	DigIN SlotA.6	414	Resets all active faults when TRUE
P3.5.1.14	Fault Reset Open	DigIN Slot0.1	213	Resets all active faults when FALSE
P3.5.1.15	Run Enable	DigIN Slot0.2	407	Must be on to set drive in Ready state



Table 73. Digital input settings

Code	Parameter	Default	ID	Description
P3.5.1.16	Run Interlock 1	DigIN Slot0.2	1041	Drive may be ready but start is blocked as long as interlock is on (Damper interlock).
P3.5.1.17	Run Interlock 2	DigIN Slot0.2	1042	As above.
P3.5.1.21	Preset Freq Sel0	DigIN SlotA.4	419	Binary selector for Preset speeds (0-7). See page 100.
P3.5.1.22	Preset Freq Sel1	DigIN SlotA.5	420	Binary selector for Preset speeds (0-7). See page 100.
P3.5.1.23	Preset Freq Sel2	DigIN Slot0.1	421	Binary selector for Preset speeds (0-7). See page 100.
P3.5.1.24	MotPot UP	DigIN Slot0.1	418	FALSE = Not active TRUE = Active (Motor potentiometer reference INCREASES until the contact is opened)
P3.5.1.25	MotPot DOWN	DigIN Slot0.1	417	FALSE = Not active TRUE = Active (Motor potentiometer reference DECREASES until the contact is opened)
P3.5.1.27	Timer 1	DigIN Slot0.1	447	Rising edge starts Timer 1 programmed in Group 3.12: Timer functions parameter group
P3.5.1.28	Timer 2	DigIN Slot0.1	448	See above
P3.5.1.29	Timer 3	DigIN Slot0.1	449	See above
P3.5.1.30	PID SP Boost	DigIN Slot0.1	1046	FALSE = No boost TRUE = Boost
P3.5.1.31	PID SP Selection	DigIN Slot0.1	1047	FALSE = Setpoint 1 TRUE = Setpoint 2
P3.5.1.32	ExtPID StartSignal	DigIN Slot0.2	1049	FALSE = PID2 in stop mode TRUE = PID2 regulating This parameter will have no effect if the external PID-controller is not enabled in Group 3.14: ExtPID Controller.
P3.5.1.33	ExtPID SP Select	DigIN Slot0.1	1048	FALSE = Setpoint 1 TRUE = Setpoint 2
P3.5.1.40	MainCounter1Reset	DigIN Slot0.1	490	Reset the counter from digital input. TRUE = Reset
P3.5.1.48	AutoClean Activ.	DigIN Slot0.1	1715	Start the Auto-cleaning sequence. The sequence will be aborted if activation signal is removed before the sequence has been completed. NOTE! The drive will start if the input is activated!
P3.5.1.49	Param. Set 1/2 Sel.	DigIN Slot0.1	496	Parameter set 1/2 selection. Open= Parameter Set 1 Closed= Parameter Set 2
P3.5.1.50	User Defined Fault 1	DigIN Slot0.1	1552 3	Digital input selection for activating User Defined Fault (1 or 2). Open= No operation Closed= Fault Activated
P3.5.1.51	User Defined Fault 2	DigIN Slot0.1	1552 4	Digital input selection for activating User Defined Fault (1 or 2). Open= No operation Closed= Fault Activated
P3.5.1.52	Energy Counter reset	DigIN Slot0.1	1933	Energy Counter reset
P3.5.1.53	Mains supply on	DigIN Slot0.1	1934	Mains supply on
P3.5.1.54	Flowmeter pulse	DigIN Slot0.1	1953	Digital input for pulse flow meter (P3.23.1 = 1)
P3.5.1.55	Volume counters reset	DigIN Slot0.1	1957	Digital input for Volume counters reset
P3.5.1.56	Minimum water level	DigIN Slot0.2	1963	Digital input for minimum water level in the well

Table 73. Digital input settings

Code	Parameter	Default	ID	Description
P3.5.1.57	Minimum level logic	Level ok = input high	1965	Selections for minimum water level logic: 0 = water level is ok when digital input for Minimum water level is high 1 = water level is ok when digital input for Minimum water level is low The drive trips with F63 (Low water level) when water level is not OK. The fault is reset with autoreset logic of Under load (see P3.10.5 - 8) when level is restored. Min level signal/fault refers to level in a well from which water is taken.
P3.5.1.58	Maximum water level	DigIN Slot0.2	1966	Digital input for maximum water level in the well
P3.5.1.59	Maximum level logic	Level ok = input high	1967	Selections for maximum water level logic: 0 = water level is ok when digital input for Maximum water level is high 1 = water level is ok when digital input for Maximum water level is low The drive trips with F64 (Max water level) when water level is not ok. The fault is reset with autoreset logic of Underload (see P3.10.5 - 8) when level is restored. Max level signal/fault refers to level in a possible tank where pumped water is stored.
P3.5.1.60	Dual Supply Enable	DigIN Slot0.2	1991	Digital input high enables relay for the AC switch connection and Dual supply mode logics.
P3.5.1.61	DualS M2Check Disable	DigIN Slot0.1	1989	Digital input high disables the periodic Mode 2 DC voltage check, when Dual supply Mode 2 sensorless is active.

7.1.6.3 Group 3.5.2: Analog inputs

NOTE! The number of usable analogue inputs depends on your (option) board setup. The standard I/O board embodies 2 analogue inputs.

Group 3.5.2.1: Analog Input 1

Table 74. Analogue input 1 settings

Code	Parameter	Min	Max	Unit	Default	ID	Description
P3.5.2.1.1	AI1 signal selection				AnIN SlotA.1	377	Connect the AI1 signal to the analogue input of your choice with this parameter. Programmable. See page 92.
P3.5.2.1.2	AI1 signal filter time	0.00	300.00	s	0.1	378	Filter time for analogue input.
P3.5.2.1.3	AI1 signal range	0	1		0	379	0 = 0...10 V / 0...20 mA 1 = 2...10 V / 4...20 mA
P3.5.2.1.4	AI1 custom. min	-160.00	160.00	%	0.00	380	Custom range min setting 20% = 4-20 mA/2-10 V
P3.5.2.1.5	AI1 custom. max	-160.00	160.00	%	100.00	381	Custom range max setting
P3.5.2.1.6	AI1 signal inversion	0	1		0	387	0 = Normal 1 = Signal inverted

Group 3.5.2.2: Analog Input 2

Table 75. Analogue input 2 settings

Code	Parameter	Min	Max	Unit	Default	ID	Description
P3.5.2.2.1	AI2 signal selection				AnIN SlotA.2	388	See P3.5.2.1.1.

Table 75. Analogue input 2 settings

P3.5.2.2.2	AI2 signal filter time	0.00	300.00	s	0.1	389	See P3.5.2.1.2.
P3.5.2.2.3	AI2 signal range	0	1		1	390	See P3.5.2.1.3
P3.5.2.2.4	AI2 custom. min	-160.00	160.00	%	0.00	391	See P3.5.2.1.4.
P3.5.2.2.5	AI2 custom. max	-160.00	160.00	%	100.00	392	See P3.5.2.1.5.
P3.5.2.2.6	AI2 signal inversion	0	1		0	398	See P3.5.2.1.6.

Group 3.5.2.3: Analog Input 3

Table 76. Analogue input 3 settings

Code	Parameter	Min	Max	Unit	Default	ID	Description
P3.5.2.3.1	AI3 signal selection				AnIN SlotD.1	141	See P3.5.2.1.1.
P3.5.2.3.2	AI3 signal filter time	0.00	300.00	s	0.1	142	See P3.5.2.1.2.
P3.5.2.3.3	AI3 signal range	0	1		0	143	See P3.5.2.1.3
P3.5.2.3.4	AI3 custom. min	-160.00	160.00	%	0.00	144	See P3.5.2.1.4.
P3.5.2.3.5	AI3 custom. max	-160.00	160.00	%	100.00	145	See P3.5.2.1.5.
P3.5.2.3.6	AI3 signal inversion	0	1		0	151	See P3.5.2.1.6.

Group 3.5.2.4: Analog Input 4

Table 77. Analogue input 4 settings

Code	Parameter	Min	Max	Unit	Default	ID	Description
P3.5.2.4.1	AI4 signal selection				AnIN SlotD.2	152	See P3.5.2.1.1.
P3.5.2.4.2	AI4 signal filter time	0.00	300.00	s	0.1	153	See P3.5.2.1.2.
P3.5.2.4.3	AI4 signal range	0	1		0	154	See P3.5.2.1.3
P3.5.2.4.4	AI4 custom. min	-160.00	160.00	%	0.00	155	See P3.5.2.1.4.
P3.5.2.4.5	AI4 custom. max	-160.00	160.00	%	100.00	156	See P3.5.2.1.5.
P3.5.2.4.6	AI4 signal inversion	0	1		0	162	See P3.5.2.1.6.

Group 3.5.2.5: Analog Input 5

Table 78. Analogue input 5 settings

Code	Parameter	Min	Max	Unit	Default	ID	Description
P3.5.2.5.1	AI5 signal selection				AnIN SlotE.1	188	See P3.5.2.1.1.
P3.5.2.5.2	AI5 signal filter time	0.00	300.00	s	0.1	189	See P3.5.2.1.2.
P3.5.2.5.3	AI5 signal range	0	1		0	190	See P3.5.2.1.3
P3.5.2.5.4	AI5 custom. min	-160.00	160.00	%	0.00	191	See P3.5.2.1.4.
P3.5.2.5.5	AI5 custom. max	-160.00	160.00	%	100.00	192	See P3.5.2.1.5.
P3.5.2.5.6	AI5 signal inversion	0	1		0	198	See P3.5.2.1.6.

Group 3.5.2.6: Analog Input 6*Table 79. Analogue input 6 settings*

Code	Parameter	Min	Max	Unit	Default	ID	Description
P3.5.2.6.1	AI6 signal selection				AnIN SlotE.2	199	See P3.5.2.1.1.
P3.5.2.6.2	AI6 signal filter time	0.00	300.00	s	0.1	200	See P3.5.2.1.2.
P3.5.2.6.3	AI6 signal range	0	1		0	201	See P3.5.2.1.3.
P3.5.2.6.4	AI6 custom. min	-160.00	160.00	%	0.00	202	See P3.5.2.1.4.
P3.5.2.6.5	AI6 custom. max	-160.00	160.00	%	100.00	203	See P3.5.2.1.5.
P3.5.2.6.6	AI6 signal inversion	0	1		0	209	See P3.5.2.1.6.

7.1.6.4 *Group 3.5.3: Digital outputs*

Group 3.5.3.2: Slot B Basic

Table 80. Digital output settings on standard I/O board

Code	Parameter	Min	Max	Unit	Default	ID	Description
P3.5.3.2.1	R01 function	0	60		2	11001	Function selection for Basic R01: 0 = None 1 = Ready 2 = Run 3 = General fault 4 = General fault inverted 5 = General alarm 6 = Reversed 7 = At speed 8 = Thermistor fault 9 = Motor regulator active 10 = Start signal active 11 = Keypad control active 12 = I/O B control activated 13 = Limit supervision 1 14 = Limit supervision 2 15 = SinglePowerOn 16 = No function 17 = Preset speed active 18 = No function 19 = PID in Sleep mode 20 = PID soft fill active 21 = PID supervision limits 22 = Ext. PID superv. limits 23 = Input press. alarm/fault 24 = Frost prot. alarm/fault 25 - 30 = No function 31 = RTC time chnl 1 control 32 = RTC time chnl 2 control 33 = RTC time chnl 3 control 34 = FB ControlWord B13 35 = FB ControlWord B14 36 = FB ControlWord B15 37 = FB ProcessData1.B0 38 = FB ProcessData1.B1 39 = FB ProcessData1.B2 40 = Maintenance alarm 41 = Maintenance fault 42 = No function 43 = No function 54 -55 = No function 56 = Auto-cleaning active 57 = Motor Switch Open 58 = TEST (Always Closed) 59 = No function 60 = DualSupply AC switch
M3.5.3.2.2	Basic R01 ON delay	0.00	320.00	s	0.00	11002	ON delay for relay
M3.5.3.2.3	Basic R01 OFF delay	0.00	320.00	s	0.00	11003	OFF delay for relay
M3.5.3.2.4	Basic R02 function	0	59		3	11004	See P3.5.3.2.1
M3.5.3.2.5	Basic R02 ON delay	0.00	320.00	s	0.00	11005	See M3.5.3.2.2.
M3.5.3.2.6	Basic R02 OFF delay	0.00	320.00	s	0.00	11006	See M3.5.3.2.3.



7.1.6.5 Expander slots D and E digital outputs

Shows only parameters for existing outputs on option boards placed in slots D and E. Selections as in Standard R01 (P3.5.3.2.1).

This group or these parameters are not visible if no digital outputs exist in slots D or E.

7.1.6.6 Group 3.5.4: Analogue outputs

Group 3.5.4.1: Slot A Basic

Table 81. Standard I/O board analogue output settings

Code	Parameter	Min	Max	Unit	Default	ID	Description
P3.5.4.1.1	A01 function	0	19		2	10050	0=TEST 0% (Not used) 1=TEST 100% 2=Output freq (0 -fmax) 3=Freq reference (0-fmax) 4=Motor speed (0 - Motor nominal speed) 5=Output current (0-I _{nMotor}) 6=Motor torque (0-T _{nMotor}) 7=Motor power (0-P _{nMotor}) 8=Motor voltage (0-U _{nMotor}) 9=DC link voltage (0-1000 V) 10=PID1 output (0-100%) 11=Ext.PID output (0-100%) 12=ProcessDataIn1 (0-100%) 13=ProcessDataIn2 (0-100%) 14=ProcessDataIn3 (0-100%) 15=ProcessDataIn4 (0-100%) 16=ProcessDataIn5 (0-100%) 17=ProcessDataIn6 (0-100%) 18=ProcessDataIn7 (0-100%) 19=ProcessDataIn8 (0-100%)
P3.5.4.1.2	A01 filter time	0.0	300.0	s	1.0	10051	Filtering time of analogue output signal. See P3.5.2.1.2 0 = No filtering
P3.5.4.1.3	A01 minimum	0	1		0	10052	0 = 0 mA / 0 V 1 = 4 mA / 2 V Signal type (current/voltage) selected with dip switches. Note the difference in analogue output scaling in parameter P3.5.4.1.4. See also parameter P3.5.2.1.3.
P3.5.4.1.4	A01 minimum scale	Varies	Varies	Varies	0.0	10053	Min scale in process unit (depends on selection of A01 function).
P3.5.4.1.5	A01 maximum scale	Varies	Varies	Varies	0.0	10054	Max scale in process unit (depends on selection of A01 function)

7.1.6.7 Expander slots D to E analogue outputs

Shows only parameters for existing outputs on option boards placed in slots D and E. Selections as in Standard A01 (P3.5.4.1.1).

This group or these parameters are not visible if no digital outputs exist in slots D or E.

7.1.7 GROUP 3.6: FIELD BUS DATAMAP

Table 82. Fieldbus data mapping

Code	Parameter	Min	Max	Unit	Default	ID	Description
P3.6.1	FB DataOut 1 Sel	0	35000		1	852	Data sent to fieldbus can be chosen with parameter and monitor value ID numbers. The data is scaled to unsigned 16-bit format according to the format on keypad. E.g. 25.5 on keypad equals 255.
P3.6.2	FB DataOut 2 Sel	0	35000		2	853	Select Process Data Out with parameter ID
P3.6.3	FB DataOut 3 Sel	0	35000		3	854	Select Process Data Out with parameter ID
P3.6.4	FB DataOut 4 Sel	0	35000		4	855	Select Process Data Out with parameter ID
P3.6.5	FB DataOut 5 Sel	0	35000		5	856	Select Process Data Out with parameter ID
P3.6.6	FB DataOut 6 Sel	0	35000		6	857	Select Process Data Out with parameter ID
P3.6.7	FB DataOut 7 Sel	0	35000		7	858	Select Process Data Out with parameter ID
P3.6.8	FB DataOut 8 Sel	0	35000		37	859	Select Process Data Out with parameter ID

Fieldbus process data out

Default values for Process Data Out to monitor through fieldbus are listed in Table 83.

Table 83. Fieldbus Process Data Out

Data	Value	Scale
Process Data Out 1	Output frequency	0.01 Hz
Process Data Out 2	Motor speed	1 rpm
Process Data Out 3	Motor current	0.1 A
Process Data Out 4	Motor torque	0.1%
Process Data Out 5	Motor power	0.1%
Process Data Out 6	Motor voltage	0.1 V
Process Data Out 7	DC-link voltage	1 V
Process Data Out 8	Last active fault code	1

Example: Value '2500' for *Output Frequency* corresponds to '25.00 Hz' (scaling value is 0.01).

All monitoring values listed in chapter 6 are given the scaling value.

7.1.8 GROUP 3.7: PROHIBIT FREQ

In some systems it may be necessary to avoid certain frequencies due to mechanical resonance problems. By setting up prohibit frequencies it is possible to skip these ranges. When the (input) frequency reference is increased, the internal frequency reference is kept at the low limit until the (input) reference is above the high limit.

Table 84. Prohibit frequencies

Code	Parameter	Min	Max	Unit	Default	ID	Description
P3.7.1	Range 1 Low Lim	-1,00	320,00	Hz	0,00	509	0 = Not used
P3.7.2	Range 1 High Lim	0,00	320,00	Hz	0,00	510	0 = Not used
P3.7.3	Range 2 Low Lim	0,00	320,00	Hz	0,00	511	0 = Not used
P3.7.4	Range 2 High Lim	0,00	320,00	Hz	0,00	512	0 = Not used
P3.7.5	Range 3 Low Lim	0,00	320,00	Hz	0,00	513	0 = Not used
P3.7.6	Range 3 High Lim	0,00	320,00	Hz	0,00	514	0 = Not used
P3.7.7	Ramp TimeFactor	0,1	10,0	Times	1,0	518	Multiplier of the currently selected ramp time between prohibit frequency limits.

7.1.9 GROUP 3.8: SUPERVISIONS

Choose here:

1. one or two (P3.8.1/P3.8.5) signal values for supervision.
2. whether the low or high limits are supervised (P3.8.2/P3.8.6)
3. the actual limit values (P3.8.3/P3.8.7).
4. the hystereses for the set limit values (P3.8.4/P3.8.8).

Table 85. Supervision settings

Code	Parameter	Min	Max	Unit	Default	ID	Description
P3.8.1	Superv1 Item	0	11		0	1431	0 = Output frequency 1 = Frequency reference 2 = Motor current 3 = Motor torque 4 = Motor power 5 = DC-link voltage 6 = Analogue input 1 7 = Analogue input 2 8 = Analogue input 3 9 = Analogue input 4 10 = Analogue input 5 11 = Analogue input 6
P3.8.2	Superv1 Mode	0	2		0	1432	0 = Not used 1 = Low limit supervision (output active under limit) 2 = High limit supervision (output active over limit)
P3.8.3	Superv1 Limit	-50.00	50.00	Varies	25.00	1433	Supervision limit for selected item. Unit appears automatically.
P3.8.4	Superv1 Hyst	0.00	50.00	Varies	5.00	1434	Supervision limit hysteresis for selected item. Unit is set automatically.
P3.8.5	Superv2 Item	0	11		1	1435	See P3.8.1
P3.8.6	Superv2 Mode	0	2		0	1436	See P3.8.2
P3.8.7	Superv2 Limit	-50.00	50.00	Varies	40.00	1437	See P3.8.3

Table 85. Supervision settings

P3.8.8	Superv2 Hyst	0.00	50.00	Varies	5.00	1438	See P3.8.4
P3.8.9	Single PO Threshold	150	500	V	300	1968	Single PO (Power On) Treshold can be used to set level for R01 or R02 to switch off when DC voltage goes below the setting level. The relay function must be programmed as 15/Single Power On. Relay can be used to control to connect additional resistor into DC supply. Resistor will eliminate power on/off cycle when supply voltage drops into drive shut down level. Resistor size can be selected approximately equal to drive standby losses.

7.1.10 GROUP 3.9: PROTECTIONS

7.1.10.1 Group 3.9.1: General

Table 86. General protections settings

Code	Parameter	Min	Max	Unit	Default	ID	Description
P3.9.1.2	External fault	0	3		2	701	0 = No action 1 = Alarm 2 = Fault (Stop according to stop mode) 3 = Fault (Stop by coasting)
P3.9.1.3	InputPhase Fault	0	1		1	730	0= 3 Phases support 1= 1 Phase support
P3.9.1.4	Undervoltage Flt	0	1		0	727	0 = Fault stored in history 1 = Fault not stored in history
P3.9.1.5	OutputPhase Flt	0	3		2	702	See P3.9.1.2
P3.9.1.6	FieldbusComm Flt	0	4		3	733	0 = No action 1 = Alarm 2 = Alarm, PresetFreq 3 = Fault (Stop according to stop mode) 4 = Fault (Stop by coasting)
P3.9.1.7	SlotComm Flt	0	3		2	734	See P3.9.1.2
P3.9.1.8	Thermistor Fault	0	3		0	732	See P3.9.1.2
P3.9.1.9	PID SoftFill Fault	0	3		2	748	See P3.9.1.2
P3.9.1.10	PID Supervision	0	3		2	749	See P3.9.1.2
P3.9.1.11	ExtPID Supervision	0	3		2	757	See P3.9.1.2
P3.9.1.13	PresetAlarmFreq	P3.3.1.1	P3.3.1.2	Hz	25.00	183	This frequency used when fault response (in Group 3.9: Protections) is Alarm+preset frequency
P3.9.1.14	STO Fault	0	3		3	775	Defines drive operation when STO function has been activated (eg. Emergency stop button has been pressed).

7.1.10.2 Group 3.9.2: Motor Therm Prot

The motor thermal protection is to protect the motor from overheating. The AC drive is capable of supplying higher than nominal current to the motor. If the load requires this high current there is a risk that the motor will be thermally overloaded. This is the case especially at low frequencies. At low frequencies the cooling effect of the motor is reduced as well as its capacity. If the motor is equipped with an external fan the load reduction at low speeds is small.

The motor thermal protection is based on a calculated model and it uses the output current of the drive to determine the load on the motor.

The motor thermal protection can be adjusted with parameters. The thermal current IT specifies the load current above which the motor is overloaded. This current limit is a function of the output frequency.

The thermal stage of the motor can be monitored on the control keypad display. See chapter 7.1.



	NOTE! If you use long motor cables (max. 100 m) together with small drives (≤ 1.5 kW) the motor current measured by the drive can be much higher than the actual motor current due to capacitive currents in the motor cable. Consider this when setting up the motor thermal protection functions.
	CAUTION! The calculated model does not protect the motor if the airflow to the motor is reduced by blocked air intake grill. The model starts from zero if the control board is powered off.

Table 87. Motor thermal protection settings



Code	Parameter	Min	Max	Unit	Default	ID	Description
P3.9.2.1	Motor Therm Prot	0	3		2	704	0 = No action 1 = Alarm 2 = Fault (Stop according to stop mode) 3 = Fault (Stop by coasting) If available, use the motor thermistor to protect the motor. Choose then value 0 for this parameter.
P3.9.2.2	MotAmbient Temp	-20.0	100.0	°C	40.0	705	Ambient temperature in °C
 P3.9.2.3	ZeroSpeedCooling	5.0	150.0	%	Varies	706	Defines the cooling factor at zero speed in relation to the point where the motor is running at nominal speed without external cooling.
 P3.9.2.4	ThermTimeConst	1	200	min	Varies	707	The time constant is the time within which the calculated thermal stage has reached 63% of its final value.
 P3.9.2.5	MotThermLoadbil	10	150	%	100	708	Motor thermal Loadability states how much the motor can be thermally loaded. E.g. 90% means that the motor temperature will settle around 100% when continuously running at 90% of nominal load.

Table 87. Motor thermal protection settings

P3.9.2.6	MotTempInitialMode	0	3		2	777	The estimated temperature rise is added to a motor ambient temperature set by the parameter P3.9.2.2 MotAmbientTemp. 0 = Disabled 2 = Last value 3 = Real time clock
P3.9.2.7	MotTempInitialAdjust	0.0	100.0	%	33.0	778	Motor thermal memory adjust [%]. Depending on the parameter P3.9.2.6 MotTempInitialMode, this parameter is used as a constant or scaling coefficient.

7.1.10.3 Group 3.9.3: Motor Stall

The motor stall protection protects the motor from short time overload situations such as one caused by a stalled shaft. The reaction time of the stall protection can be set shorter than that of motor thermal protection. The stall state is defined with two parameters, P3.9.3.2 (*Stall Current*) and P3.9.3.4 (*Stall Freq. Limit*). If the current is higher than the set limit and the output frequency is lower than the set limit the stall state is true. There is actually no real indication of the shaft rotation. Stall protection is a type of overcurrent protection.



NOTE! If you use long motor cables (max. 100 m) together with small drives (≤ 1.5 kW) the motor current measured by the drive can be much higher than the actual motor current due to capacitive currents in the motor cable. Consider this when setting up the stall protection functions.

Table 88. Motor stall protection settings

Code	Parameter	Min	Max	Unit	Default	ID	Description
P3.9.3.1	MotorStall Flt	0	3		0	709	0 = No action 1 = Alarm 2 = Fault (Stop according to stop mode) 3 = Fault (Stop by coasting)
P3.9.3.2	Stall Current	0.00	5.2	A	3.7	710	For a stall stage to occur, the current must have exceeded this limit.
P3.9.3.3	Stall Time Limit	1.00	120.00	s	15.00	711	This is the maximum time allowed for a stall stage.
P3.9.3.4	Stall Freq. Limit	1.00	P3.3.1.2	Hz	25.00	712	For a stall state to occur, the output frequency must have remained below this limit for a certain time.

7.1.10.4 Group 3.9.4: Motor Underload

The purpose of the motor underload protection is to ensure that there is load on the motor when the drive is running. If the motor loses its load there might be a problem in the process, e.g. a broken belt or a dry pump.

Motor underload protection can be adjusted by setting the underload curve with parameters P3.9.4.2 (*Underload protection: Field weakening area load*) and P3.9.4.3 (*Zero frequency load*).

The underload curve is a squared curve set between the zero frequency and the field weakening point. The protection is not active below 5 Hz (the underload time counter is stopped).

The torque values for setting the underload curve are set in percentage which refers to the nominal torque of the motor. The motor's name plate data, parameter motor nominal current and the drive's nominal current IH are used to find the scaling ratio for the internal torque value. If other than nominal motor is used with the drive, the accuracy of the torque calculation decreases.



NOTE! If you use long motor cables (max. 100 m) together with small drives (≤ 1.5 kW) the motor current measured by the drive can be much higher than the actual motor current due to capacitive currents in the motor cable. Consider this when setting up the motor underload protection functions.

Table 89. Motor underload protection settings

Code	Parameter	Min	Max	Unit	Default	ID	Description
P3.9.4.1	Underload Flt	0	3		0	713	0 = No action 1 = Alarm 2 = Fault (Stop according to stop mode) 3 = Fault (Stop by coasting) See P3.9.4.5 for the underload mode. When P3.9.4.5 = 0, Underload is determined by P3.9.4.2 - P3.9.4.4. When P3.9.4.5 = 1, the fault is related to P3.9.4.6.
P3.9.4.2	Fieldweak. Load	10.0	150.0	%	50.0	714	This parameter gives the value for the minimum torque allowed when the output frequency is above the field weakening point.
P3.9.4.3	Zero Freq. Load	5.0	150.0	%	10.0	715	This parameter gives value for the minimum torque allowed with zero frequency. If you change the value of parameter P3.1.1.4 this parameter is automatically restored to the default value.
P3.9.4.4	Time Limit	2.00	600.00	s	20.00	716	This is the maximum time allowed for an underload state to exist.
P3.9.4.5	UnderloadDetectMode	Motor Torque	Flow Meter		Motor Torque	1950	0 = Motor Torque 1 = Flowmeter (transducer defined by P3.23.1)
P3.9.4.6	Minimum Flow	1	214748	l/min	300	1951	Value to determine underload fault if P3.9.4.5 is 1

7.1.10.5 Group 3.9.6: Temperature input fault 1

NOTE! This parameter group is visible only with an option board for temperature measurement (OPT-BH) installed.

Table 90. Temperature input fault 1 settings

Code	Parameter	Min	Max	Unit	Default	ID	Description
P3.9.6.1	Temperature signal 1	0	63		0	739	Selection of signals to use for alarm and fault triggering. B0 = Temperature Signal 1 B1 = Temperature Signal 2 B2 = Temperature Signal 3 B3 = Temperature Signal 4 B4 = Temperature Signal 5 B5 = Temperature Signal 6 Max value is taken of the chosen signals and used for alarm/fault triggering. NOTE! Only 6 first temperature inputs are supported (counting boards from slot A to slot E).
P3.9.6.2	Alarm limit 1	-30.0	200.0	°C	120.0	741	Temperature limit for triggering alarm. NOTE! Only inputs chosen with parameter P3.9.6.1 are compared.
P3.9.6.3	Fault limit 1	-30.0	200.0	°C	120.0	742	Temperature limit for triggering alarm. NOTE! Only inputs chosen with parameter P3.9.6.1 are compared.
P3.9.6.4	Fault limit response 1	0	3		2	740	0 = No response 1 = Alarm 2 = Fault (Stop according to stop mode) 3 = Fault (Stop by coasting)

7.1.10.6 Group 3.9.6: Temperature input fault 2

NOTE! This parameter group is visible only with an option board for temperature measurement (OPT-BH) installed.

Table 91. Temperature input fault 2 settings

Code	Parameter	Min	Max	Unit	Default	ID	Description
P3.9.6.5	Temperature signal 2	0	63		0	763	Selection of signals to use for alarm and fault triggering. B0 = Temperature Signal 1 B1 = Temperature Signal 2 B2 = Temperature Signal 3 B3 = Temperature Signal 4 B4 = Temperature Signal 5 B5 = Temperature Signal 6 Max value is taken of the chosen signals and used for alarm/fault triggering. NOTE! Only 6 first temperature inputs are supported (counting boards from slot A to slot E).
P3.9.6.6	Alarm limit 2	-30.0	200.0	°C	120.0	764	Temperature limit for triggering alarm. NOTE! Only inputs chosen with parameter P3.9.6.5 are compared.
P3.9.6.7	Fault limit 2	-30.0	200.0	°C	120.0	765	Temperature limit for triggering alarm. NOTE! Only inputs chosen with parameter P3.9.6.5 are compared.
P3.9.6.8	Fault limit response 2	0	3		2	766	0 = No response 1 = Alarm 2 = Fault (Stop according to stop mode) 3 = Fault (Stop by coasting)

7.1.10.7 Group 3.9.8: AI Low Protection

Table 92. AI Low Protection settings

Code	Parameter	Min	Max	Unit	Default	ID	Description
P3.9.8.1	AI Low Protection	0	2		2	767	This parameter defines if the AI Low protection is enabled or disabled. 0 = Disabled 1 = Enabled in Run State 2 = Enabled in Run&Stop States
P3.9.8.2	AI Low Fault	0	5		0	700	Response when an analogue signal in use goes below 50% of the minimum signal range. 0 = No action 1 = Alarm 2 = Alarm, Preset Freq 3 = Alarm, Previous Freq 4 = Fault (Stop according to stop mode) 5 = Fault (Stop by coasting)

7.1.10.8 Group 3.9.9: User Defined Fault 1

Table 93. User Defined Fault 1 settings

Code	Parameter	Min	Max	Unit	Default	ID	Description
P3.9.9.1	User Defined Fault 1				DigIN Slot0.1	1552 3	Digital input selection for activating User Defined Fault (1 or 2)
P3.9.9.2	UserDef. Fault1 Resp.	0	3		3	1552 5	0 = No action 1 = Alarm 2 = Fault (Stop according to stop mode) 3 = Fault (Stop by coasting)

7.1.10.9 Group 3.9.10: User Defined Fault 2

Table 94. User Defined Fault 2 settings

Code	Parameter	Min	Max	Unit	Default	ID	Description
P3.9.10.1	User Defined Fault 2				DigIN Slot0.1	1552 4	Digital input selection for activating User Defined Fault (1 or 2)
P3.9.10.2	UserDef. Fault2 Resp.	0	3		3	1552 6	0 = No action 1 = Alarm 2 = Fault (Stop according to stop mode) 3 = Fault (Stop by coasting)

7.1.11 GROUP 3.10: AUTOMATIC RESET

Table 95. Autoreset settings

Code	Parameter	Min	Max	Unit	Default	ID	Description
P3.10.1	Automatic reset	0	1		0	731	0 = Disabled 1 = Enabled
P3.10.2	Wait time	0.10	10.0	m	1.0	717	Wait time before the first reset is executed.
P3.10.3	Automatic reset tries	1	10		5	759	NOTE: Total number of trials (irrespective of fault type)
P3.10.4	Restart Function	0	1		1	719	We can choose what kind of start function we want to use when doing an autoreset of the drive. 0 = Flying start 1 = Start Function
P3.10.5	Underload reset Time 1	0.1	1200.0	m	2.0	1927	
P3.10.6	Underload reset Time 2	0.1	1200.0	m	30.0	1928	
P3.10.7	Underload reset Time 3	0.1	1200.0	m	300.0	1929	
P3.10.8	Underload Tries T1,T2	1	10		2	1930	

7.1.12 GROUP 3.11: APPL. SETTINGS

Table 96. Application Settings

Code	Parameter	Min	Max	Unit	Default	ID	Description
P3.11.1	Parameter Password	0	9999		0	1806	
P3.11.2	C/F selection	0	1		0	1197	0 = Celsius 1 = Fahrenheit
P3.11.3	kW/hp selection	0	1		0	1198	0 = kW 1 = hp
P3.11.4	Multimonitor View	0	2		1	1196	Division of keypad display into sections in Multimonitor view. 0 = 2x2 sections 1 = 3x2 sections 2 = 3x3 sections
P3.11.5	FuncntButtonConfig	0	15		15	1195	With this parameter it's possible to configure what alternatives are visible when pressing the function button.

7.1.13 GROUP 3.12: TIMER FUNCTIONS

The time functions (Time Channels) in the VACON® 100 X give you the possibility to program functions to be controlled by the internal RTC (Real Time Clock). Practically every function that can be controlled by a digital input can also be controlled by a Time Channel. Instead of having an external PLC controlling a digital input you can program the "closed" and "opened" intervals of the input internally.

NOTE! The functions of this parameter group can be made the fullest advantage of only if the battery (option) has been installed and the Real Time Clock settings have been properly made during the Startup Wizard (see page 32 and page 33). **It is not recommended** to use these functions without battery backup because the time and date settings of the drive will be reset at every power down if no battery for the RTC is installed.

Time channels

The on/off logic for the *Time channels* is configured by assigning *Intervals* or/and *Timers* to them. One *Time channel* can be controlled by many *Intervals* or *Timers* by assigning as many of these as needed to the *Time channel*.

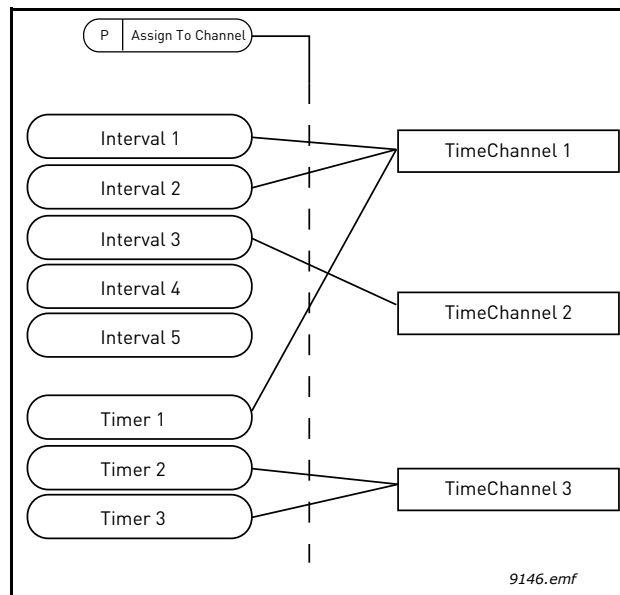

Figure 34. The intervals and timers can be assigned to time channels in a flexible way. Every interval and timer has its own parameter for assigning to a time channel.

Intervals

Every interval is given an "ON Time" and "OFF Time" with parameters. This is the daily time that the interval will be active during the days set with "From Day" and "To Day" parameters. E.g. the parameter setting below means that the interval is active from 7 am to 9 am every weekday (Monday to Friday). The Time Channel to which this Interval is assigned will be seen as a closed "virtual digital input" during that period.

- ON Time:** 07:00:00
- OFF Time:** 09:00:00
- From Day:** Monday
- To Day:** Friday

Timers

Timers can be used to set a Time Channel active during a certain time by a command from a digital input (or a Time Channel).

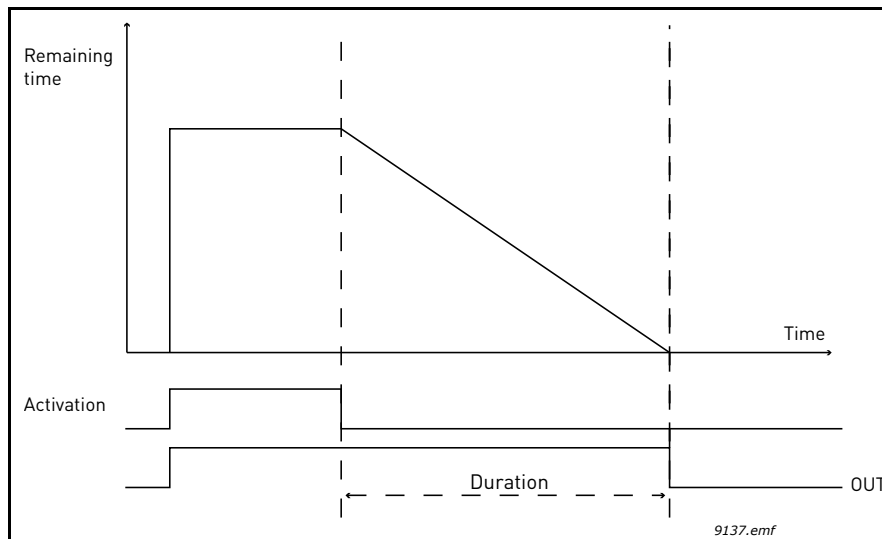

Figure 35. Activation signal comes from a digital input or "a virtual digital input" such as a Time channel. The Timer counts down from falling edge.

The below parameters will set the Timer active when Digital Input 1 on Slot A is closed and keep it active for 30s after it is opened.

Duration: 30s

Timer: DigIn SlotA.1

Tip: A duration of 0 seconds can be used for simply overriding a Time channel activated from a digital input without any off delay after the falling edge.

EXAMPLE

Problem:

We have an AC drive for air conditioning in a warehouse. It needs to run between 7am - 5pm on weekdays and 9am - 1pm on weekends. Additionally, we need to be able to manually force the drive to run outside working hours if there are people in the building and to leave it running for 30 min afterwards.

Solution:

We need to set up two intervals, one for weekdays and one for weekends. A Timer is also needed for activation outside the office hours. An example of configuration below.

Interval 1:

P3.12.1.1: **ON Time: 07:00:00**

P3.12.1.2: **OFF Time: 17:00:00**

P3.12.1.3: **Days: Monday, Tuesday, Wednesday, Thursday, Friday**

P3.12.1.4: **Assign to channel: Time channel 1**

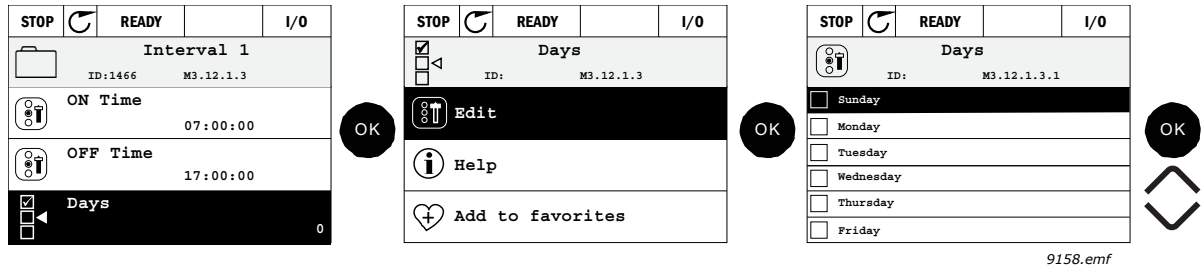

Interval 2:

- P3.12.2.1: *ON Time:* **09:00:00**
- P3.12.2.2: *OFF Time:* **13:00:00**
- P3.12.2.3: *Days:* **Saturday, Sunday**
- P3.12.2.4: *AssignToChannel:* **Time channel 1**

Timer 1

The manual bypassing can be handled by a digital input 1 on slot A (by a different switch or connection to lighting).

- P3.12.6.1: *Duration:* **1800s** (30 min)
- P3.12.6.3: *Assign to channel:* **Time channel 1**

P3.12.6.2: *Timer 1: DigIn SlotA.1* (Parameter located in digital inputs menu.)

Finally select the Channel 1 for the I/O Run command.

P3.5.1.1: *Control signal 1 A:* **Time Channel 1**

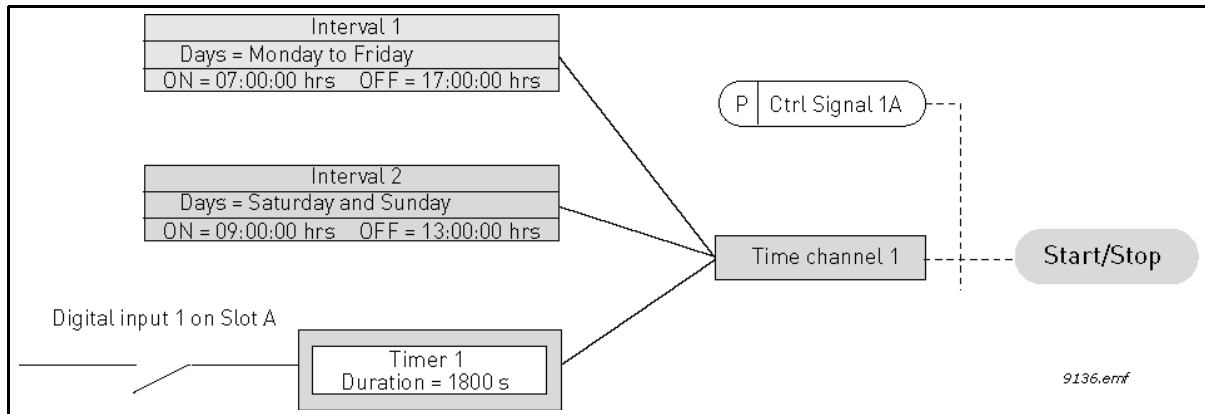

Figure 36. Final configuration where Time channel 1 is used as control signal for start command instead of a digital input.

7.1.13.1 Group 3.12.1: Interval 1

Table 97. Timer functions, Interval 1

Code	Parameter	Min	Max	Unit	Default	ID	Description
P3.12.1.1	ON time	00:00:00	23:59:59	hh:mm:ss	00:00:00	1464	ON time
P3.12.1.2	OFF time	00:00:00	23:59:59	hh:mm:ss	00:00:00	1465	OFF time
P3.12.1.3	Days					1466	Days of week when active. Checkbox selection: B0 = Sunday B1 = Monday B2 = Tuesday B3 = Wednesday B4 = Thursday B5 = Friday B6 = Saturday
P3.12.1.4	Assign to channel					1468	Select affected time channel (1-3) 0=Not used 1=Time channel 1 2=Time channel 2 3=Time channel 3

7.1.13.2 Group 3.12.2: Interval 2

Table 98. Timer functions, Interval 2

Code	Parameter	Min	Max	Unit	Default	ID	Description
P3.12.2.1	ON time	00:00:00	23:59:59	hh:mm:ss	00:00:00	1469	See Interval 1
P3.12.2.2	OFF time	00:00:00	23:59:59	hh:mm:ss	00:00:00	1470	See Interval 1
P3.12.2.3	Days					1471	See Interval 1
P3.12.2.4	Assign to channel					1473	See Interval 1

7.1.13.3 Group 3.12.3: Interval 3

Table 99. Timer functions, Interval 3

Code	Parameter	Min	Max	Unit	Default	ID	Description
P3.12.3.1	ON time	00:00:00	23:59:59	hh:mm:ss	00:00:00	1474	See Interval 1
P3.12.3.2	OFF time	00:00:00	23:59:59	hh:mm:ss	00:00:00	1475	See Interval 1
P3.12.3.3	Days					1476	See Interval 1
P3.12.3.4	Assign to channel					1478	See Interval 1

7.1.13.4 Group 3.12.4: Interval 4

Table 100. Timer functions, Interval 4

Code	Parameter	Min	Max	Unit	Default	ID	Description
P3.12.4.1	ON time	00:00:00	23:59:59	hh:mm:ss	00:00:00	1479	See Interval 1
P3.12.4.2	OFF time	00:00:00	23:59:59	hh:mm:ss	00:00:00	1480	See Interval 1
P3.12.4.3	Days					1481	See Interval 1
P3.12.4.4	Assign to channel					1483	See Interval 1

7.1.13.5 Group 3.12.5: Interval 5

Table 101. Timer functions, Interval 5

Code	Parameter	Min	Max	Unit	Default	ID	Description
P3.12.5.1	ON time	00:00:00	23:59:59	hh:mm:ss	00:00:00	1484	See Interval 1
P3.12.5.2	OFF time	00:00:00	23:59:59	hh:mm:ss	00:00:00	1485	See Interval 1
P3.12.5.3	Days					1486	See Interval 1
P3.12.5.4	Assign to channel					1488	See Interval 1

7.1.13.6 Group 3.12.6: Timer 1

Table 102. Timer functions, Timer 1

Code	Parameter	Min	Max	Unit	Default	ID	Description
P3.12.6.1	Duration	0	72000	s	0	1489	The time the timer will run when activated. (Activated by DI)
P3.12.6.2	Timer 1				DigINSlot 0.1	447	Rising edge starts Timer 1 programmed in Group 3.12: Timer functions parameter group.
P3.12.6.3	Assign to channel					1490	Select affected time channel (1-3) Check box selection: B0 = Time channel 1 B1 = Time channel 2 B2 = Time channel 3

7.1.13.7 Group 3.12.7: Timer 2

Table 103. Timer functions, Timer 2

Code	Parameter	Min	Max	Unit	Default	ID	Description
P3.12.7.1	Duration	0	72000	s	0	1491	See Timer 1
P3.12.7.2	Timer 2				DigINSlot 0.1	448	See Timer 1
P3.12.7.3	Assign to channel					1492	See Timer 1

7.1.13.8 Group 3.12.8: Timer 3

Table 104. Timer functions, Timer 3

Code	Parameter	Min	Max	Unit	Default	ID	Description
P3.12.8.1	Duration	0	72000	s	0	1493	See Timer 1
P3.12.8.2	Timer 3				DigINSlot 0.1	448	See Timer 1
P3.12.8.3	Assign to channel					1494	See Timer 1

7.1.14 GROUP 3.13: PID CONTROLLER7.1.14.1 Group 3.13.1: Basic Settings*Table 105. PID controller 1 basic settings*

Code	Parameter	Min	Max	Unit	Default	ID	Description
P3.13.1.1	Gain	0.00	1000.00	%	100.00	118	If the value of the parameter is set to 100% a change of 10% in the error value causes the controller output to change by 10%.
P3.13.1.2	Integration Time	0.00	600.00	s	1.00	119	If this parameter is set to 1,00s a change of 10% in the error value causes the controller output to change by 10.00%/s.
P3.13.1.3	Derivation Time	0.00	100.00	s	0.00	132	If this parameter is set to 1,00s a change of 10% in the error value during 1.00 s causes the controller output to change by 10.00%.
P3.13.1.4	ProcessUnitSel.	1	38		1	1036	Select unit for actual value.
P3.13.1.5	ProcessUnitMin	Varies	Varies	Varies	0	1033	Value in Process units at 0% feedback or setpoint. This scaling is done for monitoring purpose only. The PID controller still uses the percentage internally for feedbacks and setpoints.
P3.13.1.6	ProcessUnitMax	Varies	Varies	Varies	100	1034	See above.
P3.13.1.7	ProcessUnitDeci	0	4		2	1035	Number of decimals for process unit value
P3.13.1.8	Error inversion	0	1		0	340	0 = Normal (Feedback < Setpoint -> Increase PID output) 1 = Inverted (Feedback < Setpoint -> Decrease PID output)
P3.13.1.9	Dead Band	Varies	Varies	Varies	0	1056	Dead band area around the setpoint in process units. The PID output is locked if the feedback stays within the deadband area for a predefined time.
P3.13.1.10	Dead Band Delay	0.00	320.00	s	0.00	1057	If the feedback stays within the dead band area for a predefined time, the output is locked.

7.1.14.2 *Group 3.13.2: Setpoints*

Table 106. Setpoints settings

Code	Parameter	Min	Max	Unit	Default	ID	Description
P3.13.2.1	Keypad SP 1	Varies	Varies	Varies	0	167	
P3.13.2.2	Keypad SP 2	Varies	Varies	Varies	0	168	
P3.13.2.3	Ramp Time	0.00	300.0	s	0.00	1068	Defines the rising and falling ramp times for setpoint changes. (Time to change from minimum to maximum)
P3.13.2.4	SP Boost Activat.	Varies	Varies		DigIN Slot0.1	1046	FALSE = No boost TRUE = Boost
P3.13.2.5	Setpoint Selection	Varies	Varies		DigIN Slot0.1	1047	FALSE = Setpoint 1 TRUE = Setpoint 2
P3.13.2.6	SP 1 Source	0	22		1	332	0 = Not used 1 = Keypad setpoint 1 2 = Keypad setpoint 2 3 = AI1 4 = AI2 5 = AI3 6 = AI4 7 = AI5 8 = AI6 9 = ProcessDataIn1 10 = ProcessDataIn2 11 = ProcessDataIn3 12 = ProcessDataIn4 13 = ProcessDataIn5 14 = ProcessDataIn6 15 = ProcessDataIn7 16 = ProcessDataIn8 17 = Temperature input 1 18 = Temperature input 2 19 = Temperature input 3 20 = Temperature input 4 21 = Temperature input 5 22 = Temperature input 6 AI's and ProcessDataIn are handled as percent (0.00-100.00%) and scaled according to Setpoint minimum and maximum. NOTE: ProcessDataIn signals use 2 decimals.
P3.13.2.5	SP 1 Minimum	-200.00	200.00	%	0.00	1069	Minimum value at analogue signal minimum.
P3.13.2.6	SP 1 Maximum	-200.00	200.00	%	100.00	1070	Maximum value at analogue signal maximum.
P3.13.2.10	SP 1 Boost	-2.0	2.0	x	1.0	1071	The setpoint can be boosted with a digital input.
P3.13.2.11	SP 2 Source	0	22		2	431	See par. P3.13.2.6
P3.13.2.12	SP 2 Minimum	-200.00	200.00	%	0.00	1073	Minimum value at analogue signal minimum.
P3.13.2.13	SP 2 Maximum	-200.00	200.00	%	100.00	1074	Maximum value at analogue signal maximum.
P3.13.2.17	SP 2 Boost	-2.0	2.0	x	1.0	1078	See P3.13.2.10.

7.1.14.3 *Group 3.13.3: Feedbacks*

Table 107. Feedback settings

Code	Parameter	Min	Max	Unit	Default	ID	Description
P3.13.3.1	Function	1	9		1	333	1=Only Source1 in use 2=SQRT(Source1);(Flow=Constant x SQRT(Pressure)) 3= SQRT(Source1- Source 2) 4= SQRT(Source 1) + SQRT (Source 2) 5= Source 1 + Source 2 6= Source 1 - Source 2 7=MIN (Source 1, Source 2) 8=MAX (Source 1, Source 2) 9=MEAN (Source 1, Source 2)
P3.13.3.2	Gain	-1000.0	1000.0	%	100.0	1058	Used e.g. with selection 2 in <i>Feedback function</i>
P3.13.3.3	FB 1 Source	0	20		2	334	0 = Not used 1 = AI1 2 = AI2 3 = AI3 4 = AI4 5 = AI5 6 = AI6 7 = ProcessDataIn1 8 = ProcessDataIn2 9 = ProcessDataIn3 10 = ProcessDataIn4 11 = ProcessDataIn5 12 = ProcessDataIn6 13 = ProcessDataIn7 14 = ProcessDataIn8 15 = Temperature input 1 16 = Temperature input 2 17 = Temperature input 3 18 = Temperature input 4 19 = Temperature input 5 20 = Temperature input 6 AI's and ProcessDataIn are handled as % (0.00-100.00%) and scaled according to Feedback min and max. NOTE: ProcessDataIn use two decimals.
P3.13.3.4	FB 1 Minimum	-200.00	200.00	%	0.00	336	Minimum value at analogue signal minimum.
P3.13.3.5	FB 1 Maximum	-200.00	200.00	%	100.00	337	Maximum value at analogue signal maximum.
P3.13.3.6	FB 2 Source	0	20		0	335	See P3.13.3.3
P3.13.3.7	FB 2 Minimum	-200.00	200.00	%	0.00	338	Minimum value at analogue signal minimum.
P3.13.3.8	FB 2 Maximum	-200.00	200.00	%	100.00	339	Maximum value at analogue signal maximum.

7.1.14.4 Group 3.13.4: FeedForward

Feedforward usually needs accurate process models, but in some simple cases a gain + offset type of feedforward is enough. The feedforward part does not use any feedback measurements of the actual controlled process value (water level in the example on page 171). VACON® feedforward control uses other measurements which are indirectly affecting the controlled process value.

Table 108. Feedforward settings

Code	Parameter	Min	Max	Unit	Default	ID	Description
P3.13.4.1	Function	1	9		1	1059	See P3.13.3.1.
P3.13.4.2	Gain	-1000	1000	%	100.0	1060	See P3.13.3.2
P3.13.4.3	FF 1 Source	0	25		0	1061	See P3.13.3.3
P3.13.4.4	FF 1 Minimum	-200.00	200.00	%	0.00	1062	See P3.13.3.4
P3.13.4.5	FF 1 Maximum	-200.00	200.00	%	100.00	1063	See P3.13.3.5
P3.13.4.6	FF 2 Source	0	25		0	1064	See P3.13.3.6
P3.13.4.7	FF 2 Minimum	-200.00	200.00	%	0.00	1065	See P3.13.3.7
P3.13.4.8	FF 2 Maximum	-200.00	200.00	%	100.00	1066	See P3.13.3.8

7.1.14.5 Group 3.13.5: Sleep Function

This function will put the drive into sleep mode if the frequency stays below the sleep limit for a longer time than that set with the Sleep Delay.

Table 109. Sleep function settings

Code	Parameter	Min	Max	Unit	Default	ID	Description
P3.13.5.1	SP 1 Sleep Freq	0.00	320.00	Hz	0.00	1016	Drive goes to sleep mode when the output frequency stays below this limit for a time greater than that defined by parameter <i>Sleep delay</i> .
P3.13.5.2	SP 1 Sleep Delay	0	3000	s	0	1017	The minimum amount of time the frequency has to remain below the Sleep level before the drive is stopped.
P3.13.5.3	SP 1 WakeUpLevel			Varies	0.00	1018	Defines the level for the PID feedback value wake-up supervision. Uses selected process units.
P3.13.5.4	SP 1 WakeUpMode	0	1		0	1019	Select if wake up level should work as an absolute level or as an offset below the actual setpoint value. 0 = Absolute Level 1 = Relative Setpoint
P3.13.5.5	SP 2 Sleep Freq	0.00	320.00	Hz	0.00	1075	Drive goes to sleep mode when the output frequency stays below this limit for a time greater than that defined by parameter <i>Sleep delay</i> .
P3.13.5.6	SP 2 Sleep Delay	0	3000	s	0	1076	The minimum amount of time the frequency has to remain below the Sleep level before the drive is stopped.

Table 109. Sleep function settings

P3.13.5.7	SP 2 WakeUpLevel			Varies	0.00	1077	Defines the level for the PID feedback value wake-up supervision. Uses selected process units.
P3.13.5.8	SP 2 WakeUpMode	0	1		0	1020	Select if wake up level should work as an absolute level or as an offset below the actual setpoint value. 0 = Absolute Level 1 = Relative Setpoint

7.1.14.6 Group 3.13.6: Feedback Superv.

Process supervision is used to control that the *PID Feedback value* (process actual value) stays within predefined limits. With this function you can e.g. detect a major pipe burst and stop unnecessary flooding. See more on page 173.

Table 110. Process supervision parameters

Code	Parameter	Min	Max	Unit	Default	ID	Description
P3.13.6.1	Enable Superv	0	1		0	735	0 = Disabled 1 = Enabled
P3.13.6.2	Upper limit	Varies	Varies	Varies	Varies	736	Upper actual/process value supervision
P3.13.6.3	Lower limit	Varies	Varies	Varies	Varies	758	Lower actual/process value supervision
P3.13.6.4	Delay	0	30000	s	0	737	If the desired value is not reached within this time a fault or alarm is created.
P3.13.6.5	Supervision Fault	0	3		2	749	0 = No action 1 = Alarm 2 = Fault (Stop according to stop mode) 3 = Fault (Stop by coasting)

7.1.14.7 Group 3.13.7: Press.Loss.Comp.

Table 111. Pressure loss compensation parameters

Code	Parameter	Min	Max	Unit	Default	ID	Description
P3.13.7.1	Enable SP 1	0	1		0	1189	Enables pressure loss compensation for setpoint 1. 0 = Disabled 1 = Enabled
P3.13.7.2	SP 1 Max Comp.	Varies	Varies	Varies	Varies	1190	Value added proportionally to the frequency. Setpoint compensation = Max compensation * (FreqOut-MinFreq)/(MaxFreq-MinFreq)
P3.13.7.3	Enable SP 2	0	1		0	1191	See P3.13.7.1.
P3.13.7.4	SP 2 Max Comp.	Varies	Varies	Varies	Varies	1192	See P3.13.7.2.

7.1.14.8 Group 3.13.8: Soft Fill

The process is brought to a certain level (P3.13.8.3) at slow frequency (P3.13.8.2) before the PID controller starts to control. In addition, you can also set a timeout for the soft fill function. If the set level is not reached within the timeout a fault is triggered. This function can be used e.g. to fill the empty pipe line slowly in order to avoid "water hammers" that could otherwise break the pipes.

It is recommended to use the Soft Fill function always when using the Multi Pump functionality.

Table 112. Soft fill settings

Code	Parameter	Min	Max	Unit	Default	ID	Description
P3.13.8.1	Enable	0	1		0	1094	0 = Disabled 1 = Enabled
P3.13.8.2	SoftFill Freq	0.00	50.00	Hz	20.00	1055	The drive accelerates to this frequency before starting to control.
P3.13.8.3	SoftFill Level	Varies	Varies	Varies	0.0000	1095	The drive runs at the PID start frequency until the feedback reaches this value. At this point the controller starts to regulate (depending on acting mode).
P3.13.8.4	Timeout Time	0	30000	s	0	1096	If the desired value is not reached within this time a fault or alarm is created. 0 = No timeout (NOTE! No fault triggered if value '0' is set)
P3.13.8.5	Timeout Response	0	3		2	738	0 = No action 1 = Alarm 2 = Fault (Stop according to stop mode) 3 = Fault (Stop by coasting)

7.1.14.9 Group 3.13.9: Input Press.Superv.

The *Input pressure supervision* function is used to supervise that there is enough water in the inlet of the pump, to prevent the pump from sucking air or causing suction cavitation. This function requires a pressure sensor to be installed on the pump inlet, see Figure 37.

If the pump inlet pressure falls below the defined alarm limit, an alarm will be triggered and the pump output pressure reduced by decreasing the PID controller setpoint value. If the inlet pressure still keeps falling below the fault limit, the pump is stopped and a fault will be triggered.

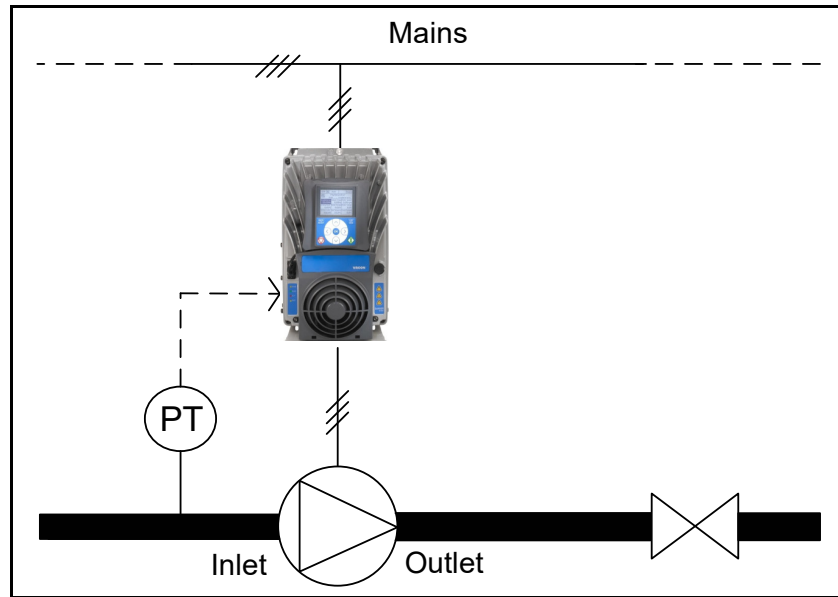

Figure 37. Location of pressure sensor

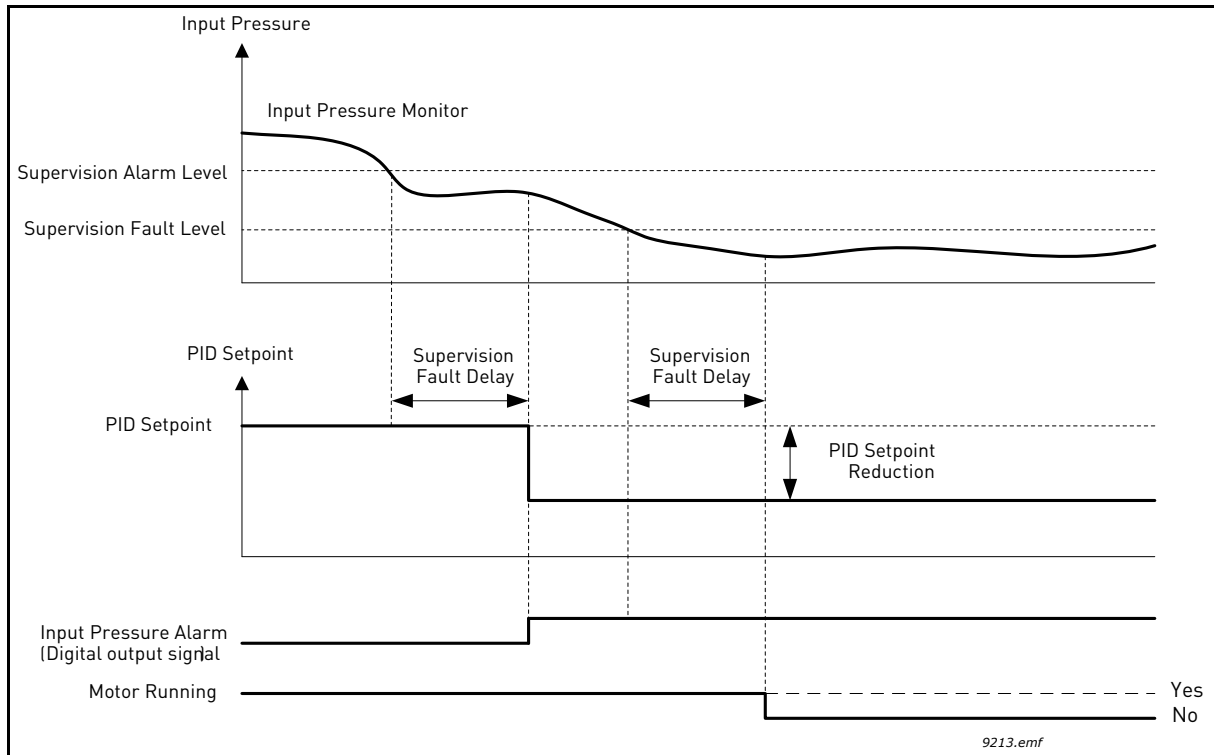

Figure 38. Input pressure supervision

Table 113. Input pressure supervision parameters

Code	Parameter	Min	Max	Unit	Default	ID	Description
P3.13.9.1	Superv. Enable	0	1		0	1685	0 = Disabled 1 = Enabled Enables the Input Pressure Supervision.

Table 113. Input pressure supervision parameters

Code	Parameter	Min	Max	Unit	Default	ID	Description
P3.13.9.2	Superv. Signal	0	13	Hz	0	1686	The source of input pressure measurement signal: 0=Analogue input 1 1=Analogue input 2 2=Analogue input 3 3=Analogue input 4 4=Analogue input 5 5=Analogue input 6 6=ProcessDataIn1 (0-100%) 7=ProcessDataIn2 (0-100%) 8=ProcessDataIn3 (0-100%) 9=ProcessDataIn4 (0-100%) 10=ProcessDataIn5 (0-100%) 11=ProcessDataIn6 (0-100%) 12=ProcessDataIn7 (0-100%) 13=ProcessDataIn8 (0-100%)
P3.13.9.3	Superv. Unit Sel.	0	8	Varies	2	1687	Select unit for supervision. The supervision signal (P3.13.9.2) can be scaled to process units on the panel.
P3.13.9.4	Superv. Unit Decimal	0	4		2	1688	Choose how many decimals to show.
P3.13.9.5	Superv. Unit Min	Varies	Varies	Varies	Varies	1689	Unit min and max parameters are the signal values corresponding to e.g. 4mA and 20 mA respectively (scaled linearly between these).
P3.13.9.6	Superv. Unit Max	Varies	Varies	Varies	Varies	1690	
P3.13.9.7	Superv. Alarm Level	Varies	Varies	Varies	Varies	1691	Alarm (Fault ID 1363) will be launched if supervision signal stays below the alarm level longer than the time defined by parameter P3.13.9.9.
P3.13.9.8	Superv. Fault Level	Varies	Varies	Varies	Varies	1692	Fault (Fault ID 1409) will be launched if supervision signal stays below the fault level longer than the time defined by parameter P3.13.9.9.
P3.13.9.9	Superv. Fault Delay	0.00	60.00	s	5.00	1693	Delay time to launch the <i>Input pressure supervision alarm</i> or <i>fault</i> if the supervision signal stays below the alarm/fault level longer than defined by this parameter.
P3.13.9.10	PID setpoint Reduct.	0.0	100.0	%	10.0	1694	Defines the rate of the PID controller setpoint reduction when the Input pressure supervision alarm is active.
V3.13.9.11	InputPress. Monitor	Varies	Varies	Varies	Varies	1695	Monitoring value for selected Input pressure supervision signal. Scaling value according to P3.13.9.4.

Table 114. Sleep - no demand detected

Code	Parameter	Min	Max	Unit	Default	ID	Description
P3.13.10.1	Sleep No Demand Detection Enable	0	1		0	1649	0 = No 1 = Yes
P3.13.10.2	SNDD Error Hysteresis	0	99999.9	P3.13.1.4	0.5	1658	
P3.13.10.3	SNDD Frequency Hysteresis	0.00	P3.3.1.2	Hz	3.00	1663	
P3.13.10.4	SNDD Supervision Time	0	600	s	120	1668	
P3.13.10.5	SNDD Actual Add	0.00	P3.13.10.2	P3.13.1.4	0.5	1669	

7.1.15 GROUP 3.14: EXTPID CONTROLLER

7.1.15.1 Group 3.14.1: Basic settings

For more detailed information, see chapter 7.1.14.

Table 115. Basic settings for external PID-controller

Code	Parameter	Min	Max	Unit	Default	ID	Description
P3.14.1.1	Enable ExtPID	0	1		0	1630	0 = Disabled 1 = Enabled
P3.14.1.2	Start signal				DigIN Slot0.2	1049	FALSE = PID2 in stop mode TRUE = PID2 regulating This parameter will have no effect if PID2 controller is not enabled in the Basic menu for PID2
P3.14.1.3	Output in Stop	0.0	100.0	%	0.0	1100	The output value of the PID controller in % of its maximum output value while it is stopped from digital input
P3.14.1.4	Gain	0.00	1000.00	%	100.00	1631	
P3.14.1.5	Integration Time	0.00	600.00	s	1.00	1632	
P3.14.1.6	Derivation Time	0.00	100.00	s	0.00	1633	
P3.14.1.7	ProcessUnitSel.	0	37		0	1635	
P3.14.1.8	ProcessUnitMin	Varies	Varies	Varies	0	1664	
P3.14.1.9	ProcessUnitMax	Varies	Varies	Varies	100	1665	
P3.14.1.10	ProcessUnitDeci	0	4		2	1666	
P3.14.1.11	Error inversion	0	1		0	1636	
P3.14.1.12	Dead Band	Varies	Varies	Varies	0.0	1637	
P3.14.1.13	Dead Band Delay	0.00	320.00	s	0.00	1638	

7.1.15.2 *Group 3.14.2: Setpoints*

Table 116. External PID-controller, setpoints

Code	Parameter	Min	Max	Unit	Default	ID	Description
P3.14.2.1	Keypad SP 1	0.00	100.00	Varies	0.00	1640	
P3.14.2.2	Keypad SP 2	0.00	100.00	Varies	0.00	1641	
P3.14.2.3	Ramp Time	0.00	300.00	s	0.00	1642	
P3.14.2.4	Setpoint Selection	Varies	Varies		DigIN Slot0.1	1048	FALSE = Setpoint 1 TRUE = Setpoint 2
P3.14.2.5	SP 1 Source	0	22		1	1643	0 = Not Used 1 = Keypad Setpoint 1 2 = Keypad Setpoint 2 3 = AI1 4 = AI2 5 = AI3 6 = AI4 7 = AI5 8 = AI6 9 =ProcessDataIn1 10 =ProcessDataIn2 11 =ProcessDataIn3 12 =ProcessDataIn4 13 =ProcessDataIn5 14 =ProcessDataIn6 15 =ProcessDataIn7 16 =ProcessDataIn8 17 = Temperature Input 1 18 = Temperature Input 2 19 = Temperature Input 3 20 = Temperature Input 4 21 = Temperature Input 5 22 = Temperature Input 6 AI's and ProcessDataIn are handled as percent (0.00-100.00%) and scaled according to Setpoint minimum and maximum. NOTE: ProcessDataIn signals use 2 decimals.
P3.14.2.6	SP 1 Minimum	-200.00	200.00	%	0.00	1644	Minimum value at analogue signal minimum.
P3.14.2.7	SP 1 Maximum	-200.00	200.00	%	100.00	1645	Maximum value at analogue signal maximum.
P3.14.2.8	SP 2 Source	0	22		0	1646	See P3.14.2.5.
P3.14.2.9	SP 2 Minimum	-200.00	200.00	%	0.00	1647	Minimum value at analogue signal minimum.
P3.14.2.10	SP 2 Maximum	-200.00	200.00	%	100.00	1648	Maximum value at analogue signal maximum.

7.1.15.3 Group 3.14.3: Feedbacks

For more detailed information, see chapter 7.1.14.

Table 117. External PID-controller, feedbacks

Code	Parameter	Min	Max	Unit	Default	ID	Description
P3.14.3.1	Function	1	9		1	1650	
P3.14.3.2	Gain	-1000.0	1000.0	%	100.0	1651	
P3.14.3.3	FB 1 Source	0	25		1	1652	See P3.13.3.3.
P3.14.3.4	FB 1 Minimum	-200.00	200.00	%	0.00	1653	Minimum value at analogue signal minimum.
P3.14.3.5	FB 1 Maximum	-200.00	200.00	%	100.00	1654	Maximum value at analogue signal maximum.
P3.14.3.6	FB 2 Source	0	25		2	1655	See P3.13.3.6.
P3.14.3.7	FB 2 Minimum	-200.00	200.00	%	0.00	1656	Minimum value at analogue signal minimum.
P3.14.3.8	FB 2 Maximum	-200.00	200.00	%	100.00	1657	Maximum value at analogue signal maximum.

7.1.15.4 Group 3.14.4: Feedback Superv.

For more detailed information, see chapter 7.1.14.

Table 118. External PID-controller, process supervision

Code	Parameter	Min	Max	Unit	Default	ID	Description
P3.14.4.1	Enable Superv	0	1		0	1659	0 = Disabled 1 = Enabled
P3.14.4.2	Upper limit	Varies	Varies	Varies	Varies	1660	
P3.14.4.3	Lower limit	Varies	Varies	Varies	Varies	1661	
P3.14.4.4	Delay	0	30000	s	0	1662	If the desired value is not reached within this time a fault or alarm is activated.
P3.14.4.5	Supervision Fault	0	3		2	757	See P3.9.1.2

7.1.16 GROUP 3.16: MAINTEN. COUNTERS

The maintenance counter is a way of indicating the operator that maintenance needs to be carried out. For example, a belt needs to be replaced or oil in a gearbox should be changed.

There are two different modes for the maintenance counters, hours or revolutions*1000. The counters are only incremented during Run mode in either case. **NOTE:** Revolutions are based on motor speed which is only an estimate (integration every second).

When the counter exceeds the limit an alarm or fault will be triggered respectively. Individual maintenance alarm and fault signals can be connected to a digital/relay output.

When maintenance has been carried out the counter can be reset through either a digital input or a parameter B3.16.4.

Table 119. Maintenance counter parameters

Code	Parameter	Min	Max	Unit	Default	ID	Description
P3.16.1	Counter 1 mode	0	2		0	1104	0 = Not used 1 = Hours 2 = Revolutions*1000
P3.16.2	Counter 1 alarm limit	214748 3647	80000	h/kRev	0	1105	When to trig a maintenance alarm for counter 1. 0 = Not used
P3.16.3	Counter 1 fault limit	214748 3647	80000	h/kRev	0	1106	When to trig a maintenance fault for counter 1. 0 = Not used
B3.16.4	Counter 1 reset	0	1		0	1107	Activate to reset counter 1.
P3.16.5	Counter 1 DI reset	Varies	Varies		0	490	TRUE = Reset

7.1.17 GROUP 3.21: PUMP CONTROL

7.1.17.1 Group 3.21.1: Auto-Cleaning

The Auto-cleaning function is used to remove any dirt or other material that may have attached to the pump impeller. Auto-cleaning is used e.g. in wastewater systems to keep up the performance of the pump. Auto Cleaning function can also be used to clear the blocked pipe or valve.

Table 120. Auto-cleaning parameters

Code	Parameter	Min	Max	Unit	Default	ID	Description
P3.21.1.1	Clean Function	0	1		0	1714	0=Disabled 1=Enabled
P3.21.1.2	Clean Activation				DigIN Slot0.1	1715	Digital input signal used to start the Auto Cleaning sequence. Auto-cleaning sequence will be aborted if activation signal is removed before the sequence has been completed. NOTE: The drive will start if the input is activated!
P3.21.1.3	Clean Cycles	1	100		5	1716	Number of forward/reverse cleaning cycles.
P3.21.1.4	Clean Forward Freq.	0.00	50.00	Hz	45.00	1717	Forward direction frequency in Auto-cleaning cycle.
P3.21.1.5	Clean Forward Time	0.00	320.00	s	2.00	1718	Running time for forward direction frequency in Auto-cleaning cycle.
P3.21.1.6	Clean Reverse Freq.	0.00	50.00	Hz	45.00	1719	Reverse direction frequency in Auto-cleaning cycle.
P3.21.1.7	Clean Reverse Time	0.00	320.00	s	0.00	1720	Running time for reverse direction frequency in Autocleaning cycle
P3.21.1.8	Clean Accel Time	0.1	300.0	s	0.1	1721	Motor acceleration time when Auto-cleaning is active
P3.21.1.9	Clean Decel Time	0.1	300.0	s	0.1	1722	Motor deceleration time when Auto-cleaning is active

7.1.18 GROUP 3.22: SOLAR

7.1.18.1 Group 3.22.1: Start Settings

Table 121. Start Settings parameters

Code	Parameter	Min	Max	Unit	Default	ID	Description
P3.22.1.1	Start DC Voltage	P3.22.2.16+ 5 V	1100	V	Varies	1916	DV voltage threshold level to activate Run enable.
P3.22.1.2	Short restart delay	0.1	5.0	m	1.0	1917	Delay time to restart
P3.22.1.3	Short restart delay tries	1	10		5	1918	Number of restart tries
P3.22.1.4	Long restart delay	6.0	30.0	m	10.0	1919	Long delay time to restart
P3.22.1.5	Sleep in solar mode	Dis-abled	Enable d		Dis-abled	1964	0 = Sleep disabled 1 = Sleep according to P3.13.5.1 and P3.13.5.2

NOTE!

Sleep in solar mode can be managed according to P3.13.5.1 and P3.13.5.2
 When P3.22.1.5 = 1, the drive will stop if the output frequency is below the value in P3.13.5.1, for the time in P3.13.5.2. It will restart as after a stop due to low power.
 Sleep function allows to program a minimum frequency P3.3.1.1 that is below the efficient range of the pump. MPPT can reach this low value, leading to a minimum output power and avoiding to stop the drive in case of temporary reduced irradiation. If the condition persists, sleep logic will then stop the drive.

7.1.18.2 Group 3.22.2: MPPT

Table 122. MPPT parameters

Code	Parameter	Min	Max	Unit	Default	ID	Description
P3.22.2.1	Vmp at 100% power	P3.22.2.16 + 5 V	1100	V	Varies	1920	
P3.22.2.2	Vmp at 10% power	P3.22.2.16 + 5 V	1100	V	Varies	1921	
P3.22.2.3	Panel/Motor power ratio	50.00	100.00	%	100.00	1922	
P3.22.2.4	P gain	0.000	1.000		0.050	1923	Gain for internal PI regulator. The internal frequency reference keeps the panels working on MPP.
P3.22.2.5	I gain	0.000	1.000		0.050	1924	Integration time.
P3.22.2.6	Acceleration time	0.1	60.0	s	1.0	1925	Time from minimum to maximum frequency
P3.22.2.7	Deceleration time	0.1	60.0	s	1.0	1926	Time from maximum to minimum frequency
P3.22.2.8	P&O update time	2	6	s	3	1939	
P3.22.2.9	P&O voltage step	3	10	V	5	1940	
P3.22.2.10	P&O power variation	0.2	5.0	%	1.0	1941	
P3.22.2.11	P&O local max volt step	20	60	V	30	1945	

Table 122. MPPT parameters

P3.22.2.12	P&O local max time	1	60	m	10	1946	
P3.22.2.13	P&O local max freq	0.00	20.00	Hz	10.00	1947	
P3.22.2.14	Damping sensitivity	5	50	V	10	1943	Amplitude of oscillation to be recognized
P3.22.2.15	Damping time	3	10	s	4	1944	Time for the oscillations on DC voltage
P3.22.2.16	Minimum DC voltage	Varies*	Varies	V	Varies	1995	If the DC-link voltage goes below this threshold, the under-voltage regulator will quickly decrease the output frequency. In case it results lower than the programmed minimum reference, the drive stops with warning 60. The value depends on the voltage range.

* Min value is 300 V is valid for VACON® 100 X 380-500 V AC when the application version is AMIT1181_V205 and the drive is manufactured after June 2019. For older VACON® 100 X 380-500 V AC and VACON® 100 380-500 V AC minimum value is 400 V.

7.1.19 GROUP 3.23: FLOW METER

Table 123. Flow meter parameters

Code	Parameter	Min	Max	Unit	Default	ID	Description
P3.23.1	Flow meter signal	Not used	AI4		Not used	1958	0: Not used 1: Digital pulse 2: AI1 3: AI2 4: AI3 5: AI4
P3.23.2	Flow at max anlg signal	0	200000	l/min	1000	1960	Considered when flow meter signal is from analogue signal (AI1 - AI4). It is the flow level at maximum analogue signal.
P3.23.3	Pulse output volume	1	10000	l/pulse	100	1954	Considered when flow meter signal is from Digital pulse. It is the total volume of water for each pulse.

7.1.20 GROUP 3.24: DUAL SUPPLY

Table 124. Common settings

Code	Parameter	Min	Max	Unit	Default	ID	Description
P3.24.1.1	AC Voltage	210	700	V	0	1974	Nominal voltage of AC grid or generator.
V3.24.1.2	Nominal DC Voltage	0	1200	V	0	1990	Monitor of calculated value of nominal DC voltage, when supply is from AC grid or generator.
P3.24.1.3	Dual Supply Mode	0	2		0	1971	0 = Always active 1 = Closed loop Irradiation 2 = Closed loop Sensorless
P3.24.1.4	DC Offset for AC Off	1	100	V	30	1977	Offset added to M3.24.1.1, as DC voltage threshold above which AC can be switched Off.
P3.24.1.5	AC Off at Stop Delay	1	3600	s	60	1973	Delay to switch AC Off at stop, if it happened with AC On condition.

Table 125. Mode 0 parameters

Code	Parameter	Min	Max	Unit	Default	ID	Description
P3.24.2.1	AC On Condition	At Run	At Start		At Run	1972	

Table 126. Mode 1 Irradiation parameters

Code	Parameter	Min	Max	Unit	Default	ID	Description
P3.24.3.1	Irradiation Signal	AI1	AI2		AI1	1980	Selection between AI1 and AI2.
P3.24.3.2	Max Irradiation	100	5000	W/m ²	1500	1981	Value of irradiation at maximum signal.
P3.24.3.3	AC On Irradiation	0	1500	W/m ²	200	1984	Threshold for irradiation, below which AC relay is switched On.
P3.24.3.4	AC Off Irrad. Offset	10	1500	W/m ²	200	1985	Value added to P3.24.3.3 to determine the threshold for switching AC Off.
P3.24.3.5	Irrad. Stabiliz. Time	1	120	s	20	1986	Irradiation has to stay below/above thresholds for this time, to activate switching On/Off.
P3.24.3.6	Identification	No	Yes		No	1987	
P3.24.3.7	Identif. Frequency	20,00	50,00	Hz	30,00	1988	

Table 127. Mode 2 Sensorless parameters

Code	Parameter	Min	Max	Unit	Default	ID	Description
P3.24.4.1	AC On Frequency	20,00	50,00	Hz	25,00	1975	AC relay is switched On if motor frequency stays below threshold, for delay time.
P3.24.4.2	AC On Delay	1	180	s	30	1976	AC relay is switched On if motor frequency stays below threshold, for delay time.
P3.24.4.3	DC Check Reference	20,00	50,00	Hz	30,00	1978	Frequency reference at which DC voltage is checked, for possible switching Off.
P3.24.4.4	DC Check Period	1	180	min	20	1979	Time for periodic DC voltage check, at reduced frequency.
P3.24.4.5	DC Check Stabiliz. Time	1	30	s	5	1983	DC voltage must stay above the threshold for this time (both at maximum and reduced speed), to activate AC switching Off.

7.2 ADDITIONAL PARAMETER INFORMATION

Due to its user-friendliness and simplicity of use, the most parameters of the VACON® 100 X Solar Pump Application only require a basic description which is given in the parameter tables in chapter 7.1.

In this chapter, you will find additional information on certain most advanced parameters of the VACON® 100 X Solar Pump Application. Should you not find the information you need contact your distributor.

7.2.1 MOTOR CONTROL

P3.1.1.2 MOTOR NOM FREQ

NOTE! When this parameter is changed, parameters P3.1.4.2 and P3.1.4.3 will be automatically initialized depending on the selected motor type. See Table 130.

P3.1.2.1 CONTROL MODE

Table 128.

Selection number	Selection name	Description
0	U/f control (open loop)	Drive frequency reference is set to output frequency without slip compensation. Motor actual speed is finally defined by motor load.
1	Speed control (open loop)	Drive frequency reference is set to motor speed reference. The motor speed is remains the same regardless of motor load. Slip is compensated.

P3.1.2.2 MOTOR TYPE

This parameter defines the used motor type.

Table 129.

Selection number	Selection name	Description
0	Induction motor (IM)	Select if an induction motor is used.
1	Permanent Magnet Synchronous Motor (PMSM)	Select if a permanent magnet synchronous motor is used.

When this parameter is changed, parameters P3.1.4.2 and P3.1.4.3 will be automatically initialized according to the selected motor type.

See Table 130 for the initialization values:

Table 130.

Parameter	Induction Motor (IM)	Permanent Magnet Synchronous Motor (PMSM)
P3.1.4.2 (Field WeakngPnt)	Motor nominal frequency	Internally calculated
P3.1.4.3 (Voltage at FWP)	100,0%	Internally calculated

P3.1.2.4 IDENTIFICATION

The automatic motor identification calculates or measures the motor parameters that are needed for optimum motor and speed control.

Identification Run is a part of tuning the motor and the drive specific parameters. It is a tool for commissioning and service of the drive with the aim to find as good parameter values as possible for most drives.

Table 131.

Selection number	Selection name	Description
0	No action	No identification requested.
1	Identification at standstill	The drive is run without speed to identify the motor parameters. The motor is supplied with current and voltage but with zero frequency. U/f ratio is identified.
2	Identification with motor rotating	The drive is run with speed to identify the motor parameters. U/f ratio and magnetization current are identified. NOTE: This identification run must be performed with no load on the motor shaft for accurate results.

The automatic identification is activated by setting this parameter to desired value and giving a start command in the requested direction. The start command to the drive has to be given within 20 s. If no start command is given within this time the identification run is cancelled, the parameter will be reset to its default setting and an *Identification* alarm will be launched.

The identification run can be stopped at any time with normal stop command and the parameter is reset to its default setting. An *Identification* alarm will be launched if the identification run has failed.

NOTE: New start command (Rising edge) is required to start the drive after identification.

P3.1.2.6 MOTOR SWITCH

This function is typically used if there is a switch between the drive and the motor. Such switches are often found in residential and industrial applications to make sure that an electrical circuit can be completely de-energized from the motor for service or maintenance.

When this parameter is enabled and the motor switch is opened to disconnect the running motor, the drive detects the loss of motor without tripping. It is not necessary to make any changes in the run command or the reference signal to the drive from the process control station. When the motor is re-connected after completed maintenance by closing the switch, the drive detects the motor connection and runs the motor to the reference speed as per the process commands.

If the motor is rotating when re-connected, the drive detects the speed of the running motor through its *Flying start* feature and then controls it to desired speed as per the process commands.

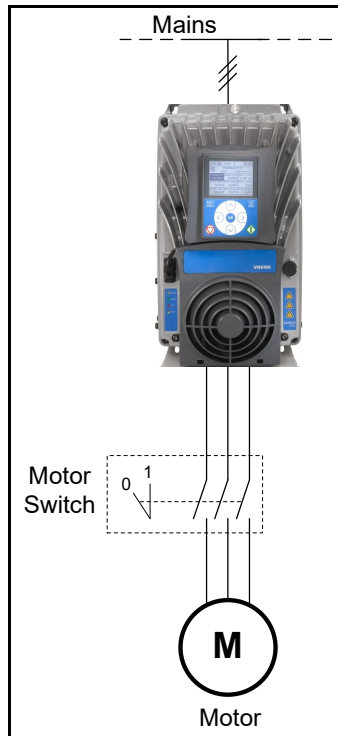

Figure 39. Motor switch

P3.1.2.7 LOAD DROOPING

The drooping function enables speed drop as a function of load. This parameter sets that amount corresponding to the nominal torque of the motor.

This function is used e.g. when balanced load is needed for mechanically connected motors or dynamic speed drooping is needed because of changing load.

E.g. if load drooping is set to 10% for a motor with a nominal frequency of 50 Hz and the motor is loaded with nominal load (100% of torque) the output frequency is allowed to decrease 5 Hz from the frequency reference.

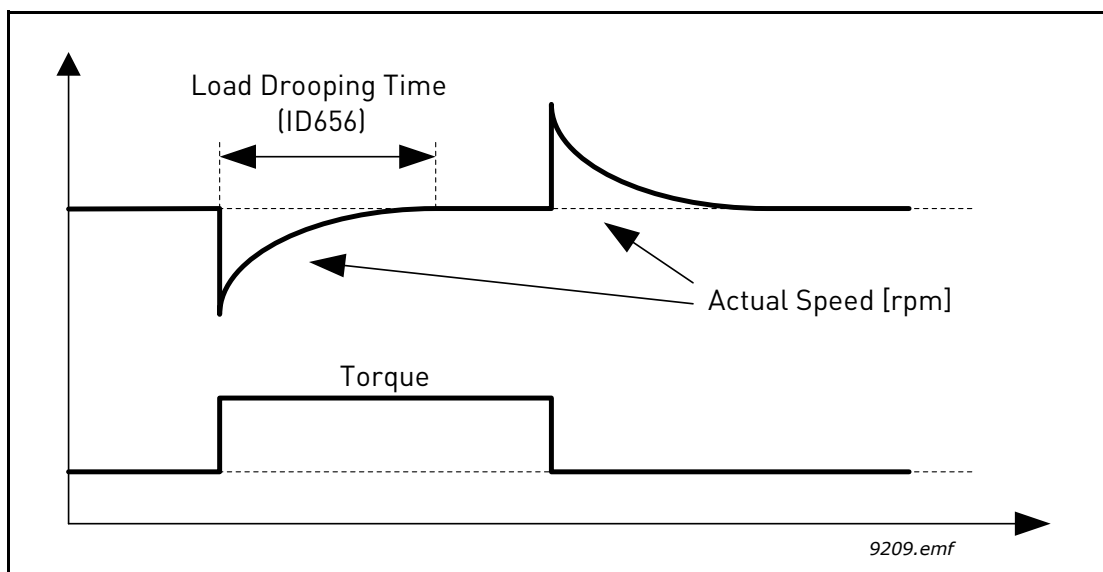

Figure 40. Load drooping

P3.1.2.11 UNDER VOLT. CONTROL

This parameter allow the under voltage controller to be switched out of operation. This may be useful, for example, if the mains supply voltage varies more than -15% and the application will not tolerate this under voltage. In this case, the regulator controls the output frequency taking the supply fluctuations into account.

P3.1.2.13 STATORVOLTADJUST

NOTE! This parameter will be automatically set during the identification run. It is recommended to make the identification run, if possible. See parameter P3.1.2.4.

Stator voltage adjust parameter is used only when *Permanent magnet synchronous motor (PMS motor)* has been selected for parameter P3.1.2.2. This parameter has no affect if *Induction motor* has been selected. With an induction motor in use, the value has been internally forced to 100% and it cannot be changed.

When the value of parameter P3.1.2.2 (Motor type) parameter is changed to *PMS Motor*, the parameters P3.1.4.2 (Field WeakngPnt) and P3.1.4.3 (Voltage at FWP) will be automatically extended up to the limits of the drive's full output voltage, retaining the defined U/f-ratio. This internal extension is done to avoid running the PMS motor in the field weakening area because the PMS motor nominal voltage is typically much lower than the full output voltage capability of the drive.

PMS motor nominal voltage typically represents the motor's back-EMF voltage at nominal frequency, but depending on the motor manufacturer, it may represent e.g. the stator voltage at nominal load.

This parameter gives an easy way to adjust the drive's U/f curve near to the motor's back-EMF curve without needing to change several U/f curve parameters. The StatorVoltAdjust parameter defines the drive's output voltage in percent of the motor's nominal voltage at the motor's nominal frequency.

The U/f curve of the drive is typically tuned slightly above the back-EMF curve of the motor. The motor current increases the more the drive's U/f-curve differs from the motor's back-EMF -curve.

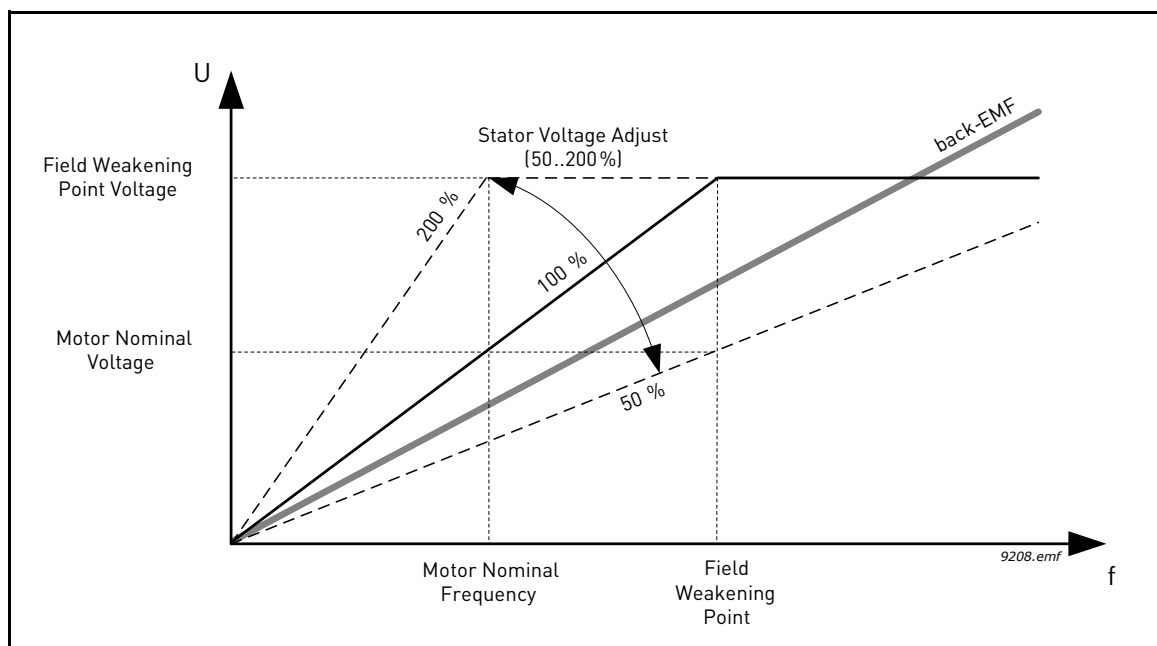

Figure 41. Principle of Stator voltage adjustment

P3.1.3.1 CURRENT LIMIT

This parameter determines the maximum motor current from the AC drive. The parameter value range differs from size to size.

When the current limit is active the drive output frequency is decreased.

NOTE: This is not an overcurrent trip limit.

7.2.2 OPEN LOOP

P3.1.4.1 U/F RATIO

Table 132.

Selection number	Selection name	Description
0	Linear	The voltage of the motor changes linearly as a function of output frequency from zero frequency voltage (P3.1.4.6) to the field weakening point (FWP) voltage (P3.1.4.3) at FWP frequency (P3.1.4.2) This default setting should be used if there is no special need for another setting.
1	Squared	The voltage of the motor changes from zero point voltage (P3.1.4.6) following a squared curve form from zero to the field weakening point (P3.1.4.2) The motor runs under magnetized below the field weakening point and produces less torque. Squared U/f ratio can be used in applications where torque demand is proportional to the square of the speed, e.g. in centrifugal fans and pumps.
2	Programmable	The U/f curve can be programmed with three different points (see Figure 43): Zero frequency voltage (P1), Midpoint voltage/frequency (P2) and Field weakening point (P3). Programmable U/f curve can be used if more torque is needed at low frequencies. The optimal settings can automatically be achieved with Motor identification run (P3.1.2.4).

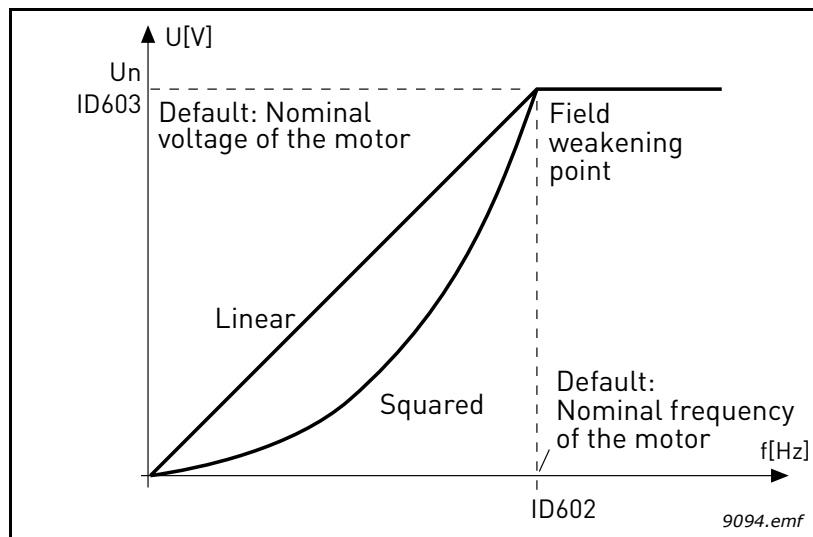

Figure 42. Linear and squared change of motor voltage

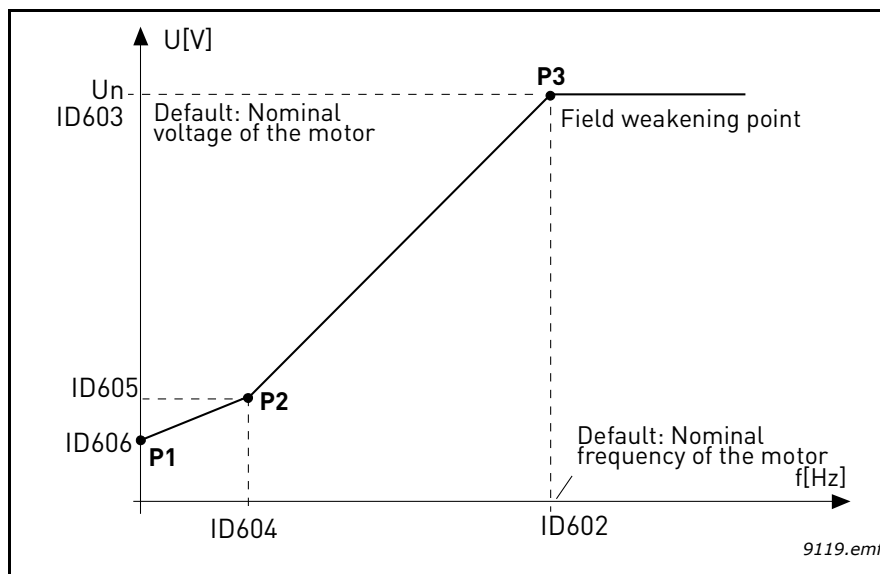

Figure 43. Programmable U/f curve

NOTE!	This parameter is forced to value '1' <i>Linear</i> when parameter <i>Motor type</i> is set to value '1' <i>Permanent Magnet Synchronous Motor (PMSM)</i> .
NOTE!	When this parameter is changed, parameters P3.1.4.2, P3.1.4.3, P3.1.4.4, P3.1.4.5 and P3.1.4.6 will be automatically set to their default values if parameter P3.1.2.2 is set to '0' <i>Induction Motor (IM)</i> .

P3.1.4.3 VOLTAGE AT FWP

Above the frequency at the field weakening point, the output voltage remains at the set maximum value. Below the frequency at the field weakening point, the output voltage depends on the setting of the U/f curve parameters. See parameters P3.1.4.1, P3.1.4.4 and P3.1.4.5.

When the parameters P3.1.1.1 and P3.1.1.2 (*Motor Nom Voltg* and *Motor Nom Freq*) are set, the parameters P3.1.4.2 and P3.1.4.3 are automatically given the corresponding values. If you need different values for the field weakening point and the maximum output voltage, change these parameters **after** setting the parameters P3.1.1.1 and P3.1.1.2.

If the programmed maximum frequency is higher than motor nominal frequency, field weakening point is automatically set at maximum frequency and fwp voltage is set proportionally higher than 100%.

This could allow to exploit the higher voltage possibly coming from the panels.

In this situation the current limit has to be set properly, to prevent a motor overload.

If the drive is fed from mains, maximum output frequency will be limited by actual DC voltage, according to nominal U/f ratio.

P3.1.4.12.1 I/F START

If the function is activated, the drive is set to current control mode and a constant current defined by P3.1.4.11.3 is fed to the motor until the drive output frequency exceeds the level defined with P3.1.4.11.2. When the output frequency has increased above I/f Start Frequency level, drive operation mode is changed smoothly back to normal U/f –control mode.

P3.1.4.12.2 I/F START FREQ

I/f start function is used when the drive’s output frequency is below this frequency limit. When the output frequency exceeds this limit, the drive operation mode is changed back to normal U/f control mode.

P3.1.4.12.3 I/F START CURRENT

This parameter defines the current to be fed to the motor when the I/f start function is activated.

7.2.3 START/STOP SETUP

P3.2.5 STOP FUNCTION

Table 133.

Selection number	Selection name	Description
0	Coasting	The motor is allowed to stop on its own inertia. The control by the drive is discontinued and the drive current drops to zero as soon as the stop command is given.
1	Ramp to min frequency	After the Stop command, the speed of the motor is decelerated to minimum frequency according to the set deceleration parameters.
2	Ramp to zero frequency	After the Stop command, the speed of the motor is decelerated to zero frequency according to the set deceleration parameters.

P3.2.6 I/O A START LOGIC

Values 0...4 offer possibilities to control the starting and stopping of the AC drive with digital signal connected to digital inputs. CS = Control signal.

The selections including the text 'edge' shall be used to exclude the possibility of an unintentional start when, for example, power is connected, re-connected after a power failure, after a fault reset, after the drive is stopped by Run Enable (Run Enable = False) or when the control place is changed to I/O control. **The Start/Stop contact must be opened before the motor can be started.**

The used stop mode is *Coasting* in all examples.

Table 134. I/O A Start Logic selections

Selection number	Selection name	Note
0	CS 1: Start Forward CS 2: Start Backward	The function takes place when the contacts are closed.
1	CS 1: Start Forward CS 2: Reverse	The function takes place when the contacts are closed.

Table 134. I/O A Start Logic selections

Selection number	Selection name	Note
2	Double Start	Run command is set when both Start 1 and Start 2 signals are high. It is reset when both the start signals are low. This can be used for a simple tank level control with hysteresis: if the tank has to be filled, two NC contact sensors will be placed at minimum and maximum levels. The drive will start below the minimum and stop above the maximum. If the tank has to be emptied, two NO contact sensors have to be used. The drive will start above the maximum and stop below the minimum.
3	Start sign 1 + Analogue	Run command is set when Start 1 signal is high and a selectable analogue input is below (or above) a programmable threshold. This can be used for a tank level control, where the analogue measurement is used for both starting the pump and controlling the speed.
4	Solar only	Run command is always active. Actual running condition is determined by DC voltage level available from the solar array.

Table 135.

Selection number	Selection name	Note
0	CS1: Forward CS2: Backward	The functions take place when the contacts are closed.

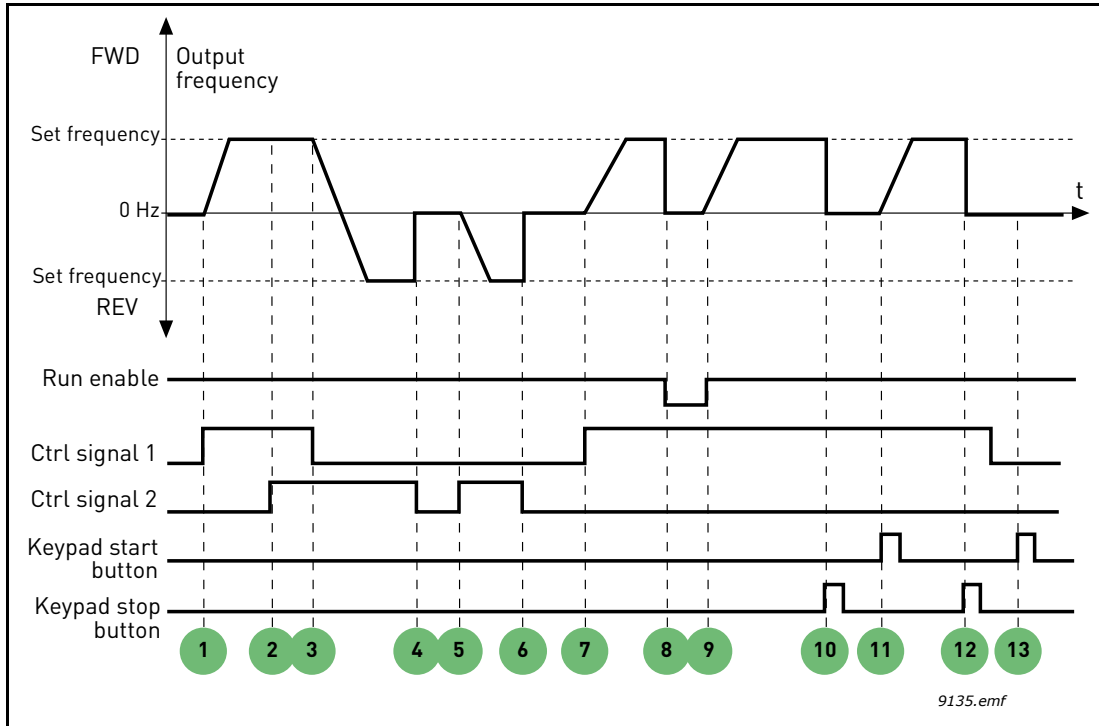

Figure 44. I/O A Start logic = 0

Explanations:

Table 136.

1	Control signal (CS) 1 activates causing the output frequency to rise. The motor runs forward.	8	Run enable signal is set to FALSE, which drops the frequency to 0. The run enable signal is configured with parameter P3.5.1.15.
2	CS2 activates which, however, has no effect on the output frequency because the first selected direction has the highest priority.	9	Run enable signal is set to TRUE, which causes the frequency to rise towards the set frequency because CS1 is still active.
3	CS1 is inactivated which causes the direction to start changing (FWD to REV) because CS2 is still active.	10	Keypad stop button is pressed and the frequency fed to the motor drops to 0. (This signal only works if P3.2.3 Keypad stop button = Yes)
4	CS2 inactivates and the frequency fed to the motor drops to 0.	11	The drive starts through pushing the Start button on the keypad.
5	CS2 activates again causing the motor to accelerate (REV) towards the set frequency.	12	The keypad stop button is pushed again to stop the drive.
6	CS2 inactivates and the frequency fed to the motor drops to 0.	13	The attempt to start the drive through pushing the Start button is not successful because CS1 is inactive.
7	CS1 activates and the motor accelerates (FWD) towards the set frequency		

Table 137.

Selection number	Selection name	Note
1	CS1: Start CS2: Reverse	The function takes place when the contacts are closed.

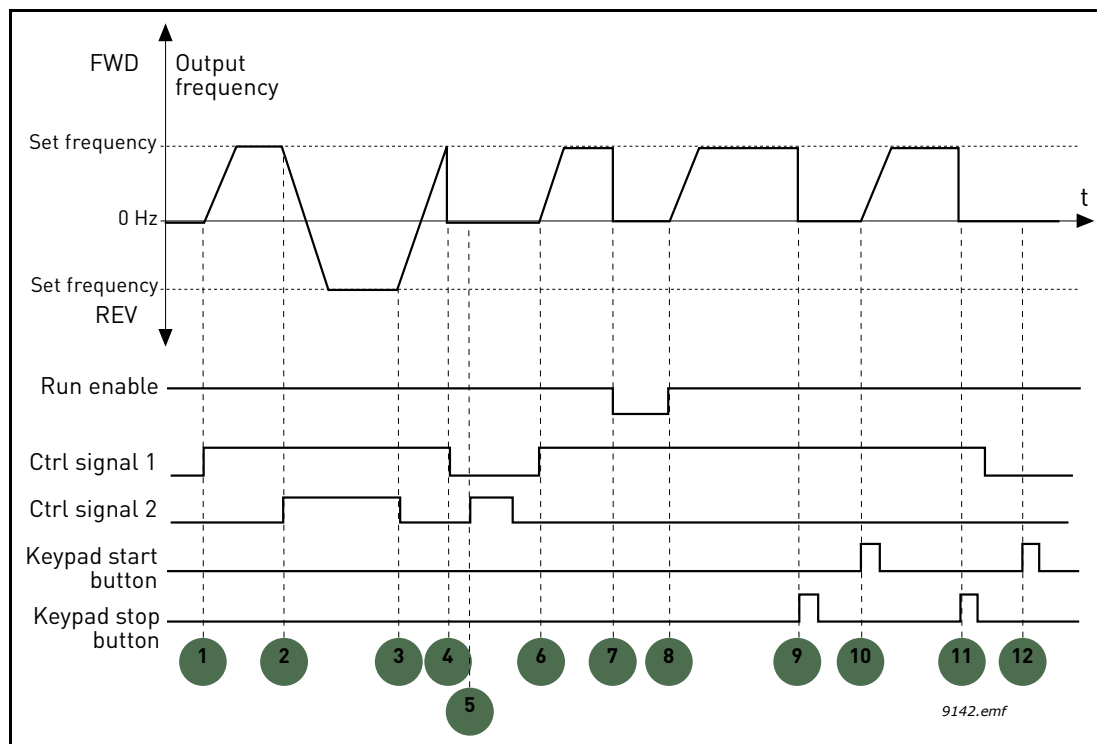

Figure 45. I/O A Start logic = 1

Table 138.

1	Control signal (CS) 1 activates causing the output frequency to rise. The motor runs forward.	7	Run enable signal is set to FALSE, which drops the frequency to 0. The run enable signal is configured with parameter P3.5.1.15.
2	CS2 activates which causes the direction to start changing (FWD to REV).	8	Run enable signal is set to TRUE, which causes the frequency to rise towards the set frequency because CS1 is still active.
3	CS2 is inactivated which causes the direction to start changing (REV to FWD) because CS1 is still active.	9	Keypad stop button is pressed and the frequency fed to the motor drops to 0. (This signal only works if P3.2.3 Keypad stop button = Yes)
4	Also CS1 inactivates and the frequency drops to 0.	10	The drive starts through pushing the Start button on the keypad.
5	Despite the activation of CS2, the motor does not start because CS1 is inactive.	11	The drive is stopped again with the stop button on the keypad.
6	CS1 activates causing the output frequency to rise again. The motor runs forward because CS2 is inactive.	12	The attempt to start the drive through pushing the Start button is not successful because CS1 is inactive.

7.2.4 REFERENCES

P3.3.1.1 MINFREQREFERENCE

Minimum frequency reference.

NOTE: When drive is fed by solar power, if available power is not sufficient to maintain dc voltage above the minimum and frequency above the minimum, the drive will be stopped.

NOTE: if motor current limit is reached, actual output frequency might be lower than this parameter. If this is not acceptable, stall protection should be activated.

P3.3.1.2 MAXFREQREFERENCE

Maximum frequency reference.

7.2.5 PRESET FREQS

P3.3.3.1 PRESETFREQMODE

You can use the preset frequency parameters to define certain frequency references in advance. These references are then applied by activating/inactivating digital inputs connected to parameters P3.3.3.10, P3.3.3.11 and P3.3.3.12 (*Preset Freq Sel0, Preset Freq Sel1 and Preset Freq Sel2*). Two different logics can be selected:

Table 139.

Selection number	Selection name	Note
0	Binary coded	Combine activated inputs according to Table 141 to choose the Preset frequency needed.
1	Number (of inputs used)	According to how many of the inputs assigned for <i>Preset frequency selections</i> are active you can apply the <i>Preset frequencies</i> 1 to 3.

P3.3.3.2 TO P3.3.3.9 PRESET FREQ 0 TO 7

Value '0' selected for parameter P3.3.3.1:

Preset frequency 0 can be chosen as reference by selecting value 1 for parameter P3.3.1.5.

Other preset frequencies 1 to 7 are selected as reference by dedicating digital inputs for parameters P3.3.3.10, P3.3.3.11 and/or P3.3.3.12. Combinations of active digital inputs determine the used preset frequency according to Table 141 below.

The values of the preset frequencies are automatically limited between the minimum and maximum frequencies (P3.3.1.1 and P3.3.1.2). See table below.

Preset Freq 0:

Table 140.

Required action	Activated frequency
Choose value 1 for parameter P3.3.1.5	Preset Freq 0

Preset frequencies 1 to 7:

Table 141. Selection of preset frequencies; ■ = input activated

Activate digital input for parameter			Activated frequency
P3.3.3.12	P3.3.3.11	P3.3.3.10	Preset Freq 1
P3.3.3.12	P3.3.3.11	P3.3.3.10	Preset Freq 2
P3.3.3.12	P3.3.3.11	P3.3.3.10	Preset Freq 3
P3.3.3.12	P3.3.3.11	P3.3.3.10	Preset Freq 4
P3.3.3.12	P3.3.3.11	P3.3.3.10	Preset Freq 5
P3.3.3.12	P3.3.3.11	P3.3.3.10	Preset Freq 6
P3.3.3.12	P3.3.3.11	P3.3.3.10	Preset Freq 7

Value '1' selected for parameter P3.3.3.1:

According to how many of the inputs assigned for Preset frequency selections are active, you can apply the Preset frequencies 1 to 3.

Table 142. Selection of preset frequencies; ■ = input activated

Activated input			Activated frequency
P3.3.3.12	P3.3.3.11	P3.3.3.10	Preset Freq 1
P3.3.3.12	P3.3.3.11	P3.3.3.10	Preset Freq 1
P3.3.3.12	P3.3.3.11	P3.3.3.10	Preset Freq 1
P3.3.3.12	P3.3.3.11	P3.3.3.10	Preset Freq 2
P3.3.3.12	P3.3.3.11	P3.3.3.10	Preset Freq 2
P3.3.3.12	P3.3.3.11	P3.3.3.10	Preset Freq 2
P3.3.3.12	P3.3.3.11	P3.3.3.10	Preset Freq 3

P3.3.3.10 PRESET FREQ SEL0

P3.3.3.11 PRESET FREQ SEL1

P3.3.3.12 PRESET FREQ SEL2

Connect a digital input to these functions (see chapter 7.1.2) to be able to apply Preset frequencies 1 to 7 (see Table 141 and pages 100, 104 and 152).

7.2.6 MOTOR POTENTIOM.

P3.3.4.1 MotPot UP
P3.3.4.2 MotPot DOWN

With a motor potentiometer, the user can increase and decrease the output frequency. By connecting a digital input to parameter P3.3.4.1 (*MotPot UP*) and having the digital input signal active, the output frequency will rise as long as the signal is active. The parameter P3.3.4.2 (*MotPot DOWN*) works vice versa, decreasing the output frequency.

The rate how the output frequency either rises or falls when Motor Potentiometer Up or Down is activated is determined by the *Motor potentiometer ramp time* (P3.3.4.3) and the Ramp acceleration/deceleration times (P3.4.1.2/P3.4.1.3).

The Motor potentiometer reset parameter (P3.3.4.4) will set the frequency reference to zero if activated.

P3.3.4.4 MOTPOT RESET

Defines the logic for resetting the motor potentiometer frequency reference.

Selection number	Selection name	Note
0	No reset	The previous motor potentiometer frequency reference is kept past the stop state and stored to memory in case of power down.
1	Stop state	Motor potentiometer frequency reference is set to zero when the drive is in stop state or the drive is powered down.
2	Powered down	Motor potentiometer frequency reference is set to zero only in a power down situation.

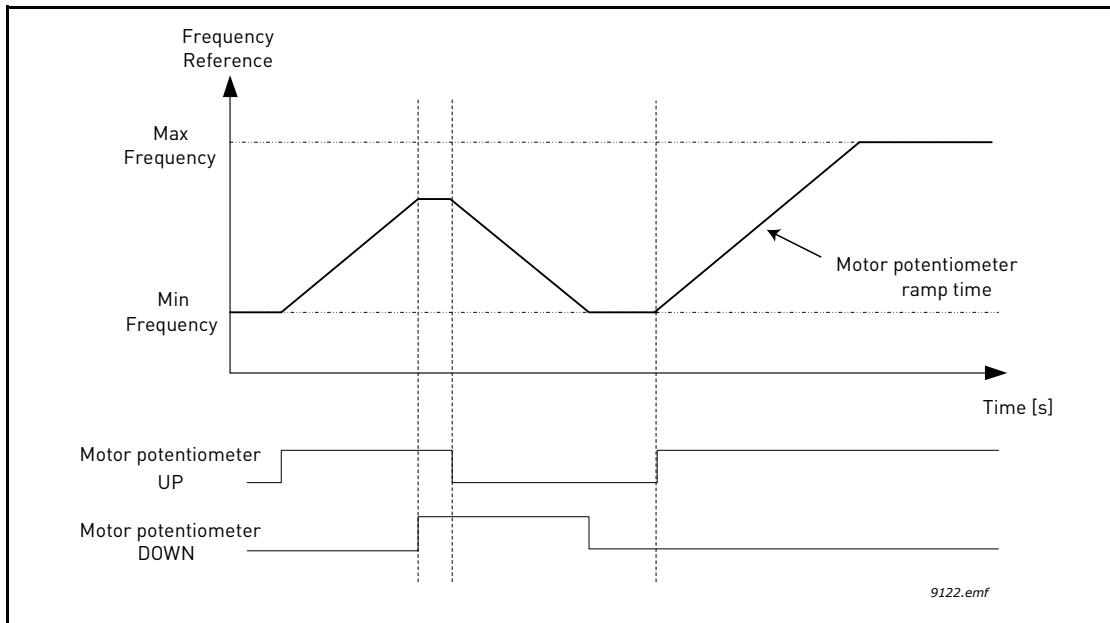

Figure 46. Motor potentiometer parameters

7.2.7 RAMPS AND BRAKES

P3.4.1.2 ACCEL TIME 1

Ramp time, referred to variation from zero frequency to max frequency.

A specific acceleration time from zero to minimum frequency is available (P2.9).

Normal acceleration time (P1.3) is active only in case power is from mains supply.

P3.4.1.3 DECEL TIME 1

Ramp time, referred to variation from max frequency to zero.

Normal deceleration time (P3.4.1.3) is active in mains supply and in case the external frequency reference is lowered below the reference of maximum power. It is also active when start command falls and ramping stop is programmed (stop mode is anyway by coasting, when the output frequency is below minimum).

Specific acceleration and deceleration time are used during power regulation. They are available as parameters in MPPT group, but it is suggested not to change them, unless needed because of stability issues.

P3.4.1.4 START ACCELERATION TIME

A specific acceleration time from zero to minimum frequency is available (P3.4.1.4). Normal acceleration time (P3.4.1.3) is active only in case power is from mains supply. Normal deceleration time (P3.4.1.4) is active in mains supply and in case the external frequency reference is lowered below the reference of maximum power. It is also active when start command falls and ramping stop is programmed (stop mode is anyway by coasting, when the output frequency is below minimum).

Specific acceleration and deceleration time are used when power is from solar panels. They are available as parameters in MPPT group, but it is suggested not to change them, unless needed because of stability issues.

7.2.8 FLUX BRAKING

P3.4.5.1 FLUX BRAKING

Instead of DC braking, flux braking is a useful way to raise the braking capacity in cases where additional brake resistors are not needed.

When braking is needed, the frequency is reduced and the flux in the motor is increased, which in turn increases the motor's capability to brake. Unlike DC braking, the motor speed remains controlled during braking.

The flux braking can be set ON or OFF.

NOTE: Flux braking converts the energy into heat at the motor, and should be used intermittently to avoid motor damage.

7.2.9 DIGITAL INPUTS

P3.5.1.15 RUN ENABLE

Contact open: Start of motor **disabled**

Contact closed: Start of motor **enabled**

The AC drive is stopped according to the selected function at P3.2.5. The follower drive will always coast to stop.

P3.5.1.16 RUN INTERLOCK 1

P3.5.1.17 RUN INTERLOCK 2

The drive cannot be started if any of the interlocks are open.

The function could be used for a damper interlock, preventing the drive to start with damper closed.

P3.5.1.52 ENERGY COUNTER RESET

This parameter enables reset of Energy counter.

P3.5.1.53 MAINS SUPPLY ON

In case the drive is fed by mains supply, the controller knows this situation through a specific digital input.

The functions related to DC voltage (start enable, MPPT) are disabled in this condition.

7.2.10 ANALOG INPUTS

P3.5.2.1.2 AI1 FILTER TIME

When this parameter is given a value greater than 0 the function that filters out disturbances from the incoming analogue signal is activated.

NOTE: Long filtering time makes the regulation response slower!

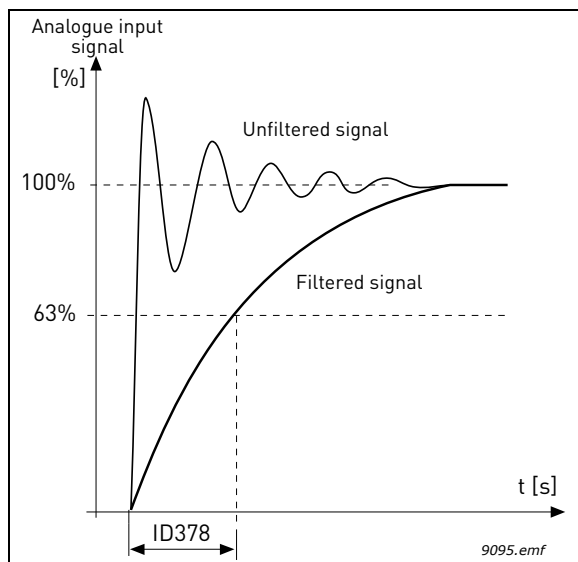

Figure 47. AI1 signal filtering

P3.5.2.1.3 AI1 SIGNAL RANGE

The signal range for the analogue signal can be selected as:

Type of the analogue input signal (current or voltage) is selected by the dip switches on the control board (see Installation manual).

In the following examples, the analogue input signal is used as a frequency reference. The figures show how the scaling of the analogue input signal is changed depending on the setting of this parameter.

Selection number	Selection name	Description
0	0...10 V/0...20 mA	Analogue input signal range 0...10 V or 0...20 mA (depending on dip switch settings on the control board). Input signal used 0...100%.

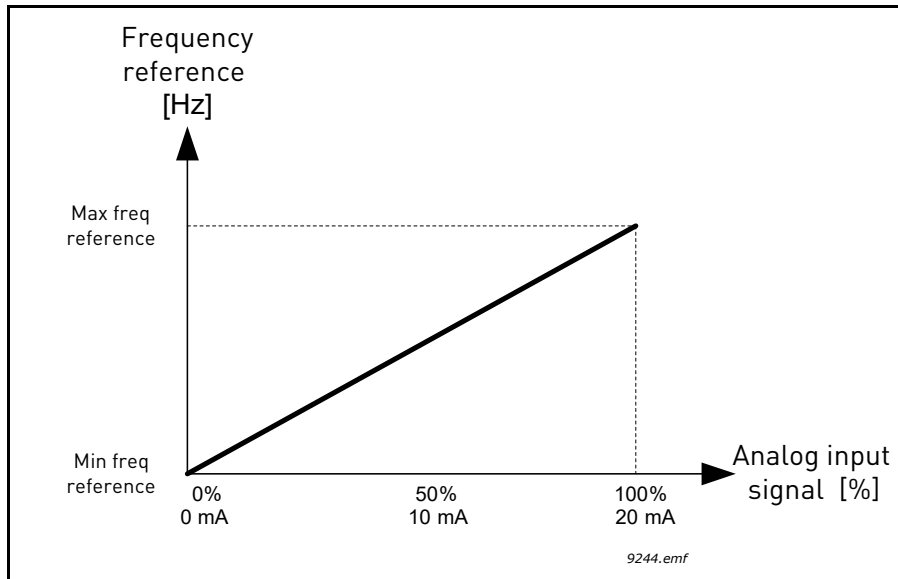

Figure 48. Analogue input signal range, selection '0'

Selection number	Selection name	Description
1	2...10 V/4...20 mA	Analogue input signal range 2...10 V or 4...20 mA (depending on dip switch settings on the control board). Input signal used 20...100%.

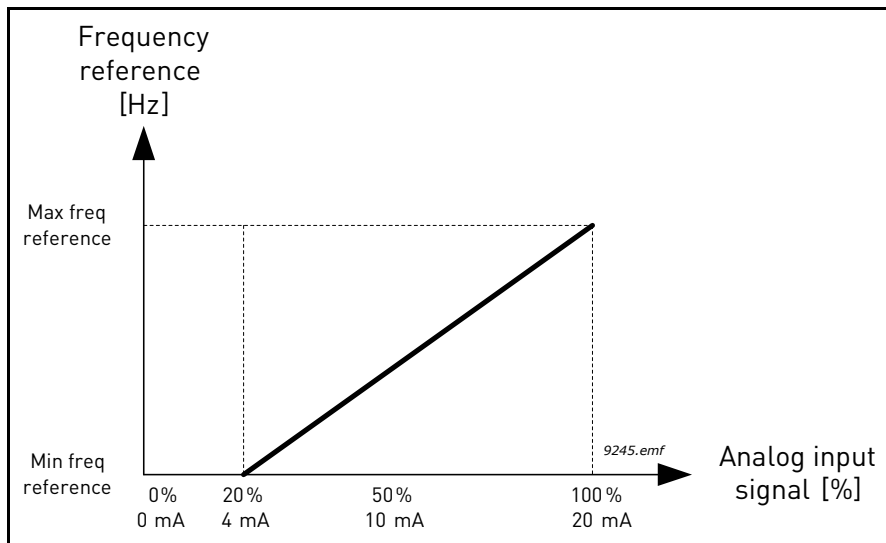

Figure 49. Analogue input signal range, selection '1'

P3.5.2.1.4 AI1 CUSTOM MIN

P3.5.2.1.5 AI1 CUSTOM MAX

These parameters allow you to freely adjust the analogue input signal range between -160...160%.

Example: If the analogue input signal is used as frequency reference and these parameters are set to 40...80%, the frequency reference is changed between the *Minimum frequency reference* and the *MaxFreqReference* when the analogue input signal is changed between 8...16 mA.

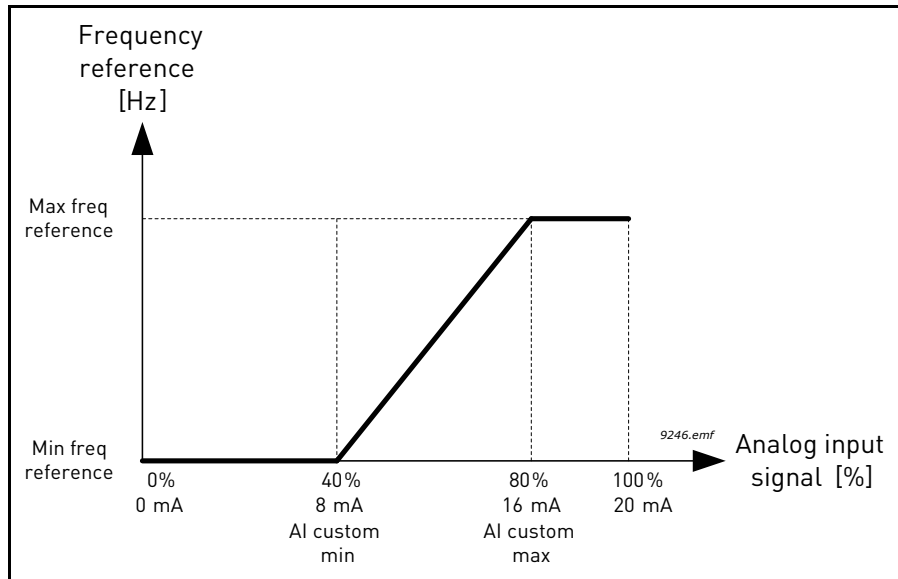

Figure 50. AI signal custom min/max

P3.5.2.1.6 AI1 SIGNAL INV

Invert the analogue signal with this parameter.

In the following examples, the analogue input signal is used as frequency reference. The figures show how the scaling of the analogue input signal is changed depending on the setting of this parameter.

Selection number	Selection name	Description
0	Normal	No inversion. The analogue input signal value 0% corresponds to the <i>Minimum frequency reference</i> and the analogue input signal value 100% to the MaxFreqReference.

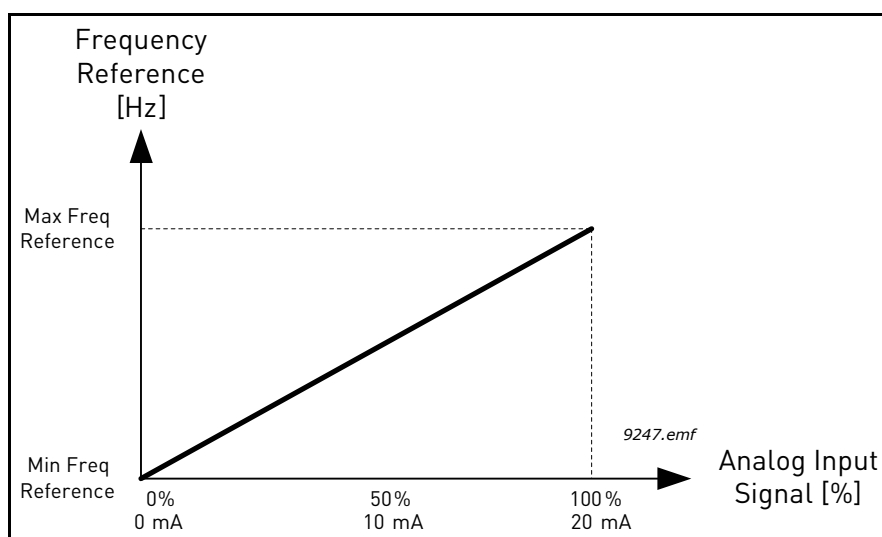

Figure 51. AI signal inversion, selection '0'

Selection number	Selection name	Description
1	Inverted	Signal inverted. The analogue input signal value 0% corresponds to the MaxFreqReference and the analogue input signal value 100% to the <i>Minimum frequency reference</i> .

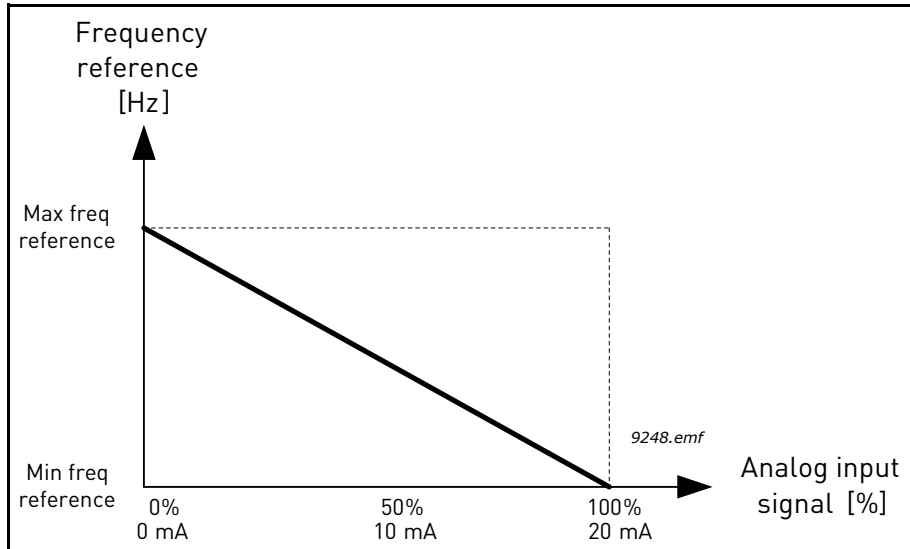

Figure 52. AI signal inversion, selection '1'

7.2.11 DIGITAL OUTPUTS

P3.5.3.2.1 RO1 FUNCTION

Table 143. Output signals via RO1

Selection	Selection name	Description
0	None	Output not used
1	Ready	The AC drive is ready to operate
2	Run	The AC drive operates (motor is running)
3	General fault	A fault trip has occurred
4	General fault inverted	A fault trip has not occurred
5	General alarm	An alarm has been initiated
6	Reversed	The reverse command has been given
7	At speed	The output frequency has reached the set frequency reference
8	Thermistor fault	A thermistor fault has occurred.
9	Motor regulator active	One of the limit regulators (e.g. current limit, torque limit) is activated
10	Start signal active	Drive start command is active.
11	Keypad control active	Keypad control selected (active control place is keypad).
12	I/O B control activated	I/O control place B selected (active control place is I/O B)
13	Limit supervision 1	Activates if the signal value falls below or exceeds the set supervision limit (P3.8.3 or P3.8.7) depending on the selected function.
14	Limit supervision 2	

Table 143. Output signals via R01

Selection	Selection name	Description
15	SinglePowerOn	Single PO (Power On) Threshold can be used to set level for R01 or R02 to switch off when DC voltage goes below the setting level. The relay function must be programmed as 15/Single Power On. Relay can be used to control to connect additional resistor into DC supply. Resistor will eliminate power on/off cycle when supply voltage drops into drive shut down level. Resistor size can be selected approximately equal to drive standby losses.
16	No function	
17	Preset speed active	The preset frequency has been selected with digital input signals.
18	No function	
19	PID in Sleep mode	PID-controller is in Sleep mode.
20	PID Soft Fill active	PID-controller Soft Fill function is activated.
21	PID supervision limits	PID-controller feedback value is beyond the supervision limits.
22	Ext PID supervision limits	External PID-controller feedback value is beyond the supervision limits.
23	Input press. alarm/fault	The input pressure signal value of the pump has fallen below the value defined.
24	Frost prot. alarm/fault	
25	No function	
26	No function	
27	No function	
28	No function	
29	No function	
30	No function	
31	RTC time chnl 1 control	Status of Time channel 1
32	RTC time chnl 2 control	Status of Time channel 2
33	RTC time chnl 3 control	Status of Time channel 3
34	FB ControlWord B13	Digital (relay) output control from Fieldbus control word bit 13.
35	FB ControlWord B14	Digital (relay) output control from Fieldbus control word bit 14.
36	FB ControlWord B15	Digital (relay) output control from Fieldbus control word bit 15.
37	FB ProcessData1.B0	Digital (relay) output control from Fieldbus Process Data In1, bit 0.
38	FB ProcessData1.B1	Digital (relay) output control from Fieldbus Process Data In1, bit 1.
39	FB ProcessData1.B2	Digital (relay) output control from Fieldbus Process Data In1, bit 2.
40	Maintenance alarm	Maintenance counter has reached the alarm limit defined with parameter.
41	Maintenance Fault	Maintenance counter has reached the alarm limit defined with parameter.
42	No function	
43	No function	
54	No function	
55	No function	
56	Auto-cleaning active	Pump auto-cleaning function is activated.
57	Motor Switch Open	

Table 143. Output signals via R01

Selection	Selection name	Description
58	TEST (Always Closed)	
59	No function	
60	DualSupply AC switch	

7.2.12 ANALOG OUTPUTS

P3.5.4.1.1 AO1 FUNCTION

This parameter defines the content of the analogue output signal 1. The scaling of the analogue output signal depends on the selected signal. See Table 144.

Table 144. AO1 signal scaling

Selection	Selection name	Description
0	Test 0% (Not used)	Analogue output is forced either to 0% or 20% depending on parameter P3.5.4.1.3.
1	TEST 100%	Analogue output is forced to 100% signal (10 V / 20 mA).
2	Output frequency	Actual output frequency from zero to MaxFreqReference.
3	Frequency reference	Actual frequency reference from zero to MaxFreqReference.
4	Motor speed	Actual motor speed from zero to Motor Nom Speed.
5	Output current	Drive output current from zero to Motor Nom Currnt.
6	Motor torque	Actual motor torque from zero to motor nominal torque (100%).
7	Motor power	Actual motor power from zero to Motor Nom Power (100%).
8	Motor voltage	Actual motor voltage from zero to Motor Nom Voltg.
9	DC-link voltage	Actual DC-link voltage 0...1000 V.
10	PID output	PID controller output (0...100%).
11	ExtPID output	External PID controller output (0...100%).
12	Fieldbus Process Data In 1	Fieldbus Process Data In 1 from 0...10000 (corresponding 0...100.00%).
13	Fieldbus Process Data In 2	Fieldbus Process Data In 2 from 0...10000 (corresponding 0...100.00%).
14	Fieldbus Process Data In 3	Fieldbus Process Data In 3 from 0...10000 (corresponding 0...100.00%).
15	Fieldbus Process Data In 4	Fieldbus Process Data In 4 from 0...10000 (corresponding 0...100.00%).
16	Fieldbus Process Data In 5	Fieldbus Process Data In 5 from 0...10000 (corresponding 0...100.00%).
17	Fieldbus Process Data In 6	Fieldbus Process Data In 6 from 0...10000 (corresponding 0...100.00%).
18	Fieldbus Process Data In 7	Fieldbus Process Data In 7 from 0...10000 (corresponding 0...100.00%).
19	Fieldbus Process Data In 8	Fieldbus Process Data In 8 from 0...10000 (corresponding 0...100.00%).

P3.5.4.1.4 AO1 MINSCALE**P3.5.4.1.5 AO1 MAXSCALE**

These parameters can be used to freely adjust the analogue output signal scaling. The scale is defined in process units and it depends on the selection of parameter P3.5.4.1.1.

Example: The drive's output frequency is selected for the content of the analogue output signal and parameters P3.5.4.1.4 and P3.5.4.1.5 are set to 10...40 Hz.

When the drive's output frequency changes between 10 and 40 Hz the analogue output signal changes between 0...20 mA.

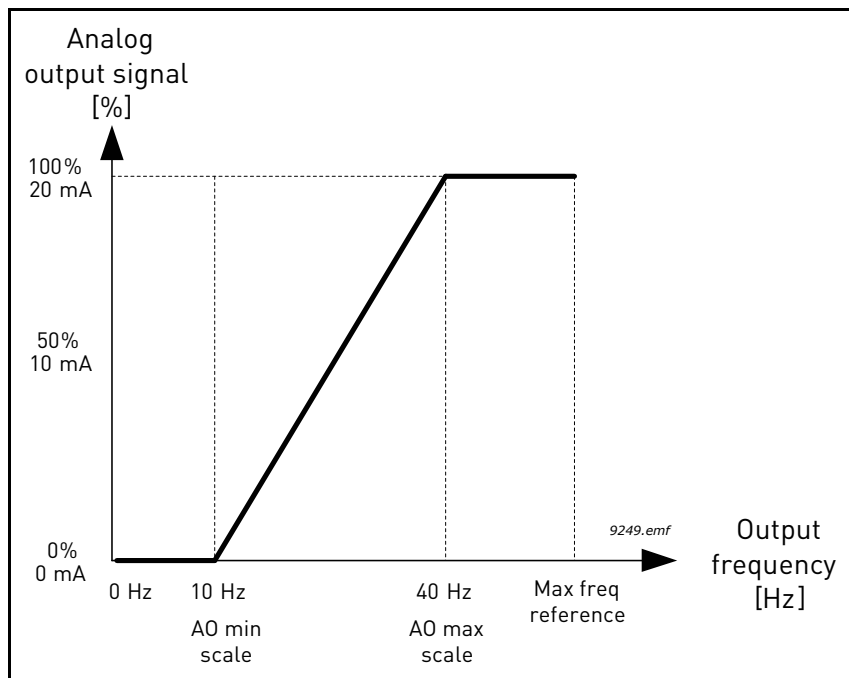

Figure 53. AO1 signal scaling

7.2.13 PROHIBIT FREQ

- P3.7.1** RANGE 1 LOW LIM
- P3.7.2** RANGE 1 HIGH LIM
- P3.7.3** RANGE 2 LOW LIM
- P3.7.4** RANGE 2 HIGH LIM
- P3.7.5** RANGE 3 LOW LIM
- P3.7.6** RANGE 3 HIGH LIM

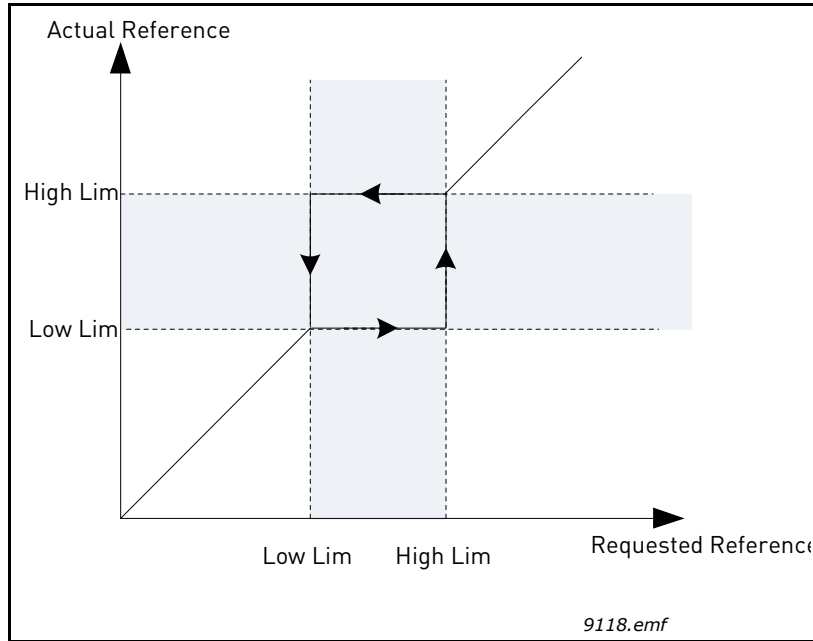

Figure 54. Prohibited frequencies

P3.7.7 RAMPTIMEFACTOR

The *Ramp time factor* defines the acceleration/deceleration time when the output frequency is in a prohibited frequency range. The *Ramp time factor* is multiplied with the value of parameters P3.4.1.2/P3.4.1.3 (*Ramp acceleration/deceleration time*). For example the value 0.1 makes the acceleration/deceleration time ten times shorter.

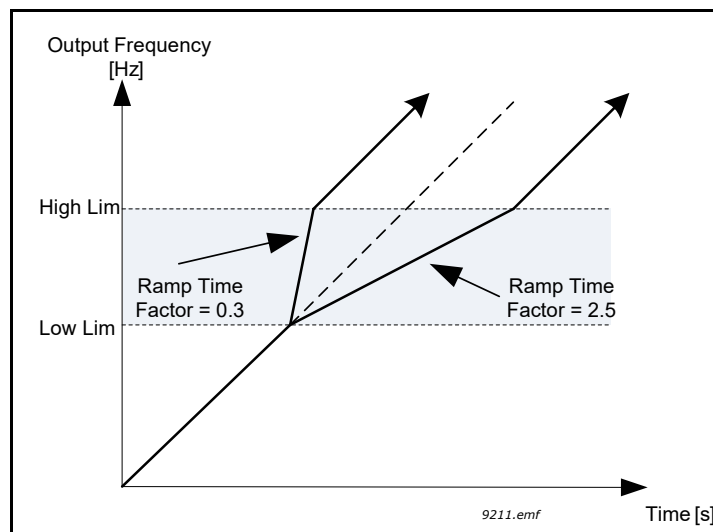

Figure 55. Ramp time factor

7.2.14 PROTECTIONS

P3.9.1.2 EXTERNAL FAULT

An alarm message or a fault action and message is generated by an external fault external fault signal in one of the programmable digital inputs (DI3 by default) using parameters P3.5.1.11 and P3.5.1.12. The information can also be programmed into any of the relay outputs.

P3.9.2.3 ZEROSPEEDCOOLING

Defines the cooling factor at zero speed in relation to the point where the motor is running at nominal speed without external cooling. See Figure 56.

The default value is set assuming that there is no external fan cooling the motor. If an external fan is used this parameter can be set to 90% (or even higher).

If you change the parameter P3.1.1.4 (*Motor Nom Currnt*), this parameter is automatically restored to the default value.

Setting this parameter does not affect the maximum output current of the drive which is determined by parameter P3.1.3.1 alone.

The corner frequency for the thermal protection is 70% of the motor nominal frequency (P3.1.1.2).

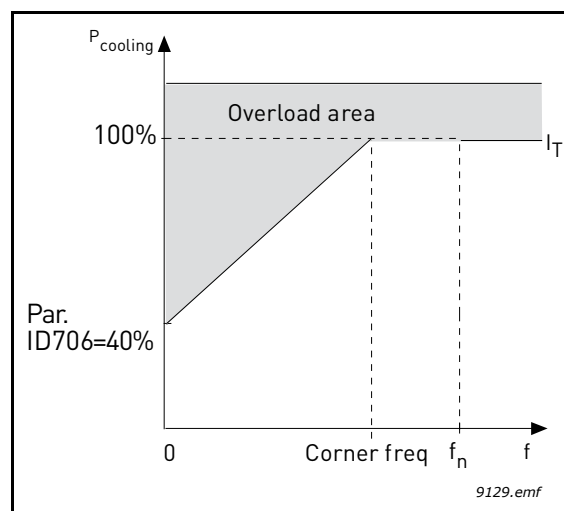

Figure 56. Motor thermal current I_T curve

P3.9.2.4 THERMALTIMECONST

This is the thermal time constant of the motor. The bigger the motor, the bigger the time constant. The time constant is the time within which the calculated thermal stage has reached 63% of its final value.

The motor thermal time is specific to the motor design and it varies between different motor manufacturers. The default value of the parameter varies from size to size.

If the motor's t_6 -time (t_6 is the time in seconds the motor can safely operate at six times the rated current) is known (given by the motor manufacturer) the time constant parameter can be set basing on it. As a rule of thumb, the motor thermal time constant in minutes equals to $2 \cdot t_6$. If the drive is in stop stage the time constant is internally increased to three times the set parameter value. The cooling in stop stage is based on convection and the time constant is increased. See Figure 58.

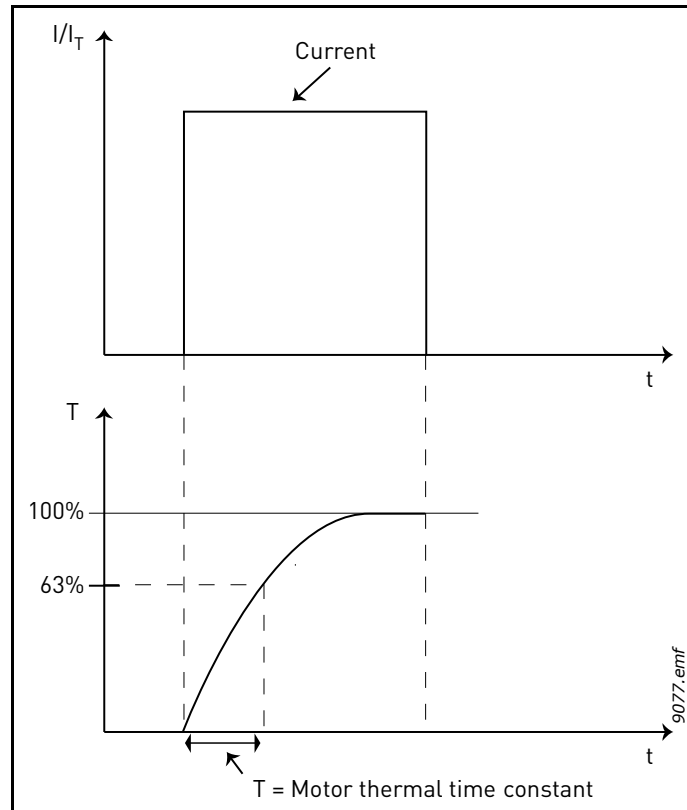

Figure 57. Motor thermal time constant

P3.9.2.5 MOTHERMLOADBIL

Setting value to 130% means that the nominal temperature will be reached with 130% of motor nominal current.

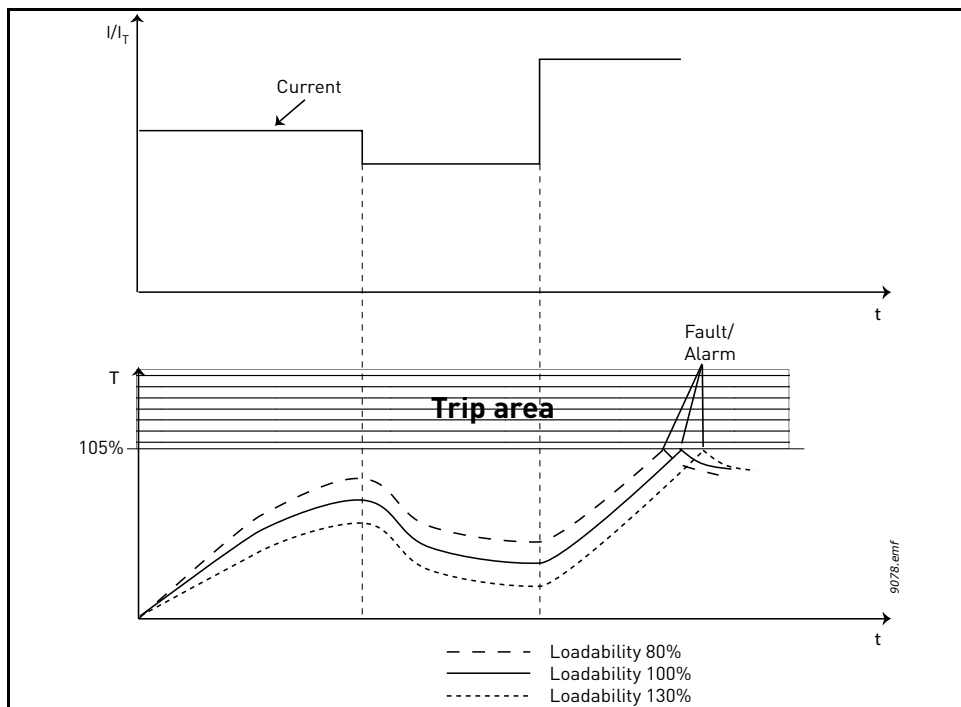

Figure 58. Motor temperature calculation

P3.9.2.6 MOTTEMPINITIALMODE

Table 145.

Selection	Description
0	Disabled, The estimated motor temperature rise is set to zero.
1	Constant, Sets the motor temperature rise estimate to a value which equals the parameter P3.9.2.7 MotTempInitialAdjust value.
2	Last value, Sets the motor temperature rise estimate to a last saved motor temperature rise estimate multiplied with the parameter P3.9.2.7 MotTempInitialAdjust value.
3	Real time clock, Similar to the last value mode, but the last saved motor temperature rise estimate is affected by real time and the parameter P3.9.2.4 ThermTimeConst. This mode requires that a battery is connected to the real time clock.

P3.9.3.2 STALL CURRENT

The current can be set to $0.0...2 \cdot I_L$. For a stall stage to occur, the current must have exceeded this limit. See Figure 59. If parameter P3.1.3.1 *Current Limit* is changed, this parameter is automatically calculated to 90% of the current limit.

NOTE! In order to guarantee desired operation, this limit must be set below the current limit.

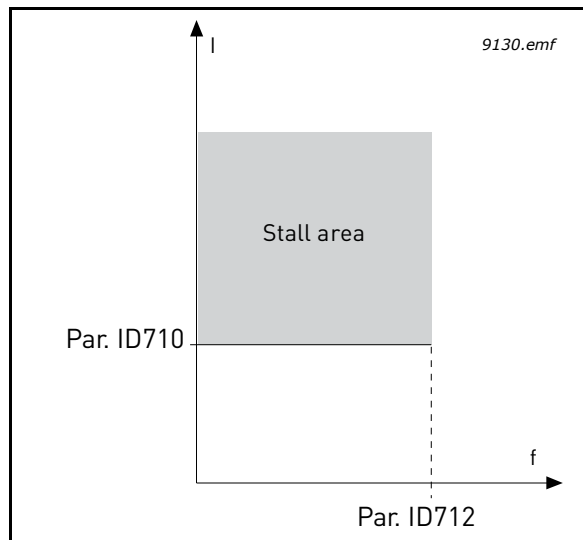

Figure 59. Stall characteristics settings

P3.9.3.3 STALL TIME LIMIT

This time can be set between 1.0 and 120.0s.

This is the maximum time allowed for a stall stage. The stall time is counted by an internal up/down counter.

If the stall time counter value goes above this limit the protection will cause a trip (see P3.9.3.1).

P3.9.4.2 FIELDWEAK. LOAD

The torque limit can be set between 10.0-150.0% $\times T_{nMotor}$.

This parameter gives the value for the minimum torque allowed when the output frequency is above the field weakening point. See Figure 60.

If you change parameter P3.1.1.4 (*Motor Nom Currnt*) this parameter is automatically restored to the default value.

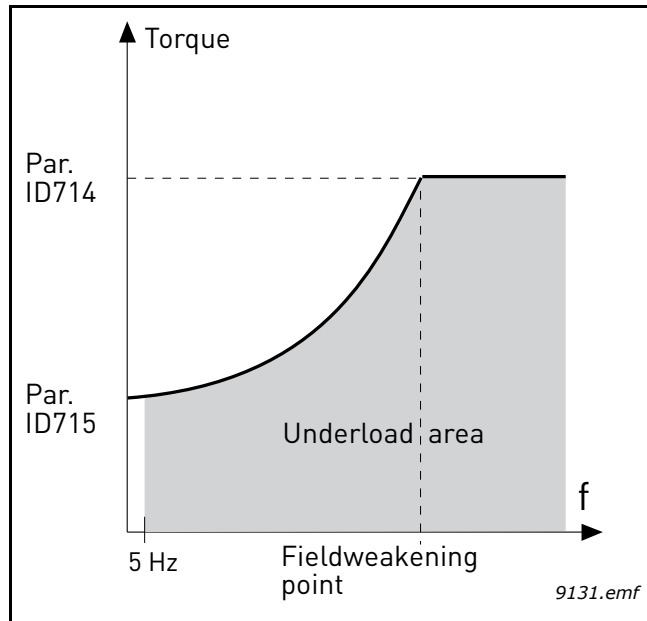

Figure 60. Setting of minimum load

P3.9.4.4 TIME LIMIT

This time can be set between 2.0 and 600.0 s.

This is the maximum time allowed for an under load state to exist. An internal up/down counter counts the accumulated under load time. If the under load counter value goes above this limit the protection will cause a trip according to parameter P3.9.4.1). If the drive is stopped the under load counter is reset to zero. See Figure 61.

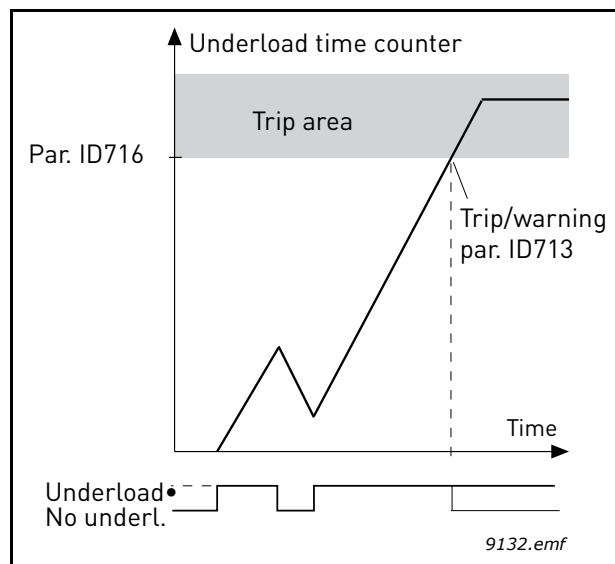

Figure 61. Under load time counter function

7.2.15 AUTOMATIC RESET

P3.10.1 AUTOMATIC FAULT RESET

0: Disabled

1: Enabled

The automatic reset function deletes fault state when the fault cause has been eliminated and the wait time P10.2 has elapsed. Parameter P10.4 determines the maximum number of automatic resets that can be effected during the trial time set by parameter P10.3. The time count starts from the first automatic reset. If the number of faults detected during the trial time exceeds the values of trials, the fault status becomes permanent and a reset command is needed.

P3.10.2 WAIT TIME

Time after which the converter attempts to restart the motor automatically after the fault has been cleared.

P3.10.3 AUTOMATIC RESET TRIES

Trials attempted during one hour.

P3.10.4 RESTART FUNCTION

We can chose what kind of start function we want to use when doing an autoreset of the drive. If run command is kept active during the autoreset sequence.

0= Flying Start

1= Start Function (according to P3.2.4)

P3.10.5 TO

P3.10.7 UNDERLOAD RESET TIME 1-3

Under voltage fault is reset without limitations, also when P10.1 is not active. The drive will restart according the delay times defined by the parameters P14.1.1 to P14.1.4.

Under load (dry run) fault is reset when P3.10.1 is active, without limitations in number, but according to a specific time schedule.

At first fault, autoreset is done after time 1 (P3.10.5). If under load fault happens again, after the number of tries defined in P3.10.8, delay becomes time 2 (P3.10.6).

Similarly, delay will change to time 3 (P3.10.7) if further tries are unsuccessful.

Five minutes of correct working will reset the tries counter.

Any other fault:

Generic autoreset is enabled by P3.10.1. Faults will be reset after the wait time (P3.10.2), unless the number of faults in a hour overcomes the threshold in P3.10.3. Any fault event, apart under voltage and under load, causes counter increasing.

Note: fault led (red) blinks during the autoreset wait time.

P3.10.8 UNDERLOAD TRIES T1, T2

Trials attempted during Underload Reset time 1 and Underload Reset time 2.

7.2.16 FEEDBACKS

P3.13.1.9 DEAD BAND

P3.13.1.10 DEAD BAND DELAY

The PID controller output is locked if the actual value stays within the dead band area around the reference for a predefined time. This function will prevent unnecessary movement and wear on actuators, e.g. valves.

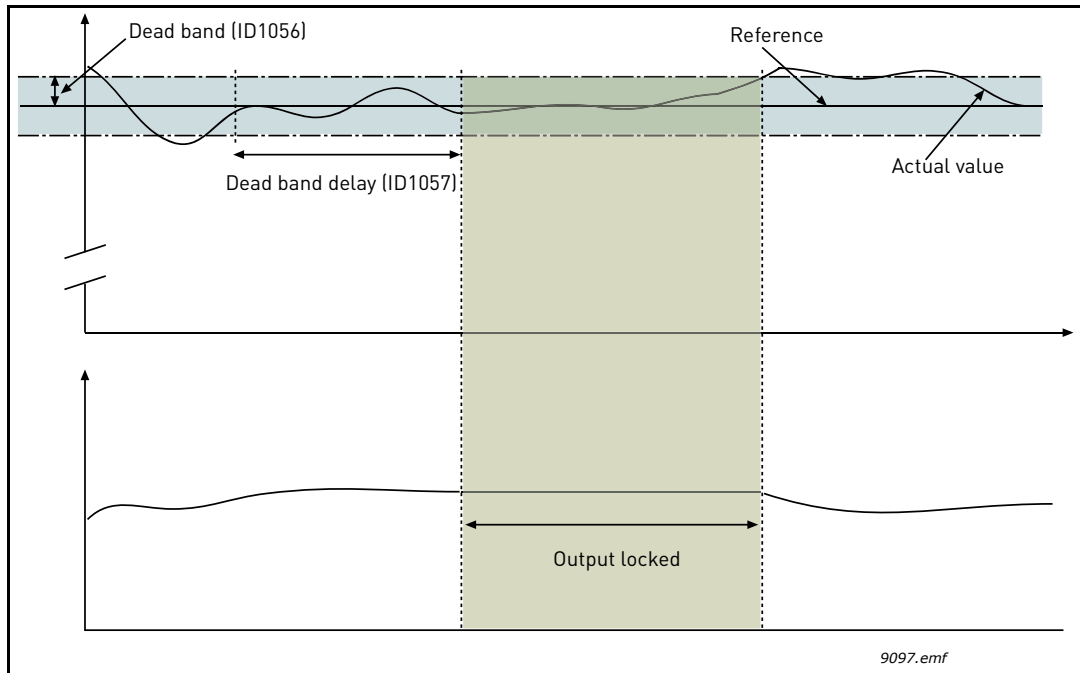

Figure 62. Dead band

7.2.17 FEEDFORWARD

P3.13.4.1 FEEDFORWARD FUNCTION

Feedforward usually needs accurate process models, but in some simple cases a gain + offset type of feedforward is enough. The feedforward part does not use any feedback measurements of the actual controlled process value (water level in the example on page 171). VACON[®] feedforward control uses other measurements which are indirectly affecting the controlled process value.

Example 1:

Controlling the water level of a tank by means of flow control. The desired water level has been defined as a setpoint and the actual level as feedback. The control signal acts on the incoming flow.

The outflow could be thought of as a disturbance that can be measured. Based on the measurements of the disturbance, we can try to compensate for this disturbance by simple feedforward control (gain and offset) which is added to the PID output.

This way the controller would react much faster to changes in the outflow than if you just had measured the level.

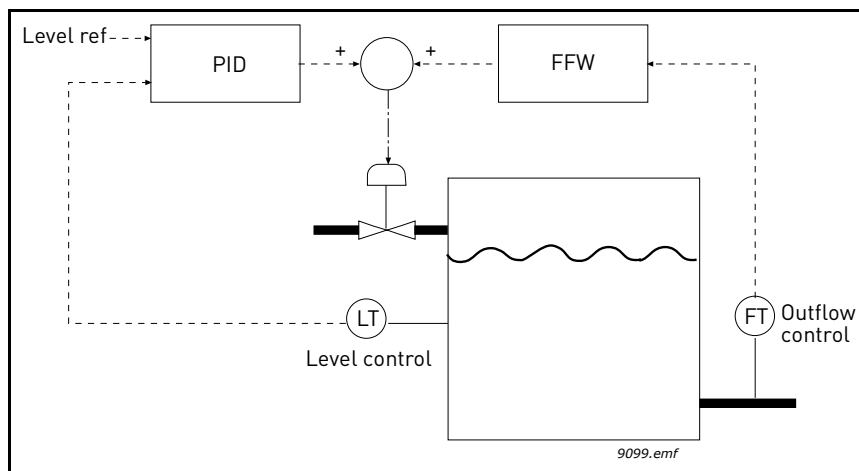

Figure 63. Feedforward control

7.2.18 SLEEP FUNCTION

P3.13.5.1 SLEEP FREQUENCY LIMIT 1

P3.13.5.2 SP 1 SLEEP DELAY

P3.13.5.3 SP 1 WAKEUPLEVEL

This function will put the drive into sleep mode if the frequency stays below the sleep limit for a longer time than that set with the Sleep Delay (P3.13.5.2). This means that the start command remains on, but the run request is turned off. When the actual value goes below, or above, the wake-up level depending on the set acting mode the drive will activate the run request again if the start command is still on.

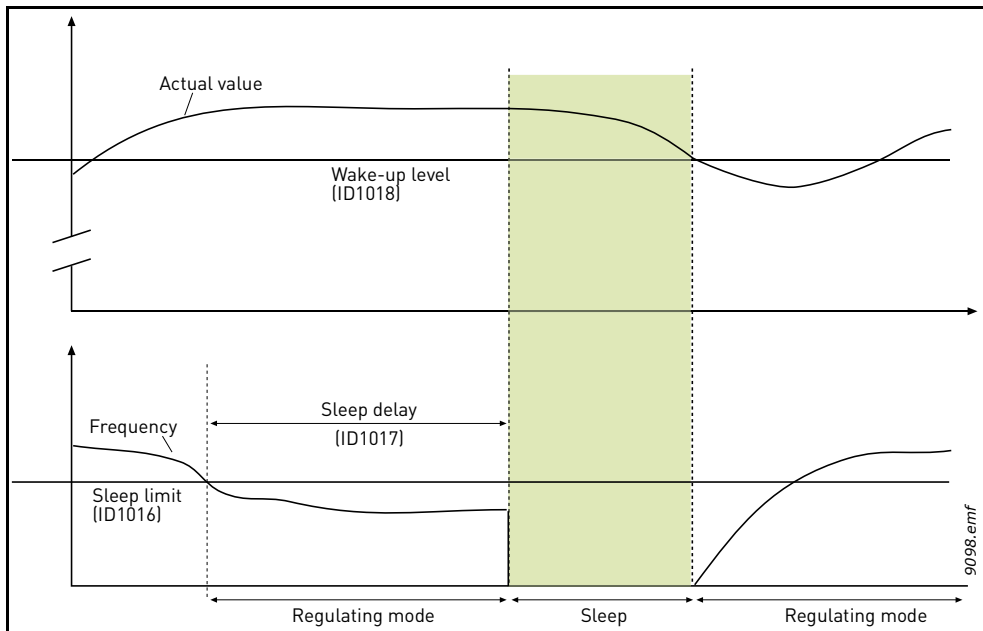

Figure 64. Sleep limit, Sleep delay, Wake-up level

7.2.19 FEEDBACK SUPERV.

P3.13.6.1 ENABLE SUPERV

These parameters define the range within which the PID Feedback signal value is supposed to stay in a normal situation. If the PID Feedback signal goes above or below the defined supervision range for longer time than what is defined as the *Delay*, a PID Supervision fault (F101) will be triggered.

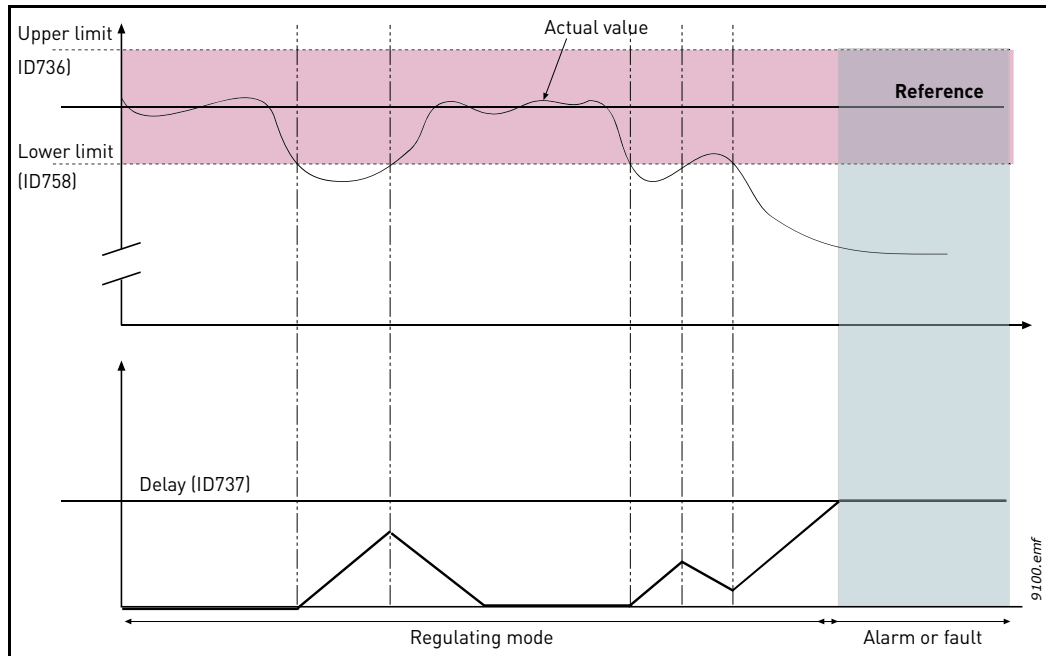

Figure 65. Process supervision

Upper and lower limits around the reference are set. When the actual value goes above or below these a counter starts counting up towards the Delay (P3.13.6.4). When the actual value is within the allowed area the same counter counts down instead. Whenever the counter is higher than the Delay an alarm or fault (depending on the selected response with parameter P3.13.6.5) is generated.

7.2.20 PRESS.LOSS.COMP

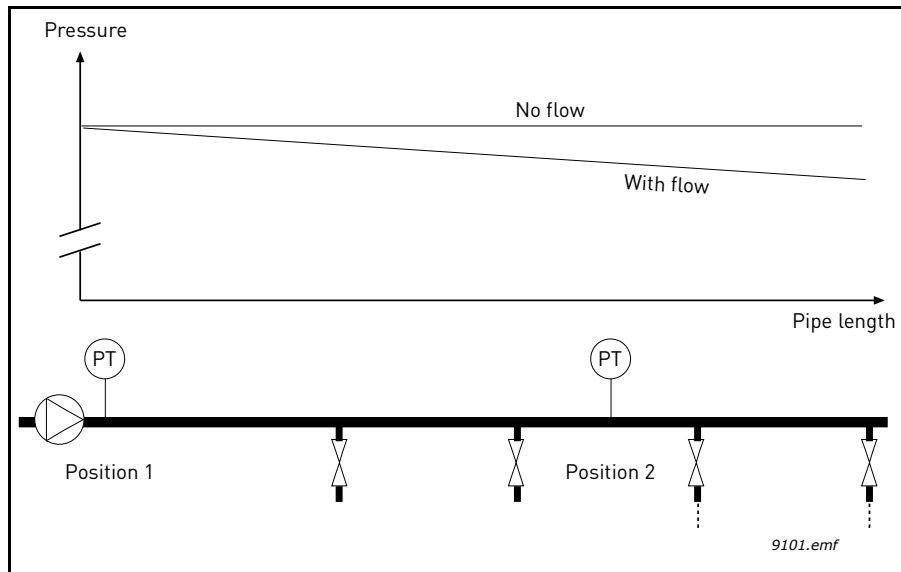

Figure 66. Position of pressure sensor

If pressurizing a long pipe with many outlets, the best place for the sensor would probably be half-way down the pipe (Position 2). However, sensors might, for example, be placed directly after the pump. This will give the right pressure directly after the pump, but farther down in the pipe the pressure will drop depending on the flow.

P3.13.7.1 ENABLE SP 1**P3.13.7.2 SETPOINT 1 MAX COMPENSATION**

The sensor is placed in Position 1. The pressure in the pipe will remain constant when we have no flow. However, with flow, the pressure will drop farther down in the pipe. This can be compensated by raising the setpoint as the flow increases. In this case, the flow is estimated by the output frequency and the setpoint is linearly increased with the flow as in the figure below.

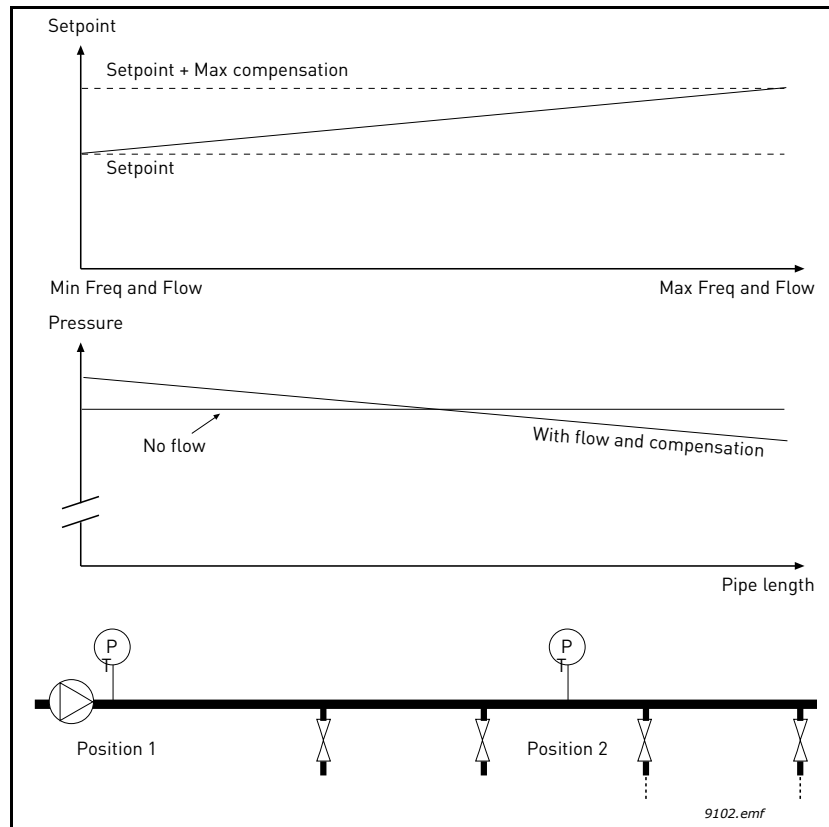

Figure 67. Enable setpoint 1 for pressure loss compensation

7.2.21 SOFT FILL

- P3.13.8.1** **ENABLE**
- P3.13.8.2** **SOFTFILL FREQ**
- P3.13.8.3** **SOFTFILL LEVEL**
- P3.13.8.4** **TIMEOUT TIME**

The drive runs at the soft fill frequency (par. P3.13.8.2) until the feedback value reaches the soft fill level set parameter P3.13.8.3. After this the drive starts to regulate, bump less, from the soft fill frequency. If the soft fill level is not reached within the timeout (P3.13.8.4) an alarm or fault is triggered (according to the set Soft Fill timeout response (P3.9.1.9)).

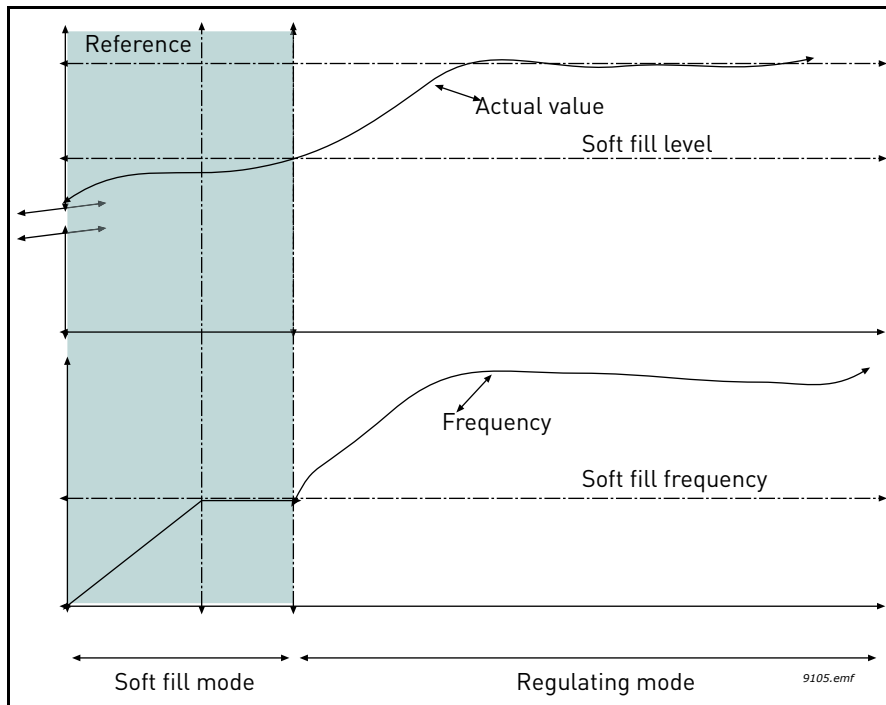

Figure 68. Soft fill function

7.2.22 AUTO-CLEANING

P3.21.1.1 CLEANING FUNCTION

If Auto-cleaning function is enabled by parameter P3.21.1.1 the Auto-cleaning sequence will start by activating the digital input signal selected by parameter P3.21.1.2.

P3.21.1.2 CLEANING ACTIVATION

See above.

P3.21.1.3 CLEANING CYCLES

The Forward/reverse cycle will be repeated for the amount of times defined by this parameter.

P3.21.1.4 CLEAN FORWARD FREQ.

Auto-cleaning function is based on rapidly accelerating and decelerating the pump. The user can define a forward/reverse cycle by setting parameters P3.21.1.4, P3.21.1.5, P3.21.1.6 and P3.21.1.7.

P3.21.1.5 CLEAN FORWARD TIME

See parameter P3.21.1.4 Clean Forward Freq. above.

P3.21.1.6 CLEAN REVERSE FREQ.

See parameter P3.21.1.4 Clean Forward Freq. above.

P3.21.1.7 CLEAN REVERSE TIME

See parameter P3.21.1.4 Clean Forward Freq. above.

P3.21.1.8 CLEANING ACCELERATION TIME

The user can also define separated acceleration and deceleration ramps for the Auto-cleaning function with parameters P3.21.1.8 and P3.21.1.9.

P3.21.1.9 CLEANING DECELERATION TIME

See parameter P3.21.1.8 Cleaning acceleration time above.

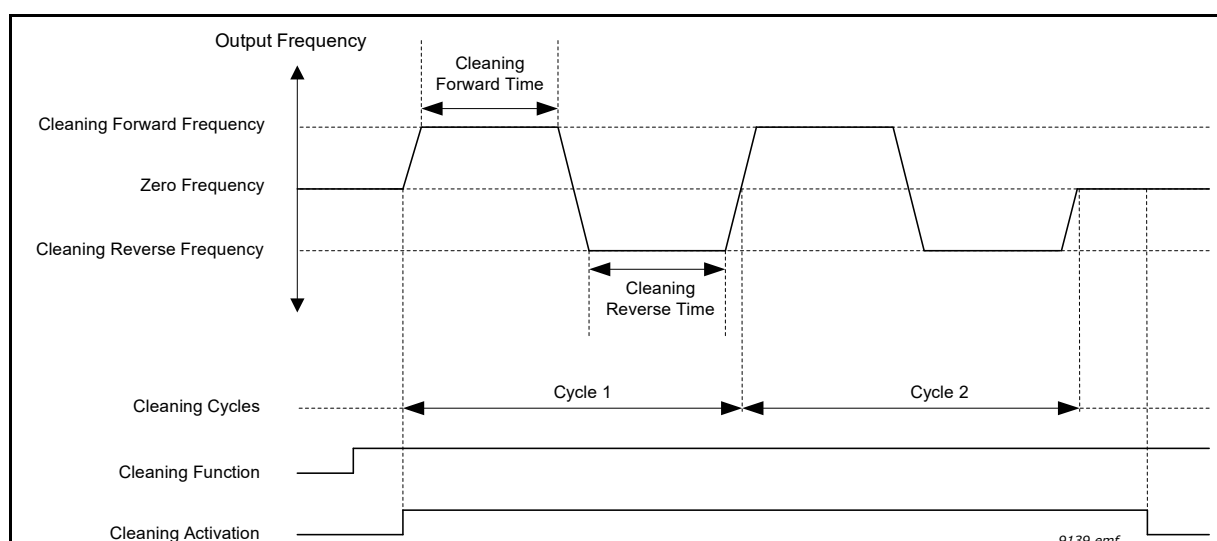

Figure 69. Auto-cleaning functionality

7.2.23 SOLAR

7.2.23.1 Start Settings

P3.22.1.1 **START DC VOLTAGE**

Start enable from solar condition needs that the DC voltage is above the threshold in P3.22.1.1 (at least for 5s).

P3.22.1.2 **SHORT RESTART DELAY**

The drive starts and tries to reach minimum frequency. If this doesn't happen within a defined time, the drive will stop and retry only after the short delay time P3.22.1.2 has elapsed.

P3.22.1.3 **SHORT RESTART DELAY TRIES**

P3.22.1.4 **LONG RESTART DELAY**

After a certain number of failed attempts (P3.22.1.3), the time between start attempts will change to long delay time P3.22.1.4.

If the drive can run continuously for the same long delay time, next start attempts will begin with short delay again. The same sequence is applied in case a running drive stops because of a temporary decrease in solar power.

Note! If the drive is supplied by mains, the drive is always enabled to start from external command.

7.2.23.2 MPPT

Generally, the MPP voltage of a panel is higher when the available power is high (good irradiation, low temperature).

The output power to the motor is considered an indicator of the panel state: if the drive can progressively increase motor speed and get a good amount of power, it means that the panel has basically "high" MPP voltage.

The DC voltage reference for the regulator is automatically changed by the MPP Tracker.

It results from four parallel algorithms:

- Feed-forward controller
- Correction controller
- Oscillation damping regulator
- Local Maxima logic

MPPT feed-forward parameters

MPP feed-forward controller continuously changes the reference from $V_{mp@10\%}$ to $V_{mp@100\%}$, according to actual motor power. The main purpose of this term is to follow variation of irradiation.

P3.22.2.1 VMP AT 100% POWER

P3.22.2.2 VMP AT 10% POWER

The V_{mp} parameters should be obtained from panel characteristics, considering standard temperature and irradiation at 10% and 100% level.

If the second value is not known, subtract 50-60 V from the first value as a rough estimation.

The accuracy of these values is not really critical, because the correction logic can easily compensate error of some tens of volts. It is better to set values possibly higher than the real ones, and let the correction decrease the voltage reference, to get maximum power.

P3.22.2.3 PANEL/MOTOR RATIO

In case the solar panels have less maximum power than the motor, a value lower than 100% should be set in P3.22.2.3.

MPPT regulator

The drive tries to get the maximum power from solar panels by keeping the DC voltage at the optimum point (Max Power Point).

There is a PI regulator that changes the internal frequency reference, so that the power sent to the motor keeps the panels working on MPP.

The voltage reference can be monitored (V2.3.1) and compared to actual DC voltage (V2.3.10), to check the effect of gain tuning.

Continuous, low amplitude and high frequency oscillations mean gains too high.

Ramp times are meant to smooth the output frequency, but without introducing significant delay in response.

P3.22.2.4 P GAIN

Proportional gain [Hz/V]. If set to 1.000, a variation of 1 V on DC bus voltage causes a variation of 1 Hz on frequency reference

P3.22.2.5 I GAIN

Integral gain [Hz/Vxs]. If set to 1.000, a variation of 1 V on DC bus voltage causes a variation of 1 Hz per second on frequency reference.

P3.22.2.6 ACCELERATION TIME

Time from minimum to maximum frequency. Used only when solar power is active.

P3.22.2.7 DECELERATION TIME

Time from maximum to minimum frequency. Used only when solar power is active.

MPPT correction parameters

This algorithm changes the DC voltage reference, to compensate temperature variations (usually slow) and to correct the error in feed-forward curve.

Correction can be up to +/- 150 V.

The correction term is determined by "perturb-and-observe" logic (P&O).

P3.22.2.8 P&O UPDATE TIME

P3.22.2.9 P&O VOLTAGE STEP

DC voltage reference is periodically (at intervals defined by P3.22.2.8) increased or decreased by a small value (P3.22.2.9). If the variation brings a higher motor power, next variation will follow the same direction, otherwise it will be reversed.

A short perturb period (P3.22.2.8) makes the regulation faster, assuming that the PI gains are not too low (power variation has to complete within the period).

The correction term can be monitored (V2.2), to help the tuning of reference feed-forward. When the panels temperature is close to standard, 25 °C, the correction term should result small (+/- 20 to 30 V).

The correction decreases towards negative maximum as temperature increases.

The correction term increases towards positive maximum in case of low temperature.

If something different is observed, feed-forward values should be improved.

P3.22.2.10 P&O POWER VARIATION

P3.22.2.10 determines the variation in motor power, above which iteration of voltage reference change continues in the same direction.

Small value leads to a regulation very close to the maximum of the panel curve, with possible instability. Higher values lead to a more stable point, but with lower efficiency.

P&O in local max points

A panel with partial irradiation, or somehow defective, could cause a discontinuity on the power/voltage curve of the array. In this situation the basic P&O logic (perturb and observe) could lead to a local maximum point, that is not corresponding to maximum available power.

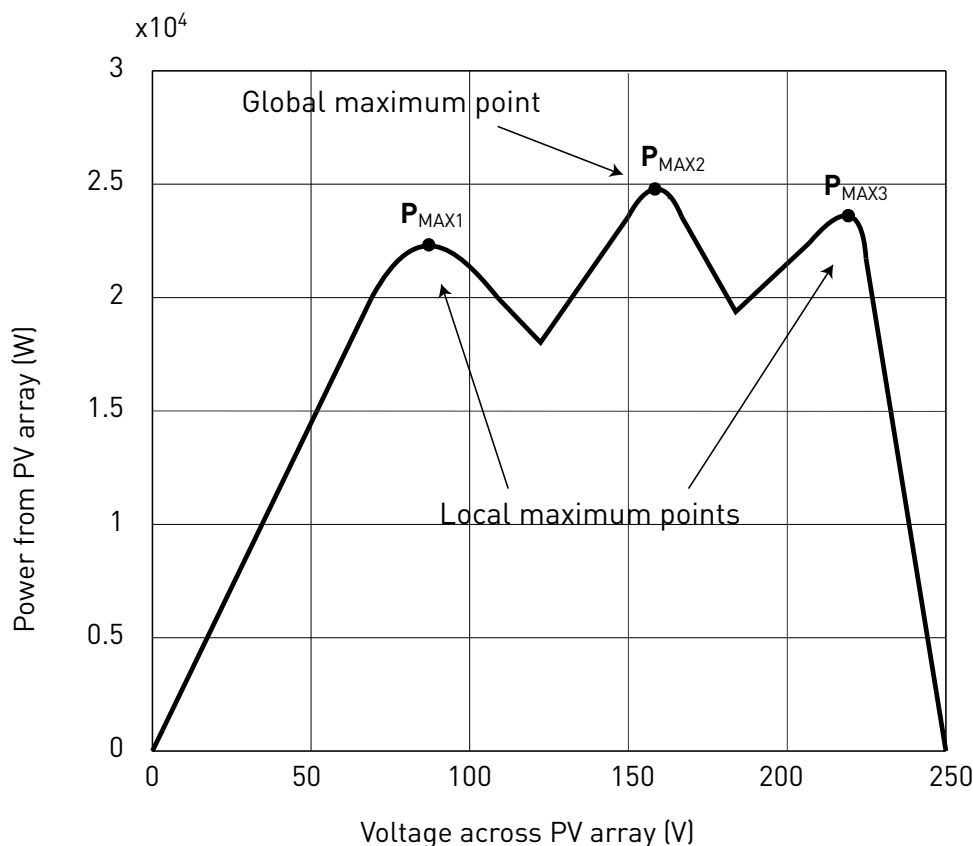

Figure 70.

P3.22.2.11 P&O LOCAL MAX VOLT STEP

To bypass discontinuity on power/voltage curve of array, after having reached a stable point, the P&O takes a bigger downward step (P3.22.2.11) in voltage. This step allows to overcome the local maximum and continue to search for the actual MPP.

If the point is the real MPP, the lower voltage reference will cause a drop in DC voltage and some oscillations, that are recognized and automatically damped by increasing the DC voltage reference.

The function can be disabled by programming P3.22.2.11= 0 V.

P3.22.2.12 P&O LOCAL MAX TIME

Further attempts to reach a higher MPP after an unsuccessful attempt will follow only after the programmable masking time (P3.22.2.12).

P3.22.2.13 P&O LOCAL MAX FREQ

The downward step is done only when output frequency is above minimum frequency + P3.22.2.13.

MPPT Oscillation Damping

If the power regulation enters the "current source" branch of the panel current/voltage characteristic, the typical result is a oscillation in DC voltage and output frequency. The damping logic rec-

ognizes oscillation in DC voltage and quickly increases the voltage reference correction term. This brings the panels back in “voltage source” branch.

P3.22.2.14 DAMPING SENSITIVITY

P3.22.2.14 parameter determines the amplitude of oscillation, to be recognized.

If the value is too low, normal variation in voltage level could be considered oscillation, and the DC voltage reference incorrectly increased.

P3.22.2.15 DAMPING TIME

Oscillation is recognized when the logic sees three maximum and minimum point during the time defined by P3.22.2.15.

If the time is too short, the logic could fail with slow oscillations.

If the time is too long, spaced and unrelated min and max points could be confused with an oscillation.

P3.22.2.16 MINIMUM DC VOLTAGE

The value depends on the voltage range.

Table 146.

Voltage range	Value	Default
230 VAC	230–300 V	230 V
400/500 VAC	300 (new xml)/410 (old xml)–600 V	410 V
525/690 VAC	530–800 V	530 V

The value (+ 5 V) is also used as the minimum limit for the DC voltage related parameters P3.22.1.1, P3.22.2.1, P3.22.2.2.

7.2.24 DUAL SUPPLY PARAMETERS

Common settings

P3.24.1.1 AC VOLTAGE

Nominal voltage of AC grid or generator.

V3.24.1.2 NOMINAL DC VOLTAGE

Monitor of calculated value of nominal DC voltage, when supply is from AC grid or generator.

P3.24.1.3 DUAL SUPPLY MODE

- 0 - Always active
- 1 - Closed loop Irradiation
- 2 - Closed loop Sensorless

P3.24.1.4 DC OFFSET FOR AC OFF

Offset added to M3.24.1.1, as DC voltage threshold above which AC can be switched Off. If DC value is above threshold, it means that the PV modules can sustain the full power, in present motor working condition.

P3.24.1.5 AC OFF AT STOP DELAY

Delay to switch AC Off at stop, if it happened with AC On condition.

Mode 0 Always active

In mode 0, relay for AC supply is always On when pump is running. There are two possible conditions, to switch the relay On.

P3.24.2.1 AC ON CONDITION

At Run: as AC switch relay is Off at power-on, the drive must start from PV modules supply, after that the relay is immediately switched On. AC grid or generator backup will avoid further stops, in case of low power from modules.

At Start: external Start signal is sufficient condition to switch the relay On and connect to AC grid or generator. This can happen also if the drive is powered up with only backup 24 V on control board.

Mode 1 Irradiation

In mode 1, relay for AC supply is managed accordingly to measurement of irradiation from analogue signal.

There is an absolute minimum threshold for switching On, and an offset added to this as threshold to switch Off.

AC relay is switched On also in case of Low Power alarm at start or Undervoltage fault.

With AC connected, MPPT will reach the maximum motor speed. Power is shared between AC grid or generator and PV modules, according to their actual capacity.

In this condition, DC voltage stays naturally close to rectified AC voltage (V3.24.1.1).

DC voltage will increase in case the modules can sustain the needed full power.

When switching Off condition is reached (high irradiation), motor speed is decreased until DC voltage increases above (V3.24.1.1 + P3.24.1.4). That is the working point aligned with present power available from PV module. Relay is switched Off afterwards.

It is possible to activate Identification of minimum irradiation threshold. It means that the value of parameter is internally adjusted, so that the AC switching On condition always happens when the motor is close to a programmable speed. This compensates the changeable ratio between irradiation and power, that is function of temperature.

P3.24.3.1 IRRADIATION SIGNAL

Selection between AI1 and AI2.

P3.24.3.2 MAX IRRADIATION

Value of irradiation at maximum signal.

P3.24.3.3 AC ON IRRADIATION

Threshold for irradiation, below which AC relay is switched On.

P3.24.3.4 AC OFF IRRADIATION OFFSET

Value added to P3.24.3.3 to determine the threshold for switching AC Off.

P3.24.3.5 IRRADIATION STABILIZATION TIME

Irradiation has to stay below/above thresholds for this time, to activate switching On/Off.

P3.24.3.6 IDENTIFICATION

P3.24.3.7 IDENTIFICATION FREQUENCY

When active, identification adjust the value of P3.24.3.3, to align the conditions of low irradiation and desired minimum power from the PV modules (defined as minimum frequency, set in P3.24.3.7).

If irradiation goes below P3.24.3.3, but present motor frequency is higher than P3.24.3.7, than the value in P3.24.3.3 is reduced. This will avoid switching to AC, when the power from PV modules is still enough.

On the other hand, if irradiation is still higher than P3.24.3.3, but MPPT regulation decreases the frequency below P2.24.3.7, present irradiation value is used to update P3.24.3.3. This will activate the AC switching On.

Mode 2 Sensorless

In mode 2, relay for AC supply is activated when the pump is running below a certain speed.

AC relay is switched On also in case of Low Power alarm at start or Under voltage fault. And in case DC voltage was already below the threshold (M3.24.1.1 + P3.24.1.4) when external Start command is given.

With AC connected, MPPT will reach the maximum motor speed. Power is shared between AC grid or generator and PV modules, according to their actual capacity.

In this condition, DC voltage stays naturally close to rectified AC voltage (V3.24.1.1).

DC voltage will increase in case the modules can sustain the needed full power.

If the threshold (V3.24.1.1 + P3.24.1.4) is reached, AC is switched Off.

Besides this, when AC switch is On, the drive periodically decreases the motor speed to a programmable level, to check if PV modules can sustain at least that reduced power. If DC voltage has increased above the threshold, AC is switched Off. Otherwise MPPT will go back to max speed. This DC voltage check can be disabled by digital input (RTC channel possibility).

P3.24.4.1 AC ON FREQUENCY

AC relay is switched On if motor frequency stays below threshold, for delay time.

P3.24.4.2 AC ON DELAY

AC relay is switched On if motor frequency stays below threshold, for delay time.

P3.24.4.3 DC CHECK REFERENCE

Frequency reference at which DC voltage is checked, for possible switching Off. Higher values mean to use PV modules alone only if they have a good power availability.

P3.24.4.4 DC CHECK PERIOD

Time for periodic DC voltage check, at reduced frequency. It can be disabled by means of digital input set in P3.5.1.60. This can be connected to RTC channels, for time of the day related actions.

P3.24.4.5 DC CHECK STABILIZATION TIME

DC voltage must stay above the threshold for this time (both at maximum and reduced speed), to activate AC switching Off.

8. FAULTS

8.1 FAULT TRACING

When an unusual operating condition is detected by the AC drive control diagnostics, the drive initiates a notification visible, for example, on the keypad. The keypad will show the code, the name and a short description of the fault or alarm.

The notifications vary in consequence and required action. *Faults* make the drive stop and require reset of the drive. *Alarms* inform of unusual operating conditions but the drive will continue running. *Info* may require resetting but do not affect the functioning of the drive.

For some faults you can program different responses in the application. See parameter group Protections.

The fault can be reset with the *Reset button* on the control keypad or via the I/O terminal. The faults are stored in the Fault history menu which can be browsed. The different fault codes you will find in the table below.

NOTE: When contacting distributor or factory because of a fault condition, always write down all texts and codes on the keypad display.

8.2 FAULT APPEARS

When a fault appears and the drive stops examine the cause of fault, perform the actions advised here and reset the fault as instructed below.

1. With a long (1 s) press on the *Reset* button on the keypad or
2. By entering the *Diagnostics* Menu (M4), entering *Reset faults* (M4.2) and selecting *Reset faults* parameter.
3. **For keypad with LCD display only:** By selecting value Yes for the parameter and clicking OK.

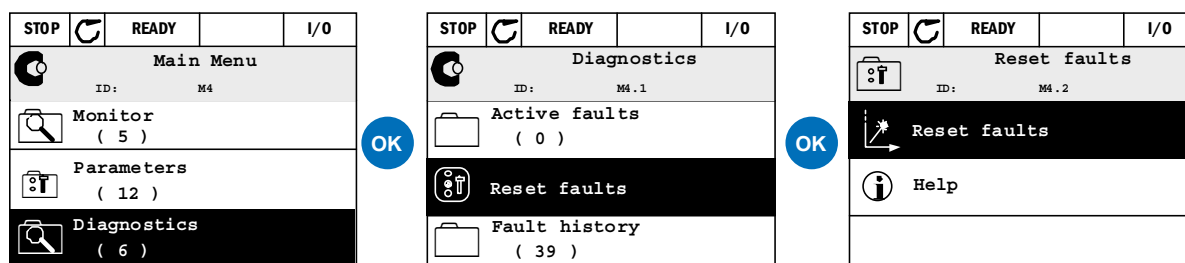

Figure 71. Diagnostic menu with graphical keypad.

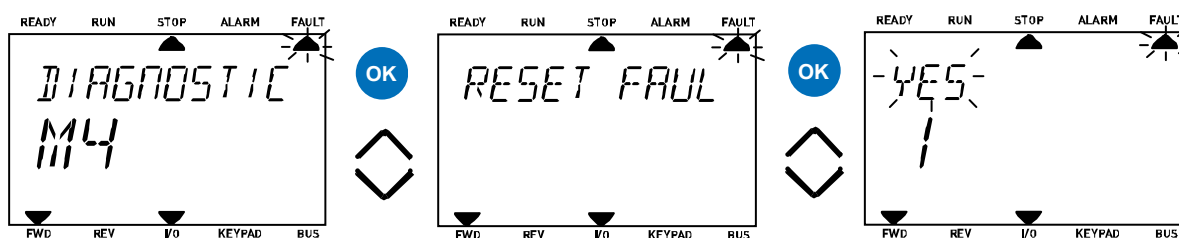

Figure 72. Diagnostic menu with text keypad.

8.3 FAULT HISTORY

In menu M4.3 Fault history you find the maximum number of 40 occurred faults. On each fault in the memory you will also find additional information, see below.

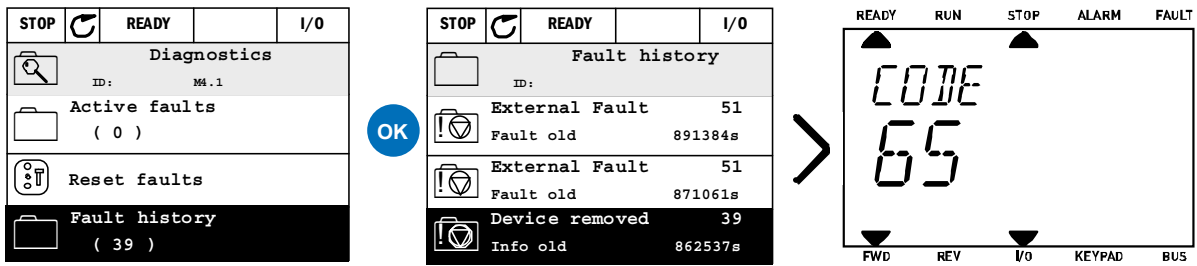

Figure 73. Fault history menu with graphical keypad.

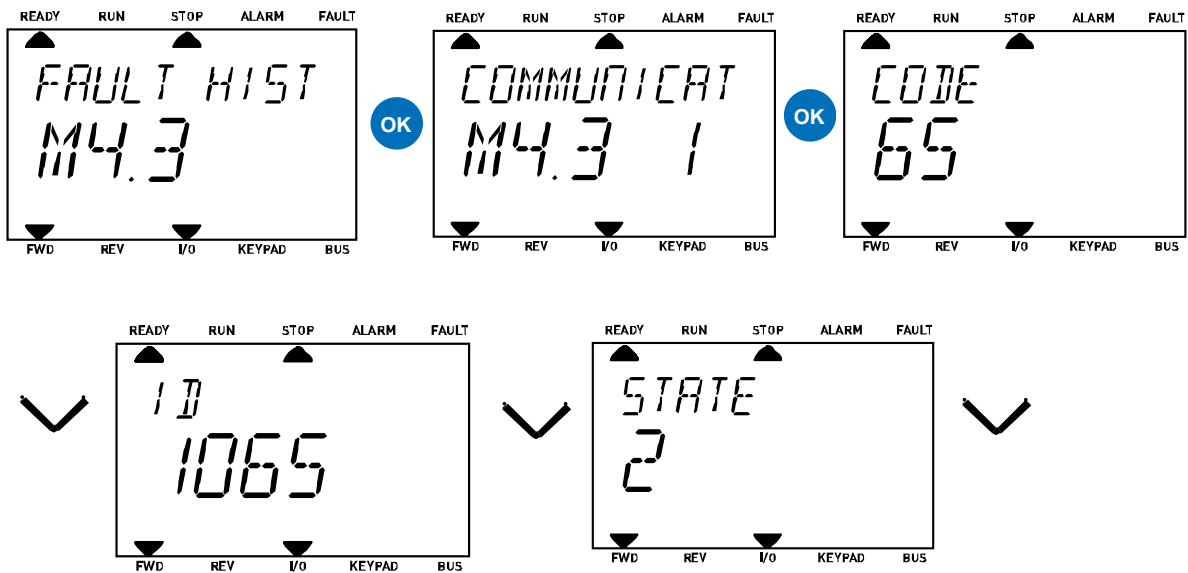

Figure 74. Fault history menu with text keypad.

8.4 FAULT CODES

Table 147. Fault codes and descriptions

Fault code	Fault ID	Fault name	Possible cause	Remedy
1	1	Overcurrent (hardware fault)	AC drive has detected too high a current ($>4 \cdot I_M$) in the motor cable: <ul style="list-style-type: none"> • sudden heavy load increase • short circuit in motor cables • unsuitable motor 	Check loading. Check motor. Check cables and connections. Make identification run. Check ramp times.
	2	Overcurrent (software fault)		
2	10	Overvoltage (hardware fault)	The DC-link voltage has exceeded the limits defined. <ul style="list-style-type: none"> • too short a deceleration time • brake chopper is disabled • high overvoltage spikes in supply • Start/Stop sequence too fast 	Make deceleration time longer. Use brake chopper or brake resistor (available as options). Activate overvoltage controller. Check input voltage.
	11	Overvoltage (software fault)		
3	20	Earth fault (hardware fault)	Current measurement has detected that the sum of motor phase current is not zero. <ul style="list-style-type: none"> • insulation failure in cables or motor 	Check motor cables and motor.
	21	Earth fault (software fault)		
5	40	Charging switch	The charging switch is open, when the START command has been given. <ul style="list-style-type: none"> • faulty operation • component failure 	Reset the fault and restart. Should the fault re-occur, contact the distributor near to you.
7	60	Saturation	Various causes: <ul style="list-style-type: none"> • defective component • brake resistor short-circuit or overload 	Cannot be reset from keypad. Switch off power. DO NOT RE-CONNECT POWER! Contact factory. If this fault appears simultaneously with F1, check motor cables and motor.

Table 147. Fault codes and descriptions

Fault code	Fault ID	Fault name	Possible cause	Remedy
8	600	System fault	Communication between control board and power unit has failed.	Reset the fault and restart. Should the fault re-occur, contact the distributor near to you.
	601		Communication between control board and power unit has interference, but it is still working.	
	602		Watchdog has reset the CPU	
	603		Voltage of auxiliary power in power unit is too low.	
	604		Phase fault: Voltage of an output phase does not follow the reference	
	605		CPLD has faulted but there is no detailed information about the fault	
	606		Control and power unit software are incompatible	Update software. Should the fault re-occur, contact the distributor near to you.
	607		Software version cannot be read. There is no software in power unit.	Update power unit software. Should the fault re-occur, contact the distributor near to you.
	608		CPU overload. Some part of the software (for example application) has caused an overload situation. The source of fault has been suspended	Reset the fault and restart. Should the fault re-occur, contact the distributor near to you.
	609		Memory access has failed. For example, retain variables could not be restored.	
	610		Necessary device properties cannot be read.	
	614		Configuration error.	
	647		Software error	Update software. Should the fault re-occur, contact the distributor near to you.
	648		Invalid function block used in application. System software and application are not compatible.	
649	Resource overload. Error when loading parameter initial values. Error when restoring parameters. Error when saving parameters.			
9	80	Undervoltage (fault)	DC-link voltage is under the voltage limits defined. <ul style="list-style-type: none"> • most probable cause: too low a supply voltage • AC drive internal fault • defect input fuse • external charge switch not closed NOTE! This fault is activated only if the drive is in Run state.	In case of temporary supply voltage break reset the fault and restart the AC drive. Check the supply voltage. If it is adequate, an internal failure has occurred. Contact the distributor near to you.
	81	Undervoltage (alarm)		
10	91	Input phase	Input line phase is missing.	Check supply voltage, fuses and cable.

Table 147. Fault codes and descriptions

Fault code	Fault ID	Fault name	Possible cause	Remedy
11	100	Output phase supervision	Current measurement has detected that there is no current in one motor phase.	Check motor cable and motor.
12	110	Brake chopper supervision (hardware fault)	No brake resistor installed. Brake resistor is broken.	Check brake resistor and cabling. If these are ok, the chopper is faulty. Contact the distributor near to you.
	111	Brake chopper saturation alarm	Brake chopper failure.	
13	120	AC drive under-temperature (fault)	Too low temperature measured in power unit's heatsink or board. Heat-sink temperature is under -10 °C.	Check the ambient temperature
14	130	AC drive over-temperature (fault, heatsink)	Too high temperature measured in power unit's heatsink or board. Heat-sink temperature is over 100 °C.	Check the correct amount and flow of cooling air. Check the heatsink for dust. Check the ambient temperature. Make sure that the switching frequency is not too high in relation to ambient temperature and motor load.
	131	AC drive over-temperature (alarm, heatsink)		
	132	AC drive over-temperature (fault, board)		
	133	AC drive over-temperature (alarm, board)		
15	140	Motor stalled	Motor is stalled.	Check motor and load.
16	150	Motor overtemperature	Motor is overloaded.	Decrease motor load. If no motor overload exists, check the temperature model parameters.
17	160	Motor underload	Motor is underloaded.	Check load.
19	180	Power overload (short-time supervision)	Drive power is too high.	Decrease load.
	181	Power overload (long-time supervision)		
25	240	Motor control fault	Start angle identification has failed.	Reset the fault and restart. Should the fault re-occur, contact the distributor near to you.
	241		Generic motor control fault.	
26	250	Start-up prevented	Start-up of the drive has been prevented. Run request is ON when a new software (firmware or application), parameter setting or any other file, which has affects the operation of the drive, has been loaded to drive.	Reset the fault and stop the AC drive. Load the software and start the AC drive.
30	530	STO fault	Emergency stop button has been connected or some other STO operation has been activated.	When the STO function is activated, the drive is in safe state.
32	312	Fan cooling	Fan life time is up.	Change fan and reset fan life time counter.

Table 147. Fault codes and descriptions

Fault code	Fault ID	Fault name	Possible cause	Remedy
33	320	Fire mode enabled	Fire mode of the drive is enabled. The drive's protections are not in use.	Check the parameter settings
37	360	Device changed (same type)	Option board changed for one previously inserted in the same slot. The board's parameter settings are saved.	Device is ready for use. Old parameter settings will be used.
38	370	Device changed (same type)	Option board added. The option board was previously inserted in the same slot. The board's parameter settings are saved.	Device is ready for use. Old parameter settings will be used.
39	380	Device removed	Option board removed from slot.	Device no longer available.
40	390	Device unknown	Unknown device connected (power unit/option board)	Device no longer available.
41	400	IGBT temperature	IGBT temperature (unit temperature + I ₂ T) is too high.	Check loading. Check motor size. Make identification run.
44	430	Device changed (different type)	Option board changed or Power unit changed. No parameter settings are saved.	Set the option board parameters again if option board was changed. Set converter parameters again if power unit was changed.
45	440	Device changed (different type)	Option board added. The option board was not previously present in the same slot. No parameter settings are saved.	Set the option board parameters again.
46	662	Real Time Clock	RTC battery voltage level is low and the battery should be changed.	Replace the battery.
47	663	Software updated	Software of the drive has been updated (either the whole software package or application).	No actions needed.
50	1050	AI low fault	At least one of the available analogue input signals has gone below 50% of the defined minimum signal range. Control cable is broken or loose. Signal source has failed.	Change the failed parts. Check the analog input circuit. Check that parameter <i>AI1 signal range</i> is set correctly.
51	1051	External Fault	Fault activated by digital input.	Check the digital input or the device connected to it. Check the parameter settings.
52	1052 1352	Keypad communication fault	The connection between the control keypad and frequency converter is broken	Check keypad connection and possible keypad cable
53	1053	Fieldbus communication fault	The data connection between the fieldbus master and fieldbus board is broken	Check installation and fieldbus master.
54	1654	Slot D fault	Defective option board or slot	Check board and slot.
	1754	Slot E fault		

Table 147. Fault codes and descriptions

Fault code	Fault ID	Fault name	Possible cause	Remedy
57	1057	Identification	Identification run has failed.	Check that motor is connected to the drive. Ensure that there is no load on the motor shaft. Ensure that the start command will not be removed before completion of identification run.
58	1058	Mechanical brake	Actual status of mechanical brake remains different from the control signal for longer than what is defined.	Check the status and connections of the mechanical brake.
60	1060	Low DC Power	<ul style="list-style-type: none"> The drive cannot start because DC voltage is below the threshold level in P3.22.1.1. The drive has stopped because the power from solar panels was insufficient to keep the minimum output frequency. This is due to DC voltage dropping below the threshold in P3.22.2.16. The drive has stopped because output frequency was below the threshold in P3.13.5.1 for the time in P3.13.5.2, and sleep function is activated in P3.22.1.5 	Check that the relevant parameters have the proper setting. Check that acceleration P3.22.2.6 and deceleration P3.22.2.7 times are not too slow. Recommended value is 1.0 s. Let the drive wait for better irradiation/temperature conditions of the solar panels.
61	1061	Restart Delay	The drive will start after the programmed delay.	
63	1063	Low water level	The minimum water level is not ok.	Check settings and water level status.
64	1064	Max water level	The maximum water level is not ok.	Check settings and water level status.
65	1065	PC communication fault	The data connection between the PC and frequency converter is broken	
66	1066	Thermistor fault	The thermistor input has detected an increase of motor temperature	Check motor cooling and load. Check thermistor connection (If thermistor input is not in use it has to be short circuited)
68	1301	Maintenance counter 1 alarm	Maintenance counter has reached the alarm limit.	Carry out the needed maintenance and reset counter.
	1302	Maintenance counter 2 alarm	Maintenance counter has reached the alarm limit.	Carry out the needed maintenance and reset counter.
	1303	Maintenance counter 3 alarm	Maintenance counter has reached the alarm limit.	Carry out the needed maintenance and reset counter.
	1304	Maintenance counter 4 alarm	Maintenance counter has reached the alarm limit.	Carry out the needed maintenance and reset counter.

Table 147. Fault codes and descriptions

Fault code	Fault ID	Fault name	Possible cause	Remedy
69	1310	Fieldbus mapping error	Non-existing ID number is used for mapping values to Fieldbus Process Data Out.	Check parameters in Fieldbus Data Mapping menu.
	1311		Not possible to convert one or more values for Fieldbus Process Data Out.	The value being mapped may be of undefined type. Check parameters in Fieldbus Data Mapping menu.
	1312		Overflow when mapping and converting values for Fieldbus Process Data Out (16-bit).	
71	1071	Unsupported	The drive is not VACON® 100 X.	
	1171	Unsupported	The drive has not solar property.	
76	1076	Start prevented	Start command is active and was blocked in order to prevent unintentional rotation of the motor during the first power-up.	Reset drive to restore the normal operation. The need of restart depends on the parameter settings.
77	1077	>5 connections	Maximum number of 5 simultaneous active fieldbus or PC tool connections supported by the application exceeded.	Remove excessive active connections.
100	1100	Soft fill time-out	The Soft fill function in the PID controller has timed out. The wanted process value was not achieved within time.	Reason might be a pipe burst.
101	1101	Process supervision fault (PID1)	PID controller: Feedback value outside of supervision limits (and the delay if set).	Check settings.
105	1105	Process supervision fault (PID2)	PID controller: Feedback value outside of supervision limits (and the delay if set).	Check settings.
109	1109	Input pressure supervision	Input pressure supervision signal has gone below the alarm limit.	Check the process.
	1409		Input pressure supervision signal has gone below the fault limit.	Check the parameters Check the input pressure sensor and connections.
111	1315	Temperature fault 1	At least one of the selected temperature input signals has reached the alarm limit.	Find the cause of temperature raise. Check the temperature sensor and connections. Check that the temperature input is hardwired if no sensor is connected. See option board manual for further information.
	1316		At least one of the selected temperature input signals has reached the fault limit.	
112	1317	Temperature fault 2	At least one of the selected temperature input signals has reached the fault limit.	See option board manual for further information.
	1318		At least one of the selected temperature input signals has reached the fault limit.	
117	1600	Pump Underload	Motor underload caused by dry pump.	Check pump operation.

VACON[®]

www.danfoss.com

Danfoss Drives Oy
Runsorintie 7
65380 Vaasa
Finland

Document ID:



DPD01602E

Rev. E