

User Guide

System Manager Type **AK-SM 800A** series

ADAP-KOOL® Refrigeration Control System
SW Ver. 4.1x



Contents

1. Product Introduction	3	5.9 Control tab	50
1.1 Product Introduction	3	5.10 Configuration → Network Nodes	53
1.2 Specifications	4	5.11 Suspend Polling function (Network Nodes)	56
2. Installation and start-up configuration	6	5.11 Configuration → History (Inc HACCP points)	58
2.1 Installation	6	5.12 Configuration → History	59
2.2 Connections	8	6. Master Control Functions	58
2.3 Southbound Network topology	8	6.1 Rail Heat	58
2.3.1 Lon RS485 topology	9	6.2 Schedules	61
2.3.2 MODBUS topology	10	6.3 Customized control	63
2.3.3 MODBUS / IP	11	6.4 Suction Pressure Optimization	64
2.4 First time startup	12	6.5 Configuration of suction optimization	65
2.5 IP Configuration and suggested security settings	13	6.6 Adaptive Liquid Management	66
3. Navigation and use (Local screen)	14	6.7 AKC ON (Evap shutdown when injection off)	67
3.1 Log in screen	14	6.8 Coordinated Adaptive Defrost	68
3.2 Home screen / Dashboard	15	7. Advanced features and configurations	71
3.3 Home Screen – Menu Bar	17	7.1 Managers Override	71
4. Navigation and use (SvB5 browser)	19	7.2 Light	72
4.1 StoreView Browser 5 (SvB5)	19	7.2.1 Lighting Configuration	72
4.2 AK-SM 800A Utilities	19	7.2.2 Addresses	74
4.3 Utilities – Software update	21	7.2.3 Alarms	74
4.4 Food Safety Logging (HACCP)	25	7.3 Dimming control via AK I/O	75
4.5 File menu	27	7.4 HVAC Configuration	77
4.6 Dashboard	27	7.5 Miscellaneous Configuration	80
4.7 Managing alarms	28	7.6 Energy	91
4.8 System view	29	7.7 Energy Measurement / Load shed	96
4.9 Device detail	29	7.8 Detail → Energy	98
4.10 Schedule view	30	7.9 Enterprise Load Shed (via Danfoss EDS Service)	99
4.11 History (Logs)	30	7.10 Demand Limiting	100
4.12 AK-SM 800A Host Network Configuration	32	7.11 Boolean Logic / Calculations	101
4.13 Secondary device configuration	32	8. Device support	103
4.14 Device Upload / Download	33	8.1 Danfoss AKC Support (Via AK-PI 200)	103
4.15 Device Management	34	8.2 Service Tool Support	107
(Configuration/System/Device Management)	34	8.3 CoreSense™ (MODBUS) Support	108
5. Configuration	35	8.4 Technical data	109
5.1 Configuration → Wizards	36	8.5 Generic capacity-A	109
5.2 Copy Wizard	40	8.6 Generic capacity-B	109
5.3 Configuration → Time	41	8.7 Specifications	110
5.4 Configuration → System	41	9. Ordering	110
5.5 Configuration → Comm	43	10. Document history	111
5.6 Configuration → Security	44	11. Glossary of terms	111
5.7 Configuration → Alarms	45		
5.8 Offline	49		

Chapter 1: Product Introduction

1.1 Product Introduction

Introducing the new Danfoss System Manager 800A series. The System Manager AK-SM 800A series is an evolution of the global System Manager 800 and represents a significant investment by Danfoss in the Food Retail market. The AK-SM 800A maintains familiarity and a deep application feature set but is enhanced via several significant updates.

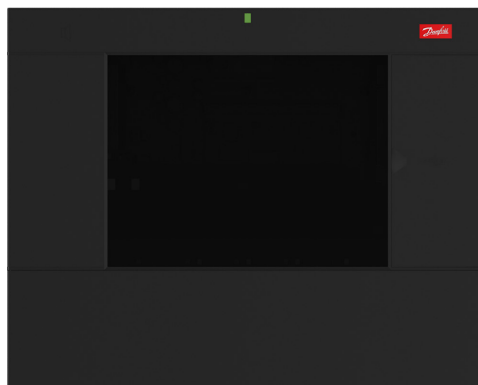

Product headline features

- All new Electronics platform supporting new Operating System (based on Linux)
- Implementation of IT industry standard security protocols (HTTPS, SSL/TLS 1.2, WPA2 encryption)
- Enhanced UI/UX - new yet familiar touch screen
- Full HTML5 web browser, known as StoreView Browser 5 (SvB5)
- New Utilities App (integrated in SvB5)
- Support of Mobile devices (Utilities App only)
- Retro-fit ready – includes EoL and legacy control functions supporting smooth upgrade path
- Extended history capacity
- Secure Wi-Fi Access point – for site connection without disrupting WAN network

Series Features (Model dependent)	Benefits
Built in standard IT security best practice and protocols	Secure web connection (HTTPS), Secure e-mail, Encrypted data and secure software update packages. Software Package 4.0 and above now includes new Security menu where session control attributes can be configured.
Full Web browser interface	Reduce tool complexity, utilization of modern web technology (HTML5), full view and access to your system
Mobile ready utilities	Key functions broken into discrete apps, making task more user friendly and mobile device supported (software updates, backup..)
Refrigeration Control (centralized and de-centralized)	Control your refrigeration application via built in Rack control or via de-centralized distributed network controls
Lighting Control (centralized and de-centralized)	Control your lighting application via built in control or via de-centralized distributed network controls
HVAC Control (centralized and de-centralized)	Control your HVAC application via built in control or via de-centralized distributed network controls
Energy saving technology (built in)	Energy saving functions built in - no additional licenses to enable savings
Master Schedules	Schedules Groups Central Defrost, Case lighting, Store / Outside Lighting, Night setback, Shutdown
Flexible Alarm Routing / output	Flexible Alarm Routing / Output e-mail, IP address, relay
Built in field bus options	Modbus, LonWorks®, SNMP IP, CANbus (future update)
Full color VGA Local touch screen	Full access to system
Built in Buzzer & 2-tone LED	Easy local level alarm notification
Custom graphics	Local screen custom graphics: Create simple & clear graphic screen with only 'key parameters' shown
Extended History logging	More memory for more history point collection and save
Alsense™ ready	Supported by Alsense™, offering multiple digital services and reporting

1.2 Specifications

The mounting location should be flat, dry and free of major vibrations. The AK-SM 800A should be mounted at eye level.

Environmental Range

Operating temperature:

-10 – 50 °C (14 – 122 °F)

@ 95% RH (non condensing) IP20

Electrical range:

For supply connections, use 16 AWG or larger wires rated for at least 75 °C (167 °F). Use copper conductors only.

~ 100 – 240 V AC 50/60 Hz 12 W

Built-in alarm relay

Contact voltage:

Up to 240 V, Load: AC-1 (Ohmic) Current rating.

5 Amp AC-15 (inductive) Current rating. 3 Amp

LCD Touch Screen

Active TFT touch (thin-film transistor), SVGA 800 x 600

LCD Touch Screen – cleaning

- Use a soft lint-free cloth.
- The cloth may be used dry, or lightly dampened with a mild soap cleaner or Ethanol.
- Cleaner with Ammonia can be used, but with percentage max of 4%.
- Be sure the cloth is only lightly dampened, not wet. Never apply cleaner directly to touch panel surface.
- Never use acidic or alkaline cleaners, or organic chemicals such as: paint thinner, acetone, toluene, xylene, propyl or isopropyl alcohol, or kerosene.

International Certifications

Este equipamento não tem direito à proteção contra interferência prejudicial e não pode causar interferência em sistemas devidamente autorizados. Para maiores informações, consulte o site da ANATEL - www.anatel.gov.br

Approvals

UL file: E31024

61B5

Class 2 or LPS in accordance with NEC.

Enclosure rating type 1

FCC ID: X02SPB209A

IC ID: 8713A-SPB209A

Size

Unit Width 295 mm (11.6"), Unit Height 235 mm (9.3"),

Unit Depth 65 mm (2.5")

Mounting holes 246 mm (9.7") Width

Mounting holes 175 mm (6.9") Height

Approvals:



Declaration of conformity info

- Regulation 2005/37/EC

- EN 12830, 07-1999

- EN 13485, 11-2001

- HACCP 080R1215

- CE 080R1213

- C-Tick 080R1214

- UL E31024



WARNING: To avoid risk of injury from electric shock, ensure correct electrical isolation is made before working within the enclosure.

Statements for the AK-SM 800A

FCC COMPLIANCE STATEMENT

CAUTION: Changes or modifications not expressly approved could void your authority to use this equipment
This device complies with Part 15 of the FCC Rules. Operation to the following two conditions: (1) This device may not cause harmful interference, and (2) this device must accept any interference received, including interference that may cause undesired operation

INDUSTRY CANADA STATEMENT

This device complies with Industry Canada license-exempt RSS standard(s). Operation is subject to the following two conditions: (1) this device may not cause interference, and (2) this device must accept any interference, including interference that may cause undesired operation of the device.

Le présent appareil est conforme aux CNR d'Industrie Canada applicables aux appareils radio exempts de licence. L'exploitation est autorisée aux deux conditions suivantes : (1) l'appareil ne doit pas produire de brouillage, et (2) l'utilisateur de l'appareil doit accepter tout brouillage radioélectrique subi, même si le brouillage est susceptible d'en compromettre le fonctionnement.

NOTICE

FCC COMPLIANT NOTICE

This equipment has been tested and found to comply with the limits for a Class B digital device, pursuant to part 15 of the FCC Rules. These limits are designed to provide reasonable protection against harmful interference in a residential installation. This equipment generates, uses and can radiate radio frequency energy and, if not installed and used in accordance with the instructions, may cause harmful interference to radio communications. However, there is no guarantee that interference will not occur in a particular installation. If this equipment does cause harmful interference to radio or television reception, which can be determined by turning the equipment off and on, the user is encouraged to try to correct the interference by one or more of the following measures:

- Reorient or relocate the receiving antenna.
- Increase the separation between the equipment and receiver.
- Connect the equipment into an outlet on a circuit different from that to which the receiver is connected.
- Consult the dealer or an experienced radio/TV technician for help.

Modifications: Any modifications made to this device that are not approved by Danfoss may void the authority granted to the user by the FCC to operate this equipment.

Any regulatory related concerns contact: global_approvals@danfoss.com

Danfoss Cooling
11655 Crossroads Circle
Baltimore, Maryland 21220
United States of America
global_approvals@danfoss.com
www.danfoss.com

EU CONFORMITY NOTICE

Hereby, Danfoss A/S declares that the radio equipment type AK-SM 800A is in compliance with Directive 2014/53/EU.
The full text of the EU declaration of conformity is available at the following internet address: www.danfoss.com

Danfoss A/S
Nordborgvej 81
6430 Nordborg
Denmark
global_approvals@danfoss.com
www.danfoss.com

Chapter 2: Installation and start-up configuration

2.1 Installation

Tools needed

1. Bubble level
2. Small slotted screwdriver for connector screws
3. Torx 8 screwdriver for releasing the electronic unit and for fastening the unit when recessed mounted
4. Screwdriver for fixing the AK-SM 800A
5. Pen for marking the 2 lower fixing holes
6. Larger slotted screwdriver for releasing the Technician lid

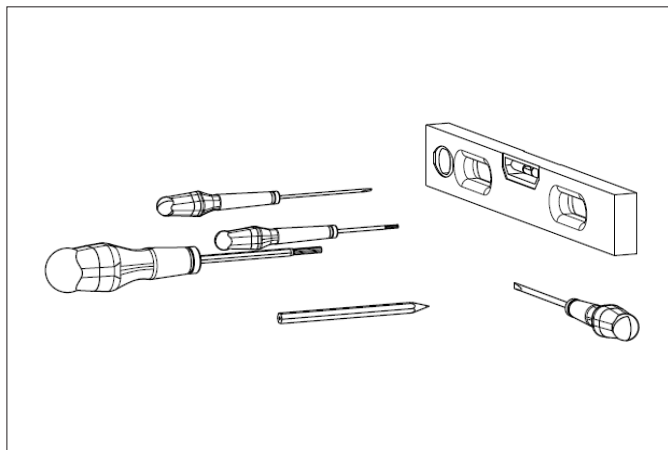

Wall Mounting- box¹⁾

1. Attach screw to the wall
2. Mount AK-SM 800A to the screw
3. Loosen Technician lid (three sides)
4. Remove Technician lid
5. Level the AK-SM 800A
6. If drilling is necessary, mark up 2 screws in Connector part.
7. Attach the Connector part to the wall using another 2 screws

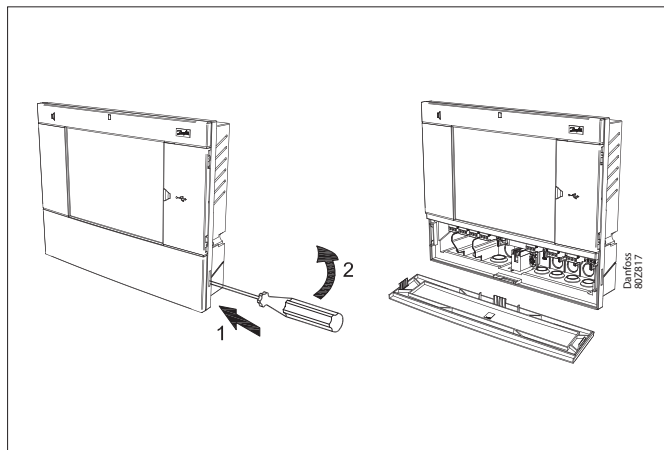

Wall Mounting- wiring

Insert cables through the rubber grommets

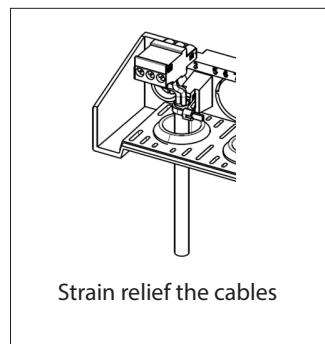
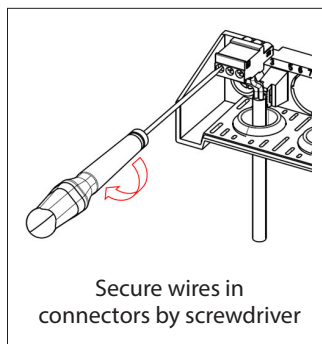
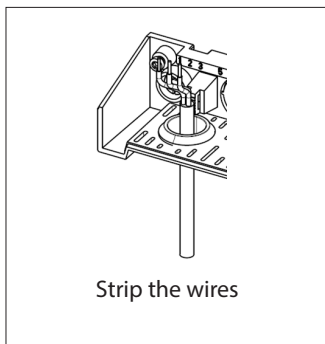
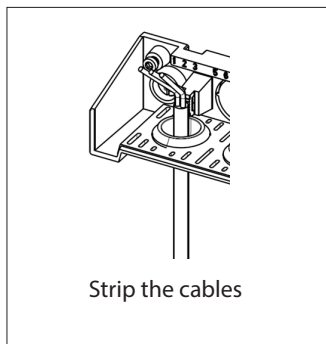
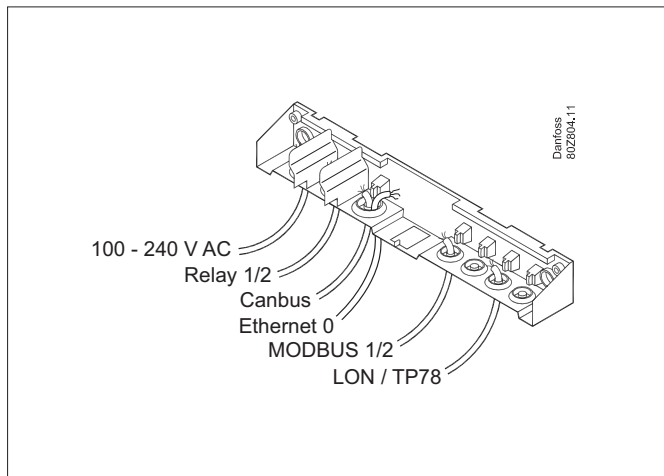
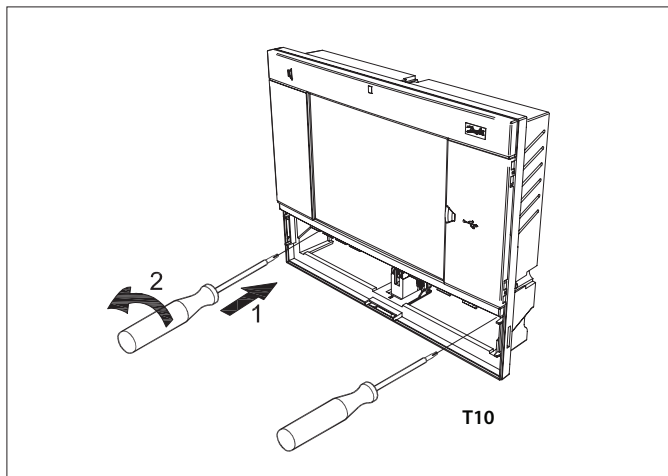

¹⁾ For installation in countries where UL Listing is required, please refer to the installation instruction provided with the product.

Carefully replace the cover, ensure that it securely snaps into place

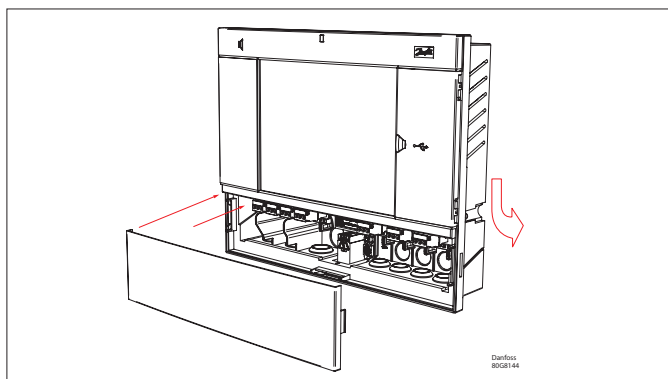

Wall Mounting- Panel recessed

From the front:
A hole of the size 280 x 220mm is machined.
The AK-SM 800A is inserted in the hole.

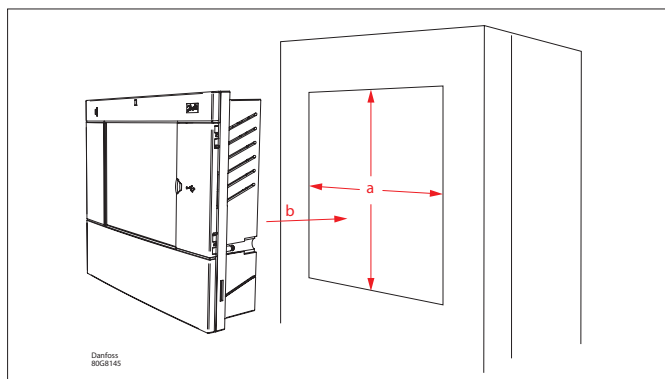

From the backside:
Slide the 3 fastener into the housing part.
The screws are inserted into the fasteners.
Secure the unit by tightening the screws

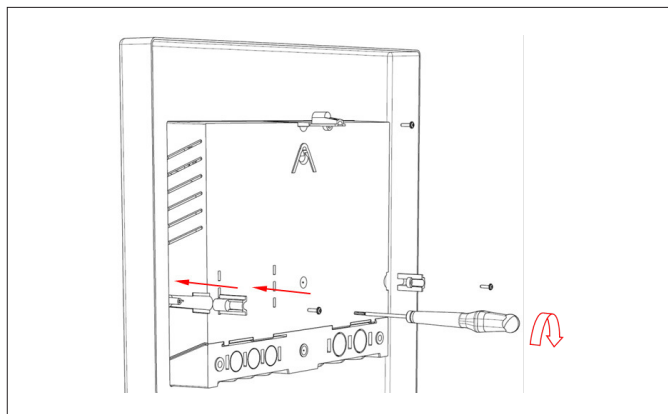

Remove Technician lid
From the back, push cables inside the housing

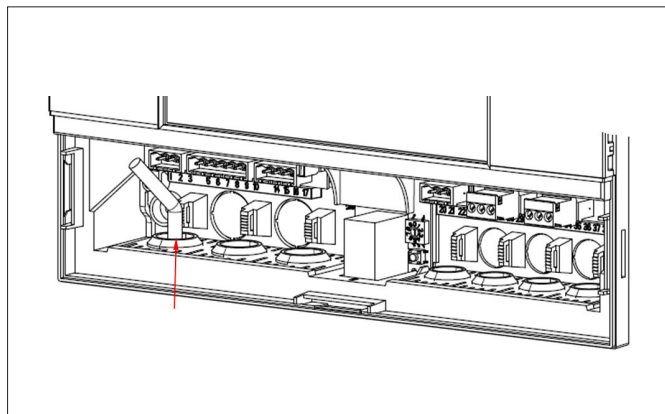

2.2 Connections

The following chapter describes the available connections on your AK-SM 800A.

i Please note that not all connection points are currently active, refer to the drawing below for more details

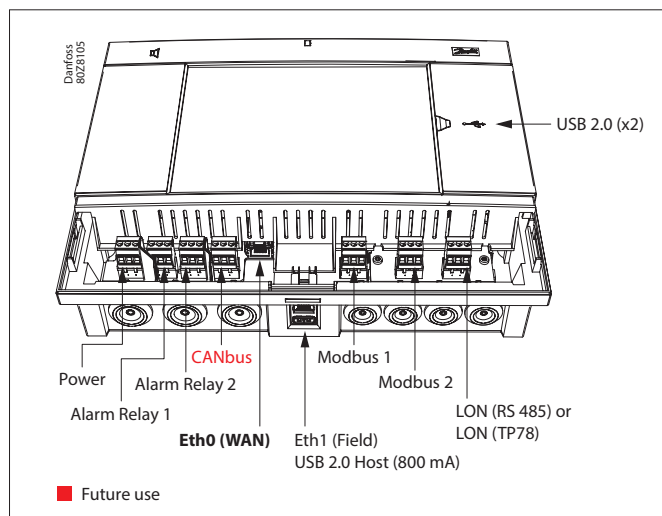

2.3 Southbound Network topology

Your AK-SM supports multiple southbound device topology formats. The term 'southbound' refers to controllers that reside on network(s) downstream of the System Manager. The System manager supports serial and digital formats (Modbus, Lon, Modbus/IP, AK-IP).

For further detailed description of network connections please refer to document 'Data Communication between ADAP-KOOL® Refrigeration controllers_RC8AC802'.

Follow the standard topology guidelines for Lon RS485, particularly with respect to:

- Maximum cable length
- When to use a repeater
- Suitable resistors

Cable type

Twisted pair cables must be used (with or without screen). Some types of communication require a cable with a screen to be used.

Examples:

For Lon RS485, MODBUS, RS485 Third party - General 'EIA 485' recommendation:

- Belden 9841, 24 AWG, 1 pair with screen
- Belden 3107A, 22 AWG, 2 pairs with screen
- Smartwire 043006AL, 22 AWG, 1 pair with screen
- Alpha wire 6453, 22 AWG, 1 pair with screen
- Carol C4841A, 24 AWG, 1 pair with screen
- Dätwyler Uninet 3002 4P 4 pairs with screen (CAT5 cable)

For Lon TP78 communication - Level 4 cable general recommendation:

- Belden 7703NH, 22 AWG, 1 pair with screen
- Belden 7704NH, 22 AWG, 2 pair with screen
- Smartwire 106500, 22 AWG, 1 pair with screen

Wires with larger cross-section than AWG 22 is not recommended

Cable length

A cable length must not exceed 1200 m (4000 foot). A repeater (Part # 084B2241) must be used for longer lengths.

i When using the Lon RS485 network, ensure the Term. Switch on the AK-SM is in the 'ON' position (enable internal resistor). Any repeaters must also have 120 Ohm resistor in place. Additionally, ensure that the last controller on the network run also has its end of line resistor enabled.

2.3.1 Lon RS485 topology

The cable connection must be wired from controller to controller, and no branches are allowed on the cable. If the cable length exceeds 1200 m a repeater must be inserted. If the data communication cable runs through an electrically noisy environment which impairs the data signal, one or more repeaters must be added to stabilise the signal.

i When configuring Lon devices on the field bus, the highest device address that can be used is 127.

Remember to use 120 Ohm terminators on the last field bus controller device. Note also to enable (ON) the Termination Switch, located above each network connection point on the AK-SM 800A, this will enable the built in terminator(s) for each network point on the AK-SM 800A.

Conductors

The wire pairs are looped from device to device. There are no polarisation requirements. (On some controllers, the clamps are designated A and B, while on others there is no designation. The connectors are otherwise identical. If a screen wire is used, it must be connected to the system device and any repeaters. A screen must always be looped from device to device.

The screen must not be connected to anything else. (The screen is earthed inside the screen and must not be earthed in any other way.)

Mid network connection

This example shows the AK-SM 800A series RS485 version used in the middle of a network run. In this example ensure that both ends of the controller run are fitted with 120 Ohm terminators. Over the past several years Danfoss has offered versions of the AK-SC 255 and AK-SC 355 which has a LonWorks® option of TP78. As a physical layer of the LonWorks® protocol these older systems offered x5 network connection points. Due to the global phase out of the TP78 option by the OEM, Danfoss has made available a special order version of the AK-SM 880A (080Z4029), which comes pre-installed with a LonWorks® TP78 options card. This 'special' version of the AK-SM 880A is designed to support customers who wish to migrate from existing AK-SC 255 and AK-SC 355 and AK-SM 800 TP78 systems.

Note: this version of the AK-SM 880A is not intended or available in Europe and offers x4 TP 78 connection points.

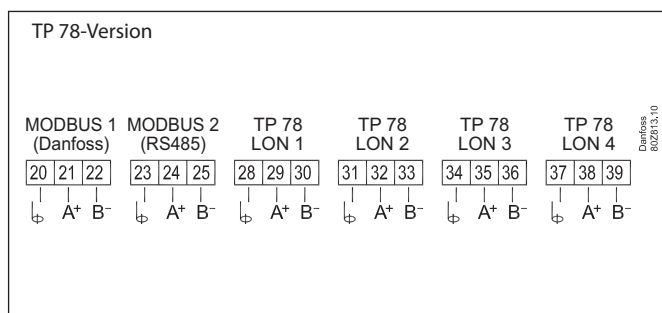
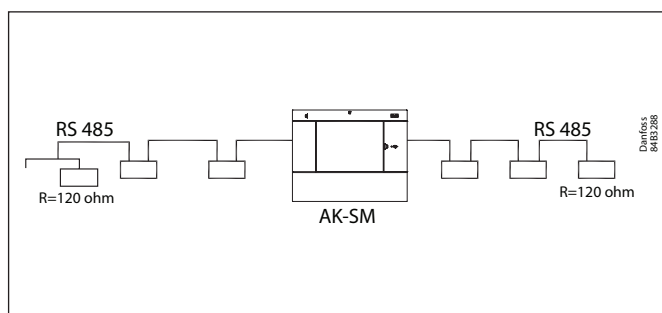
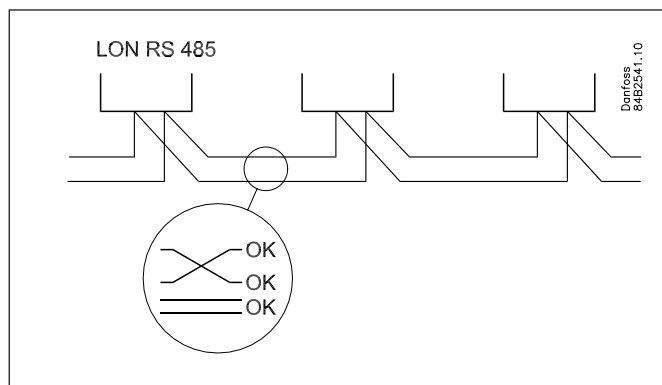
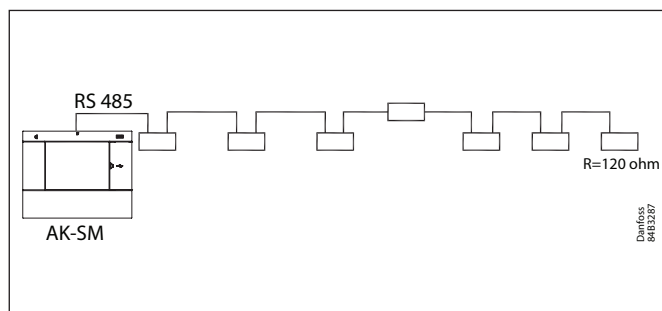
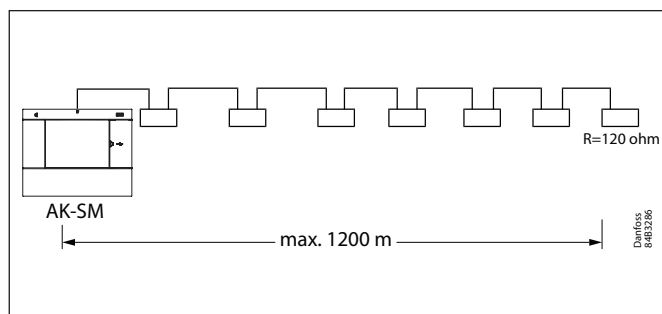

2.3.2 MODBUS topology

When running software package version V3.2.x and above, the AK-SM 800A offers two Modbus channels, including 3rd party support for (Modbus) Refrigeration and utility meter device. Both channels can be enabled at the same time but must have unique node addressing for every node regardless of the channel/s in use.

Note: See system capacity tables at end of this document for details on node capacity etc.

MOD#1 supports Danfoss and pre-coded devices, as such this channel does not require any custom configuration.

MOD#2 supports Danfoss and 3rd party devices and offers a degree of configuration to accommodate non Danfoss controls.

MOD1&2 offers the ability to configure scan address range, thus making scanning more efficient (only scan for known address ranges).

For additional details on Modbus configuration see section '5.9 Configuration → Network Nodes'.

Master control (Po Optimization) is supported in distributed use case where Pack is on Lon and associated cases are on MOD#1 and MOD#2.

The cable must be with screen. The cable is connected from controller to controller, and no branches are allowed on the cable. If the cable length exceeds 1200 m a repeater must be inserted. If the data communication cable runs through an electrically noisy environment which impairs the data signal, one or more repeaters must be added to stabilise the signal.

The System Manager can be inserted in middle of network, ensure System Manager termination is OFF. Refer to Danfoss document 'RC8AC802 Data Communication'.

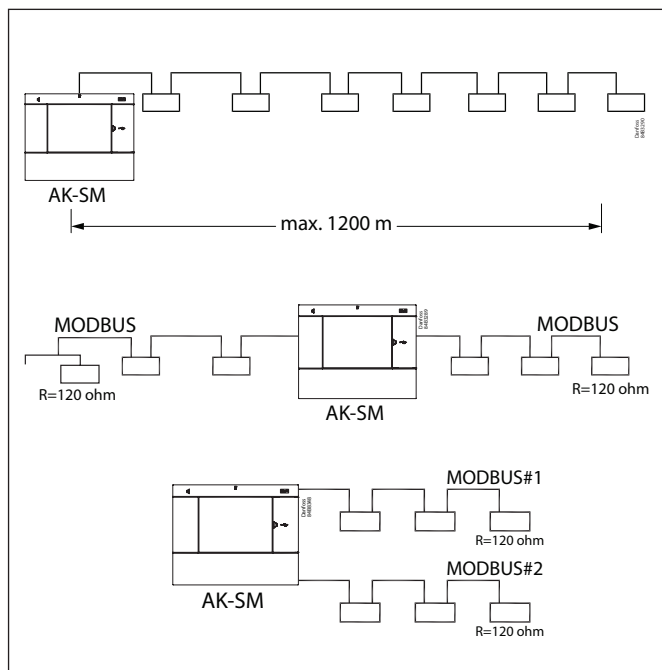

i When configuring MODBUS devices on the field bus, the highest device address that can be used is 199.

The wires are looped from device to device.

A is connected to A.

B is connected to B.

The screen must be connected to the system device, all controller and any repeaters.

A screen must always be looped from device to device.

The screen must not be connected to anything else.

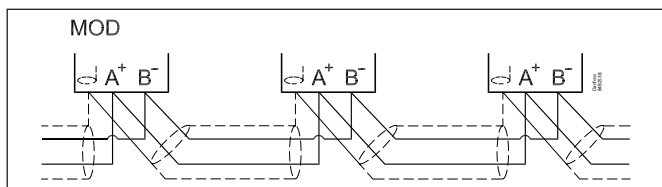

Be sure to configure the MODBUS repeater AKA 222 (code#084B2240) to the correct baud rate.

See notes section at the back of this guide for MODBUS device baud rate properties.

Refer to Danfoss Instructions RI8KN402 for further details on the AKA 222 repeater'.

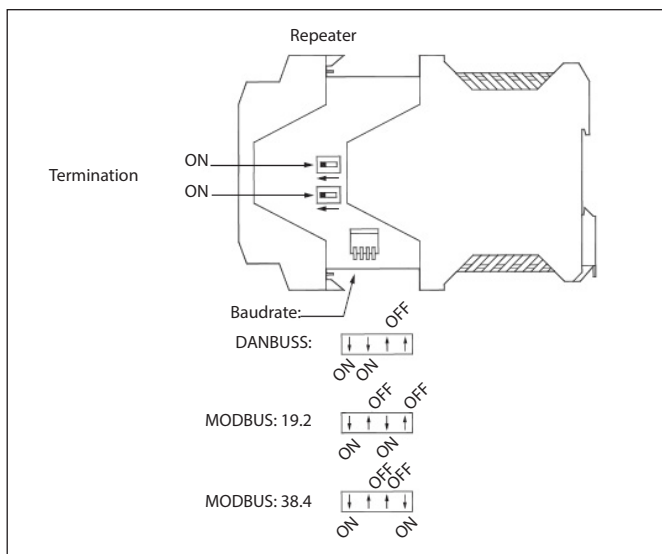

2.3.3 MODBUS / IP

New in software package 4.x and above, the AK-SM 800A supports Danfoss AK-CC case controllers.

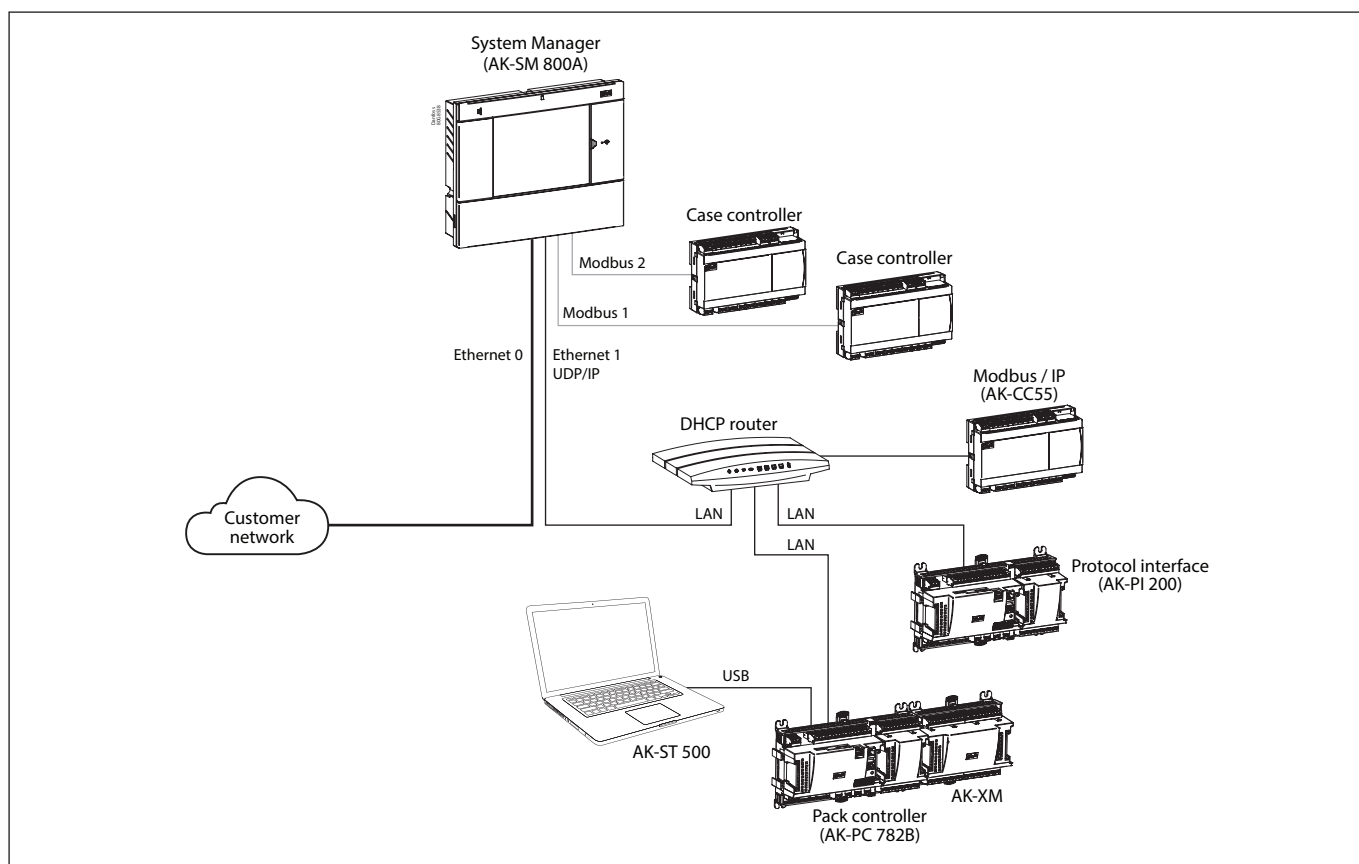

2.4 First time startup

To establish basic settings, an initial wizard is presented upon first powering up your AK-SM 800A. This wizard appears only once upon first time power up from new (out of the box) or if the system database has been cleared (an option in the system configuration).

The following screens are presented;

1/8 Language (set required primary unit language)

2/8 Setup Administrator (create highest level user who later can then create additional users.



Caution: Remember user/password as Danfoss does not have access to user profiles or passwords. Danfoss is not responsible for the management of user passwords. If the user/password is forgotten the 'forgot password' workflow will need to be applied).

3/8 Setup Date/Time/Format

4/8 Setup system units

5/8 Notification of connectors (take note of connector locations and what connectors are available)

6/8 Setup Network

7/8 Security (session control)

8/8 Important software update notification

(To ensure optimum operation, security and the latest features ensure your AK-SM 800A is updated with the latest software.

Follow on screen prompts or visit ak-sm800a.danfoss.com for the latest software packages. Also refer to chapter 4.3 for more information on how to update your AK-SM 800A.)

After completion of the settings wizard the AK-SM 800A Series will request a reset, where settings will be saved. Commissioning activities can now continue using Web wizards and control screens.

Local screen login

For security purposes, no system information or status is available on the AK-SM 800A until a valid username and password has been entered. To assist in the confirmation of inputting of credentials, use the 'show' check box – this will show each character as you input.

Forgot Credentials

This button can be used if you have forgotten your user name or password. Danfoss cannot access or recover any user name or password in the system, as these are stored in an encrypted format. If your log in credentials are forgotten you will need to enter new credentials, previous user credentials are not recoverable. Please note that it is expected that one administrator can always gain access to the system and thereby delete the original user profile of the user who has forgotten their credentials and create a new one, where the user would input a new password.

If the administrator is not available or cannot perform this action, the reset password workflow will need to be initiated. Follow the on-screen prompts and press the 'Reset password' button, see section 3.1 for more details.

Note: For security purposes, resetting of the password requires specific unit information that is ONLY possible when in front of the local AK-SM 800A screen.

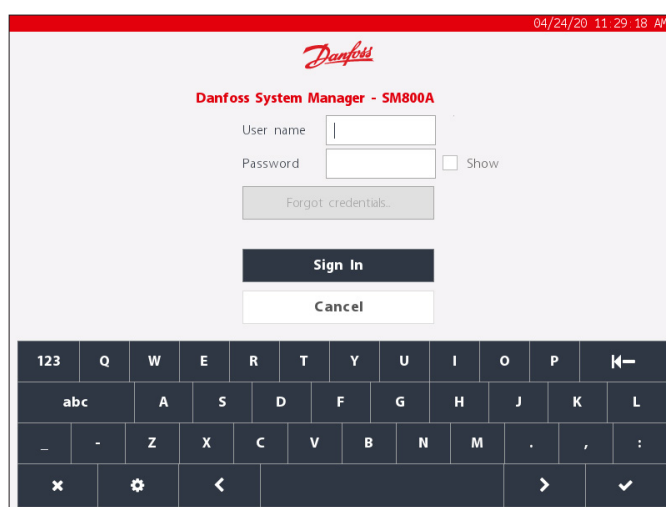
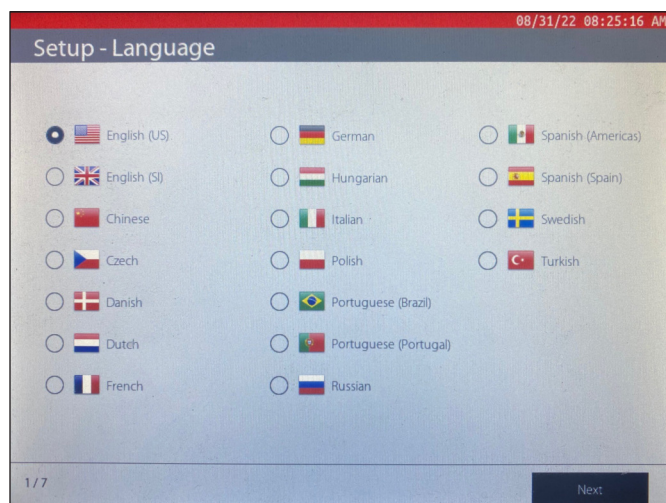

2.5 IP Configuration and suggested security settings

Danfoss takes security and the integrity of its applications seriously and is continuously investing in bringing to market products and services that have best-in-class security features and technologies. Danfoss products are Engineered to last many years and, as technologies and security risks evolve, it is important to ensure basic best practices are in place so that no matter how old your product is, you can have a level of core security that will continue to support your business needs.

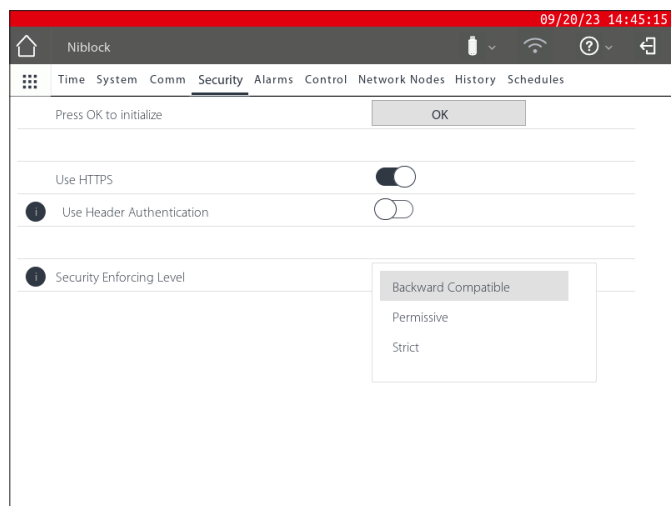

Important:

The current generation of Danfoss refrigeration controller front-ends are embedded devices designed to be installed behind secure networks and firewalls. Due to the longevity of several Danfoss products installed in the field it is important that key security steps are taken to ensure protected operations. Please consider the important recommendations below to ensure your application has a suitable level of network security and integrity.

- Ensure your AK-SM 800A system(s) are NOT connected to an open or public network
- Use 'strong password' for user accounts
- Configure Session Control to 'Strict' (see section 5.x)
- Enable HTTPS for remote communications
- Do not share or publish any username and passwords
- Keep your System Managers updated with the latest software packages from Danfoss (ADAP-KOOL™ [Downloads](#))

Consult available industry standards (i.e. ISO/IEC 27002:2013) for further reference and guidance on organizational information security standards and information security management practices.

Communication and Security settings on your AK-SM 800A can be found in *section 5.x*

General IT security / Recommendations

The AK-SM 800A series device is an embedded controller designed to be installed behind an appropriate router and firewall. Whilst the AK-SM 800A offers many IT industry security technologies (HTTPS, encrypted Wi-Fi, encrypted passwords...). Danfoss strongly recommends the deployment using IT security best practices and protocols.

The AK-SM 800A controller supports auto negotiated 10/100 Ethernet speeds.

The AK-SM 800A controller supports auto negotiated full / half duplex Ethernet communications.

AK-SM 800A port table

Port	Description	Use	User Configurable
5136	UDP	SNMP	No
1041	UDP	PI-200	No
443	TCP	HTTPS Secure Web browser communications	Yes
80	TCP	HTTP Web browser communications	Yes
5003, 5005	UDP	Host network communication UDP ports	No

Security session control

System software package v4.0.x and above now includes additional Northbound (remote UI and XML) security functionality to further harden against malicious attacks and network vulnerabilities. Danfoss recommends enabling strict security settings in the System Manager, with coordination and alignment within applicable IT security departments.

Refer to the *section 5.x Configuration → Security - Session Control* for more details.

Chapter 3: Navigation and use (Local screen)

3.1 Log in screen

For security purposes, no system information or status is available on the AK-SM 800A until a valid username and password has been entered. To assist in the confirmation of inputting of credentials, use the 'show' check box – this will show each character as you input.

Forgot Credentials

This button can be used if you have forgotten your user name or password. **Danfoss cannot access or recover any user name or password in the system, as these are stored in an encrypted format. If your log in credentials are forgotten you will need to enter new credentials, previous user credentials are not recoverable.**

Please note that it is expected that one administrator can always gain access to the system and thereby delete the original user profile of the user who has forgotten their credentials and create a new one, where the user would input a new password. If the administrator is not available or cannot perform this action, the reset password workflow will need to be initiated. Follow the on-screen prompts following 'Reset password' button.

Note: For security purposes, resetting of the password requires specific unit information that is ONLY possible when in front of the local AK-SM 800A screen.

Depending on the AK-SM 800A region (country) configuration, the initial contact point may differ. In essence, your first action is to contact Danfoss Technical support for your region. Upon receipt of your request to reset a password, Danfoss Technical support will raise a support ticket capturing relevant details and ultimately will provide a one off, time restricted (16 hours) user/password so entry can be established. Upon using this code to gain access to the AK-SM 800A you must update your user credentials with a new password.

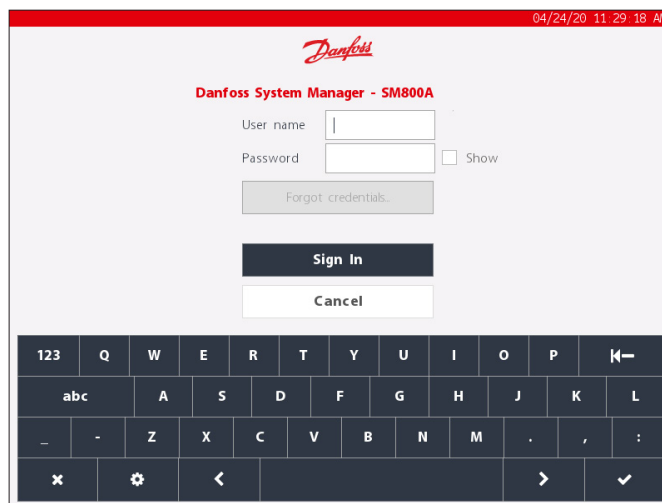

Note: For the North American region, Alsense™ can be called to initiate a password reset. The phone number will be shown in the reset popup window, as shown below.

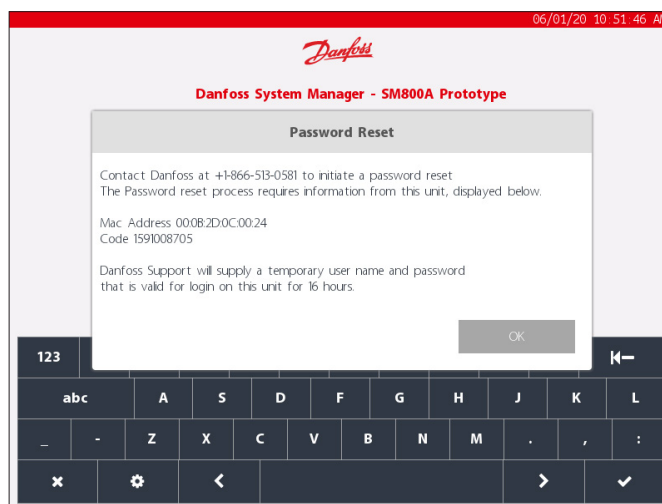
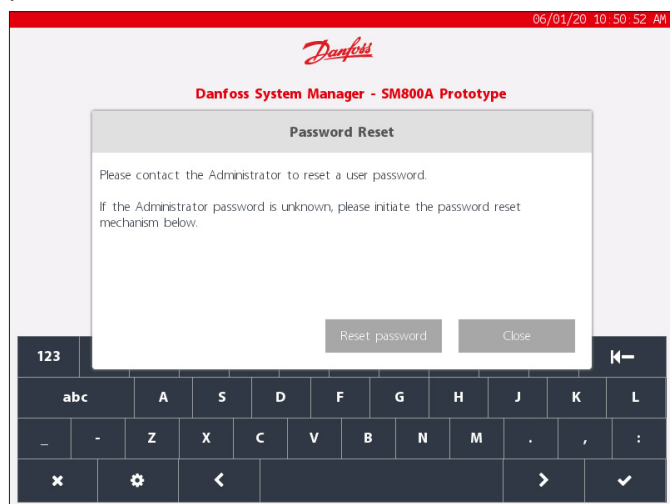

3.2 Home screen / Dashboard

After logging in, by default the dashboard screen will be presented. Note that a system preference is available under the Configuration → System → screen where the option to define either Dashboard, Equipment or Graphics as home screen is available.

The home screen (indicated by the home icon) offers access to different functions, described below;



USB Flash Drive

Access to the USB Flash drive (when inserted) is via the USB flash drive icon. The 800A supports FAT32 formatted USB flash drives with a usable file size of 4 GB. When a compatible USB flash drive is inserted into any one of the three USB ports, the USB icon changes to solid, indicating successful detection. Pressing this icon will bring up the USB menu options.

Note: Be sure to correctly eject the USB drive, via the top menu selection, corruption to the USB may occur if this is not done.

USB Flash Drive menu options

- Eject USB Drive: use this to correctly eject flash drive
- Update Software: Use this option to update the AK-SM 800A via compatible software package (obtained via Danfoss ADAP-KOOL support site)
- Export:
 - Database
 - HACCP Data
 - Refrigeration Report
 - System Report
 - Cleared Alarms
 - Audit Trail
 - Advanced Diagnostics
- Import:
 - Database
 - Device File pkg (.epk)

AK-SM 800A Wi-Fi Access Point

Your AK-SM 800A may offer Wi-Fi access point functionality, depending on model. If your unit has Wi-Fi Access point enabled, the Wi-Fi icon can be seen on the local screen, if this icon is not shown, your model does not have Wi-Fi available - use Ethernet for web connectivity.

The AK-SM 800A is equipped with built in Wi-Fi access, designed to support direct unit/user access. By default, Wi-Fi is disabled, only authorized users can enable this feature. The AK-SM 800A Wi-Fi access point can be used to connect a mobile device (smart phone, tablet) or laptop/PC and when enabled will remain active for 8 hours.

When connecting to the AK-SM 800A Wi-Fi, look for the wireless network SSD name and select. The SSD name will reflect the host address (rotary switch), since this is a point to point connection only (host network view not supported).

Once connection to the AK-SM 800A network has been established, open a compatible web browser (Google Chrome™ / Apple Safari™, Chromium based Microsoft Edge™) and enter the IP address shown on the Wi-Fi screen, the AK-SM 800A.

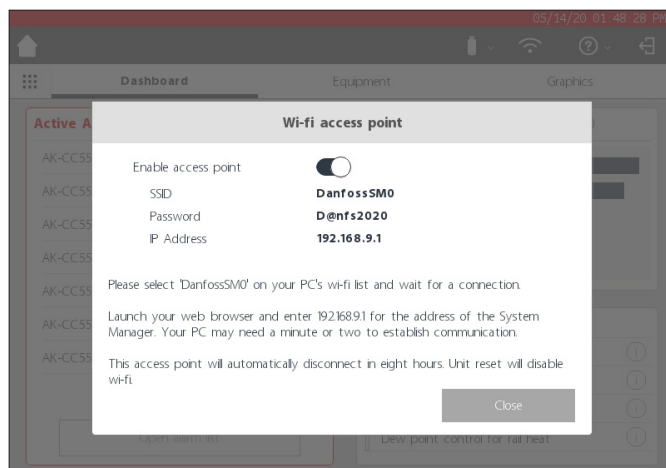
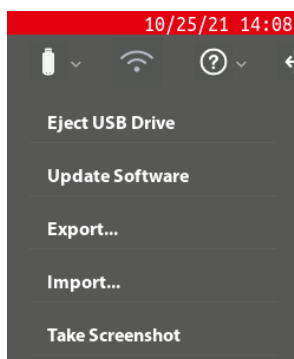
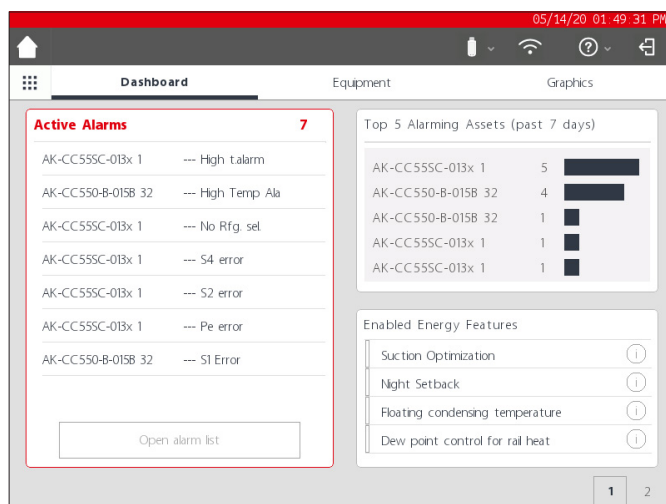

Web log on screen will be shown. Enter the AK-SM 800A user name and password.

When connecting with a mobile device (i.e. smart phone) the AK-SM 800A will auto detect this platform and will only present the unit Utilities. If accessing with a desktop class browser, StoreView browser 5 will be presented.

Note: If the Wi-Fi is enabled and the AK-SM 800A resets, for security purposes, Wi-Fi will revert to disabled.

Info button

The info button hosts a drop down menu selection, where the following is available;

About:

Shows unit information, software version, MAC and IP address

Licensing:

This screen will show any applied licenses

Terms:

End user terms and disclosure

Connections:

A technical view of active connections available on the AK-SM 800A.

Log out

Press the log out icon to exit and log out of the AK-SM 800A.

Note: The AK-SM 800A will detect inactivity and will auto log off after a period of 20 minutes. This can be changed via the Configuration->System screen (Idle timeout).

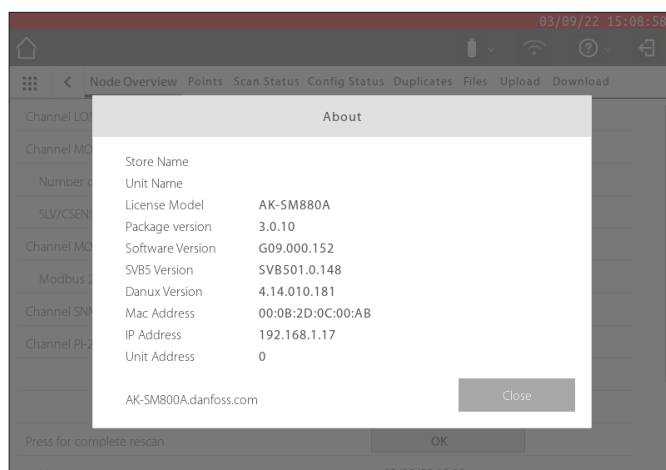
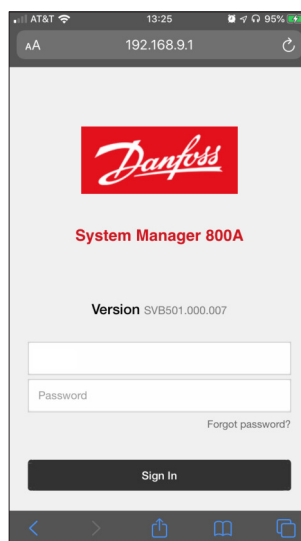

3.3 Home Screen – Menu Bar

The second level of menu bar on the home screen offers the following;

Fly-in Menu

Pressing the 'grid button' will trigger the fly-in menu. The purpose of this menu is to provide quick links / utilities to important areas of the AK-SM 800A.

Dashboard

With the Dashboard in focus (note grey focus line under Dashboard), the left hand section of the screen will display active alarms. The active alarm count will be shown as a red digit, followed by the active alarm list. Press the 'Open Alarm list' button to open a dedicated alarm screen.

The active alarm screen will show all current active alarms in the AK-SM 800A unit. An active alarm is one where no user action has occurred, for example the alarm(s) have not been acknowledged.

Use the check boxes to select or de-select different application types (HVAC, Refrigeration, Lighting, Misc.). A search field can be used to quickly search on device name.

Alarms on this list can be acknowledged individually or on bulk. To perform a bulk acknowledgement 'check' the device box and all entries will be selected – press the Acknowledge button to execute this action. Note that this will be recorded in the Audit trail.

Additional functions can be found along the top of the screen, Cleared, service, status and info

Cleared

This screen will show all alarms that have been set to cleared.

Service

This screen allows the user to send test alarms, suspend alarms, clear alarm log and delete alarm configuration. In addition, the internal relay (found on the AK-SM 800A) can be configured.

Status

Provides a quick status view (offline) of your connected devices.

Top 5 alarming assets (past 7 days)

The upper right segment of the screen shows a rolling analysis of what devices (top 5) are highest in terms of alarm occurrences. This is for information only and may help guide the operator on what to focus on to reduce alarm counts.

Enabled Energy Features

The AK-SM 800A includes several energy functions that provide autonomous control and continuous savings of operational efficiency, when combined with Danfoss controls. Any built-in energy feature enabled in the system will show green in the list. This information panel is designed to prompt users in ensuring enablement of these included features, thus maximizing energy efficiency of the store.

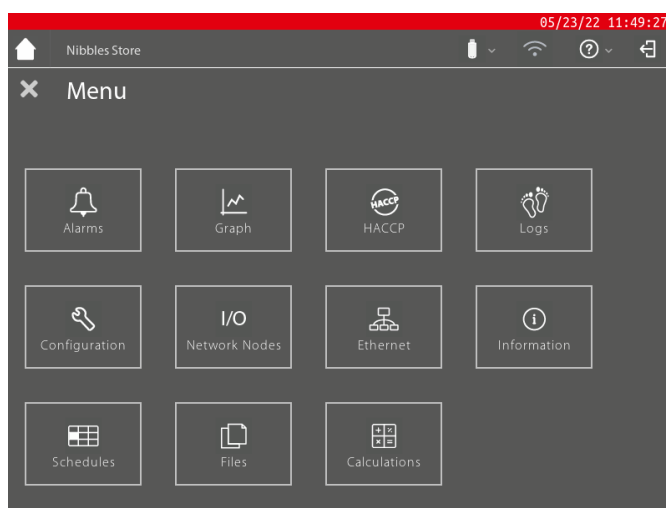
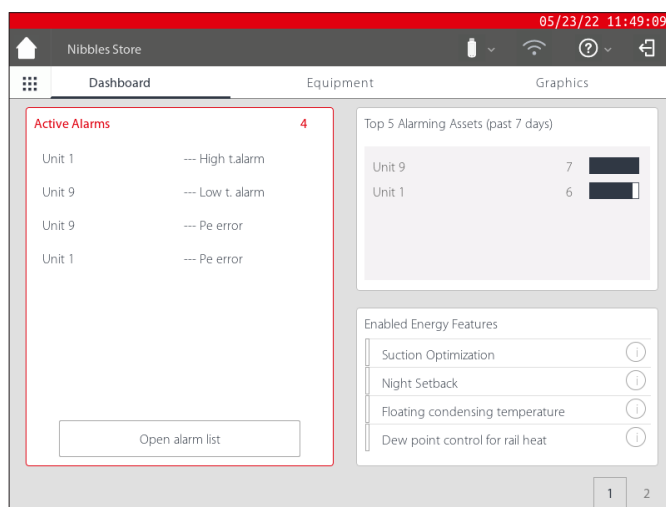

Custom Screen

The AK-SM 800A offers the ability to create a custom screen, populated with up to 15 points (OI, RO, SI, VO, Generic device). Once configured, the custom screen can be seen by pressing the second screen (2) button, found at the bottom right of the dashboard screen.

Note: To configure datapoints to show in the custom screen, navigate to the Configuration → System → Custom Screen. Here a selection can be made – in the example opposite, point 1 has been defined as a generic device (GN), Case 32 and the parameter u36 S6 Temp is selected.

Repeat this process for additional datapoints, upon completion press the 2 button to view the points. The values on this screen will auto refresh to provide an up to date status.

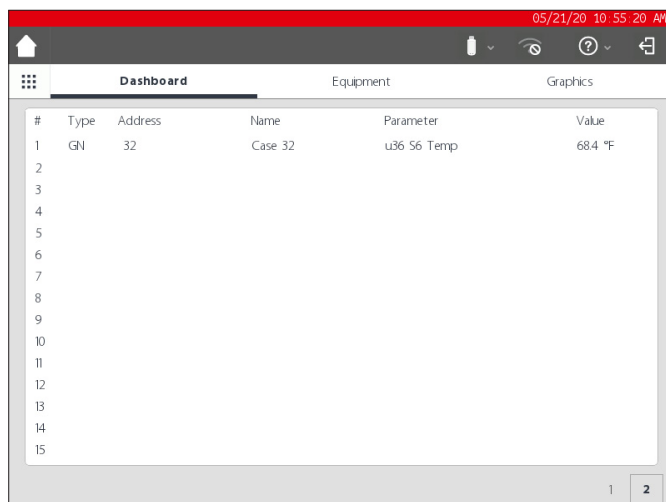
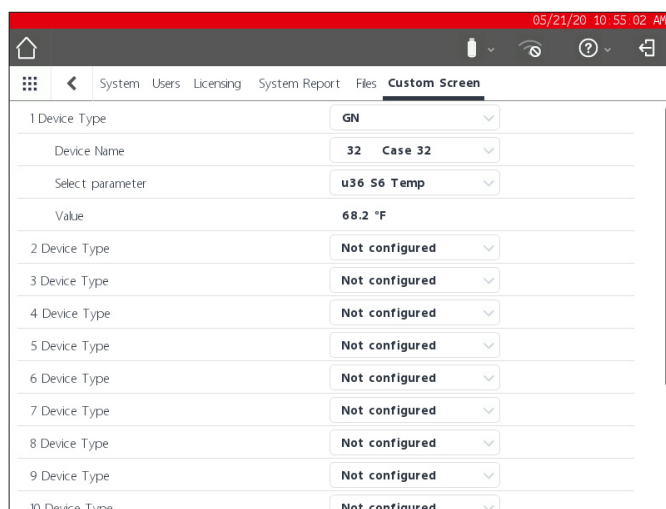
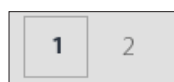

Equipment

To view a list of installed equipment, navigate to the equipment screen from the dashboard (grey bar will be indicated under Equipment menu).

Use the radio buttons to select which application type should be listed (Refrigeration, HVAC, Lighting, Misc) – by default Refrigeration is preselected.

A list of devices, grouped into Rack / Packs will be shown (reflecting the configuration).

To view more information on a particular device, press the > button, which will then show the device detail screen.

Graphics

To view any graphics loaded in the AK-SM 800A, navigate to the graphics screen from the dashboard (grey bar will be indicated under graphics menu)

Note: See the section on Utilities to get an overview on how to configure and deploy graphics on your AK-SM 800A.

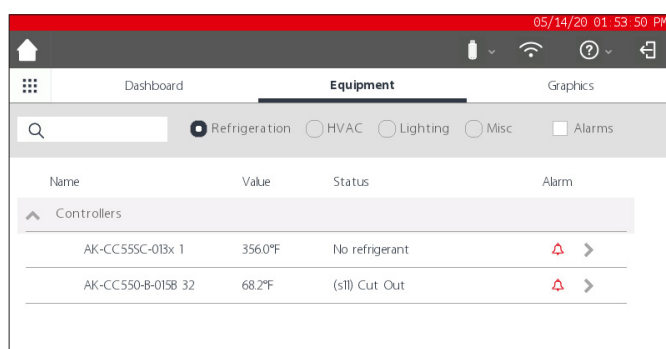

Chapter 4: Navigation and use (SvB5 browser)

Once your AK-SM 800A has been configured, general navigation and daily use is done via the Dashboard screen. The Dashboard screen acts as the central system home page, where further system details can be reached. The Dashboard and subsequent device screens have been developed to provide an easy to use navigation environment for the user, where typical status and setting can be found.

Dashboard view / Menus

Once the correct user name and password has been entered the Dashboard screen will load. The Dashboard screen will only reflect what your application configuration has been set to. For example, if your application does not have any HVAC configured the Dashboard will not show the HVAC panel. Dashboard panels are automatically generated depending on the configuration, no user action is required to build the panels.

Utilities (fly in) menu

Press the 'grid icon' to view the utilities.

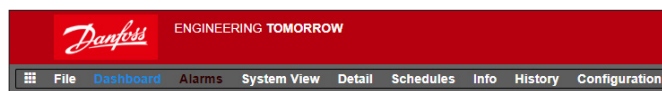

4.1 StoreView Browser 5 (SvB5)

This section describes the (web) browser interface of the AK-SM 800A, known as the StoreView Browser 5 or SvB5 for short.

Your AK-SM 800A includes web server technology that 'serves' data that is then displayed in a compatible web browser. SvB5 provides full access to all system screens and in some instances provides additional features not available in the local touch screen due to the preferred user interface (i.e. wizards are only found in SvB5)

SvB5 is a software module utilizing HTML 5, included in the AK-SM 800A software package, the version of which can be seen in the info screen(s) of your AK-SM 800A. For ease of use, no special tools and setup is required, simply open a supported browser and type the HTTPS address of your AK-SM 800A unit, for example; <https://192.168.1.50>

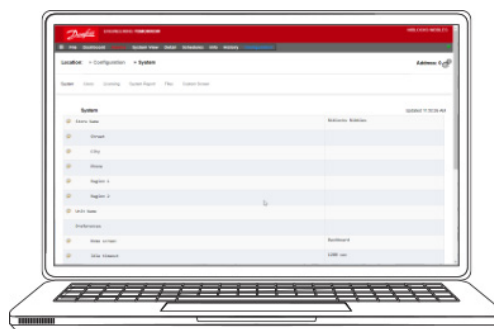

Note: At the time of user guide publication, Google Chrome™ Chromium based Microsoft Edge™ and Apple Safari™ are supported browsers for the AK-SM 800A.

Communications between your device/browser and the AK-SM 800A is encrypted using HTTPS technology.

Note: You may observe that your browser provides a warning, suggesting that the connection to this site is not secure. In fact, the browser is providing this user warning as it has detected a self-signed certificate which it cannot verify from a public database. In this instance you will need to continue to connect via the 'proceed to...' option (depending on your browser choice).

4.2 AK-SM 800A Utilities

This section describes the various AK-SM 800A Utilities, seen when connecting via a compatible browser. The Utilities are hosted in the AK-SM 800A, as an individual software component and are part of the AK-SM 800A software package.

When logging onto your AK-SM 800A via a (desktop grade) compatible browser you will have access via the fly-in menu (based on user permissions), located next to the File Menu. The AK-SM 800A will recognize the browser type (mobile/desktop) and will react accordingly. For example, when accessing your AK-SM 800A via a mobile platform, only the Utilities will be shown, if a desktop grade browser is detected the full SvB5 interface will be shown, with access to the Utilities as described.

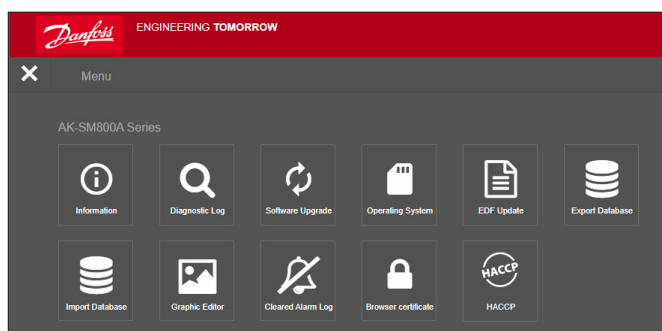

Feature	Apple™ iOS™ device	Apple Mac device	Google™ Android™ mobile device	PC/Laptop
	Mobile browser	Desktop browser	Mobile browser	Desktop browser
	Safari (mobile class) Chrome (mobile class)	Safari (desktop class) Chrome (desktop class)	Chrome (mobile class)	Chrome (desktop class)
StoreView Browser 5	N	Y	N	Y
Utilities_Software update (Web)	N	N	Y	Y
Utilities_Software update (local file)	Y	Y	Y	Y
Utilities_Information	Y	Y	Y	Y
Utilities_diagnostic log	Y	Y	Y	Y
Utilities_Software Rollback	Y	Y	Y	Y
Utilities_EDF update	Y	Y	Y	Y
Utilities_Export database	Y	Y	Y	Y
Utilities_Import database	Y	Y	Y	Y
Utilities_Graphic Editor	N	Y	N	Y
Utilities_Cleared Alarm Log	Y	Y	Y	Y

At the time of publication, the AK-SM 800A and SvB5 supports Google Chrome™, Chromium based Microsoft Edge™ and Apple Safari™ mobile and desktop browsers. Refer to the chart below for a detailed overview of platform and associated feature support.

Note: Whilst SvB5 is not currently engineered to support responsive web design, enabling full mobile use, it is possible to view and use SvB5 in a mobile tablet device that supports browser Desktop mode (i.e. Apple iPad™ 10.2" and above). For best SvB5 experience Danfoss recommends and supports PC/Laptop configuration only.

Utilities - Information function

Selecting the information button will retrieve and show AK-SM 800A unit information. The most commonly used information is located at the top of the screen. The Information screen also contains version numbering for other technical software aspects that may mostly be relevant to Danfoss.

To easily record / share unit information, use the download icon, located in the upper right of the screen. This will initiate a download, presented as a Comma Separated Value (.CSV) file (the file will automatically be named YYYY/MM/DD/HHMMSS).

Utilities – Diagnostic Log

The diagnostic log is intended to capture technical information about unit operation or system events. This log is designed for Danfoss Technical support and is intended to gather large amounts of data and is not intended to present a daily user audit trail. An export feature is available that will easily download a diagnostic log file, which can be sent to Danfoss for analysis.

4.3 Utilities – Software update

Introduction

Like many other modern electronic devices, it is important that you maintain your AK-SM 800A with up to date software. Danfoss has a policy of continued improvement and enhancement and will regularly offer updates to your system. These updates may include bug fixes, new enhancements and important updates for security vulnerabilities. Updates can be categorized as 'recommended' or 'mandatory', with supporting documentation describing the categorization. The following section describes the Software Upgrade feature, found in utilities. Use this feature to remotely update your AK-SM 800A series controller.



Important: To download the latest software package for your AK-SM 800A series controller, visit www.ak-sm800a.danfoss.com

Operational scope and Important notes:

Once connected to your AK-SM 800A series controller you will have access to the Utilities App. The Software Upgrade function is currently designed for single SM800A units only. For example, if you have a host network of multiple units, ensure you connect to the actual unit (IP address) that you intended to update. To update other units on the host network, be sure to log into that units unique IP address and follow the same workflow.

The software packages available for your AK-SM 800A have unique assigned 'digital signatures', this signature is then validated by the AK-SM 800A to ensure the file has not be altered or tampered with. Any software package that is modified will be rejected by the AK-SM 800A and update will not be possible.

Important: Whilst upgrading your system, power must not be interrupted at any time during the update process. Any power loss during the update procedure may cause permanent damage or corruption to your AK-SM 800A series controller.

Important: In host network applications (multiple interconnected AK-SM 800A units) it is required that ALL units have the same software installed. Failure to do so may result in unexpected behavior and may affect control and monitoring of your store.

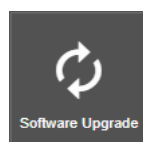

Utilities - Software update function

The software update utility offers two methods of updating, **Local Stored File** and **Web Connectivity** (note, in addition to using the Utilities, any of the USB ports on your AK-SM 800A can also be used to update software via a flash memory stick).

Local Stored File

This method assumes you have previously downloaded a software package from www.sm800a.danfoss.com and this package is located on the device you are using to access your AK-SM 800A / SvB5.

1. Click on the Local Stored File option and select the software package via the 'Choose File' button. The file type is SPK (software Package)
2. Press the Upgrade SM800A button to initiate the package download to the SM800A
3. After the package has been downloaded and checked for integrity, press the install button to execute the update. Note: During the update process, your AK-SM 800A will reset, this will temporarily disconnect your connection. Press the browser refresh to reconnect after ~3 minutes.
4. An upgrade Log will appear, with the final status 'Software upgrade SUCCESSFUL!', press the Home button to get back to the Utilities.

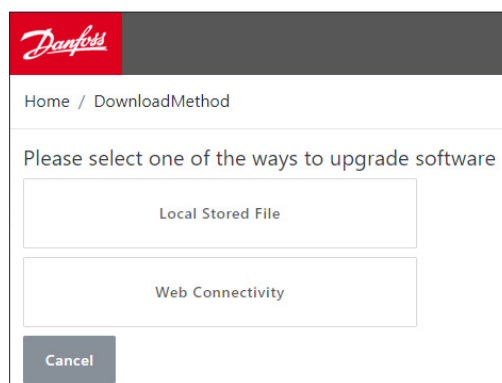

Web Connectivity

This method assumes you have connected to your AK-SM 800A via a device that has access to the Internet. Selecting this option will use your Internet connection to retrieve the latest AK-SM 800A software package (from secure Danfoss software server) and with the live browser connection to the AK-SM 800A unit, will update software. Follow the screen prompts to perform a software update via a web connected device. (Note: At this time Apple® based platform(s) do not support the web connectivity function, if using an Apple® device, use the Local stored file option described above)

Utilities- Operating System (Danux)

This function follows the same principle as described above for software update, but is supporting the updating of the System Managers operating system (OS). Your AK-SM 800A utilizes a Linux based distribution, specifically for Danfoss and like all software systems, updates may be required for feature or security reasons.

Utilities- EDF Update

EDF files are digital files that represent actual hardware/control products connected to your AK-SM 800A. When connecting devices to the AK-SM 800A it is required to have the correct EDF file to support that device, model, type and software version. As part of ongoing operations, it will likely be needed to update the EDF files or library of EDF files as new products or software variants enter the market. Typically, each time Danfoss issues new AK-SM 800A software update it will include the latest EDF files. However, during software release cycles it may be required to update individual or a group of EDF files that did not come or were not available at time, in this instance you can update the library of EDF files in your AK-SM 800A. Using the same principles as seen in software updates, you have a section of local stored file or Web connectivity.

To access EDF packages manually (when using the local stored file option), use the following link ak-sm800a.danfoss.com.

Note: To ensure the integrity of the AK-SM 800A only approved, digitally signed software packages will be allowed to be installed in the AK-SM 800A. Be sure that the tool chain you are using (i.e. MCX Shape) has the ability to export digitally signed files. Available EDF packages will have the format of 'SM800A_EDF_YYYYMMDD.epk

Utilities- Export Database

This utility allows for the export of the AK-SM 800A database. When initiated, the database will download to your browser download folder. The file will have a YYYYMMDD format with file format .dpc

Utilities- Import Database

This utility allows the user to select a compatible database file, and then import. The import procedure is done in a simple two step process. Step one is to download the selected database file to the AK-SM 800A, a file security check is performed, and the file is uncompressed. The next step is the actual installation, where the unit will reset.

Utilities - Graphic Editor

Using the Graphic Utility

The graphic utility allows custom graphics to be viewed at the local AK-SM 800A display or when communicating via Web. These graphics must be built and loaded in the controls on a host network.

Basic operation

This utility will only function on controls that are programmed and communicating. The host network must be operational for data from all controls to be retrieved into the Graphic utility. Once graphics are built the files are transmitted to all controls. Local graphics will only be applicable to match the unit communication address number.

The local SM800A graphics screen can only display data points programmed on this specific control. The Web graphics will display data points programmed on any SM800A on the host network. The initial files, Jpeg and PNG, have size requirements that must be adhered to. The graphics files are not imbedded in the database when exported or imported.

The DPJ file, project file, should be stored in a location allowing for future access. You can modify overlaying points at any time by opening the graphic utility, but the original Jpeg or PNG is not available.

The AK-SM 800A browser (using Google Chrome) will support a total of 5 web graphic views supporting custom Jpeg or PNG drawings, and 5 custom PNG views for each local AK-SM 800A unit. In addition to these graphical drawing the system parameters are mapped to display current sensor readings and status of digital inputs and relays. This may serve as an easy means to display data on the local and web screens. If no graphic is loaded the screen will be blank. If no graphic is loaded for the web application the tab for "View Graphics" is not available.



Select Graphic Editor from Utility menu.

User Guide | AK-System Manager, AK-SM 800A series

Prior to starting a build, these basic size requirements must be adhered to per the pop up screen shown
 JPEG or PNG for web graphics: < 1 MB
 PNG for local graphics: 800x450 pixels and 8 or 24 bit (no alpha channel).

On initial entry into the graphic utility all data points are automatically retrieved for overlaying

Selection of drawing

Step 1: Import the Jpeg or PNG file to be used for both web graphics and SM 800A graphics.

Select "Manage graphics" and using pop-up window select number of drawings to be used for Web (up to 5) and number of drawings to be used for SM 800A (up to 5 per control). Use the browse option to select the Jpeg or PNG drawings to import. The SM800A PNG will be specific to the unit as indicated below ie; Unit 0. The SM800A graphics will need to be selected for the other controls on the host network by first selecting another control ie; Unit 1 followed by selecting/importing the PNG files. When all drawings have been imported select "Save" to continue.

Step 2: Open the datapoints that will be overlaid.

The imported drawings will be displayed one at a time by the selection of either the "Browser View" or "SM Local Screen". When using the local screen option the drawings will be specific to the SM800A unit number. See below

Using the data tree on left select the data type ie; Analog sensor, Digital input, etc. Select the IP addresses for the SM 800A's to drag and drop the point on overlay.

For the SM Local Screen graphics there will be only one IP address as you can only select points for that control.

Step 3: Aligning layout

Any datapoint overlaid can be individually setup. Once the datapoint is placed on the drawing, and highlighted blue, a doubleclick of the left mouse button will display a pop up. This allows for the datapoint to be displayed in different formats. When the data point is highlighted blue the arrow keys on keyboard can now move the point for alignment.

Step 4: Loading the files in controls.

With datapoint overlay complete the package must be transmitted to the controls.

The "Save" button will transmit all the files to each controller in the host network.

A pop up window details the download status.

When the download is complete a pop up window notifies that the units must be reset for the new graphics to be implemented.

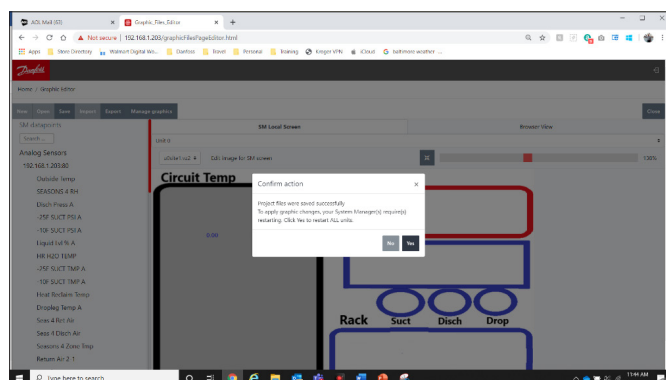
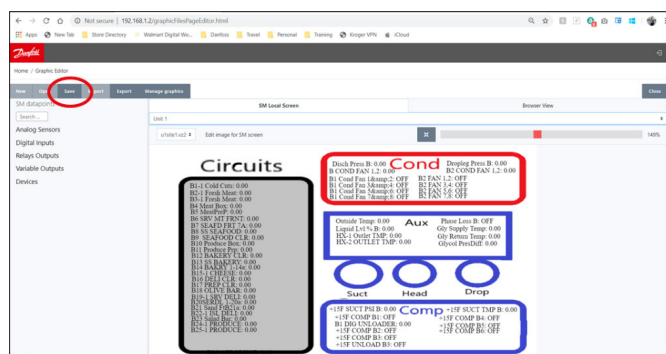
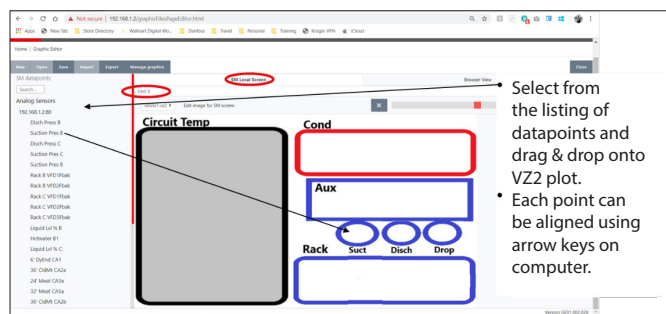
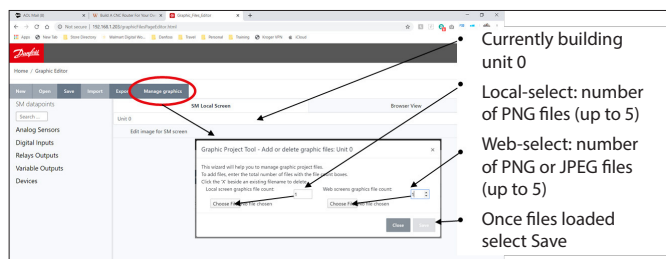
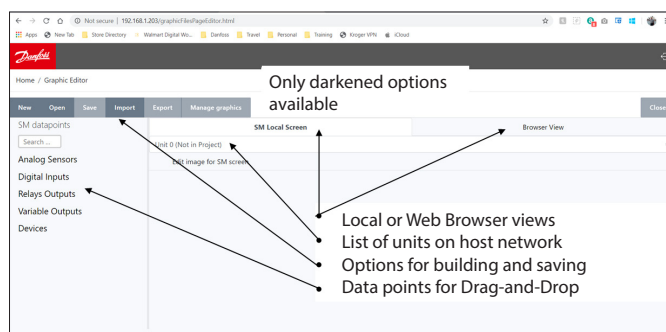

Step 5: Import and export the graphic package
 All the files used to build graphics are stored in a xxx.dpj file
 When selecting “export” a pop up asks for file name and the complete graphic package will be placed in the download folder. Ensure the naming identifies the store.

When selecting “Import” a pop up asks for file to be loaded to all controllers. This file must be specific to the store or data points will not be correctly labeled.

Utilities – Cleared Alarm Log

This utility presents a visual list of ALL previously cleared alarms from the AK-SM 800A. The cleared alarm log screen also allows the download of the units cleared alarms in .CSV file for easy sorting
 Note: Clearing the Alarm Log via the Alarm->Service screen does NOT delete this list. The cleared alarm log remains active and will continue to append to the list as alarms clear.

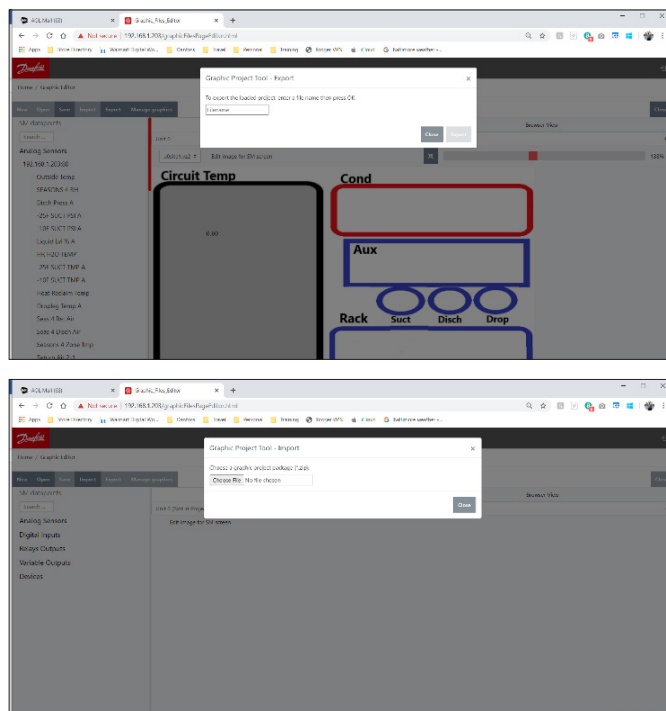

Utilities- Browser Certificate

Browser certificate management tool

Communication with the system manager via web interface is encrypted when (as default) HTTPS is enabled. The AK-SM 800A uses a self-signed certificate (SSC) and whilst the connection is secure, your web browser will likely mark the connection as not trusted. To facilitate a trusted connection between your web browser and the AK-SM 800A, the SM800A browser certificate must be signed by an authority known to the browser.

The browser certificate feature under the Utilities section is a tool intended for customer use and allows the creation of a CRS (Certificate Signing Request) allowing the customer to self-sign or obtain a Certificate Authority (CA) signed certificate. Once signed, the certificate is uploaded back to the SM800A - thus creating a root of trust between SM800A and browser.

Key notes:

- When the generate request is made, a new private key with 2048 bits is created using RSA
- The hash function uses 256 bits
- The certificate will expire after 365 days

The following procedure can be followed for the browser certificate management tool, where a Certificate Signing Request (CSR) will be initiated, resulting in a configuration file containing a new private key with 2048 bit RSA encryption.

1. Navigate to the Utilities section of the SvB5 and select browser certificate
2. The info screen will be shown
3. Navigate to the ‘Generate’ screen and fill in the following information
4. Country
5. Domain
6. IP Address
7. Organization
8. Press the generate button which will output a csr file
9. This crs file then must be signed by a trusted authority, usually via the following options

10. The user pays an internationally trusted CA (e.g. VeriSign, DigiCert) to sign the certificate. In this case the browser already has the root and intermediate certificate installed.
11. The user acts as a certificate authority to sign the CSR, installs root and intermediate certificates in user browser
12. Once the CSR is signed the user uploads the file through the web interface (Upload menu). The system manager first checks if the uploaded certificate is valid and ensures that a matching <domain>.key file exists. Finally, it runs a test to check if the uploaded certificate matches the private key (<domain>.key) that was created along with CSR. If the test passed, the current certificate is replaced, else the changes are rolled back and an error is returned. If the update was successful a summary of the new certificate is sent back as response.

The image below is a graphical representation of this workflow.

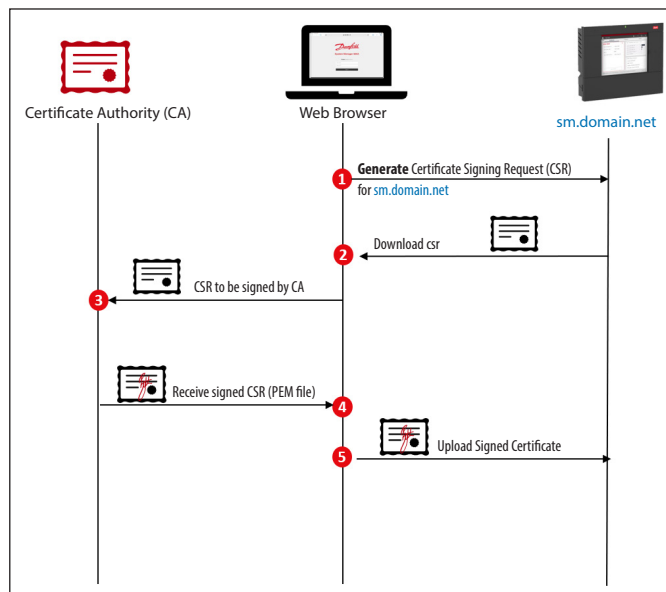

4.4 Food Safety Logging (HACCP)

From software release V9.000.15x and above, the AK-SM 800A offers a special logging function that can facilitate food safety reports.

Note: that the functionality now included in your AK-SM 800A does not replace enterprise advanced logging and reporting available via Danfoss digital services (Alsense™).

Highlights of the new System Manager feature are shown below:

- Designed for individual System Manager logging only (for multi-unit, multi-site / Enterprise data collection and view please consider Danfoss digital services - Alsense™)
- Manually select history datapoints and tag as 'HACCP'
- Any available parameter can be selected for HACCP logging (but typical use case is cabinet air temperature or product sensor)
- Danfoss I/O points and Generic devices (de-centralized field bus controls) supported
- Where available (device dependent) the HACCP report will automatically capture defrost status
- HACCP tagged points will be secured in the System Manager for 18 months before being overridden
- Report generation for stored data on tagged HACCP points accessible via local screen and browser
- Ability to export daily HACCP report (csv from local screen, PDF from browser)
- Ability to configure scheduled daily e-mail export (CSV attached)
- Ability to export (csv) HACCP report from local screen USB
- 200 history points are available for HACCP logging and fixed at 15 min. sample rates
- Configuration supported in Copy Wizard
- The same datapoint can be selected for both service logging and HACCP (note if same point is double configured, only service log frequency will be seen in main history view)

Configuring your System Manager for Food Safety Logging

Note: this can be performed on local touch screen or browser. For typical food safety monitoring it is recommended to select only 1 designated sensor per asset or control device (for example S6 on a Danfoss Evap controller).

- Log on with supervisor level access
- Navigate to Configuration → History
- Navigate to your required control device that has available sensors (in this example a Danfoss Case controller)
- Select your chosen HACCP point by enabling the HACCP line (factory set for 15 min sample)
- If required, the same point can also be select for 'service logs' – here select your frequency

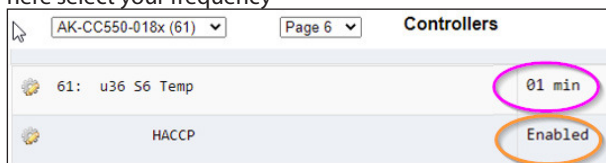

- Continue with all other devices that are configured and available – note that the copy wizard (available in browser) can be used to simplify this task if there are multiple same type devices configured
- Return to the Configuration → History Setup screen and ensure logging is enabled. This screen will also reflect how many HACCP points have been tagged (enabled) and how many service log points

Note: The selected sample rate for the 'service logs' point does not affect the predefined 15 min. sample rate of HACCP logging.

- There is a max. of 200 history points reserved for HACCP logging, a warning message will pop up if more than 200 points are attempted

Status	Collecting
No. of Configured Datapoints	208
No. of Polled Service Log Datapoints	100
No. of Polled Food Safety (HACCP) Log Datapoints	200
No. of Event-Driven Datapoints	0
Generic	208
Sensor Inputs	0
On/Off Inputs	0
Relay Outputs	0
Variable Outputs	0
Utility Meter	0

Configuring a schedule for your HACCP reports – e-mail export

Your System Manager has the ability to automatically export daily HACCP reports via e-mail at a scheduled time (or on demand 'now')

- Navigate to the Configuration → History → Other screen and select Schedule HACCP Report

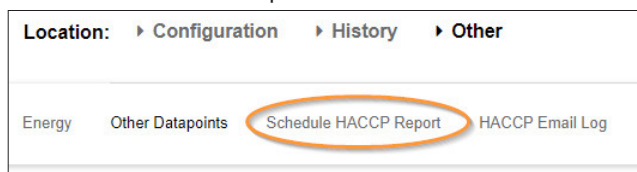

- Configure e-mail (see section 5.6 for information on e-mail configuration)
- Under the 'Schedule Report' section you may send a report 'now' or configure a schedule. If selecting a schedule, the daily time and day(s) can be selected

Note: Via the 'HACCP Email Log' menu a view of successful (or not) e-mail transmissions can be seen.

Viewing options for configured HACCP reports

After successfully configuring your System Manager for HACCP logging and after at least 24 hrs of data collection, you have different options to view and export.

a. Viewing HACCP report via browser

Via the utilities button, select HACCP. By default, the prior 24 hrs period to the current date will be retrieved and presented, as HACCP logs are daily reports only.

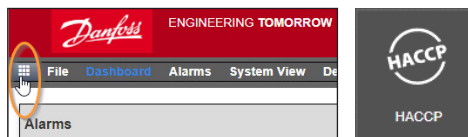

The HACCP report consists of 24 hrs shown in 1-hour increments (0-23) and will list all configured assets on the left vertical column. If the system manager detected a defrost input in association with the asset a Y / N will be shown (representing Yes or No), else n/a is shown. Each hour will display a value, which is the average of 4 samples for that hour. If a defrost state is detected at any of these 4 samples the asset will show Y for that hour.

There is a date picker and an export button at the top of the report screen. The export button will allow the creation of a PDF, which is downloaded to your browser downloads folder. Numbered pages will be shown at the bottom of the screen, allowing the navigation though all the assets.

Note: for large systems with many sample points it can take several seconds to build this report, this is normal, and a spinning circle is shown during this 'compiling time'.

ASSET	0	1	2	3	4	5	6	7	8	9	10	11	12	13	14	15	16	17	18	19	20	21	22	23	
AK-CC550-015B (63): u36 56 Temp	79.2	78.8	79.1	79.4	78.8	77.1	78.6	75.1	73.5	72.2	71.1	71.9	73.5	74.3	75.7	77.7	78.9	77.4	77.4	77.4	77.4	77.4	77.4	77.4	77.4
Defrost Event Detected	Y	N	N	N	Y	N	N	N	Y	N	N	N	Y	N	N	N	Y	N	N	N	N	N	N	N	N
AK-CC550-015B (65): u36 56 Temp	79.7	79.4	79.7	79.9	79.4	77.9	79.2	76.2	74.6	73.4	72.3	73.3	74.7	75.2	76.3	78.1	79.2	78.0	78.0	78.0	78.0	78.0	78.0	78.0	78.0
Defrost Event Detected	N	N	N	N	N	N	N	N	N	N	N	N	N	N	N	N	N	N	N	N	N	N	N	N	N
AK-CC550-12B (97): u17 Ther Air	75.4	75.0	75.0	75.7	76.9	76.1	77.2	73.2	73.6	73.4	71.8	69.4	69.4	69.2	71.0	76.0	77.3	76.3	76.3	76.3	76.3	76.3	76.3	76.3	76.3
Defrost Event Detected	N	N	N	Y	N	N	N	Y	N	N	N	Y	N	N	N	Y	N	N	N	N	N	N	N	N	N

b. Viewing HACCP report via Local Touch screen

Using the same principle and process as previously described, the HACCP report can also be seen via the touch screen. Via the utilities menu selector (9 dot menu button), a HACCP button can be seen. As in the browser, a date selector and report can be found, with the export button allowing CSV file export to USB Flash Drive.

Note: Via the USB flash drive main menu you also have access to HACCP data (fixed at previous days log collection).

4.5 File menu

Preferences

Under this selection custom settings can be made for the SvB5 via the Preferences pop up window.

Refrigeration report

When selecting the Refrigeration Overview report it is possible to output a current status report of configured refrigeration. The report will display current value, setpoint, alarm, defrost and device address. The report can be exported to PDF, CSV and Print. Note: It is also possible to export the Refrigeration report to a USB flash drive in simple text format, which is mounted in the AK-SM 800A USB port (user must be authorized).

Download report

It is possible to download a text file which contains AK-SM 800A information and configuration. The report includes information about the whole unit setup, alarms, schedules, scanned devices, audit trail and the controller database.

Note: Report setup (what to include) can be made under Configuration → System → System Report screen.

Log Off

As described.

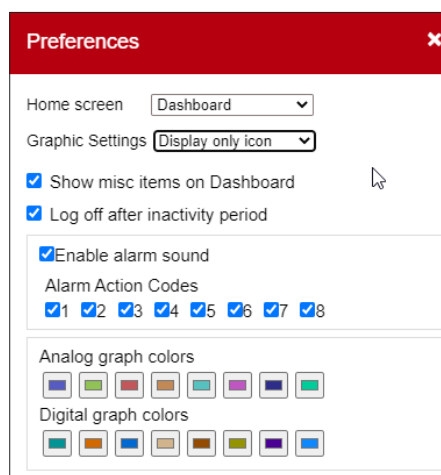

Note: If wishing to view CSV export in Excel, use the 'Data → From Text/CSV' menu in Excel to ensure correct visualization.

4.6 Dashboard

The Dashboard screen will only reflect what your application configuration has been set to. For example, if your application does not have any HVAC configured the Dashboard will not show the HVAC panel. Dashboard panels are automatically generated depending on the configuration, no user action is required to build the panels.

Upon the Dashboard loading, if any active alarms are present the built in alarm buzzer can be heard. To silence the alarm press the silence button. This does not acknowledge or clear any alarms.

The Dashboard allows for a consolidated 'system' view, where any configured AK-SM 800A on a host network will be shown.

Tips: Use the + buttons to zoom into a dedicated application panel.

If there is more than one AK-SM 800A configured on a host network, access to the individual unit can be done via the configuration menu (a drop-down list of configured units will be shown). Single click a line item to jump into more / additional details.

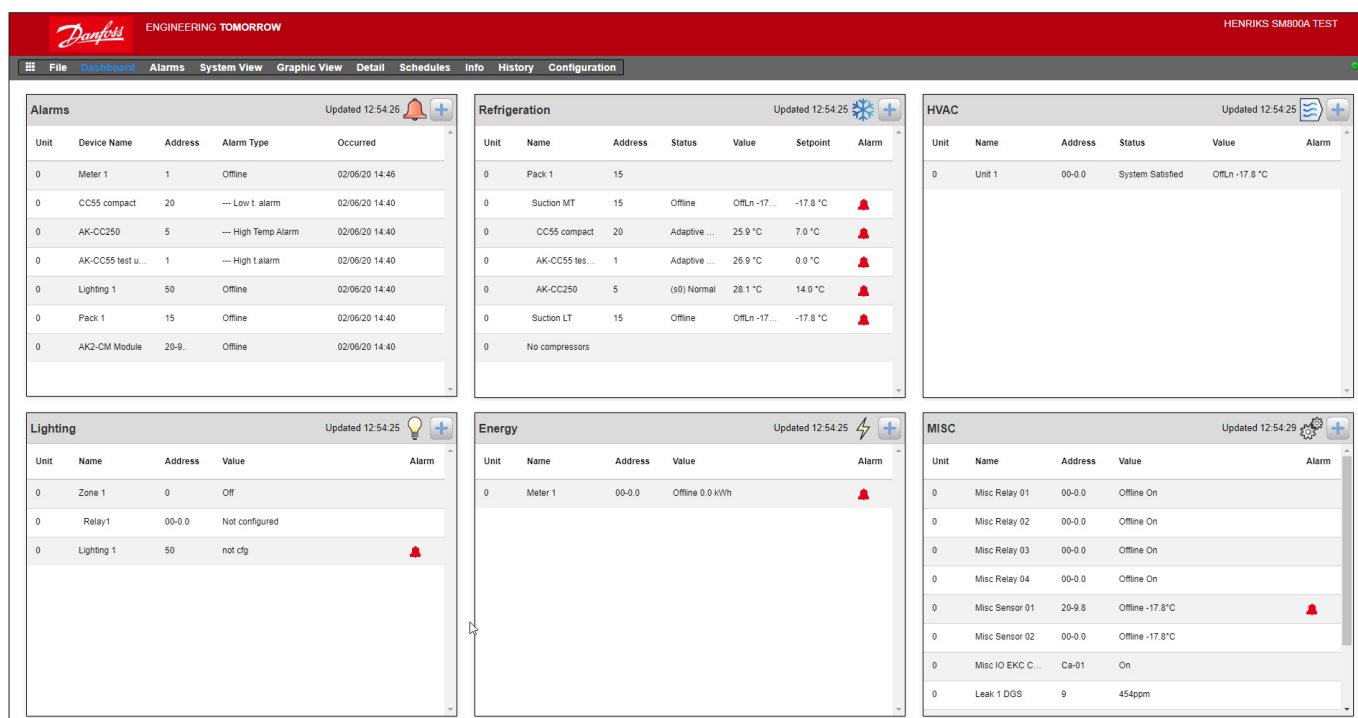

4.7 Managing alarms

Any active alarms will be shown in the Dashboard alarm panel. To view more details regarding the alarm, click the relevant alarm line. An alarm info box will appear with further details regarding the alarm.

In addition to more information, the info box also allows the authorized user to Mute/Acknowledge the alarm and to jump to the device detail screen.

Information

Description --- High Temp Alarm
 Point Case 32
 Address 32
 Setting Alarm if error
 Current Value Trip
 Occurred 06/02/20 08:42AM
 Acknowledged No
 Cleared
 Alarm Level Normal
 Alarm Action 1

Name	Status
Network 1	Not Sent
Network 2	Not Sent
Network 3	Not Sent
Network 4	Not Sent

Mute/Ack Detail Close

Use the Mute/Ack button to acknowledge the alarm. When pressed the alarm will 'move' to the Acknowledge list.

To view all system alarms (known as global alarms) use the Alarms tab (found on the main menu).

Status and Service screens

Global acknowledge list

Global cleared alarm list

Global active alarm list

Please Select Alarms to Export

- Active Alarms
- Acknowledged Alarms
- Cleared Alarms

Cancel OK

Service screen

Under the service screen tab, test alarms can be configured and set.

Alarm Status/Service

Service	Normal
System Test Alarm	Normal
Action	1
Press to send test alarm now	
Auto Test	None
Suspend alarm generation	No
Press to clear the alarm log	
Press to delete alarm configuration	
Internal relay 1	Auto
Internal relay option	Enabled with alarm
Internal relay 2	Auto

4.8 System view

The system view provides a generic yet graphical view of your configured controls.

The same principle of the navigation tree can be seen in the left side of the screen. The system view screen shows any configured Rack or Pack, with associated evaporator circuits. To see additional

information, hover your mouse pointer over an icon, a pop up box will appear showing additional information. To view additional information and gain access to settings click the 'show Detail' button. A dashboard will slide across, where a Status, Settings and Manual operation can be seen. Simply click an asset to highlight and the detail table will update with reference to this selected device. Once complete with the device settings, close the dashboard by clicking the 'Hide Detail' button.

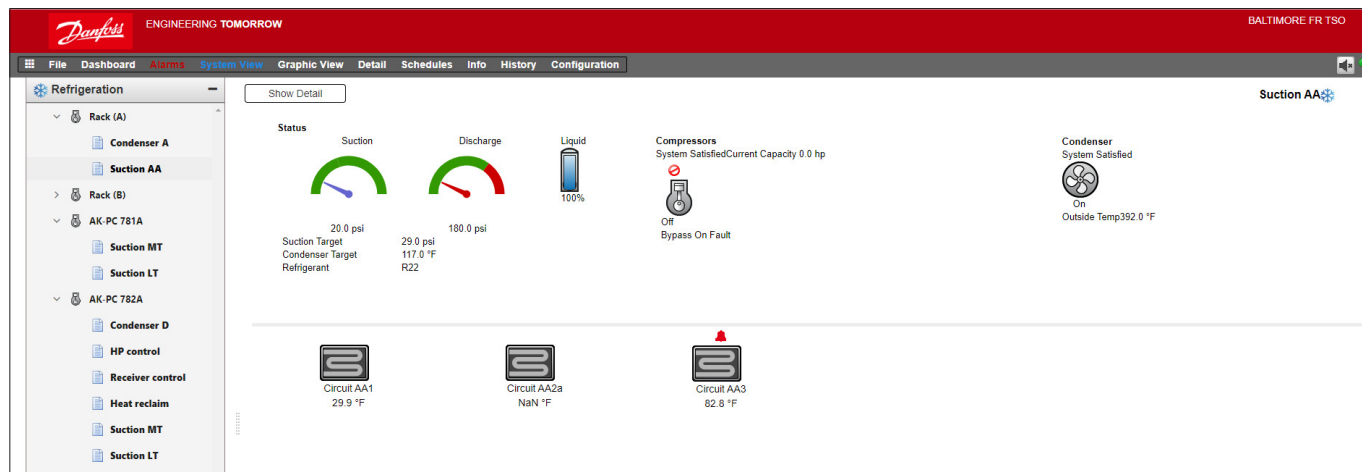

System View (Refrigeration)

4.9 Device detail

Whilst the Dashboard screen will show basic asset information (AK-SM 800A unit address, Asset Name, Value, Status and alarm), more detailed information can be found by clicking an asset line in the Dashboard. The resulting device detail screen will reflect more details and settings. The device detail screen is designed to provide key status and operational settings for the selected device. Easy navigation to other assets is done via the navigation tree.

The screen image below highlights some of the main areas of the device detail screen:

1. Application / device selection tree
2. Device Detail Menu (select overview menu for manual operation selections-if available)
3. Device details and history plot
4. Device menu (depending on menu selection in section 2)
5. Device Settings

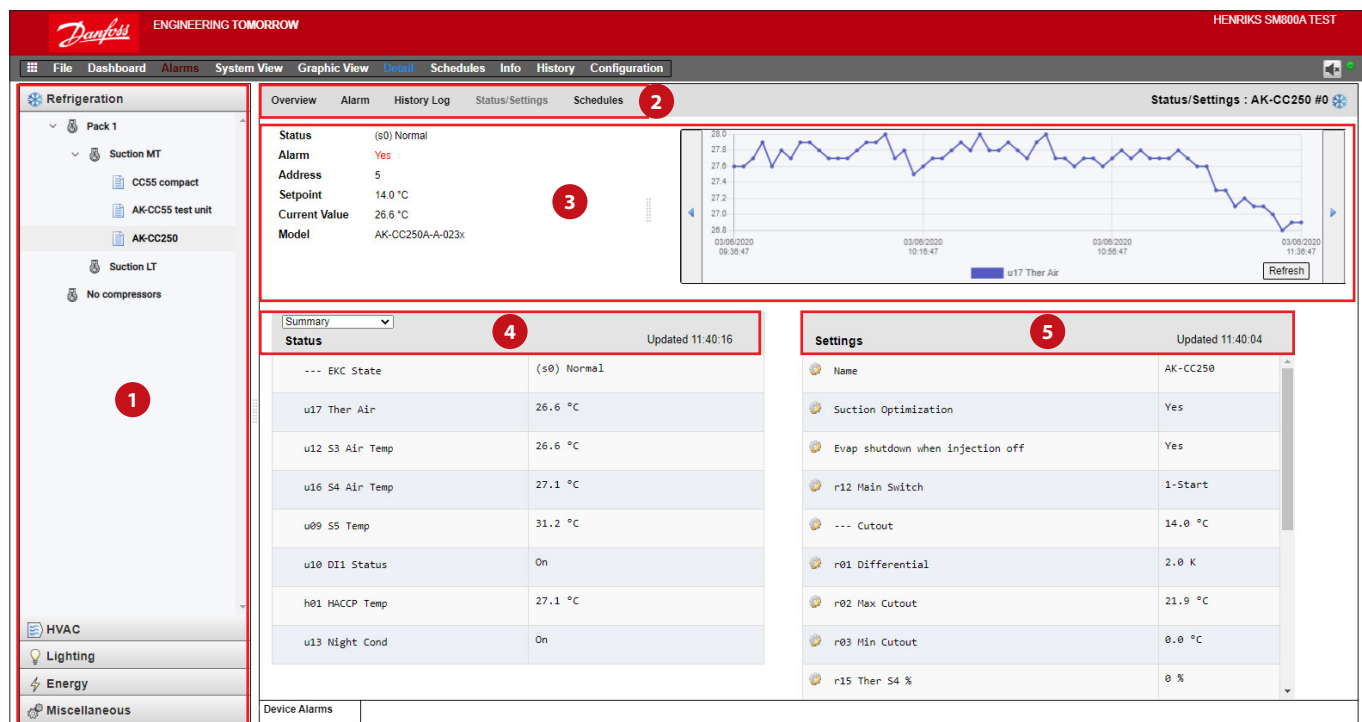

4.10 Schedule view

The schedule view provides a system wide view of schedules (previously configured) in your AK-SM or host of controllers. The following schedules are currently supported under the schedule view.

- Shutdown (Generic controllers - i.e. AK-CC)
- Defrost (Generic controllers - i.e. AK-CC)
- Case Lights (Generic controllers - i.e. AK-CC)
- Night Setback (Generic controllers - i.e. AK-CC)

If a host network of AK-SM units are configured, a full system view can be seen by selecting the folder icon, for a (AK-SM) unit display click the relevant heading under the folder view. On the schedule screen, you can hover the mouse pointer over each circuit, and the schedule times information will be displayed.

Change the graphical view to text (table) form, Print, save as PDF or save as CSV.

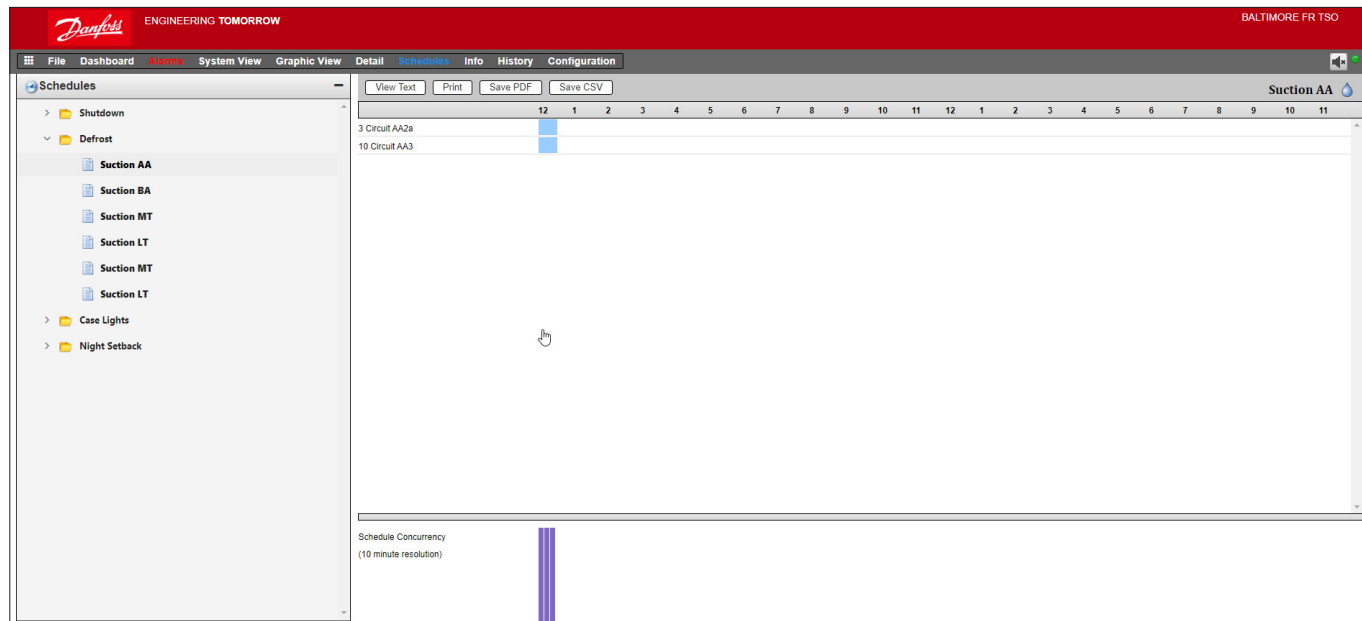

4.11 History (Logs)

To access your AK-SM history, select the history tab.

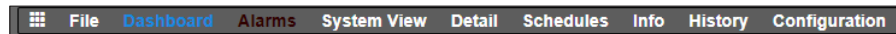

Upto 8 datapoints can be viewed at any given time on the history screen.

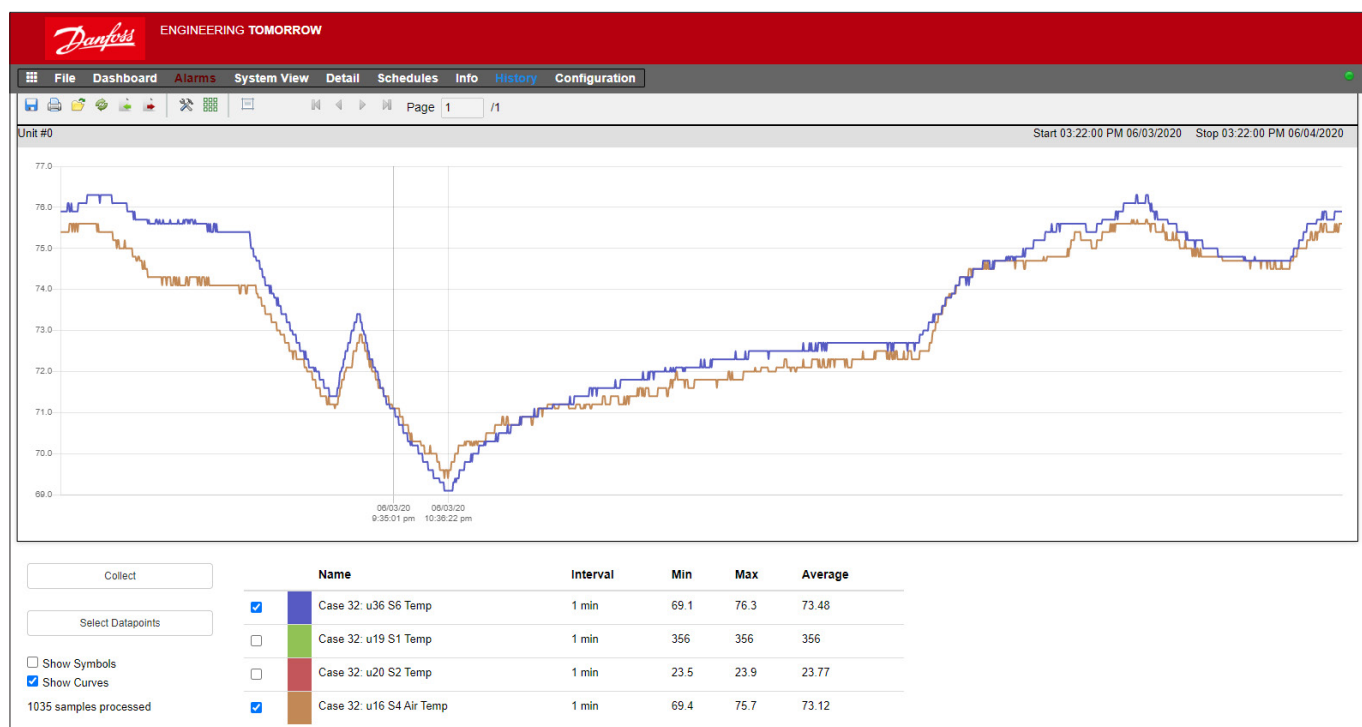

History Tool bar

When viewing data in the history view the tool bar has a set of functions to enable various actions to be performed. From left to right, the following functions are available.

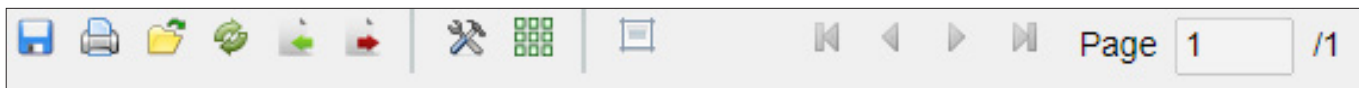

Export history function

This feature allows the user to export the previously collected history data.

A pop up window asks the user to select a file format, the following formats are possible.

- .hst (Danfoss history file format)
- .csv (Excel compatible spreadsheet)

Saving any collected history as a file allows for future loading and view, use the 'Load history from file' button to load any saved history files.

Note: A .hst file is a compressed history file created and used by the AK-SM 800A.

Print

Print (printer or PDF) your graph view

Load History from file

Use in conjunction with the export function.

Convert .hst filr to .csv file format

To view history data in a spreadsheet, use this function to convert from the .hst format to .CSV

Load history group from file

Used in conjunction with the save history feature. Use this feature to load any previously save datapoint groups. When opening the history group file the system will prompt for the file location. Once loaded a 'select datapoint' box will appear with the datapoints already pre-selection.

Save history group from file

This feature allows the user to save a set of history datapoints. Typically, this feature would be used when a set of datapoints is frequently needed to be loaded and viewed. Once the datapoints are saved, this history group can then be easily loaded - thus saving time in selecting datapoints.

Preferences

Date, time and unit preferences for graph presentation.

Show/Hide Grid

Reset Zoom

Click and hold the left mouse button and drag to create zoom area. This function resets zoom coordinates.

Page controls

When displaying large volume of data use the pages buttons to move forward, back or jump forward / back.

Collecting and viewing history

1. From the history page, press the collect button.
2. Select the required datapoints and time/date range. Multiple points can be collected but only 8 can be later shown in the history screen at any given time. After the datapoints have been downloaded, a dialogue box will appear which provides two options:
 - Select points to draw
 - Save to .hst file (for later view)
3. The graph will be presented for view and analysis. Use the zoom buttons or hold the left mouse button and hold for zoom area. Moving the mouse pointer will show a tool tip with point description, time/date and value.

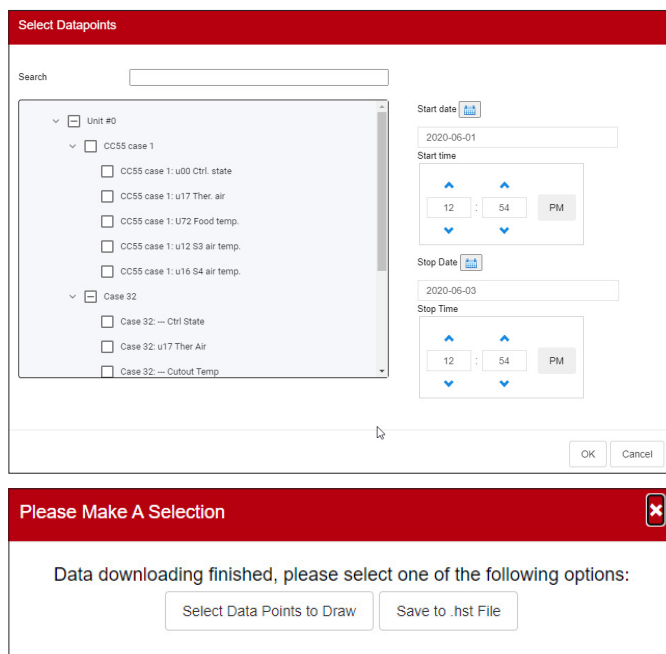

4.12 AK-SM 800A Host Network Configuration

The following section describes how to configure your AK-SM 800A to facilitate a host network. The AK-SM 800A host network can support up to a max of 10 interconnected AK-SM 800A units. The practice of interconnecting on a host network allows for support of larger applications or to separate discrete control applications onto dedicated AK-SM 800A units. For example, HVAC and Refrigeration control could be done via dedicated AK-SM 800A units. The host network requires an IP Ethernet connection to each AK-SM 800A unit. Once configured all AK-SM 800A units can be viewed in a consolidated format via a web browser.

Note: Ensure a common user / password is applied to all units in the host network. A consolidation view is only available via SvB5, not local screens.

Primary device configuration

Make sure you have suitable fixed IP or DHCP addresses for each of your AK-SM 800A units you wish to deploy on the host network. Also ensure all Ethernet cables are connected.

Make sure the rotary address switch (located behind cover plate) is set to 0 (Zero), which will define your AK-SM 800A as the Primary node on the host network.

Navigate to the Configuration/Comm screen and check your unit has a valid Primary IP address. Set the 'Host Network' question to Enabled. Enter the number of System Manager units you intend to have on the host network.

After all changes are complete reset the Primary AK-SM 800A unit.

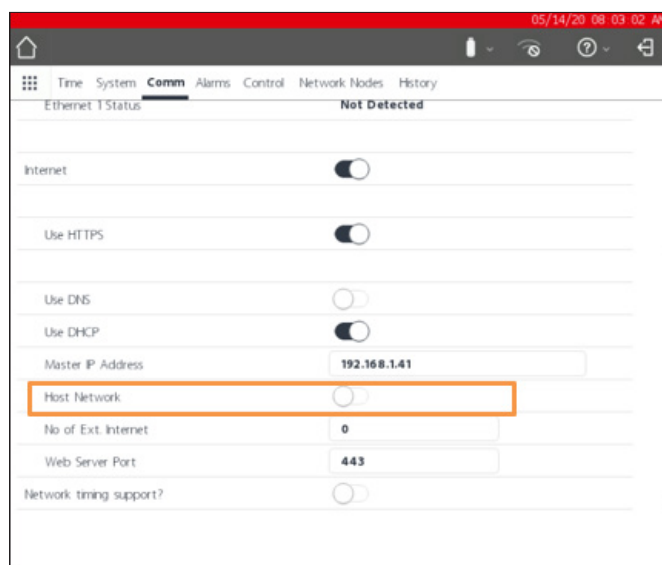

Note: Do not mix legacy System Manager 800 units on the same host network as System Manager 800A. These different unit types are not compatible and require separate host networks.

4.13 Secondary device configuration

Make sure the rotary address switch (located behind cover plate) is set to the appropriate number. For example, setting the switch to 1, will define the unit as a Secondary device address 1. All units in the host network must have unique host network addresses (address 0 is always Primary).

Once you have set the rotary address switch, reset the unit and allow the AK-SM 800A to boot up. Navigate to the Configuration/Comm screen and check your unit shows the Primary IP address.

Set the 'Host Network' slider to Enabled. Enter the number of System Manager units you intend to have on the host network (matching what you have already set in the Primary unit)

Make sure the Secondary unit has a valid IP address.

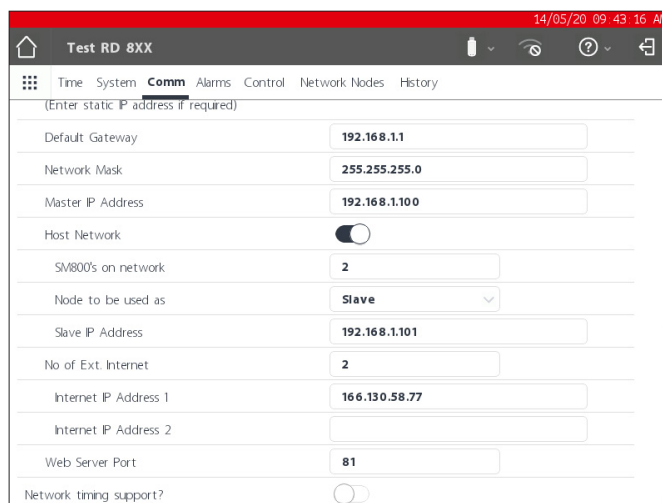

To validate the host network has been correctly configured and all System Managers can see each other refer to the Network status screen. Here you should see all AK-SM 800A on the host network via the local screen slide in menu, select 'Ethernet'.

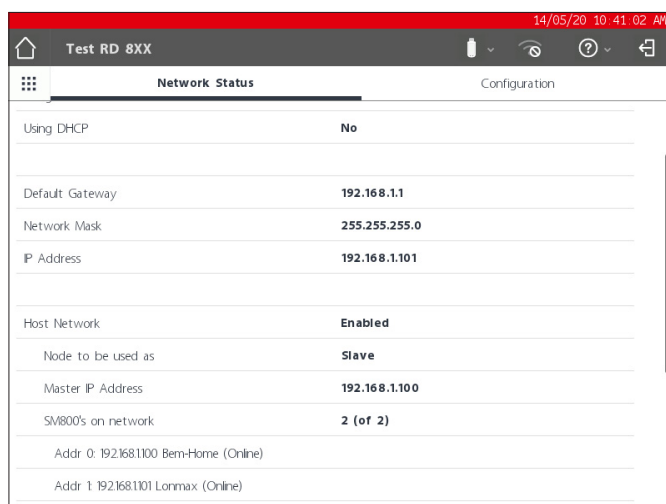

4.14 Device Upload / Download

When to use Upload / Download function

Understanding the concept of these difference methods will help in determining the use of the Upload or Download feature.

Upload = Retrieve field bus controller device settings and sync with AK-SM 800A database

Download = Send controller device settings held in the SM800A to the field bus controller.

The **UPLOAD** function is used to 'retrieve' or 'pull back' control device settings and update the SM800A database. Once the upload is performed and completed any subsequent device setpoint changes done via the SM800A will get immediately sent to the field device (no need to perform upload/download)

Example for Upload: A legacy Danfoss front end controller (i.e. AK-SC255) is to be replaced by the AK-SM 800A. The application has multiple field bus controllers, for example EKC-CC550 evap controller. Upon installing the AK-SM 800A to the established control network and completing a network scan an upload function is performed. This upload function will sync the AK-SM 800A database with the settings that exist in the field bus control devices. Once the upload is complete the contractor can continue to configure via the AK-SM 800A and change settings in the control devices.

The **DOWNLOAD** function is used to 'push' control device settings from the SM800A database to the field bus controller(s).

Example for Download: A contractor is planning a visit where a new AK-SM 800A will be installed with new field bus controllers. To save time on site, the contractor (who has access to the new AK-SM 800A) pre-programs the devices in the AK-SM 800A. Upon visiting the site, the AK-SM 800A is mounted and powered up. After a successful network scan (that matches the previously configuration) the contractor uses the download function to 'push' the settings from the AK-SM 800A to all the selected nodes on the field bus.

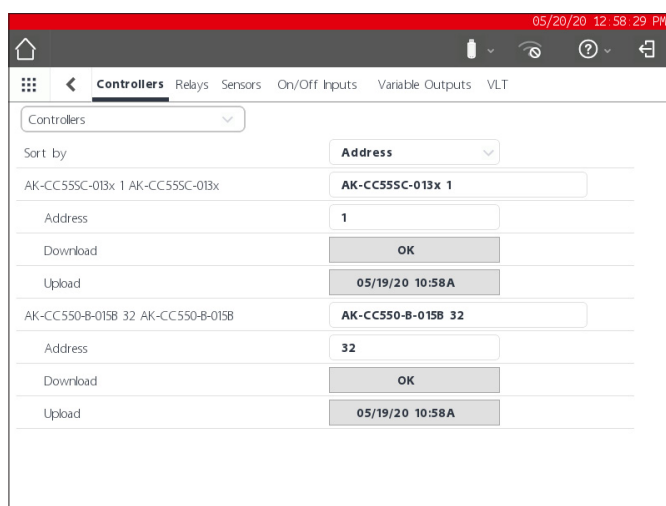

4.15 Device Management (Configuration/System/Device Management)

The purpose of the Device Management feature is to control the amount of active device files at any given time in the AK-SM00A, thus conserving system memory resources.

By default, the most common controller types are set to 'Enabled'. Groups which are not enabled (Disabled) are not actively loaded into system RAM. To enable any controller group simply slide the selection switch on for the group required

As device files are Enabled / Disabled the file counter will reflect the total number of active device files (seen in the Device Files menu). The term 'Files' in this case, is actually the total number of device selections available. For example, a controller such as an AK-CC 550 has 10 different applications. Therefore, each application is a 'selection'. Then the number of selections is multiplied over several software versions that may be available for that device.

This means that once the controller selection reaches 1000, you will need to disable groups of those devices not being used, in order to keep this number at, or below 1000. A message will be presented to alert if the capacity has been reached.

Using the network scan or Refrigeration layout/scan wizard will automatically enable any group is detected on a scan (even if the device file was previously set to 'disabled').

EDF's not packaged within the AK-SM 800A will be available via the Danfoss Support web site <http://www.ak-sm800a.danfoss.com>. When installing the latest AK-SM 800A firmware package, recently released / new EDF device files may not be included.

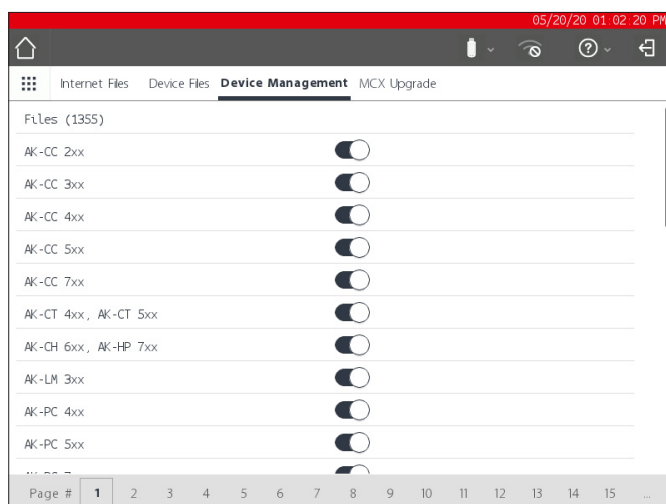

Make sure to always disable all device groups that are not in use. When performing a re-scan, device groups are activated automatically if any devices within the groups are detected.

Chapter 5: Configuration

The following section describes the typical steps required for commissioning and configuration of your AK-SM. Although site applications can differ from one site to another, many setup procedures are common. This setup section assumes the AK-SM is mounted and all necessary power, network cabling and controllers are in place. The described work flow is based around the AK-SM web browser interface, but would equally apply if being done via the local screen. Further detailed commissioning instructions are found throughout this user guide.

The AK-SM offers unique control flexibility in that both centralized and de-centralized control methods are supported. The term 'centralized' is used to describe the control of refrigeration Racks via I/O (Danfoss Input / Output modules). Under this method of control the refrigeration control is managed directly from the front end (AK-SM), with field bus I/O. De-centralized control is the term used to describe the full support of Danfoss Pack and Case controllers. Under this method, each Pack or Case controller on the network can be seen as self contained, with control logic built in. The front end (AK-SM) under this type of application is more of a network manager, providing full read / write access and energy saving functions.

When starting your system configuration, you will have the opportunity to select either Centralized or De-centralized (or a mix of both) control methods.

The following areas of system configuration will be covered in this section:

1. Initial configuration - web wizard and copy wizard
2. Network Nodes (Network scan/ Node overview, Points, scan / config status, duplicates, upload/download)
3. Time (Set time/date, time zone, operating Hours, Daylight savings, Holidays)
4. System (Store / Region Names, Units preferences, Authorization levels and users)
5. Communication (DNS, DHCP, IP Ports)
6. Alarms (XML, e-mail, Routing)
7. Control (Configure Refrigeration, Lighting, Miscellaneous, Energy meters and Gas detection)

Once successfully logged into the AK-SM (web) and assuming you have the required authorization, system configuration is done via the central 'Configuration tab'. Clicking this tab reveals the configuration 'sub tabs'. Depending on your selection, these sub tabs will change dependent on content.

Using the menu structure seen in the 'Configuration' page, a step by step process can be applied when setting up your AK-SM.

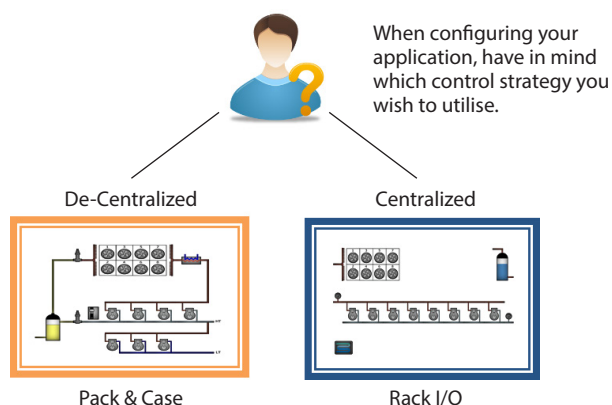
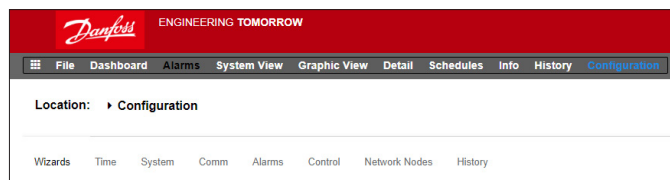

5.1 Configuration → Wizards

The following section describes the current Web Wizards, used for simplifying initial settings and Refrigeration layout. The Web Wizards can be used in an offline or online configuration. Danfoss recommends using the AK-SM web environment for commission tasks.

Establish a web connection to your AK-SM (if working online, enter the valid IP address of the AK-SM and apply the factory user name and password). Navigate to the **Configuration** menu

Preferences Wizard

(Language, store names, units, preferences, time, date, daylight savings)

1. To easily configure your units preferences, launch the Preferences wizard. Use the Wizard navigation controls to move through the Wizard screens.
2. To make changes, double click on the relevant line and continue until the final screen.
3. Press the finish button to complete and close the wizard (return to main wizard screen)

Users Wizard

(Create, modify users, user groups, authorization levels)

1. Enter number of users required (max 22), set password and browser language for each user
2. Enter the number of authorization types (max 7), against the settings line double click to modify the scope of system access
3. Press the Finish button to complete the Web Wizard

Licensing Wizard (Enter new license functionality)

Not currently used.

Refrigeration layout Wizard

The Refrigeration layout wizard is designed to improve on-site / connected initial setup and mapping of control devices. The wizard captures a workflow including scanning of configured field bus nodes, addressing and naming of the devices and finally allowing mapping of refrigeration devices to form suction groups.

New! For software Package version 175 and above (SMG09.000.134_SVB501.000.139), Danfoss Multi-suction pack controllers are supported, allowing the mapping of case controls to the relevant suction groups.

The Refrigeration Layout wizard is intended for Danfoss Pack and Case (Evap) controllers that are addressed and connected to an operational field bus (i.e. Modbus/LonWorks).

Limitations: Whilst the wizard will layout the Pack and Case relationships, further controller configuration may be required. Currently the wizard is intended for Pack and Case devices and HVAC devices, any controls not designated as such will have to be configured using traditional config methods (see Configuration section).

Starting the wizard

From the configuration menu, start the layout wizard in the refrigeration section (the wizard will assume the relevant control devices (Danfoss Pack / Case) are addressed and connected via the field bus.

Take note of the help text in the left-hand section of the screen. To navigate through the wizard, use the arrow key on the top right.

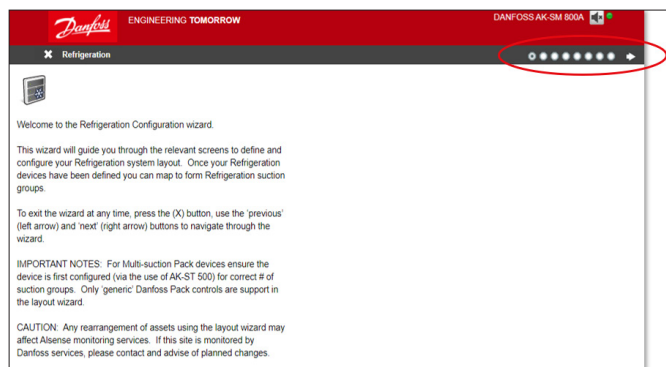
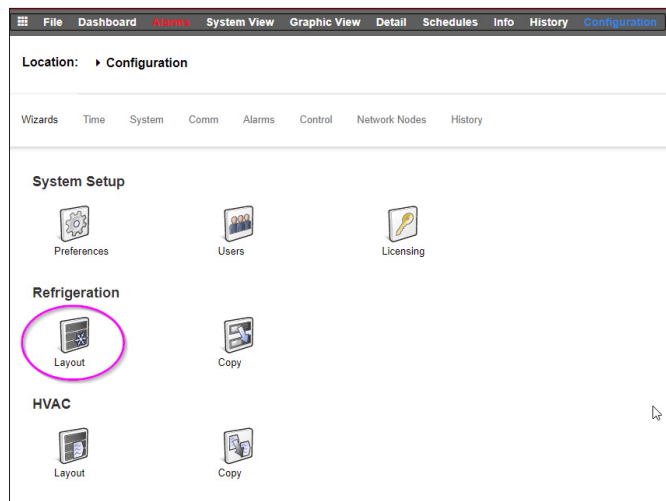
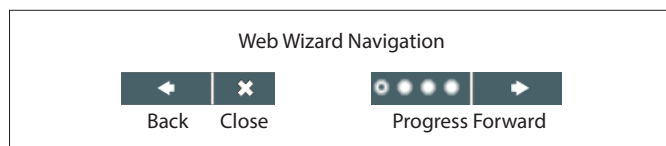
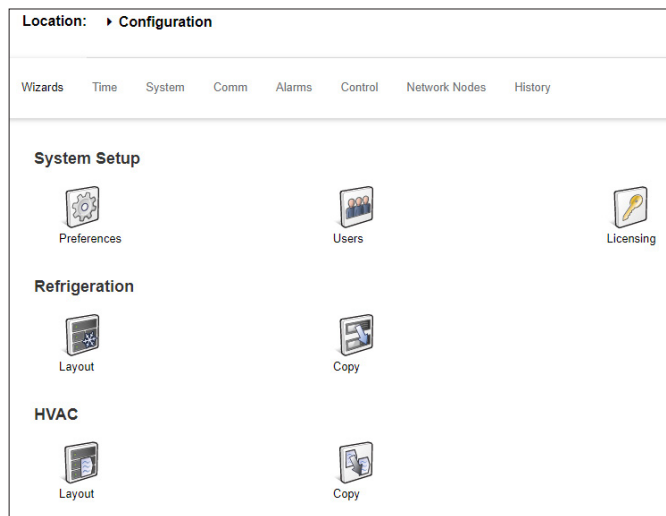

Enable channels for scan

Depending on your controllers and the required network topology, enable the channels that need to be scanned. Press the arrow top right to continue.



Scan the network

Scan the network by pressing the 'Scan' or 'Rescan' button. After the scan is finished, check if the network is complete, all devices are online, and you have no duplicate addresses. Press the arrow top right to continue.

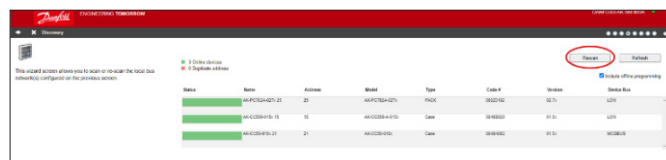

Compressor controls, set up amount of suction groups

Double click on the '0' under '# Suction Groups'

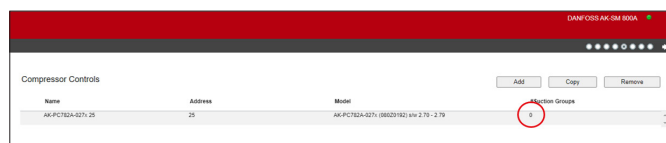

and use the arrow keys to set the correct number of suction groups for this pack controller.



Compressor controls, set up amount of suction groups

After changing the number/quantity of suction groups, a blue arrow appears next the device name.

Click on this arrow to open the suction groups.

You can now double click on each line to change the name for the controller and suction group if needed.

Press the arrow top right to continue.

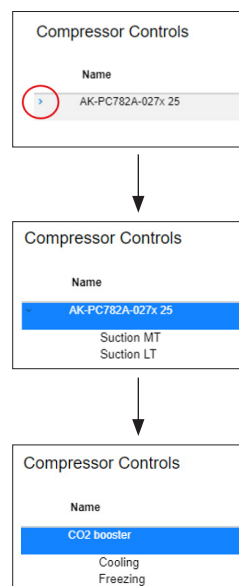

Setting up the case controllers

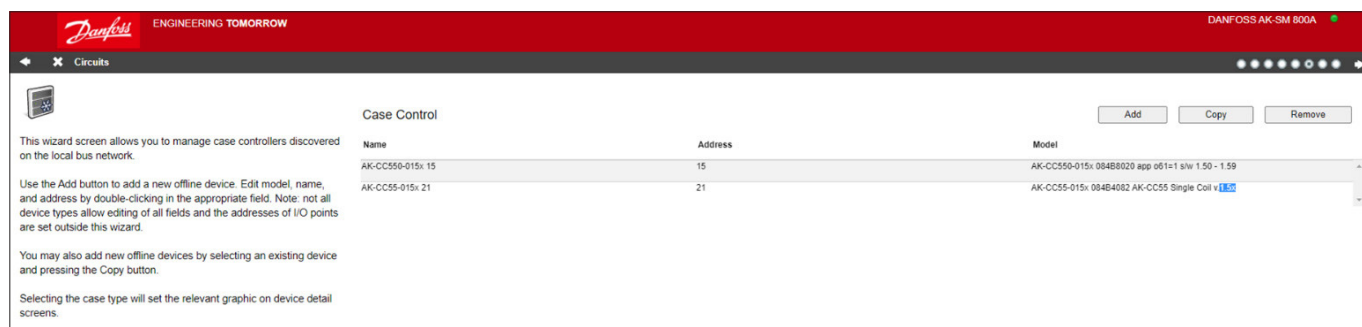

Double click on the case controller name to change it.

Press the arrow top right to continue

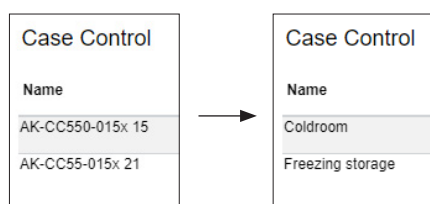

Suction group mapping

You now must connect the case controller to the correct suction group:

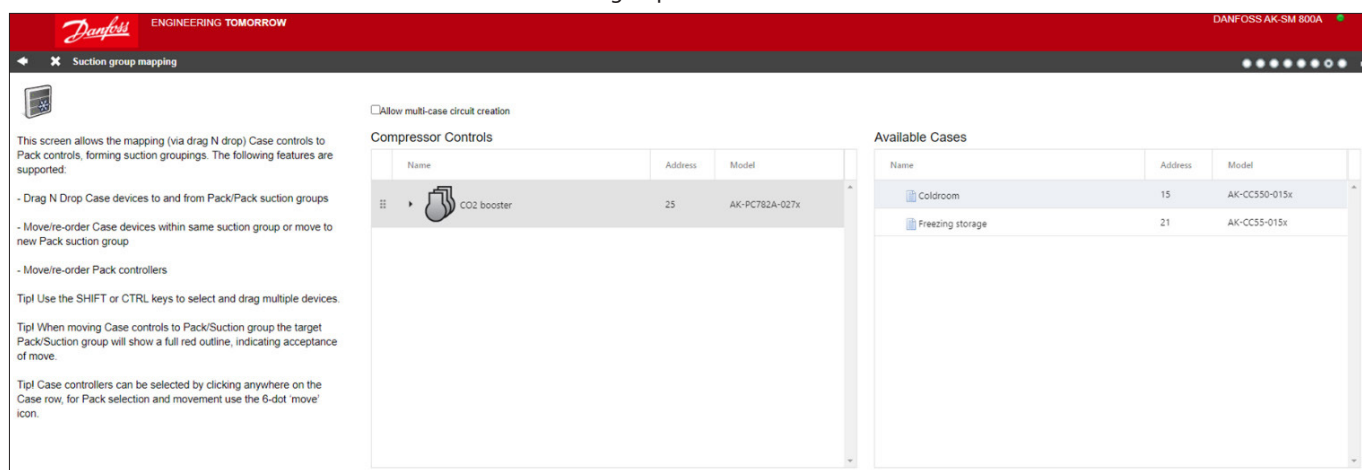

First, click on the arrow next to the pack controller name to open the suction groups.

Make sure that when dragging and dropping, the target suction group has 3 green lines around it before you drop the case controller in it.

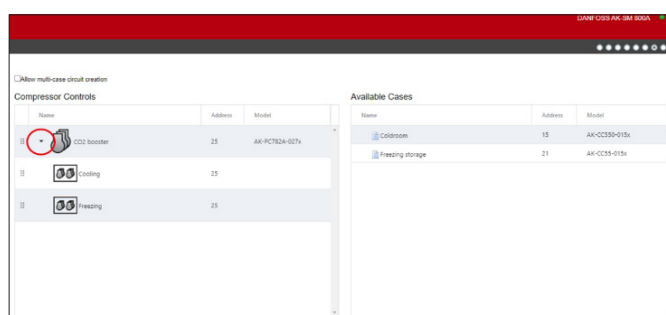

The example below a CORRECT, now you can drop the selected group:

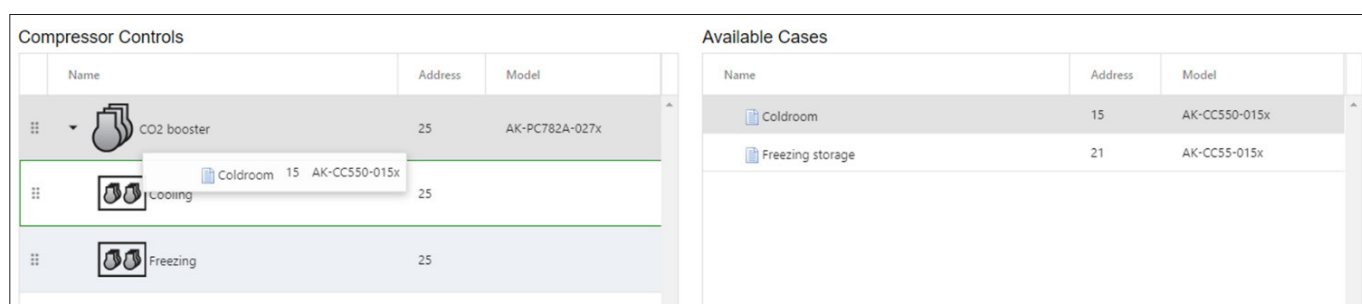

User Guide | AK-System Manager, AK-SM 800A series

The example here below is NOT good, as it's missing one green line on the left edge:

Name	Address	Model
CO2 booster	25	AK-PC782A-027x
Cooling	15	AK-CC550-015x
Freezing	25	

Name	Address	Model
Coldroom	15	AK-CC550-015x
Freezing storage	21	AK-CC55-015x

As next step, make sure all cases are connected to a suction group:

Suction group mapping

This screen allows the mapping (via drag N drop) Case controls to Pack controls, forming suction groupings. The following features are supported:

- Drag N Drop Case devices to and from Pack/Pack suction groups
- Move/re-order Case devices within same suction group or move to new Pack suction group
- Move/re-order Pack controllers

Tip! Use the SHIFT or CTRL keys to select and drag multiple devices.

Tip! When moving Case controls to Pack/Suction group the target Pack/Suction group will show a full red outline, indicating acceptance of move.

Tip! Case controllers can be selected by clicking anywhere on the Case row, for Pack selection and movement use the 6-dot 'move' icon.

Name	Address	Model
CO2 booster	25	AK-PC782A-027x
Cooling	25	
Coldroom	15	AK-CC550-015x
Freezing	25	
Freezing storage	21	AK-CC55-015x

If a case controller has been connected to the wrong suction group, you can drag it to the correct group by dragging it on the symbol left of the name (see below).

Name	Address	Model
CO2 booster	25	AK-PC782A-027x
Cooling	25	
Coldroom	15	AK-CC550-015x
Freezing	25	
Freezing storage	21	AK-CC55-015x

Then, press the top right arrow to continue.

Final refrigeration layout

The last page will show you the setup as you have made it. Check if everything is set up correctly.

If so, press the 'Finish' button top right to save your configuration.

Final Refrigeration Layout

Name	Address	Type	Model
CO2 booster	25	PACK	AK-PC782A-027x (08020192) s/w 2.70 - 2.79
Cooling	25	Suction	
Coldroom	15	Case	AK-CC550-015x 08488020 app o61=1 s/w 1.50 - 1...
Freezing	25	Suction	

5.2 Copy Wizard

Before performing the copy function ensure your SM 800 database is in sync with any control devices on line – refer to previous section 'System Upload / Download' before starting copy wizard'.

The copy wizard is designed to speed up the commissioning workflow by providing the ability to define a 'source' device and then copy the settings to like type devices. In addition to controller settings, the copy wizard also provides the ability to define and copy alarm controller configuration and history point configuration. A new feature added under the copy wizard for version G08_031 is the ability to save / load controller settings to and from a file.

During normal operations, your AK-SM 800A auto polls certain online controller parameters to sustain communications and to refresh key parameters at regular intervals. Please note that during the copy wizard process auto polling is temporarily suspended. Polling is stopped when you reach the parameter configuration screen. Auto polling will resume after a max 2Hr timeout or completion of wizard task or if wizard is cancelled, whichever is first. To cancel the wizard at any time only use the top left close 'X' button.

Some Danfoss controllers require that the 'Main switch' is OFF before allowing any parameter changes. To accommodate this fact, the copy wizard will automatically turn off the main switch for the source and destination controller(s). The main switch will be reverted to original position after the copy or copy/download is completed. Since the copy wizard changes the state of the device main switch, please pay special attention to operational conditions (i.e. food temperature) during this operation and validate all devices are correctly running after copy completion or cancellation of copy wizard. Failure to review device status may result in devices being left with main switch off (i.e. no refrigeration).

Important limitations

The copy wizard is currently not designed to fully support the Danfoss AK2 platform of devices (i.e. AK-PC 781, AK-CC 750..) since these devices have a different framework than other Danfoss controllers. When using the copy wizard in an on-line environment (connect to active controller network) the copy wizard will only allow 'Alarms and History' points to be set and copied. For full

configuration of AK2 device parameters Danfoss recommends using the available Service Tool to facilitate commissioning on these device types.

Note: The copy function will only work against same device, application/code type and is not designed to fully support Danfoss AK2 style controllers.

Preparation

Online Configuration

For onsite (online) commissioning, the copy wizard assumes all relevant controller devices are installed on the network, have correct addressing, and if relevant application type set. Naming of the asset will also help in the copy wizard due to easy recognition of your devices. The 'Layout wizard' can assist in this preliminary task.

During the final copy/download phase, the main switch of the target device(s) will be switched off then on after the copy/download is complete.

Offline Configuration

The copy wizard can be used in an online or offline (via RMT simulator) environment.

Before using the copy wizard make sure the source device is fully configured (settings, history, alarms). Whilst it is possible to use the copy wizard to set up the source device, it is not recommended and has been seen that potential errors can occur with this workflow – please configure the source device first (outside of the copy wizard). Once source device is configured the copy wizard can be used, do not make any changes (settings, alarms, history) to the source device whilst in the copy wizard.

When copying history. Be aware, that the copy process always keeps existing logs in the destination and new logs will be added. **BE SURE TO VALIDATE MAIN SWITCH STATUS AFTER COPY WIZARD.**

Note: When assigning history points to a controller device a recommended max of 100 points per device is allowed. Assigning more than 100 points per device will cause points not to record log history.

5.3 Configuration → Time

The Time tab allows the system time, time zone, operating hours, daylight savings and holidays to be configured. Double click a line to make any changes.



The following examples can be seen for the time zone; London (GMT) = 000

Central Europe = 100 East Coast USA = -500

The operating hours can be set that reflect your store operating hours. Any times set in this section can then be referenced to via a 'Relative schedule'. Relative schedules are found under the 'Lighting' and 'HVAC' application areas and apply a (user selectable) offset which references the operating hours schedule.

Holiday's for full days must be operated with 00:00 open to 00:00 close and not 00:00 open and 23:59 close or 00:01 open and 00:00 close.

5.4 Configuration → System

The Time tab allows the system time, time zone, operating hours, daylight savings and holidays to be configured. Double click a line to make any changes.

System → System

After completing the required settings in the 'time' tab, navigate to the 'system' tab. Under the system tab add the store name and region / preference setting and information. Other preferences are available under this screen, most are self-explanatory, but of note;

Home Screen: Define what screen is set as the home screen

Idle timeout: # of seconds before the SM800A will log out

Generic Device Write Errors: Enable this option when system is live and communicating to generic field bus devices. Set to Disable when programming a SM800A database that is not connected to any physical field bus device(s) - this is described as offline configuration.

Offline Status Indicator: Enable this function to view '*' in local and SvB5 screens for Generic devices that are not activity communicating. Under normal operation the '*' symbol will be briefly seen before getting updated with live device status data. If the '*' symbol remains active on the screen it is an indication of possible communication issues with the specific device. In this case, check for correct device configuration, wiring and network addressing.

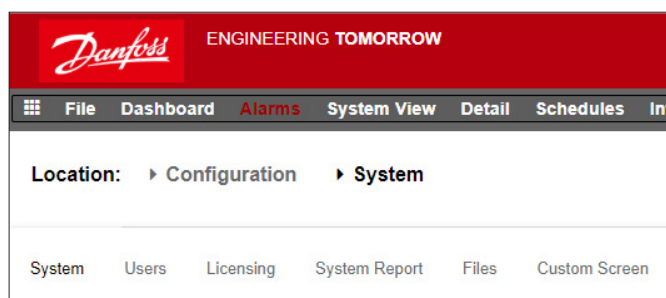

Clear Database: Will clear the database and upon reset the initial start up wizard will be presented.

System → Users

Under the users tab additional users can be added or removed (depending on your credentials). 100 Users can be configured in the AK-SM 800A.

By default, the setting of 'Require Strong Password' is set to yes. This setting encourages the use of passwords that are typical in modern computing networks and follows IT best practice. Danfoss strongly recommends using strong passwords to increase your level of system security and integrity.

Note: If this setting is changed to 'no', the screen will reflect a message warning of this selection. In addition, this action is recorded in the Audit trail.

When adding or configuring a user, you must be logged in at supervisor level. The following properties are associated with a user:

- Password
- Level (of permissions)
- Password expiry
- Account expiry
- Browser language

The following areas of authorization are available:

Configuration

- System:** Access to the System tab
- Authorization:** Access to the Authorization tab
- Refrigeration:** Access to Refrigeration configuration
- HVAC:** Access to HVAC configuration
- Lighting:** Access to Lighting configuration
- Miscellaneous:** Access to Misc configuration
- Schedules:** Access to Schedule configuration
- Calculations:** Access to Calculations configuration

Manual Operation

- (seen under Service tab in device detail page)
- Refrigeration:** Allow user to perform the following operations on Danfoss case controllers; Main Switch, Defrost, Cleaning, Lights, Night Setback, Shutdown
- HVAC:** Allow user to perform the following operations to Relay, Inputs & sensor overrides
- Lighting:** Allow user to perform the following operations
 - override relay
- Miscellaneous:** Allow user to perform the following operations
 - override relay, sensor inputs

Alarms

- Configuration:** Allow user to configure alarms
- Routing:** Access to the alarm routing
- Acknowledge:** Allow user to acknowledge
- Clear:** Allow user to clear alarms
- Log:** Allow user to set alarm level to log

Other

- Use Access Point:** When checked the user can enable the AK-SM 800A Wi-Fi access point
- Use USB:** When checked the user can use a USB Flash drive (update AK-SM 800A software/save database)
- Rescan Network:** When checked the user can perform network scanning

System → Licensing

This screen offers the ability to add new license (future feature), view current license and unit MAC address

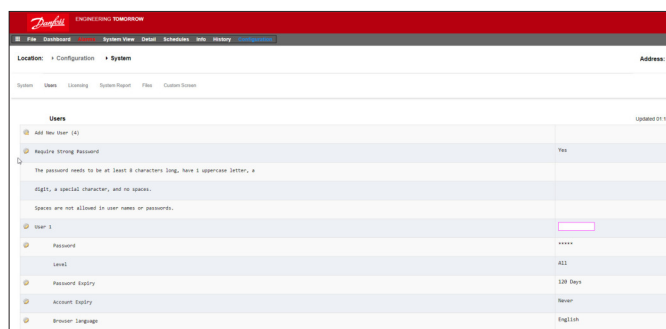
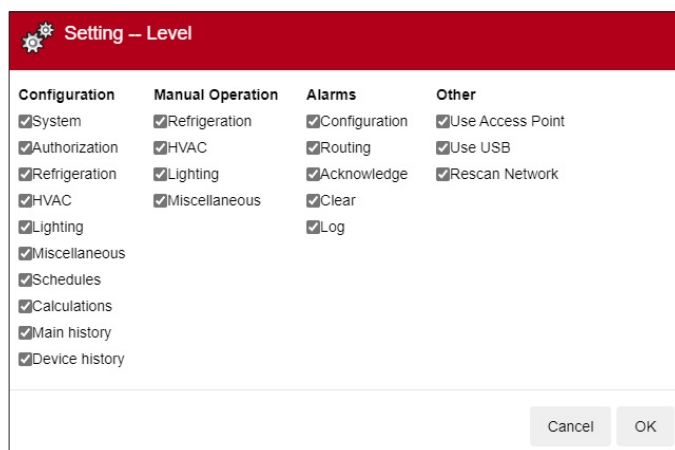

System → System Report

This screen allows configuration of what aspects of the AK-SM 800A should be included in the report (available via the File – Download report option in the dashboard)

System → Files

This screen has four sub tabs;
 Internet Files – listing files associated with browser connectivity.
 Language and web graphic files (if installed) will be listed here.

Device Files – List of installed EDF files, supporting field bus devices.

Device Management – list of device type in groups, for example all EDF files for AK-CC 2xx model will be available for system use if this group is Enabled MCX Upgrade.

System → Custom screen

Use this screen to configure up to 15 points that will then be shown on the AK-SM 800A dashboard local screen (selected by button 2).

Assuming there is configured nodes available, double click the Device Type line and select from the drop down menu.

Tip: Select GN for generic or field bus controllers!

Select the device and then the parameter. The resulting value will be shown.

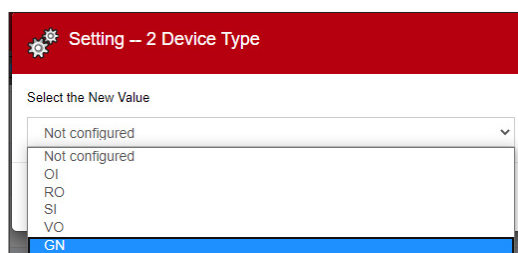
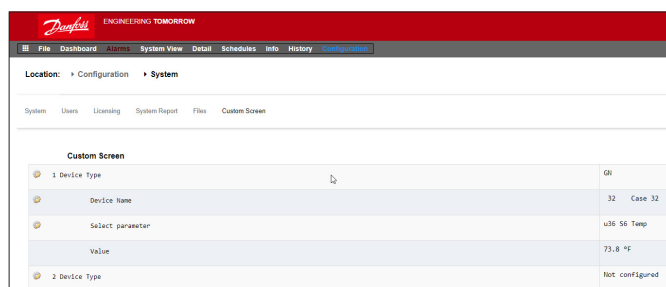

5.5 Configuration → Comm

The Comm (Communications) screen allows for IP network settings to be configured. Follow the question lines on the screen to configure your AK-SM 800A according to site requirements. Any changes in IP configuration must be followed by system initialization (performed by the 'press to initialize' line at the top of the screen).

The AK-SM 800A has two ethernet connections, eth(0) and eth(1). With software package R3.1 and above, eth(1) is enabled and is intended to support Danfoss Pack controller that uses IP for field bus communications.

Press to Initialize (Press/OK)

After any changes to settings on the Comm screen use the initialize function to perform an IP settings soft reset (unit itself will not reset).

Press to reset this unit (Press/OK)

To physically reset the SM 800A unit, press the OK button.

Ethernet 0 - Located inside of SM 800A and intended for corporate WAN/Host network.

Ethernet 1 - Intended for 'southbound' field bus communications (Danfoss Pack IP controller).

Internet (enable/disable - Yes/No)

Enable this to allow remote communications (StoreViewBrowser 5, StoreViewWeb..) to your AK-SM 800A.

Use HTTPS (enable/disable - Yes/No)

Recommended for secure communications between AK-SM 800A and remote connections. **Note:** by default port 443 is used.

Use Secure TLS (enable/disable - Yes/No)

By default will be enabled when selecting HTTPS. Disable for legacy Danfoss remote services.

Use Header Authentication (enable / disable – Yes/No)

New feature in Release 3.3 – see important note below

For enhanced 'Northbound' communications (i.e. cloud / enterprise) enable this function. By default, 'Use Header Authentication' action is disabled to avoid the breakage of existing XML connections.

Use DNS (enable/disable - Yes/No)

Select 'Yes' if a DNS service is to be used. Preferred host name can be subsequently configured.

Use DHCP (enable/disable - Yes/No)

Select 'enable / Yes' if AK-SM 800A is to be connected to a DHCP server. Select yes and manually enter the IP address that the AK-SM will use if DHCP fails.

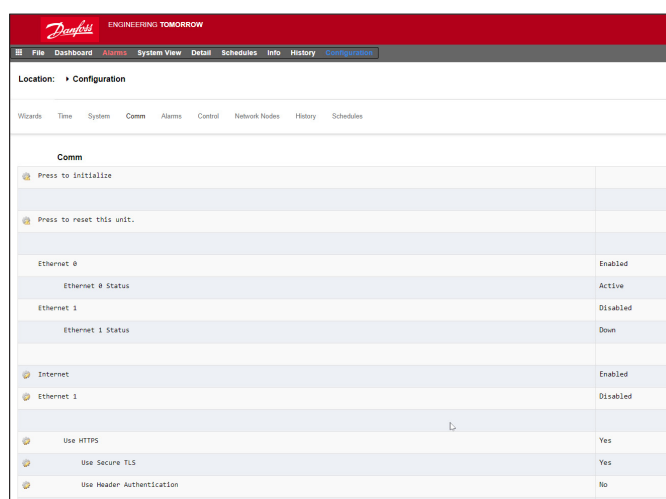

Important:

Consult with customer / 3rd party XML users before enabling this feature.

Note: By default, 'Use Header Authentication' is disabled to avoid the breakage of existing XML connections. If enabled, it will require current XML commands to be updated (all inbound XML communications must include user/password in header). Failure to do so will break existing XML communications.

Host Network (enable/disable - Yes/No)

Enable/Yes if your application will use more than one System Manager interconnected on a host (IP) network.

If enabled, enter number of units expected on host network Node to be used as – select Master for unit zero (as set by rotary address switch behind front panel cover) or 'Slave' for other units on host network (each unit must have different address switch addresses).

Slave IP address – enter the IP address for the slave(s).

Note: If the requirement is to access the AK-SM 800A host network over the Internet you must configure the # of Ext Internet and Internet web port settings (continue to read below).

5.6 Configuration → Security

Danfoss takes security seriously and as part of our continued improvements, new measures are being implemented. Please review below important security updates included in the latest AK-SM 800A software update that may impact your upgrade experience.

System Manager 800A software package v4.0x and above enhances your product's security features to meet internationally recognized regulations such as the NIS2 and CRA Directives. Also following the global standard IEC 62443-4-1 Standard in regard to security by design practices, and to comply to NIS2 and CRA European regulation requirements ([Danfoss keeps the focus on IT Security](#)).

In compliance with IT best practice and mandatory standards, Danfoss is now defaulting to a strong security posture on the System Manager 800A, via software package 4.0.x and above. This feature is called **Session Control** and when combined with HTTPS improves overall security of your product.

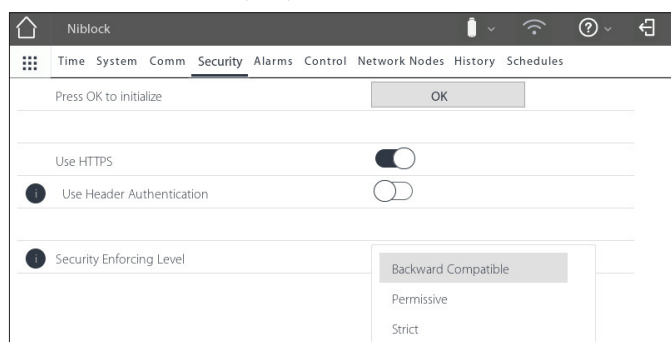

What is Session Control?

Session control in the AK-SM 800A is an authentication rules engine/module and is intended to improve the overall security posture of your system. Session control offers different configuration settings (Backward compatibility, Permissive and Strict). Depending on how these settings are configured, the remote interface will need to comply accordingly.

What is a remote Interface?

The term remote interface refers to StoreView Browser 5 (SvB5), StoreView Web (SvW), Alsense™ (Danfoss Digital services) and 3rd party XML1.0. SvB5, SvW and Alsense™ already support Session control. 3rd party XML1.0 users will need to update requests if Strict mode remains selected (see below).

What are these Session Control settings?

The important aspect to note is that immediately after installing System Manager 800A software package 4.0.x and above, Strict mode is set by default. These settings can always be managed via the System Manager Configuration → Security menu.

Session Control setting	Description
Backward Compatible	Not recommended but when selected, http is available, and no session tokens needed.
Permissive (used as a transition to strict level)	Set this level to view any error responses so that adjustments can be made in preparation for strict mode. Permissive is allowing both the old authentication and the new authentication scheme at the same time.
Strict (default immediately after R4.0 install)	Require HTTPS connection XML requests cannot contain usernames and passwords. Must provide session token in the AKSM-auth header. HTTPS becomes mandatory and authentication moves from plain-text to session-based authentication. Strict mode will sanitize all strings in the Northbound connection of XML, rejecting any commands that conflict with the sanitization.

After AK-SM 800A software package 4.0.x is installed, Strict mode is default, what does this mean?

- Your AK-SM 800A now requires secure Internet standard of HTTPS (encrypts all data in transit)
- In Strict mode, 3rd Party XML communications to the AK-SM 800A cannot contain usernames/passwords and must provide the session token in the AKSM-auth header
- For AK-SM 800A systems that have 3rd party XML interfaces, Danfoss has supporting documentation, please contact Danfoss Technical Support, [Salesforce "New Case Creation"](#).
- Depending on your method of upgrade a pop-up message will be presented, informing of Strict mode but also allowing fall back to Backward compatible
- Depending on your method of upgrade your remote browser session may be lost. In this event you may need to manually type https in front of your system managers IP/DNS name
- After the software installation you may revert back to (weaker configuration) by selecting 'Backward Compatible' mode – Danfoss recommends Strict mode.

Important installation notes for System Manager R4.0.x

Before upgrading to R4.0, take a moment to review your current implementation. For instance: check how your AK-SM 800A network is configured, are any 3rd Party XML entities involved?

After installation of System Manager software package 4.0x the unit will reboot and **will immediately default to Strict enforce level**.

Note: If you are uncertain about your AK-SM 800A's current configuration for web communications, we strongly recommend performing on-site update only or having personnel on-site or contact Danfoss Technical support for further guidance.

If your AK-SM 800A application is already configured for HTTPS, the remote update will not require any additional manual steps apart from confirming Strict mode.

If your AK-SM 800A application is configured for HTTP, there will be a workaround to support a remote update dependent on network setting (detailed guidelines will follow), but in case of any doubt an **on-site update is always recommended**.

5.7 Configuration → Alarms

The Alarms screen has a sub-set of screens; Connections, Service, Alarm Routing, Relays, System, Offline

Go through each sub tab to ensure all areas are correctly configured as per site requirements.

Connections (e-mail, remote, XML)

Define the number of connections (up to 4), then select the connection type. The AK-SM 800A can offer the following alarm IP based alarm output; e-mail, Remote (Danfoss Electronic delivered services) and XML.

Depending on your configuration the screen will reflect the required inputs in relation to your selection. Below is a description of alarm type

- Disabled = No alarms will activate on this point
- Log Only = When an alarm occurs on this alarm point it will only register in the AK-SM 800A alarm log - no physical alarm output
- Normal = When alarm is active the output will be sent once (alarm may get re-triggered if the stop condition is set for repeat)
- Severe = When alarm is active the output will re-send every xx min
- Critical = Same as Severe but with separate re-trigger time - when alarm is active the output will get re-sent every xx min
- Delete = Removes any applied alarm settings
- Select Alarm Action type (defined under Alarm routing) Auto Test: Scheduled: Configure days & time for test alarm Repeated: Configure interval time for test alarm
- Suspend alarms generation (suspend All alarms in the system from being sent): Set time period (min/Hrs) to stop alarms being sent
- Any relays configured for alarm output can be forced on / off for testing purposes.

Remember to leave in Auto position after testing.

Note: To ensure alarms are sent correctly, please ensure a schedule is configured. Failure to set a schedule will inhibit any alarm output.

Connection Type: e-mail

- Enter valid server name (or IP) for e-mail server
- Your AK-SM 800A supports SSL/TLS e-mail encryption standards, be sure to enter the relevant username and password
- Send to: Add the e-mail address for intended recipients
- Reply to: mandatory field that must have a valid entry (address with same domain name).
- An abbreviated message would have reduced text in the alarm message
- Configure a schedule to enable the alarm e-mail output

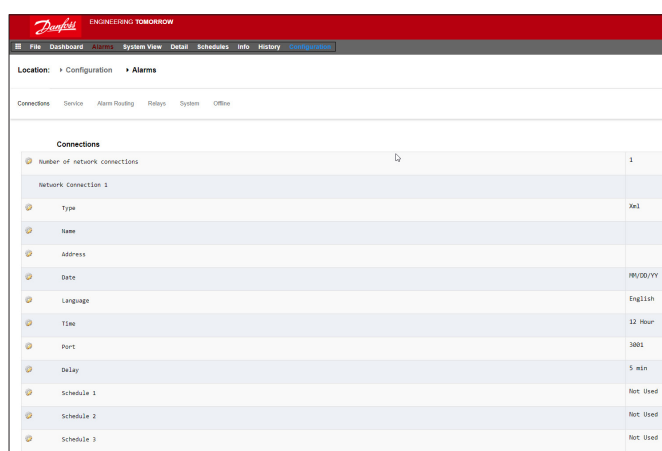
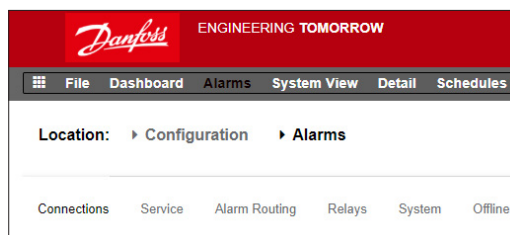

Connection type: Remote

- Use this option if the AK-SM 800A is subscribed to Alsense™

Connection type: XML

- Use this option if the AK-SM 800A is to send alarms to a 3rd party XML based service.

Service

The service tab is designed to allow test alarms to be generated. There is also an auto alarm test that can either be on a scheduled or repeated basis.

The suspension of alarm output is also possible, with user options of selecting the interval period

Clear alarm log will clear logs seen in the system.

Note: Under the utilities section of StoreView Browser 5, the cleared alarm log will maintain a full audit log of ALL cleared alarms, irrespective of the clear alarm log selection is made in the service screen.

Delete alarm configuration is available in the screen.

The AK-SM 800A internal relays can be configured per site requirements.

The line item AK(2) Generic Device – ‘Send alarm route clear’ is used, to clear the alarm route in ALL connected Ak2 controllers and is required if the AK2 controller was connected to another Danfoss system prior to getting connected to the AK-SM 800A series (i.e. AKA Gateway/SM720).

Change the parameter to YES and a scan will be initiated, the alarm route in AK2 will be reset, and your AK2 devcie(s) will now have valid alarm routing.

Alarm Routing

The AK-SM utilizes an Alarm Action Matrix that allows a high degree of flexibility for various alarm routing options. At the heart of the alarm configuration is the ‘Alarm Routing’ page, where different routing options can be defined, along with time delays and alarm output stop conditions.

The AK-SM utilizes an Alarm Action Matrix that allows a high degree of flexibility for various alarm routing options. At the heart of the alarm configuration is the ‘Alarm Routing’ page, where

different routing options can be defined, along with time delays and alarm output stop conditions.

The central alarm action matrix allows various output options (known as alarm actions) and alarm handling configuration to be centrally assigned. Once the alarm action matrix has been defined, any controller or I/O point can be given an alarm action number. The alarm action number corresponds to the appropriate output. (as defined in the alarm routing page). Alarm output options include:

- 5 external (AK I/O) relay outputs
- Local AK-SM buzzer
- Local AK-SM front LED
- Internal alarm relay
- 2 Network connections
- 6 IP / e-mail addresses (3 per alarm receiver)

The following example can be seen as a guide to configuring your AK-SM alarm logic options;

Relays

If the alarm output includes relay(s) the Relays tab should be accessed to configure the board & point address for these.

To configure an alarm action, navigate to the required output line (I.E. Relay A) and press enter. The resulting screen allows the configuration of the alarm actions, any pre delays, duration times and stop conditions. The results of this configuration will be shown in the alarm routing page.

Component Column (alarm output)
Select from the options seen in this column;

- Relay A-E
- Front LED
- Buzzer
- Int. Relay
- Network 1
- Network 2

Alarm Actions (1-8)
Up to 8 alarm actions can be defined. Each alarm action can have multiple outputs, making the AK-SM alarm output options very flexible. ‘Look down’ each alarm action number column and any associated outputs will be seen in the left hand column.

	1	2	3	4	5	6	7	8	Del	Dur	Stop
Relay A	-	-	-	-	-	-	-	-			
Relay B	-	-	-	-	-	-	-	-			
Relay C	-	-	-	-	-	-	-	-			
Relay D	-	-	-	-	-	-	-	-			
Relay E	-	-	-	-	-	-	-	-			
Front LED	-	-	-	-	-	-	-	-			
Buzzer	-	-	-	-	-	-	-	-			
Int. Relay	-	-	-	-	-	-	-	-			
Phone 1	-	-	-	-	-	-	-	-			

Delay
Once an alarm is defined the associated time delay for the action can be set. This delay is in addition to any delay already defined in any controller (i.e. EKC) or monitoring points (i.e. I/O) defined in the system.

Duration
A duration time is available when either Time or Time/Repeat are selected as stop conditions. The duration setting defines the length of time the alarm output will be active for (irrespective if the alarm is still active or acknowledged or not) Available in second or minute selections. 0 Sec/ Min duration will result in the alarm output remaining off. Min = 0 Sec/Min Max = 99 Sec/Min

Stop
The stop condition defines when the alarm output will stop or return to configured position. The following definitions apply;
Time = Stop on time (set under duration)
Ack = Stop on alarm being acknowledged
Clear = Stop when alarm clears
Time/Rep = Stop after time delay but repeat if alarm is still active
Ack/Rep = Stop after alarm is acknowledged. If alarm still active after acknowledge repeat alarm action (repeat

Alarm Actions (1-8)
Each alarm action can have multiple relays, IP address, etc assigned

Custom text that better reflects the alarm relays can be entered. Use the 'component name display' to toggle between custom text & factory name (Relay A, Relay B...).

Alarm output options
Select the appropriate 'component' (i.e relay, network) and configure by double clicking on the appropriate line.

Delays & Stop conditions Set pre delay, duration and stop conditions (for each alarm output selection).

Example configuration

This example will describe the steps to configure an alarm actions.

- Alarm action 1 will be defined according to the following;
- Relay A should trigger after a 10 second pre delay. This relay will energize any time and will only reset when the alarm clears.
- The Front LED should activate (de-activate LED when alarm clears)
- The Buzzer should only activate during the Day (Buzzer stops when alarm is Acknowledged)
- Alarm message should also be sent out via e-mail

This opens another page that allows the configuration for that output to be set. In the example below Relay A and the Buzzer can be seen. Follow the same process for the other outputs. For e-mail output, navigate to the Network 1 line and press enter.

Here, set the action, time delay & stop conditions. (The actual e-mail configuration is done in the Alarm 'Connections' page). The results of the alarm output configuration can be seen in the central Alarm Routing page. Follow this process for other actions.

To define the alarm output options navigate down the page and double click the relevant line.

The above alarm outputs are associated with action 1 - 'look down' the alarm action 1 column and the relevant outputs can be seen in the left of the page.

'Look down' Alarm action 1 column

Relay A Configuration page

Action settings:

Once in the actual output page, navigate through the lines and set the relevant Action. Each action can have the following settings;

Not Selected : No action

Enabled : Will enable this output action (any time of day)

Day : Enable this output during day status (based on store opening times (Configuration → Time)

Night : Enable this output during night status (based on time outside of store opening times (Configuration → Time)

Delay, Units & Stop settings:

To complete the output configuration set the time delay, units & stop conditions should be set. Stop conditions;

Time = Stop on time (set under duration)

Ack = Stop on alarm being acknowledged

Clear = Stop when alarm clears

Time/Rep = Stop after time delay but repeat if alarm is still active

Ack/Rep = Stop after alarm is acknowledged.
If alarm still active after acknowledge repeat

Relays

If the alarm output includes relay(s) the Relays tab should be accessed to configure the board & point address for these relays. The example below shows relay A & C, with the associated (AK I/O) board & point address.

Relays	
Sort by	Address
Relay A	Relay A
Address	01-1:1
Type	N-Open
Relay C	Relay C
Address	01-1:2
Type	N-Open

System

AK-SM system based alarm conditions should be set under the System tab. The alarms seen in this page are factory set but can be changed as per site requirements. Navigate down each line and configure (pressing the enter key) as required. The following items can be seen and changed under the System tab;

Host Comm error

Host count error

I/O Network Fail : Alarm if communications to AK I/O fails
Flash Memory fail: Alarm if AK-SM system memory fails
Database Cleared: Alarm if AK-SM database is cleared

File Error : Alarm if critical files do not load / not present on AK-SM system (I.E. Device list missing)

Alarm fail remote

Alarm fail e-mail

Alarm fail XML

Alarm if any active alarms were unable to be sent out

NTP Failure : Alarm if the network time protocol fails
Host Comm: Alarm If host communication fails

Host Count : Alarm if one or more AK-SM units disconnect from host network

Ram Disk Full : Alert alarm if Ram is getting full (due to EDF files)

Freq Response On

Ethernet Fail

Static IP fail

DHCP failure

Load level high

History collection failure

System	
Host Comm error	Normal
Action	1
Host count error	Normal
Action	1
I/O Network fail.	Normal
Action	1
Flash memory fail	Normal
Action	1
Database Cleared	Normal
Action	1
File Error	Normal
Action	1
Alarm Fail-Remote	Log Only
Alarm Fail-Email	Log Only
Alarm Fail-XML	Log Only
NTP Failure	Log Only
RAM disk full	Normal

5.8 Offline

If Controllers (Danfoss Evap & Pack, Power meters) and, I/O has been used in the control configuration (Lighting, HVAC, Refrigeration etc.), these devices can be seen under the I/O Comm tab.

The I/O Comm tab allows any offline communication alarms to be configured. The example below shows an evaporator controller (address 1) with the alarm level set to 'Normal' & alarm action '1'. These factory settings can be changed in this page.

Any AK I/O points used in the AK-SM system can be found on this page, with the associated alarm level and actions set. The factory settings can be changed as required.

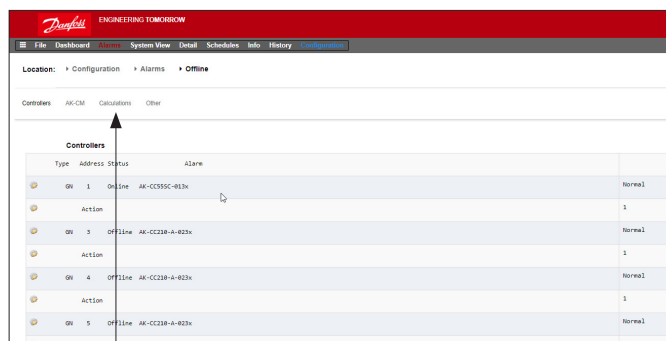

Calculations & Other

If any calculations have been defined in the AK-SM system, alarms can be associated with these. Use the Calculations tab to set appropriate alarm levels and actions.

5.9 Control tab

The control tab is the central configuration page for your control requirements. It lays out the different application areas and allows the Commissioning Engineer to define what applications are on site. Once the application areas are defined on this page, more detailed commissioning is done in the dedicated application tabs (covered in following section).

Please also note that the SM provides the ability to configure centralized or de-centralized control.

Centralized control is where your SM has the control logic built in and uses Danfoss I/O to provide refrigeration control. De-centralized is the control method via the use of Danfoss Pack and case controllers.

Note: depending on your license version, different applications may be visible (or not).

For de-centralized control, ensure the control type is set to your required controller type (via drop down menu).

For centralized control, ensure the control type is set to IO (input/Output). This alerts the SM that you wish to use Danfoss Board and Point configuration for your refrigeration application.



De-Centralized

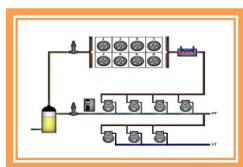

Pack & Case

Centralized

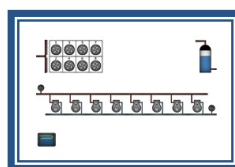

Rack I/O

Refrigeration	
Dewpoint method	Calc Dewpt
Humidity sensor to use	Inside RH 1
Number of racks/packs	1
Rack (A)	AK-I/O
2 stage system	No
No of suction groups	5
Condenser type	Air cooled

Control	
Name	Value
Show only scanned devices	No
Refrigeration	
Dewpoint method	Calc Dewpt
Humidity sensor to use	Inside RH 1
Number of racks/packs	1
Pack 1	AK-PC730-021x 080Z0118
Number of drives	0
Number of circuits	0

Show only scanned devices:

Select 'yes' if your controller devices are already on the network, with valid addresses and connected to the AK-SM. By setting to 'yes' and after a network scan (covered in next section) only discovered devices will be shown in the drop down boxes. If your controllers are not yet on the network, keep this selection to no.

Number of Racks / Packs (max 12):

Enter the required amount of suction groups.

Rack type

(Use I/O selection for centralized control, select controller type if using de-centralized)

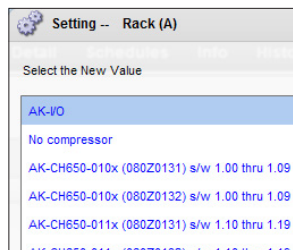

AK IO = built in control via AK I/O

No Compressor = No Compressor control

Device selection = select required controller

Note: Variable speed drive can be selected as a pack controller.

Suction groups (Suction group or Evaporator control)

Add your required quantity of suction groups (centralized logic) OR enter how many evaporator controls are available under your Pack (de-centralized)

Note: suction group / evap configuration is then done under the Refrigeration tab.

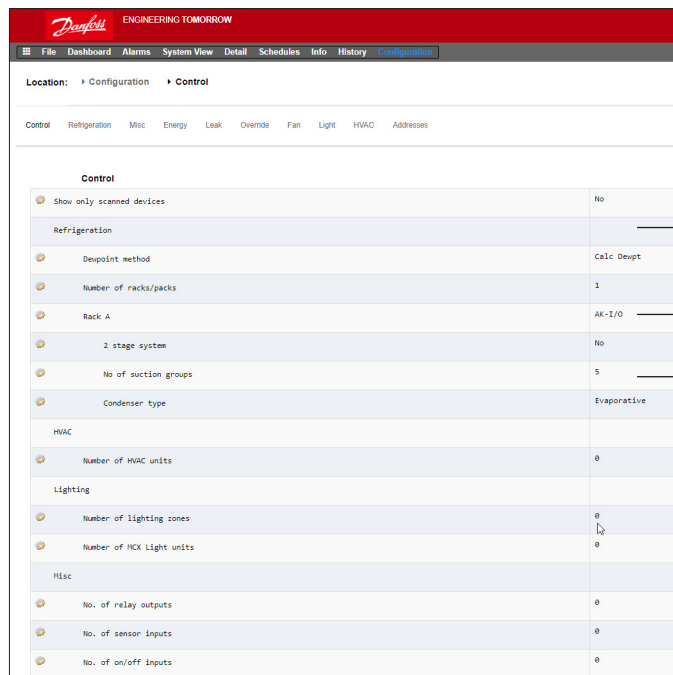

User Guide | AK-System Manager, AK-SM 800A series

The following screen shots below represent an example of de-centralized configuration (Pack and Case control).

The AK-SM has been configured for two pack controllers (AK-PC 730 and the AK-PC 840), with 5 Evaporator controllers under each pack. Selection for each Pack controller was made via the pop up box that appears when the Rack line is double clicked.

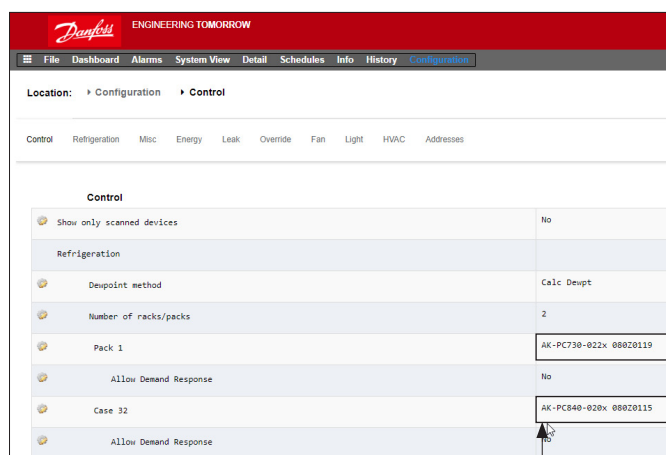

Double click to select your required Pack device.

Once the Pack controllers have been defined and the number of case controllers under each pack have been set, continue to the Refrigeration tab for detailed configuration.

First, navigate to the 'Address' tab. Enter a valid network address, corresponding to the address already set in the field controllers.

Note: If your field controllers have already been configured with the relevant parameters set, you may wish to perform an 'Upload'.

This function forces the AK-SM to pull back the controller settings and thus synchronize the AK-SM database. Only use the 'Download' function if you have finished controller configuration on the AK-SM and you wish then to send these settings 'down' to the controller.

A one click option for this (upload/download) can be found under the Configuration → Network Nodes tab.

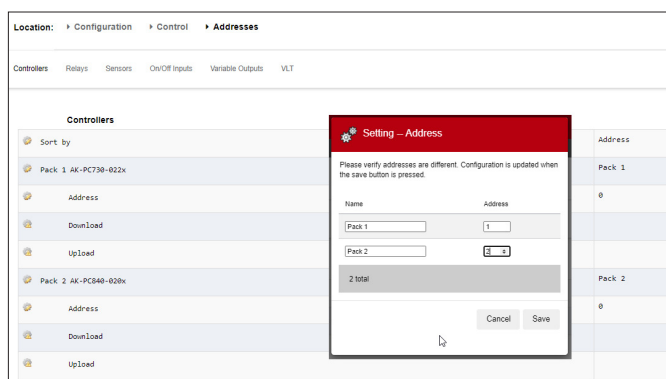
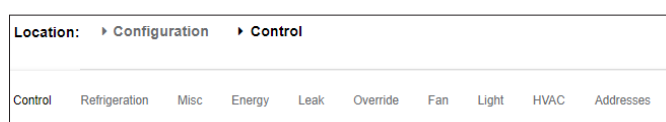

Once all the addresses and custom naming is complete escape out of the addresses menu and navigate to the 'Suction' tab. This will allow for configuration of the Pack Controller(s). Use the drop down (Suction) menu to access each Pack controller and the corresponding menus. Please note that any online controller devices will invoke a dialog box which asks if you wish to retrieve the data from this controller. This dialog box is intended to direct the choice of either uploading data from a controller (overwriting any previous settings held in the AK-SM database) or not. If you have existing controllers on the network which have already been configured, choose the upload option (this need only be done once for each controller you view).

The AK-SM holds a database in which all the system configuration is held. This includes any actual controller devices connected or just devices that have been selected ready for configuration. It is important to recognize when to perform an upload or download function so that any preset configuration is not overwritten by automatic upload by the AK-SM.

Upload

This function may be required where the case and pack controllers have already been configured and all parameters are set according to customer specifications. In this instance the need is to typically perform an upload function, thus updating the AK-SM database to fully reflect the controllers commissioned settings. Once this has been done, changes to the controller settings can be done directly from the AK-SM.

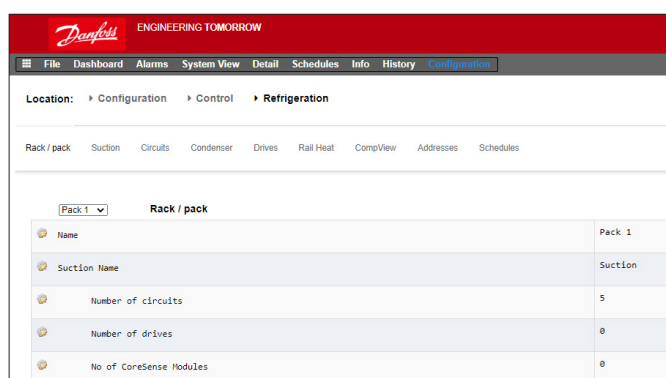
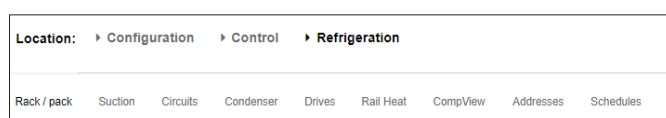

Download

The opposite to this would be where the controller devices have not been set per customer specification and the AK-SM should be used as the commissioning tool or window into the controllers. By navigating through all the controller screens in the AK-SM it is possible to configure the controller parameters and then send

these setting to the connected controllers via the download function.

- Controller must be online
- Some controller types require the main switch (R12 parameter) to be off before certain changes can be made

Copy function

To aid the commissioning process, the AK-SM offers a settings copy function which can be used to copy one device settings and alarm configuration to other (similar) device(s). This function works when copying settings to and from same controller version / type devices. The procedure described below is one example of the copy /paste function.

Use the Copy tab to open the copy page, where any same controller type devices can be copied to. The actual device page will act as the copy base, so ensure the correct circuit is selected (in the drop down list). Select **all** or **individual** controllers that will be copied to, then press the copy to line.

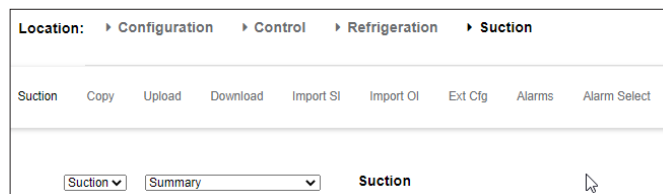

Note: the copy function copies controller parameters etc from once device to the AK-SM database, to complete the operation the (copied) settings need to be downloaded to the required controllers.

The Global download function can be seen under the Network Nodes → Download section.

Import SI | OI function

Use the **Import SI (Sensor Input)** and **Import OI (On/Off)** function to gain access to 'generic' controller (Evap & Pack) parameters that are normally not accessible for alarm / logging / Boolean use. This function can be used to alarm on specific parameters not in the factory alarm list and / or can be used to import controller parameters in the Boolean logic calculator. Up to sixteen points can be selected per controller. This function extends the flexibility of controller support in the AK-SM and opens up the generic controllers parameter list for more customer specific needs. The following steps highlight the procedure in 'Importing'.

From the import page(s) double click an import line to present a pop up box that shows all available parameters. Select the parameter that you wish to 'import' from the controller (you may give it a custom name).

In the example below, the parameter Po Setpoint has been selected. This parameter can now be seen in the miscellaneous calculator.

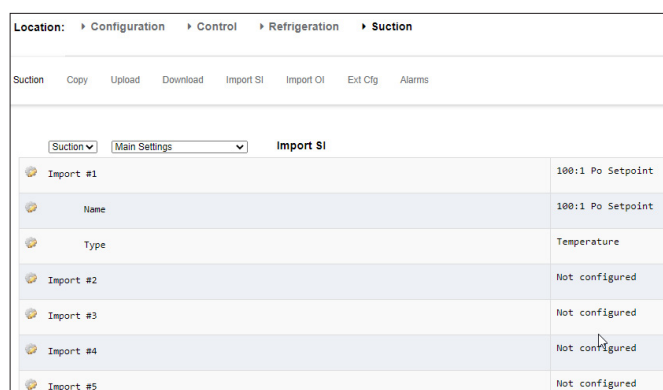

Important note:

Dependent on the load of the system it can take up to a minute, before the imported value can used in e.g. a calculation for further use.

If the import of a value is basis for a secure operation we strongly recommend to find other ways to secure the system.

Extended Config function

Extended configuration (changing what parameter is seen in the System View, Dashboard & Device detail status) Using the extended configuration tab the factory standard parameter that is used for 'System View' status can be changed. This feature is useful in giving the end user more flexibility in showing the relevant sensor at the system and device detail views. By changing the overview value the AK-SM will then display the new selected parameter or status in the system view, Dashboard and device detail pages.

Alarms and Alarm Select

Use the Alarm tab to define the alarm actions associated with this device. Use the Alarm select tab to select up to 300 alarm points (max 300 per AK-PC controller)

5.10 Configuration → Network Nodes

If your application already has controllers and/or I/O modules set and powered, you may wish to perform a network scan to validate their connection to the AK-SM. Follow this section to perform a network scan.

From the Configuration tab select the 'Network Nodes' sub-tab. When your field network is complete, and all controllers are on line a network scan can be initiated. The operation of a network scan allows the AK-SM to be aware of any controller devices on the network, allowing the AK-SM to communicate and function with the controllers on the field bus.

Node Overview

Under Node Overview your network 'type' can be selected, and subsequent scanning of the field bus can be initiated.

Modbus configuration (new enhancements from s/w package 3.2.x and above)

System Manager software package 3.2.5 and above includes improvements for managing serial Modbus devices, in particular the following updates can be seen:

- Ability to define Modbus (Channels 1 & 2) node address scan ranges – this will improve scan efficiency time, rather than the previous default full Modbus address range (1 – 199), you may specify an address range specific to the controls installed on the Modbus channel.
- Ability to use Modbus#2 for 3rd party Refrigeration and utility controls (Non Danfoss).

Modbus channel 2 enables additional device connectivity via the support of non-Danfoss Modbus controls, commonly known as 3rd party. This is done via user configurable Modbus configuration 'slots', where each 'slot' may represent Modbus device type(s). Once configured and the relevant device file (EDF) has been loaded via StoreView Web, it is possible to establish Modbus communications and show device parameters in the AK-SM 800A.

Notes:

1. Due to the varying implementation of Modbus Protocol in different devices seen in the market, it may not be possible to support all 3rd party devices or parameters. At time of writing Refrigeration and utility meter types are supported
2. At this time, creation of 3rd party Modbus device file(s) is managed by Danfoss ECS Technical support – please contact ADAP-KOOL support concerning 3rd party topic <https://danfoss.lightning.force.com>
3. Modbus channel 1 is designed for Danfoss only (including existing 3rd party devices built into AK-SM 800A firmware).
4. Danfoss Modbus devices support and default to autobaud rate detection. This presents a challenge when trying to mix other devices that need to operate on fixed baud rates.

Rule: Danfoss Modbus controls should only be mixed with 3rd party devices on Modbus#2 if all 3rd party devices can be configured to the same Modbus properties.

All 3rd party devices must be set to either, 9600|even|8|200¹⁾, 19200|even|8|200¹⁾ or 38400|even|8|200¹⁾. If the 3rd party device cannot support these settings Danfoss controls should not be placed on Modbus#2.

You may have differing 3rd party device configurations (i.e. baud rates) without Danfoss controls ONLY IF those devices do not use auto-baudrate switching.

¹⁾You may modify the timeout property (keeping other properties the same) if your 3rd party Modbus device requires slower response time.

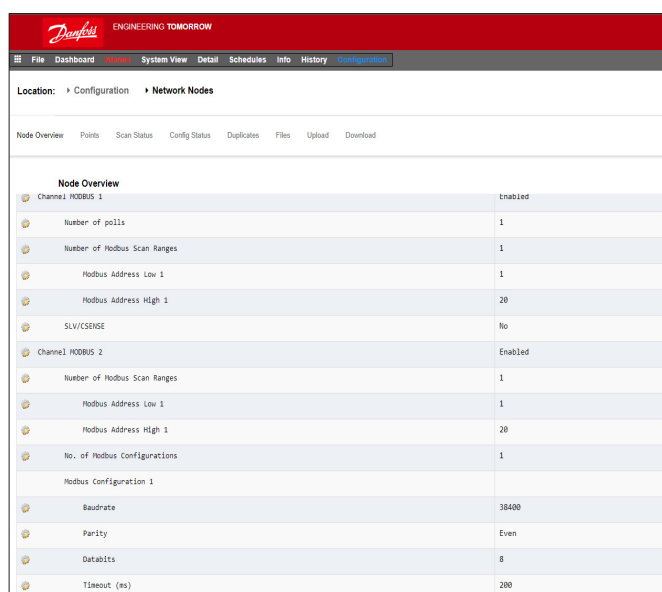
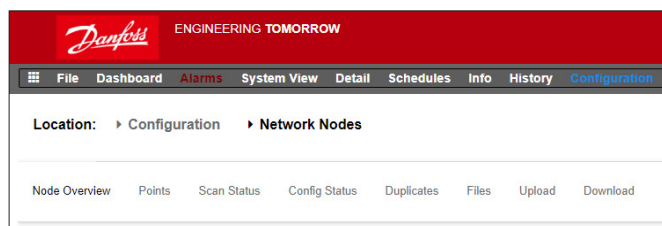

Note: do not initiate a network scan via this screen and in parallel start the layout wizard (which would set an additional scan process). If scanning for network nodes either use this screen or the layout wizard - not both concurrently.

Example A: Modbus configuration (Danfoss + 3rd party on Modbus#2)

In the below example the AK-SM 800A (running R3.2) has been configured to communicate with Danfoss and 3rd party devices. Both Modbus 1 and 2 have been enabled with appropriate scan ranges to ensure efficient scan performance – see below table.

This example shows the AK-SM 800A configured for 150 case controls, using Modbus channels 1 & 2

- Modbus channel 1 has 120 Danfoss controls
- Modbus channel 2 has 20 Danfoss evap devices + 10 3rd party
- Totalling 150

Serial Modbus devices	Unique control device address range	# Modbus configurations
Modbus channel 1 (Danfoss)	1 – 120	n/a
Modbus channel 2 (Danfoss + 3 rd party)	130 – 160	1

Modbus#1 Configuration

As Modbus 1 is used exclusively for Danfoss controls there is no configuration needed, except if required, to adjust the address range for the Modbus scan as noted in table. In this example there are 120 controls, with address range 1 – 120. As a result, the scan address range can be set to 1 – 120 as indicated in the image below.

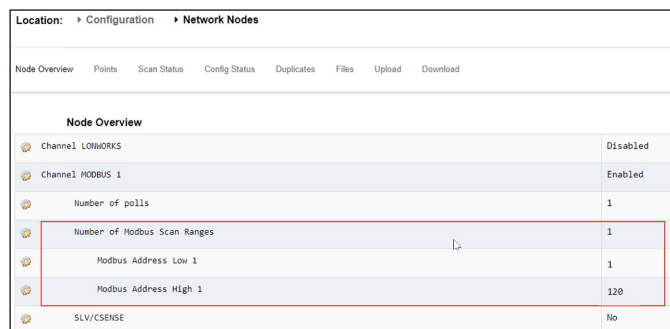

Modbus#2

As Modbus 2 is used for Danfoss and 3rd party controls, some configuration is needed (in addition to the scan range configuration if required). In this example it is assumed that the 3rd party device file has previously been loaded into the AK-SM 800A via StoreView Web and the AK-SM 800A unit was re-set to auto populate the internal device file table. This example also assumes that the 3rd party devices have the ability to set Modbus properties (i.e. baud rate etc) to comply with 'note 4' and are set to match the max speed default in Danfoss AKC and AK-CC evaporator controllers.

Each red box indicates required configuration:

1. Configure scan range (in this example 130 – 160).
2. As there are two device types on Modbus channel 2 (Danfoss & 3rd party) but they share the same Modbus configuration profile (i.e. baud rates) this is set to 1.
3. Configuration 1 is set for Danfoss and 3rd party controls (38400|Even|8|200).

Note: Currently, Danfoss AK-RC 2xx, 3xx (Optyma™ room controllers) are compatible only on Modbus#1.

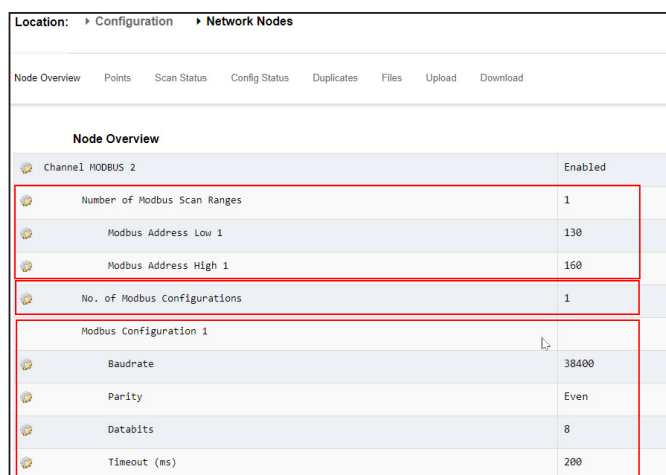

Scan, detect and map

After configuring the Modbus channels, initiate a rescan and observe controls being detected via the Configuration → Network Nodes → Node overview table.

From the Node overview screen, navigate to the Configuration → Network Nodes → Scan Status and then → Controllers screen. Here you will see all scanned generic devices, including 3rd party. **An important note is that this screen may reflect your 3rd party device as a model type other than expected.** It is common that 3rd party controls do not declare what device type they are during a scan so initially the AK-SM 800A makes a 'best guess'. The (unique) network address will be the key identifier, from which to locate the 3rd party device(s).

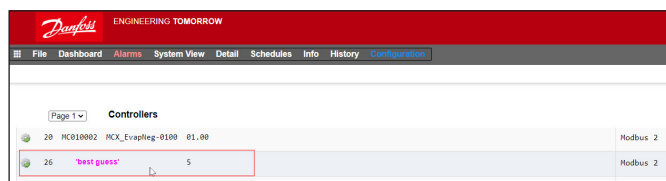

To correct this device model type, double click the associated gear icon or press the '>' on local screen. The resulting > Device Type screen will then allow the correct device file association via a drop-down list.

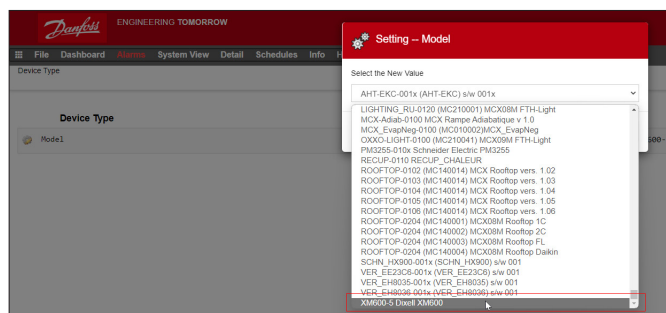

After selecting the correct device file from the drop-down menu, the controller will correctly reflect model type and can be seen as a generic device in the AK-SM 800A.

Example B: Modbus configuration (two 3rd party device types on Modbus#2)

In the below example the AK-SM 800A (running R3.2) has been configured to communicate with Danfoss and 3rd party devices. In this example two different 3rd party device types are installed on Modbus#2 and because they have differing Modbus profiles (Baud rates etc) have 2 configurations and Danfoss controls are not installed on Modbus#2.

Both Modbus 1 and 2 have been enabled with appropriate scan ranges to ensure efficient scan performance – see below table.

This example shows the AK-SM 800A configured for 150 case controls, using Modbus channels 1 & 2

- Modbus channel 1 has 120 Danfoss controls
- Modbus channel 2 has 30 3rd party devices (two types)
- Totalling 150

Serial Modbus devices	Unique control device address range	# Modbus configurations
Modbus channel 1 (Danfoss)	1 – 120	n/a
Modbus channel 2 (3 rd party, two types)	130 – 150	2

Modbus#1 Configuration

Refer to example 1, no change in this configuration.

Modbus#2

As Modbus 2 is used exclusively for 3rd party controls, some configuration is needed (in addition to the scan range configuration if required). In this example it is assumed that the 3rd party device files have previously been loaded into the AK-SM 800A via StoreView Web and the AK-SM 800A unit was re-set to auto populate the internal device file table. This example assumes that the two 3rd party devices have differing Modbus properties (i.e. baud rate etc) and so to comply with note 4 Danfoss controls are not installed on this channel.

Each red box indicates required configuration:

1. Configure scan range (in this example 130 – 150).
2. As there are two 3rd party device types on Modbus channel 2 and each have differing Modbus profiles, 2 configurations are set.
3. Configuration 1 is set for 3rd party control type 1 (38400|Even|8|200).
4. Configuration 2 is set for 3rd party control type 2 (19200|Even|8|175).

Channel MODBUS 2		Enabled
Number of Modbus Scan Ranges		1
Modbus Address Low 1		130
Modbus Address High 1		150
No. of Modbus Configurations		2
Modbus Configuration 1		
Baudrate	38400	
Parity	Even	
Databits	8	
Timeout (ms)	200	
Modbus Configuration 2		
Baudrate	19200	
Parity	Even	
Databits	8	
Timeout (ms)	175	

Scan, detect and map

The remaining steps are common with the previous example.

Points

Under the Points menu, sub tabs of Relay, Sensors, On/Off Inputs and Variable Outputs will be shown. This tab relates to any AK I/O configured points, the term points relates to AK I/O relay, sensors, On/Off Inputs and variable outputs. Any control questions that have required AK I/O control will be seen in these tabs. The purpose of these tabs is to allow the viewing of the I/O point status.

Scan Status

Under the scan status menu, sub tabs of All nodes, Controllers, I/O Boards and Other Nodes will be seen. Use these screens to check that your expected devices or I/O are seen and listed as expected.

All Nodes : Central list will display configured devices and points. Only configured controllers will be visible in this list.

Controllers : To view any scanned generic controllers. This screen will also reflect address and controller type

I/O Boards : Display AK Board & Point status.

Other Nodes : List of other nodes

Config Status

A list of nodes that reflect address, status (online / offline) and model type.

Duplicates Tab

Check this list to make sure no two devices have been assigned the same network address. Any duplicate address will be shown in this list. Correct any address issues and re-scan.

Files

Under the Files menu, sub tabs of Device Files, Device Management and MCX Upgrade will be seen. Use these screens

Device Files : A complete list of EDF files

Device Management : Groups of same device type

MCX Upgrade :

Upload Tab

The upload tab will list any controllers that have been uploaded. The upload function can be performed in the **Configuration** → **Control** area (one controller at a time) or here (multiple devices with one command). The process of an upload takes the current parameter settings and values from the controller(s) and loads them into the AK-SM database. This operation ensures that the AK-SM database is synchronized with any pre-configured controllers on the control network. Any upload failure will be shown on this screen, else a time / date stamp will be shown when successful.

Download Tab

The download tab will list any controllers that have been processed for download (where the AK-SM sends parameter data to the device). The download function can be performed individually under the **Configuration** → **Control** page or here, where multiple controllers can be selected for download (using one command). The process of a download takes the AK-SM database values and downloads them to the selected controller(s). Any upload failure will be shown on this screen, else a time/date stamp will be shown.

After the network scan has completed, any resulting count will be seen against the Nodes Scanned on Network line - this reflects the number of found nodes on the scan just completed. The corresponding line below (Nodes configured in database) reflects the current total of network nodes actually configured in the AK-SM database.

The last group in this table refers to the following node types:

- OI (Output|Input)
- RO (Relay output)

- SI (Sensor Input)
- V02 (Variable output)
- Utility Meter (WattNode, Veris, Carlo Gavazzi)
- Generic (Danfoss case / pack controllers)
- AK-CM (AK- Communication Modules) Calculations

Each node (type) has a column that reflects any configured or scanned status.

5.11 Suspend Polling function (Network Nodes)

The new 'suspend polling' function can be found in AK-SM 800A release R4.1. It is designed to assist in the commissioning process of generic field bus devices (i.e. Case, Pack controllers), specifically where a previous (offline configured) AK-SM 800A database can be imported to a target (Online) AK-SM 800A unit without concern that the field bus polling will overwrite the original configured settings. This feature is designed for Danfoss field bus devices (e.g. AK-CC55, AK-CC550, etc.) and improves support for using previously configured AK-SM 800A databases for onsite commissioning

Polling is the automatic function of the AK-SM 800A communicating with configured southbound devices, where the AK-SM 800A will retrieve parametric data from the controls (settings/values..) and updates the AK-SM 800A database.

The use case below describes typical usage expectations and how the new suspend polling feature aids in the commissioning process, by improved support for pre-programming on an offline AK-SM 800A unit.

Use Case

"As a commissioning Eng I want to pre-program a customer application database via my home/office AK-SM 800A unit. The home/office unit is not physically connected to any devices, however, I still can pre-program as the AK-SM 800A has the built in device files. Of particular interest is the programming of settings for generic field bus devices (i.e. case controls). After programming settings for the controls, I save the database to USB flash drive. I then travel to site where I expect an AK-SM 800A to be mounted and associated devices available on the southbound network. I expect to update the site AK-SM 800A to the latest firmware and to load my previously saved database. I will expect to perform a network scan (discover the devices) and then to 'download' my settings previously made and contained within the database to the live southbound devices".

Step 1: Home/Office Unit

1. Disable Generic Device Write Errors (Config → System)
2. Configure 800A unit to match expected site unit configuration/ device settings etc (i.e. Network channels, # of controllers, controller type, controller settings...)

How to use the suspend polling function

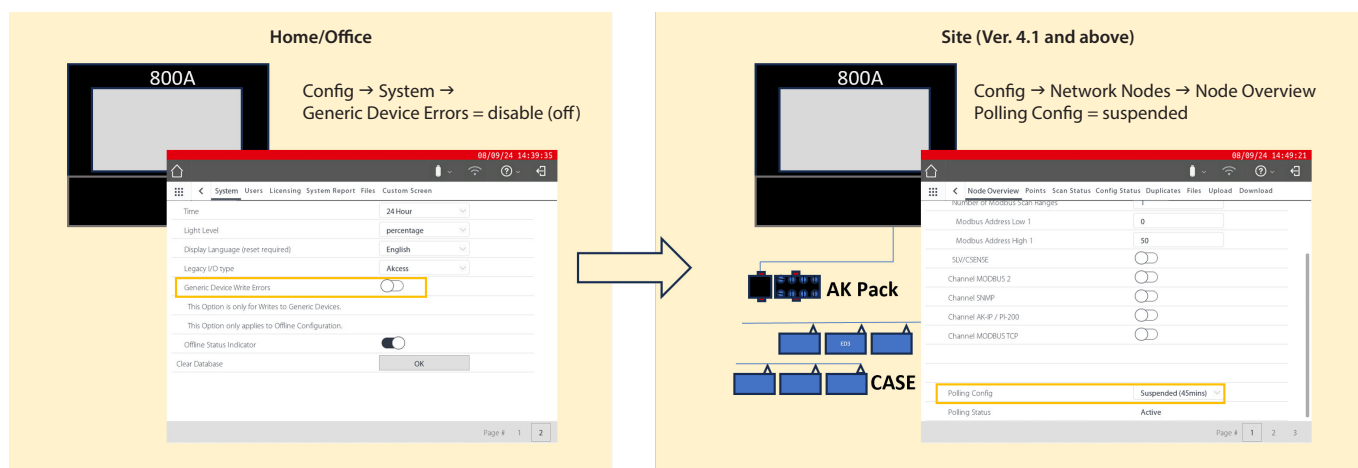

- Disable Generic Device Write Errors (Config → System)
- Configure system per site requirements
 - Field bus channels, Devices, addresses, device settings
 - Main Switch of controllers¹⁾
- Force an internal database refresh by soft resetting the unit
- (Config → Comm → **'Press to reset unit'**)
- Save (export) database to USB

- Polling Configuration suspended
- Load (import) database
- **Allow unit to complete network scan** (if configured in DB or manually scan to detect devices)
- Download settings to controllers
- Resume polling

¹⁾ The following assumes you have a home/office 'offline' 800A where you wish to pre-program device settings, save the DB and load into the site unit.

Note: Pay special attention to controller main switch state, as this will be reflected in the site unit post download sequence. I.E. if you have the device(s) main switch to OFF then the 'site unit' post Download step will keep the device in OFF mode!

3. To ensure your configuration settings are fully updated to the database, force a database update by initiating a soft reset (re-boot). This can be done via Config → Comm and using the **press to reset unit function (do not power cycle the unit!)**
4. Save 800A DB to USB or .dpk file via remote UI (SvW / SvB5)

Step 2: Site Unit (Ver. 4.1 and above)

1. Suspend polling (Configuration → Network Nodes → Node Overview)
2. Import home/office 800A DB (USB/.dpk), unit will reboot as part of this process
3. Network rescan (if set to do so) or manually perform network scan – allow to complete
4. Use download function to 'push' settings from configured DB to live devices on field bus
5. After download, resume polling (pop up message will prompt you-local screen only), else after time elapse (45 min) polling will resume automatically.

Feature notes:

- New suspend function found in Config → Network Nodes → Node Overview screen
- New suspend function set to default as 'disabled' (i.e Polling is enabled!)
- Fixed 45 min suspension (unless user stops after pop-up prompt-local screen only), then auto polling resumes automatically
- Even after initial download of settings a Pop-up message offers the user the ability to re-start polling, the user can decline and make additional setting changes without fear of polling starting (until timer elapses)- thus giving user option to resume polling or not
- All user actions associated with this new function is recorded in Audit trail
- During polling suspension, a persistent (flashing) message is shown to inform the user (local screen)
- **During polling suspension (because the 800A is not retrieving live data from the controllers) alarms will not be able to be processed, nor history collection. Upon polling re-start, alarm conditions from controllers will then function as normal**
- **Always check you application and system configuration prior to leaving site, ensuring alarms and full communication to all devices are active**

5.12 Configuration → History (Inc HACCP points)

The AK-SM history section allows the collection and recording of control parameters, values and status. The central history function allows up to 3000 points (plus an additional 200 for HACCP logging) to be configured, a point being a temperature, pressure, status, relay, etc. The collection of history allows further analysis using the AK-SM or remote web browser, where a graphical representation of this data can be made.

To configure history, navigate to the Setup tab (**Configuration → History**).

The following setup lines are visible:

Auto Configure History: Use this function to auto select typical points needed for logging (the AK-SM will select key points in the Refrigeration, HVAC, Lighting and Misc control areas. Manual configuration can be done to override these selections or add more as required.

Clear History Configuration: Use this function to clear history configuration (points selected for history & the frequency of samples).

Clear History log: Use this function to clear stored history in the AK-SM.

Start / Suspend History: Once the relevant points have been selected for history collection (using either the Auto history, manual or a combination of both) press this line to Start the collection. Press again to Stop collection.

Status: Displays the current status of history collection.



A change of the log interval will delete all previous logs of that chosen data point.



Note: Ensure the correct time & date are set in the AK-SM. Make sure the history collection function is running to ensure the collection of datapoints. Use the 'Start History' line and check that the status reflects 'Collecting'. When assigning history points to a controller device a recommended max of 45 points per device is allowed. Assigning more than 45 history points per device will cause points to not be recorded in the history log.

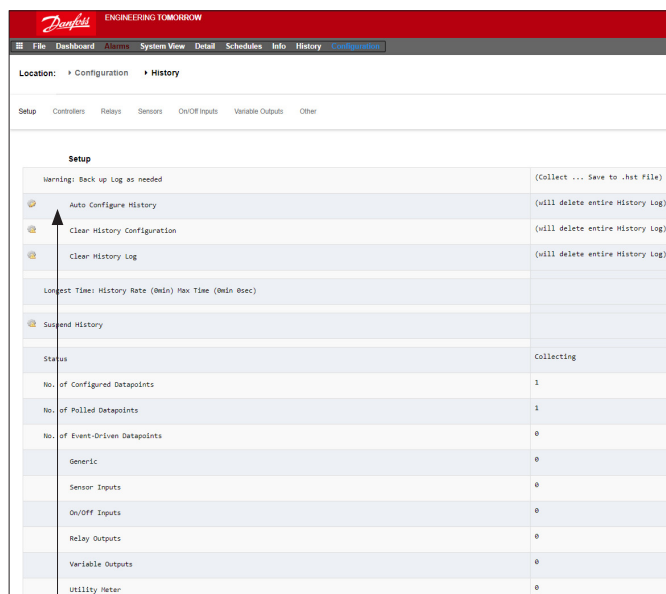

Auto Configure History

When selecting the auto configure history function the AK-SM presents the option to select the history collection sample rate. These can be later changed & modified under the relevant history device type (Controllers/Relays/ Sensors/On/Off/Variable/Other).

5.13 Configuration → History

Controllers

If any controllers are configured for history collection, these can be seen in the ‘Controllers’ tab. The example below shows a evaporator controller with the various control groups accessible via a drop down menu. Any auto history settings will be seen in these controller group lists, manual configuration of any parameter can be done in this page.

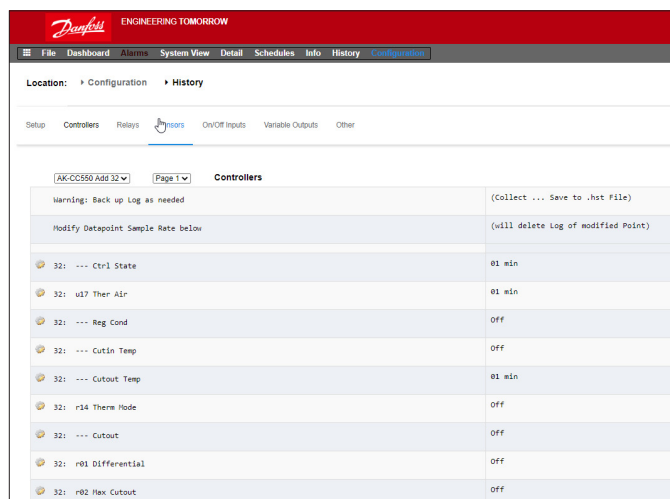

Navigate and select appropriate points for history collection, via the drop down menu selector. Double click a required line, a pop up selection box allows the choice of sample rates:

- 1, 2, 5, 10, 15, 30 mins
- 1, 2, 6, 24 Hours

It is not recommended to define more than a maximum of 100 log points per field bus controller with intervals at 1 minute or lower. Exceeding the field bus capacity will cause data to be collected at a slower rate than what is selected in this configuration screen.

Using longer intervals will extend the duration of which the history logs are stored in the unit.

Relays, Sensors, On/Off Inputs, Variable Outputs & other

Depending on the defined control criteria, other points may be viewed and modified under the respective tabs.

The SM 800A has a total of 3000 standard history points. These points are categorized into two ‘styles’ of history collection.

Polled (1000 points), is where the SM 800A when configured will capture the history point at the configured rate of collection. Example: collect air temp every 1 min.

Event Driven (2000 points), is where the user makes a change to a parameter and if configured to event history the user change will be captured and recorded. Example: Main switch parameter is configured in history as event driven. When the user changes this (say from on to off) – this event is captured in history.

Note: Event-driven are only applicable for generic controls not I/O.

HACCP (200 points), is where the user selects a parameter as a HACCP point and every 15 min a sample is captured (fixed).

Chapter 6: Master Control Functions

(Energy saving features, scheduling and load shedding configuration)

This section will discuss rail heat control, schedules, HVAC, and lighting. Please refer to this section when configuring more advanced areas of your AK-SM.

6.1 Rail Heat

The AK-SM can be used to manage the energy output to the case trim heaters (Rail Heat). There are different ways to approach the solution to rail heat control, listed below are three main possibilities.

1. Use a Night Setback Schedule

Many Danfoss controls have a function whereby the output to the rail heat elements can be pulsed in a percentage of time ratio. If set in the controller, the night setback signal from the AK-SM will allow the controller to vary the output depending on the time period. Consult specific controller manual for more details.

2. Use AK I/O relays to control rail heater connections

(using 'Calculated' or physical Dew point)
By means of utilizing temperature and relative humidity sensors the AK-SM can calculate the relative Dew point. Based on this Dew point reference and against a set point the output to the rail heat elements can be controlled. This represents 'tighter' control based on the calculated Dew point.

3. Use Adaptive Rail heat control

Adaptive rail heat is a feature that groups together a collection of compatible evaporator controllers that receive signals of the current calculated dew point from an installed dew point / temperature sensor. The installed humidity / temperature sensor connects to the AK-SM (via I/O) and the resulting calculated dew point value is sent to the connected evaporator controllers.

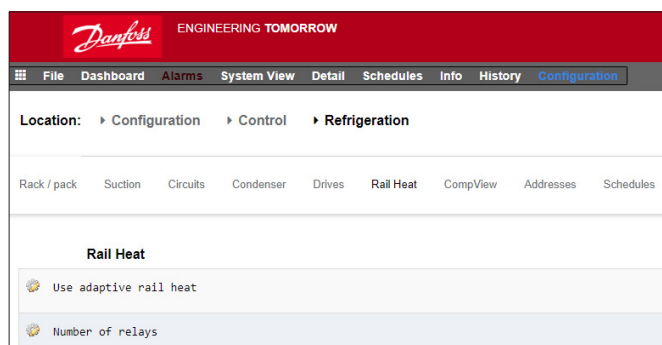

From the Control screen navigate to Refrigeration then Rail Heat (Configuration → Refrigeration → Rail Heat).

AK I/O relay method

Select 'No' to the question line 'Use Adaptive Rail heat'. Define how many relays will be used in the control of the rail heat elements (max 30).

Cycle time: Used to determine what amount of time the relays are energized, used in combination with the output percentage as set in the Dew point setpoint.

Dewpoint method:

- Calculated dewpoint (Using a combined temperature / humidity sensor - type: EMHS3-1 is recommended. See below for wiring example)
- Dewpoint (Utilize direct output from dewpoint sensor)

Selecting Use HVAC humidity to "yes" Rail heat dew point will be calculated using Rail Temp and Inside RH sensor inputs. A Rail hum point will not be generated by the SM800.

Selecting Use HVAC humidity to "no" Rail heat dew point will be calculated using Rail Temp and Rail hum sensor inputs.

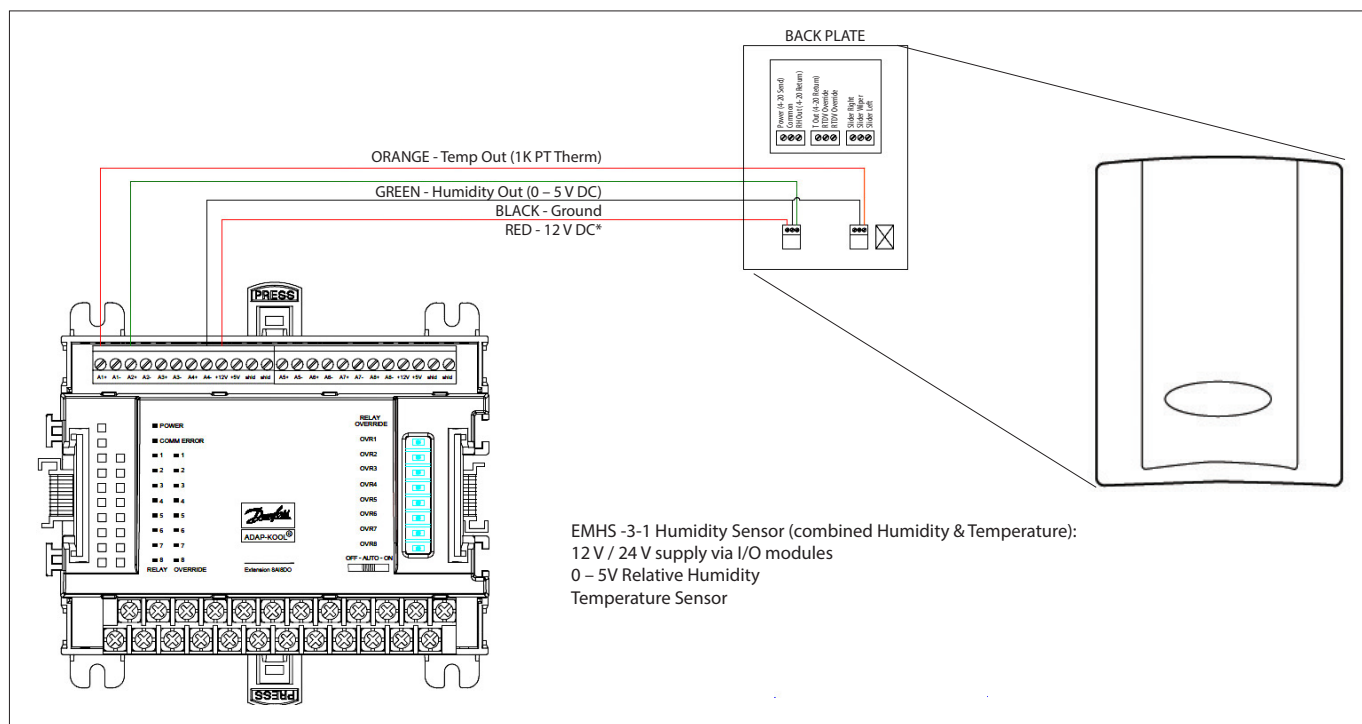

Location: Configuration Control Refrigeration	
Rack Suction Circuits Condenser Drives Rail Heat Addresses Schedules	
Rail Heat	
Name	Value
Use adaptive rail heat	No
Number of relays	1
Cycle Time	1 min
Dewpoint method	Calc Dewpt
Use HVAC humidity	No
Rail Heat 1 Dewpoint >	8.0 °C
Rail Heat 1 Dewpoint <	-4.0 °C
Rail Heat 1 Duty Cycle >	100 %
Rail Heat 1 Duty Cycle <	0 %

Example: With a Dew point target range of -4.0 – 8.0 °C and the Cycle time set for 10 minutes the following behavior will be true.

- At -4.0 °C : Dewpoint the relay output will be 0%
- At 8.0 °C : Dewpoint the relay output will be 100%
- At 2.0 °C : Dewpoint the relay output will be 50% of the cycle time (5 mins on, 5 mins off)
- At 7.0 °C : Dewpoint the relay output will be 90% of the cycle time (9 mins on, 1 min off)

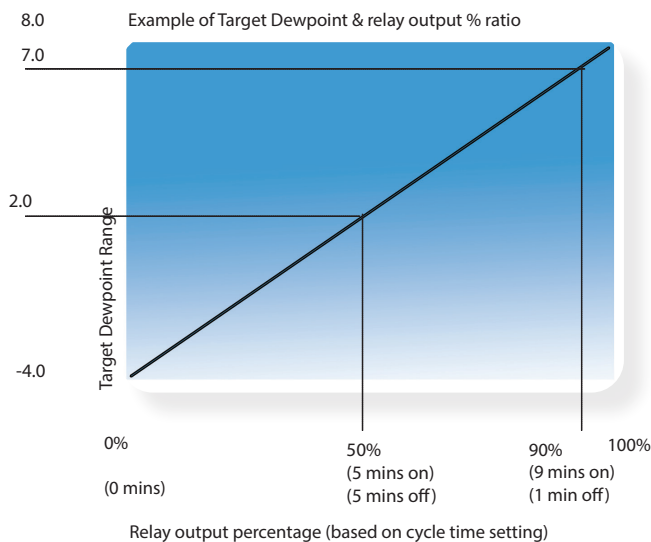

Adaptive method (with compatible Danfoss evaporator controllers)

Adaptive rail heat is a feature that groups together a collection of compatible evaporator controllers that receive signals of the current calculated dew point from an installed dew point / temperature sensor. The installed humidity / temperature sensor connects to the AK-SM (via I/O) and the resulting calculated dew point value is sent to the connected evaporator controllers. By controlling rail heat according to the actual dew point measured in the store, significant energy savings can be achieved. The following section highlights how to configure active rail heat via the Danfoss AK-CC 550 evaporator controller (which has the ability to utilize calculated dew point over the communications bus). Select 'Yes' to the question line 'Use Adaptive Rail heat', and (in this example) select 'Calculated Dewpoint' as the dewpoint method. Upon answering these questions the AK-SM will automatically build sensor points to allow for the humidity and temperature sensors to be defined. As the diagram below shows, the EMHS3-1 sensor has humidity and temperature wired in to an AK I/O module, the points at which these sensors are connected can then be added under the sensor page (Configuration → Control → Refrigeration-Addresses).

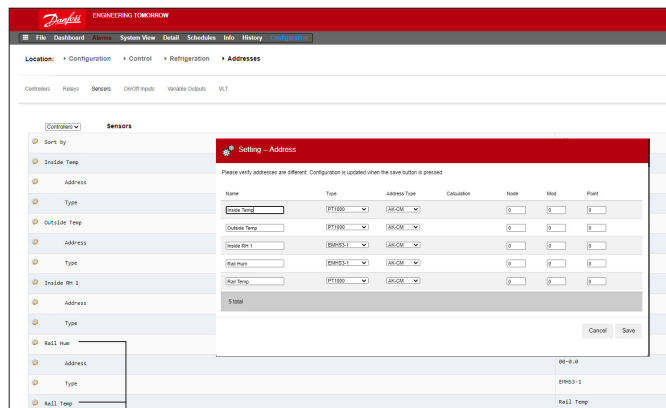

When using the EMHS3-1 sensor the humidity & temperature output will be connected to AK I/O. Use the 'Addresses' tab to locate the sensor sub- tab, where the appropriate board & point can be set (in line with the physical connections on the AK I/O).

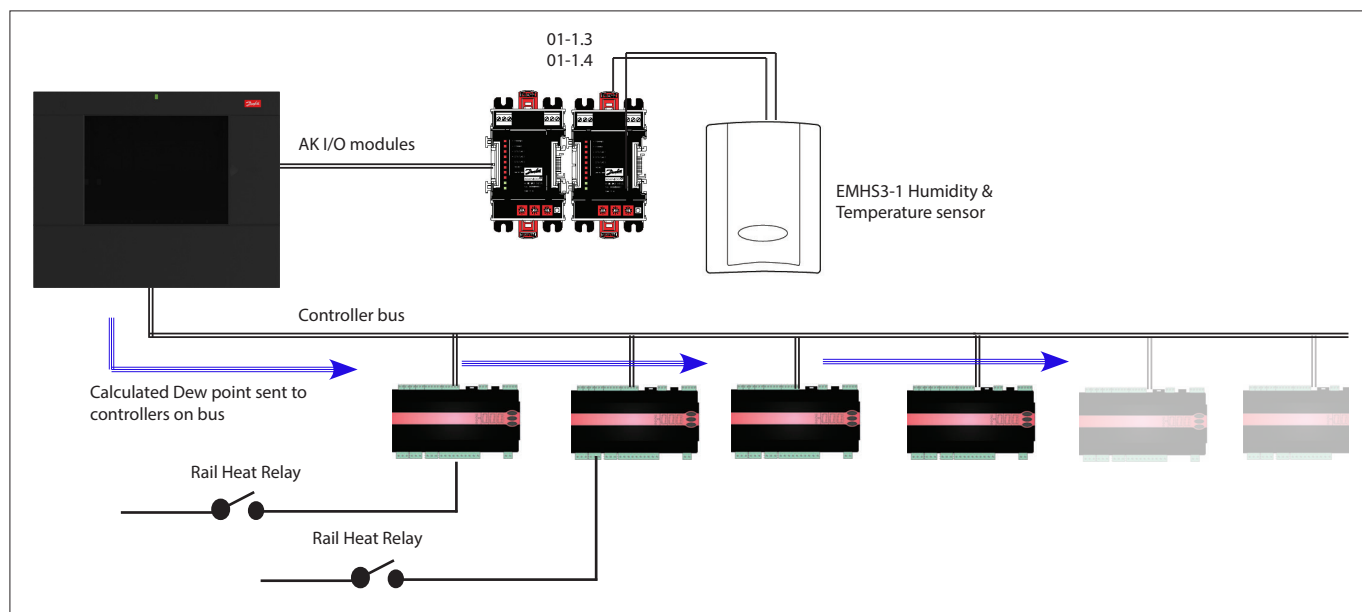

For adaptive rail heat to function correctly ensure the AK-CC 550 controllers are set correctly. Review parameters o85, o86 and o87, as noted below. The screen image below highlights the AK-CC 550 controller (Miscellaneous menu), where parameter o85, o86 and o87 are set for rail heat control over the bus.

Name	Value
* #12 Main switch	0-Stop
* o61 Appl.mode	Application B
* o38 Light config	2-Data communica
* o39 Light remote	OFF
* o46 Case clean	0-normal op
* o85 RailTh. mode	0-Not used
* o41 Railh.ONday%	100 %
* o42 Railh.ONwgt%	100 %
* o43 Railh.cycle	10 min
* o86 DewP Min.lim	6.0 °C
* o87 DewP Max.lim	17.0 °C
* o88 Rail Min ON%	30 %
* o89 DoorInj5Start	30 min
* o06 SensorConfig	0-PT1000
* #05 Temp.unit	C
* #09 Adjust S4	0.0 °K
* #10 Adjust S3	0.0 °K
* #59 Adjust S6	0.0 °K
* #001 DelayOfOutp	5 sec
* o02 DI1 Config	0-Not used
* o37 DI2 Config	0-Not used
* o84 DI3 Config	0-Not used
* #92 Displ menu 2	Def Stop Temp
* #97 Displ. Ctr1	1
* #98 Light MS-Off	0
* #05 Acc. code	0
* #04 Acc.code 2	0

Rail heat settings in the AK-CC550

o85 = Rail heat control
(select option 2, pulse control with dew point function)

o86 = Dew Point MIN limit

o87 = Dew point Max limit

At a dew point which is equal to or lower than the value in O86, the effect will be the value indicated in o88. In the area between the two dew point values the controller will manage the power to the rail heat.

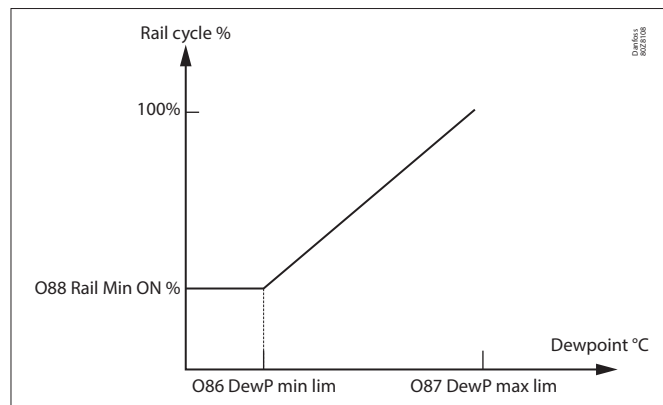

6.2 Schedules

(used in combination with Danfoss controllers)

Configuration → Control → Refrigeration → Schedules

Under the schedules section multiple schedules can be added and configured according to your needs.

Enter the number of schedules required. The desired number of schedules will be shown (in this example 3 schedules have been requested). Initially each new schedule is set to disabled, move the cursor to the required schedule line and press 'Enter'. The resulting page allows the definition of the schedule, the following

configuration settings can be made:

- Enable this schedule (ensure this is set to 'YES' to engage schedule)
- Schedule usage (Choose from Case Lighting, Night Setback, Shutdown, Defrost, Coord Defrost)
- Description (Add custom description for schedule)
- Schedule control (Choose between Time, Digital, Time & Digital, Time or Digital)
- Number of schedules (select the number of sub schedules required)
- Start, Stop, Days and Holidays (Define the Start / Stop times, days and holidays)

Schedules	Status
Make a selection	
Press to enable all	
Press to disable all	
Num of schedules	7
Case lighting	True
Schedule 2	Not Sent
Group defrost	Auto
Press to turn on	
Schedule 3	Disabled
Schedule 4	Disabled
Schedule 5	Disabled

Schedules	Value
Enable this schedule	No
Schedule usage	Case Lighting
Description	Case Lighting
Schedule control	Time or Digital
Digital Input	01-1-3 MISC Input 01
Num of schedules	1
Schedule 1	
Start	04:30 AM
Stop	01:00 AM
Days	-0T5A8FA
Holidays	12345678

Each schedule line will also reflect the current status
False = schedule not active True = schedule is active
Disabled = Not Active (Enable in schedule setup page)

The example screen below highlights the different areas of schedule configuration, in this example the (Case Lights) schedule has been set to start at 04:00AM until 01:00AM based on Time [AK-SM time] or a Digital Input.

For this example the Digital Input had already been defined under the Miscellaneous ON/OFF section, using AK I/O input **01-1.1**. The schedule will now become true (ON) if either the Digital switch is made OR the Time falls between the set Start / Stop times.

The example also has active schedule days seen as -MTWRFA. Sunday (S) has been deselected (-) therefore the schedule is only relevant Monday → Saturday.
i.e. S= Sunday, M=Monday, T=Tuesday, W=Wednesday, R=Thursday, F=Friday, A=Saturday.

After the schedule has been created the associated circuit [Evap] controllers must be selected - do this via the **Controllers** tab.

Note: A start / stop time of 12:00AM - 12:00AM = always ON

Navigate to the **Controllers** tab and any configured evaporator controllers will be listed (if no controllers are listed make sure the appropriate controller type is set, as defined in the main control page). Navigate to the required controller and double click the relevant line. This will toggle the controller 'Selected' or 'Not Selected'. Any controller set as 'Selected' will become part of the schedule.

Once all configuration of the schedule is complete, navigate back to the Schedules tab & select 'Enable this schedule' to **YES**.

To associate controllers with the schedule, use the Controllers tab.

Set to YES to enable schedule.

Press the enter key to select the pre-defined ON/OFF input.

Use the 'Enter' key to select or not select any controller(s).

For test or commissioning purpose or use of groups outside of the programmed interval it's possible to override the schedule. In case this feature is needed, go to **Configuration → Control → Refrigeration → Schedules** and double click in the selected schedule on the line "Press to turn on"

The status is changing from Auto to manual on.

Note: It is not possible to turn off and the feature is only available for defrost and not for setback, shutdown or other features.

6.3 Customized control

Select the Customized Control Schedule to allow your AK-SM 800A to trigger on/off events based on user configured control trigger such as a time schedule and/or a digital input. The Customized Control Schedule is designed to switch a specific controller parameter to establish certain run conditions (only one parameter selection per control device must be selected). For example, a master control parameter may be toggled for control purposes. The customized control schedule can be used to control (on=1/off=0) parameter, based on demand (digital input).

In the example below, the user defines a Danfoss AK I/O point as the digital input 'source' and selects the required control parameter via the 'select device parameter' question. As an option, an alarm or alert can be configured upon schedule activation or on schedule de-activation (Invert alarm option). An alarm action may be selected as well.

Schedules	
Enable this schedule	No
Schedule usage	Customized Control
Description	MyCustom Schedule
Schedule control	Digital
Digital input	01-1.3 Misc Input 01
Select default value if DI fails	Off
Invert schedule input	No
Master Control mode	Enabled
Select device parameter	AK-CC555C-013x ... HC Liq. Ctrl
Send alarm when schedule triggered	Disabled

On the associated tab called 'Controllers', those controllers which hold the selected On/Off device parameter can be selected. Unselect those controllers that should not be included in the customized control.

When the digital input is active, the AK-SM 800A will broadcast the value '1' to the selected controller(s), as defined in the 'Select device parameter' line and on the 'Controllers' tab. When the input signal is de-active, the AK-SM 800A broadcasts the value '0' to the controller parameters – thus toggling on/off the selected parameter. With the setting 'Master Control mode' set to 'Enabled', the parameter value is re-regularly broadcasted. Disabling this feature prevents re-broadcasting more than 1 time even when the trigger state condition remains 'True'.

Note: A customized control schedule is designed to action on one parameter only. It is not possible to use multiple customized control schedules on the same target controller. It is possible to define one customized control and only controllers of the same EDF file type may be selected. Since the customized control may interact with a large network of field bus devices, appropriate time must be allowed for the customized control to respond to a state change in the selected Schedule control parameter. By setting Default to 'On' the schedule function will continue to broadcast the value '1' in case communication to the digital input is lost. If communication the digital input is lost with the 'Default' set to 'Off' the schedule function stops broadcasting to the controllers.

6.4 Suction Pressure Optimization

The Adaptive Suction Pressure function in your AK-SM makes it possible to automatically optimize the suction pressure so that it will be adapted to the systems actual load. During optimization, data is collected that tells the system which refrigeration appliances are most heavily loaded. This energy saving function can make substantial savings directly whilst also saving on compressor wear and tear and also providing an analysis tool for refrigeration appliances.

The individual controllers handle the temperature control in the refrigeration appliances. The load and operating conditions of each are continuously collected by the AK-SM via the data communication system. The collected data is computed and the "most heavily loaded" refrigeration points are identified.

An adaptation can now be made of the Suction Pressure, whilst ensuring the air temperature at the refrigeration appliance is maintained. It is the AK-SM that collects data from the refrigeration appliances and it is the AK-SM that transmits any offset to the compressor pack control so that suction pressure reference is changed to suit the needs of the "most heavily loaded" refrigeration point. It is always the temperature at the appliance that takes top priority and in fact the suction pressure can float down if necessary.

The time during which a refrigeration point has been designated "the most heavily loaded" will be summed up in the log (history) within the AK-SM.

The pack suction (Po) pressure is optimized in accordance with the current refrigeration demand, taking into account short-term changes (day/night setback/defrost) and long-term effects (seasonal/weather changes).

In order to get the best efficiency out of the Po Optimization function it is highly recommended that a plant survey is done before enabling this function. A poorly running site will not be corrected by Po Optimization and the maximum benefits will not be seen - ensure all plant & evaporator cases are running close to

their designed setpoints and that defrost are operating correctly. Also ensure any manual plant override systems are set accordingly to allow the floating up of suction pressure.

It is highly recommended to always use the latest firmware available at [AK-SM 800A Series](#).

Theory of operation

The Po Optimize function uses a calculation on all controllers to determine a "Load Factor". This has been developed by Danfoss and is available in your AK-SM. By use of the Load Factor the Most Loaded Case (MLC) is constantly updated.

Floating of the Suction Setpoint is then determined at any given time by the MLC

1. The AK-SM continuously receives operating information from each (Po enabled) controller connected on the network. The AK-SM is looking for the 'Most loaded case' (MLC). Each evaporator is analyzed to see if its current operating temperature is within a calculated MLC 'target window'. During defrost and including after defrost recovery, the Po Optimization will temporarily remove the case from the Po calculation loop. This ensures that normal system fluctuations (due to defrost etc) do not effect the overall operation of Po Optimization.
2. In effect the continuous Po Optimization is looking for the evaporator that is under the heaviest load (the one that has to work the hardest to maintain temperature), but still falls within the MLC target 'window'
3. Based on the MLC the Po optimization function will then send a control signal to the Pack controller to optimize the running suction pressure, i.e. float the pressure up (based on the max limit set in the Pack configuration page). As the Pack controller allows the suction pressure to increase the AK-SM monitors the complete network and ensures that the refrigerating system as a whole is stable. This then is a continuous function that once set runs automatically and ensures the refrigeration system is running to the best conditions.

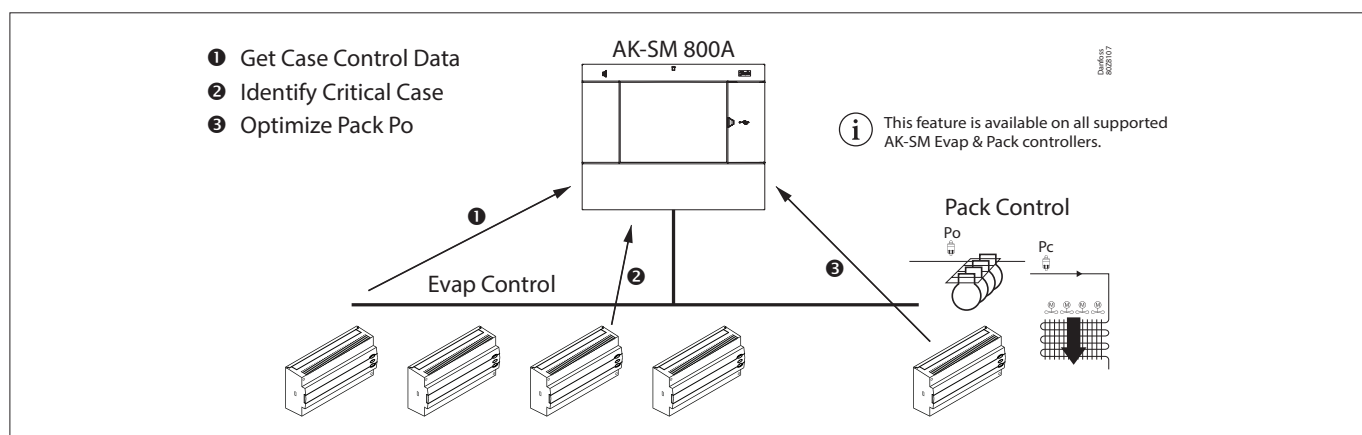

6.5 Configuration of suction optimization

Assuming a pack and evaporator suction group has already been defined, go to the Pack controller configuration screen. Locate the line 'suction optimization' and set to 'yes'.

Note: The settings may vary depending on the configured Pack Controller.

This automatically sets all evaporators associated with this suction group to also operate in Po optimization mode. If required, individual evaporator devices can be manually removed from the optimization loop under the individual evaporator configuration screens (Detail tab).

- Set an appropriate Maximum float pressure (shown in 'k') change that the optimization algorithm can make to the pack controller.
- Enter a post defrost delay (The time period that the Po Optimization algorithm ignores the evaporator device after a defrost. This allows the evaporator to recover from a defrost without effecting the Po Optimization algorithm).
- Define Po stop and alarm conditions (if x controllers enter off line state, then stop optimization)

Once set, the Po optimization operation can be seen under the pack controller screen (optimization tab)- refer to (local screen) examples below.

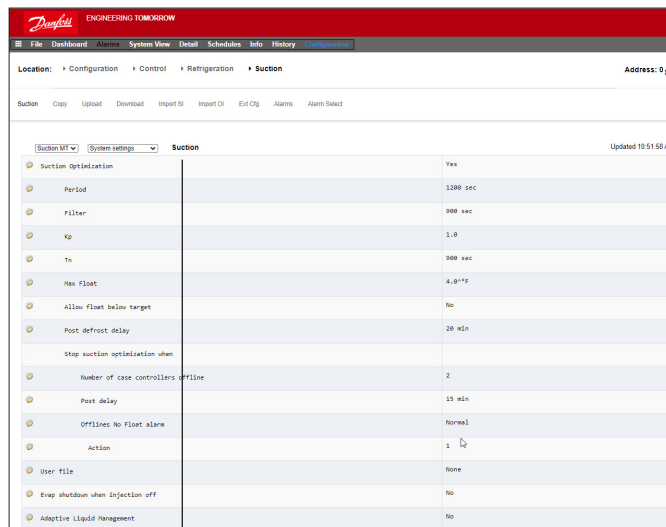

Enable suction optimization by selecting 'Yes'. All evap controllers associated with the Pack will then be tagged 'yes'.

Name	Value
View	Today
Status	Float based on Rund ZB5 200
Adjust suction by	0.0°K
Float up-all OK	0.0%
>Rund ZB5 200	15.7%
Varken ZB5 200	14.0%
Feest ZB5 300	9.9%
Borre1 ZB5 300	8.4%
Vleesw Buffet	8.1%
Zuivel TD 300	7.3%
Vis ZB5 200	4.2%
Vis ZB5 200	3.5%
Vleesw TD 200	3.5%
Kaas TD 200	3.3%
Zuivel TD 200	2.7%
Kaas Trevi 200	2.5%
Zuivel TS 200	2.4%
Kant&K1r TD 300	2.2%
Grill Trevi 200	1.7%
Zuivel TD 200	1.5%
Vleesw TD 200	1.4%
Groente TD 300	1.2%

Name	Value
Suction Optimization	Groente TD 300
User file	None
Evap shutdown when injection off	Yes

It is possible to remove any evap controller in the optimization function by selecting 'No' in the (evap) device detail (settings) screen.

Note: If your AK-SM is configured for degrees C, Suction Optimization is "K". If set to degrees F Suction Optimization is "F".

6.6 Adaptive Liquid Management

The new CO₂ Adaptive Liquid Management (CALM) solution allows full utilization of the evaporator surface in display cases and cold rooms, improving energy savings with CO₂ refrigeration in any store. CALM is a complete solution: It includes The Liquid Ejector, a compatible Pack Controller, and the Adaptive Liquid Control case controller algorithm. To make best use of your System Manager as a component in a CALM solution, make sure to utilize only compatible Case and Pack controllers manufactured by Danfoss.

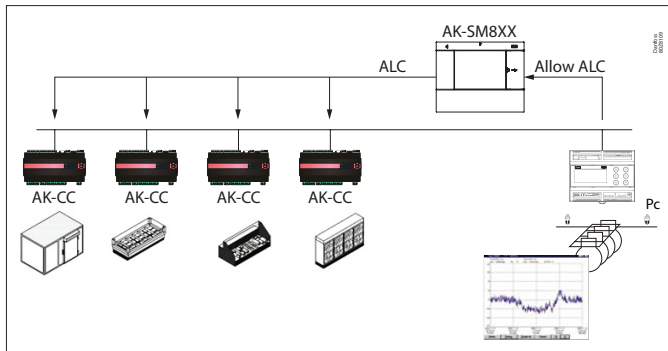

To enable automatic CALM control in the AK-SM 800A Series System Manager the Pack controller must be able to determine when to allow liquid control. Similarly, the Case controllers must be able to operate in CALM mode. Please consult your local sales representative for more details about supported case and pack controllers.

The CALM feature can be enabled by changing the setting 'Adaptive Liquid Management' to 'Yes'. Doing so will continuously monitor the associated Pack controller and distribute the CALM signal to supported Case controllers. It is possible to configure this functionality per suction group if this is supported by the pack controller itself.

Location: Configuration > Wizards > Control > Refrigeration > Suction

Type	Setup	Copy	Upload	Download	Import SI	Import OI	Ext Cfg	Alarms	Alarm Select
Suction MT System settings Suction									
Suction Optimization	Yes								
Period	1200 sec								
Filter	900 sec								
Kp	1.0								
In	900 sec								
Max Float	4.0°F								
Allow float below target	No								
Post defrost delay	20 min								
Stop suction optimization when									
Number of case controllers offline	2								
Post delay	15 min								
Offlines No Float alarm	Normal								
Action	1								
User file	None								
Evap shutdown when injection off	No								
Adaptive Liquid Management	Yes								

It is possible to exclude selected Case controllers from the CALM functionality by navigating to the 'Circuit configuration' area and set the "Adaptive Liquid Management" setting to 'No'. By default, all supported Case controllers will be set to "Yes" and thereby included in the CALM master control as illustrated in the picture.

Location: Configuration > Wizards > Control > Refrigeration > Circuits

Type	Setup	Copy	Upload	Download	Import SI	Import OI	Ext Cfg	Alarms
Circuit AA1 Setup								
Name	Circuit AA1							
Suction Optimization	Yes							
User file	None							
Evap shutdown when injection off	Yes							
Adaptive Liquid Management	Yes							
r12 Main Switch	0-Stop							
--- Cutout	0.1 °F							
A13 High Lim Air	46.4 °F							
A14 Low Lim Air	-22.0 °F							
A03 Alarm Delay	0 min							
A04 Door Open Del	60 min							

In the event that the system does not send or receive correct 'Allow CALM' signals in time, the CALM feature is designed to return into normal MSS control meaning disabling the CALM feature in all the configured Case controllers. These situations include:

1. Communication error (Offline) to the Pack controller
2. Pack Controller sends "Liquid Control NOT allowed"
3. Case Controller is configured to "Liquid Control NOT allowed"
4. The Pack controller does not support CALM
5. The Case controller does not support CALM

Should the Case controllers not receive a CALM signal from the System Manager within 15 minutes, the Case controllers will return to normal MSS operation.

Note: When the 'Adaptive Liquid Management' feature is enabled in the System Manager, it is important that NO custom schedules are configured for utilizing the same master control parameters ('--- MC. Liq. Ctrl;', 'MC Liq.ctl' or '---Flooding'). Failing to do so could compromise system integrity and result in compressor damage!

6.7 AKC ON (Evap shutdown when injection off)

One of the main features of the AKC On function is that the SM will detect if there is a pack shutdown condition. The SM does this by monitoring the pack controller for such conditions. If configured to do so, and upon detecting a pack shut down, the SM will issue a signal to all (configured) evap controllers under the pack suction group to close their AKV valves. The effect of closing the local AKV valve is to limit liquid flow in the evaporator. Due to the AKV valve being closed during a pack shutdown period there is a greatly reduced risk of liquid hammer or compressor damage upon pack / compressor start up. The AKC ON function must be configured for each pack suction group. By default, the associated evap controllers are set to 'yes' under the selection choice of Evap shutdown when injection off. If a evap controller is not required to be part of the suction group AKC ON function, set this value to 'No'.

Settings	
Name	Value
Suction Optimization	Centr Koelinst
Suction I.D	Centr Koe1
Max Float	0.0°K
Allow float below target	No
Post defrost delay	30 min
Stop suction optimization when	
Number of case controllers offline	2
Post delay	15 min
Offlines No Float alarm	Normal
Action	1
User file	None
Evap shutdown when injection off	No

Pack Configuration
Under the settings / Summary screen set the question Evap shutdown when injection off to 'YES'

AKC injection ON

For commissioning, retrofit and filter change mode it is necessary to simulate the signal from pack controller. Means, close valves manually.

In case the menu "Evap shutdown when injection off" a new menu appears in manual operation section, which enables the user to select between injection ON, OFF and AUTO mode.

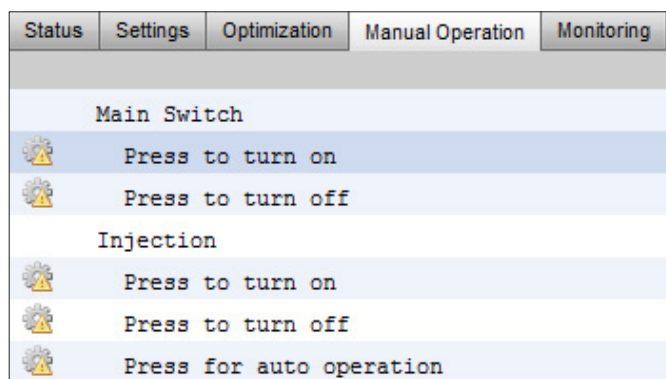

Evap Configuration

If the Evap is not required to be part of the AKC ON function, modify the question. Evap shutdown when injection off to 'No'

Settings	
Name	Value
Suction Optimization	Groente TD 300
Suction Optimization	Yes
User file	None
Evap shutdown when injection off	Yes

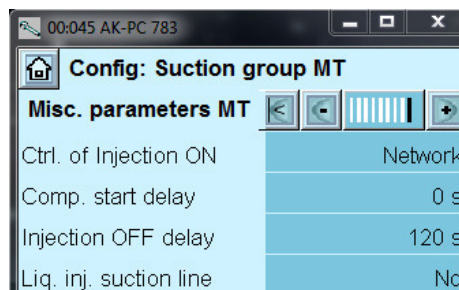

Note: make sure that the Pack controller has the field Ctrl. Of Injection ON set to Network, for AK2 style devices you may need the Danfoss Service Tool in order to see this parameter

6.8 Coordinated Adaptive Defrost

Danfoss offers a range of ADAP-KOOL® controllers that have an adaptive defrost function which allows the case controller to skip scheduled defrost cycles that are not necessary to carry out. Adaptive defrost is based on a real time monitoring of the evaporator performance.

By using the electronic expansion valve as a mass flow meter, it is possible to compare the energy balance between the refrigerant side and air side of the evaporator. By means of this comparison, it is possible to calculate the airflow through the evaporator when it is clean.

By monitoring the degrading air flow through the evaporator, it is possible to estimate the ice build-up on the evaporator. In order to calculate the mass flow of the refrigerant, the case controller uses the opening degree of the electronic expansion valve as well as the pressure differential across the valve.

Refrigerated cases are normally defrosted in groups corresponding to how they are placed physically in the store, for instance all case sections of a refrigerated island are defrosted at the same time. If multiple case sections share the same air flow, the defrost cycle must be co-ordinated, so that all case sections start defrost at the same time and start refrigeration when all cases of the group have terminated defrost.

In order to maximize the number of saved defrost, the case controllers have to be grouped into smaller sub-groups of controllers sharing the same air flow. It is more likely that a group of 3 case controllers all are willing to skip defrost compared to a group of 8 case controllers.

The 'ADAP-KOOL® system' offers a failsafe procedure that ensures that the refrigerated cases are defrosted in case of error conditions (e.g. lost communication).

The pack controller provides a filtered value of the condensing pressure P_c converted into saturated temperature T_c . For pack controllers handling trans-critical CO2 systems, the liquid receiver pressure must be distributed to the case controllers. This filtered value of the condensing/liquid receiver temperature is used by the adaptive defrost algorithm in the case controllers.

Automatic adaptation to the evaporator

When adaptive defrost is activated it will carry out an automatic "tuning" in order to adapt itself to the relevant evaporator. The first tuning takes place after the first defrost so that tuning can be carried out on an evaporator without ice formation. New tuning subsequently takes place after each defrost (but not during night with night blinds using defrost function 2). In a few cases it may happen that the function is not correctly adapted to the relevant evaporator. This is usually because the automatic adjustment has been made under abnormal operating conditions at start-up/ or testing the system. This will result in the function reporting an error state. If this happens, a manual reset of the function should take place while briefly setting the adaptive function switch to "0" (OFF).

Status display

For each evaporator it is possible to display the current operating status for adaptive defrost:

- 0: OFF Function not activated
- 1: Sensor error state – waiting for sensor OK
- 2: Tuning Function carries out automatic tuning
- 3: OK – no ice build-up
- 4: Slight ice build-up
- 5: Medium ice build-up
- 6: Heavy ice build-up

Defrost Control	Status	Updated: 15:24:20
--- Ctrl State	(s11) Normal	
u17 Ther Air	3.9 °C	
u12 S3 Air Temp	3.9 °C	
u16 S4 Air Temp	2.9 °C	
--- AKV OD %	0 %	
u26 Evap Temp Te	-10.0 °C	
u20 S2 Temp	2.9 °C	
u09 S5 Temp	3.2 °C	
u36 S6 Temp	120.0 °C	
u11 Defrost Time	60 min	
U01 AD State	0-Off	
U10 Acc Defrost	0	
U11 Acc Def Skip	0	
--- Defrost State	Off	
--- Tc Temp Ave	-150.0 °C	

Supported Danfoss Parameters to enable Adaptive Defrost functionality

The table below gives an overview of the defrost parameters required for the adaptive defrost start co-ordination. **Before configuring any adaptive defrost scheduling please check that the case controls used in your application are compatible.**

Chapter 7: Advanced features and configurations

7.1 Managers Override

Configuration → Control

From the Configuration → Control menu select the number of managers override required.

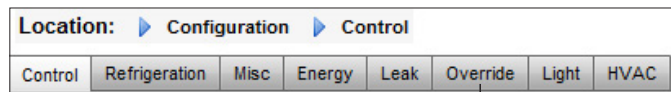

To configure the override, navigate to the 'Override' menu tab and follow the below guidelines.

The managers override function allows the authorized user to place Lighting zones and or HVAC units into an override state. The expected implementation for this feature is to provide some mechanical switch in the store managers office or loading bay. The following options can be seen in the configuration of the manager's override;

Timed Override (Yes/No)

YES - The override will last for the time selected in the 'duration (in Hours)' line. The point will return to normal operation after this time has elapsed.

NO - The override will last until it's switch on the override box is operated a second time

Interrupt enabled (Yes/No)

YES - The override can be interrupted by a second operation of the override switch

NO - The override cannot be interrupted, the point will remain in override status for the duration of the selected time

Bluetooth Interface

Override for securing wireless BT interface in supported controllers (e.g. AK-CC 55).

Override all zones (Yes/No)

YES - All lighting zones will be overridden

NO - One or more lighting zone (see details below) will be overridden

Override all units (Yes/No)

YES- All HVAC units will be overridden

NO - One or more HVAC unit (see details below) will be overridden

The 'Select zones' and 'Select units' buttons appear as needed to let you choose the lighting zones and HVAC units to be overridden. Each will give you a list from which you can select the specific zones or units to be overridden

Configuration for 'Other Unit' Overrides

If the point to be overridden is on another controller, you must configure a Managers override for that unit. Usually, there will not be an actual override box on the remote unit. Use the same board and point number you used for the actual override box. It is a good idea to make the name of the point the same too. Then make sure to configure the board & point with the same board and point number used for the actual override box, and set the Bcast point to Rec.

Manager's Override	
Number of overrides	1

Location: Configuration Control Override

Manager Override	Addresses	Device Access
Name		Override
Is this a timed override		No
Interrupt enabled		No
Override is for		Both
Override all units		No
Override all zones		No
Select Units		
Select Zones		

Setting -- Override is for

Select the New Value

- Lighting
- HVAC
- Both
- Other Unit
- BlueTooth Interface

OK Cancel

Bluetooth® Override

Some Danfoss controllers provide a Bluetooth communication interface for mobile devices.

Bluetooth® Lock for support devices

Some controllers provide a Bluetooth® communication interface for mobile devices. To prevent accidental or unauthorized configuration changes to these controllers, the system manager can send out a lock signal continuously on the fieldbus to keep the Bluetooth® interface in the controllers locked.

The system manager is able to override the Bluetooth® lock in four different ways:

1. Manually
2. Automatic at login

3. Digital input (D) override
4. Timeout fallback

Use the 'Managers Override' and the "Addresses" tab to configure a digital input as a Bluetooth® override. This requires an available IO point e.g. via an AK-XM extension module. Use the "Device Access" tab to manually override the Bluetooth® lock and enable automatic unlock when a user logs into the System Manager on the local interface. For both options is it possible to define a timeout which automatically re-engages the Bluetooth® lock in supported controllers.

Note: it is not possible to enable both methods at the same time.

7.2 Light

7.2.1 Lighting Configuration

Configuration → Control → LIGHT

Your AK-SM has the built in ability to support lighting schedules and control via Danfoss I/O modules or via lighting panel communications.

Typically the built in lighting control function is used to manage general store lighting applications. The initial lighting configuration is set out under the Configuration → Control page. The initial control question asks how many lighting zones are required. The AK-SM has the ability to share any indoor photocell configured and to define how many photocells are required. Once these initial control questions have been completed the remaining configuration is done under the Configuration → Control → Light. Lighting control is done via built in AK-SM schedules, and the optional use of photocells. The following section describes a typical lighting configuration, using AK-SM control.

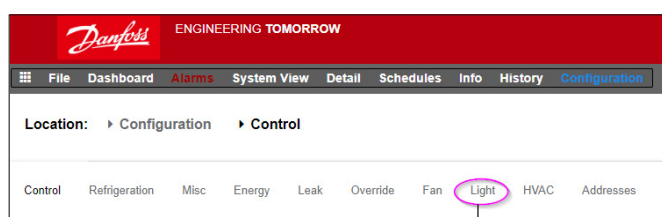

Detailed configuration is done under the Light tab (Configuration→Control→Light).

Lighting	
Number of lighting zones	1
Zones share indoor photocells	No
Zones share shutdown input	No
Number of MCX Light units	0
Number of Powerlink panels	0
Number of Cutler-Hammer panels	0

The initial Lighting configuration is done under the Configuration→Control page.

Danfoss recommends wiring any lighting circuits in **Normally Closed** position. This will ensure that if power fails to the AK-SM or I/O modules the lighting systems will 'fail safe'ON'

AK-SM Built in LIGHTING control (Using AK Input / Output / schedules & Photocells)

The following control options can be seen in the Lighting tab, navigate and press the enter key to change / configure any relevant points.

Property	Value
Zone name	User Def.
User defined name	Zone 1
Zone Type	AK-I/O
Photocell	None
Num of schedules	1
Num of control relays	1
Override Switch	No
Burglar override	No
Fire override	No
Shutdown Input	No
Load Shed Level	0
Schedules	
Type 1	Standard
Start 1	12:00 AM
Stop 1	12:00 AM
Days 1	SMTWFA
Holidays 1	12345678

Zone Name: Custom description (User Def) or select from a drop down list.

User Defined Name: Enter required name

Photocell: None (no photocell), Inside photocell, Outside photocell or Skylight

Control Sensor

Min: The lowest-reading photocell at any given time will be used as the control sensor.

Max: The highest-reading photocell at any given time will be used as the control sensor.

Average: All photocells are averaged, and the average value is used as the control sensor value. Photocell ID#1 (etc.): If any specific photocell is selected, its value alone will be used as the control sensor value.

Num of Schedules: The number of schedules for this point.

Control Method: Schd and photo: For this point to be on, two conditions have to be satisfied: (1) the schedule must be true; and (2) the photocell must be above trip level. Once those two conditions are satisfied, the pre-delay timer will start. Schd or photo: For this point to be on, either of two conditions must be satisfied: (1) the schedule must be true; or (2) the photocell must be above trip level. Once one of those two conditions is satisfied, the pre-delay timer will start.

Tip: For outside lighting control via photocell, the light level needs to be below the trip level. In the case of interior lighting, turn off lights when we're above a trip level.

Num of control relays: Each zone is controlled by a relay output (digital output) on the I/O network.

Trip Level %: The % level at which the photocell condition will be true and act to turn the lights on. (If multiple relays are configured, there will be one trip level per relay.)

Range: +/- : The range selected creates a dead band.

Pre Delay: When lights are off, the number of minutes that the lighting condition must be satisfied before lights will be turned on.

Post Delay: When lights are on, the number of minutes that the lighting condition must be false before lights will be turned off.

Minimum on Time: When lights are turned on, the number of minutes that they must remain on before being turned off.

Minimum off Time: When lights are turned off, the number of minutes that they must remain off before being turned on.

Override Switch: (Yes / No) Whether or not there is an override switch assigned to the zone.

Override Duration: The duration of an override when the override switch is used.

Burglar Override: When this zone's lights are turned off, whether they are to be turned on when a monitored burglar alarm is sensed.

Fire Override: When this zone's lights are turned off, whether they are to be turned on when a monitored fire alarm is sensed. There is no pre-delay for fire alarms.

Enable Dimmer output: Whether or not a dimmer variable output will be controlled.

Target %: The photocell level that the controller will seek to maintain by operation of the dimmer.

Minimum output (0.0v): The minimum dimmer level.

Maximum output (10.0v): The maximum dimmer level.

Algorithm sensitivity:

Algorithm interval:

Max rate of change (% / Sec):

Tip: Target % applies if 'inside' or 'outside' photocell used. If a skylight photocell used, then the min output/max output (slope between 2 points) approach is enabled.

Schedules:

Type 1: Standard (directly linked with AK-SC lighting schedule), Relative (a time that is defined before or after the scheduled start / stop times).

Start1: Scheduled Start time

Stop 1: Scheduled Stop time

Days 1: Days of the week that will apply to this schedule

Holidays: Holidays that will apply to this schedule

7.2.2 Addresses

Configuration → Control → Light → Addresses

After the relevant Lighting control questions have been configured, appropriate AK I/O addresses need to be applied. The address inputs correspond to the Board & Point address of the AK I/O modules. Depending on the control definition made in the previous (Configuration → Control → Light) screen various inputs will require board & point addresses. Navigate through the Relays, Sensors, On/Off Inputs & variable tabs to define the relevant outputs (Skip the controllers tab as all control is done via AK I/O).

Tip: Standard schedule (eg. on / off time 8 am to 10pm)

Relative means, relative to the open/closed hours. I.E. Open hours are 8 am until 10 pm and a certain lighting zone needs to come on 15 minutes prior to start of open hours until 30 minutes after closing, the schedule would look like the following;
 -0015 on → +0030 off (so, being relative, the lights are on at 7:45 am and off at 10:30 pm).

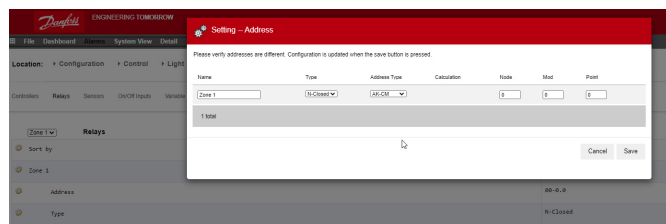

Navigate through the various control lines, enter custom description & valid address (Board & Point) that reflect the location on the AK I/O network.

7.2.3 Alarms

Configuration → Control → Light → Alarms

After the relevant Lighting control questions and appropriate AK I/O addresses have been applied, check the alarms tab. Depending on the Lighting control configuration alarm points will be seen under the alarm tab.

7.3 Dimming control via AK I/O

The AK-SM 800A offers the ability to dim lighting controls via the use of Danfoss AK I/O dimming systems. The following section describes initial setup and configuration.

Location: Configuration Control

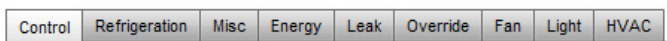

From the Configuration menu, navigate to the 'Control' screen. Enter the number of lighting zones required.

From the Configuration → Control screen navigate to the Light (Lighting) sub tab. The control method setup MUST be 'Schd and photo'. To use the dimmer night setback option, ensure 'Skylight' is selected.

Select Number of control points

Trip level: 2000fc A middle range setpoint.

Trip Range +/- : The value added to the trip level to turn Sales Lights OFF and allow them back ON.

Trip level of 2000 fc "plus" 200 trip range will turn lights OFF at 2200 fc.

Trip level of 2000 fc "minus" 200 trip range will allow sales lights back ON at 1800 fc.

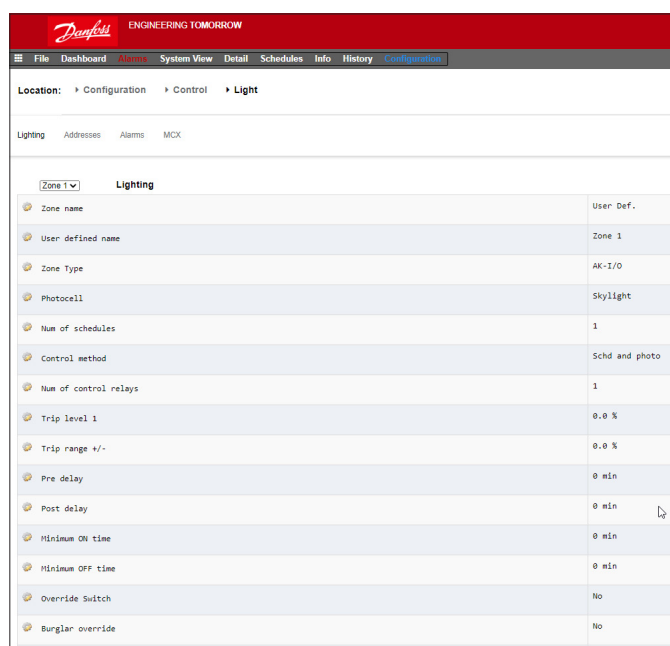

Pre delay: Delay in minutes before the zone can come ON. (Scheduled time)

Post delay: Delay in minutes before the zone can be turned OFF.

Minimum ON time: The time that must elapse once the zone has been turned OFF, before the zone can be turned OFF again.

Minimum OFF time: The time the zone MUST stay OFF before coming back ON.

The 'Min Out & Max Out' fields would be interpreted as follows:

Min Out at: If the skylight sensor indicated a reading greater than or equal to **1800** footcandles (fc), the dimmer would be set to **2% (Minimum output)**.

Max out at:

If the skylight sensor indicated a reading at or below **800** fc, the dimmer would be set to **65 % (Maximum output)**.

All readings between these 2 extremes would set the dimmer output per the following:

(Min out at – sensor)

$$\frac{\text{Sensor Reading} - \text{Min out at}}{\text{Max out at} - \text{Min out at}} \times (\text{Max. output} - \text{Min. output}) + \text{Min. output}$$

Thus, a sensor reading of 1200 fc would result in a dimmer output of:

$$\frac{1800 - 1200}{1800 - 800} \times 600$$

$$\frac{600}{1000} \times (65\% - 2\%) + 2\% = 63\% + 2\% = 65\%$$

$$\frac{1800 - 800}{1000}$$

Based on "default" setpoints, the algorithm will work as follows:

Dimming Algorithm Reference Table

Actual foot candle	VO%
800	65% (Max)
850	62%
900	59%
950	55%
1000	51%
1050	49%
1100	45%
1150	43%
1200	40%
1250	37%
1300	32%
1350	30%
1400	27%
1450	24%
1500	20%
1550	17%
1600	15%
1650	11%
1700	8%
1750	5%
1800	2% (Min)

Algorithm interval is the algorithm cycle.
Max rate of change is the percentage of adjustment per second.
 With a setting of 1 % for a 1 second algorithm cycle, and a 2% minimum and 65 % maximum output, the full range can be covered in 63 seconds. (1 percent per second for 63 steps.)
 This schedule turns the zone ON and OFF on a time base. (Setup for 24 hours).

Once the main configuration screen is complete, navigate to the Variable Outputs tab, where a board and point address can be added for the 0-10 vdc board.

Setup of analog inputs:
 Skylight sensor to PHOTO-SKY type
 Dimmer feedback to misc. conversion factor DIM FEEDBK

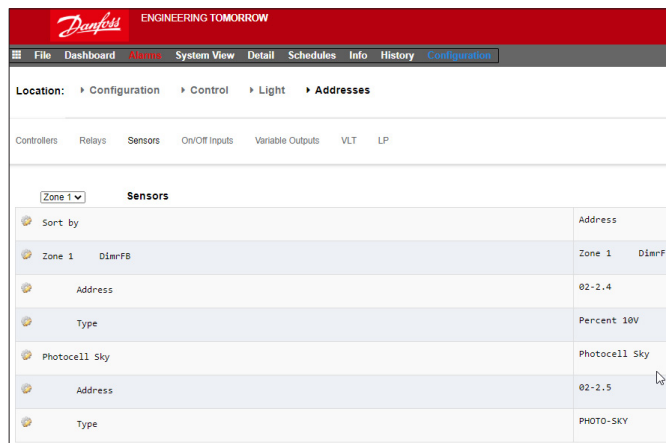
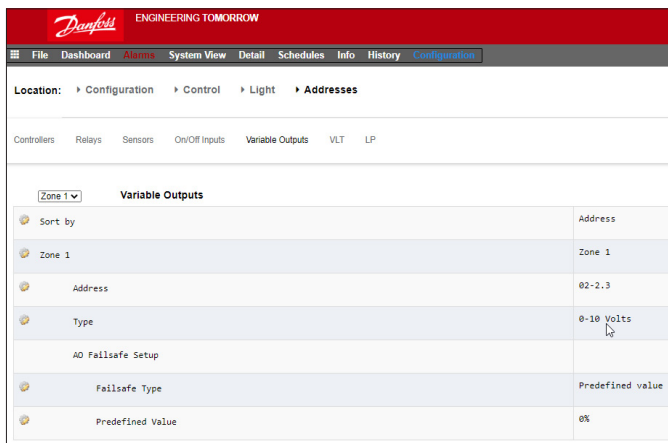

Once the lighting configuration is complete the details can be seen in the zone lighting detail screen. The detail screen will reflect status, Settings and Service tabs.

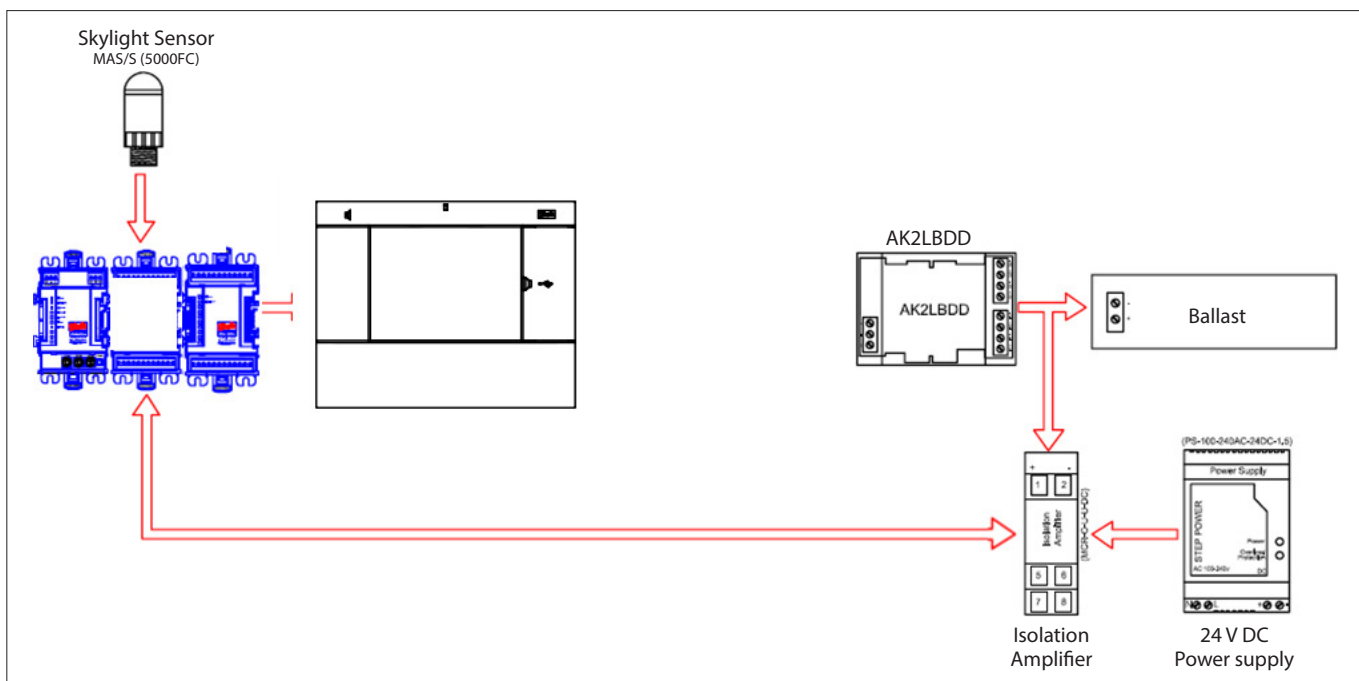
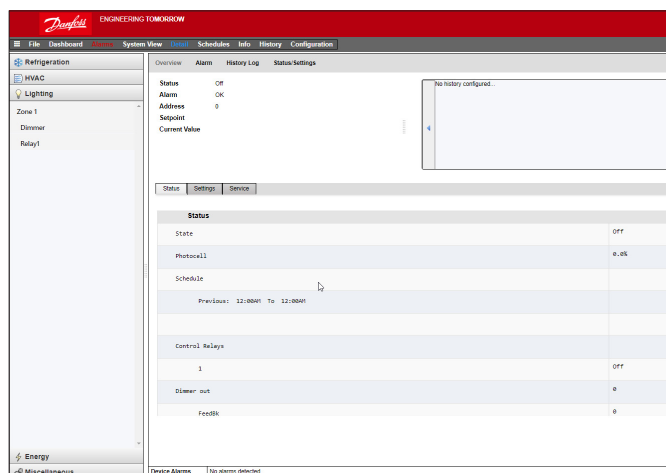

7.4 HVAC Configuration

Configuration → Control → HVAC

The AK-SM 820 and AK-SM 880 both offer HVAC control and support. Both the AK-SM 820 and 880 offer the same HVAC functionality, the only difference is the number of HVAC units that can be configured. HVAC control and support can be via centralized or de-centralized control. Centralized control offers the ability to control HVAC systems via Danfoss AK I/O modules. The de-centralized method allows support for specific field bus nodes.

Initially, navigate to the 'Configuration → Control' screen, and then declare how many HVAC units you require. In addition to the number of HVAC units, the following questions will also be populated;

- # of phase loss monitors
- # of humidity sensors
- # of dewpoint sensors

Setting	Value
Allow Demand Response	No
HVAC	
Number of HVAC units	2
Number of phase loss monitors	0
Number of humidity sensors	1
Number of dewpoint sensors	0
Inside CO2 sensors	1
Outside CO2	Yes

The example below describes a typical centralized control method. As seen in the Refrigeration section, the built in HVAC control is based around a list of control questions. When answering these questions, the control inputs / outputs are being built and will be visible in the Address tab. Navigate to the 'Configuration → Control → HVAC' screen; here you will need to declare what type of HVAC control method is to be used.

For centralized control, select 'AHU' or 'RTU' from the drop down list. If you require de-centralized (field bus) control, select the controller type from the drop down list. Once selected use the setup tab to continue configuration. In the example below, AHU has been selected.

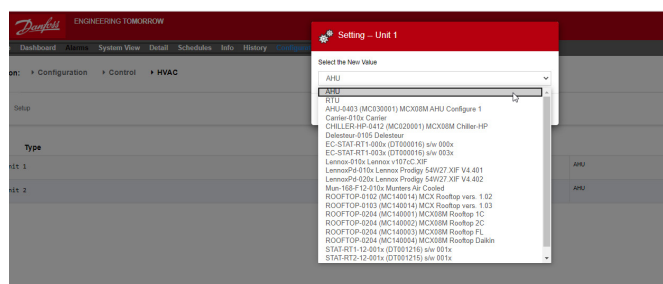

Number of Zone sensors: The number of zone sensors in the area of the store served by this HVAC unit.

Fan Type: 1-Speed: The unit has a single-speed fan. 2-Speed: The unit has a two-speed fan.

Fan control OPEN hours: Continuous: The fan will run continuously during open hours. Store open hours are defined in the Configuration→Time tab. On demand: The fan will run on demand during open hours. “On demand” means that the fan will run whenever conditions calling for heating, cooling, dehumidification, or venting are met.

Fan control CLOSED hours: Continuous: The fan will run continuously during Closed hours. Store Closed hours are defined in the Configuration→Time tab (the closed period is from Close time to Open time). On demand: The fan will run on demand during Closed hours. “On demand” means that the fan will run whenever conditions calling for heating, cooling, dehumidification, or venting are met.

Post delay: The number of minutes that the fan will run after the last stage of heating, cooling, etc. is turned off.

Lockout on proof failure: Yes: The fan will be locked out if fan proof is lost for five minutes. Human intervention will be needed to restart the fan by using the “Clear” button on the status screen. Evidence of the locked out condition, and the means of ending the lockout, are found on the status screen for cooling or heating function. No: The fan will not be locked out on proof failure.

Monitor Phase Loss: Whether or not a phase loss monitor will be monitored.

Which phase loss monitor: All available phase loss monitors are shown.

Shutdown on phase loss: Whether or not the unit is to be shut down when its phase loss detector input is on.

Shutdown on digital input: HVAC unit will shut down based on a digital input

Shutdown on smoke detection: Whether or not the unit is to be shut down when its smoke detector is on.

Shutdown on fire alarm: Whether or not the unit is to be shut down when a monitored fire alarm is detected.

No. of return air sensors: (1-3)

No. of supply air sensors: (1-3)

Cooling:

Num of cooling stages: (1-3) The number of cooling stages in this HVAC unit.

Proof: Cooling stage will be monitored for it’s actual run status

Stage x (where x is either stage 1,2 or 3)

Target: Enter required target temperature

Pre Delay: The number of minutes that must elapse after target plus range is reached before the stage will come on.

Post Delay: The number of minutes that must elapse after target - range is reached before the stage will be turned off.

Range +/- : The range selected creates a dead band. For example, if the target is 72 and the range is 2, the stage will come on at 74, and will not be turned off until the temperature reaches 70.

Ambient temp lockout: Whether or not there is to be a lockout based on low outside ambient temperature.

No Cooling below: The ambient temperature below which cooling will be locked out.

Range +/- : The range selected creates a dead band. For example, if the lockout is 50 and the range is 2, cooling will be locked out at 48 and will be allowed on at 52.

Default fan Speed: The fan speed for cooling. A different fan speed can be chosen for dehumidification when it is configured.

Setup	
Name	Unit 1
Number of zone sensors	1
Load Shed Level	0
Fan type	1-Speed
Fan control OPEN hours	Continuous
Fan control CLOSED hours	On Demand
Post delay	2 min
Fan fail lockout delay	60
Lockout on proof failure	No
Monitor phase loss	No
Shutdown on digital input	No
Shutdown on smoke detect	No
Shutdown on fire alarm	No
No. of return sensors	1
No. of supply sensors	1

Max suction press safety: Lists every configured pressure sensor. Any may be selected. Only the suction pressure for the cooling compressor in this rooftop should be used.

No cooling above: The pressure value of the sensor selected on the previous line at and above which cooling will be cut out. Cooling will not cut in again until the pressure falls below this value and the pre delay specified in the HVAC control page.

Freeze protection:

Sensor Input: There is a leaving air temperature for each stage of cooling, near the coil. At and below the setpoint (next line), the cooling stage will be turned off.

On/Off Input: A single digital input that when ON will turn off all stages of cooling in the RTU (Roof Top Unit)

None: There is no freeze protection to configure.

Night Setback: Whether or not the cooling setpoints are to be raised by an offset (next line) during scheduled times (next page) when cooling requirements are not as critical; for example, when the building is closed.

Night Setback offset: The amount by which the cooling setpoint is to be raised when night setback schedules (next page) are in effect.

Num of schedules: The number of cooling night setback schedules.

Override switch: Whether or not there is a switch to override night setback.

Override duration: The number of minutes after, activation of the override switch, that night setback will be overridden.

Night Setback schedules:

Type: Standard = based on start / stop times configured in following lines. Relative = based on store schedule with offset time applied

Start : Start time

Stop: Stop time

Holidays: Any holidays, as defined under Configuration→Time

Heating:

Auxiliary Heat type: None: There is no auxiliary heat. Staging: Auxiliary heat is staged. Gas Valve: Auxiliary heat is regulated by a modulating gas valve, Gas/Staging xxx

Stage x

Target: Heating target temperature

Gas Valve:

- Control from:
- Supply Target:
- Control gain (% degree):
- Integral time:
- Min valve opening:
- Max valve opening:
- Low fire position:
- Low fire duration:
- Ambient heat lockout:
- High Supply temp lockout:
- Fan Speed: Night setback:
- Night setback offset: Num of schedules: Override switch:
- Night setback schedules: Dehumidification:
- 'None' or 'cooling' (humidity, dewpoint or calculated dewpoint, and related setpoints and delays)
- Air Damper:
- If set to 'yes' it provides pre-delay, post-delay, ambient air temperature lockout and schedule options

AK-SC Built in HVAC control (Using AK Input / Output)

Following from the Controllers tab, the Relay, Sensor, On/Off Inputs & Variable Outputs tabs allow the adding of the relevant I/O modules required for built in HVAC. Each line would have been 'built' depending on the answers given in the various HVAC setup screens (previously described).

If required, enter unique description.
 Enter correct address for the Board & Point input.
 Type can be changed according to the selections in the type drop down list.

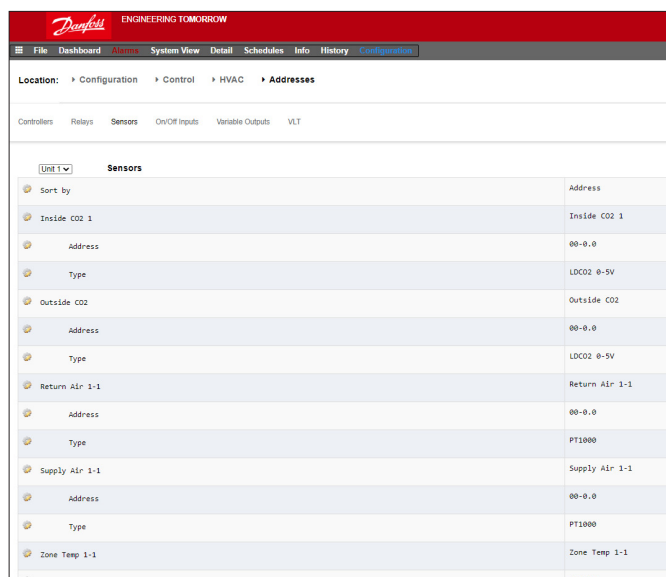

HVAC Alarms - Alarms Tab

The alarms for the individual HVAC unit can be found under the Alarms tab.

Scroll down each appropriate line and press enter to change the alarm level, the available options being the same as found in previous alarm tab configurations. In addition to the alarm level, an alarm action number can be set (1-8), configure the alarm actions in the central alarm routing page (Configuration → Alarms).

Note: For alarms to correctly activate, the central alarm routing page must also be configured. See Configuration → Alarms

Define the Alarm Action for each alarm output - this links with the central Alarms → Routing page.

Define the Alarm level (Disabled, Log Only, Normal, Severe, Critical, Delete).

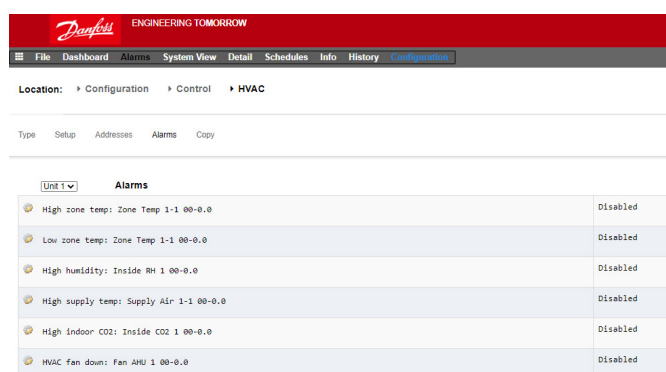

7.5 Miscellaneous Configuration

Configuration → Control → MISC

The term Miscellaneous refers to the ability to monitor and control miscellaneous areas of an application using Danfoss AK I/O (modules). For example, a miscellaneous relay output may be required for an exhaust fan, a dispenser that adds chemicals, an oven, a produce fogger, or any other device that can't or shouldn't be treated like an ordinary refrigeration, HVAC, or lighting asset. Miscellaneous on/off, sensor inputs can be used in defining the control strategy for miscellaneous relay outputs. Any miscellaneous points configured can be monitored for history, and may be configured strictly for that purpose, or for alarms. Routable alarms can be created for any Miscellaneous point. For sensor inputs, the AK-SM allows custom conversion for non-Danfoss sensors that have a linear response (known as Conversion factors)

Misc		
No. of relay outputs		1
No. of sensor inputs		2
No. of on/off inputs		3
No. of variable outputs		1

Configuration → Control screen

The initial Miscellaneous definition is set out in the **Configuration → Control screen** (see left). In addition to Relay, Sensor, On/Off Inputs and variable outputs the Misc section also has Conversion Factors & Calculations. Further details on conversion factors and calculations can be seen in this section.

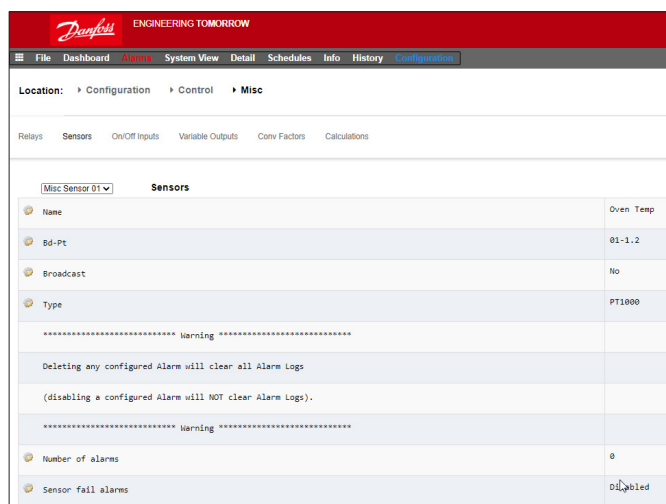

For this example the board and point address 01-1.2 is assigned

Once the required misc points have been set (number required), configuration is done under the **Misc** tab.

In this example a miscellaneous sensor has been configured, but the same principle will apply if configuring Relays, On/Off and variable outputs. Under the Misc tab, navigate to the sensors tab. Enter a suitable description for the sensor, then under the Bd-Pt line, enter the board & point address for the sensor in question. In this example the address 01-1.2 has been assigned. Review the remaining items in the list and configure according to your site requirements.

Example of I/O module line up. The communication module (AK CM 101A) has an address set as 1, with module 1 having the sensor in location 2. This is then entered in the AK-SM as 01-1.2

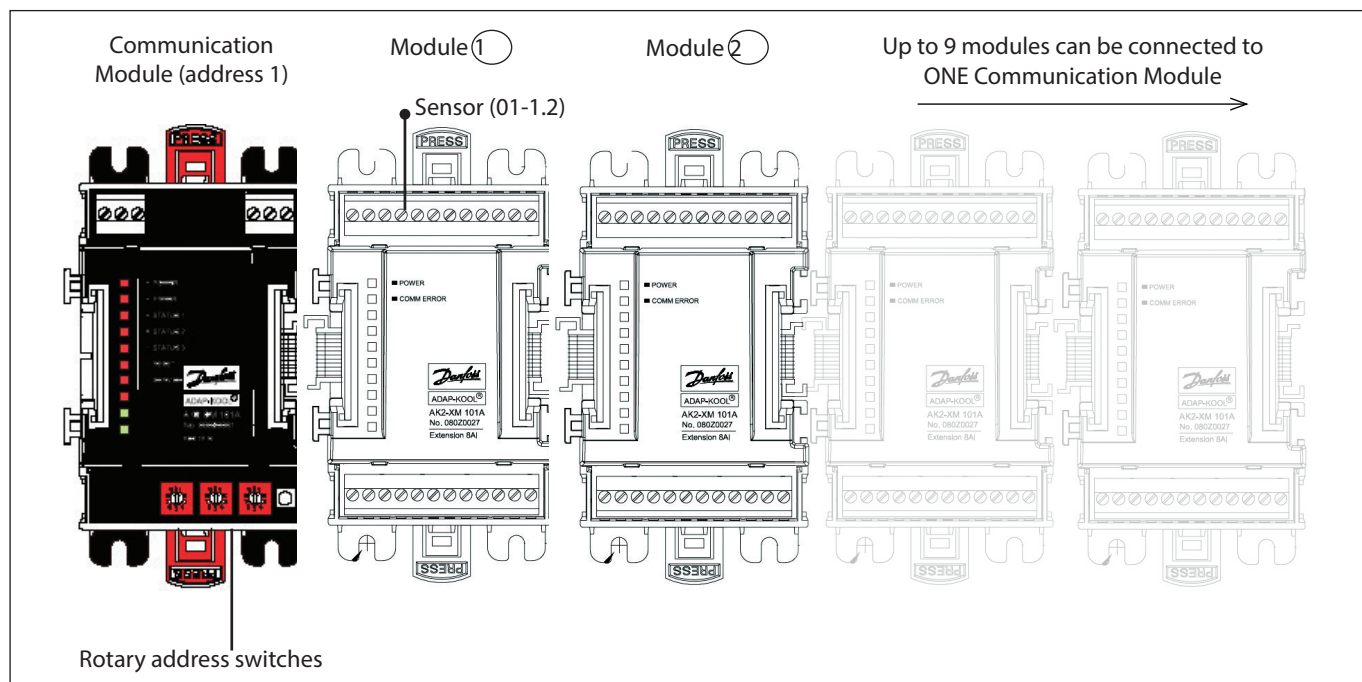

Relays Tab

The example below shows the Misc Relays tab. Navigate down the control lines and configure as required.

Relay Tab

Depending on control requirements the screen layout may differ.

Navigate through the options, adding custom name, AK I/O address, alarms, pre and post delays etc.

Note: Setting Broadcast to yes will make available the relay status on the AK-SM host network. If a control input is needed to operate your misc relay, this can be selected on the Control Input line (you will need to configure your control input in advance)

If configured, navigate to additional relays via the drop down box

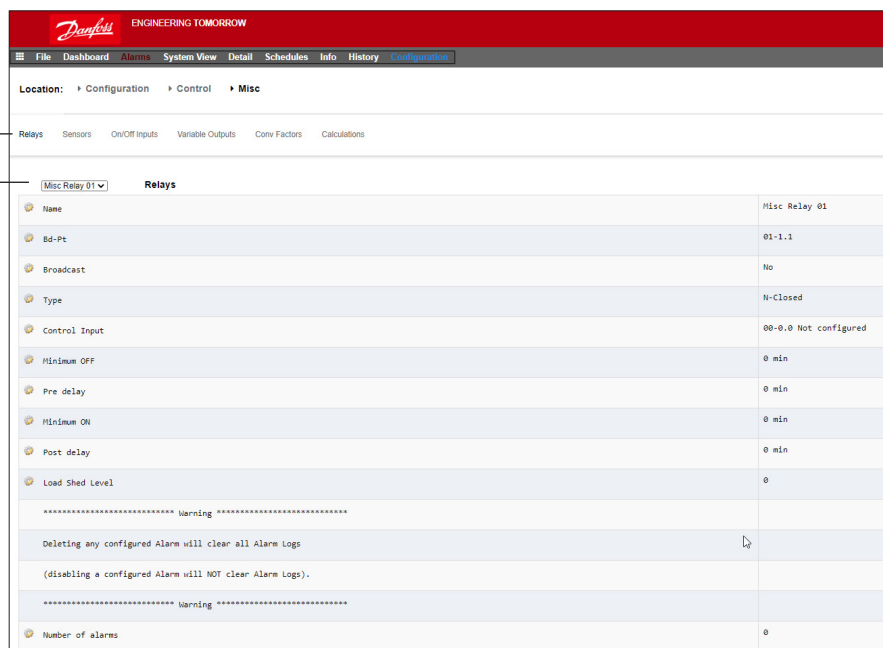

Name: Enter custom description for relay

Bd-Pt: Enter a valid Board & Point address (using AK I/O modules)

Broadcast:

No: The value of the point will not be broadcast to be used in logic on other controllers.

Send: The value of the point (whether it is ON or OFF) will be available on the host network for use by other controllers. Be sure that each sending Board-Point combination is unique throughout the system. (If the controller at address #01 is sending from its Bd-Pt address 1-02, then no other controller can have an output at its Bd-Pt address 1-02 sending.

Rec: The value of the point is being received from another controller on the host network. You must enter, in the Bd-Pt fields, the Bd-Pt address of the sending point.

Type: Normally Closed or Normally Open

Control Input: It is possible to use other defined points (including calculations) to act as the control Input - these will be seen in a drop down list

Minimum Off: Define a min off time period to stop short cycling

Pre Delay: Define a pre time delay before the relay activates

Minimum On: Define a min on time period to stop short cycling

Post Delay: Define a post time delay to minimize short cycling

Number of alarms: Enter the amount of alarms (max 3)

Alarm 1: Enter the alarm level (Disabled, Log only, Normal, Severe, Critical)

Type: Alarm if ON, Alarm if OFF, Cycles (enter number of cycles)

Delay: Enter delay time

Units: Seconds, Minutes, Hours

From: Defines alarm output time window

To: Defines alarm output time window

Days: Define the days associated with alarm

Action: Define the alarm action

Note: Any Misc points configured in the AK-SM system will be shown in the 'System View' under the Power/Misc window

Sensors Tab

The example below shows the Misc Sensors tab. Navigate down the control lines and configure as required.

Name: Enter custom description for sensor

Bd-Pt: Enter a valid Board & Point address (using AK I/O modules)

Broadcast:

No: The value of the point will not be broadcast to be used in logic on other controllers.

Send: The value of the point (whether it is ON or OFF) will be available on the host network for use by other controllers. Be sure that each sending Board-Point combination is unique throughout the system. (If the controller at address #01 is sending from its Bd-Pt address 1-02, then no other controller can have an output at its Bd-Pt address 1-02 sending.)

Rec: The value of the point is being received from another controller on the host network. You must enter, in the Bd-Pt fields, the Bd-Pt address of the sending point.

Type: Select from various option in the drop down list (this example uses a PT1000 sensor)

Control Input: It is possible to use other defined points (including calculations) to act as the control Input, these will be seen in a drop down list

Number of alarms: Enter the amount of alarms (max 3)

Alarm 1: Enter the alarm level (Disabled, Log only, Normal, Severe, Critical)

Type: Alarm if above or if below limit (seen below)

Limit: Enter the alarm limit

Delay: Enter delay time

Units: Seconds, Minutes, Hours

From: Defines alarm output time window

To: Defines alarm output time window

Days: Define the days associated with alarm

Action: Define the alarm action

Sensor fail alarms: Enter the alarm level to issue alarm if sensor fails (Disabled, Log only, Normal, Severe, Critical)

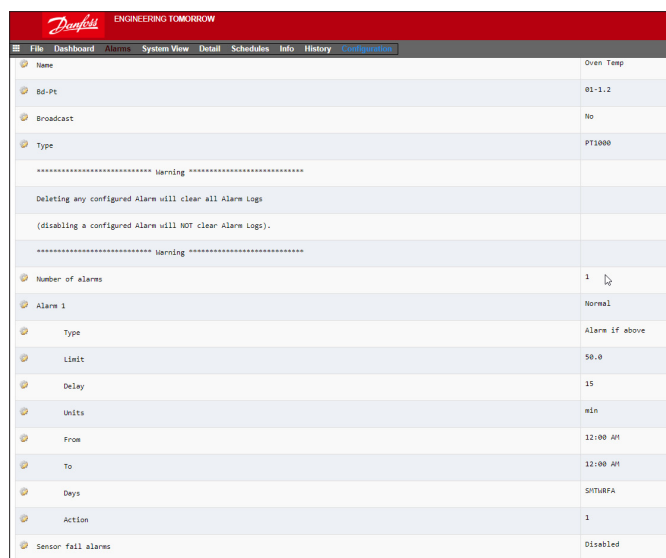

On/Off Tab

The example below shows the Misc On/Off tab. Navigate down the control lines and configure as required.

Name: Enter custom description for Input

Bd-Pt: Enter a valid Board & Point address (using AK I/O modules)

Broadcast:

No: The value of the point will not be broadcast to be used in logic on other controllers.

Send: The value of the point (whether it is ON or OFF) will be available on the host network for use by other controllers. Be sure that each sending Board-Point combination is unique throughout the system. (If the controller at address #01 is sending from its Bd-Pt address 1-02, then no other controller can have an output at its Bd-Pt address 1-02 sending.)

Rec: The value of the point is being received from another controller on the host network. You must enter, in the Bd-Pt fields, the Bd-Pt address of the sending point.

Type: Select from various option in the drop down list

Voltage: Voltage Input

No Voltage: No Voltage Input

Latching: Latching Input

Closed: Closed Input

Open: Open Input

Number of alarms: Enter the amount of alarms (max 3)

Alarm 1: Enter the alarm level (Disabled, Log only, Normal, Severe, Critical)

Type: Alarm if above or if below limit (seen below)

Limit: Enter the alarm limit

Delay: Enter delay time

Units: Seconds, Minutes, Hours

From: Defines alarm output time window

To: Defines alarm output time window

Days: Define the days associated with alarm

Action: Define the alarm action

Variable outputs

Using a 0 – 10V water mixing valve application as an example, the following screen can be used on the AK-SM to provide control. The same principles can be applied against a wide range of control needs. Variable output control can also be seen in certain AK-SM Refrigeration, HVAC and Lighting control screens. Using the Miscellaneous area of the AK-SM a variable output point can be created. After authorization, navigate to the **Configuration** → **Control page**. Enter the required quantity of variable outputs, remembering to also add a sensor input (which will be later used as a water temperature reference).

Next, navigate to the Misc tab and scroll to the variable output tab. Enter a descriptive name and the board & point allocation (the point number will be 1 to 4). Define the working voltage

range, here a 0 – 10 V range is set. The previously configured sensor input (water temp) can be defined, along with the output % range and is used as the control reference point.

An override relay or switch can be added if required (not used in this example). Finally an analog output fail safe can be configured. The fail safe feature is to ensure safe operation during power outages, network disturbances etc.

The following options are available;

- Stay unchanged - upon failure keep output voltage unchanged
- Maximum output - set output to 100%
- Minimum output - set output to 0%
- Predefined value - user set value %

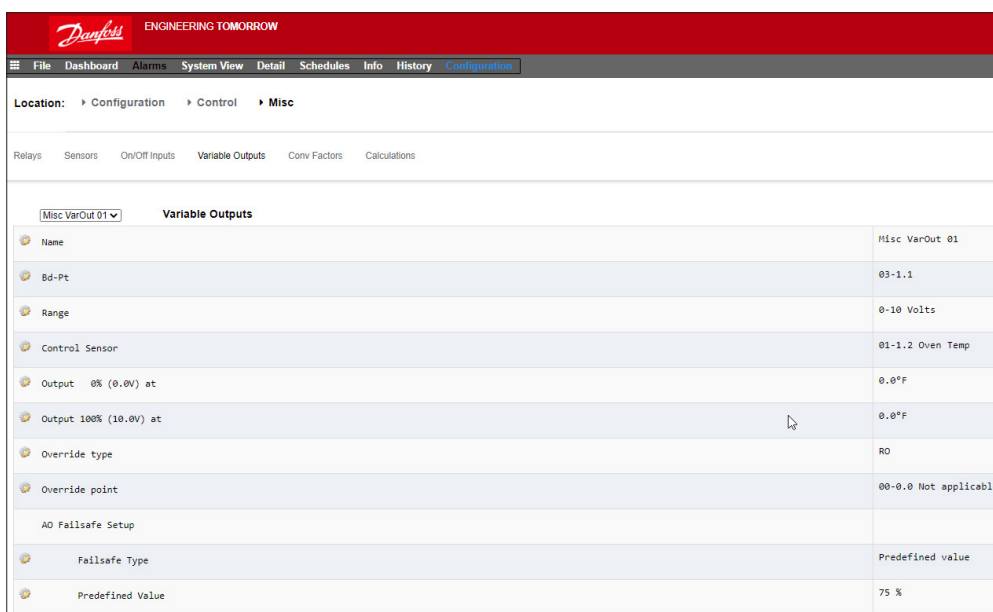

Name: Enter custom description for Output

Bd-Pt: Enter a valid Board & Point address. Variable output is done via VO2 board (described opposite)

Range: Select from various option in the drop down list:
0 – 10, 10 – 0, 0 – 5 Volts

Control Sensor

Output 0%

Output 100%

Override type (Relay Output, On/Off)

Override point

Failsafe Type (Stay unchanged, Maximum output, Minimum output, predefined value - user definable)

Number of alarms: Enter the amount of alarms (max 3)

Alarm 1: Enter the alarm level (Disabled, Log only, Normal, Severe, Critical)

Type: Alarm if above or if below limit (seen below)

Limit: Enter the alarm limit

Delay: Enter delay time

Units: Seconds, Minutes, Hours

From: Defines alarm output time window

To: Defines alarm output time window

Days: Define the days associated with alarm

Action: Define the alarm action

AK-XM 103A Variable Output board

Your AK-SM fully supports the family of Danfoss I/O modules. The I/O family consists of various analog inputs, digital outputs, and relays. New to the I/O family is the AK-XM 103A (080Z0032) analog input /output module. This new module offers x4 analog inputs and x4 analog outputs, allowing easy control of a variety of control applications.

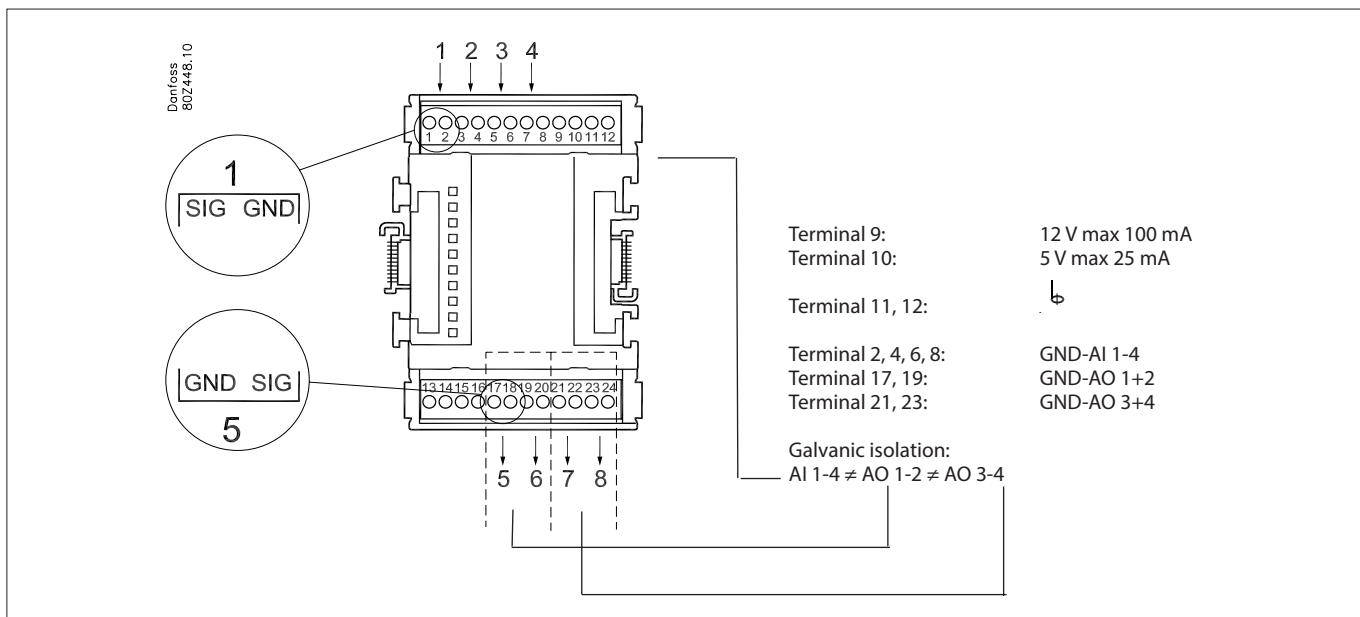
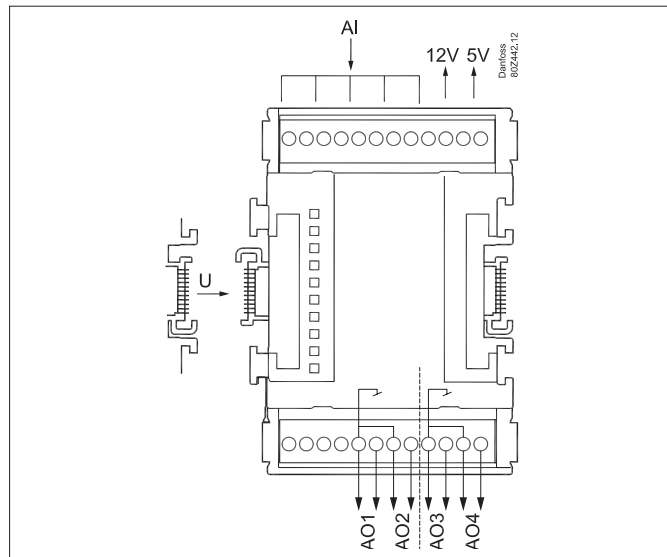
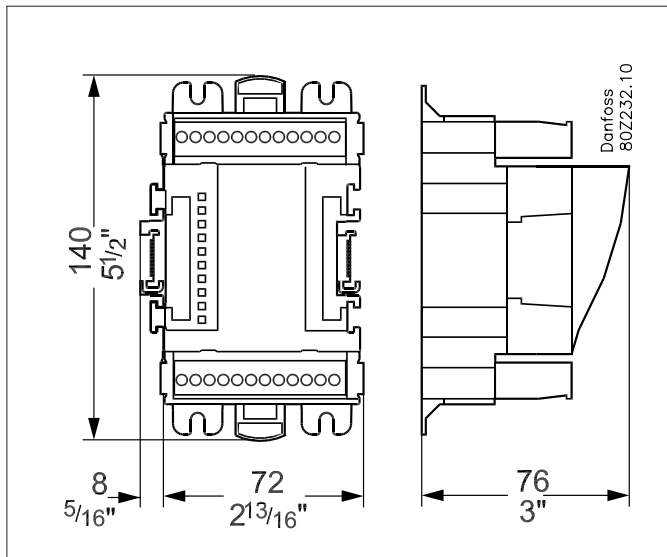

Conversion Factors

Conversion factors are used for sensors that have an output range or range-to-value relationship not already defined as one of the named “types” in the sensor input configuration list box. The following example highlights the Conversion Factor screen.

No of conversion factors: Enter the required amount of conversion factors

Conv 1: Name for conversion factor (user changeable)

Units: Select from a range of unit types:

- psi
- Bar
- °F
- %
- °C
- ppm (Parts Per million)
- V (Volts)
- Amp
- Kw
- kWh
- Hz
- gpm (gallons per min)
- fps
- pH
- fc
- lpm (litres per minute)
- lps (litres per second)
- Minimum Input:
- Maximum Input:
- Minimum output:
- Maximum output:
- Lux:

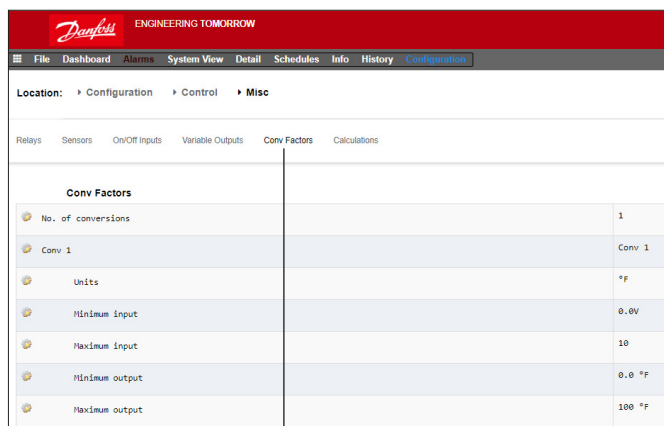

Conversion Factor Tab
Depending on control requirements the screen layout may differ.

Detail View

Status

Overview Alarm History Log Status/Settings Schedules Device Detail : Pack gr. 1 #0 Master Unit

Name	Alarm	Value	Setpoint	Status
HP control	Yes	- Bar	79.0 Bar	Emergency
Receiver control	Yes	- Bar	36.0 Bar	Emergency
Suction MT	OK	-1°C	-10.0 °C	Standby
Suction LT	OK	-1°C	-30.0 °C	Standby

No history configured...

Status Settings Manual Operation

Summary Status Updated 09:48:31

AK error	FAULT
Control status HT	Standby
Suction temp. To-HT	NaN °C
Suction reference HT	-10.0 °C
Running capacity HT	0 %
Requested cap. HT	0 %
Trec	NaN °C
HP control status	Emergency
Pgc	NaN Bar
Pgc reference	79.0 Bar

Settings (see also configuration)

Overview Alarm History Log Status/Settings Schedules Device Detail : Pack gr. 1 #0 Master Unit

Name	Alarm	Value	Setpoint	Status
HP control	Yes	- Bar	79.0 Bar	Emergency
Receiver control	Yes	- Bar	36.0 Bar	Emergency
Suction MT	OK	-1°C	-10.0 °C	Standby
Suction LT	OK	-1°C	-30.0 °C	Standby

No history configured...

Status Settings Manual Operation

Summary Settings Updated 09:56:54

Main Switch	ON
-------------	----

Service

Overview Alarm History Log Status/Settings
Device Detail: New metering #0 Master

Status 835192.0 kWh
Alarm OK
Address 01-2.3

Status Settings Service Consumption
Updated: 13:47:07

- Press to reset All
- Press to reset Average
- Press to reset yesterday
- Press to reset last week
- Press to reset kWh counter
- Press to reset peak kW value

Consumption

Overview Alarm History Log Status/Settings
Device Detail: New metering #0 Master

Status 835198.2 kWh
Alarm OK
Address 01-2.3

Status Settings Service Consumption
Updated: 13:47:41

View
Day

- Mon Sep 19 2016
- Previous day
- Next day
- Previous month
- Next month

Total kWh	2576.6
Peak kW	749.0
Occurred	12:15

The place for the address of the utility meter pulse did not change.
Still available here under sensors

Location: Configuration Control Addresses
Address: 0 Master Unit

Controllers Relays Sensors On/Off Inputs Variable Outputs VLT

Sensors

Updated 10:04:32

	Address
Sort by	
Inside Temp	Inside Temp
Address	00-0.0
Type	PT1000
Suction Pres AB	Suction Pres AB
Address	00-0.0
Type	AKS32-200
Outside Temp	Outside Temp
Address	00-0.0
Type	PT1000
Inside RH 1	Inside RH 1
Address	00-0.0
Type	EMHS3-1

Parameter	Description
Manual defrost start	Used to start a defrost cycle on a case controller. If this parameter is set ON the case controller will always initiate a defrost cycle. (Few exceptions does exist e.g. if Main Switch is set OFF, Defrost control is not Enabled, Case cleaning is ongoing, Case is in shutdown mode, forced closing condition with disabled defrost).
MC defrost start	Also a defrost start signal, but this signal will not initiate a defrost cycle if the adaptive defrost function in the case controller allows to skip the scheduled defrost. If the case controller is not set up for adaptive defrost, the signal will initiate a defrost cycle.
Request defrost	If the case controller is setup for adaptive defrost skip functionality, this parameter indicates whether the controller will initiate the next scheduled defrost. ON: Case controller will initiate a defrost cycle if the MC defrost start signal is set ON. OFF: Case controller will skip the next defrost cycle if the MC defrost start signal is set ON and the skip defrost counter will count 1 up.
Defrost state	Parameter that indicates the actual defrost status of the controller. This parameter is already used by the standard defrost co-ordination function in AK-SM850.
Tc mean	Filtered condensing pressure (converted to saturated temperature) read by AK-SM 850 from the associated suction group In pack controller) and distributed/written to the case controllers every 10 minutes. If the signal is not updated every 15 minutes in the case controller, the value will fall back to a default value.

Methodology of adaptive defrost

The following section describes the methodology of adaptive defrost.

When the defrost schedule reaches a defrost initiation time the following will happen for **each subgroup of controllers**;

AK-SM 800A will read if any of the case controllers are requesting a defrost cycle. The “Defrost request” status can be read from all case controllers supporting adaptive defrost with skip.

If just one controller requests a defrost cycle, AK-SM 800A will start a defrost cycle on all case controllers of the sub group in question by setting the “Manual defrost start” parameter to ON.

If none of the case controllers are requesting a defrost cycle, AK-SM 800A will send a “MC defrost start” signal to the case controllers of the sub group in question. The reason for sending the “MC defrost start” parameter is to enable the case controller to count the number of skipped defrost.

Exception handling

If a case is not configured for adaptive defrost or has no adaptive defrost function, it will always execute a defrost, members in the subgroup will also be (forced) into defrost. In this situation, all case controllers must start a defrost cycle. If the defrost request signal cannot be read from one or more case controllers at the time of defrost initiation, AK-SM 800A will start a defrost cycle on all case controllers in the sub-group by setting the “Manual defrost start” parameter ON.

Process diagram

The diagram below shows the process for defrost initiation for each sub group of controllers.

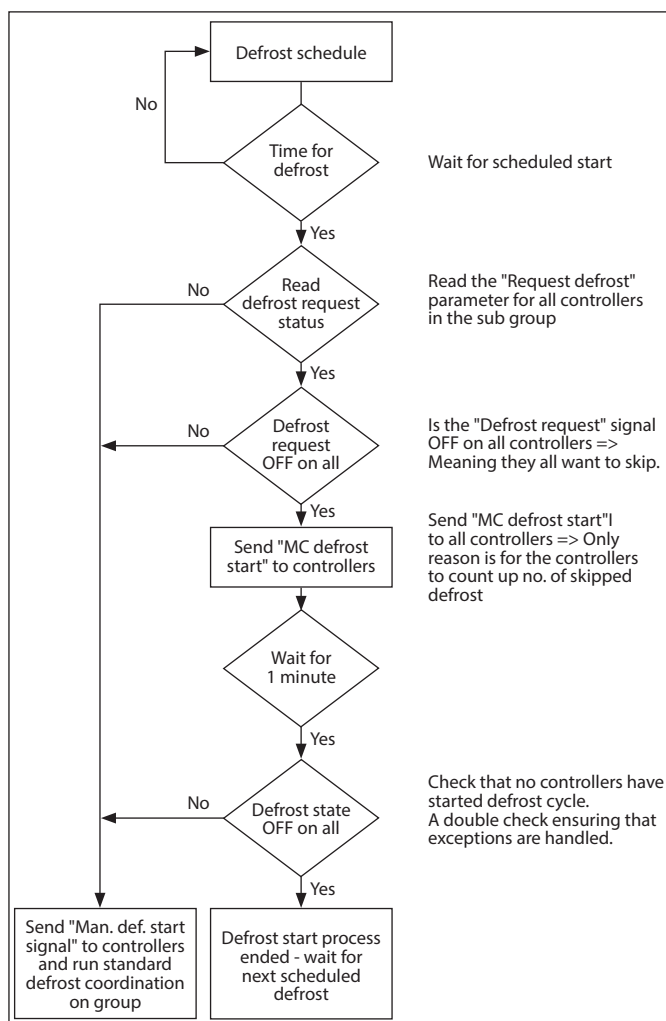

Coordinated Adaptive Defrost schedule and sub-grouping of controllers

Setting up an (coordinated) adaptive defrost schedule

Prior to any defrost schedule configuration, it is required that the relevant case controls are configured to accept adaptive defrost (i.e. set controller d21 AD Mode =4).

Under the Configuration → Control → Refrigeration → Schedules tab, create a new schedule – type Adaptive Defrost.

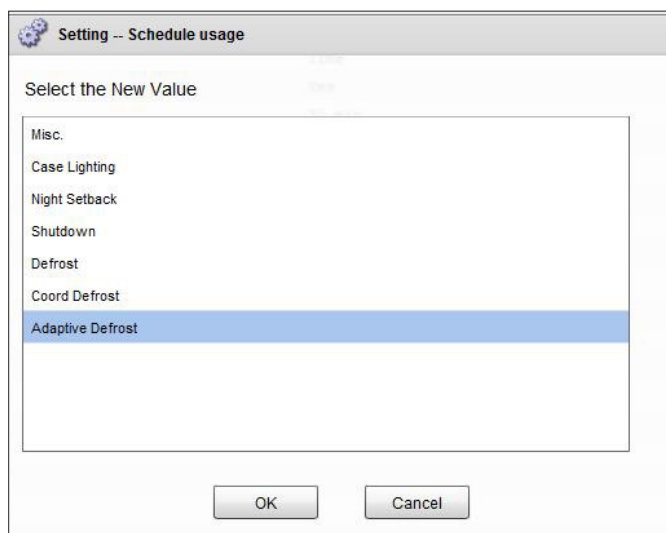

Selection of adaptive defrost schedule

The next step is to associate select case controllers to the (Adaptive) defrost schedule. Next, group the controllers into sub groups, corresponding to case controllers that share same airflow in the refrigerated cabinets.

The reason for putting controllers into sub groups is to maximize the defrost savings – i.e. 3 controllers are more likely to agree upon skipping a defrost cycle than 8 controllers.

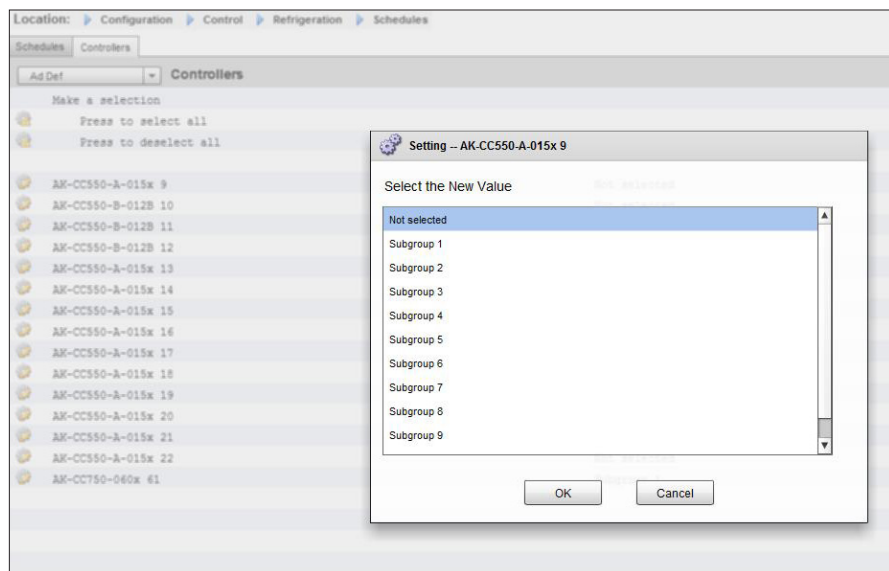

Example:

An island of refrigerated cases consists of totally 8 case sections (evaporators) – 3 case sections on each side and two individual end sections. In this example the user must be able to divide the group of controllers into 4 sub-groups:

- Sub group 1: 3 case controllers on one side
- Subgroup 2: 3 controllers on the other side
- Subgroup 3: End section
- Subgroup 4: End section

To support this configuration a master 'Adaptive Defrost' schedule is defined, with the controllers then getting grouped together using the sub-group option. This grouping effectively provides the coordination feature so that all cases are in sync during defrost / refrigeration cycles.

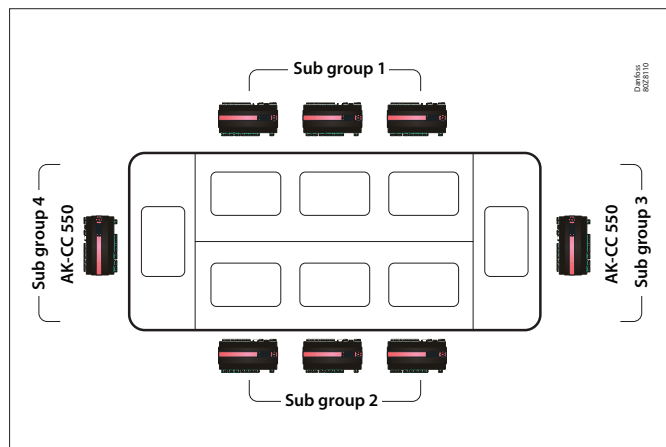

Manual defrost

The user can manually start a defrost at an individual case level (via device detail screen → Manual tab) or a schedule wide command can be performed. To initiate a schedule wide (all controls associated with that particular master defrost schedule) navigate to the schedule screen (Configuration → Control → Refrigeration → Schedules) and double click or press the 'turn on now' action line. The status 'defrost group' will then be shown under this schedule screen.

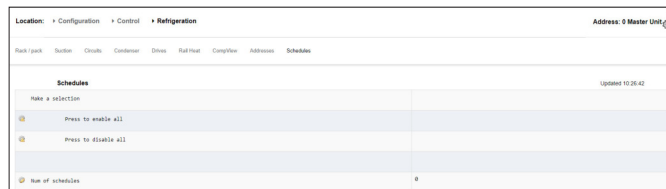

7.6 Energy

Energy Configuration

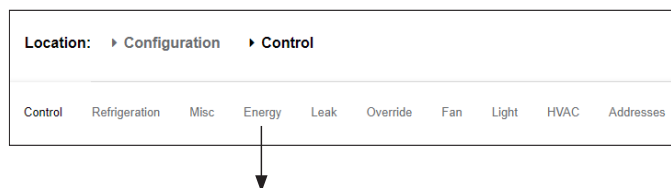

Configuration → Control → ENERGY

The AK-SM system can monitor Danfoss-approved energy meters which have a network interface. In addition to the network meter models, pulse inputs can be fed from a wide range of non supported meters to AK I/O pulse boards & thus basic kWh monitoring can be done. Once either a supported meter or pulse input has been configured, the AK-SM can display current electrical status and log data for history purposes. In addition to viewing and recording electrical data, demand limiting can be performed on lighting and HVAC loads.

The AK-SM system can have a max of 80 meters, only **one** of the meters connected to an AK-SM can be used for demand limiting. The following section describes the configuration of Pulse and network meter types, and highlights the demand limiting function.

The Danfoss approved power meters can be seen when selecting meter type under the control question in Configuration→Control page and are described in the example below.

Location: Configuration > Control > Energy	
Type	Setup
Meter 1	Setup
Name	Value
Name	Meter 1
Window size	15 min
Watt-hours per pulse	1000
Collect History	Yes
Use unit for demand lim	Yes
Window size	15 min
Normal load 01 HRS	1000
Normal load 02 HRS	1000
Normal load 03 HRS	1000
Normal load 04 HRS	1000
Normal load 05 HRS	1000
Normal load 06 HRS	1000
Normal load 07 HRS	1000
Normal load 08 HRS	1000
Normal load 09 HRS	1000
Normal load 10 HRS	1000
Normal load 11 HRS	1000
Normal load 12 HRS	1000

Configuration → Control → ENERGY [Pulse input from meter]

From the Configuration → Control page, navigate to the **Energy** tab. This example will describe the configuration of a **Pulse** meter type. Choose this 'type' if a non supported power meter has a pulse output that can be connected to a pulse AK I/O module (AK-XM 107A).

Under the **Meter Setup** tab the following screen can be seen;

Location: Configuration > Control > Energy	
Type	Setup
Type	
Name	Value
Meter 1	Pulse
Meter 2	WN Plus/MB
Meter 3	VER_EH8035-001x H8035
Meter 4	CG_EM24AV5-001x EM24-AV5

Detailed configuration is done under the Energy tab (Configuration → Control → Energy)

The initial meter configuration is done under the Configuration → Control page. Define how many Meters are required, then select meter type..

Energy meter choices:

Pulse/Vol = used to record volume via pulse (set to Liter, Gallon, Cubic meter (m³), Cubik feet (ft³))

Pulse = Output from meter fed in to AK I/O module

WN Plus= WattNode + brand meter (supplied by Danfoss).

CG_EM24AV0, AV5,AV6,AV9 = Carlo Gavazzi EM24 (Note NOT compatible with other MODBUS nodes on network)

VER_EH8035/36 = Veris modbus meter

Carlo Gavazzi WM30AV5 is compatible with other MODBUS devices on the same MODBUS network

Meter **Setup** Tab. All meter types can be seen in this window. In this example, pulse meter has been selected.

Enter custom name for meter
If using the pulse meter input for demand limiting, answer 'yes' to the question 'use for demand limiting'
See descriptions below for further details.

Name: Enter custom description for meter

Window Size: [Visible only when demand limiting set to yes] The window width is set to 15, 20, or 30 minutes. Every minute, the window “slides” forward so that it always contains the most recent period of time. Each minute the accumulated KW during that minute is recorded.

Watt-hours per pulse: Enter relevant value- Watt-hour per pulse

Collect History: Select yes to collect history from this meter

Use for demand limiting: Whether or not this meter is to be used for demand limiting.

Normal Load 01 - 24 Hrs: Enter the upper demand limit you do not wish to exceed for the given hour of the day (defined by each hour line) under normal operating conditions (when using normal power). There is one field for each hour of the day, from 01 to 24.

Maximum Emergency Load: Enter the upper demand limit that you do not wish to exceed when the emergency generator is running.

Start Shedding at: Enter the percent of maximum load at which you want to start shedding loads.

Start restoring at: Enter the percent of maximum load at which you want to start restoring loads which have been shed.

Enable coupling switch: In installations where there are two transformers and/or two emergency generators, a coupling switch can be used to connect both loads to one source in case the other source fails.

Number of normal steps: The number of steps (levels) which you will allow to be shed under normal conditions.

Number of emergency steps: The number of steps (levels) which you will allow to be shed when the emergency generator is running.

Normal:

Soft start begin level: 0 to the number of normal steps set above, up to 10; if 8 normal steps are configured, for example, the upper limit of this entry is 8) This entry specifies the level down to which loads will be turned on when the emergency generator starts. A level will be added each minute unless the specified emergency load for shedding to start is reached.

Couple begin level: [Visible when coupling switch = yes] Emergency generator control - Enter the upper demand limit you do not wish to exceed for the given hour of the day under normal operating conditions (when using normal power). There is one field for each hour of the day, from 00 to 23. This screen has two pages in order to list all the hours of the day.

Emergency:

Soft start begin level: [Emergency generator control] 0 to the number of emergency steps set above, up to 10; (if 8 emergency steps are configured, for example, the upper limit of this entry is 8) This entry specifies the level down to which loads will be turned on when the emergency generator starts. A level will be added each minute unless the specified emergency load for shedding to start is reached.

Coupling begin level: [Emergency generator control] Enter the upper demand limit you do not wish to exceed for the given hour of the day under normal operating conditions (when using normal power). There is one field for each hour of the day, from 00 to 23. This screen has two pages in order to list all the hours of the day.

Note about soft starts:

The effect of a soft start is to slowly add load to the generator after it starts. If, for instance, soft start begin level is set to 6, when the generator starts only refrigeration loads and loads assigned level 7 through 11 will be on. After one minute, if the load is below the “start shedding at” percentage of maximum emergency load, level 6 will be turned on. After another minute, the same decision will be made for level 5, and so on down to level one. If at any time the load reaches the “start shedding at” percentage, load shedding will begin again until the system reaches the “start restoring at” percentage.

DEMAND LIMITING TAB (see dedicated section on Demand Limiting).

Configuration → Control → Energy → Addresses

After the relevant Energy control questions have been configured, appropriate AK I/O addresses need to be set for the pulse meter input. The address input corresponds to the Board & Point address of the AK I/O module - **only use module type AK-XM 107A for pulse meter inputs**. Navigate to the **Addresses** Tab (Demand limiting will be shown in later section). Enter appropriate Board & Point location for the pulse input, under the Sensors tab (as shown below).

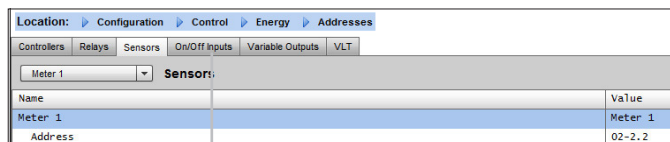

Enter custom name for pulse input

Enter unique Board & Point address. This input address should have the pulse input (via the power meter) connected

Any Emergency or Coupling Switch (defined in meter setup) will require address configuration.

Add these relevant address's via the On/Off Input tab

Configuration → Control → ENERGY [Danfoss Supported Power meter]

As previously described, the AK-SM offers communication support to the WattNode +, Veris and Carlo Gavazzi EM24 power meters. These meters offer increased parameters that can be viewed and logged in the AK-SM.

Note- due to differing baud rate specifications the Carlo Gavazzi power meter should not be connected on the MODBUS channel if an existing network of Danfoss EKC modbus devices is established.

- **WattNode® + (Continental Control Systems) meter** requires LonWorks® FTT10 interface - Use Danfoss (part #TP78-02) TP78 to FTT10 network bridge to allow correct communications .
- **WattNode®+ MODBUS (Continental Control Systems) meter**, connects over the AK-SM modbus network
- **Carlo Gavazzi EM24 supported meters** have built in MODBUS communications - connect directly to the AK-SM MODBUS port.
- **Veris EH35/36 (Veris Industries®) MODBUS energy meters**

WattNode Plus (MODBUS power Meters)

The Wattnode modbus power meter (Danfoss code 080Z2146) is a device which is compatible with other approved modbus devices on the AK-SM 800A network.

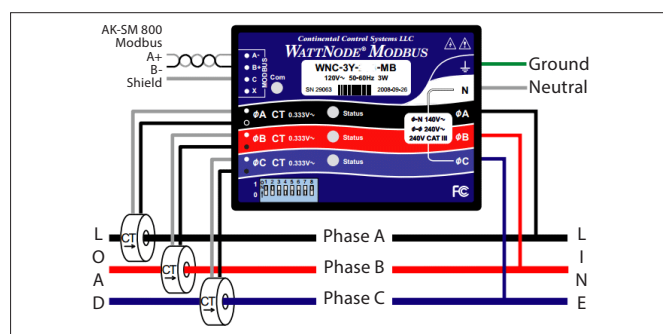

The following steps must be followed to ensure correct scan and communications

Step 1:
Ensure all devices on the modbus network are connected and have a valid and unique network address. Via the Configuration / Network Nodes screen, perform a network scan, enabling the MODBUS-RS485 - Ensure SLV/ECfan is set to NO.

Note: The WattNode MODBUS meter (080Z2146) has the ability to run at 38400 or 19200 baud rates. Out of the box the meter is set to 38400. If there are no SLV devices on the network, perform a network scan without selecting the SLV options. This will allow the AK-SM 800A to scan at the same baud rate and thus the meter will be detected.

If you have SLV devices on the same phase field bus as the meter you need to first communicate with the meter at 38400, then once scanned you select the SLV option to 'yes' and re-scan. This will then set the meter to the slower rate of 19200, the same as the SLV, thus making them compatible on the same field bus.

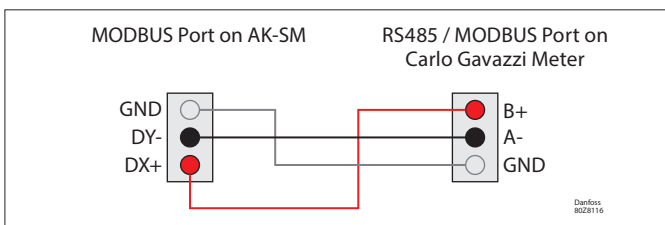

Danfoss preferred Carlo Gavazzi power meter support EM511 / EM530

New in release 4.0, the AK-SM 800A supports Carlo Gavazzi EM511 and EM530 power meters.

Danfoss ordering information below:

Codes	Description
080Z2130	3PH energy meter CT 5A RS485
080Z2131	1PH energy meter 45A Direct Conn. RS485
080Z2132	CTD-2x Bus-Bar current transformer 100A
080Z2133	CTD-3x Bus-Bar current transformer 200A
080Z2134	CTA-6x split core current transformer 400A

Both meters are implemented within the SM800A in the same manner as previous Carlo Gavazzi models, with additional aspects described below. EM511 and EM530 are Modbus meters and come factory default as 9600 Baud, No parity and 8 stop bits (9600N8).

Modbus#1: use case example - Danfoss approved devices + new Carlo Gavazzi meters

The table below is an example where the application has Danfoss EKC based controllers on Modbus#1, and there is a need to include the new Carlo Gavazzi meters also. In this use case the meters must be manually reconfigured for the appropriate Modbus settings – as shown in the table below.

MODBUS 1 Danfoss approved devices only	Configuration → Network Nodes - SLV Disabled	Configuration → Network Nodes - SLV Enabled	Configuration → System - Control Enabled
Danfoss EKC	38400, E, 8	19200, E, 8	n/a
EM511 - new	38400, E, 8	19200, E, 8	n/a
EM530 - new			

Note: there is no need to modify the Danfoss EKC controls as they have an auto baud rate feature.

Carlo Gavazzi ® power meter configuration (used in junction with RS485 AK-SM Model)

The following section describes the required steps to connect & configure the Carlo Gavazzi EM24xx meter over a Modbus network connection.

Before any configuration can take place, ensure the meter is securely wired, has a valid network address (different from any other nodes on the 'Controller' network) and has a baud rate set to 9600- consult the meter manual for specific information on how to set the network address & baud rate. The data format is 1 start bit, 8 data bit, no parity and 1 stop bit.

Once set, ensure correct interconnection to the RS485 modbus port on the AK-SM.

Modbus#1: use case example – New Carlo Gavazzi meters only

In this use case, only the Carlo Gavazzi meters will be installed on Modbus#1. Using factory defaults for Carlo Gavazzi meter(s) (9600N8) ensure SLV/CSENSE is disabled and no Danfoss devices are connected.

Options when using Modbus Channel 2

The AK-SM 800A Modbus channel 2 is intended to accommodate devices in addition to Danfoss, adding flexibility on multiple Modbus configurations. Within the Configuration → Network Nodes screen, it is possible to define up to 5 Modbus 2 configurations. Depending on selection it may be necessary to manually adjust Carlo Gavazzi meter Modbus settings.

The table below is an example of possible mixing of Modbus devices (higher baud rate device in configuration 1).

MODBUS 2 Danfoss + other devices	Modbus settings	Modbus configuration
Danfoss EKC	38400, E, 8	1
3 rd Party Case controls	19200, N, 8	2
EM511 / EM530 new	9600, N, 8	3
Other..		4
Other..		5

(1) To avoid errors due to the signal reflections or line coupling, it is necessary to terminate the bus at the beginning and at the end (inserting a 120 ohm 1/2W 5% resistor between line B and A in the last instrument and in the Host interface).

(2) The network termination is necessary even in case of point-to-point connection and/or of short distances.

(3) For connections longer than 1200m a signal repeater is necessary.

Once all communication wiring has been set, perform a network scan- details of how to perform network scans can be seen in the Network Nodes Section of this user guide. Ensure MODBUS channel is checked in the Node Overview page.

Configuration → Control → ENERGY
[Danfoss Supported Power meter]

This example highlights a Danfoss supported meter **WattNode + MODBUS**. Having already defined the power meter as 'WN Plus/MB' under the control page, navigate to the Configuration→Control→Energy page. Under type, select WattNode MB (MODBUS).

The physical connection to the MODBUS network should keep the polarity (+ terminal should be to the + terminal on the Wattnode)

- Name:** Enter custom description for meter
- Amperage:** Select the amperage of the CT's connected to the Wattnode +.
- Collect History:** Select yes to collect history from this meter
- Power Update:** Interval to which power is measured.
- Energy Update:** The interval over which energy (the integral of power over time) is calculated.
- Reactive Update:** The interval over which reactive components are recalculated.
- Demand Period:** The interval over which demand is calculated. Demand is defined as average power over a specified time interval.
- Demand Subintervals:** The # of divisions of the demand period used when calculating a "rolling demand" using a "sliding window."

After the relevant Energy control questions have been configured, the meter must have the address correctly configured. To add the WattNode + modbus meter to the AK-SM network, ensure all network wiring is in place and that power has been applied to the WattNode + meter. Navigate to the addresses tab and then enter the same address that is already set in the meter. Perform a network scan to bring the WattNode + meter on line.

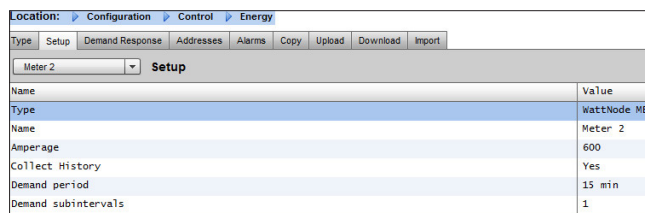

Using the drop down list, the WattNode + meter has been selected.

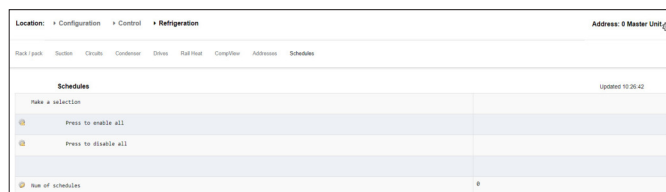

Select the address tab to enter the address which has been assigned in the Wattnode meter (bit switches)

Note: Remember to correctly wire and use the appropriate Modbus port on the AK-SM.

7.7 Energy Measurement / Load shed

Feature Introduction

A new feature introduced in SM800A version 08.053 and above allows the measurement and subsequent load shedding of electrical loads. This feature allows the consideration of tariff data, which can be then used to load shed equipment associated with a digital input. The use of Danfoss AK-IO modules is required for this feature.

Feature highlights

- Measuring period synchronization
- 3 Tariffs in kW (High Tariff, Normal Tariff, Strong Tariff)
- Scale factor for current and voltage transformers
- Pulse / unit

Load shed based on

- Start and stop shed borders
- Shed level
- Min OFF, Pre and Post delay in minutes
- Maximum OFF in seconds

Additional features

- Preset of counters
- Self-synchronization possibility
- Alarm on load shed limit
- Neutral zone in period
- Reset for average, value yesterday, value last week, kWh, kW or all in one go

Configuration

Follow the guidelines in this section in order to configure energy measurement and load shed
 Go to Configuration → Control
 Change the number of meters (max. 80)

Go to Configuration → Control → Energy
 Select Pulse / kW

Go to Tab Setup
 Select Pulse / unit
 Give counter a name and fill in all appropriate details

Self sync Period.

In case the external contact is not working properly, SM800A will synchronize the measuring period internally

Self sync Timeout

If the last time sync is not a self sync timeout, the SM800A will wait for xx sec, before it will synchronize the measuring period internally

Type of metering

Conventional way is unit/pulse. The new way is pulse/unit

Sync.mode

Special: Measuring period syncs on tariff change Normal: Tariff changes after external synch

Pulse/unit

Pulse meter constant

Scale factor

Factor, to adapt the pulse meter constant to current and/or voltage transformers.

Preset counter

Set SM800A kWh to the value of the utility meter. Clear counter will reset the value.

Collect history

Enable SM800A to collect data for consumption view from this particular meter

Use unit for demand limitation

Enable SM800A to use this (and only this) meter for load shed.

Location: Configuration ▶ Control ▶ Energy		
Type	Setup	Demand Response
New metering ▼ Setup		
	Name	New metering
	Selfsync Period	15 min
	Selfsync Timeout	20 sec
	Type of metering	Pulse/unit
	Sync. mode	Special
	Pulse/unit	1000
	Scale factor	200.0
	Preset counter	0.0 kWh
	Collect History	Yes
	Use unit for demand lim	Yes
	Start shedding at	90 %
	Start restoring at	85 %
	Alarm if above	150 %
	Maximum levels	4
	Tariff Limit HT	3600.0 kW
	Tariff Limit NT	4500.0 kW
	Tariff Limit ST	3200.0 kW
	Neutral time	60 sec
	Level time	10 sec
	Period Peak duration	15 min

Start shedding at

SM800A is constantly calculating the energy which is allowed until the rest of the period without the risk to pass the max. limit. In this example the load shed starts if 90% of the max value is reached

Start restoring at

SM800A is constantly calculating the energy which is allowed until the rest of the period without the risk to pass the max. limit. If the energy consumption is decreasing and the system is satisfied with the calculation the restoring of the levels starts. In this example the restoring starts if the consumption falls below 85% of the max value.

Alarm if above

If the system is passing above the limit an alarm will be created. In this example the alarm will be send out if the limit is 50% above the max value.

Maximum level

The system can handle max 4 levels (priorities) for load shed

Tariff limit HT/NT/ST

Maximum value in kW

Neutral time

Time in sec. for the beginning of a period where load shed is inactive

Level time

Time how long the calculation stays in a level before it goes to next level

Period Peak duration

Basis time for calculation on the peak

Addressing:

Go to Tab Addresses and On/Off Inputs to find the addresses for synch and tariffs.

NT does not need an address because it is NT, if it is not HT.

If ST is active it doesn't matter which status NT or HT has.

Location: Configuration Control Energy Addresses	
Controllers Relays Sensors On/Off Inputs Variable Outputs VLT	
New metering On/Off Inputs	
Sort by	Creation
Emergency Switch	Emergency Switch
Broadcast	No
Address	00-0.0
Type	Voltage
Sync. Input	Sync. Input
Broadcast	No
Address	02-2.2
Type	Open
Tariff HT	Tariff HT
Broadcast	No
Address	01-2.4
Type	Open
Tariff ST	Tariff ST
Broadcast	No
Address	01-2.5
Type	Open

7.8 Detail → Energy

Under detail → energy the Sm8xx supports following information to the user:

1. Status
 - a. total consumption since start
 - b. Current power in kW
 - c. Peak power in kW

Status		Updated 11:27:48
AK error	FAULT	
Control status HT	Standby	
Suction temp. To-HT	Null °C	
Suction reference HT	-10.0 °C	
Running capacity HT	0 %	
Requested cap. HT	0 %	
Trec	Null °C	
HP control status	Emergency	
Pgc	Null Bar	
Pgc reference	79.0 Bar	

2. Settings (example shows pulse meter)
 - a. Name
 - b. Window size for demand limit
 - c. Pulse rate in Wh/pulse
 - d. Collect history (yes or no)
 - e. Use this meter for demand limitation

Settings		Updated 11:30:01
Main Switch	ON	

3. Service
 - a. Reset kWh
 - b. Reset peak

Service	
	Press to reset kWh counter
	Press to reset peak kW value

4. Consumption (to present consumption and peak from history)
 - a. View total, monthly, weekly or daily values
 - b. Select time frame
 - i. Total from/to
 - ii. previous month and next month
 - iii. previous week and next week
 - iv. previous day and next day

In case of total view it is possible to delete history for this particular meter.

Consumption	
	Total
First Day	07/11/15
Last day	21/12/15
Total Days	15
Total kWh	9330.0
Avg Daily kWh	622.0
Peak kW	68.0
Occurred	16/12/15
Delete history for this meter	

7.9 Enterprise Load Shed (via Danfoss EDS Service)

Your AK-SM has built in functionality to facilitate enterprise demand limiting, via the Danfoss Electronic Delivered Services (EDS) offering.

Contact your local Danfoss sales rep for more details

The term Load Shed in the AK-SM is used to describe a function that allows an enterprise connection to schedule and actively turn off / on configured electrical loads for a period of time.

Once locally configured, your AK-SM can be fully managed via the Danfoss EDS (Electronic Delivered Services). Once logged on, the demand response enterprise dashboard allows retailers to participate in demand response incentive programs via a single, web-based portal. All site configuration, job scheduling, execution, status monitoring, and meter data extraction is completed from one web application.

Why Demand Response?

Participate in demand response programs.
Quickly curtail energy usage across your enterprise.
Single web portal for all configuration, execution, and utility reporting. For further details, contact your local Danfoss representative.

Minimum requirements:

AK-SM version V08_001 or higher of firmware.
A connection between customer stores and Danfoss EDS –via VPN connection.

Configuration

This section will focus on the local (AK-SM) configuration, and assumes some HVAC and Lighting have been previously configured.

The available load Shed Points (**HVAC, Lighting Zones, Misc**) are configured within the AK-SM. From the Configuration/Control/Energy/Demand Response screen select the **Load Shed** tab. Any previously configured HVAC, Lighting or Misc Relay will be visible.

The example below shows the HVAC and Lighting sections. The two HVAC units are shown and a load shed index of '4' has been entered. The available index range is from 0-4 and once set in the AK-SM is used in the enterprise service to dictate what level of load shed the scheduled job (via the enterprise) will execute. The Lighting tab has been set to load shed level index 3.

Location: Configuration > Control > Energy > Demand Response > Load Shed	
HVAC Lighting Zones Misc Relay	
HVAC	
Name	Value
Unit 1	
Load Shed Level	4
Power Rating	25.0 kW
Post delay	1 m
Unit 2	
Load Shed Level	4
Power Rating	20.0 kW
Post delay	3 m
Location: Configuration > Control > Energy > Demand Response > Load Shed	
HVAC Lighting Zones Misc Relay	
Lighting Zones	
Name	Value
Zone 1	
Load Shed Level	3
Power Rating	0.0 kW
Post delay	0 m

Enter load shed index (0-4)

The power rating slot can be used as a note to what the load is. This has no functional purpose except for notification purposes

Enter a required post delay. This ensures once the load shed event has finished not all system loads will start up at the same time, which could result in electrical overload conditions

Results

Now the AK-SM has been set for load shed, with the appropriate levels set, the enterprise user can now schedule load shed jobs. Once logged in to the enterprise dashboard the user can select multiple sites and select a time and duration, with a load shed level action.

In our example above, if the enterprise user wishes to reduce maximum load for a period of time, a job would be created in the enterprise dashboard and the index '4' would be issued to all selected AK-SM units across the customers estate. The effect is that ALL applications that have an index of 4 and below will turn off for that period of time (and re-start after any post delays). The result in our example here is that all HVAC and lighting will switch off. Another example would be using the load shed index of 3. This would then only shut down ALL applications set at 3 and below. In this example that would be the Lighting, the HVAC would continue to operate.

7.10 Demand Limiting

The AK-SM Demand Limiting function is based on a designated utility power meter. Only one meter can be assigned Demand limiting, even though up to 80 meters can be connected to the AK-SM. Once a meter has been selected, the Demand Limit function can be applied against any Lighting and HVAC load.

Utility demand is monitored every minute. Every minute, the most recent *n* minutes are averaged (where *n* is the width of the configured window, 15, 20, or 30 minutes defined in the meter set up window Configuration → Control → Energy). If the average reaches the configured “start shedding at” percentage of configured maximum demand, Step one (all lighting zones and HVAC units assigned to level 1) will be turned off. After one minute, when the average is calculated again, if the demand is still above the configured percentage of configured maximum demand, level two will be shed, and so on. When demand has dropped to the “start restoring at” level, the last level shed will be restored, and then the others in descending order, so that the last load restored will be the one which was shed first. Restoration will continue as long as the load remains below the “start shedding at” percentage.

If both normal and emergency load limits are to be established, the relative on/off input for the automatic transfer switch must be wired and configured. In addition, if the site has a coupling switch, you must wire and configure an on/off input for the coupling switch.

Priority Levels (normal conditions)

Levels are shed in ascending order: level 1, then level 2, and so on up to the highest level configured, limited by the number of steps allowed. Levels above the number of steps configured will not be shed unless the meter configuration is changed (Configuration → Control → Energy meter setup). Since there are only up to ten steps, loads assigned level 11 will never be shed. It is recommended that loads which are not to be shed are left at level 11, the default value.

Emergency level

The priority for shedding when the emergency generator is running. If a load is assigned level 0 (zero) for either normal or emergency conditions, the load will never come on under those conditions.

Configuration → Control → Energy Demand Limiting

As previously mentioned the Demand Limiting function is applied against HVAC and Lighting loads. This example assumes that both HVAC and lighting have been defined in the AK-SM and that a meter has been selected for Demand Limiting.

Navigate to the Demand Limiting tab. The HVAC and lighting systems will be seen in this page, allowing the configuration of shed levels.

Location: Configuration > Control > Energy > Demand Response	
Demand Limiting Load Shed	
Name	Value
Unit 1	
Shed level	10
Emergency level	11
Unit 2	
Shed level	9
Emergency level	11
Zone 1	
Shed level	7
Emergency level	11

Enter the required Shed levels & Emergency levels for the HVAC & Lighting systems.

7.11 Boolean Logic / Calculations

Calculations

Miscellaneous calculations are used to create custom logic. The AK-SM has the capacity for a total of 96 calculations which can be used to 'drive' miscellaneous logic where special applications are required. There are several ways to formulate calculations for a given requirement, but testing as you go is a 'must' in order to confirm desired results. A calculated point created here can be used anywhere a board & point address can be referenced. The calculated points processor is a true boolean processor, with a full complement of argument types and operators. Every configured calculated point will be listed. The fields are as follows:

New Calc

When first entering the calculations screen a line called New Calc is shown. To configure a new point, double click this field.

Description

The type of point (OI or SI). If an SI, the description will usually include the units.

Point

(Ca-01 to Ca-96) The name of the calculated point.

Value

The current value or state of the point. This will be on or off for OI points, and a value for SI points.

Status

(Online, Offline, Error)

Example of Calculations Tab

Point	Description	Value	Status
New Calc			Updated 13:40:45
Ca-01			

After adding a new calculation, a default screen will be shown (similar to the example below). The screen is divided into three areas, which from top to bottom are the following:

Heading area The heading of the screen tells what type and style of calculation point will be created.

Data definitions area This area contains information that identifies points that will be used in the logical statements in the next area, and the current value of each. The area by default has lines for two definitions, but it can be enlarged by double clicking the *****Press to insert new line*****. You will see this done in a few pages during the presentation of our first example.

Rules area This is the area that will contain the logical statements that determine whether the point is on or off (OI) or the value (SI) that is used. At the bottom of the area is the current value of the result.

Calculation		Updated 13:42:57
Units		OI
Style		Generic
Description		
Datapoint type		ROI (? (error))
Output		Not configured
Datapoint type		
***** Press to insert new line *****		
If (First True line)	Result	Value
ROI _____	Off	?(error)
New		
True	On	On
Current Value (? - Error)		? On

Simple Calculation example:

Calculate the average of 3 different temperature sensors. Show this resulting average value in a miscellaneous sensor driven by the calculation

1. Creating the miscellaneous points for this calculation- Sensor inputs:

Create 3 sensor inputs (the 3rd is used to display the average through the calculation).

Misc	
No. of relay outputs	1
No. of sensor inputs	3
No. of on/off inputs	1
No. of variable outputs	1

2.

Location: Configuration > Control > Misc > Calculations	
Calculation	
Ca-01	Calculation
Name	Value
Units	SI °F
Style	Average
Description	Average 2 Sensors
Datapoint type	SI1 (26.1°F)
Input	01-1.1 Sensor 1
Datapoint type	SI2 (36.7°F)
Input	01-1.2 Sensor 2
Datapoint type	Avg3
SI1 SI2	(31.4°F)
Datapoint type	
***** Press to insert new line *****	
if (First True line)	Result
New	
True	Avg3
Current Value	31.4°F

Location: Configuration > Control > Misc	
Relays Sensors On/Off Inputs Variable Outputs Conv Factors Calculations	
Sensor 7	Sensors
Name	Value
Name	Sensor 7
Bd-Pt	Ca-01
Broadcast	No
Type	Calc (°F)
Number of alarms	0
Sensor fail alarms	Disabled

MISC			
Retrieving data... Unit 0:4			
Unit▲	Name	Value	Alarm
0	Sensor 1	Off	No
0	Sensor 1	26.1°F	No
0	Sensor 2	36.7°F	No
0	Sensor 3	20.3°F	No
0	Sensor 4	29.0°F	No
0	Sensor 5	21.3°F	No
0	Sensor 6	0.0°F	No
0	Sensor 7	31.4°F	No

Chapter 8: Device support

8.1 Danfoss AKC Support (Via AK-PI 200)

The following section describes the configuration of the Protocol Interface -200 (PI-200) in the System Manager. For detailed PI-200 installation instructions and please refer to the PI-200 manual (RS8EX202). The AK-PI 200 is a network device allowing legacy AKC and AKL type controllers to be operated via your System Manager. Any connected DANBUSS controller will be presented similarly to other refrigeration controllers (i.e. LON RS 485 / MODBUS devices).

Note: PI-200 must have firmware 2.25 installed to ensure correct operation and communication with AKC devices and AK-SM 800A.

Important limitations

Up to 60 AKC controllers can be connected to a single AK-PI 200. If there are more than 60 controllers, two AK-PI 200 units must be used. Up to four AK-PI 200 units can be connected to a single System Manager.

The link between the System Manager and the AK-PI 200 is via a TCP/IP. Ensure when connecting your AK-PI200 to the network be sure to use a router or switch, not a network hub. The AK-PI 200 will not function correctly if network hubs are used.

Preparation / Addressing

Both the System Manager and the AK-PI 200 must have valid addressing set before any configuration can take place. Consider the following steps when setting up your System Manager and PI-200.

1. Ensure System Manager has a valid IP address and is connected on the LAN.
2. Use AK-Service Tool and make direct connection to the PI-200, under IP setup check correct IP address mode (Dynamic/Static), Port Number (default 1041 in PI-200 and System Manager).
3. Set physical Danbuss address for PI-200 by using the rotary address switches on the PI-200. A unique address must be assigned for PI-200, with no duplicate with generic devices on any field bus'.

PI-200 configuration in System Manager (via web wizard)

The following text will describe the workflow when adding PI-200(s) to your System Manager, including scanning and mapping of AKC devices.

Note: Using the layout wizard assumes no other Refrigeration configuration has been previously performed. Using the wizard on a pre-existing configuration may result in loss of configuration, use manual method described in this user guide.

Under the 'Configuration' tab, locate the Refrigeration 'Layout' wizard, and start the process, under the network screen select the PI-200 to enabled.

The next screen shows details of the PI-200. If multiple PI-200 units are installed you should select only the PI units which will be associated with the particular System manager.

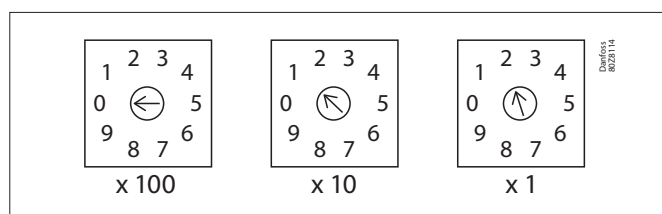
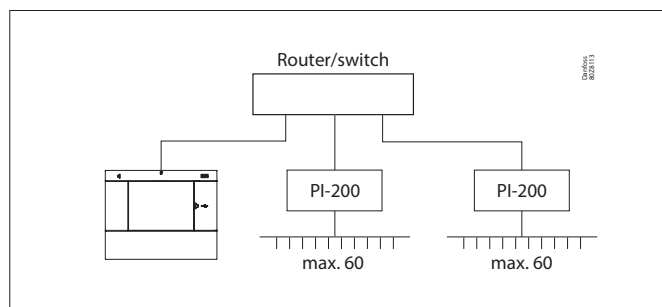

Channel LONWORKS	Enabled
Channel MODBUS-RS485	Disabled
Channel SNMP	Disabled
Channel PI-200	Enabled
Port	1041

Make a selection			
Press to select all			
Press to deselect all			
Make a selection			Unlock
Addr	Model	IP Address	Select
151	080Z8521	10.35.36.5	Selected
153	080Z8521	10.35.36.127	Selected

Follow the remaining wizard screens to format device names and map case to pack controls to form suction 'groups'.

PI-200 configuration in System Manager (via manual configuration)

If there are existing devices already on your System Manager you may want to manually add the PI-200 / AKC via the manual method. This section covers how to scan PI-200 and configure the AKC nodes.

1. Via the Configuration → Network Nodes tab, select Channel PI-200 (checking correct port address, as previously described)
2. Initiate a network scan by selecting the 'Press for complete rescan' line entry
3. Under the Scan Status tab navigate to the PI-200 sub tab, here any detected PI-200 units will be shown and can be selected for use with the System Manager.
4. Under the 'PI-200 Status' sub tab you can view the address, version, status, signal quality and number of devices under each PI-200.
5. Once the above process is complete the next step is to define the number of devices you wish to add to the System Manager. Under the Configuration → Control tab enter 'Number of racks/packs' and select the relevant Pack controller. Tip! Use the 'show only scanned devices' line to only show only the controllers that the System Manager has previously scanned, this will reduce the list of available devices to select from.
6. Navigate to the Refrigeration → Circuits tab to set which case type is to be used

The remaining configuration tasks are already described earlier sections of this user guide.

Node Overview	Status	IP Address
Channel LOGS001	Enabled	
Channel LOGS002	Enabled	
Number of packs	1	
SUVC0000	No	
Channel SWP	Enabled	
Rescan Range Type	IP Address	
IP Network P012	1	
IP Address Range0 Low	10.7.58.70	
IP Address Range0 High	10.7.58.80	
IP Address Range1 Low	10.7.58.210	
IP Address Range1 High	10.7.58.220	
IP Address Range2 Low		
IP Address Range2 High		
Channel PI-200	Disabled	
Press for complete rescan		
Last scan	10/01/20 10:21	

Name	Count	Signal
ESP Board	0	0
R10 Board	0	0
R20 Board	0	0
V10 Board	0	0
VLT	0	0
Pressure sensor	0	0
Light Panel	0	0
ESP10	11	11
AK-01	0	0
CaseType001	1	N/A

Name	IP Address	Status
Make a selection		
Press to select all		
Press to deselect all		
Make a selection		Unlock
ADD: P040	IP Address	
0127 0003012	10.7.58.103	Selected

Presentation of the AKC devices

Once connected to the PI-200 and configured, the AKC devices will be represented in the same format as any other refrigeration device. The AKC devices will be shown in the main screen dashboard under Refrigeration. Selecting a device will then show the device detail screen, where (if authorized) the user can view and make setpoint changes.

Note: The response times over a Danbuss network and via the PI-200 is somewhat slower than traditional LonWorks networking, any delay in retrieving data is not an indication of system fault, but due to Danbuss network performance.

Monitoring Points

Your AK-SM offers a simple yet effective way to display temperature sensors that also include dedicated alarming and inhibiting functions. The following section describes the configuration of monitoring points and their associated functions.

Adding monitoring points manually

From the Configuration → Control menu select the required amount of circuits, then navigate to the Refrigeration → Circuits page and under type, select 'Monitoring'. The selection of 'Monitoring' in the drop down selection list offers the user a means to capture, record and display sensors and to present them in the 'Misc' section of the home dashboard screen. This method of sensor input is in addition to the miscellaneous sensor inputs used elsewhere in the AK-SM system and can be used to monitor board & point inputs or sensors from connected network controllers (i.e. AKC, AK2, EKC).

Once set to Monitoring navigate to the Setup tab, using the drop down menu to select the recently defined monitoring points.

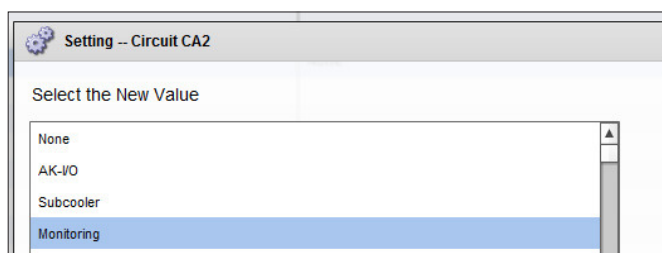

Location: Configuration > Control > Refrigeration > Circuits

Type Setup Alarms Copy

Monitoring 3-1 Setup

Name	Value
Monitor temp input	Yes
Monitor defrost input	Yes
Post defrost alarm delay	30 min
Generate cleaning input	Yes
Post clean alarm delay	15 min
Monitor digital input	Yes

Inputs

Name	Value
Monitoring 3-1	
Bd-Pt	00-0.0
Broadcast	No
Type	PT1000
Name	Defrost 3-1
Bd-Pt	00-0.0
Broadcast	No
Type	Voltage
Name	Clean 3-1
Bd-Pt	00-0.0
Broadcast	No
Type	Voltage
Name	Digital 3-1
Bd-Pt	00-0.0
Broadcast	No
Type	Voltage

Location: Configuration > Control > Refrigeration > Circuits

Type Setup Alarms Copy

Monitoring 3-1 Alarms

Name	Value
Low Temperature: Monitoring 3-1 00-0.0	Disabled
High Temperature: Monitoring 3-1 00-0.0	Disabled
Defrost input: Defrost 3-1 00-0.0	Disabled
Monitor Input: Digital 3-1 00-0.0	Disabled

To setup monitoring points follow the 'standard' method in refrigeration configuration - Main Menu / Configuration / Refrigeration / Add Controls. Answer 'No' to the question 'Pack controller required?' and navigate to the lower section of the screen and describe how many monitoring sensor points are required (still described as No of case controllers.?)

Click on the Setup button and then select the **Type** drop down list Choose **Monitoring** from the drop down list

Monitor temp input

Select 'Yes' to allow monitoring of a board & point sensor or a sensor via a connected network controller

Defrost Input

If required a Defrost input can be configured. A Defrost input would be used to effectively inhibit the alarms whilst the equipment was in 'defrost mode'. Once a Defrost input has been configured it can be used in conjunction with further sensor setups (select Existing option for this)

No: No Defrost input required

Yes: Define Defrost input

Existing Pick from previously set Defrost inputs

Monitoring setup page

Monitor temp input

Select 'Yes' to allow monitoring of a board & point sensor or a sensor via a connected network controller

Post defrost alarm delay

Enter the required time delay that the AK-SM 800A will apply after it has detected a defrost has completed - this can stop nuisance alarms

Generate Cleaning input

Select 'Yes' if a cleaning input is required (typical example could be voltage or switch). When the assigned switch is made the monitoring point will detect this change of state and will stop any alarms from being transmitted. After the cleaning input is re-set any future alarms will be transmitted - after any post clean alarm delay timer has elapsed.

Post clean alarm delay

Enter the required time delay that the AK-SM 800A will apply after it has detected the cleaning input has reset

Monitor digital input

Select 'Yes' to allow monitoring of a digital input via a board & point input or a digital input via a connected network controller

Input configuration

After selecting 'Yes' to any of the questions in the upper part of the monitoring configuration screen the resulting input is shown below.

A custom name can be given to each input. For each input enter the corresponding board & point address for local I/O to enter a controller address (see next section for further details on entering controller address). Finally make sure the type is correctly defined for the input (via a drop down list). Page Down to define any alarms for the inputs. Continue to configure any remaining sensors, once complete you can view the sensors in the Evap Overview list, via the Main Menu. As in the generic format simply click on the sensor to view a summary screen. The detail page for the monitoring point contains current status & temperature, the ability to inhibit (stop alarm from occurring) and alarm settings (if configured).

Additional monitoring of dedicated HACCP sensors

Using the monitoring feature as previously described, dedicated HACCP sensors can be displayed in the main Dashboard overview screen and subsequently logged for history and alarm limits can be assigned.

Danfoss offers a dedicated HACCP sensor (AK-HS 1000) which is supported by some of the evaporator range of AK-CC controllers. In this example the AK-CC 550 evaporator controller will be used to highlight the required steps to monitor this dedicated HACCP sensor. In the example below an amount of (AK-CC 550) evaporator controllers have been defined and a corresponding amount of monitoring points also defined. Once in the monitoring point configuration screen select 'yes' to the question 'Monitor temp input'. Enter a suitable name for the sensor (Case 1 HACCP in this example) and add the relevant controller network address in the form of 001:1 is controller address 1, 002:1 is controller address2... The principle is that by adding the controllers address in the Bd-Pt box the parameters for that controller become available. The final step is to define the HACCP sensor connected to this AK-CC550 (parameter u56 in this example) -this is done via the drop down list against the Pt# line. Page down to set any alarms associated with this sensor and duplicate for the remaining monitoring points - using the relevant controller address to access the parameter list. The defined HACCP sensors will now be seen in the Evap overview screen and can also be set for history collection.

8.2 Service Tool Support

Your AK-SM 800A supports the latest Danfoss Service Tool version. It is important to note that this version of the Service Tool supports encryption and authentication, as required by the AK-SM 800A – versions below this will not work.

The Service Tool (CT) must be connected via an IP interface. Once an connection is established the ST will show the AK-SM and all AK2 platform devices. Note that non AK2 platform based devices will not show up in the ST device list.



When creating a new connection in your ST make sure you select TCP/IP channel.

Enter username and password that reflects a supervisor level in the AK-SM 800A you are connecting to.



Once connected, navigate to your required controller in the available list. Access to all AK2 parameters is available via this connection.

8.3 CoreSense™ (MODBUS) Support

Danfoss AK-SM 800A series version 08.053 and higher supports select Emerson modules within the CoreSense™ range. In particular, the following two module types are supported (see important notes below for supported versions).

CoreSense™ Protection for Discuss Compressors

Module type R112 (529-0170) is supported via the available device file;

529-0170 CSProtect 512 0 25 001x 529-0170.ed3 |(529-0170) CSProtection for Discuss

CoreSense™ Diagnostics

Module type R1011 (526-9996) is supported via the available device files;

526-9996 CSDiagnost 512 0 25 001x 526-9996.ed3 |(526-9996) CSDiagnostics for K5

526-9998 CSDiagnost 512 0 25 001x 526-9998.ed3 |(526-9998) CSDiagnostics for K5

Only the above versions of CoreSense™ Protection modules are supported, please observe the following requirements. CoreSense™ Modules that have 10 dip switch must have firmware version F33 or newer.

CoreSense™ compressor support requires a valid MODBUS network to be in place, following standard MODBUS topology rules (point to point, no star connections). Ensure each module follows the manufacturer's recommendation for unique addressing (via module) bit switch and correct terminal wiring. Ensure the last node on the MODBUS network has 120 Ohm resistor in place.

Each module must be set for 'Stand Alone Mode', else invalid module alarms will occur. To set the modules for 'Stand Alone Mode' use the relevant bit switches on the module-refer to the CoreSense™ user guide for more details.

Once all network cabling, node addressing, and Stand Alone Mode are defined, the SM800A can now scan the MODBUS network to discover the nodes. Enter valid authorization and navigate to the Network Nodes screen. The Channel MODBUS RS-485 must be enabled and 'SLV/CSENSE' must be set to "Yes" for the 19,200 Baudrate (default Baudrate) before pressing rescan. The MODBUS address must be unique across all channels.

After the rescan is completed, verify the "Nodes Scanned on Network" for the new scanned nodes. Also, verify the "Generic" Node types for the new scanned nodes after a successful rescan. The address, type and the software version of the detected Coresense™ modules can be viewed under the Configuration → Network Nodes → Scan Status tab.

Once the scan is complete, the Coresense™ modules can be configured under the "Configuration→Control→Refrigeration" tab of the SM800A series Control Tab. The number of Coresense™ modules to be configured must be entered for each suction group. Select the relevant ED3 file for the module (under the "Type" Tab Configuration → Control → CompView → Type for each configured Coresense™ module). Enter a unique address for each Coresense™ module under the "Addresses" tab. Under the "Setup" tab it will show 6 other tabs to:

1. Alarms: Enable or disable the alarms for a generic device
2. Copy: Copy devices in the offline configuration
3. Upload: Upload the parameters from the device
4. Download: Download the parameters to the device
5. Import SI: Import the parameters as SI
6. Import OI: Import the parameters as OI

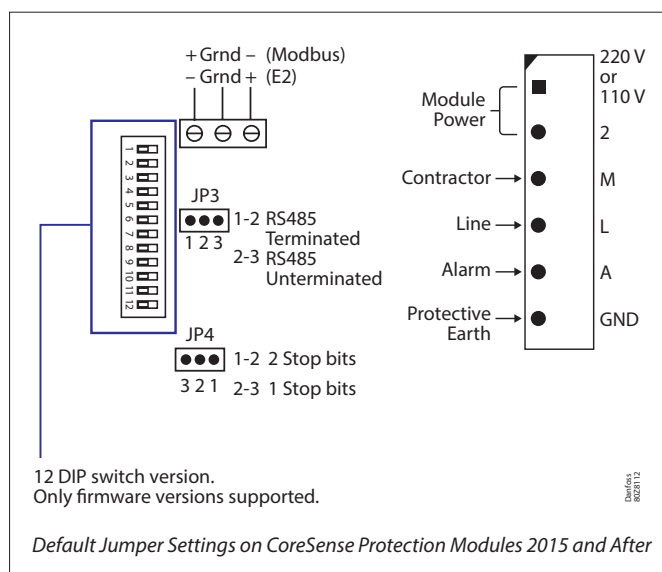
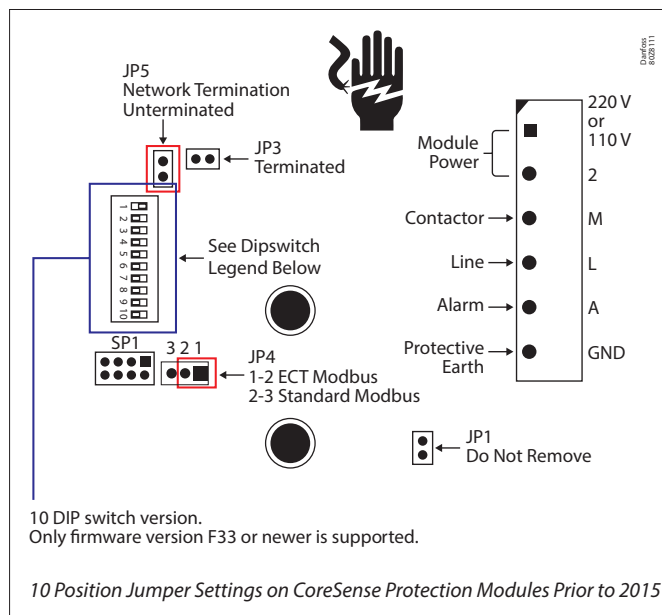

8.4 Technical data

AK-SM 800A version comparison	AK-SM 820A Small store	AK-SM 850A Refrigeration	AK-SM 880A Full
Refrigeration Control			
All AK-SM 800A variants come with Centralized I/O and Pack / Case control options. EKC AK2 SLV FC102	Max. 32 generic device support	Max. 170 generic support (see 8.7 Specifications)	Max. 170 generic support (see 8.7 Specifications)
Lighting Control			
All AK-SM 800A variants come with built in lighting control via I/O modules. The number of zones differ.	10	30	30
HVAC			
Only the AK-SM 820A and AK-SM 880A support built in HVAC control via I/O	10	n/a	45
Alarms			
Capacity	500	500	500
Miscellaneous points (via IO modules)			
Relay (R), Sensor (S), ON / OFF (O / F), Variable (V)	R=20, S=20, O / F=20, V=20	R=70, S=80, O / F=70, V=70	R=70, S=80, O / F=70, V=70
Master control			
Po Optimization, Master Schedules, AKC ON Note: Adaptive Defrost not currently supported	Yes	Yes	Yes
Misc Calculations			
Boolean Logic statements	96	96	96
History			
The AK-SM 800A has the ability to record datapoints for history and view	3000 points	3000 points	3000 points
History HACCP	200 total points	200 total points	200 total points
Leak Detectors			
Refrigerant gas detectors (connected via AK I/O)	10	50	50
Energy Meters			
Pulse Input (via I/O module), Carlo Garvazi, Wattnode, Wattnode Plus MODBUS, Veris MODBUS, Schneider PM3255 and iEM3250	32	80	80

8.5 Generic capacity-A

Features	Max # of nodes	Modbus properties
Danfoss Modbus		
Danfoss Modbus controller devices (EKC, AK-CC, AK-PC 3,4,5x, MCX)	170	PARITY_EVEN, 38400, DATA_8_BITS
Danfoss Gas Sensors (DGS)	50	PARITY_EVEN, 38400, DATA_8_BITS
Danfoss SLV, WattNode MODBUS (MODBUS)	120	PARITY_EVEN, 19200, DATA_8_BITS
Danfoss SNMP		
Danfoss SNMP controller devices	160	n/a
Danfoss Lon (RS485/TP78)		
AK2 Multi-Case controllers (max per front end / no further generic devices allowed)	60	n/a
AK2 Pack Controllers	12	n/a
Danfoss Danbuss (Legacy AKC)		
Danfoss Danbuss via PI-200 (max X4 PI-200 per front end)	120	

8.6 Generic capacity-B

Typical mix examples	Field bus deployment examples
Danfoss Pack (x12) + Danfoss Case (x158) = 170 max	12 LonWorks, 120 Mod#1, 38 Mod#2
Danfoss Pack (x10) + Danfoss Case (x110) + Danfoss Gas sensors (x50) = 170 max	10 LonWorks, 120 Mod#1, 40 Mod#2
Danfoss Pack (x10) + Danfoss AK2 Multi-Evap Case (x50) = 60 max	60 LonWorks
Danfoss Rack I/O (x12) + Danfoss Case (x170) = 170 max	LonWorks, 85 Mod#1, 85 Mod#2

Note: Max. 120 Modbus nodes per Modbus channel (170 max. in total between Mod#1 and Mod#2).

Note: Software Package 4.0 and above supports 160 circuits per Pack suction group.

8.7 Specifications

Data communication			
Ethernet (WAN/Host network)	1		
Ethernet 1 (AK-Pack IP field bus)	1		
USB	2 (Host) + 1 (800 mA)		
Wi-Fi (Point-to-point access)	1		
Alarm relays	2 Contact voltage: up to 240 V, Current rating: max. 5 Amp for AC-1 (Ohmic load), Max. 3 Amp for AC-15(inductive load)		
Field Bus Support			
RS485 Modbus	2		
RS485 LON	1		
TP78	4 (optional code #)		
CANbus	1 (future)		
Ethernet 1	1		
Hardware specifications			
Enclosure	IP20		
Dimensions (WxDxH)	295 mm (11.6") x 65 mm (2.5") x 235 mm (9.3")		
Weight (gross)	2,408 kg		
WiFi transmitter			
WiFi Type	Wi-Fi Access Point		
Transmitter type	Wi-Fi 2.4 GHz / 5 GHz (IEEE 802.11a/b/g/n/ac)		
Transmit Frequency	2412 – 2472 MHz, 4900 – 5925 MHz (frequencies limited by Software)		
Receive Frequency	2412 – 2472 MHz, 4900 – 5925 MHz		
Antenna Gain	2.4 GHz gain: 1.8 dBi, 5 GHz gain: 4.9 dBi		
Communication standards			
Modbus			
Modbus IP (Danfoss AK-CC55 controls)			
Lonworks			
Danbus (via PI-200)			
SNMP			
AK-Pack IP controller (UDP/TCP)			
Port	Description	Use	User Configurable
5136	UDP	SNMP	No
1041	UDP	PI-200	No
443	TCP	HTTPS Secure Web browser communications	Yes
80	TCP	HTTP Web browser communications	Yes
5003, 5005	UDP	Host network communication UDP ports	No

9. Ordering

Contact your local Danfoss sales office.

Variants with LON Modules

Type	Description	Code no.
AK-SM 820A	C-Store (Refrigeration / HVAC / Lighting)	080Z4024
AK-SM 850A	Refrigeration (including Lighting)	080Z4021
AK-SM 850A - no WiFi	No Wi-Fi, Refrigeration (including Lighting)	080Z4022
AK-SM 880A	Full (Refrigeration / HVAC / Lighting)	080Z4028
AK-SM 880A - TP78	Retro-fit Full (Refrigeration / HVAC / Lighting)	080Z4029

Variants without LON Modules

Type	Description	Code no.
AK-SM 820A	C-Store (Refrigeration / HVAC / Lighting)	080Z4044
AK-SM 850A	Refrigeration (including Lighting)	080Z4041
AK-SM 880A	Full (Refrigeration / HVAC / Lighting)	080Z4048

10. Document history

Document	Notes
BC337629891709en-000101	First document release
BC337629891709en-000201	Updated for the release of ver. 2.0
BC337629891709en-000301	Updated for the release of ver. 3.0
BC337629891709en-000401	Revised IP port table / minor updates
BC337629891709en-000501	Updated for the release of ver. 3.2x
BC337629891709en-000601	Updated for the release of ver. 3.3x
BC337629891709en-000701	Updated for the release of ver. 4.0
BC337629891709en-000801	Updated for the release of ver. 4.1

11. Glossary of terms

Viz	Visual file. Used in the RMT tool and sent to the AK-SM for graphic Site View
System View	Central page of AK-SM that displays all configured control points
Site View	Custom graphic page with mapped system parameters
AK I/O	Danfoss AK Input / Output modules
Bd-Pt	Board & Point address location
Alarm Levels	Disabled = no alarm action Log Only = logs alarm in database - no external action Normal = Activate alarm output (once) Severe = Activate alarm output (repeat based on severe repeat time) Critical = Activate alarm output (repeat based on critical repeat time)
IP	Internet Protocol
EDF/ED3	Extended Device File (a file that represents the physical device)
CAT (seen in EDF list)	Category (1=Evap, 2=Pack, 8=HVAC, 16=Energy meter, 34=AKD102)
Relative schedule	When set a relative schedule will offset against the operating hours (set under config/time)
Host Communications	The connection (via Ethernet) of one or more AK-SM units. The connection between units is known as 'host network'
Danfoss	http://danfoss.com
Danfoss Software	http://food-retail.danfoss.com/knowledge-center/software/ak-sm-800/
Veris Industries™	http://www.veris.com/
Carlo Gavazzi™	http://www.carlogavazzi.com/
Continental Control Systems™	http://www.ccontrolsys.com/w/Home
CALM	CO ₂ Adaptive Liquid Management
ALC	Adaptive Liquid Control
Bluetooth®	The Bluetooth logos and word marks referenced in the Services and Content are the trademarks of Bluetooth SIG and its affiliates.
Session control	Session control in the AK-SM 800A is an authentication rules engine/module and is intended to improve the overall security posture of your system. Session control offers different configuration settings (Backward compatibility, Permissive and Strict), When configured to Permissive or Strict, Northbound communications require HTTPS and encryption of all data ensuring that XML requests do not contain usernames and passwords, thus enhancing the overall security of your system.

Danfoss A/S

Climate Solutions • danfoss.com • +45 7488 2222

Any information, including, but not limited to information on selection of product, its application or use, product design, weight, dimensions, capacity or any other technical data in product manuals, catalogues descriptions, advertisements, etc. and whether made available in writing, orally, electronically, online or via download, shall be considered informative, and is only binding if and to the extent, explicit reference is made in a quotation or order confirmation. Danfoss cannot accept any responsibility for possible errors in catalogues, brochures, videos and other material. Danfoss reserves the right to alter its products without notice. This also applies to products ordered but not delivered provided that such alterations can be made without changes to form, fit or function of the product.
All trademarks in this material are property of Danfoss A/S or Danfoss group companies. Danfoss and the Danfoss logo are trademarks of Danfoss A/S. All rights reserved.