

Installation Guide

Remote Control TM70 and Ikontrol

Danfoss does not take responsibility for incorrect installation or any frequency interference.

Chance of unintended machine movement on start up.
Ensure the machine is stopped for the entire duration of the assembly process.
Keep the work area free and wear protective clothing.

Connect the power supply and the output connections using the connection block diagram provided with the system. The receiver will enter into scanning mode and show the following:

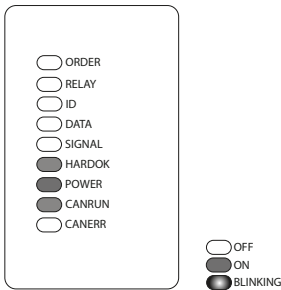

LED scanning mode (receiver)

LED	Description
DATA	There is not another system active in the area
SIGNAL	OFF; channels are signal free BLINKING; RF signal detected on the channels
HARDOK	GREEN; Absence of faults on the boards
POWER	Power supply OK
CANRUN	Communications with expansion boards are OK*

* Only in receivers with CAN connection (except RCAN)

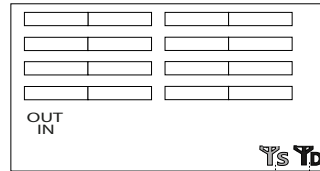

RF signal detected:
Incorrect ID signal from Ikusi system:
ABC CORRECT ELEMENTS
ABD INCORRECT ELEMENTS - Check troubleshooting guide

Display scanning mode (receiver)

1. Place a charged battery in the transmitter
2. Turn the contact key
3. Push and pull out the STOP button
The LED of the transmitter will flash orange-green. If the transmitter has a display, it displays the identification of the machine, as well as the battery level
4. Press the start button
The green LED should now light indicating the transmitter is transmitting
5. Turn off the transmitter using the STOP button

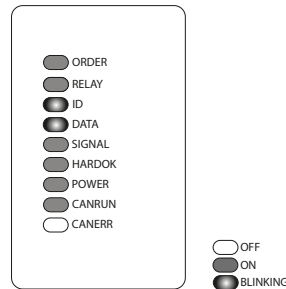

LEDs operational mode (receiver)

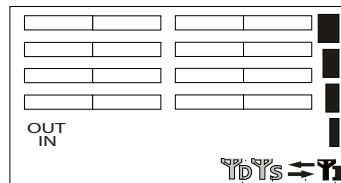

Incorrect ID (the icon shows the quality):
No Ikusi RF signal detected (the icon shows the quality):
Linked state:
Correct ID (the icon shows the quality of the link):

Display operational mode (receiver)

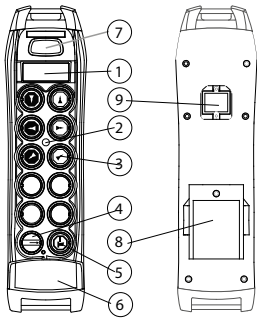

TM70 hand-held transmitter

1. Label for crane identification
Optional: display LCD
2. LED
3. Maneuver button
4. Contact key
5. Start button
6. STOP button
7. Optional: range limiter
8. Battery
9. Removable EEPROM

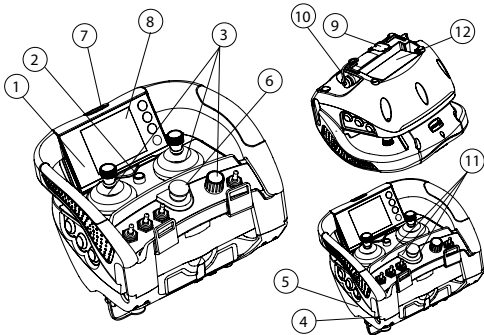

Ikontrol console box transmitter

1. Label for crane identification
2. LED
3. Maneuver element
4. Contact key or multi-key
5. Start button
6. STOP button
7. Optional: range limiter
8. 3.5" color TFT display (IK3); LCD monochrome 128x64 (IK2)
9. Removable EEPROM
10. Tether connection

11. Lateral push buttons

12. Battery

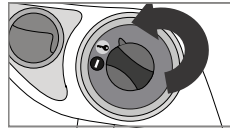

Contact key

Insert the multi-key and turn the position from 0 to 1. The machine will not operate in 1 position as this is the natural position of the multi-key.

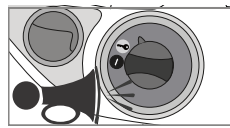

Start/horn

In position 1, release the STOP push button and push start so the transmitter starts emitting. The multi-key can also be used to activate maneuvers such as the horn signal.

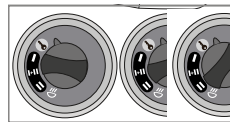

Toggle switch

The multi-key can also work as a toggle switch, configurable up to 5 positions.