

User Guide

Gateway Unit Type **X-Gate**

SW Ver. 5.20

Configurable gateway device for field integration



Contents

1. Introduction	3
2. Installation	3
2.1 First time configuration	3
3. System Access	4
3.1 Login	4
3.2 Network Overview	4
3.3 Network Alarm	5
3.4 Event Log	5
4. User Configuration	6
4.1 User List	6
5. Network Configuration	6
5.1 Device List	6
6. X-Gate set-up	7
6.1 Supervisor	7
6.2 Other	8
6.3 Services	8
6.4 Client Fieldbus	8
6.5 Server Fieldbus	9
7. CDF Editor	9
8. Customization of HTTP user interface	14
9. Use Cases	15
9.1 Use Case 1: Source BACNET & Destination MODBUS	15
9.2 Use Case 2: Source CANBUS & Destination MODBUS	16
9.3 Use Case 3: Source MODBUS & Destination MODBUS	17
9.4 Use Case 4: Source XML Interface & Destination MODBUS	18
10. Update	18
10.1 X-Gate Software	18
10.2 CDF Files	18
11. Annexure	19
11.1 Supported BACNET features	19
11.2 Supported BACNET properties	19

1. Introduction

X-Gate is the new Danfoss gateway, designed to support and make easy the “Integration” activity at field level.

X-Gate can manage mainly two kinds of integrations:

- At **south-bound level**: Capability to read from electronic devices with different protocols: Modbus RTU, Modbus TCP/IP, BACNet IP, BACNet MS/TP, CANBus and translate into another protocol suitable for the integration at monitoring system level. Typical Modbus RTU.
- At **north-bound level**: Capability to read the Open XML protocol from System Manager 800A and expose the normalized data-points on different protocols: Modbus RTU or TCP/IP, BACNet IP for an “on top” BMS.

DISCLAIMER: Professional Use Only

This product is not subject to the UK PSTI regulation, as it is for supply to and use only by professionals with the necessary expertise and qualifications. Any misuse or improper handling may result in unintended consequences. By purchasing or using this product, you acknowledge and accept the professional-use-only nature of its application. Danfoss does not assume any liability for damages, injuries, or adverse consequences (“damage”) resulting from the incorrect or improper use of the product and you agree to indemnify Danfoss for any such damage resulting from your incorrect or improper use of the product.

Use Cases Scenarios

Following the typical use-cases scenarios where X-Gate can fit:

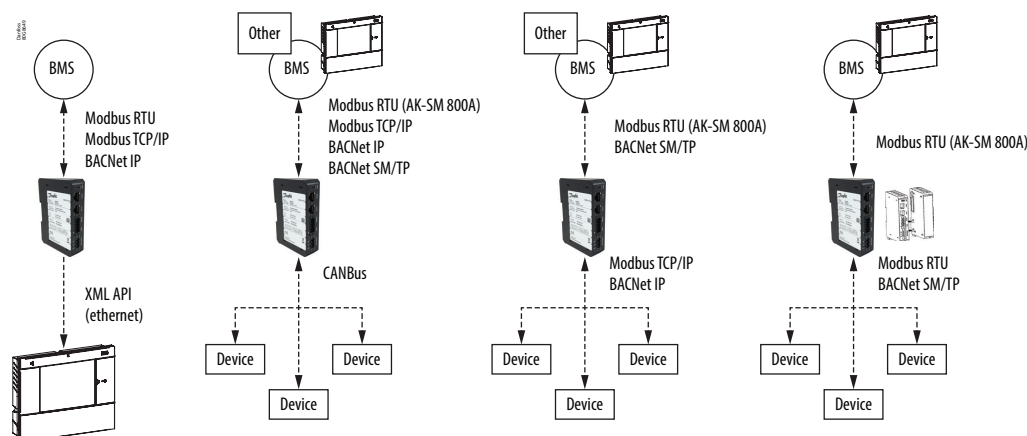

X-Gate can provide flexibility with focus on 3rd party device integration into System Manager and at the same time make easy for a BMS to integrate the desired data-points over standard protocols.

2. Installation

For the installation phase of X-Gate please refer to the standard “Installation Guide” provided inside the packaging.

2.1 First time configuration

X-Gate has a Web User Interface, that can be accessed using standard browser.

The X-Gate starts in DHCP mode to be easily connected to an existing network. To discover the IP address of X-Gate in the network, User can plug an USB pen-driver and perform the following steps:

On your PC:

- Insert a USB memory stick.
- Make sure the USB stick is formatted as FAT or FAT32.
- Create an empty file in the root named node_info.txt.
- Unmount and remove the USB memory stick from your PC.

On your X-Gate:

- Power-up the X-Gate
- Insert the USB stick into the USB connector of the X-Gate.
- Wait about 10 seconds (X-Gate will write the information in automatic mode into the txt file).
- Remove the USB stick and insert into your PC

The file node_info.txt will contain the basic information about the X-Gate. Here is an example of the content:

```
[node_info]
ip=10.16.176.86
mac_address=02:50:41:00:00:01
sw_descr=X-Gate v.1.10 (180628.1713)
```

The file contains information on IP and MAC-ADDRESS of X-Gate.

After got the IP address of X-Gate in the network, User can connect using browser by typing the following URL: <http://10.16.176.86>

If you connect direct to X-Gate to PC via ethernet cable on ETH2, you will find the X-Gate at IP address 192.168.2.101.

3. System Access

3.1 Login

To access to the main configuration section of X-Gate, a login is required with User & Password.

Default account is "admin" with default password "PASS".

For security reason, after 3 attempts to enter a wrong password, X-Gate will lock access for 10 minutes. The default login credentials must be changed in User Configuration menu.

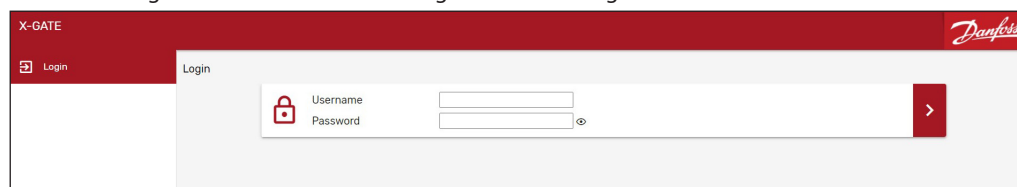

After first login, we strongly suggest changing default password to prevent unauthorized access.

After login into the system, User can access to the configuration options according to the user-profile.

3.2 Network Overview

"Network Overview" is the landing page after login. It contains the list of the devices (Node) connected to X-Gate, plus the X-Gate itself.

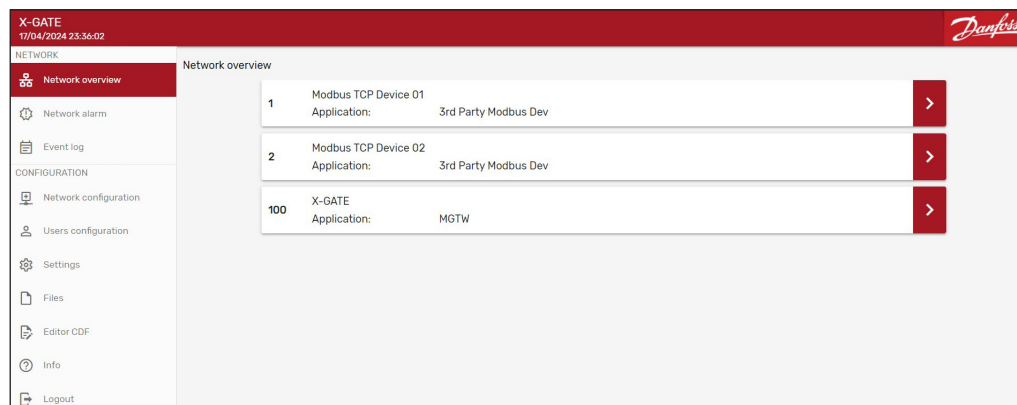

3.3 Network Alarm

Network Alarm page contains the real-time alarms list of the X-Gate device. It can be used to troubleshooting in case of problems in the installation.

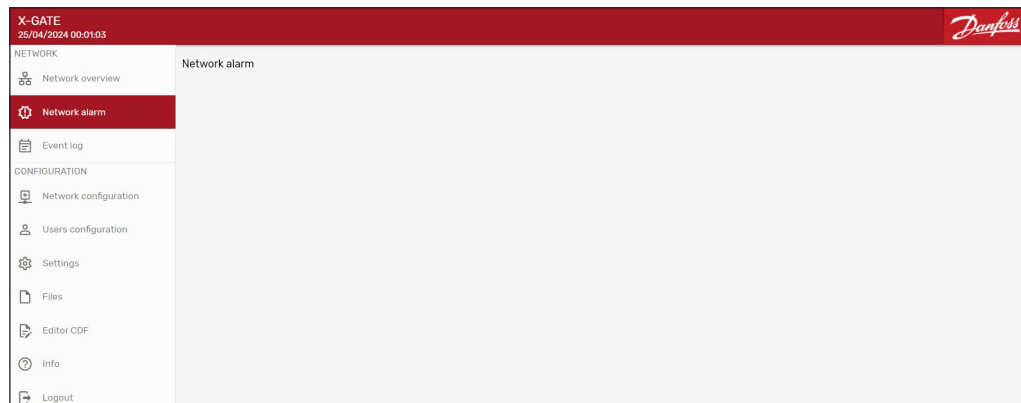

If parameter “G17 Enable alarm history” is enabled, an history of cleared alarms and other events will be kept into X-Gate.

The following events are recorded:

- Alarm start/end.
- Alarm acknowledges.
- Power-up
- Change of parameter
- Firmware updates
- Time change
- Security threat

3.4 Event Log

The event page traces the events of the X-Gate. User can save the event log list into a csv format.

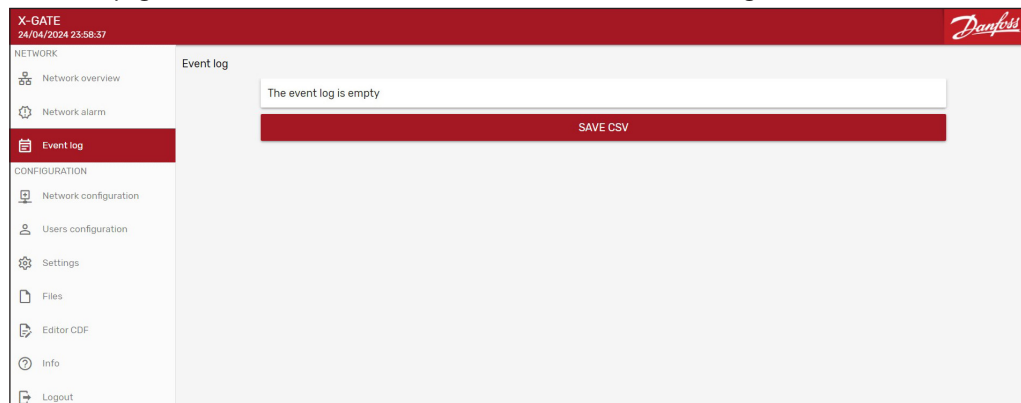

4. User Configuration

4.1 User List

Accounts list can be accessed from the User Configuration page. By default, 4 users are available in the system: admin, Manufacturer, Service and User.

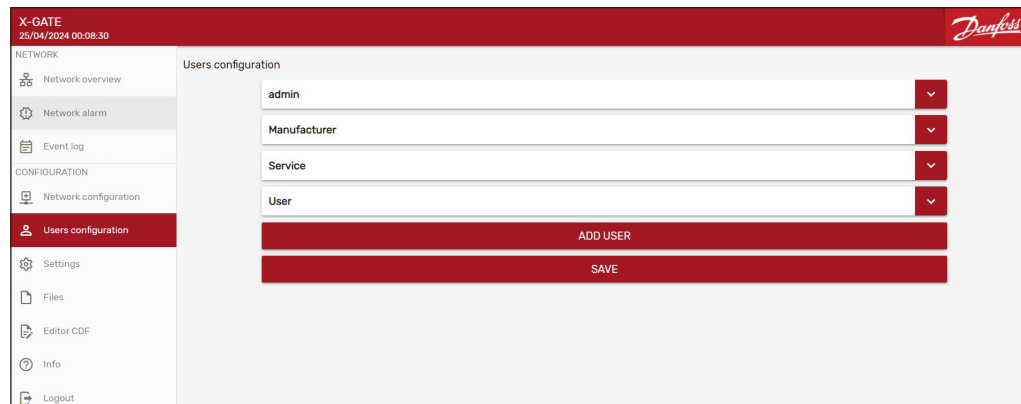

All the Accounts has a dedicated profile to have different visibility inside the X-Gate configuration page. Profiles available are **Maintenance** and **Service**.

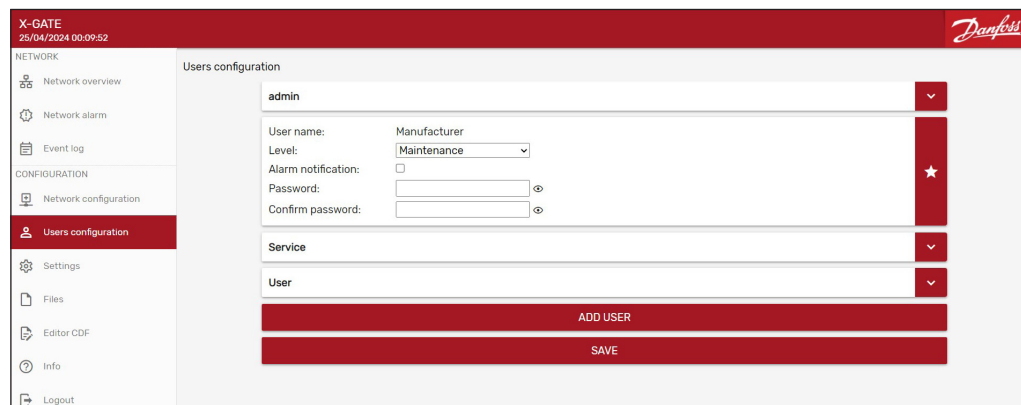

The User Configuration page provides the following features:

- “Add User” button: To add a new user to the system.
- Delete “—” button: to delete the single user.
- “Save” button: to commit of the modification done.

5. Network Configuration

5.1 Device List

Device (Node) list can be accessed from the Network Configuration page. The default Device present is the X-Gate itself with his own configuration.

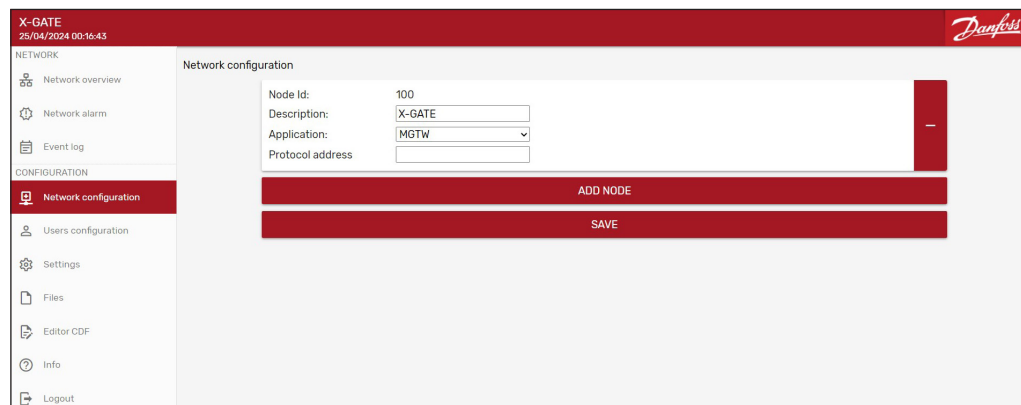

To add a new device, “Add Node” button that provides the information needed:

- Node Id: the serial address of the device
- Description
- Application: the device profile with the list of the data-points to read
- Protocol address: in case of TCP/IP protocol like Modbus, it is the IP address of the device itself.

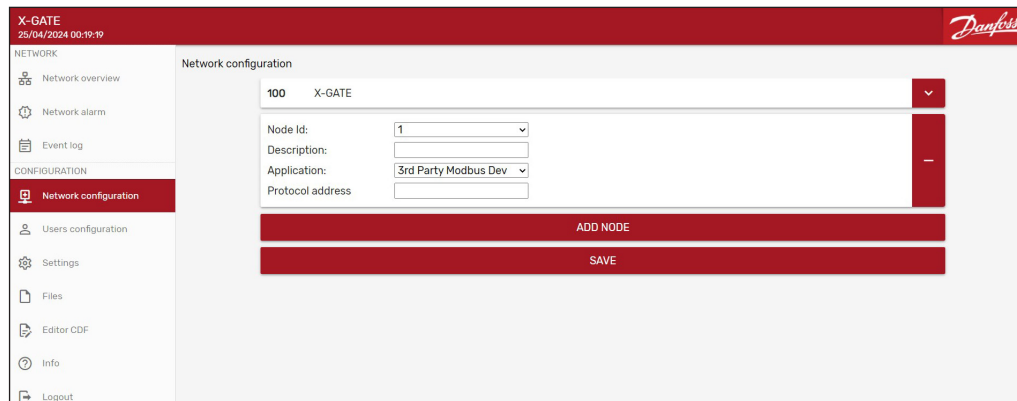

Every time the User add or remove a device, he must be saved with the “Save” button.

6. X-Gate set-up

Enter in the “Network Overview” and access to the X-Gate main menu page.

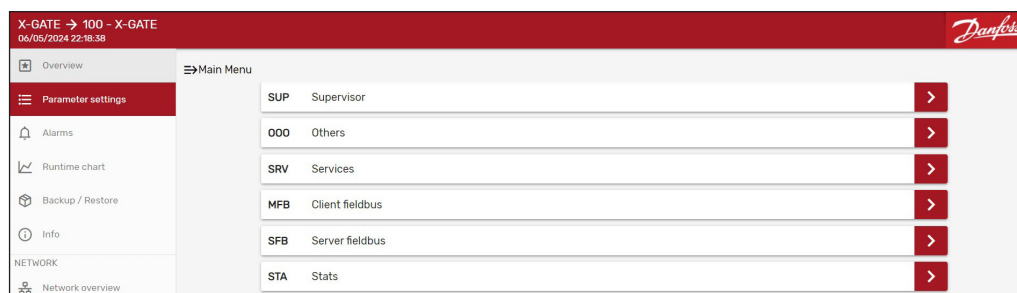

6.1 Supervisor

This page contains the main parameters to set up the communication over serial line.

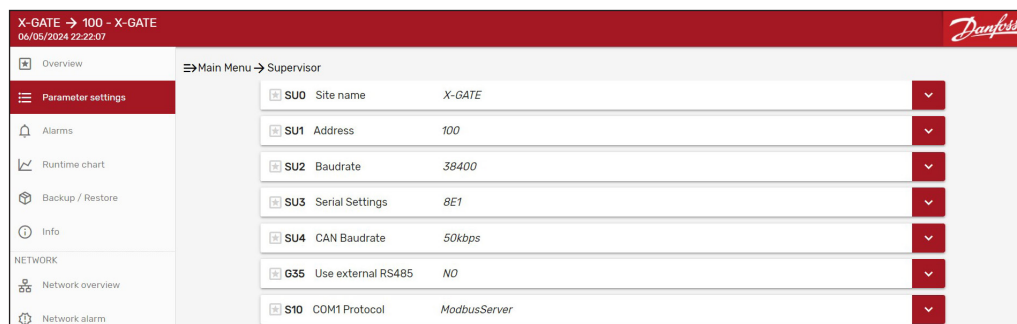

SU2 & SU3 are the configuration parameters for the serial line at COM1.

SU4 is used to set up the speed over CANBus serial line (there is dedicated port for CANBus built-in into X-Gate).

S10 is used to define which protocol must be used on the COM1 serial port.

In case of extra RS485 module, parameter **G35** must put at YES.

An extra set of parameters can be set up:

SU5 & SU6 are the configuration parameters for the serial line at COME (COM Extension).

S40 is used to define which protocol must be use on the COME (COM Extension) serial port.

6.2 Other

This page contains the main parameters to set up the LAN configuration both for the ethernet port 1 and port 2.

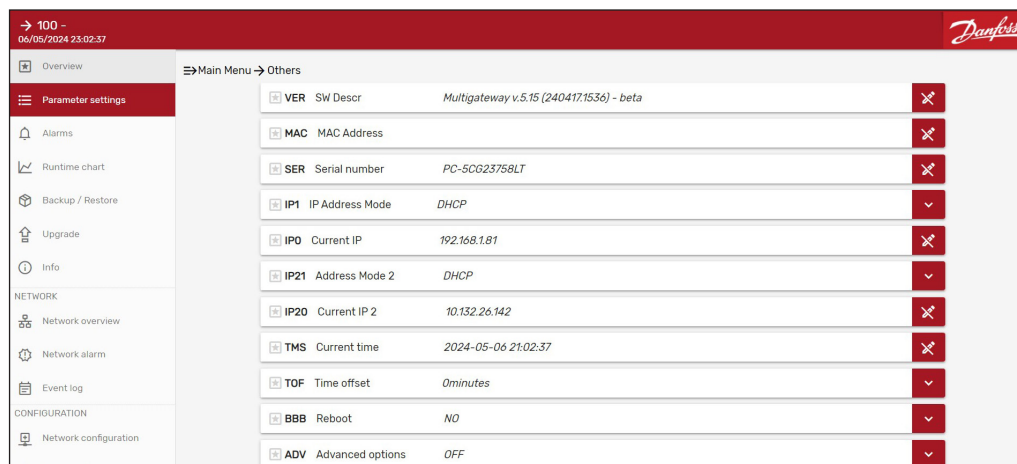

In case of STATIC IP management, set up parameters **IP1** & **IP21** to “Static”. **BBB** parameter can be used in case of manual reboot of the X-Gate machine.

6.3 Services

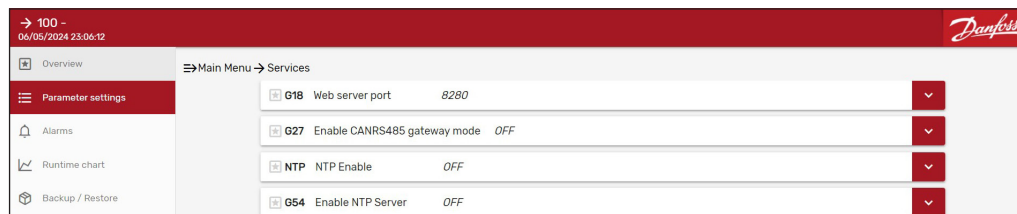

Parameter **NTP** will enable X-Gate to synchronize the time with an online service. Parameter **G54** will enable X-Gate as a NTP Server for another Client.

6.4 Client Fieldbus

This section allows to configure the “SOURCE of the DATA”.

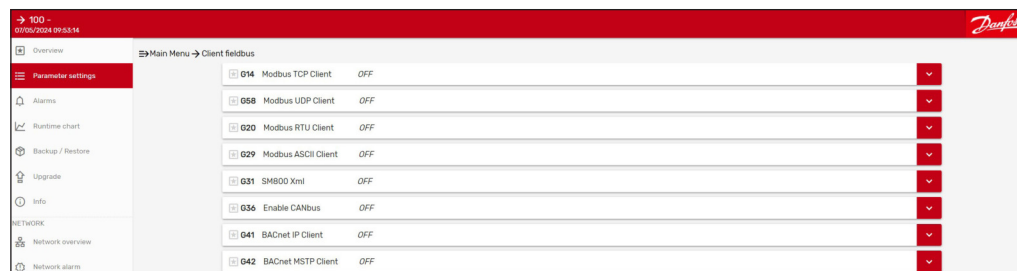

According to the protocol to read from the device on field, User must activate the right configuration.

- **G14**: To enable the communication with Modbus TCP/IP device using the RJ45 (LAN) cable.
- **G58, G20, G29**: To enable the communication with Modbus device over serial port (RS485).
- **G31**: To enable in case X-Gate must read over XML protocol on System Manager (via LAN cable).
- **G36**: To enable for a communication with a CANBus device.
- **G41, G42**: To enable in case of BACNet device with IP (LAN) or MSTP over serial RS485.

According to the enabled client fieldbus, extra configuration parameters will be displayed. Here the example in case of Modbus TCP/IP with the need to set up the IP address of the device.

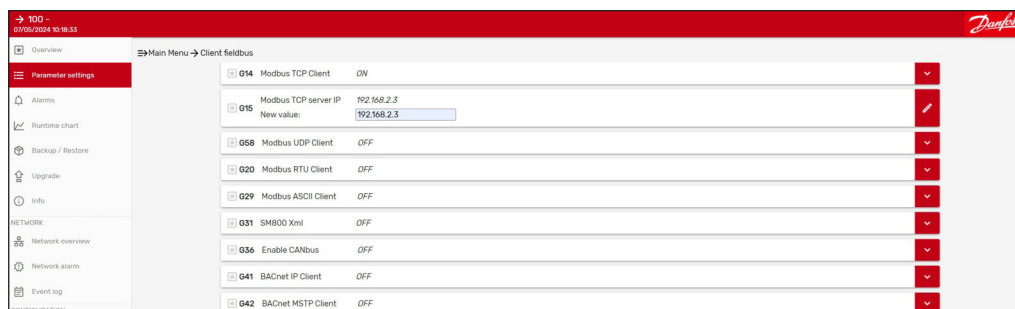

6.5 Server Fieldbus

This section allows to configure the “DESTINATION of the DATA” read from the field.

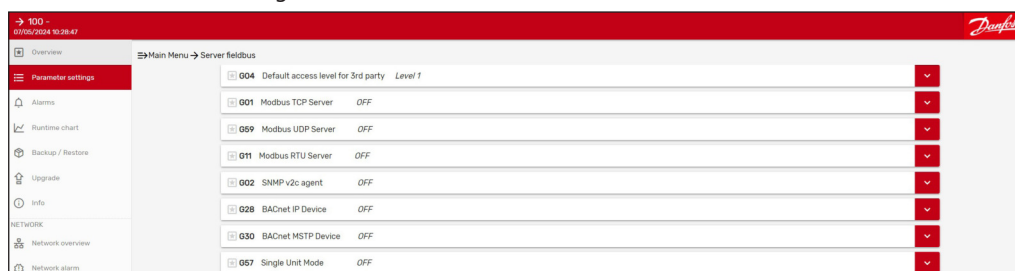

According to the protocol to read from the device on field, User must activate the right configuration.

- **G01, G59**: To enable the data sharing via Modbus TCP/IP server.
- **G11**: To enable the data sharing in Modbus on RS45 port.
- **G02**: To enable data sharing over SNMP protocol over TCP/IP.
- **G28, G30**: To enable data sharing over BACnet in IP or MSTP according to setting.

According to the enabled server fieldbus, extra configuration parameters will be displayed.

G04 parameter provide capability to limit variable visibility according to the Level. From Level 1 to Level 3. Level is a characteristic of the variable coming from the CDF file (or CDF Editor).

7. CDF Editor

The Editor CDF is a feature that allows the user to edit or create from scratch a CDF file. To use it, click on the “Editor CDF” icon on the left-side of the menu tab.

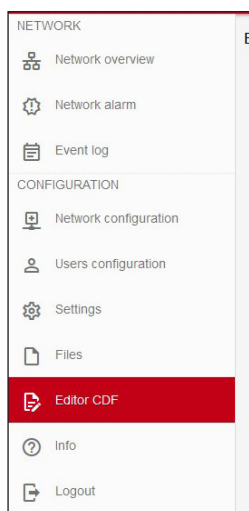

The user can decide to load and eventually modify an existing CDF. If the desired CDF is stored inside the X-Gate, the “Select CDF from X-Gate” window must be opened.



All the CDF files stored inside the device will be listed and are available for selection.

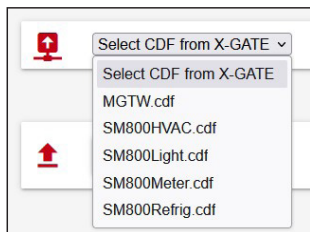

Either way, if the CDF is not stored inside the X-Gate itself but is saved inside the host machine (a PC, eventually), click on "LOAD CDF LOCALLY" and select the file you want to load.

Create new CDF

If a CDF must be created from scratch, the user must fill the CDF fields as described in the following sections.

The **header** of the CDF is a field that contains a general overview of the CDF itself. There are five fields that can be modified.

- Name: The given name will be stored inside the CDF and will also be the file name. It a string of maximum 20 characters. This filed must be filled.
- Description: A general description of the CDF. It a string of maximum 20 characters. This filed must be filled.
- Model: A 2 digits number, representing the model of the CDF. This field must be filled.
- Version: A 3 digits number, representing the version of the CDF. For example, if the field is 100, the version will be interpreted as 1.0.0. This field must be filled.
- Device Category: A list, containing the category of the CDF. It is an optional field.

The **enum** section allows the user to create and modify new enumeration types.

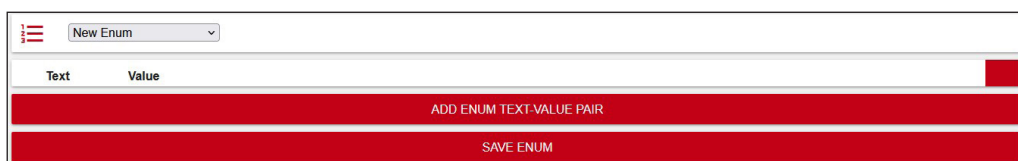

If the button "ADD ENUM TEXT-VALUE PAIR" is clicked, an additional row will appear:

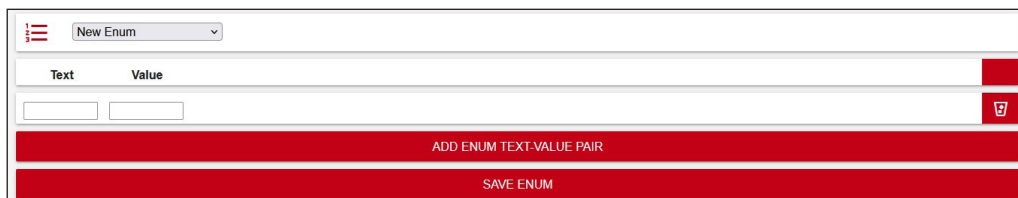

There are two fields that describe the text-value pair that needs to be added to the enumeration under definition:

- Text: A textual description of the current enumeration value
- Value: the relative value

For example, suppose that the user wants to define an enumeration representing the baud rate available for a serial communication:

Text	Value
1200	1
2400	2
4800	3
9600	4

ADD ENUM TEXT-VALUE PAIR

SAVE ENUM

Once the enum is complete, the user must click "SAVE ENUM" to use it in the parameters section, which will be described later. All the defined enums will be saved inside the CDF. If the enum is correctly formatted, then a successful message will appear: "ENUM SAVED" message.

Otherwise, if an error is present, when clicking on "SAVE ENUM" the corresponding row will appear highlighted in red:

Text	Value
1200	1
2400	2
4800	3
9600	4
9600	5

ADD ENUM TEXT-VALUE PAIR

SAVE ENUM

In this case, the same text cannot be used for storing two different values.

Once an enum has been correctly saved, the selection list containing all the enum will refresh and the just created entity will appear formatted as follows:

13: 1200; 2400; 4800; 9600;

where 13 is the index of the enum (this means that the CDF file already had 12 enum saved), followed by the texts used to define the enum itself.

In case of error during the Enum creation there are some conditions to look for as following:

- The text is not unique.
- The value is not unique.
- The value is not numeric.

The parameters table allows the user to specify the parameters that will be stored inside the CDF:

Pos	En	Addr	Bit	RW	Dec	Type	Enum	Min	Def	Max	Eng Unit	Descr	MB Fn	Group
↑ ↓	<input checked="" type="checkbox"/>		0	0-1	0									

ADD PARAM

The fields that define a parameter are:

- Pos: Position inside the table. If the user clicks the arrows on the left of the rows, the parameter position will be switched with either next or the previous parameter (if possible). This feature can be used for quickly sorting the file in case the parameter is out of place by some positions.
- En: If the En checkbox is selected, the device will be saved inside the groups and will be visible.
- Addr: Represents the address of the parameter (for example, the register address for a Modbus register)
- Bit: This selection box is enabled and can be modified just for U1 typed parameters. It represents the bit that this parameter occupies for the given address.

- RW: Read/Write permission. The first digit is relative to the read permission, the second is relative to the write.
 - 0: always allowed
 - 1: require level user
 - 2: require level service
 - 3: require level OEM
 - X: hidden
- Dec: Number of decimals, disabled if the parameter is of type STR or U1
- Type: The type of the parameter. Can be:
 - Empty
 - U1: Unsigned bit
 - U8: Unsigned 1 byte
 - U16: Unsigned 2 bytes
 - U32: Unsigned 4 bytes
 - U64: Unsigned 8 bytes
 - S16: Signed 2 bytes
 - S32: Signed 4 bytes
 - S64: Signed 8 bytes
 - F32: Float 4 bytes
 - F64: Float 8 bytes
- Enum: This field can be either empty or one of the indexes of the defined enums
- Min: The minimum value that the parameter can assume
- Def: The default value that the parameter will assume.
- Max: The maximum value that the parameter will assume
- Eng Unit: The Engineering unit that describes the parameter.
- Descr: A textual description of the parameter
- MB Fn: In case of Modbus protocol, the user can specify the function code use to interact with it
- Group: The group that contains the parameter. If this field is empty, then the group is "ROOT" by default. Otherwise, the group is the string provided by the user. The group can be nested inside another group with the "|" char. For example, the group "Stats | Calculated" defines the Calculated group inside the Stats group.

In the previous image, the "Addr" and "Group" column header are highlighted in red. If the user clicks them, the entire parameter table will be sorted in ascending/alphabetical order. This feature can be used to quickly sort a messy CDF.

Note: also that a parameter row can be deleted from the table by clicking the bin icon located at the right of the group.

The following conditions are defined as error when creating a new param:

- Address field is empty.
- Address field contains chars different from 0-9.
- Address field is not unique with the respect to all other addresses.
- Min, default, and maximum are not coherent with the given parameter type (for example, max=256 and type=U8)
- Min <= default <= maximum is not respected
- Min, default and maximum contains chars different from 0-9.

The alarms table allows the user to specify the alarms that will be stored inside the CDF:

Address	Bit	Modbus Fn	Description
<input type="text"/>	0	<input type="text"/>	<input type="text"/>
ADD ALARM			

The fields that define an alarm are:

- Address: Represents the address of the alarm
- Bit: Represents the bit of the address which is effectively occupied by the alarm
- Modbus Fn: In case of Modbus protocol, the user can specify the function code use to interact with it
- Description: A textual description of the parameter

The following conditions are defined as error when creating a new alarm:

- The pair (Address, Bit) is not unique.

The tags table allows the user to link a pre-defined tag with a

- Parameter
- parameter list
- Enum
- Alarm list
- Enum reference
- Number
- Text

Tag	Tag Type	Tag Origin	Param or Alarm Index(es) separated by comma
0: 0000_MAIN_SWITCH	Param	DeviceSpecific	

ADD TAG

The tags, which type, and origin cannot be modified, can be linked to the parameters or alarms by their index, eventually separated by a comma in case a parameter list or alarm list is selected.

The index of a parameter can be found as a tool tip when the mouse is over a parameter/alarm table row:

↑ ↓	<input checked="" type="checkbox"/>	3230	0	0-2	0	S16	1	100	254	Address	Supervisor
-----	-------------------------------------	------	---	-----	---	-----	---	-----	-----	---------	------------

In the case pictured above, the index is seven. Note that the index of the first parameter is 0.

The following conditions are defined as error when creating a new tag:

- Tag is not unique.
- Tag type is "param" and more than one param are specified.
- Tag type is "param", "param list" or "alarm list" and the index(es) specified are higher than the index of the last defined param.

As for the loading part, the CDF can be either saved on the X-Gate itself or in the local host, such as the user PC. The user must click one of the buttons pictured below, according to its necessity.

↓ SAVE CDF LOCALLY

↑ SAVE CDF X-GATE

The button with the label "SAVE CDF LOCALLY" allows the user to save and store the edited CDF in the host (PC), while the other saves the CDF on the X-Gate itself. If the saving procedure will not find any error, then the file is either downloaded or a message saying "CDF saved on XGATE" will be shown. On the other side, if any error on the CDF file is found, an alert will pop-up: "There are some errors: could not save the file".

The message shown above will appear if the save procedure finds one or more errors. The possible errors have been listed and explained in the previous sections.

The user can then explore the CDF and see where the error is located, by searching for a red backgrounded element, such as is the following:

↑ ↓	<input checked="" type="checkbox"/>	3353	0	1-2	0	S16	4	0	0	1	BACnet MS	Client fieldbi
↑ ↓	<input checked="" type="checkbox"/>	3353	0	0-1	0	STF		0		100	APN	Modem

Once all the errors are resolved, the CDF can be saved again.

Note: that the errors are also shown in real-time and not just when a CDF is saved. The row that was modified by the user is scanned when another row has been clicked.

8. Customization of HTTP user interface

It is possible to customize the user interface of X-Gate.

It is possible to customize the:

- **Logo** in the top right corner of the (instead of the default Danfoss logo)
- The **colour** of the interface (instead of the default red)

Logo Customization

1. To customize the logo shown at top right of the page, create a PNG file named custom_logo.png with width of 133 pixels, height of 55 pixels.
2. Once the PNG file is ready go to the "Files" menu, which can be found on the left-side panel:

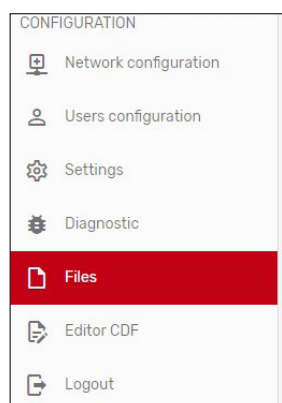

3. Here you should click the "Upload" button and click on your logo customization PNG file.



4. Refresh the page to see your changes.

Colour Customization

1. You can also customize colours by creating a custom_style.css. This is an example of a custom_style.css

```
.root {
  --main-color: #c20016;
}
```

2. Upload the file in the same way as specified above under the "Files" menu and click "Upload".
3. Refresh the page to see your changes.

Here is an example of customizing the main colour into blue.



Removing Customizations

1. If you want to remove a customization, simply remove the file in the "Files" list using the icon:  on the right.
2. Refresh the page to see your changes.

9. Use Cases

9.1 Use Case 1: Source BACNET & Destination MODBUS

As a step 1, User must activate the “source of the data”. It could be BACNet IP or MSTP from the Client Fieldbus configuration page. Main parameters to set up are: **G41** or **G42**. **G55** parameter is use as write priority property for BACNet protocol: Default is 16. **G43** parameter is used as max number of units: Default is 127.

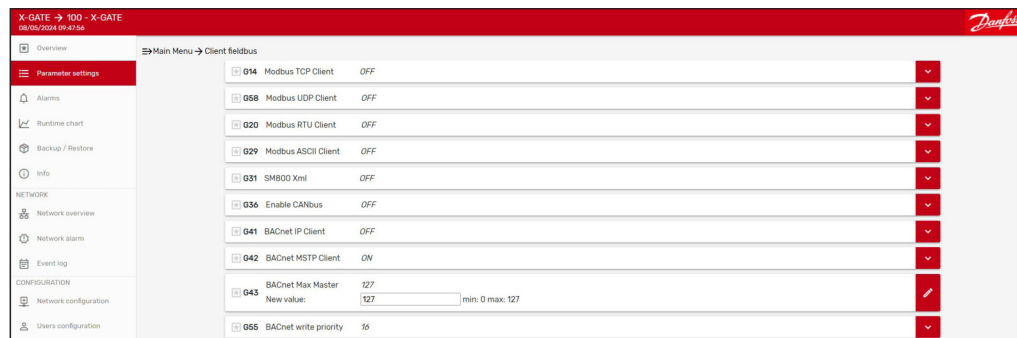

After this configuration done, X-Gate will start to automatically scan the network (IP or Serial as per configuration done) and automatically will create all the CDF files of the discovered devices (nodes) and create the related device in the Network Configuration page.

User can modify the CDF file directly using the CDF Editor or use as it is.

As a step 2, User must activate the “Destination of the data”, in this case Modbus TCP/IP. In the Server Fieldbus page, the main parameter is **G01** and later the **G48** as default port of the server at 502.

With this configuration, X-Gate is reading BACNET and exposing over MODBUS TCP/IP.

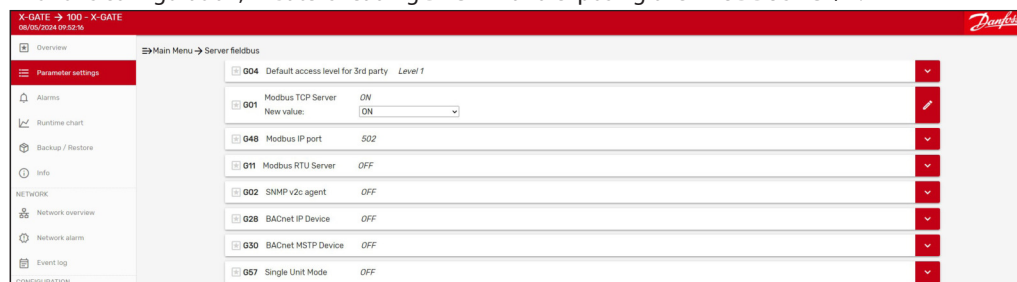

In case of sharing data with a local BMS, the full list of variable/data-points can be downloaded as a CVS file with the utility in settings → download CSV file.



In case the destination of the data is the System Manager over Modbus RTU (serial RS485), G11 parameter must be on.

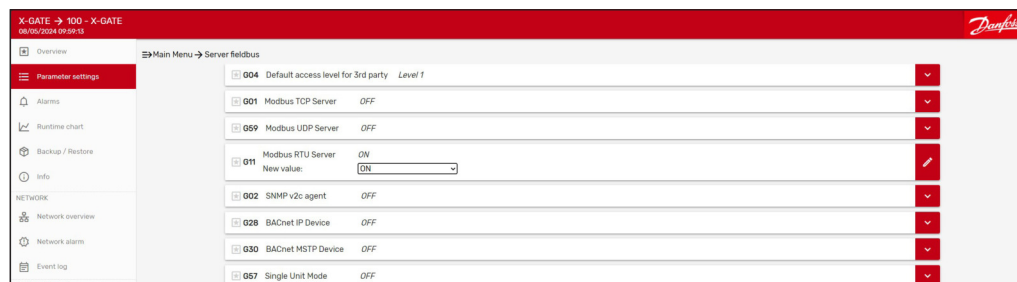

In this case, User must set up the communication port with the correct enabled feature.

S10 parameter must have the correct set up “Modbus server” and the parameter **SU2** and **SU3** must be set up according.

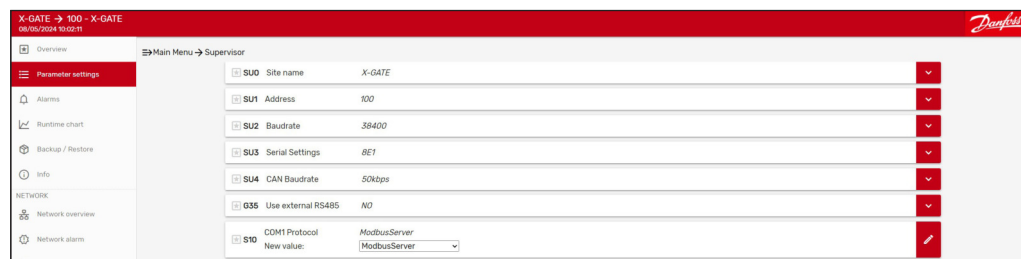

Finally, User can download the file for the System Manager integration from the settings menu with the download of the ED3 / EPK files.



9.2 Use Case 2⁽¹⁾ Source CANBUS & Destination MODBUS

As a step 1, User must activate the “source of the data” with parameter **G36**.

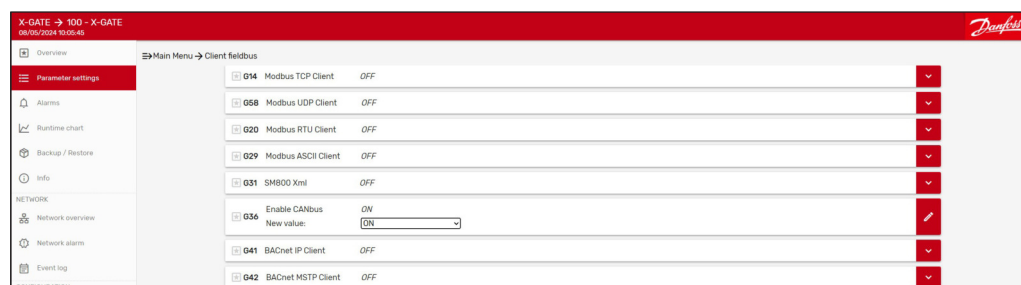

Check the communication speed on the port with parameter **SU4**.

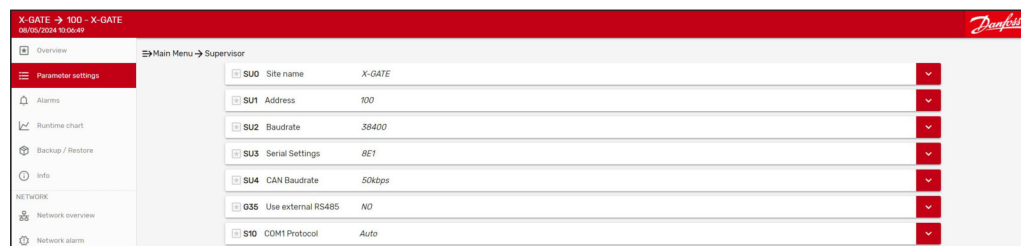

Import the CDF file or create/modify an existing one with the CDF Editor.

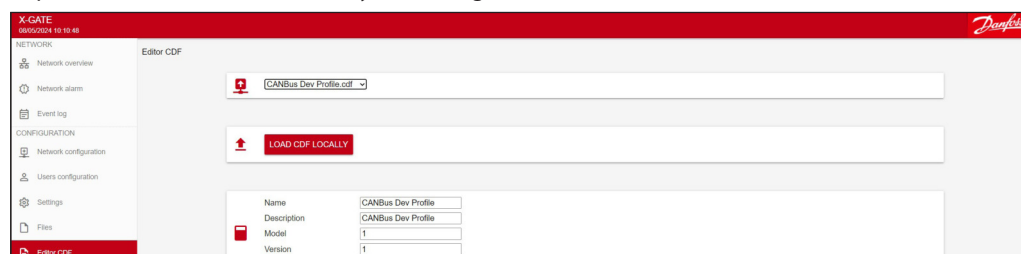

⁽¹⁾ Feature available starting from software version greater than 5.22.

Create a new Device in the Network Configuration page.

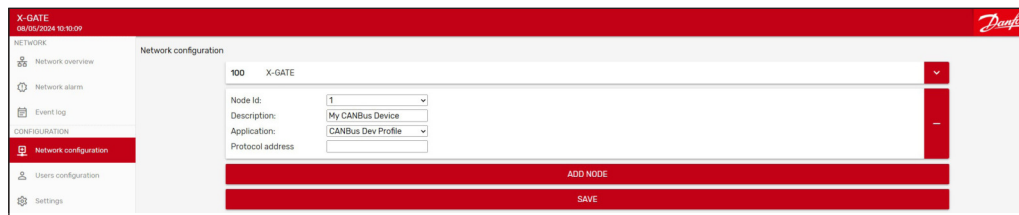

As a step 2, User must activate the “Destination of the data”, in this case Modbus TCP/IP. In this case the activities to be done are the same already described for the **Use-Case 01** to set up the destination of the data.

**9.3 Use Case 3:
Source MODBUS &
Destination MODBUS**

As a step 1, User must activate the “source of the data”. In this case X-Gate must have the additional expansion card with the extra RS485 port.
G35 parameter to enable the use of the extra RS485.
SU2 and **SU3** for the serial line configuration of COM1
SU5 and **SU6** for the serial line configuration of COME (extended)
S10 for COM1 as Client
S40 for COME as Server

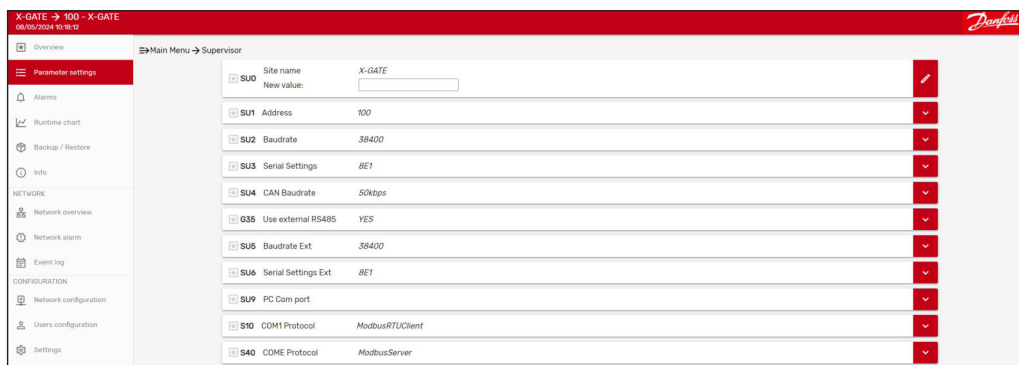

G20 ON to enable the source of the data via Modbus.

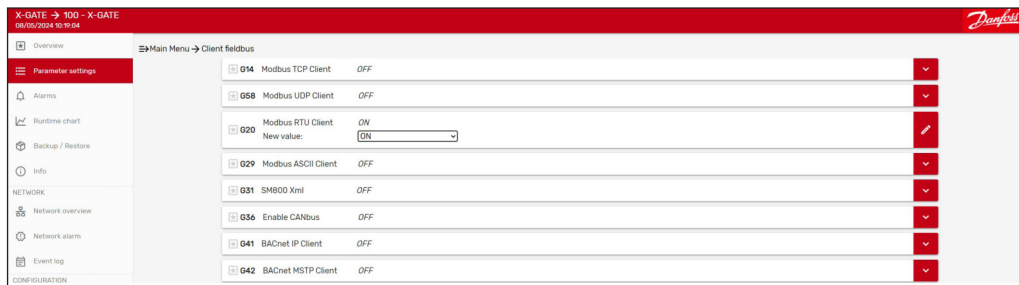

Import the CDF file or create/modify an existing one with the CDF Editor (as done for **Use Case 2**).

Create a new Device in the Network Configuration page (as done for **Use Case 2**).

As a step 2, User must activate the “Destination of the data”, in this case Modbus TCP/IP. In this case the activities to be done are the same already described for the **Use Case 1** to set up the destination of the data.

**9.4 Use Case 4:
Source XML Interface &
Destination MODBUS**

As a step 1, User must activate the “source of the data” with parameter **G31** to on. **G32** parameter with the System Manager IP address (please consider also to add the port number like IP:PORT) **G33** parameter with a valid User defined into System Manager **G34** parameter with the password of the User.

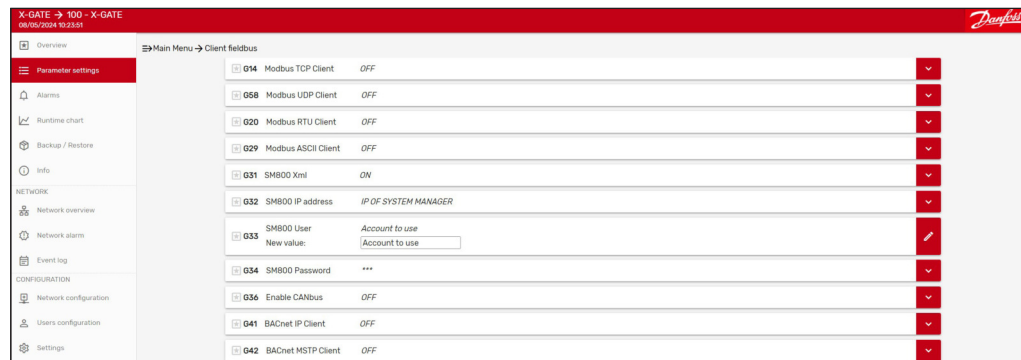

After this configuration done, X-Gate will start to automatically collect data from the System Manager and automatically will create all the CDF files of the discovered devices (nodes) and create the related device in the Network Configuration page.

As a step 2, User must activate the “Destination of the data”, in this case Modbus TCP/IP. In this case the activities to be done are the same already described for the **Use Case 1** to set up the destination of the data.

10. Update

10.1 X-Gate Software

User can update the X-Gate software using the feature available in the settings page. Software can be downloaded from the official Danfoss “Software ADAP-KOOL” website. The final “*.bin” file must be imported and used for the upgrade.



10.2 CDF Files

User can upload / delete available CDF files on the X-Gate using the Files menu.

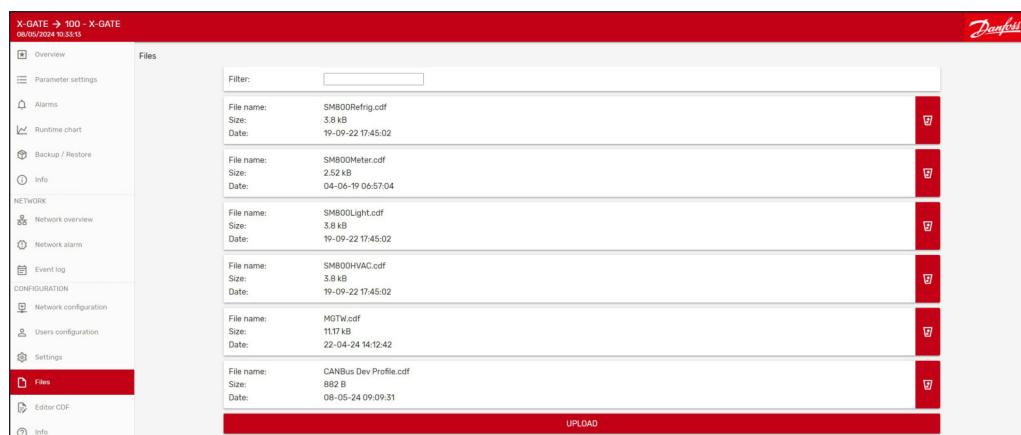

11. Annexure

11.1 Supported BACNET features

- Who Is Router to Network
- I Am Router to Network
- Reject Message to Network
- Router Busy to Network
- Router Available to Network
- What Is Network Number
- Network Number Is
- Confirmed Request
- Unconfirmed Request
- Simple ACK
- Complex ACK
- Error PDU
- Reject PDU
- Abort PDU
- Read Property
- Write Property
- Read Property Multiple
- Write Property Multiple
- Subscribe COV
- COV Notification
- Who Is
- I Am
- Who Has
- I Have
- Time Synchronization
- Device Communication Control
- BACnet objects:
- Device (D)
- Integer Value (IV)
- Positive Integer Value (PI)
- Analog Value (AV)
- Analog Output (AO)
- Analog Input (AI)
- Large Analog Value
- Binary Input (BI)
- Binary Output (BO)
- Binary Value (BV)
- Multistate Input
- Multistate Output
- Multistate Value
- Bitstring Value
- Character String Value

11.2 Supported BACNET properties

- Object Identifier
- Object Type
- Object Name
- Description
- Present Value
- Event State
- Units
- Resolution
- Out of service
- Status Flags
- Reliability
- Min Pres Value
- Max Pres Value
- Polarity

The X-Gate supports BACnet segmentation.

Danfoss A/S

Climate Solutions • danfoss.com • +45 7488 2222

Any information, including, but not limited to information on selection of product, its application or use, product design, weight, dimensions, capacity or any other technical data in product manuals, catalogues descriptions, advertisements, etc. and whether made available in writing, orally, electronically, online or via download, shall be considered informative, and is only binding if and to the extent, explicit reference is made in a quotation or order confirmation. Danfoss cannot accept any responsibility for possible errors in catalogues, brochures, videos and other material. Danfoss reserves the right to alter its products without notice. This also applies to products ordered but not delivered provided that such alterations can be made without changes to form, fit or function of the product.

All trademarks in this material are property of Danfoss A/S or Danfoss group companies. Danfoss and the Danfoss logo are trademarks of Danfoss A/S. All rights reserved.
