



ESBE

THERMOSTATIC MIXING VALVE TMV

ESBE TMV is a newly developed version of the well known Series 20 valve. TMV offers accurate temperature control via a self-regulating thermostat. The valves are designed to control Domestic Hot Water (DHW) temperature, Hydronic Radiant, Space Heating, Heat Pump and Solar Systems.

TMV valves offer the following features:

- Meets ANSI/ASSE 1017.
- Dual purpose: Mixing or diverting function.
- Desired temperature can be locked at any point.
- Max. working pressure 150 psi (10 bars).
- Max. hot water inlet temperature 212°F (100°C).
- Designed for long-life and easy maintenance.
- Available with 3 different temperature ranges.
- Unique compression design in 3/4" and 1" sizes.
- Minimal outlet temperature fluctuation.

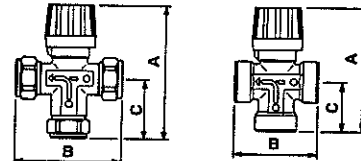

Ordering

Code Number	CV	Size/Connection	DHW* Flow/Gpm	Temp. range	Dimension (in.)			Weight lbs
					A	B	C	
065B8907	2,0	1/2" NPT	8	110-140°F (43-60°C)**	4.1	2.8	1.7	1.0
065B8908	1,7	1/2" NPT	7	68-105°F (20-40°C)	4.1	2.8	1.7	1.0
065B8931	1,9	1/2" NPT	7	85-120°F (29-49°C)	4.1	2.8	1.7	1.0
065B8909	2,2	3/4" NPT	9	110-140°F (43-60°C)**	4.1	2.8	1.7	1.1
065B8910	2,0	3/4" NPT	8	68-105°F (20-40°C)	4.1	2.8	1.7	1.1
065B8932	2,1	3/4" NPT	8	85-120°F (29-49°C)	4.1	2.8	1.7	1.1
065B8911	2,2	3/4" Compression	9	110-140°F (43-60°C)**	4.6	3.6	2.1	1.2
065B8912	2,0	3/4" Compression	8	68-105°F (20-40°C)	4.6	3.6	2.1	1.2
065B8933	2,1	3/4" Compression	8	85-120°F (29-49°C)	4.6	3.6	2.1	1.2
065B8913	4,1	1" Compression	16	110-140°F (43-60°C)**	4.8	3.7	2.2	1.9
065B8914	3,6	1" Compression	14	68-105°F (20-40°C)	4.8	3.7	2.2	1.9
065B8934	3,9	1" Compression	15	85-120°F (29-49°C)	4.8	3.7	2.2	1.9

* At a pressure drop of 22 psi (50 feet). ** Can be recalibrated to 118-149°F (48-65°C).

Temperature selection: Selections per tables below. Line up number on valve cap with boss on valve body. Tables are based on 50°F cold water. For other cold water temperatures, correct mixed temperature by 1°F for every 10°F deviation from 50°F, up or down.

Hot supply of °F	TMV 68-105°F Valve position						TMV 85-120°F Valve position						TMV 110-140°F Valve position					
	1	2	3	4	5	6	1	2	3	4	5	6	1	2	3	4	5	6
120	64	76	83	89	94	102	81	88	95	102	109	115	95	100	106	111	115	118
140	65	78	85	90	96	105	82	89	99	106	111	118	104	111	115	119	127	134
160	68	81	88	94	99	105	83	92	101	108	113	119	108	113	117	124	129	137
180	68	81	88	94	99	105	84	94	102	109	114	120	110	116	120	127	133	140

Note: Temperatures given in table are average values.

SIZING FOR DOMESTIC HOT WATER

Procedure:

1. Determine type and number of fixtures.
2. Read fixture units from Table 1.
3. Calculate number x fixture unit for each fixture type.
4. Calculate total units of all fixtures.

Fixture Units	
Lavatory	1
Kitchen Sink	2
Bath	2
Shower	2
Clothes Washer	2
Dish washer	1

TMV Capacity	
Size	Fixture Units
1/2"	15
3/4"	16
1"	30

Example: 6 lavatories, 1 kitchen sink, 3 baths, 1 shower, 1 clothes washer, 1 dish washer.
Total fixture units=19. Select a 1" TMV.

INSTALLATION

The valve should be installed below the storage tank or water heater as shown in Fig. 3 wherever possible.

If the valve is installed adjacent to, or higher than the storage tank or water heater, it is important to prevent gravity circulation in the event that there is no discharge of water. This is done using various methods such as a check valve in the cold water feed line (Fig. 5).

A check valve should also be installed when a high temperature (uncontrolled) outlet is used for hot water (Fig. 4) and when the valve is installed near the fixtures (Fig. 5).

If a circulation pump is installed in the system, we suggest the use of an "on-off" thermostat to control the temperature in the return line. This thermostat is normally set between 112-120°F (45-49°C). (Fig. 6).

BASIC WAYS HOW TO USE TMV

1. Mixing of domestic hot and cold water.
2. Maintaining a constant supply temperature in a closed heating system.
3. Maintaining a constant return temperature in a closed heating system.

In applications 2 and 3 water is not used up. It is continuously recirculated acting as a heat transfer medium only.

Applications 1 and 2 require piping as a mixing valve, and 3 as a diverting valve.

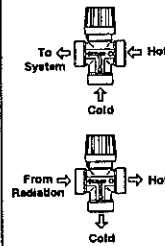

Fig. 1

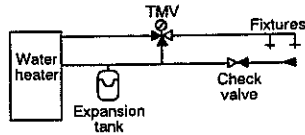

Fig. 4

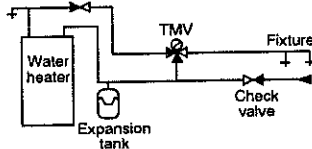

Fig. 2

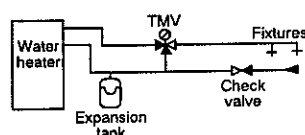

Fig. 5

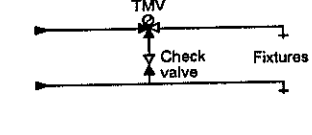

Fig. 3

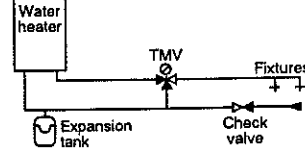
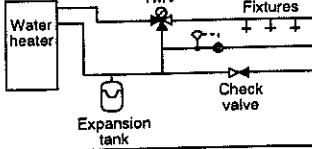

Fig. 6



Printed in Sweden



Danfoss shall not be responsible for any errors in catalogues, brochures or other printed material. Danfoss reserves the right to alter its products at any time without notice, provided that alterations to products already on order shall not require material changes in specification previously agreed upon by Danfoss and Purchaser.

Danfoss Automatic Controls
4971 Mercantile Road
Baltimore, Maryland 21236 · USA
Telephone: (410) 931-8250
Telefax: (410) 931-8256

Danfoss Mfg. Co. Ltd
7880 Tranmera Drive
Mississauga, Ontario, L5S 1L9 · Canada
Telephone: (905) 676-6000
Telefax: (905) 676-0279



LIMITING OR LOCKING TEMPERATURE RANGE

It is possible to lock in a specific temperature setting or a limited temperature range. To use this feature:

1. Turn knob to selected temperature setting lining up with the boss on valve.
2. Remove knob.
3. To lock in temperature at a fixed level: Replace knob so that arrow on wheel is in-line with the boss on valve.
4. **SAFETY CHECK:** To make sure above procedure has been followed correctly ascertain that actual mixed temperatures are within the desired range.

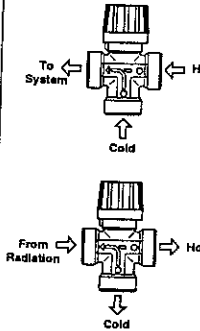

BASIC WAYS HOW TO USE TMV

1. Mixing of domestic hot and cold water.
2. Maintaining a constant supply temperature in a closed heating system.
3. Maintaining a constant return temperature in a closed heating system.

In applications 2 and 3 water is not used up, it is continuously recirculated acting as a heat transfer medium only.

Applications 1 and 2 require piping as a mixing valve, and 3 as a diverting valve.

TYPICAL INSTALLATION OF ESBE TMV

(Thermostatic Mixing Valve) on Radiant Heating System

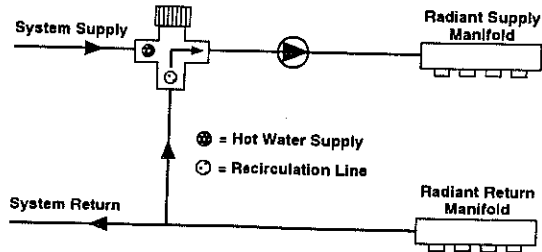

TYPICAL COMBINATION SYSTEM

With Standard Radiators/Baseboard and Radiant Heating

Application: ESBE TMV controls the maximum flow temperature within the Radiant Zone.
Also available, ESBE TV protects the Boiler from operating at low temperatures.

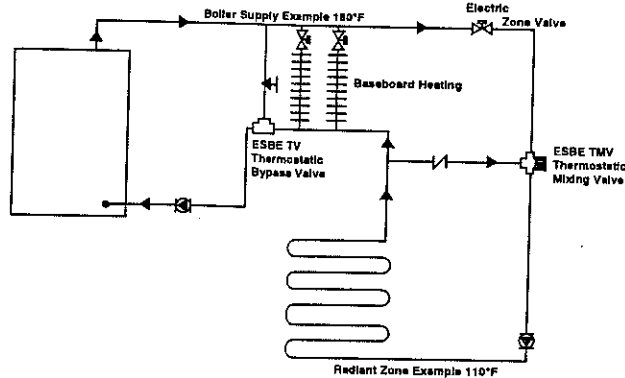

ESBE TMV VALVE - MAINTENANCE OR ELEMENT REPLACEMENT

Hard water conditions may result in scale deposits causing binding of internal parts in extreme cases. Cleaning the internal parts will usually restore the valve to proper operating conditions. In some cases it may be necessary also to clean the seat assembly.

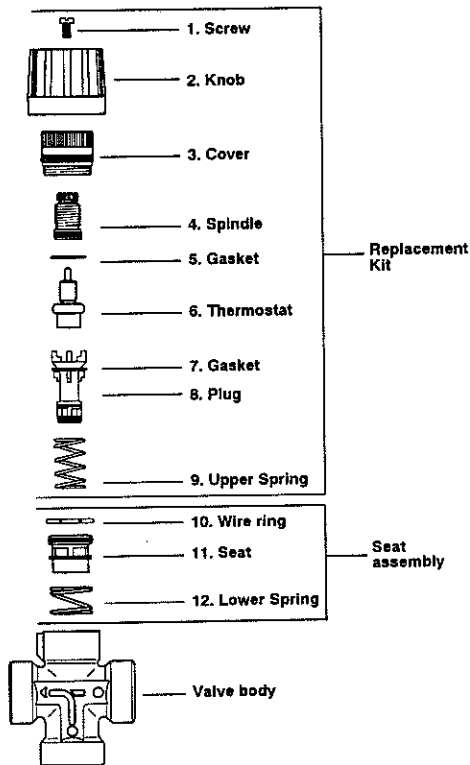

To clean and/or restore the valve, shut off the water and:

1. Remove the knob and then the part 3-8.
2. Remove carefully all scaling (calcium deposits) or foreign particles from all internal parts.
3. When necessary remove and clean the seat assembly in the same way.
4. Assemble the valve carefully and calibrate as described below.

The parts 1-8 are available as Replacement Kits as follows:

Temp. range	1/2" and 3/4"	"1"	Thermostat only
110-140°F (43-60°C)	082F8994	082F8997	082F8953
68-105°F (20-40°C)	082F8995	082F8998	082F8954
85-120°F (29-49°C)	082F8996	082F8999	082F8955

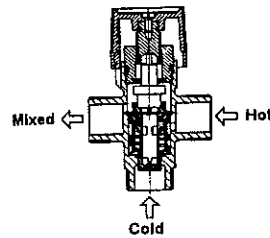

CALIBRATION AND SAFETY TEST FOR THERMAL PROTECTION

It is important that the thermostat replacement is done exactly as indicated above to prevent malfunction, temperature range inaccuracies or possible scalding.

Field replacement or exchange does not guarantee accurate factory calibration and the ESBE TMV may be off by several degrees. To test the calibration, set Position 1 marked on the knob over the boss on the valve body; run water for two minutes and measure hot and cold inlet temperatures and (mixed) outlet temperature with a thermometer.

If the supply water temperatures do not correspond with those on the table, correct for any differences before continuing. Once corrected, if the measured outlet temperature does not agree with the temperature shown in column 1 of the table on page 1, reposition the knob (without disturbing the setting of the spindle) so that the number shown on the table lines up with the boss.

Example: Using a TMV 85-120°F (29-49°C) valves. The hot water supply temperature is 160°F (71°C), the thermometer reads 101°F (38°C), the table says that for 101°F (38°C) the number on the knob should read 3. If it does not, lift the knob off the spindle and re-install the knob so that the number 3 marking lines up with the boss.

