

User guide

Capacity controller with recovery function AK-PC 781A

ADAP-KOOL® Refrigeration control systems

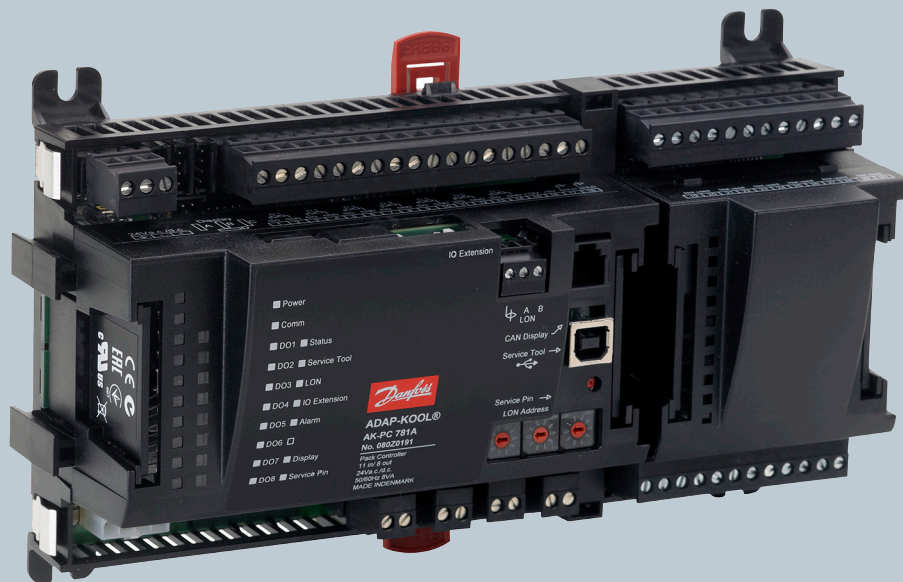

Contents

1. Introduction	3	Setup Functions for General purpose.....	70
Application.....	3	Separate thermostats	71
Principles.....	4	Separate pressostats	71
2. Design of a controller	7	Separate voltage signals.....	72
Module survey	8	Separate alarm inputs	72
Common data for modules	10	Separate PI functions.....	73
Controller	12	Configuration of inputs and outputs	74
Extension module AK-XM 101A	14	Set alarm priorities.....	76
Extension module AK-XM 102A / AK-XM 102B.....	16	Lock configuration	78
Extension module AK-XM 103A	18	Check configuration.....	79
Extension module AK-XM 204A / AK-XM 204B.....	20	Check of connections.....	81
Extension module AK-XM 205A / AK-XM 205B.....	22	Check of settings.....	83
Extension module AK-XM 208C	24	Schedule function	85
Extension module AK-OB 110	26	Installation in network	86
Extension module EKA 163B / EKA 164B / EKA 166.....	27	First start of control.....	87
Graphic display MMIGRS2.....	27	Start the control.....	88
Power supply module AK-PS 075 / 150 / 250.....	28	Manual capacity control	89
Communication module AK-CM 102	29	5. Regulating functions	91
Preface to design	30	Suction group	92
Functions.....	30	Controlling sensor selection	92
Connections	31	Reference	93
Limitations.....	31	Capacity control of compressors.....	94
Design of a compressor and condenser control	32	Capacity distribution methods.....	96
Procedure:.....	32	Power pack types – compressor combinations.....	97
Sketch.....	32	Compressor timers.....	101
Compressor and condenser functions	32	Compressor with variable capacity.....	101
Connections	33	Load shedding.....	102
Planning table	35	Injection signal to heat exchanger control	103
Length	36	Injection ON	103
Linking of modules.....	36	Liquid injection in common suction line	104
Determine the connection points	37	Safety functions	104
Connection diagram	38	Oil management.....	106
Supply voltage	40	Condenser	108
Ordering.....	41	Capacity control of condenser	108
3. Mounting and wiring.....	43	Reference for condensing pressure.....	108
Mounting.....	44	Capacity distribution	110
Mounting of analog output module.....	44	Step regulation	110
Mounting of extension module on the basic module.....	45	Speed regulation	110
Wiring.....	46	Condenser couplings.....	111
4. Configuration and operation.....	49	Safety functions for condenser	111
Configuration	50	EC motor.....	111
Connect PC.....	50	CO ₂ transcritical system and heat recovery	112
Authorization.....	52	Circuit for heat recovery or hot tap water	113
Unlock the configuration of the controllers	53	Circuit for recovery for heating.....	114
System setup	54	Circuits for control of CO ₂ gas pressure	117
Set plant type	55	Receiver control	119
Set control of compressors.....	56	Parallel compression	120
Set oil management.....	60	General monitoring functions	122
Setup control of condenser fans	62	Miscellaneous	124
Setup control of high pressure.....	64	Appendix A – Compressor combinations and coupling pat-	
Setup control of receiver pressure.....	65	terns.....	128
Setup control of heat recovery.....	66	Appendix B - Alarm texts	134
Setup Display.....	69	Appendix C - Recommended connection	136

1. Introduction

SW = 1.4x

Application

AK-PC 781A is complete regulating units for capacity control of compressors and condensers in refrigeration systems. The controller is with oil management, heat recovery function and CO₂ gas pressure control.

In addition to capacity control the controllers can give signals to other controllers about the operating condition, e.g. forced closing of expansion valves, alarm signals and alarm messages.

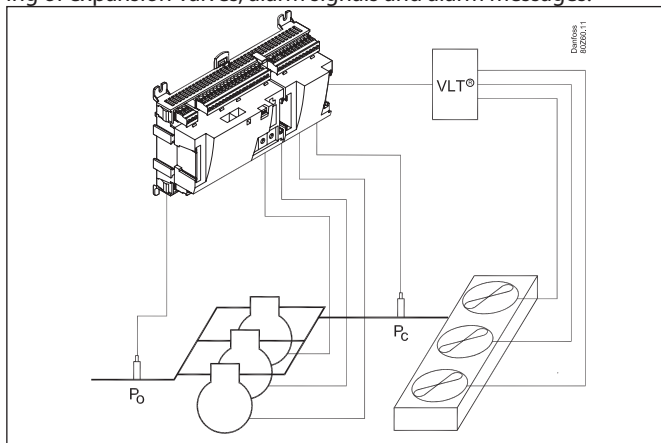

The controller's main function is to control compressors and condensers so that operation all the time takes place at the energy-optimum pressure conditions. Both suction pressure and condensing pressure are controlled by signals from pressure transmitters.

Capacity control can be carried out by suction pressure P₀, media temperature S₄ or separate control pressure P_{ctrl} (for cascade).

Among the different functions are:

- Capacity control of up to 10 compressors
- Up to 3 unloaders for each compressor
- Oil management. Either shared or individual for all of the compressor's oil valves. Receiver pressure control.
- Speed control of one or two compressors
- Up to 6 safety inputs for each compressor
- Option for capacity limitation to minimize consumption peaks
- When the compressor does not start, signals can be transmitted to other controllers so that the electronic expansion valves will be closed
- Regulation of liquid injection into suction line
- Start/stop of liquid injection in heat exchanger (cascade)
- MT/LT - coordination between controllers in cascade control
- Safety monitoring of high pressure / low pressure / discharge temperature
- Capacity control of up to 8 fans
- Floating reference with regard to outside temperature
- Heat recovery function
- CO₂ gas cooler control and receiver control
- Parallel compression on transcritical CO₂ system
- Step coupling, speed regulation or a combination
- Safety monitoring of fans
- The status of the outputs and inputs is shown by means of light-emitting diodes on the front panel
- Alarm signals can be generated via data communication
- Alarms are shown with texts so that the cause of the alarm is easy to see.
- Plus some completely separate functions that are totally independent of the regulation – such as alarm, thermostat, pressure and PI-regulating functions.

Examples

Traditional capacity control

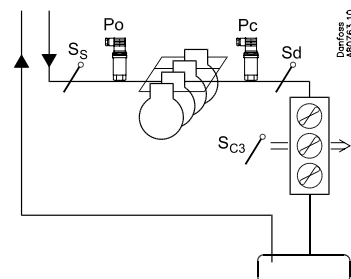

Booster control with 2 controls

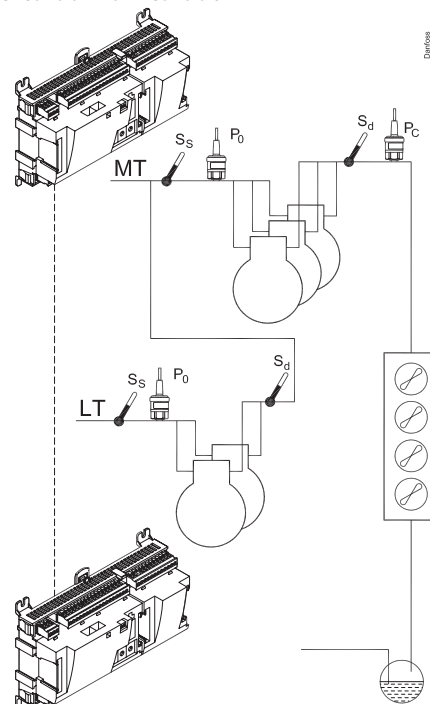

(For pure booster control without MT cooling, the intermediate pressure must be connected to the receiver to prevent P_{min} and P_{max} cut-outs during the start-up).

Heat recovery functions, controlling the condensing pressure and receiver pressure of a CO₂ plant

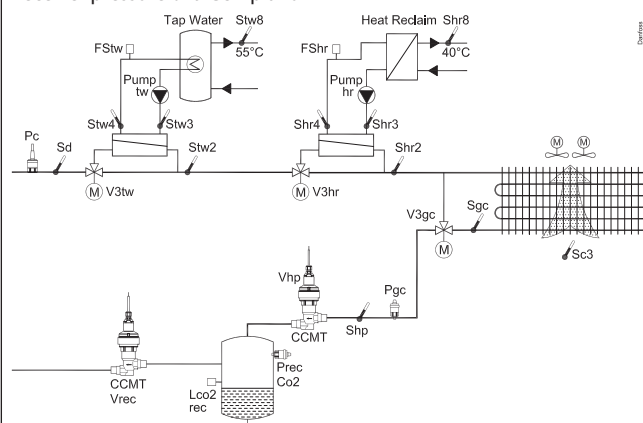

Principles

The great advantage of this series of controllers is that it can be extended as the size of the plant is increased. It has been developed for refrigeration control systems, but not for any specific application – variation is created through the read-in software and the way you choose to define the connections.

It is the same modules that are used for each regulation and the composition can be changed, as required. With these modules (building blocks) it is possible to create a multitude of various kinds of regulations. But it is you who must help adjusting the regulation to the actual needs – these instructions will assist you to find your way through all the questions so that the regulation can be defined and the connections made.

Advantages

- The controller's size can "grow" as systems grow
- The software can be set for one or more regulations
- Several regulations with the same components
- Extension-friendly when systems requirements are changed
- Flexible concept:
 - Controller series with common construction
 - One principle – many regulation uses
 - modules are selected for the actual connection requirements
 - The same modules are used from regulation to regulation

Controller

Danfoss
A80Z92.11

Top part

Bottom part

Extension modules

Danfoss
A80Z93.10

The controller is the cornerstone of the regulation. The module has inputs and outputs capable of handling small systems.

- The bottom part – and hence the terminals – are the same for all controller types.
- The top part contains the intelligence with software. This unit will vary according to controller type. But it will always be supplied together with the bottom part.
- In addition to the software the top part is provided with connections for data communication and address setting.

If the system grows and more functions have to be controlled, the regulation can be extended. With extra modules more signals can be received and more relays cut in and out – how many of them – and which – is determined by the relevant application.

Examples

Danfoss
A80Z95.10

Danfoss
A80Z94.10

A regulation with few connections can be performed with the controller module alone

If there are many connections one or more extension modules have to be mounted

Direct connection

Setup and operation of an AK controller must be accomplished via the "AK-Service Tool" software program.

The program is installed on a PC, and setup and operation of the various functions are carried out via the controller's menu displays.

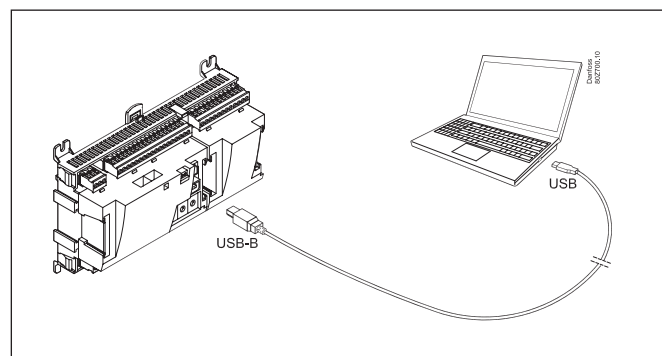

Displays

The menu displays are dynamic, so that different settings in one menu will result in different setting possibilities in other menus.

A simple application with few connections will give a setup with few settings.

A corresponding application with many connections will give a setup with many settings.

From the overview display there is access to further displays for the compressor regulation and the condenser regulation.

At the bottom of the display there is access to a number of general functions, such as "time table", "manual operation", "log function", "alarms", and "service" (configuration).

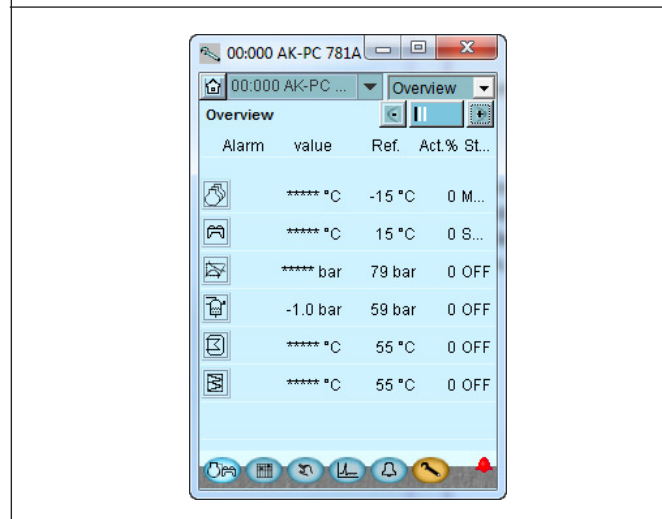

Network linking

The controller can be linked up into a network together with other controllers in an ADAP-KOOL® refrigeration control system. After the setup operation can be performed at a distance with, say, our software program type AKM.

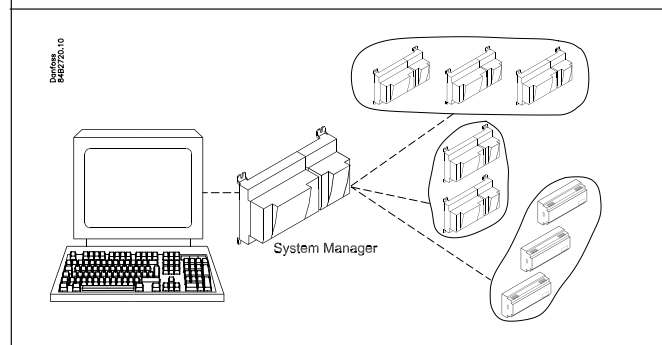

Users

The controller comes supplied with several languages, one of which can be selected and employed by the user. If there are several users, they may each have their choice of language. All users must be assigned a user profile which either gives access to full operation or gradually limits the operation to the lowest level that only allows you "to see".

Language selection is part of the service tool settings.

If the language selection is not available in the service tool for the current regulator, English texts will be displayed.

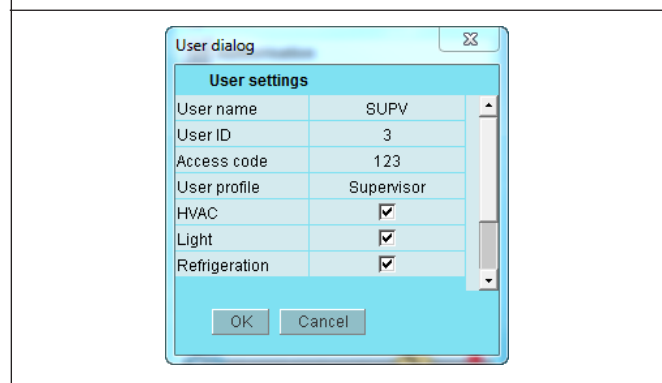

External display

An external display can be fitted in order for P0 (Suction) and Pc (Condensing) readings to be displayed.

A total of 4 displays can be fitted and with one setting it is possible to choose between the following readings: suction pressure, suction pressure in temperature, Pctrl, S4, Ss, Sd, condenser pressure, condenser pressure in temperature, S7 gas cooler temperature, hot tap water at heat recovery and heat exchanger temperature at heat recovery.

A graphical display with control buttons can also be fitted.

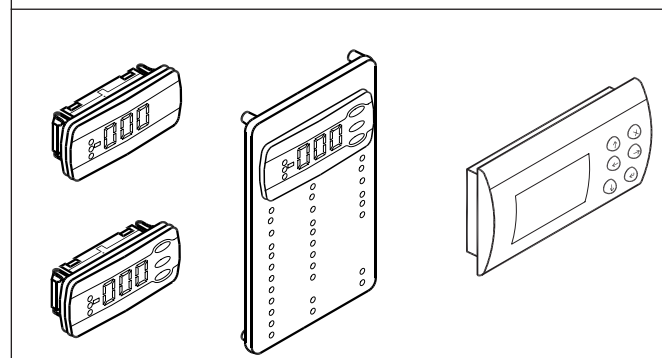

Light-emitting diodes

A number of light-emitting diodes makes it possible to follow the signals that are received and transmitted by the controller.

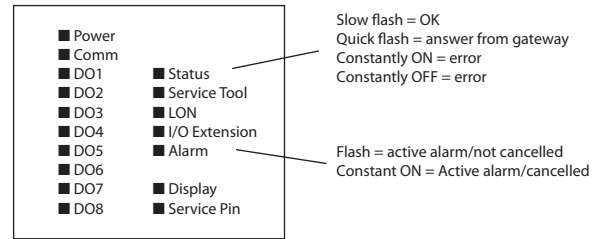

Log

From the log function you can define the measurements you wish to be shown.

The collected values can be printed, or you may export them to a file. You can open the file in Excel.

If you are in a service situation you can show measurements in a trend function. The measurements are then made real-time and displayed instantly.

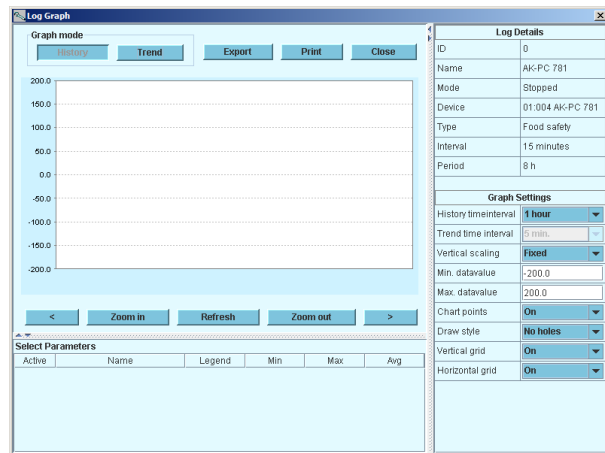

Alarm

The display gives you an overview of all active alarms. If you wish to confirm that you have seen the alarm you can cross it off in the acknowledge field.

If you want to know more about a current alarm you can click on it and obtain an information display on the screen.

A corresponding display exists for all earlier alarms. Here you can upload information if you need further details about the alarm history.

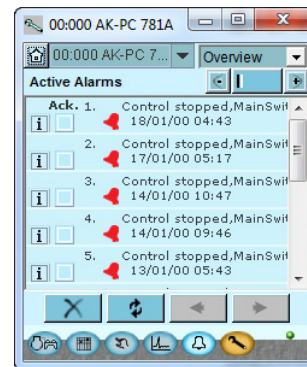

Trouble-shooting

The controller contains a function that continuously follows a number of measurements and deals with them. The result indicates whether the function is OK or whether an error may be expected within a given period of time ("the trip down the roller coaster has started"). At this time an alarm is transmitted about the situation – no error has appeared as yet, but it will come. One example may be slow clogging-up of a condenser. When the alarm comes the capacity has been reduced, but the situation is not serious. There will be time to plan a service call.

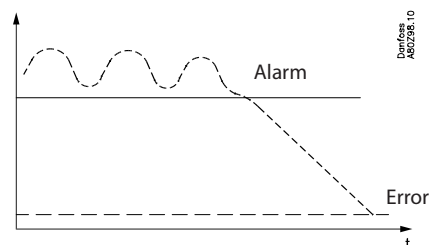

2. Design of a controller

This section describes how the controller is designed.

The controller in the system is based on a uniform connection platform where any deviations from regulation to regulation is determined by the used top part with a specific software and by which input and output signals the relevant application will require. If it is an application with few connections, the controller module (top part with belonging bottom part) may be sufficient. If it is an application with many connections it will be necessary to use the controller module plus one or more extension modules.

This section will give you a survey of possible connections plus assistance in selecting the modules required by your actual application.

Module survey

- Controller module – capable of handling minor plant requirements.
- Extension modules. When the complexity becomes greater and additional inputs or outputs are required, modules can be attached to the controller. A plug on the side of the module will transmit the supply voltage and data communication between the modules.
- Top part
The upper part of the controller module contains the intelligence. This is the unit where the regulation is defined and where data communication is connected to other controllers in a bigger network.
- Connection types
There are various types of inputs and outputs. One type may, for example, receive signals from sensors and switches, another may receive a voltage signal, and a third type may be outputs with relays etc. The individual types are shown in the table below.

- Optional connection
When a regulation is planned (set up) it will generate a need for a number of connections distributed on the mentioned types. This connection must then be made on either the controller module or an extension module. The only thing to be observed is that the types must not be mixed (an analog input signal must for instance not be connected to a digital input).
- Programming of connections
The controller must know where you connect the individual input and output signals. This takes place in a later configuration where each individual connection is defined based on the following principle:
 - to which module
 - at which point ("terminals")
 - what is connected (e.g. pressure transmitter/type/pressure range)

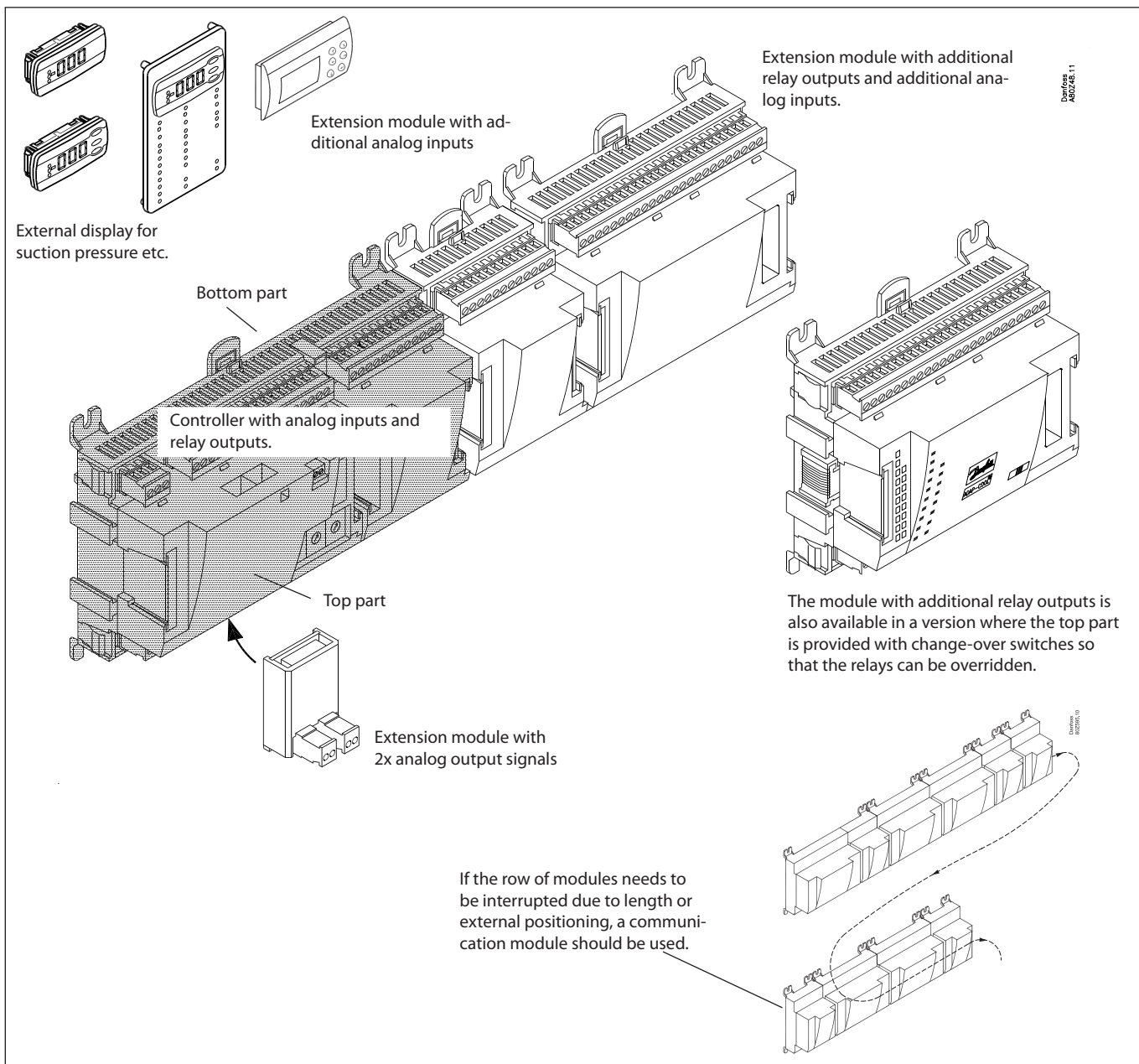

1. Controller

Type	Function	Application
AK-PC 781A	Controller for capacity control of compressors and condensers 10 compressors with up to 3 unloaders, 8 fans, max. 120 inputs/outputs	Compressor / Condenser / Both/ Oil management / Heat recovery / CO2 gas pressure

2. Extension modules and survey of inputs and outputs

Type	Analog inputs	On/Off outputs		On/off supply voltage (DI signal)		Analog outputs	Stepper output	Module with switches
	For sensors, pressure transmitters etc.	Relay (SPDT)	Solid state	Low voltage (max. 80 V)	High voltage (max. 260 V)	0-10 V d.c.	For valves with step control	For override of relay outputs
Controller	11	4	4	-	-	-		-
Extension modules								
AK-XM 101A	8							
AK-XM 102A				8				
AK-XM 102B					8			
AK-XM 103A	4					4		
AK-XM 204A		8						
AK-XM 204B		8						x
AK-XM 205A	8	8						
AK-XM 205B	8	8						x
AK-XM 208C	8						4	

The following extension module can be placed on the PC board in the controller module.
There is only room for one module.

AK-OB 110						2		
-----------	--	--	--	--	--	---	--	--

3. AK operation and accessories

Type	Function	Application
Operation		
AK-ST 500	Software for operation of AK controllers	AK-operation
-	Cable between PC and AK controller	USB A-B (Standard IT cable)
Accessories	Power supply module 230 V / 115 V to 24 V d.c.	
AK-PS 075	18 VA	Supply for controller
AK-PS 150	36 VA	
AK-PS 250	60 VA	
Accessories	External display that can be connected to the controller module. For showing, say, the suction pressure	
EKA 163B	Display	
EKA 164B	Display with operation buttons	
EKA 166	Display with operation buttons and LED for function cut in	
MMIGRS2	Graphic display with operation	
-	Cable between EKA display and controller	Length = 2 m, 6 m
	Cable between graphic display and controller	Length = 1.5 m, 3.0 m
Accessories	Communication modules for controllers where modules cannot be connected continuously	
AK-CM 102	Communication module	Data communication for external extension modules

On the following pages there is data specific to each module.

Common data for modules

Supply voltage	24 V d.c./a.c. +/- 20%	
Power consumption	AK-__ (controller)	8 VA
	AK-XM 101, 102, 103, 107, AK-CM 102	2 VA
	AK-XM 204, 205, 208	5 VA
Analog inputs	Pt 1000 ohm /0°C	Resolution: 0.1°C Accuracy: +/- 0.5°C +/- 0.5°C between -50°C and +50°C +/- 1°C between -100°C and -50°C +/- 1°C between +50°C and +130°C
	Pressure transmitter type AKS 32R / AKS 2050 MBS 2050 / AKS 32 (1-5 V)	Resolution: 1 mV Accuracy +/- 10 mV Max. connection of 5 pressure transmitters on one module
	Other pressure transmitter: Ratiometric signal Min. and Max. pressure must be set Voltage signal 0-10 V	
	Contact function (On/Off)	On at R < 20 ohm Off at R > 2K ohm (Gold -plated contacts not necessary)
On/off supply voltage inputs	Low voltage 0 / 80 V a.c./d.c.	Off: U < 2 V On: U > 10 V
	High voltage 0 / 260 V a.c.	Off: U < 24 V On: U > 80 V
Relay outputs SPDT	AC-1 (ohmic)	4 A
	AC-15 (inductive)	3 A
	U	Min. 24 V Max. 230 V Low and high voltage must not be connected to the same output group
Solid state outputs	Can be used for loads that are cut in and out frequently, e.g. : Oil valves, fans and AKV valves	Max. 240 V a.c. , Min. 48 V a.c. Max. 0,5 A, Leak < 1 mA Max. 1 AKV
Stepper outputs	Used for valves with stepper input	20-500 step/s Separate supply to stepper outputs : 24 a.c./d.c. / 13 VA
Ambient temperature	During transport	-40 to 70°C
	During operation	-20 to 55°C, 0 to 95% RH (non condensing) No shock influences / vibrations
Enclosure	Material	PC / ABS
	Class	IP10 , VBG 4
	Mounting	For mounting on panel wall or DIN rail
Weight with screw terminals	Modules in 100- / 200- / controller-series	Ca. 200 g / 500 g / 600 g
Approvals	EU low voltage directive and EMC requirements are complied with	LVD tested according to EN 60730 EMC tested Immunity according to EN 61000-6-2 Emission according to EN 61000-6-3
	UL 873,  us	UL file number: E166834 for XM and CM-modules UL file number: E31024 for PC-modules

The mentioned data applies to all modules.

If data is specific, this is mentioned together with the module in question.

Dimensions

- The module dimension is 72 mm.
- Modules in the 100-series consist of one module
- Modules in the 200-series consist of two modules
- Controllers consist of three modules
- The length of an aggregate unit = $n \times 72 + 8$

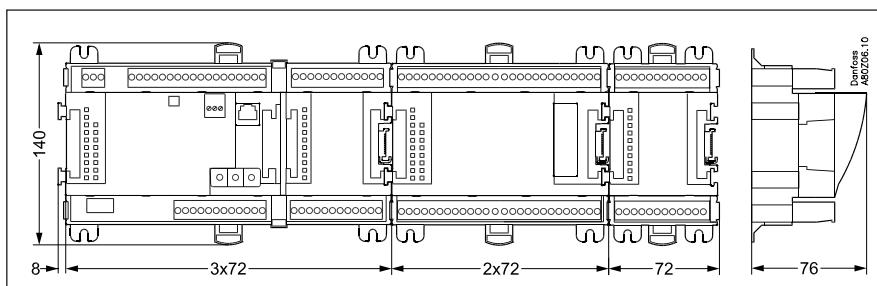

Controller

Function

There are several controllers in the series. The function is determined by the programmed software, but outwardly the controllers are identical – they all have the same connection possibilities: 11 analog inputs for sensors, pressure transmitters, voltage signals and contact signals.
8 digital outputs, with 4 Solid state outputs and 4 relay outputs

Supply voltage

24 V a.c. or d.c. to be connected to the controller.
The 24 V must **not** be retransmitted and used by other controllers as it is not galvanically separated from inputs and outputs. In other words, you **must** use a transformer for each controller. Class II is required. The terminals must **not** be earthed.
The supply voltage to any extension modules is transmitted via the plug on the right-hand side.
The size of the transformer is determined by the power requirement of the total number of modules.

The supply voltage to a pressure transmitter can be taken either from the 5 V output or from the 12 V output depending on transmitter type.

Data communication

If the controller is to be included in a system, communication must take place via the LON connection.
The installation has to be made as mentioned in the separate instructions for LON communication.

Address setting

When the controller is connected to a gateway type AKA 245, the controller's address must be set between 1 and 119. (If it is a system manager AK-SM .., then 1-999).

Service PIN

When the controller is connected to the data communication cable the gateway must have knowledge of the new controller. This is obtained by pushing the key PIN. The LED "Status" will flash when the gateway sends an acceptance message.

Operation

The configuration operation of the controller must take place from the software program "Service Tool". The program must be installed on a PC, and the PC must be connected to the controller via the USB-B plug on the front of the unit.

Light-emitting diodes

There are two rows with LED's. They mean:

Left row:

- Voltage supply to the controller
- Communication active with the bottom PC board (red = error)
- Status of outputs DO1 to DO8

Right row:

- Software status (slow flash = OK)
- Communication with Service Tool
- Communication on LON
- Communication with AK-CM 102
- Alarm when LED flashes
- 1 LED that is not used
- Communication with display on RJ11 plug
- "Service Pin" switch has been activated

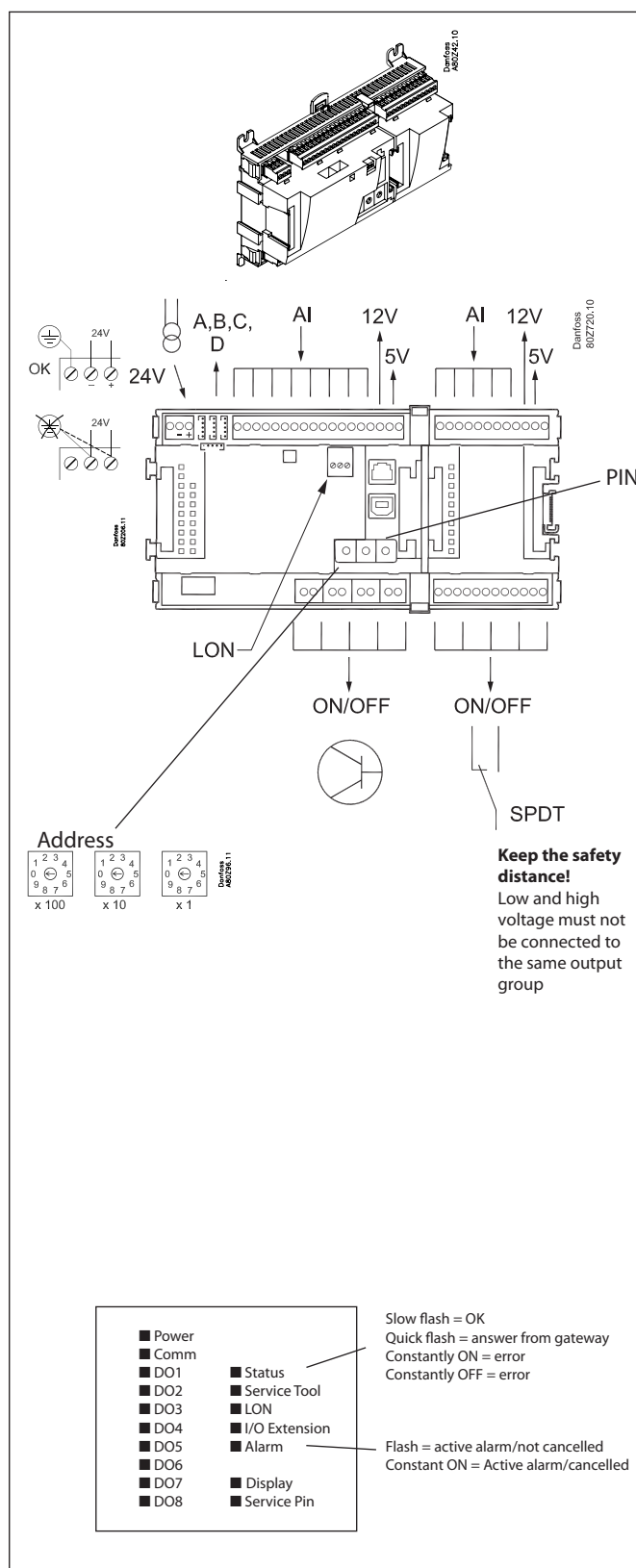

A small module (option board) can be placed on the bottom part of the controller. The module is described later in the document.

Point

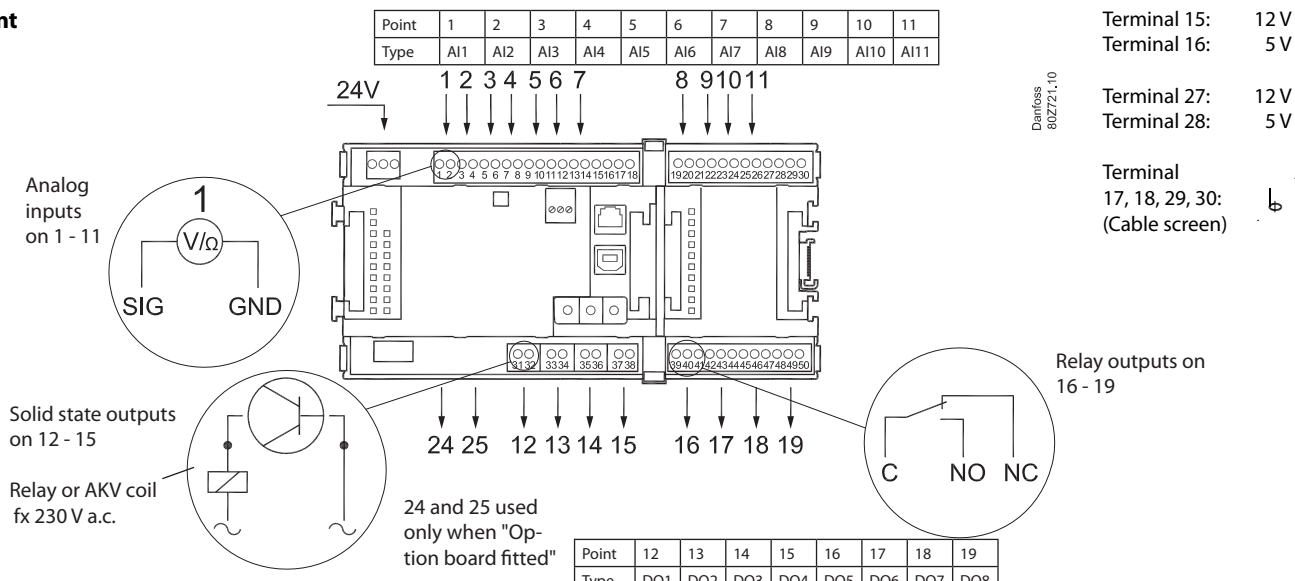

Point	12	13	14	15	16	17	18	19
Type	DO1	DO2	DO3	DO4	DO5	DO6	DO7	DO8

	Signal	Signal type
S Pt 1000 ohm/0°C	S1 S2 Saux_ SsA SdA Shr Stw Sgc	Pt 1000
P	AKS 32R 3: Brown SIG 2: Blue GND 1: Black 5V AKS 32 3: Brown SIG 2: Black GND 1: Red 12V	P0A POB PcA PcB Paux Pgc Prec AKS 32R / AKS 2050 MBS 8250 -1 - xx bar AKS 32 -1 - zz bar
U	+ SIG - GND	0 - 5 V 0 - 10 V
On/Off	Ext. Main switch Day/ Night Door Level switch	Active at: Closed / Open
DO	AKV Comp 1 Comp 2 Fan 1 Alarm Light Rail heat Defrost Solenoid valve	Active at: On / Off
Option Board	Please see the signal on the page with the module.	

Signal	Module	Point	Terminal	Signal type / Active at
	1	1 (AI 1)	1 - 2	
		2 (AI 2)	3 - 4	
		3 (AI 3)	5 - 6	
		4 (AI 4)	7 - 8	
		5 (AI 5)	9 - 10	
		6 (AI 6)	11 - 12	
		7 (AI 7)	13 - 14	
		8 (AI 8)	19 - 20	
		9 (AI 9)	21 - 22	
		10 (AI 10)	23 - 24	
		11 (AI 11)	25 - 26	
		12 (DO 1)	31 - 32	
		13 (DO 2)	33 - 34	
		14 (DO 3)	35 - 36	
		15 (DO 4)	37 - 38	
		16 (DO 5)	39 - 40 - 41	
		17 (DO6)	42 - 43 - 44	
		18 (DO7)	45 - 46 - 47	
		19 (DO8)	48 - 49 - 50	
		24	-	
		25	-	

Extension module AK-XM 101A

Function

The module contains 8 analog inputs for sensors, pressure transmitters, voltage signals and contact signals.

Supply voltage

The supply voltage to the module comes from the previous module in the row.

Supply voltage to a pressure transmitter can be taken from either the 5 V output or the 12 V output depending on transmitter type.

Light-emitting diodes

Only the two top LED's are used. They indicate the following:

- Voltage supply to the module
- Communication with the controller is active (red = error)

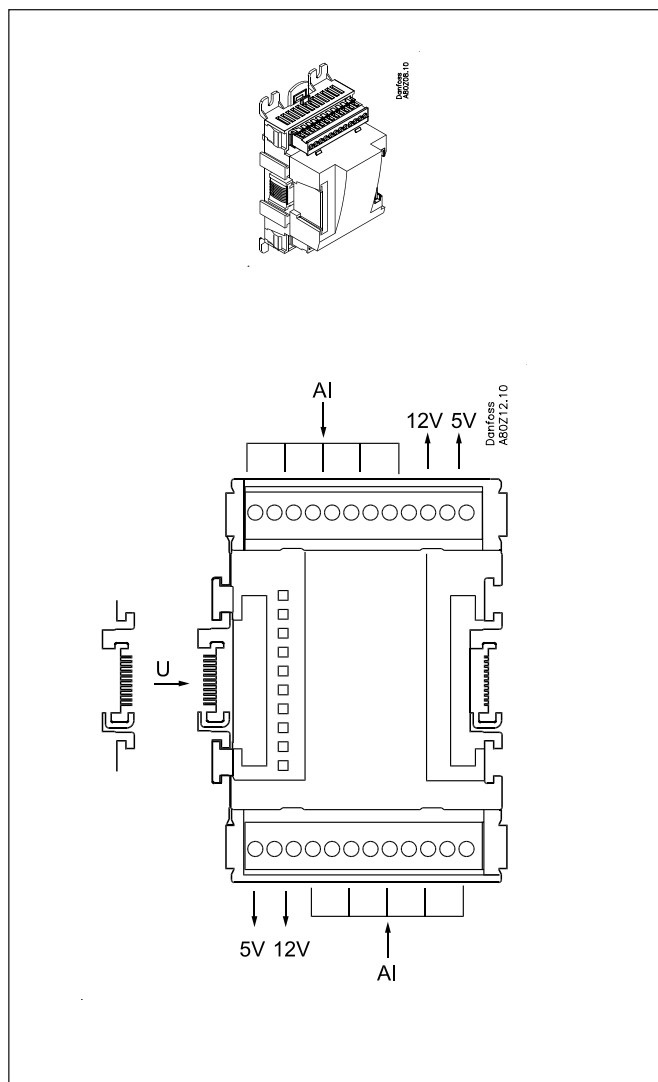

Point

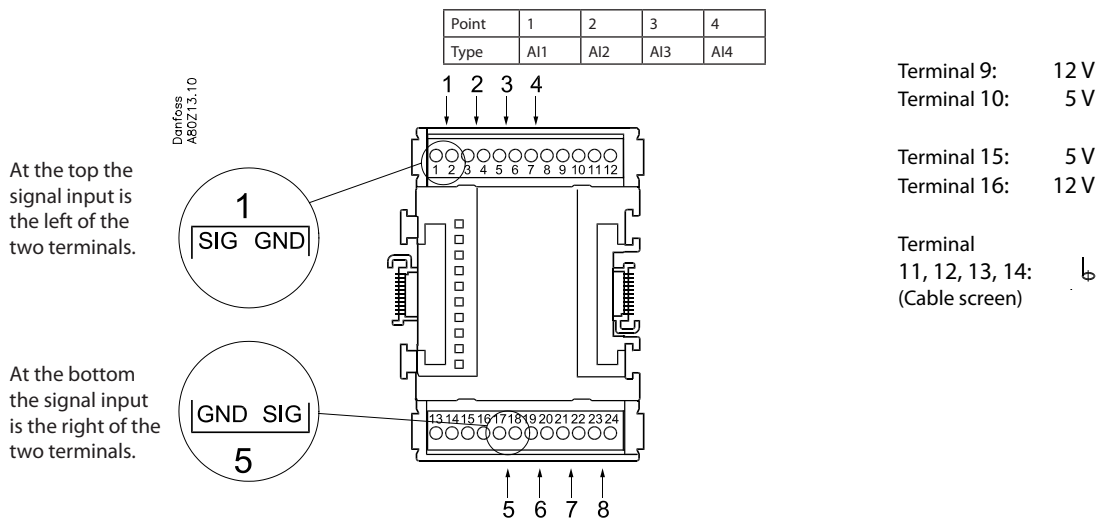

	Signal	Signal type
S Pt 1000 ohm/0°C 	S1 S2 Saux SsA SdA Shr Stw Sgc	Pt 1000
P AKS 32R AKS 32 	POA POB PcA PcB Paux Pgc Prec	AKS 32R / AKS 2050 MBS 8250 -1 - xx bar AKS 32 -1 - zz bar
U 	...	0 - 5 V 0 - 10 V
On/Off 	Ext. Main switch Day/ Night Door Level switch	Active at: Closed / Open

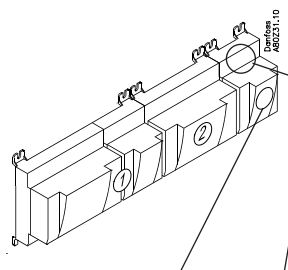

Signal	Module	Point	Terminal	Signal type / Active at
		1 (AI 1)	1 - 2	
		2 (AI 2)	3 - 4	
		3 (AI 3)	5 - 6	
		4 (AI 4)	7 - 8	
		5 (AI 5)	17 - 18	
		6 (AI 6)	19 - 20	
		7 (AI 7)	21 - 22	
		8 (AI 8)	23 - 24	

Extension module AK-XM 102A / AK-XM 102B

Function

The module contains 8 inputs for on/off voltage signals.

Signal

AK-XM 102A is for low voltage signals.

AK-XM 102B is for high voltage signals.

Supply voltage

The supply voltage to the module comes from the previous module in the row.

Light-emitting diodes

They indicate:

- Voltage supply to the module
- Communication with the controller is active (red = error)
- Status of the individual inputs 1 to 8 (when lit = voltage)

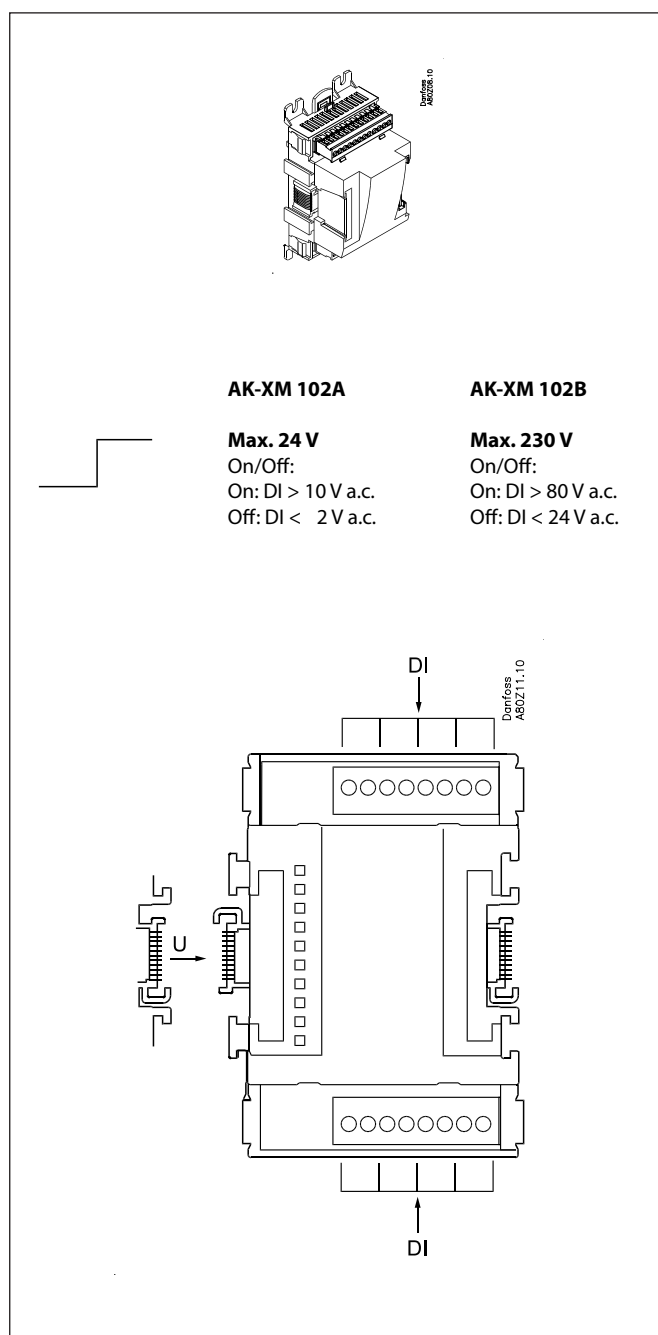

Point

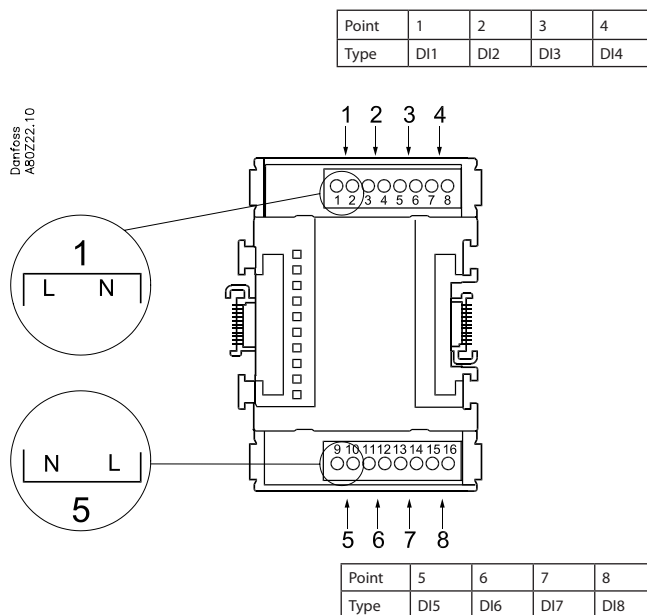

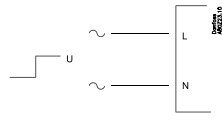
	Signal	Active at
DI AK-XM 102A: Max. 24 V AK-XM 102B: Max. 230 V 	Ext. Main switch	Closed (voltage on)
	Day/ Night	
	Comp. safety 1	Open (voltage off)
	Comp. safety 2	
	Level switch	

(The module can not register a pulse signal from e.g. a reset function.)

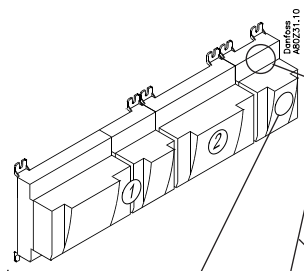

Signal	Module	Point	Terminal	Active at
		1 (DI 1)	1 - 2	
		2 (DI 2)	3 - 4	
		3 (DI 3)	5 - 6	
		4 (DI 4)	7 - 8	
		5 (DI 5)	9 - 10	
		6 (DI 6)	11 - 12	
		7 (DI 7)	13 - 14	
		8 (DI 8)	15 - 16	

Extension module AK-XM 103A

Function

The module contains :

4 analog inputs for sensors, pressure transmitters, voltage signals and contact signals.

4 analog voltage outputs of 0 - 10 V

Supply voltage

The supply voltage to the module comes from the previous module in the row.

Supply voltage to a pressure transmitter can be taken from either the 5 V output or the 12 V output depending on transmitter type.

Galvanic isolation

The inputs are galvanically separated from the outlets.

The outlets AO1 and AO2 are galvanically separated from AO3 and AO4.

Light-emitting diodes

Only the two top LED's are used. They indicate the following:

- Voltage supply to the module
- Communication with the controller is active (red = error)

Max. load

$I < 2.5 \text{ mA}$

$R > 4 \text{ k}\Omega$

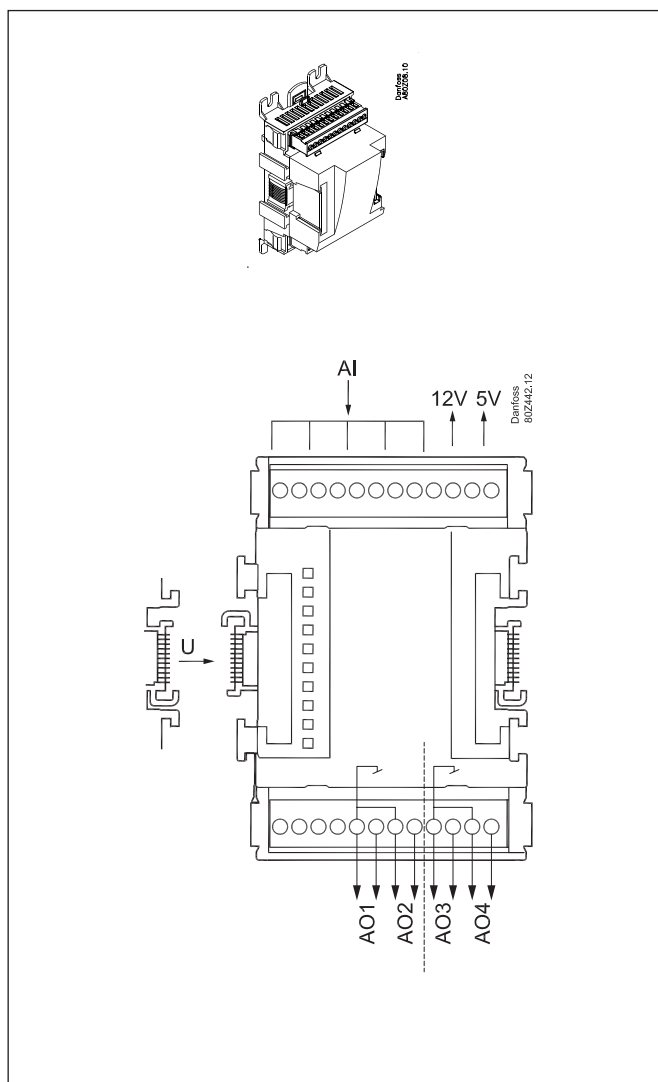

Point

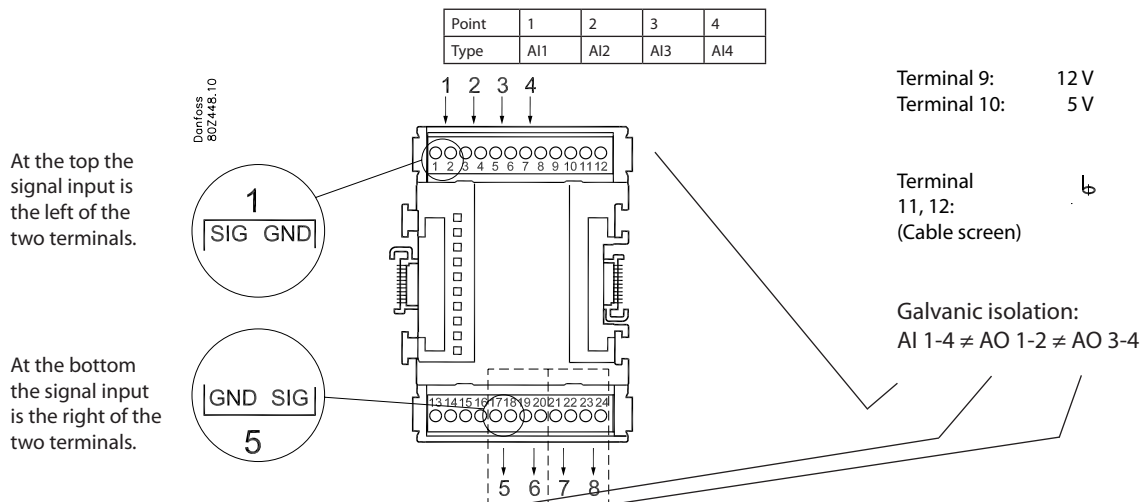

Point	1	2	3	4
Type	AI1	AI2	AI3	AI4

Point	5	6	7	8
Type	AO1	AO2	AO3	AO4

	Signal	Signal type
S Pt 1000 ohm/0°C 	S1 S2 Saux SdA Shr Stw Sgc	Pt 1000
P AKS 32R AKS 32 	POA POB PcA PcB Paux Pgc Prec	AKS 32R / AKS 2050 MBS 8250 -1 - xx bar AKS 32 -1 - zz bar
U 	...	0 - 5 V 0 - 10 V
On/Off 	Ext. Main switch Day/Night Door Level switch	Active at: Closed / Open
AO 		0-10 V

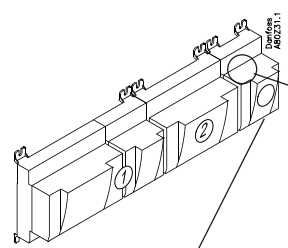

Signal	Module	Point	Terminal	Signal type /Active at
		1 (AI 1)	1 - 2	
		2 (AI 2)	3 - 4	
		3 (AI 3)	5 - 6	
		4 (AI 4)	7 - 8	
		5 (AO 1)	17 - 18	
		6 (AO 2)	19 - 20	
		7 (AO 3)	21 - 22	
		8 (AO 4)	23 - 24	

Extension module AK-XM 204A / AK-XM 204B

Function

The module contains 8 relay outputs.

Supply voltage

The supply voltage to the module comes from the previous module in the row.

AK-XM 204B only

Override of relay

Eight change-over switches at the front make it possible to override the relay's function.

Either to position OFF or ON.

In position Auto the controller carries out the control.

Light-emitting diodes

There are two rows with LED's. They mean:

Left row:

- Voltage supply to the controller
- Communication active with the bottom PC board (red = error)
- Status of outputs DO1 to DO8

Right row: (AK-XM 204B only):

- Override of relays
ON = override
OFF = no override

Fuses

Behind the upper part there is a fuse for each output.

Note

If the changeovers are used to override the compressor operation, it is necessary to wire a safety relay into the circuit for oil management. Without this safety relay, the controller will fail to stop the compressor if it should run out of oil. See Regulating functions.

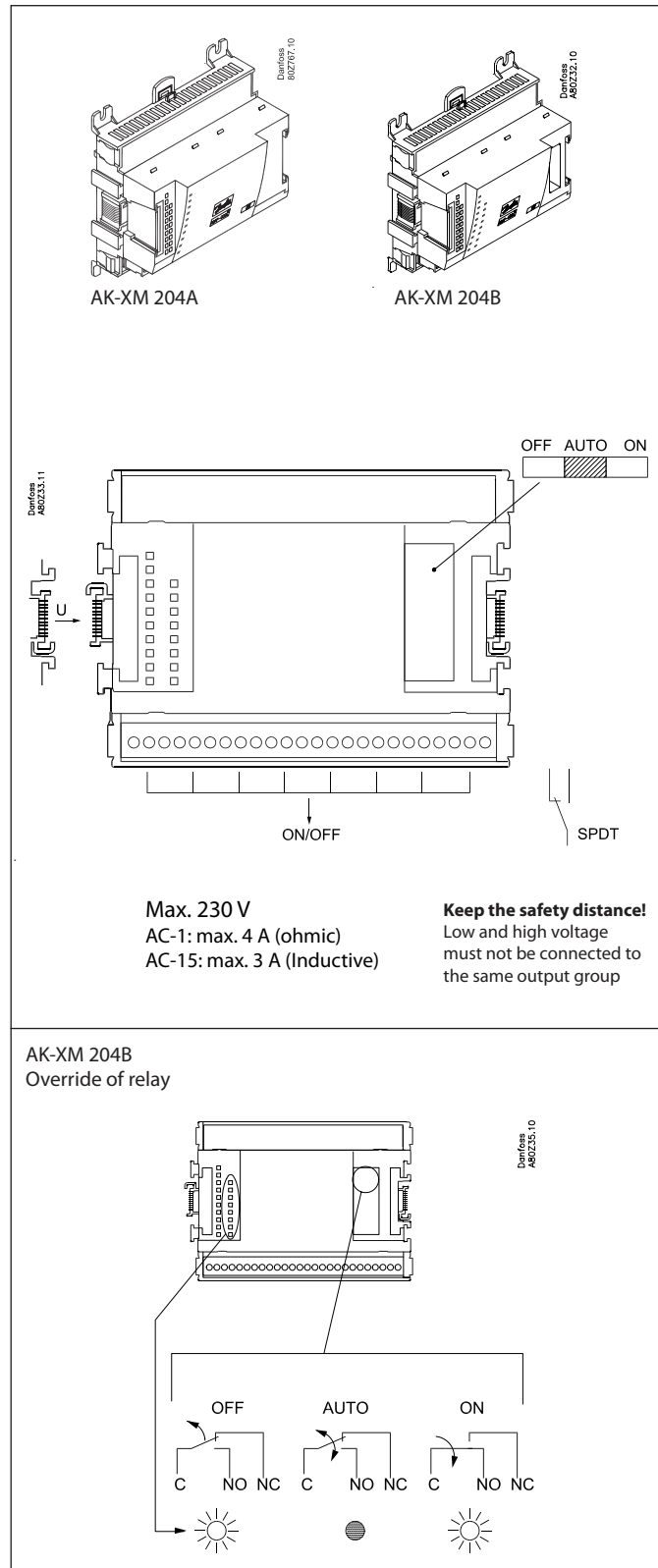

Point

Danfoss
A80234.10

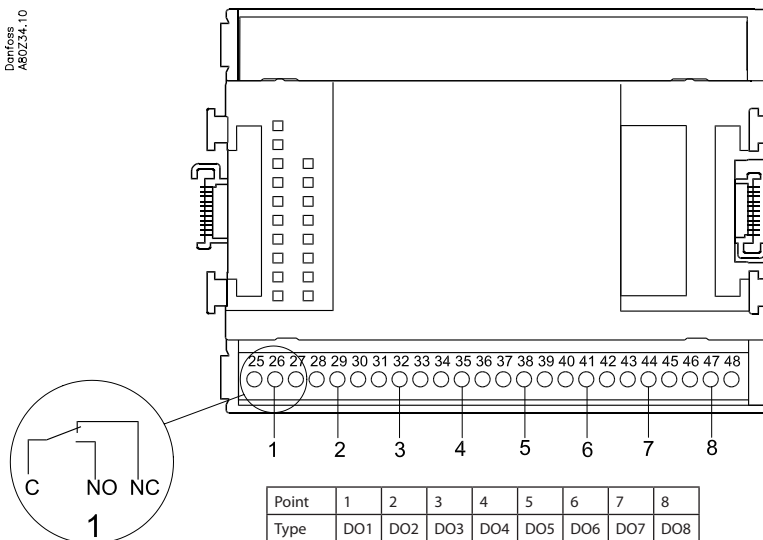

	Signal	Active at
	Comp. 1	On / Off
	Comp. 2	
	Fan 1	
	Alarm	
	Solenoid valve	

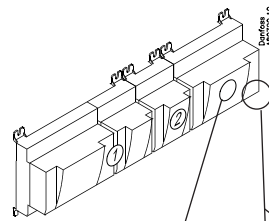

Signal	Module	Point	Terminal	Active at
		1 (DO 1)	25 - 27	
		2 (DO 2)	28 - 30	
		3 (DO 3)	31 - 33	
		4 (DO 4)	34 - 36	
		5 (DO 5)	37 - 39	
		6 (DO 6)	40 - 41 - 42	
		7 (DO 7)	43 - 44 - 45	
		8 (DO 8)	46 - 47 - 48	

Extension module AK-XM 205A / AK-XM 205B

Function

The module contains:
 8 analog inputs for sensors, pressure transmitters, voltage signals and contact signals.
 8 relay outputs.

Supply voltage

The supply voltage to the module comes from the previous module in the row.

AK-XM 205B only

Override of relay

Eight change-over switches at the front make it possible to override the relay's function.

Either to position OFF or ON.

In position Auto the controller carries out the control.

Light-emitting diodes

There are two rows with LED's. They mean:

Left row:

- Voltage supply to the controller
- Communication active with the bottom PC board (red = error)
- Status of outputs DO1 to DO8

Right row: (AK-XM 205B only):

- Override of relays
 ON = override
 OFF = no override

Fuses

Behind the upper part there is a fuse for each output.

Note

If the changeovers are used to override the compressor operation, it is necessary to wire a safety relay into the circuit for oil management. Without this safety relay, the controller will fail to stop the compressor if it should run out of oil. See Regulating functions.

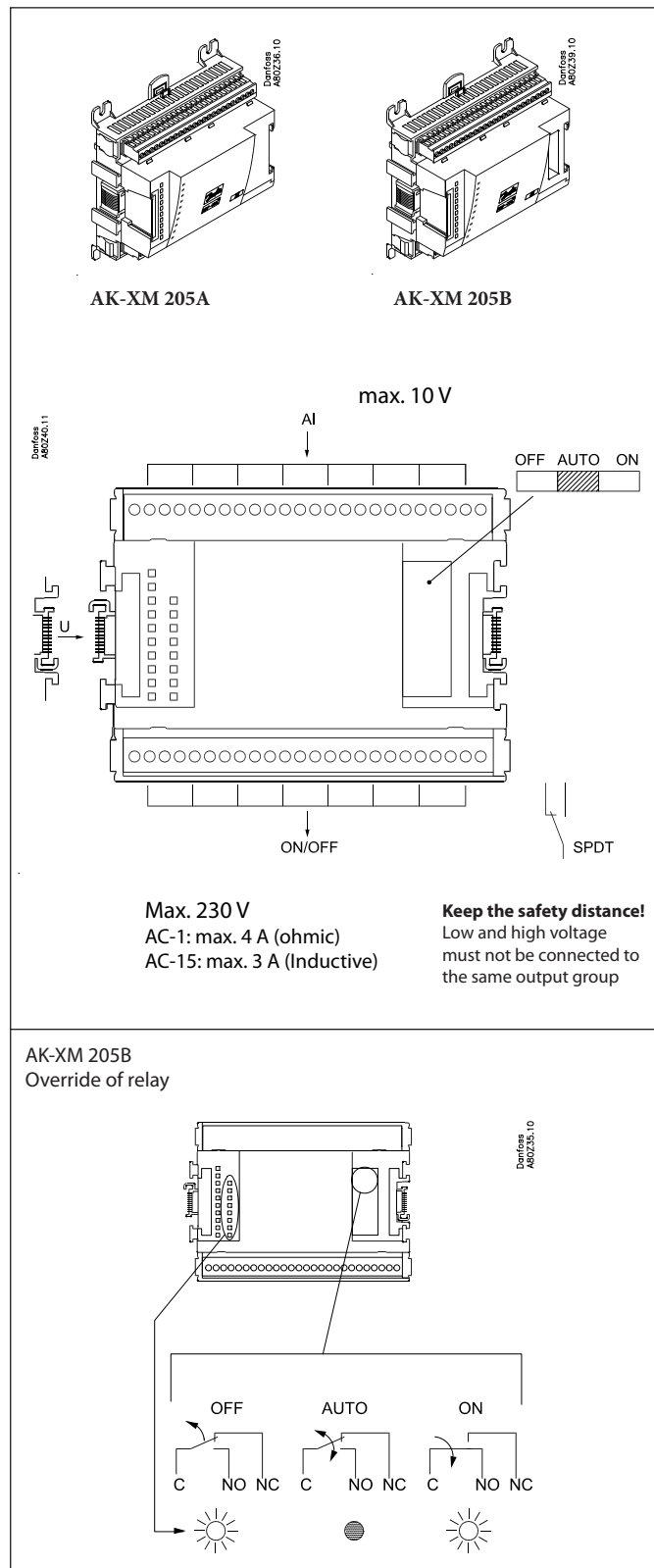

Point

Point	1	2	3	4	5	6	7	8
Type	AI1	AI2	AI3	AI4	AI5	AI6	AI7	AI8

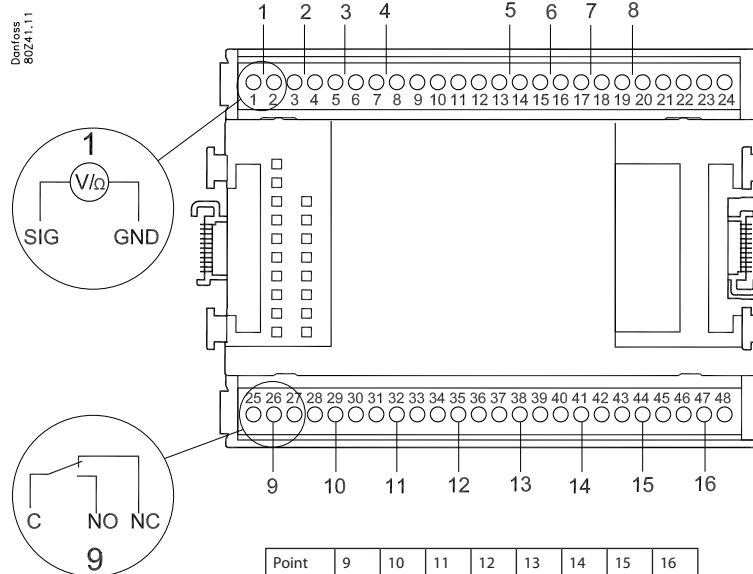

Terminal 9: 12V
Terminal 10: 5V

Terminal 21: 12V
Terminal 22: 5V

Terminal 11, 12, 23, 24: 6 (Cable screen)

Point	9	10	11	12	13	14	15	16
Type	DO1	DO2	DO3	DO4	DO5	DO6	DO7	DO8

	Signal	Signal type
S Pt 1000 ohm/0°C 	S1 S2 Saux SsA SdA Shr Stw Sgc	Pt 1000
P AKS 32R AKS 32 	POA POB PcA PcB Paux Pgc Prec	AKS 32R / AKS 2050 MBS 8250 -1 - xx bar AKS 32 -1 - zz bar
U 	...	0 - 5 V 0 - 10 V
On/Off 	Ext. Main switch Day/ Night Door Level switch	Active at: Closed / Open
DO 	Comp 1 Comp 2 Fan 1 Alarm Light Rail heat Defrost Solenoid valve	Active at: on / Off

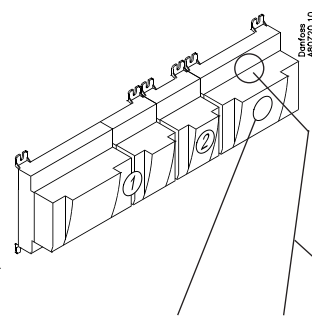

Signal	Module	Point	Terminal	Signal type / Active at
		1 (AI 1)	1 - 2	
		2 (AI 2)	3 - 4	
		3 (AI 3)	5 - 6	
		4 (AI 4)	7 - 8	
		5 (AI 5)	13 - 14	
		6 (AI 6)	15 - 16	
		7 (AI 7)	17 - 18	
		8 (AI 8)	19 - 20	
		9 (DO 1)	25 - 26 - 27	
		10 (DO 2)	28 - 29 - 30	
		11 (DO 3)	31 - 30 - 33	
		12 (DO 4)	34 - 35 - 36	
		13 (DO 5)	37 - 36 - 39	
		14 (DO6)	40 - 41 - 42	
		15 (DO7)	43 - 44 - 45	
		16 (DO8)	46 - 47 - 48	

Extension module AK-XM 208C

Function

The module contains:
 8 analog inputs for sensors, pressure transmitters, voltage signals and contact signals.
 4 outputs for stepper motors.

Supply voltage

The supply voltage to the module comes from the previous module in the row. Here supplied with 5 VA.
 The supply voltage to the valves must be from a separate supply, which must be galvanically separated from the supply for the control range.

(Power requirements: 7.8 VA for controller + xx VA per valve).

A UPS may be necessary if the valves need to open/close during a power failure.

Light-emitting diodes

There is one row with LED's. It indicate the following:

- Voltage supply to the module
- Communication active with the bottom PC board (red = error)
- Step1 to step4 OPEN: Green = Open
- Step1 to step4 CLOSE: Green = Close
- Red flash = Error on motor or connection

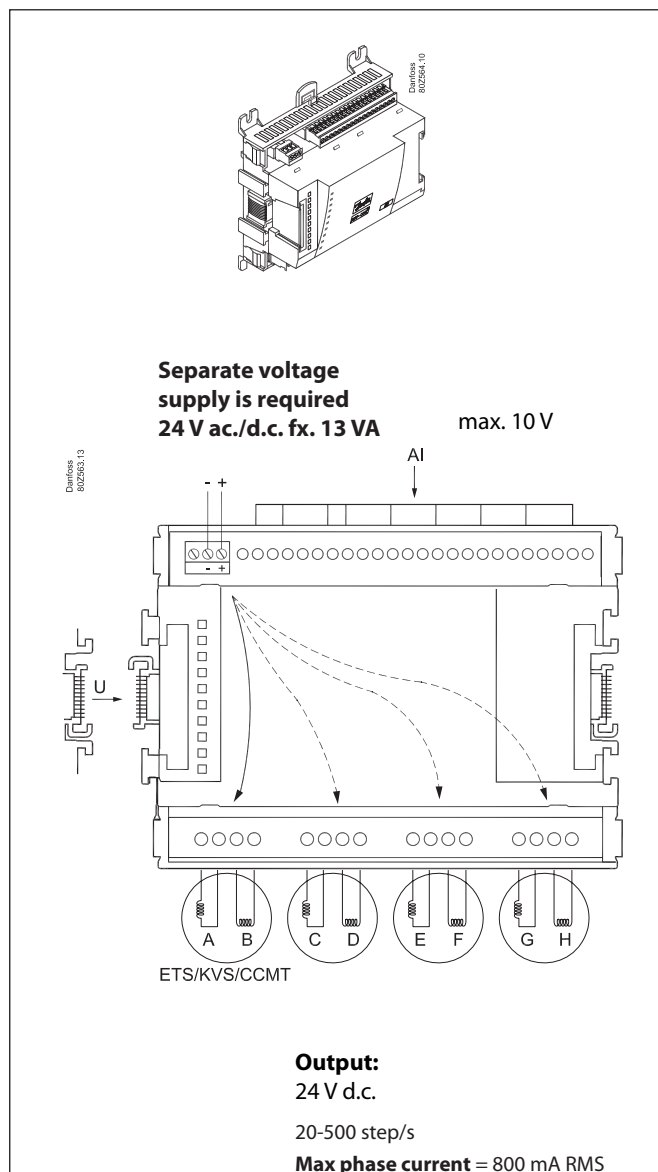

Valve data	
Type	P
ETS 12.5 - ETS 400 KVS 15 - KVS 42 CCMT 2 - CCMT 8 CCM 10 - CCM 40	1.3 VA
CCMT 16 - CCMT 42	5.1 VA

Power supply to AK-XM 208C:

$$\text{Fx: } 7.8 + (4 \times 1.3) = 13 \text{ VA} \Rightarrow \text{AK-PS 075}$$

$$\text{Fx: } 7.8 + (4 \times 5.1) = 28.2 \text{ VA} \Rightarrow \text{AK-PS 150}$$

Point

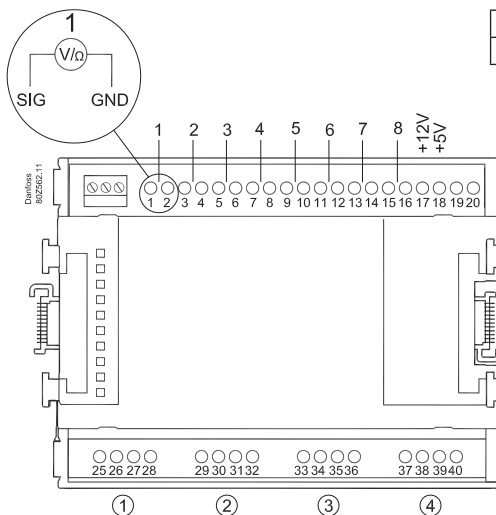

Point	1	2	3	4	5	6	7	8
Type	AI1	AI2	AI3	AI4	AI5	AI6	AI7	AI8

Terminal 17: 12 V
Terminal 18: 5 V

Terminal 19, 20:
(Cable screen) b

Point	9	10	11	12
Step	1	2	3	4
Type	AO			

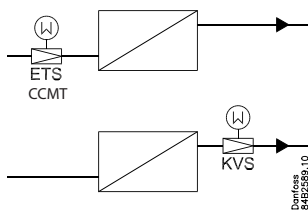

Step / Terminal	1	25	26	27	28
	2	29	30	31	32
	3	33	34	35	36
	4	37	38	39	40
ETS		White	Black	Red	Green
CCM / CCMT		White	Black	Green	Red
KVS 15		White	Black	Green	Red
KVS 42-54		White	Black	Green	Red

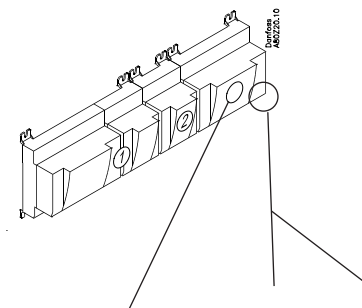

Valve	Module	Step	Terminal
<p>ETS/KVS/CCMT</p>		1 (point 9)	25 - 28
		2 (point 10)	29 - 32
		3 (point 11)	33 - 36
		4 (point 12)	37 - 40

Extension module AK-OB 110

Function

The module contains two analog voltage outputs of 0 – 10 V.

Supply voltage

The supply voltage to the module comes from the controller module.

Placing

The module is placed on the PC board in the controller module.

Point

The two outputs have points 24 and 25. They are shown on the earlier page where the controller is also mentioned.

Max. load

$I < 2.5 \text{ mA}$

$R > 4 \text{ kohm}$

AO	-	→	0-10 V	AO	0 - 10 V
	+	→			

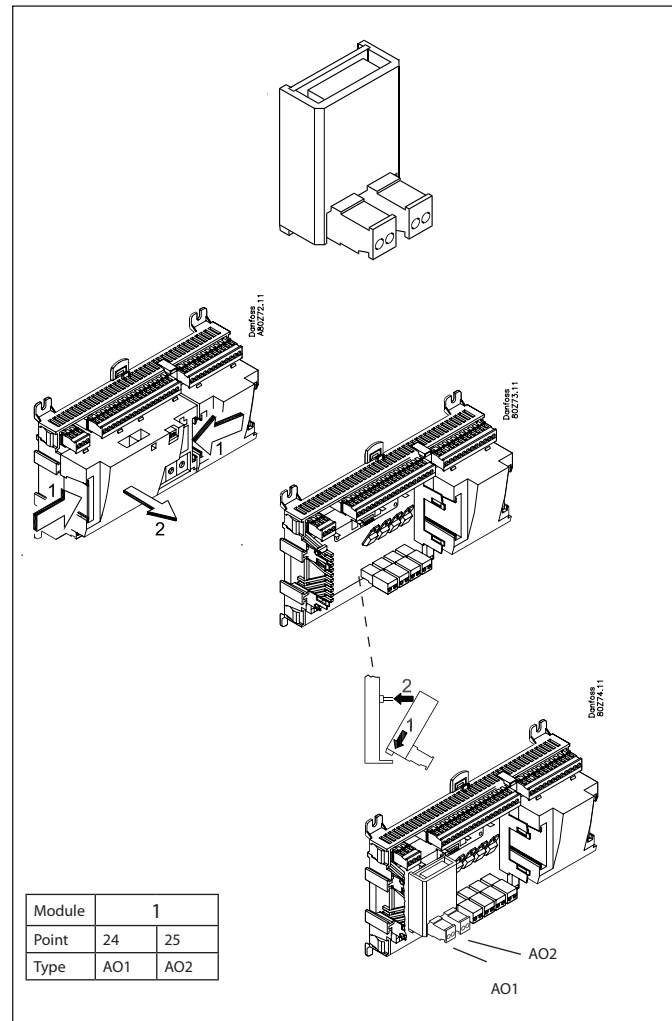

Extension module EKA 163B / EKA 164B / EKA 166

Function

Display of important measurements from the controller, e.g. appliance temperature, suction pressure or condensing pressure. Setting of the individual functions can be performed by using the display with control buttons.

It is the controller used that determines the measurements and settings that can occur.

Connection

The extension module is connected to the controller module via a cable with plug connections. You have to use one cable per module. The cable is supplied in various lengths.

Both types of display (with or without control buttons) can be connected to either display output A, B, C and D.

Ex.

A: P0. Suction pressure in °C.

B: Pc. Condensing pressure in °C.

When the controller starts up, the display will show the output that is connected.

-- 1 = output A

-- 2 = output B

etc.

Placing

The extension module can be placed at a distance of up to 15 m from the controller module.

Point

No point has to be defined for a display module – you simply connect it.

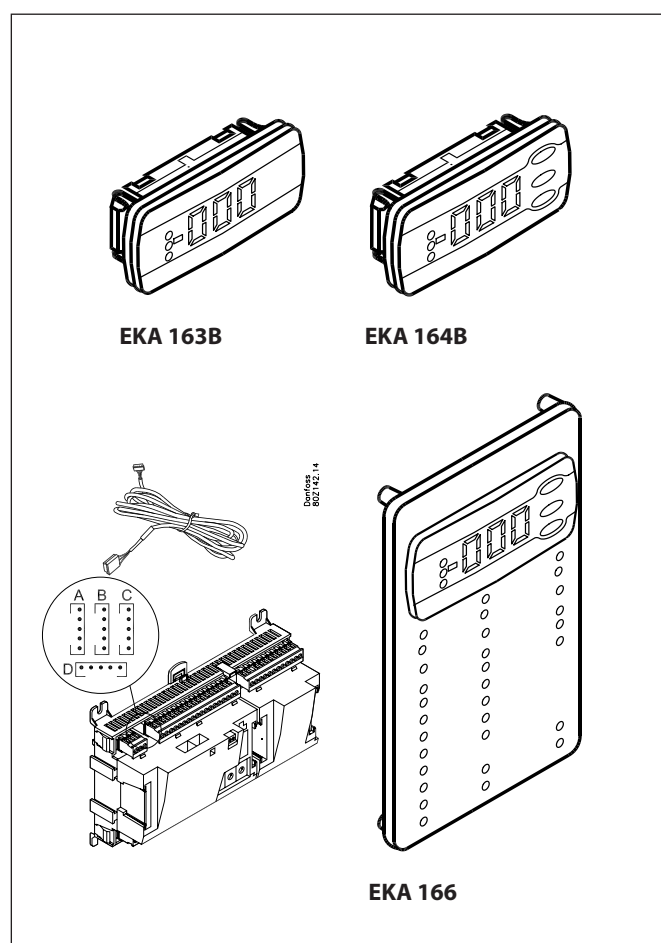

Graphic display MMIGRS2

Function

Setting and display of values in the controller.

Connection

The display connects to the controller via a cable with RJ11 plug connections.

Supply voltage

Received from the controller via cable and RJ11 connector.

Termination

The display must be terminated. Mount a connection between the terminals H and R.

(AK-PC 781A is terminated internally.)

Placing

The display can be placed at a distance of up to 3 m from the controller.

Point / Address

No point has to be defined for a display – you simply connect it. However, the address must be verified. See the instructions accompanying the controller.

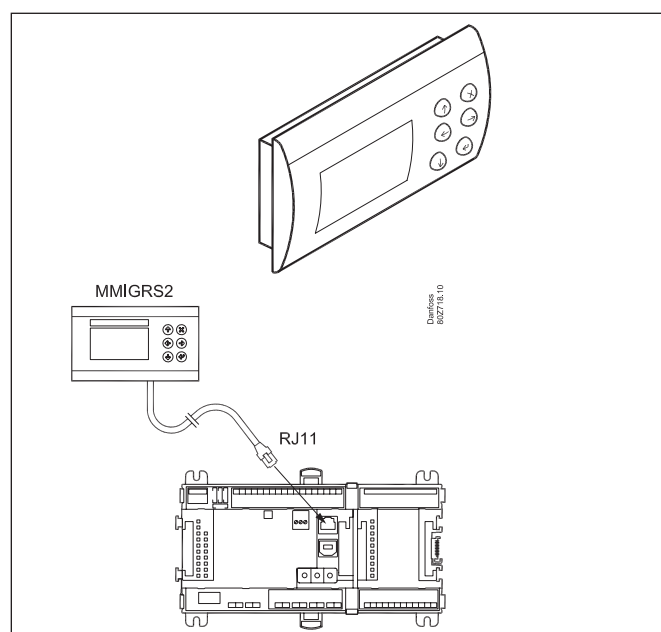

Power supply module AK-PS 075 / 150 / 250

Function

24 V supply for controller.

Supply voltage

230 V a.c. or 115 V a.c. (from 100 V a.c. to 240 V a.c.)

Placing

On DIN-rail

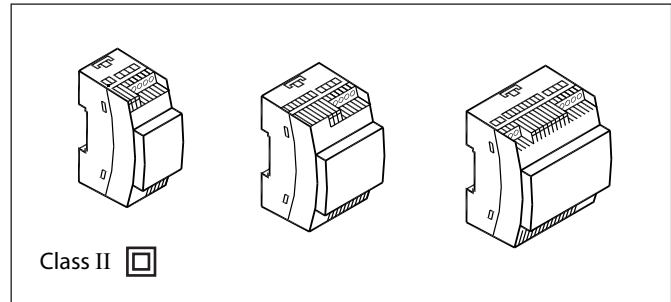

Effect

Type	Output tension	Output current	Power
AK-PS 075	24 V d.c.	0.75 A	18 VA
AK-PS 150	24 V d.c. (adjustable)	1.5 A	36 VA
AK-PS 250	24 V d.c. (adjustable)	2.5 A	60 VA

Supply to a controller

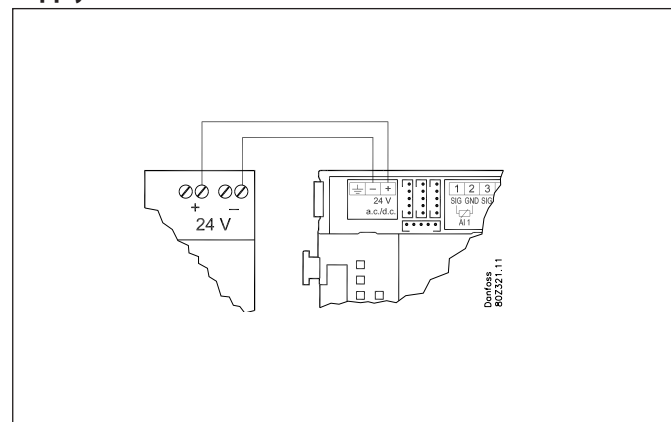

Dimension

Type	High	Width
AK-PS 075	90 mm	36 mm
AK-PS 150	90 mm	54 mm
AK-PS 250	90 mm	72 mm

Connections

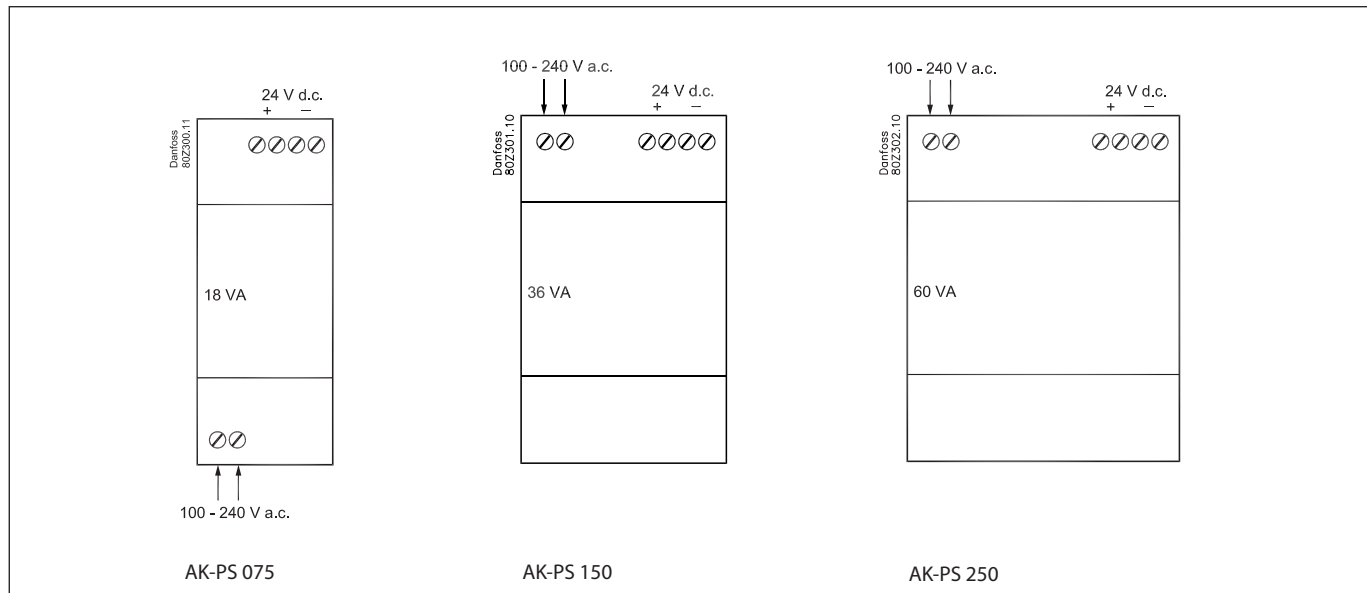

Communication module AK-CM 102

Function

The module is a new communication module, meaning the row of extension modules can be interrupted.

The module communicates with the regulator via data communication and forwards information between the controller and the connected extension modules.

Connection

Communication module and controller fitted with RJ 45 plug connectors.

Nothing else should be connected to this data communication; a maximum of 5 communication modules can be connected to one controller.

The communication module can be used only with controllers of the type AK-PC 781A.

Communication cable

One metre of the following is enclosed:
ANSI/TIA 568 B/C CAT5 UTP cable w/ RJ45 connectors.

Positioning

Max. 30 m from the controller
(The total length of the communication cables is 30 m)

Supply voltage

24 volt AC or DC should be connected to the communication module.

The 24 V can be sourced from the same supply that supplies the controller. (The supply for the communication module is galvanically separated from the connected extension modules).
The terminals must **not** be earthed.

The power consumption is determined by the power consumption of the total number of modules.

The controller strand load must not exceed 32 VA.

Each AK-CM 102 strand load must not exceed 20 VA.

Point

Connection points on the I/O modules should be defined as if the modules were an extension of each other.

Address

The address for the first communication module should be set to 1. Any second module should be set to 2. A maximum of 5 modules can be addressed.

Termination

The termination switch on the final communication module should be set to ON.

The controller should permanently be set to = ON.

Warning

Additional modules may only be installed following the installation of the final module. (Here following module no. 11; see the sketch.)

After configuration, the address must not be changed.

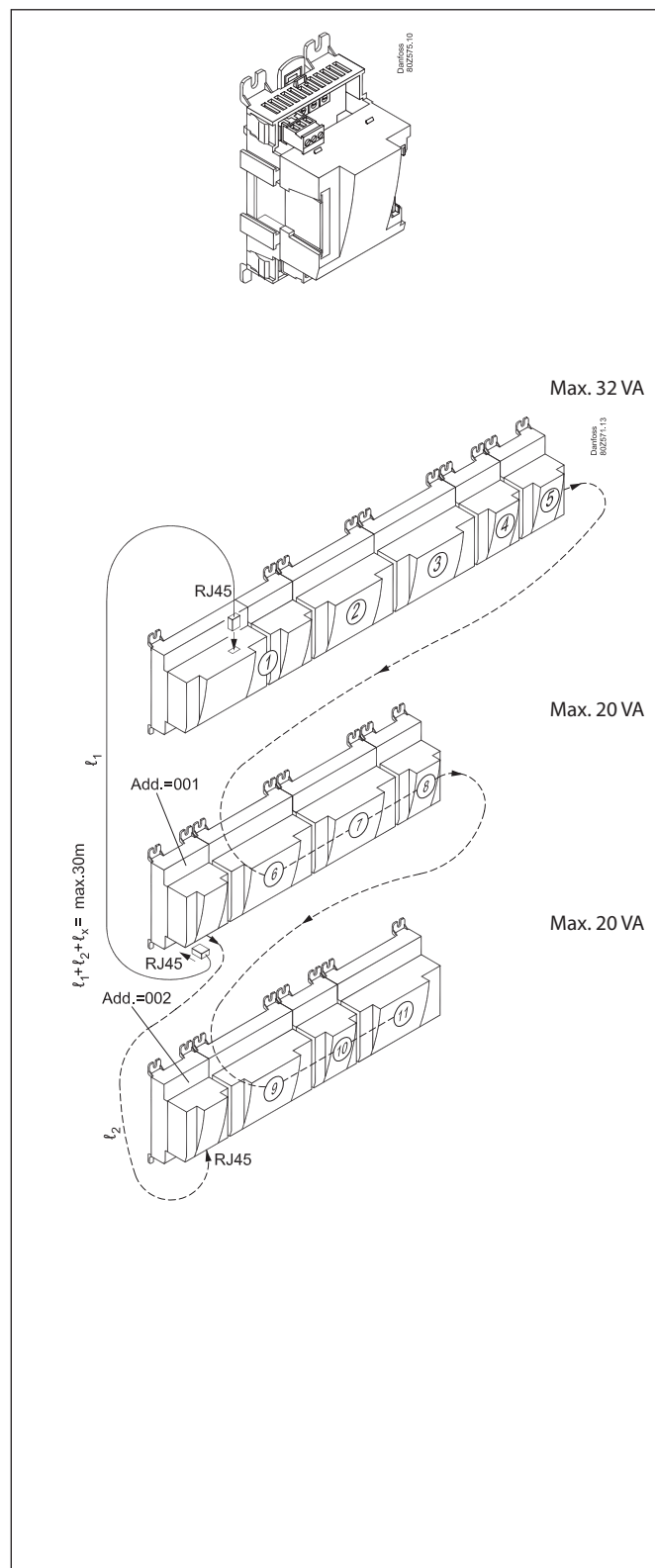

Preface to design

Be aware of the following when the number of extension modules is being planned. A signal may have to be changed, so that an additional module may be avoided.

- An ON/OFF signal can be received in two ways. Either as a contact signal on an analog input or as voltage on a low or high-voltage module.
- An ON/OFF output signal can be given in two ways. Either with a relay switch or with solid state. The primary difference is the permitted load and that the relay switch contains a cutout switch.

Mentioned below are a number of functions and connections that may have to be considered when a regulation has to be planned. There are more functions in the controller than the ones mentioned here, but those mentioned have been included in order that the need for connections can be established.

Functions

Clock function

Clock function and change-over between summer time and winter time are contained in the controller.

The clock setting is maintained for at least 12 hours at a power failure.

The clock setting is kept updated if the controller is linked up in a network with a system manager.

Start/stop of regulation

Regulation can be started and stopped via the software. External start/stop can also be connected.

Warning

The function stops all regulation, including any high-pressure regulation.

Excess pressure can lead to a loss of charge.

Start/stop of compressors

External start/stop can be connected.

Alarm function

If the alarm is to be sent to a signal transmitter, a relay output will have to be used.

I'm alive function

A relay can be reserved which is pulled during normal regulation. The relay will be released if the regulation stops with the main switch or if the controller fails.

Extra temperature sensors and pressure sensors

If additional measurements have to be carried out beyond the regulation, sensors can be connected to the analog inputs.

Forced control

The software contains a forced control option. If an extension module with relay outputs is used, the module's top part can be with change-over switches – switches that can override the individual relays into either OFF or ON position.

Wiring should be done with a safety relay. See Regulating functions.

Data communication

The controller module has terminals for LON data communication. The requirements to the installation are described in a separate document.

Connections

In principle there are the following types of connections:

Analog inputs "AI"

This signal must be connected to two terminals.

Signals can be received from the following sources:

- Temperature signal from Pt 1000 ohm temperature sensor
- Pulse signal or reset signal
- Contact signal where the input is short-circuited or "opened", respectively
- Voltage signal from 0 to 10 V
- Signal from pressure transmitter AKS 32, AKS 32R, AKS 2050 or MBS 8250.
The supply voltage is supplied from the module's terminal board where there is both a 5 V supply and a 12 V supply.
When programming the pressure transmitter's pressure range must be set.

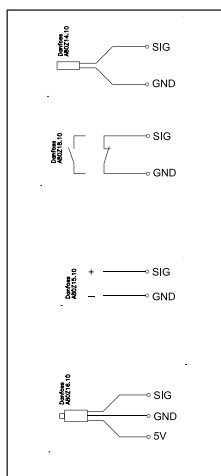

ON/OFF output signals "DO"

There are two types, as follows:

- Relay outputs
All relay outputs are with change-over relay so that the required function can be obtained when the controller is without voltage.
- Solid state outputs
Reserved for AKV valves, but output can cut an external relay in and out, as with a relay output.
The output is only found on the controller module.

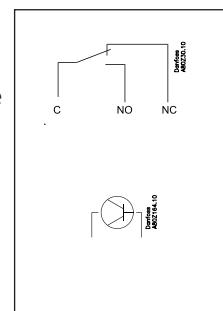

When programming the function must be set:

- Active when the output is activated
- Active when the output is not activated.

ON/OFF voltage inputs "DI"

This signal must be connected to two terminals.

- The signal must have two levels, either 0 V or "voltage" on the input.
There are two different extension modules for this signal type:
 - low-voltage signals, e.g. 24 V
 - high-voltage signals, e.g. 230 V

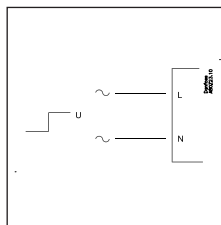

Analog output signal "AO"

This signal is to be used if a control signal is to be transmitted to an external unit, e.g. a frequency converter.

When programming the signal range must be defined: 0-5 V, 1-5 V, 0-10 V, 2-10 V, 10-0 V or 5-0 V.

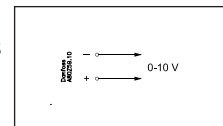

Pulse signal for the stepper motors.

This signal is used by valve motors of the type ETS, KVS and CCMT.

The valve type should be set during programming.

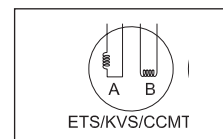

When programming the function must be set:

- Active when the input is without voltage
- Active when voltage is applied to the input.

Limitations

As the system is very flexible regarding the number of connected units you must check whether your selection complies with the few limitations there are.

The complexity of the controller is determined by the software, the size of the processor, and the size of the memory. It provides the controller with a certain number of connections from which data can be downloaded, and others where coupling with relays can be performed.

- ✓ The sum of connections cannot exceed **120** (AK-PC 781A).
- ✓ The number of extension modules must be limited so that the total power in a row will not exceed **32 VA** (including controller).
If the AK-CM 102 communication module is used, each row of AK-CM 102 must not exceed 20 VA (incl. AK-CM 102).
There must not be more than a total of 12 modules (controller + 11 modules).
- ✓ No more than **5** pressure transmitters may be connected to one controller module.
- ✓ No more than **5** pressure transmitters may be connected to one extension module.

Common pressure transmitter

If several controllers receive a signal from the same pressure transmitter, the supply to the affected controllers must be wired so that it is not possible to switch off one of the controllers without also switching off the others. (If one controller is switched off, the signal will be pulled down, and all the other controllers will receive a signal which is too low)

Design of a compressor and condenser control

Procedure:

1. Make a sketch of the system in question
2. Check that the controller's functions cover the required application
3. Consider the connections to be made
4. Use the planning table. / Note down the number of connections / add up
5. Are there enough connections on the controller module? – If not, can they be obtained by changing an ON/OFF input signal from voltage signal to contact signal, or will an extension module be required?
6. Decide which extension modules are to be used
7. Check that the limitations are observed
8. Calculate the total length of modules
9. The modules are linked together
10. The connection sites are established
11. Draw a connection diagram or a key diagram
12. Size of supply voltage/transformer

← Follow these 12 steps

1

Sketch

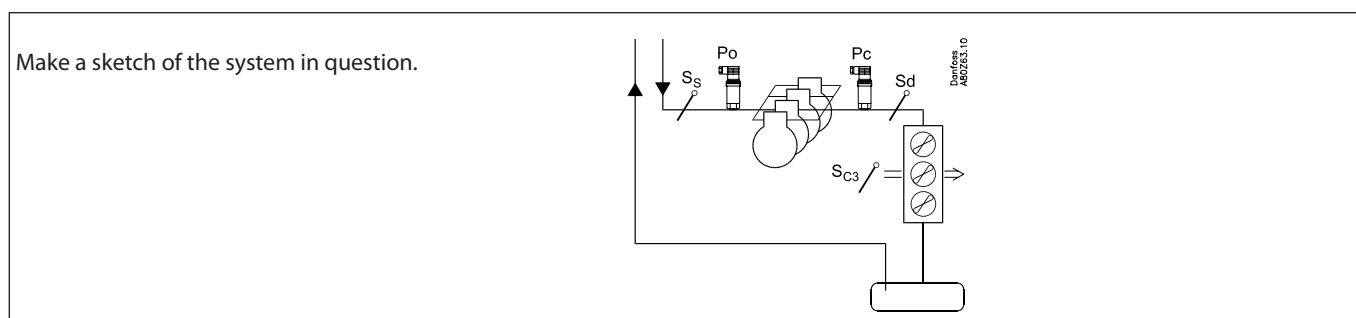

2

Compressor and condenser functions

	AK-PC 781A
Application	
Regulation of a compressor group	x
Regulation of a condenser group	x
Both compressor group and condenser group	x
Regulation of compressor capacity	
Regulation sensor. Either P0, S4 or Pctrl	x
PI-regulation	x
Max. number of compressor steps	10
Max. number of unloaders each compressor	3
Identical compressor capacities	x
Different compressor capacities	x
Speed regulation of 1 or 2 compressors	x
Run time equalisation	x
Min. restart time	x
Min. On-time	x
Liquid injection in suction line	x
Liquid injection in cascade heat exchanger	x
External start/stop of compressors	x
Oil management	
Oil injection in compressor. Shared or individual	x

Receiver pressure control	x
Monitoring of oil level in receiver	x
Management of oil level in oil separator	x
Reset of oil management	x
Cutout of compressors at oil failure	x
Safety relays during forced compressor control	x
Suction pressure reference	
Override via P0 optimization	x
Override via "night setback"	x
Override via "0 -10 V signal"	x
Regulation of condenser capacity	
Regulation sensor. Either: Pc, Sgc or S7	x
Step regulation	x
Max. number of steps	8
Speed regulation	x
Step and speed regulation	x
Speed regulation first step	x
Limitation of speed during night operation	x
Heat recovery function for tap water control	x
Heat recovery function for heating	x
Controlling the gas cooler (high pressure valve). parallel valve, if applicable	x

Trouble-shooting function FDD on condenser	x
Condenser pressure reference	
Floating condensing pressure reference	x
Setting of references for heat recovery functions	x
Safety functions	
Min. suction pressure	x
Max. suction pressure	x
Max. condensing pressure	x
Max. discharge gas temperature	x
Min. / Max. superheat	x
Safety monitoring of compressors	x
Common high pressure monitoring of compressors	x

Safety monitoring of condenser fans	x
General alarm functions with time delay	10
Miscellaneous	
Extra sensors	7
Inject On function	x
Option for connection of separate display	4 + 1
Separate thermostat functions	5
Separate pressostat functions	5
Separate voltage measurements	5
PI regulation	3
Max. input and output	120

A bit more about the functions

Compressor

Regulation of up to 10 compressors. And up to 3 unloaders each compressor.

Compressor No. 1 or 2 can be speed-regulated.

The following can be used as control sensor:

- 1) P0 - Suction pressure
- 2) S4 - Cold brine temperature
- 3) Pctrl - Condensing pressure in the low pressure circuit controls the high-pressure circuit for cascade control.
(P0 is also used for 2 and 3, but for low-pressure safety.)

Condenser

Regulation of up to 8 condenser steps.

Fans can be speed-regulated. Either all on one signal or only the first fan of several. EC motor can be used.

Relay outputs and solid state outputs may be used, as desired.

The following can be used as control sensor:

- 1) Pc - Condensing pressure
- 2) S7 - Warm brine temperature (Pc is used here for high-pressure safety.)
- 3) Sgc - Temperature at the gas cooler outlet.

Connection between high-pressure and low-pressure circuits (MT and LT circuits)

Capacity control of the high-pressure circuit can be adjusted by the condensing pressure in the low-pressure circuit.

The controller can give off a signal from a relay output so that the low-pressure circuit can only start when the high-pressure circuit is on.

The controller can receive a signal from the low-pressure circuit that there is a need for refrigeration.

Coordination is also required for parallel compression.

Speed regulation of condenser fans

The function requires an analog output module.

A relay output may be used for start/stop of the speed regulation.

The fans may also be cut in and out by relay outputs.

Pulse wide modulating unloading

When using a compressor with PWM-unloading, the unloading should be connected to one of the four solid state outputs in the controller.

Heat recovery

There are adjustment options for hot water and heat containers for heating.

The controller manages, in order of priority: 1 -tap water 2-heating 3-gas cooler, which removes the remaining excess heat.

Safety circuit

If signals are to be received from one or more parts of a safety circuit, each signal must be connected to an ON/OFF input.

Day/night signal for raising the suction pressure

The clock function can be used, but an external ON/OFF signal may be used instead.

If the "P0 optimization" function is used, no signal will be given concerning the raising of the suction pressure. The P0 optimization will see to this.

"Inject ON" override function

The function closes expansion valves on evaporator controls when all compressors are prevented from starting.

The function can take place via the data communication, or it may be wired via a relay output.

Separate thermostat and pressure control functions

A number of thermostats can be used according to your wishes.

The function requires a sensor signal and a relay output. In the controller there are settings for cutin and cutout values. An associated alarm function may also be used.

Separate voltage measurements

A number of voltage measurements can be used according to your wishes. The signal can for example be 0-10 V. The function requires a voltage signal and a relay output. In the controller there are settings for cutin and cutout values. An associated alarm function may also be used.

If you want to know more about the functions, go to chapter 5.

3 Connections

Here is a survey of the possible connections. The texts can be read in context with the table on the following page.

Analog inputs

Temperature sensors

- S4 (Cold brine temperature)
Must be used when the control sensor for compressor control has been selected as S4.
- Ss (suction gas temperature)
Must always be used in connection with compressor regulation.
- Sd (discharge gas temperature)
Must always be used in connection with compressor regulation.

- Sc3 (outdoor temperature)
To be used when monitoring function FDD is used.
To be used when regulation is performed with floating condenser reference.
- S7 (warm brine return temperature)
Must be used when the control sensor for condenser has been selected as S7.
- Saux (1-4), any extra temperature sensors
Up to four additional sensors for monitoring and data collection may be connected. These sensors can be used for general thermostat functions.
- Stw2, 3, 4 and 8 (temperature sensors for heat recovery)
Must be used when adjusting hot tap water.
- Shr2, 3, 4 and 8 (temperature sensors for heat recovery)
Must be used when adjusting the heat receiver for heating.

- Sgc (temperature sensor for gas cooling controls)
Shall be placed within one metre after the gas cooler.
- Shp (temperature sensor, if the refrigerant can be routed outside of the gas cooler)

Pressure transmitters

- P0 Suction Pressure
Must always be used in connection with compressor regulation (frost protection).
 - Pctrl (control pressure for cascade)
Must only be used if the control sensor for compressor control has been selected as Pctrl (cascade)
 - Pc Condensing Pressure
Must always be used in connection with compressor or condenser regulation
 - Prec. Oil receiver pressure. Must be used for receiver pressure regulation.
 - Pgc Gas cooler pressure. Must be used for CO2 transcritical operation.
 - Prec.CO2 Pressure reading in the CO2 receiver. Must be used for CO2 transcritical operation.
 - Paux (1-5)
Up to 5 extra pressure transmitters can be connected for monitoring and data collection.
These sensors can be used for general pressure switch functions.
- Note. A pressure transmitter type AKS 32, AKS 32R or MBS 8250 can supply signals to a maximum of five controllers.

Voltage signal

- Ext. Ref
Used if a reference override signal is received from another control.
- Voltage inputs (1-5)
Up to 5 extra voltage signals can be connected for monitoring and data collection. These signals are used for general voltage input functions.

On/Off-inputs

- Contact function (on an analog input) or voltage signal (on an extension module)
- Common safety input for all compressors (e.g. common high-pressure/low-pressure pressure switch)
 - Up to 6 signals from the safety circuit of each compressor
 - Compressor release signal on LT controller in cascade
 - Compressor requirements signal on MT controller in cascade

Example

Compressor group:

- MT circuits
- Refrigerant CO2 (R744)
- 4 only compressors with "Best fit". One speed controlled
- Safety monitoring of each compressor
- Common high-pressure monitoring
- Po setting -15°C, night displacement 5 K
- Oil management of each compressor
- Pulse reset for stopped compressor (lack of oil)

High pressure controls:

- Heat recovery for tap water
- Heat recovery for heating circuit
- Gas cooler
- Fans, speed controlled
- Pc regulates based on temperature sensor Sc3 and Sgc

Receivers:

- Monitoring of CO2 level
- Control of pressure in oil receiver
- Controlling the tap water receiver temperature, 55°C
- Controlling the receiver temperature for the heating circuit, 40°C

- Signal from the condenser fans safety circuit
- Any signal from the frequency converter's safety circuit
- External start/stop of regulation
- External day/night signal (raise/lower the suction pressure reference). The function is not used if the "P0 optimization" function is used.
- DI alarm (1-10) inputs
Up to 10 no. extra on/off signals for general alarm for monitoring and data collection can be connected.
- Flow switch for heat recovery
- Level contacts

On/off-outputs

Relay outputs

- Compressors
- Unloaders
- Fan motor
- Injection On function (signal for evaporator controls. One per suction group).
- Start/stop of liquid injection in heat exchanger
- Compressor release, output signal from MT controller in cascade
- Compressor request, output signal from LT controller in cascade
- Start/stop of liquid injection in suction line
- Start/stop of 3-way valves at heat recovery
- ON/OFF signal for start/stop of speed regulation
- Alarm relay. I'm alive relay.
- On/off signals from general thermostats (1-5), pressure switches (1-5) or voltage input functions (1-5).
- Oil valves
- Safety relays for cutouts of compressors at oil failure

Solid state outputs

The solid state outputs on the controller module may be used for the same functions as those mentioned under "relay outputs". (The output will always be "OFF" when the controller has a power failure).

Analog output

- Speed regulation of the condenser's fans.
- Speed regulation of the compressor
- Speed control of pumps for heat recovery
- Control signal for high pressure CO2 valve. (stepper signal. if applicable)
- Stepper signal for hot gas by-pass valve

Fan in plant room

- Thermostat control of fan in engine room
- Safety functions:**
 - Monitoring of Po, Pc, Sd and superheat in suction line
 - Po max = -5°C, Po min = -35°C
 - Pc max = 50 °C
 - Sd max = 120°C
 - SH min = 5 °C, SH max = 35 °C
 - Monitoring of low and high level in oil receiver
- Other:**
 - Alarm output used
 - External compressor stop used

Data from this example is used on the next page.

The result is that the following modules should be used:

- AK-PC 781A controller
- AK-XM 205A input and output module
- AK-XM 208C stepper output module
- AK-XM 102B digital input module
- AK-XM 103B analog input and output module
- AK-OB 110 analog output module

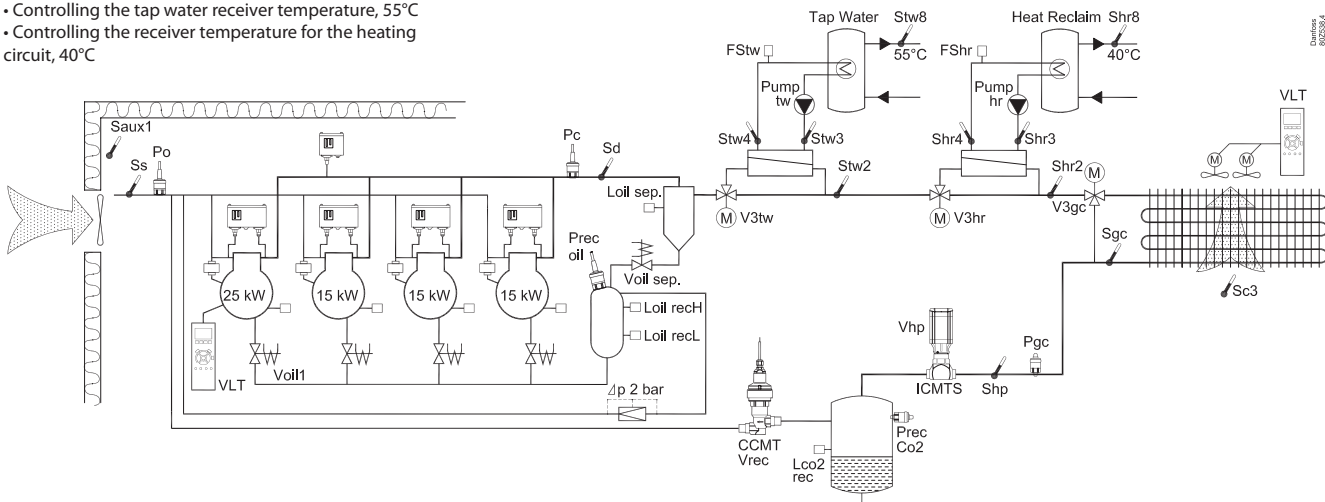

4 Planning table

The table helps you establish whether there are enough inputs and outputs on the basic controller. If there are not enough of them, the controller must be extended by one or more of the mentioned extension modules.

Note down the connections you will require and add them up

	Analog input signal Example		On/off voltage signal Example		On/off voltage signal Example		On/Off output signal Example		Analog output signal 0-10 V Stepper output Example		7 Limitations
Analog inputs											
Temperature sensors, Ss, Sd, Sc3, S4, S7, Stw., Shr., Sgc		9									P = Max. 5 / module
Extra temperature sensor / separate thermostats /PI-regulation		1									
Pressure transmitters, P0, Pc, Pctrl. Prec / separate pressostats		5									
Voltage signal from other regulation, separate signals											
Heat recovery via thermostat											
On/off inputs	Contact		24 V		230 V						
Safety circuits, common for all compressors						1					Max.1
Safety circuits, Oil pressure											Max. 1/ Comp.
Safety circuits, comp. Motor protection											
Safety circuits, comp. Motor temp.											
Safety circuits, comp. High pres. thermostat											
Safety circuits, comp. High pres. pressostat											
Safety circuits, general for each compressor						4					
Safety circuits, condenser fans, frequency converter											Max. 1/ fan
Safety circuits, flow switch						2					
External start/stop		1									
LT release input / MT request input / IT release input											
Night setback of suction pressure											
Separate alarm functions via DI		1									
Load shedding											
Start of Heat recovery		1				1					
Liquid level, Oil level		8									
Pulse reset of oil management		1									
On/off outputs											
Compressors, motors						4					
Unloaders											
Fan motors, circulation pumps						3					
Alarm relay, I'm alive relay											
Inject ON											
Separate thermostat and pressostat functions and voltage measurements						1					Max. 1
Heat recovery function via thermostat											Max. 5+5+5
Liquid injection in suction line / heat exchanger. Heat gas dump											Max.1
MT release output / LT request output / IT on-outp. / IT release outp.											Max.1
Solenoid valve for Oil.						5					
3-way valve						3					
Analog control signal, 0-10 V											
Frequency converter, Compressor, fans, pumps, valves etc.										5	
Valves with stepper motor. Parallel valves, if applicable										1	
Sum of connections for the regulation		27		0		8		16			5+1
Number of connections on a controller module	11	11	0	0	0	0	8	8	0	0	0
5 Missing connections, if applicable		16		-		8		8			5+1
6 The missing connections to be supplied by one or more extension modules:											Sum of power
AK-XM 101A (8 analog inputs)											___ pcs. á 2 VA = ___
AK-XM 102A (8 digital low voltage inputs)											___ pcs. á 2 VA = ___
AK-XM 102B (8 digital high voltage outputs)						1					___ pcs. á 2 VA = ___
AK-XM 103A (4 analog inputs, 4 analog outputs)		1									___ pcs. á 2 VA = ___
AK-XM 204A / B (8 relay outputs)											___ pcs. á 5 VA = ___
AK-XM 205A / B (8 analog inputs. + 8 relay output)		1						1			___ pcs. á 5 VA = ___
AK-XM 208C (8 analog inputs + 4 stepper outputs)		1									___ pcs. á 5 VA = ___
AK_OB 110 (2 analog outputs)											___ pcs. á 0 VA = 0
											1 pcs. á 8 VA = 8
											Sum =
											Sum = max. 32 VA

The example: None of the 3 limitations are exceeded => OK

8 Length

If you use many extension modules the controller's length will grow accordingly. The row of modules is a complete unit which cannot be broken.

If the row becomes longer than desired, the row can be broken by using AK-CM 102.

The module dimension is 72 mm.

Modules in the 100-series consist of one module

Modules in the 200-series consist of two modules

The controller consist of three modules

The length of an aggregate unit = $n \times 72 + 8$

or in an other way:

Module	Type	Number	at	Length
Controller module		1	x 224	= 224 mm
Extension module	200-series	–	x 144	= ___ mm
Extension module	100-series	–	x 72	= ___ mm
Total length				= ___ mm

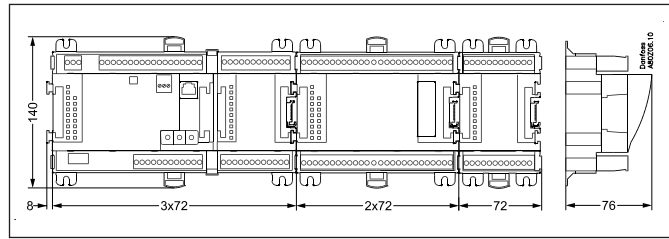

Example continued:

Controller module + 2 extension modules in 200-series + 2 extension module in 100 series =

$224 + 144 + 144 + 72 + 72 = 656$ mm.

9 Linking of modules

Start with the controller module and then mount the selected extension modules. The sequence is of no importance.

However, you must **not** change the sequence, i.e. rearrange the modules, after you have made the setup where the controller is told which connections are found on which modules and on which terminals.

The modules are attached to one another and kept together by a connection which at the same time transmits the supply voltage and the internal data communication to the next module.

Mounting and removal must always be performed when there is no voltage.

The protective cap mounted on the controller's plug connection must be moved to the last vacant plug connection so that the plug will be protected against short-circuit and dirt.

When the regulation has started the controller will all the time check whether there is connection to the connected modules. This status can be followed by the light-emitting diode.

When the two catches for the DIN rail mounting are in open position the module can be pushed into place on the DIN rail – no matter where in the row the module is found. Removal is likewise carried out with the two catches in the open position.

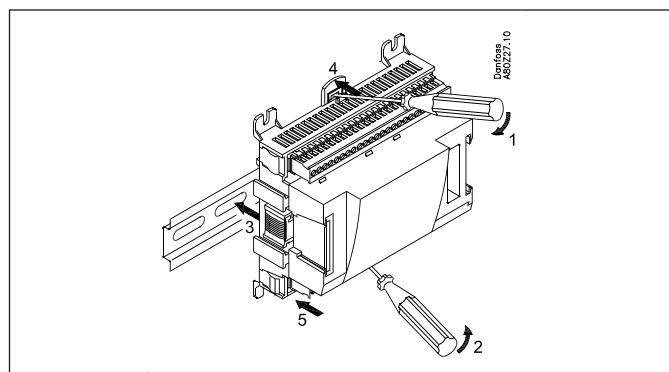
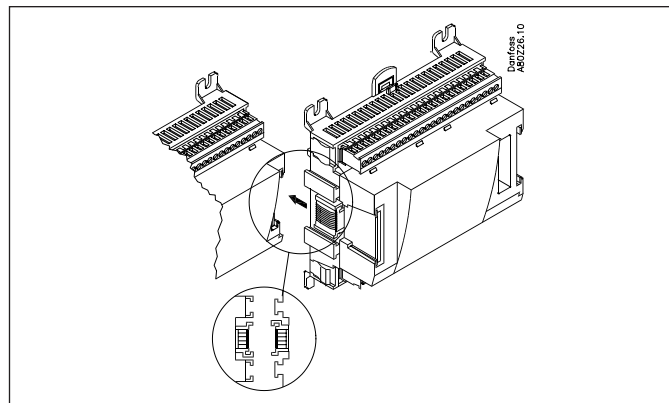
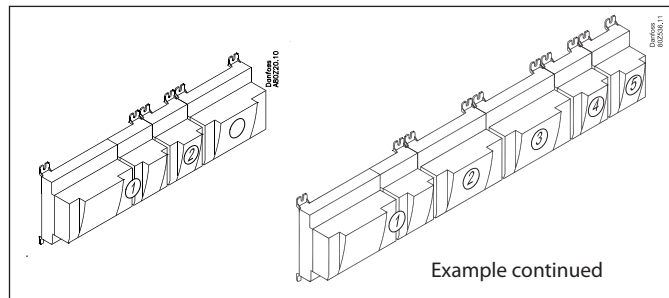

10 Determine the connection points

All connections must be programmed with module and point, so in principle it does not matter where the connections are made, as long as it takes place on a correct type of input or output.

- The controller is the first module, the next one is 2, etc.
- A point is the two or three terminals belonging to an input or output (e.g. two terminals for a sensor and three terminals for a relay).

The preparation of the connection diagram and the subsequent programming (configuration) should take place at the present time. It is most easily accomplished by filling in the connection survey for the relevant modules.

Principle:

Name	On module	On Point	Function
fx Compressor 1	x	x	Close
fx Compressor 2	x	x	Close
fx Alarm relay	x	x	NC
fx Main switch	x	x	Close
fx PO	x	x	AKS 32R 1-6 bar

The connection survey from the controller and any extension modules are uploaded from the paragraph "Module survey. E.g. controller module:

Signal	Modul	Punkt	Klemme	Signal type / Aktive ved
		1 (AI 1)	1 - 2	
		2 (AI 2)	3 - 4	
		3 (AI 3)	5 - 6	

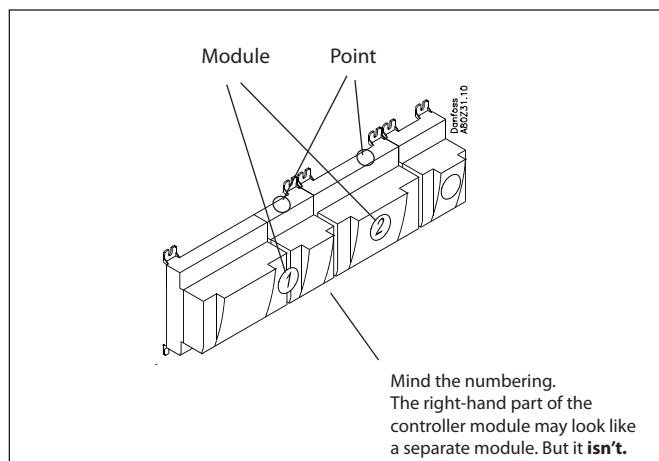

Note
The safety relays should not be fitted onto a module with override changeovers, as they can be put out of operation by an incorrect setting.

- Columns 1, 2, 3 and 5 are used for the programming.
- Columns 2 and 4 are used for the connection diagram.

Example continued

Signal	Module	Point	Terminal	Signal type / Active at
Discharge temperature - Sd	1	1 (AI 1)	1 - 2	Pt 1000
Suction gas temperature- Ss		2 (AI 2)	3 - 4	Pt 1000
Outdoor temperature - Sc3		3 (AI 3)	5 - 6	Pt 1000
External compressor stop		4 (AI 4)	7 - 8	Closed
Thermostat sensor in plant room - Saux1		5 (AI 5)	9 - 10	Pt 1000
Suction pressure - Po		6 (AI 6)	11 - 12	AKS 2050-59
Condensing pressure - Pc		7 (AI 7)	13 - 14	AKS 2050-159
Level switch, oil, comp.1		8 (AI 8)	19 - 20	Closed
Level switch, oil, comp.2		9 (AI 9)	21 - 22	Closed
Level switch, oil, comp.3		10 (AI 10)	23 - 24	Closed
Level switch, oil, comp.4		11 (AI 11)	25 - 26	Closed
Solenoid valve, oil , comp. 1		12 (DO 1)	31 - 32	ON
Solenoid valve, oil , comp. 2		13 (DO 2)	33 - 34	ON
Solenoid valve, oil , comp. 3		14 (DO 3)	35 - 36	ON
Solenoid valve, oil , comp. 4		15 (DO 4)	37 - 38	ON
Solenoid valve, oil, Separator		16 (DO 5)	39 - 40 - 41	ON
Circulation pump tw		17 (DO6)	42 - 43 - 44	ON
Circulation pump hr		18 (DO7)	45 - 46 - 47	ON
Room fan		19 (DO8)	48 - 49 - 50	ON
Voltage signal to high pressure valve, ICMTS		24	-	0-10 V
		25	-	

Signal	Module	Point	Terminal	Signal type / Active at
Level switch, oil, receiver High	2	1 (AI 1)	1 - 2	Closed
Level switch, oil, receiver Low		2 (AI 2)	3 - 4	Closed
Level switch, oil, Separator		3 (AI 3)	5 - 6	Closed
Level switch, CO2 receiver		4 (AI 4)	7 - 8	Open
Pulse reset of stopped compressor		5 (AI 5)	13 - 14	Pulse
		6 (AI 6)	15 - 16	
Refrigerant receiver, Prec CO2		7 (AI 7)	17 - 18	AKS 2050-159
Oil receiver, Prec Oil		8 (AI 8)	19 - 20	AKS 2050-159
Compressor 1		9 (DO 1)	25 - 26 - 27	ON
Compressor 2		10 (DO 2)	28 - 29 - 30	ON
Compressor 3		11 (DO 3)	31 - 32 - 33	ON
Compressor 4		12 (DO 4)	34 - 35 - 36	ON
Start /stop of VLT for fans		13 (DO 5)	37 - 38 - 39	ON
3-way valve, tap water, V3tw		14 (DO6)	40 - 41 - 42	ON
3-way valve, heat circuit, V3hr		15 (DO7)	43 - 44 - 45	ON
3-way valve, gas cooler, V3gc		16 (DO8)	46 - 47 - 48	ON

Signal	Module	Point/Step	Terminal	Signal type
Tap water temperature - Stw2	3	1 (AI 1)	1 - 2	Pt 1000
Tap water temperature - Stw3		2 (AI 2)	3 - 4	Pt 1000
Tap water temperature - Stw4		3 (AI 3)	5 - 6	Pt 1000
Tap water temperature - Stw8		4 (AI 4)	7 - 8	Pt 1000
Heat reclaim temperature Shr2		5 (AI 5)	9 - 10	Pt 1000
Heat reclaim temperature Shr3		6 (AI 6)	11 - 12	Pt 1000
Heat reclaim temperature Shr4		7 (AI 7)	13 - 14	Pt 1000
Heat reclaim temperature Shr8		8 (AI 8)	15 - 16	Pt 1000
Stepper signal to by-pass valve, CCMT		9 (step1)	25 - 26 - 27 - 28	CCM (ETS)
		10 (step 2)	29 - 30 - 31 - 32	
		11 (step 3)	33 - 34 - 35 - 36	
		12 (step 4)	37 - 38 - 39 - 40	

Continued next page

Signal	Module	Point	Terminal	Active at
Compressor 1 Gen. Safety	4	1 (DI 1)	1 - 2	Open
Compressor 2 Gen. Safety		2 (DI 2)	3 - 4	Open
Compressor 3 Gen. Safety		3 (DI 3)	5 - 6	Open
Compressor 4 Gen. Safety		4 (DI 4)	7 - 8	Open
Start/stop heat recovery hr		5 (DI 5)	9 - 10	Closed
All compressors common safety		6 (DI 6)	11 - 12	Open
Flow switch FS _{tw}		7 (DI 7)	13 - 14	Open
Flow switch FS _{hr}		8 (DI 8)	15 - 16	Open

Signal	Module	Point	Terminal	Signal type
Temp. gas cooler outlet Sgc	5	1 (AI 1)	1 - 2	Pt 1000
Temp. by-passed gas Shp		2 (AI 2)	3 - 4	Pt 1000
Start/stop heat recovery tw		3 (AI 3)	5 - 6	Closed
Gas cooler pressure Pgc		4 (AI 4)	7 - 8	AKS 2050-159
Speed control, compressor		5 (AO 1)	9 - 10	0 - 10 V
Speed control, gas cooler fan		6 (AO 2)	11 - 12	0 - 10 V
Speed control, pump - tw		7 (AO 3)	13 - 14	0 - 10 V
Speed control, pump - hr		8 (AO 4)	15 - 16	0 - 10 V

11

Connection diagram

Drawings of the individual modules may be ordered from Danfoss.
Format = dwg and dxf.

You may then yourself write the module number in the circle and draw the individual connections.

The supply voltage for the pressure transmitter should be taken from the same module that receives the pressure signal.

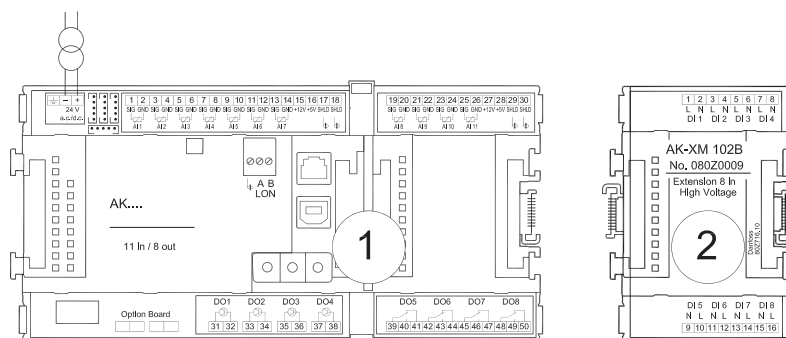

Example continued:

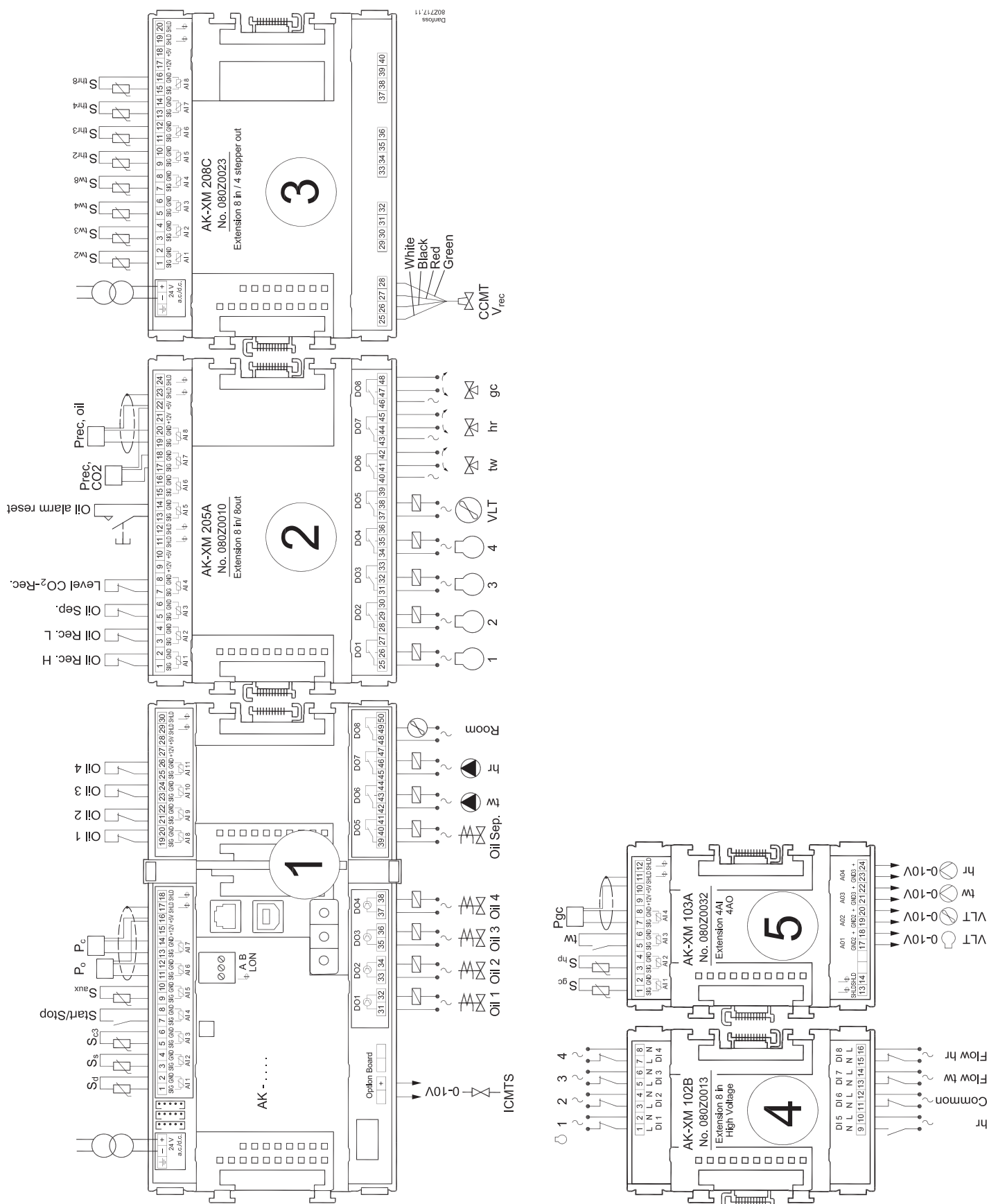

12 Supply voltage

Supply voltage is only connected to the controller module. The supply to the other modules is transmitted via the plug between the modules.

The supply must be 24 V +/-20%. One power supply must be used for each controller. The power supply must be a class II.

The 24 V must not be shared by other controllers or units. The analog inputs and outputs are **not** galvanically separated from the supply.

The + and – 24V input must **not** be earthed.

If using stepper motor valves, the supply for these must be provided from a separate power supply.

For CO₂ facilities, it will also be necessary to safeguard the voltage to the controller and valves using UPS.

Power supply size

The power consumption grows with the number of modules used:

Module	Type	Number	á	Effect
Controller		1	x 8 =	8 VA
Extension module	200 series	_	x 5 =	_ VA
Extension module	100 series	_	x 2 =	_ VA
Total				_ VA

Common pressure transmitter

If several controllers receive a signal from the same pressure transmitter, the supply to the affected controllers must be wired so that it is not possible to switch off one of the controllers without also switching off the others. (If one controller is switched off, the signal will be pulled down, and all the other controllers will receive a signal which is too low)

Example continued:

Controller module	8 VA
+ 2 extension modules in 200 series	10 VA
+ 2 extension modules in 100 series	4 VA

Power supply size (least)	22 VA

Ordering

1. Controller

Type	Function	Application	Language	Code no.	Example continued
AK-PC 781A	Controller for capacity control of compressors and condensers. With oil management	Compressor / condenser / both	English, German, French, Dutch, Italian, Spanish, Portuguese, Danish, Finnish, Russian, Czech, Polish, Chinese	080Z0191	x

2. Extension modules and survey for inputs and outputs

Type	Analog inputs	On/Off outputs		On/off supply voltage (DI signal)		Analog outputs	Stepper outputs	Module with switches	Code no.	Example continued
	For sensors, pressure transmitters etc.	Relay (SPDT)	Solid state	Low voltage (max. 80 V)	High voltage (max. 260 V)	0-10 V d.c.	For valves with step control	For override of relay outputs	With screw terminals	
Controller	11	4	4	-	-	-		-	-	
Extension modules										
AK-XM 101A	8								080Z0007	
AK-XM 102A				8					080Z0008	
AK-XM 102B					8				080Z0013	x
AK-XM 103A	4					4			080Z0032	x
AK-XM 204A		8							080Z0011	
AK-XM 204B		8						x	080Z0018	
AK-XM 205A	8	8							080Z0010	x
AK-XM 205B	8	8						x	080Z0017	
AK-XM 208C	8						4		080Z0023	x
The following extension module can be placed on the PC board in the controller module. There is only room for one module.										
AK-OB 110						2			080Z0251	x

3. AK operation and accessories

Type	Function	Application	Code no.	Example continued
Operation				
AK-ST 500	Software for operation of AK controllers	AK-operation	080Z0161	x
-	Cable between PC and AK controller	USB A-B (standard IT cable)	-	x
Accessories Power supply module 230 V / 115 V to 24 V d.c.				
AK-PS 075	18 VA	Supply for controller	080Z0053	
AK-PS 150	36 VA		080Z0054	x
AK-PS 250	60 VA		080Z0055	
Accessories External display that can be connected to the controller module. For showing, say, the suction pressure				
EKA 163B	Display		084B8574	
EKA 164B	Display with operation buttons		084B8575	
EKA 166	Display with operation buttons and LED's		084B8578	
MMIGRS2	Graphic display with operation		080G0294	
-	Cable between EKA display and controller	Length = 2 m	084B7298	
-		Length = 6 m	084B7299	
-	Cable between graphic display type MMIGRS2 and controller (controller with RJ11 plug)	Length = 1.5 m	080G0075	
-		Length = 3 m	080G0076	
Accessories Communication modules for controllers where modules cannot be connected continuously				
AK-CM 102	Communication module	Data communication for external extension modules	080Z0064	

3. Mounting and wiring

This section describes how the controller:

- Is fitted
- Is connected

We have decided to work on the basis of the example we went through previously, i.e. the following modules:

- AK-PC 781A controller module
- AK-XM 205A input and output module
- AK-XM 208C analog input module + stepper output module
- AK-XM 102B digital input module
- AK-XM 103B analog input and output module
- AK-OB 110 analog output module

Mounting

Mounting of analog output module

1. Lift the top part off the basic module

The basic module must not be connected to voltage.

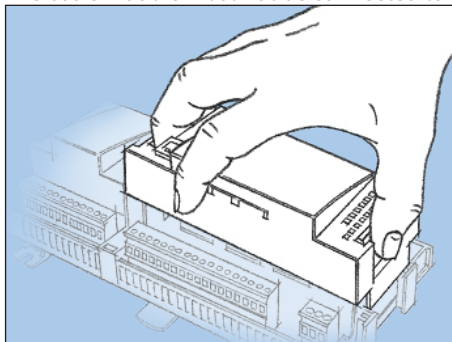

Press in the plate on the left-hand side of the light-emitting diodes and the plate on the right-hand side for the red address changers.

Lift the top part off the basic module.

2. Mount the extension module in the basic module

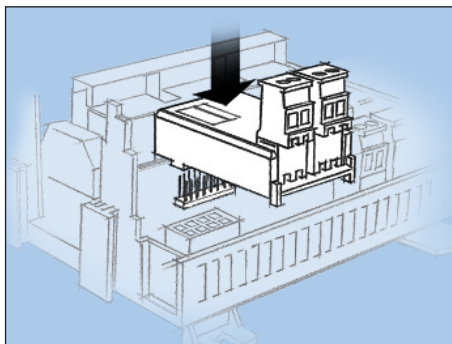

3. Put the top part back on the basic module

The analog extension module will supply a signal to the ICMTS valve

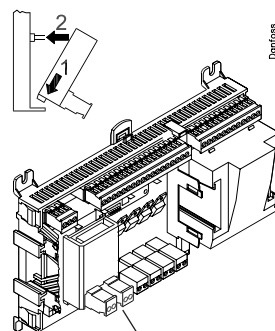

There are two outputs.

Mounting of extension module on the basic module

1. Move the protective cap

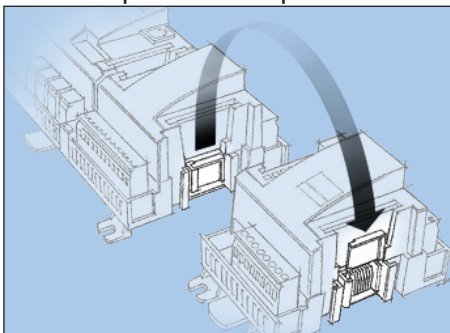

Remove the protective cap from the connection plug on the right-hand side of the basic module.
Place the cap on the connection plug to the right of the extension module that is to be mounted on the extreme right-hand side of the AK assembly.

2. Assemble the extension module and the basic module

The basic module must not be connected to voltage.

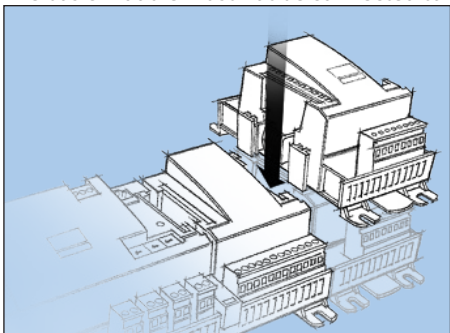

In our example four extension modules are to be fitted to the basic module. We have chosen to fit the module with relays directly on the basic module and then the following module. The sequence is thus:

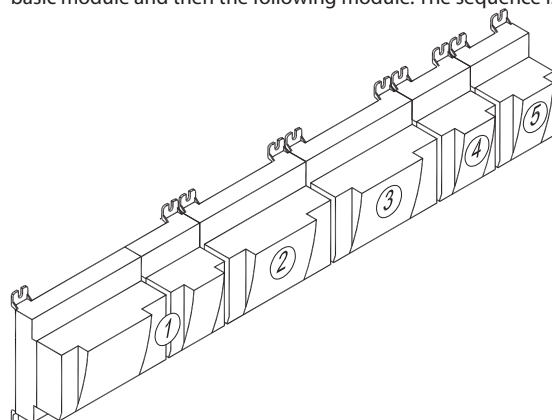

Danfoss
802536,1,1

All the subsequent settings that affect the four extension modules are determined by this sequence.

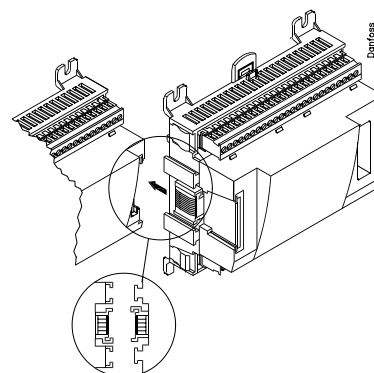

Danfoss
802536,1,0

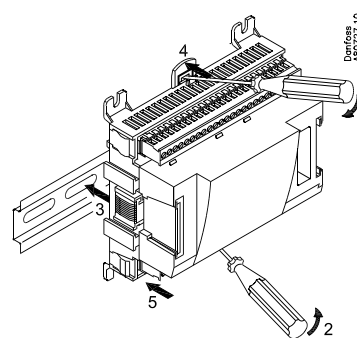

Danfoss
80227,1,0

When the two snap catches for the DIN rail mounting are in the open position, the module can be pushed into place on the DIN rail – regardless of where the module is on the row.
Disassembly is thus done with the two snap catches in the open position.

Wiring

Decide during planning which function is to be connected and where this will be.

1. Connect inputs and outputs

Here are the tables for the example:

Signal	Module	Point	Terminal	Signal type / Active at
Discharge gas temperature - Sd	1	1 (AI 1)	1 - 2	Pt 1000
Suction gas temperature - Ss		2 (AI 2)	3 - 4	Pt 1000
Outdoor temperature - Sc3		3 (AI 3)	5 - 6	Pt 1000
External compressor stop		4 (AI 4)	7 - 8	closed
Thermostat sensor in plant room - Saux1		5 (AI 5)	9 - 10	Pt 1000
Suction pressure - P0		6 (AI 6)	11 - 12	AKS 2050-59
Condenser pressure - Pc		7 (AI 7)	13 - 14	AKS 2050-159
Level switch, oil, comp. 1		8 (AI 8)	19 - 20	closed
Level switch, oil, comp. 2		9 (AI 9)	21 - 22	closed
Level switch, oil, comp. 3		10 (AI 10)	23 - 24	closed
Level switch, oil, comp. 4		11 (AI 11)	25 - 26	closed
Solenoid valve, oil, Comp. 1		12 (DO 1)	31 - 32	ON
Solenoid valve, oil, Comp. 2		13 (DO 2)	33 - 34	ON
Solenoid valve, oil, Comp. 3		14 (DO 3)	35 - 36	ON
Solenoid valve, oil, Comp. 4		15 (DO 4)	37 - 38	ON
Solenoid valve, oil, Separator		16 (DO 5)	39 - 40 - 41	ON
Circulation pump tw		17 (DO6)	42 - 43 - 44	ON
Circulation pump hr		18 (DO7)	45 - 46 - 47	ON
Room fan		19 (DO8)	48 - 49 - 50	ON
Voltage signal to high pressure valve, ICMTS		24	-	0-10 V
	25	-		

Remember the isolation amplifier

If signals are received from different controls, e.g. heat recovery for one of the inputs, a galvanically insulated module should be inserted.

The function of the switch functions can be seen in the last column.

There are pressure transmitters AKS 32R and AKS 2050 available for several pressure ranges. Here there are two different ones. One up to 59 bar and two up to 159 bar.

Signal	Module	Point	Terminal	Signal type / Active at
Level switch, oil, receiver High	2	1 (AI 1)	1 - 2	closed
Level switch, oil, receiver Low		2 (AI 2)	3 - 4	closed
Level switch, oil, Separator		3 (AI 3)	5 - 6	closed
Level switch, CO2 receiver		4 (AI 4)	7 - 8	Open
Pulse reset of stopped compressor		5 (AI 5)	13 - 14	Pulse
		6 (AI 6)	15 - 16	
Refrigerant, receiver, Prec CO2		7 (AI 7)	17 - 18	AKS 2050-159
Oil receiver, Prec Oil		8 (AI 8)	19 - 20	AKS 2050-159
Compressor 1		9 (DO 1)	25 - 26 - 27	ON
Compressor 2		10 (DO 2)	28 - 29 - 30	ON
Compressor 3		11 (DO 3)	31 - 32 - 33	ON
Compressor 4		12 (DO 4)	34 - 35 - 36	ON
Start /stop of VLT to fans		13 (DO 5)	37 - 38 - 39	ON
3-way valve, tap water, V3tw		14 (DO6)	40 - 41 - 42	ON
3-way valve, heat circuit, V3hr		15 (DO7)	43 - 44 - 45	ON
3-way valve, gas cooler, V3gc		16 (DO8)	46 - 47 - 48	ON

Signal	Module	Point	Terminal	Active at
Compressor 1 Gen. safety	4	1 (DI 1)	1 - 2	Open
Compressor 2 Gen. safety		2 (DI 2)	3 - 4	Open
Compressor 3 Gen. safety		3 (DI 3)	5 - 6	Open
Compressor 4 Gen. safety		4 (DI 4)	7 - 8	Open
Start/stop heat recovery hr		5 (DI 5)	9 - 10	closed
All comp. common safety		6 (DI 6)	11 - 12	Open
Flow switch FStw		7 (DI 7)	13 - 14	Open
Flow switch FS hr		8 (DI 8)	15 - 16	Open

Signal	Module	Point	Terminal	Signal type
Temp. gas cooler outlet Sgc	5	1 (AI 1)	1 - 2	Pt 1000
Temp. by-passed gas Shp		2 (AI 2)	3 - 4	Pt 1000
Start/stop heat recovery tw		3 (AI 3)	5 - 6	closed
Gas cooler pressure Pgc		4 (AI 4)	7 - 8	AKS 2050-159
Speed control, compressor		5 (AO 1)	9 - 10	0 - 10 V
Speed control, gas cooler fans		6 (AO 2)	11 - 12	0 - 10 V
Speed control, pump - tw		7 (AO 3)	13 - 14	0 - 10 V
Speed control, pump - hr		8 (AO 4)	15 - 16	0 - 10 V

Signal	Module	Point/Step	Terminal	Signal type
Tap water temperature - Stw2	3	1 (AI 1)	1 - 2	Pt 1000
Tap water temperature - Stw3		2 (AI 2)	3 - 4	Pt 1000
Tap water temperature - Stw4		3 (AI 3)	5 - 6	Pt 1000
Tap water temperature - Stw8		4 (AI 4)	7 - 8	Pt 1000
Heat reclaim temperature Shr2		5 (AI 5)	9 - 10	Pt 1000
Heat reclaim temperature Shr3		6 (AI 6)	11 - 12	Pt 1000
Heat reclaim temperature Shr4		7 (AI 7)	13 - 14	Pt 1000
Heat reclaim temperature Shr8		8 (AI 8)	15 - 16	Pt 1000
Stepper signal to by-pass valve, CCMT		9 (step 1)	25 - 26 - 27 - 28	CCMT (ETS)
		10 (step 2)	29 - 30 - 31 - 32	
		11 (step 3)	33 - 34 - 35 - 36	
		12 (step 4)	37 - 38 - 39 - 40	

The connections for the example can be seen here.

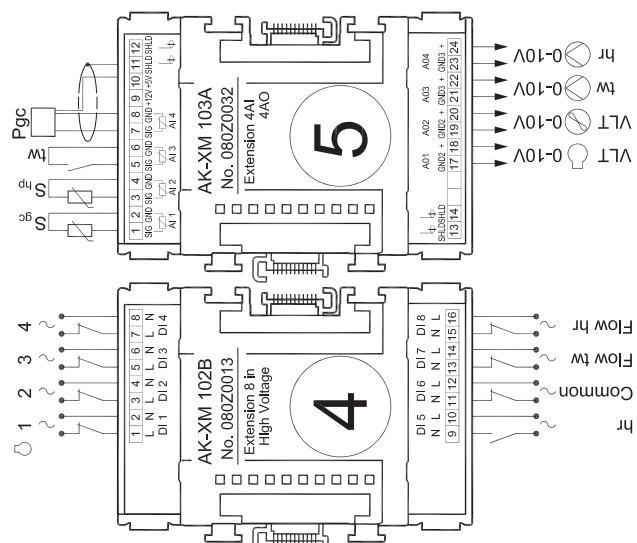
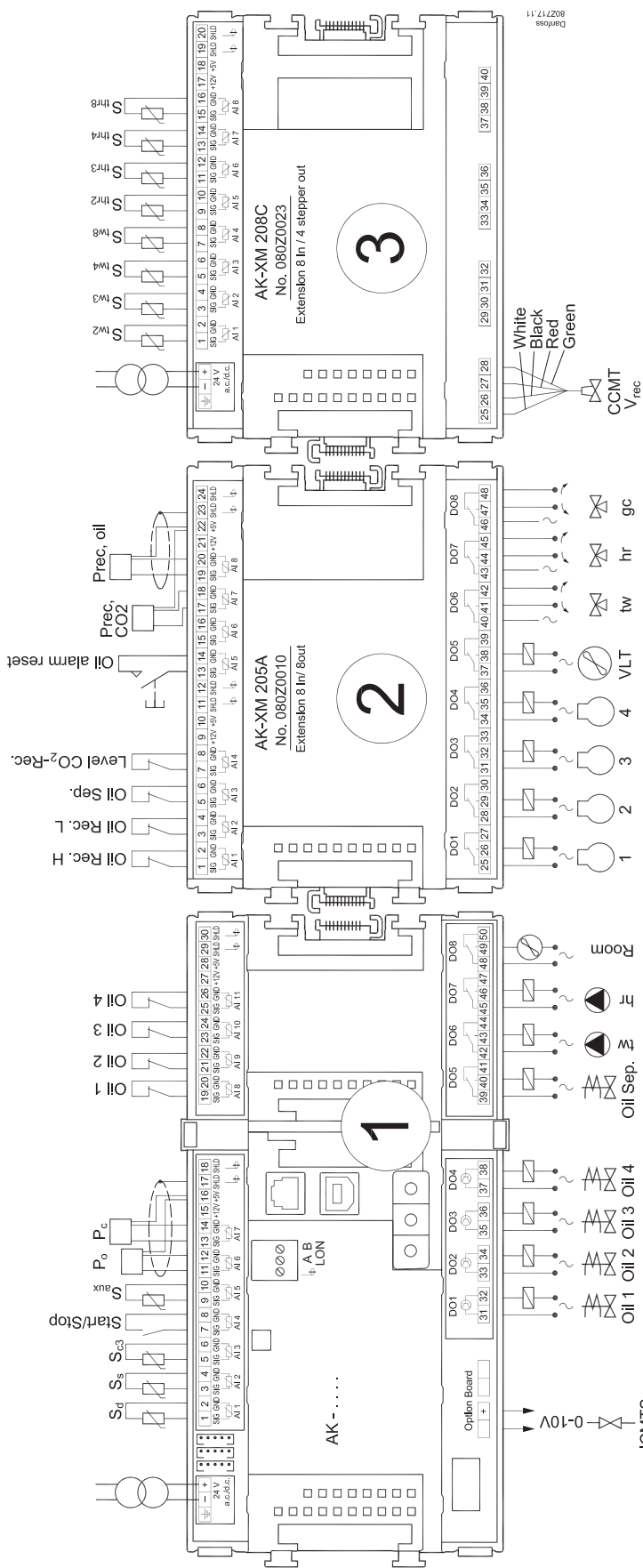

Warning
Keep signal cables separate from cables with high voltage.

The screen on the pressure transmitter cables must only be connected at the end of the controller.

The supply voltage for the pressure transmitter should be taken from the same module that receives the pressure signal.

2. Connect LON communication network

The installation of the data communication must comply with the requirements set out in document RC8AC.

3. Connect supply voltage

Is 24 V, and the supply must not be used by other controllers or devices. The terminals must not be earthed.

4. Follow light-emitting diodes

When the supply voltage is connected the controller will go through an internal check. The controller will be ready in just under one minute when the light-emitting diode "Status" starts flashing slowly.

5. When there is a network

Set the address and activate the Service Pin.

6. The controller is now ready to be configured.

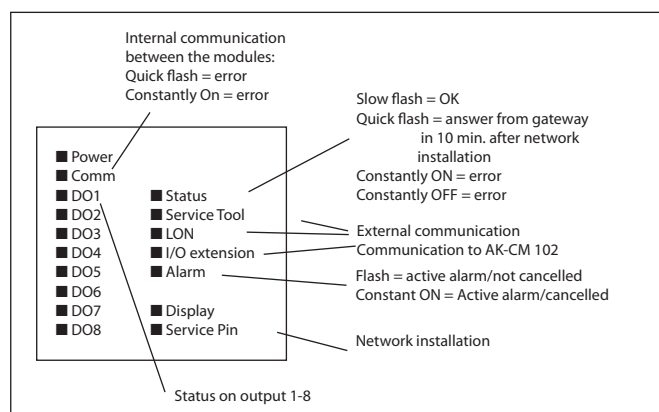

4. Configuration and operation

This section describes how the controller:

- Is configured
- Is operated

We have decided to work on the basis of the example we went through previously, i.e. compressor control with 4 compressors and high pressure control using heat recovery and gas cooler.

The example is shown two pages in.

Configuration

Connect PC

PC with the program "Service Tool" is connected to the controller.

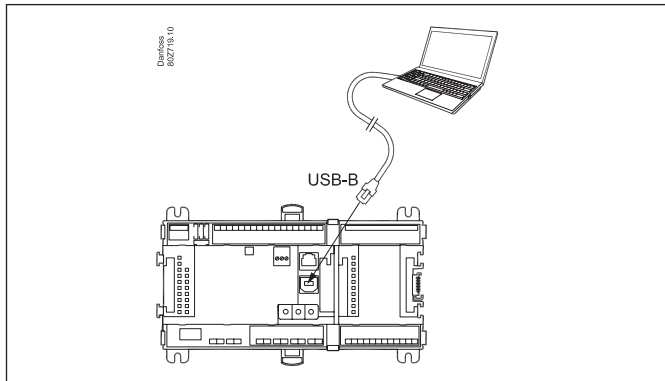

The controller must be switched on first and the LED "Status" must flash before the Service Tool program is started.

Start Service Tool programme

Login with user name SUPV

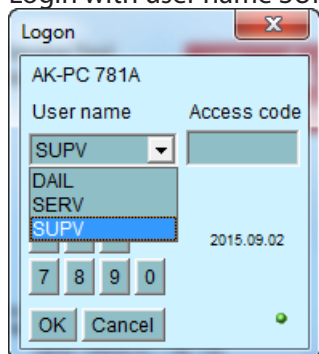

Select the name **SUPV** and key in the access code.

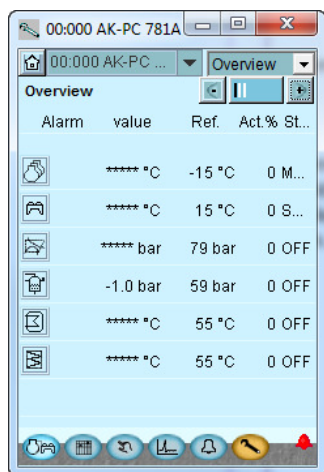

For connecting and operating the "AK service tool" software, please see the manual for the software.

The first time the Service Tool is connected to a new version of a controller the start-up of the Service Tool will take longer than usual while information is retrieved from the controller. Time can be followed on the bar at the bottom of the display.

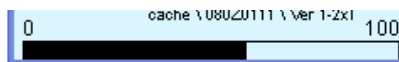

When the controller is supplied the SUPV access code is 123. When you are logged into the controller an overview of it will always appear.

In case the overview is empty. This is because the controller has not yet been set up. The red alarm bell at the bottom right tells you that there is an active alarm in the controller. In our case the alarm is due to the fact that the time in the controller has not yet been set.

Refrigerating plant example

We have decided to describe the setup by means of an example comprising a MT compressor group and a high pressure control. The example is the same as the one given in the "Design" section, i.e. the controller is an AK-PC 781A + extension modules.

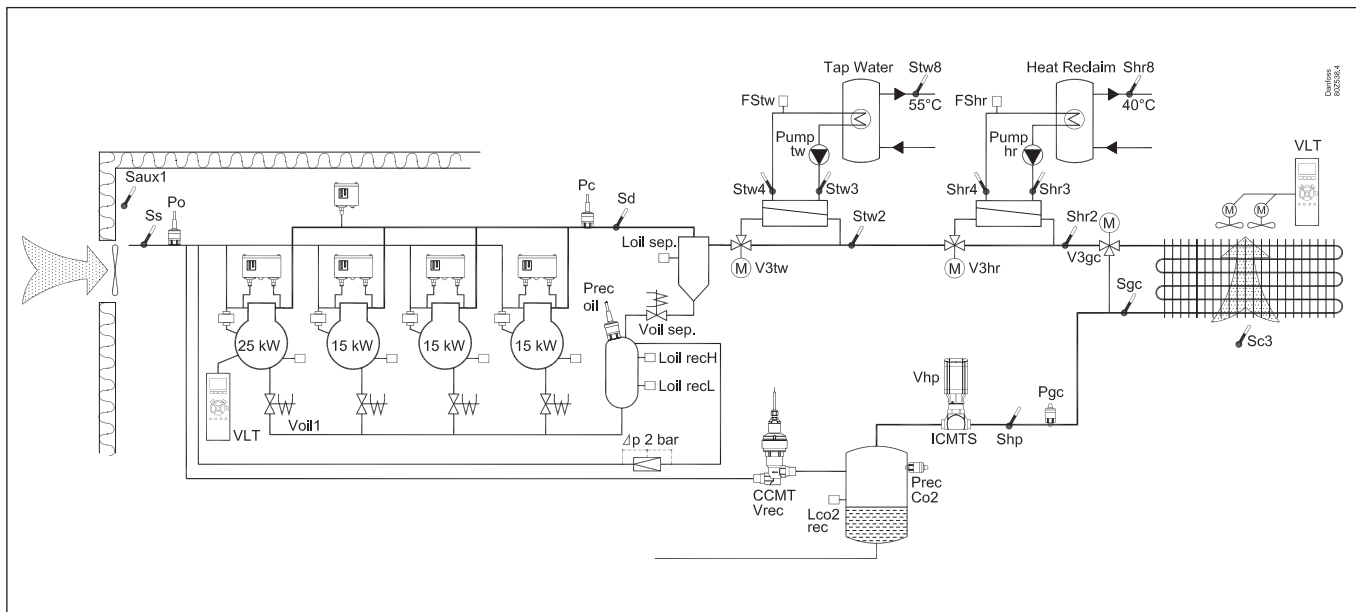

Compressor Group

- MT circuit
- Refrigerant CO₂ (R744)
- Variable compressor and 3 single step compressors
- 4 only compressors with "Best fit"
- Safety monitoring of each compressor
- Common high-pressure monitoring
- Po setting -15°C, night displacement 5 K
- Oil management of each compressor

High pressure control:

- Gas cooler with speed controlled fans (Pgc Max. = 100 bar)
- High pressure control with signal from Sgc and Shp
- Pc regulates floating based on outdoor temperature sensor Sc3
- Control of high pressure valve ICMTS
- Heat recovery for hot tap water. Relay and 0-10 V
- Heat recovery for heating. Relay and 0-10 V

Receivers:

- Monitoring of liquid level of refrigerant
- Control of pressure in refrigerant receiver (reference 34 bar)
- Control of pressure in oil receiver

Fan in plant room

- Thermostat control of fan in engine room

Safety functions:

- Monitoring of Po, Pc, Sd and superheat in suction line
- Po max = -5°C, Po min = -35°C
- Pc max = 103.5 bar
- Sd max = 120°C
- SH min = 5 °C, SH max = 35 °C
- Monitoring of low and high level in oil receiver

Other

- Start/stop of heat recovery tw and hr
- External compressor stop used

There is also an internal main switch as a setting. Both, this and the external compressor stop must be "ON" before any adjustment is made.

Warning

The main switch will stop all regulations, including high-pressure regulation.

Authorization

1. Go to Configuration menu

Press the orange setup button with the spanner at the bottom of the display.



2. Select Authorization

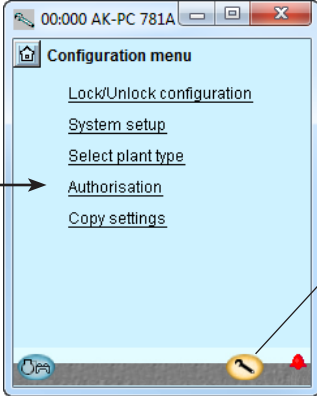

When the controller is supplied it has been set with standard authorization for different user interfaces. This setting should be changed and adapted to the plant. The changes can be made now or later.

You will use this button again and again whenever you want to get to this display. On the left-hand side are all the functions not shown yet. There will be more here the further into the setup we go.

Press the line **Authorisation** to get to the user setup display.

3. Change setting for the user 'SUPV'

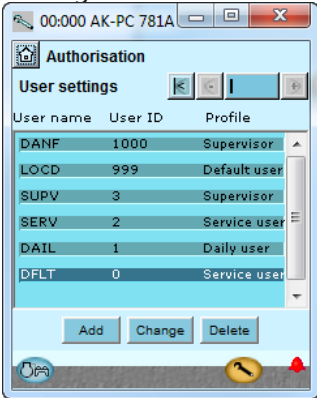

Mark the line with the user name **SUPV**. Press the button **Change**

4. Select user name and access code

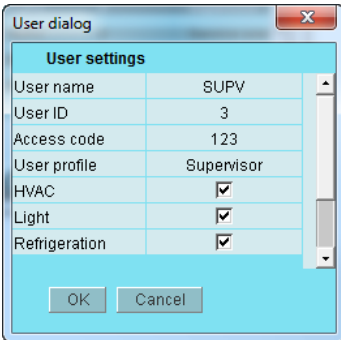

This is where you can select the supervisor for the specific system and a corresponding access code for this person.

The controller will utilize the same language that is selected in the service tool but only if the controller contains this language. If the language is not contained in the controller, the settings and readings will be shown in English.

5. Carry out a new login with the user name and the new access code

To activate the new settings you must carry out a new login to the controller with the new user name and the relevant access code. You will access the login display by pressing the icon at the top left corner of the display.



Unlock the configuration of the controllers

1. Go to Configuration menu



2. Select Lock/Unlock configuration

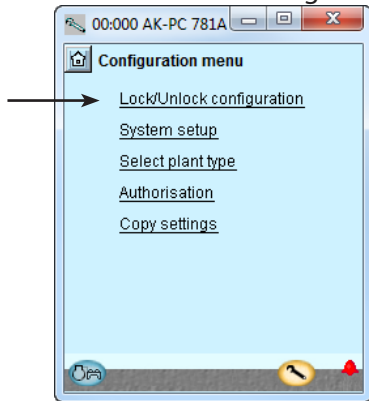

3. Select Configuration lock

Press the blue field with the text **Locked**

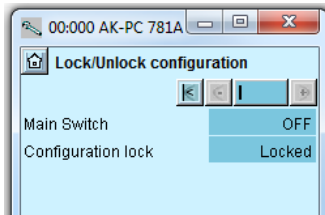

4. Select Unlocked

Select **Unlocked**.

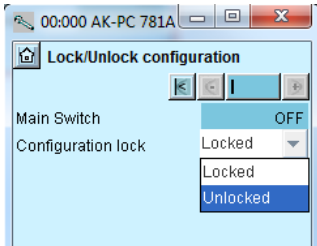

The controller can only be configured when it is unlocked.

The values can be changed when it is locked, but only for those settings that do not affect the configuration.

System setup

1. Go to Configuration menu



2. Select System setup

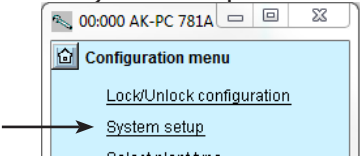

3. Set system settings

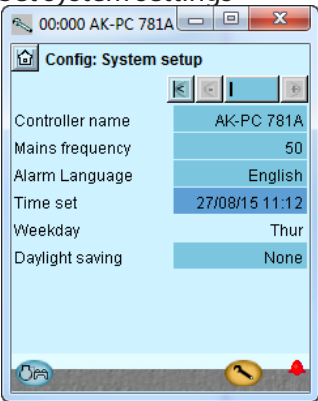

All settings can be changed by pressing in the blue field with the setting and then indicating the value of the required setting.

In the first field you enter a name for what the controller will be controlling. The text written in this field can be viewed at the top of all screens, together with the controller's address.

When the time is set the PC's time can be transferred to the controller. When the controller is connected to a network, date and time will automatically be set by the system unit in the network. This also applies to change-over Daylight saving. Power failure, the clock will be kept running for at least 12 hours.

Set plant type

1. Go to Configuration menu
2. Select plant type

Press the line **Select plant type**.

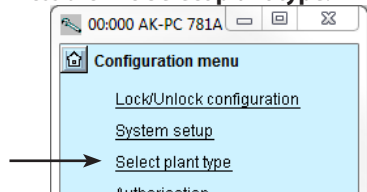

General

If you want to know more about the different configuration options, they are listed in the right column. The number refers to the number and picture in the column on the left.

As the screen only shows the settings and readings that are required for a given setup, all possible settings have also been included in the right column.

Our example

The comments for the example are shown on the following pages, in the middle column.

3 - Plant type

Application selection

Select between "One Suction", "One condenser" or both "One Pack"

4- Plant type continued

Quick setup

New selection

- a. -Co2, LT 1 vsd 1 single
- b. -Co2, LT 1 vsd 1 single Oil
- c. -Co2, MT 1 vsd 3 single vsd fan TW HR
- d. -Co2, MT 1 vsd 3 single vsd fan Oil TW HR
- e. -Hfc, LT 1 vsd 2 single
- f. -Hfc, MT 1 vsd 3 single 4 fan HR
- Factory default

A choice will give a number of predefined combinations, which at the same time determine the connection points.

At the end of the manual there is an overview of the options and connection points.

After configuration of this function, the controller will shut down and restart. After the restart, a large number of settings will have been made. These include the connection points. Continue with the settings and check the values.

If you change some of the settings, the new values will come into force.

Refrigerant

Select refrigerant type

Refrigerant factors K1, K2, K3

Only used if "Po refrigerant type" is set to custom (contact Danfoss for information)

Pack type

MT = Medium temperature. LT = Low temperature. IT = Parallel compression

HP control

High pressure control enabled. To be adjusted later on.

Receiver control

Receiver control enabled. To be adjusted later on.

IT Compressor

Parallel compressor (there are special settings; see the section on page 120).

Heat recovery

Heat recovery enabled. To be adjusted later on.

Oil management

Oil control enabled. To be adjusted later on.

Show advanced settings

This function opens the advanced settings in the various menus.

Show Tc

If selecting "yes" the Pc pressure will also be shown as temperature.

External main switch

A switch may be connected for starting and stopping the regulation. (Also opens UPS selection)

Mon. Ext. Power loss (signal from an UPS)

Monitoring of external voltage. When selecting "yes", a digital input is allocated.

Alarm output

Here you may set whether or not it should be an alarm relay, and which priorities will activate it.

I'm alive relay

A relay will "release" if the regulation is stopped.

Comp. cap. out to AO

If selecting "yes" indicate the current capacity of an output.

5 - Quick relative setup

Easy Pgc max. provides a group setting for the overall pressure values.

Easy Prec ref. provides a group setting for the receiver controller..

3. Set plant type

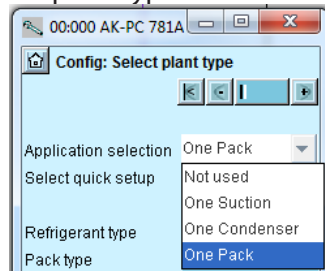

In our example we want the controller to control both a compressor group and a condenser group. We therefore select the plant type **One pack**.

Subsequent options are then available, but only those options allowed by the current selection.

4. Set Common functions

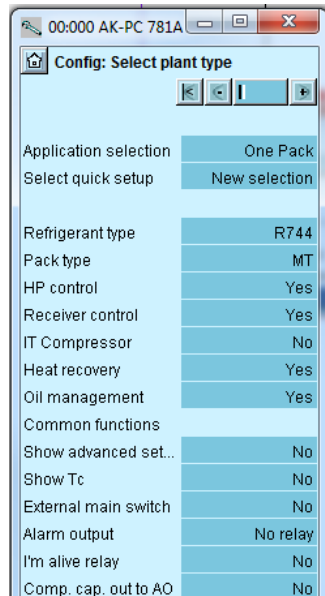

This setting is special.

Here the user can select a pre-defined system. We do not use this function in our example, but perform the adjustments individually.

Select the refrigerant type, here CO₂, further options are made available, etc.

In our example, the cooling (MT) is regulated. (If it was a cascade control/two step system, the other controller would need to be set to "LP".)

The settings for our example can be viewed in the display.

Press the **+**-button to go on to the next page

5. Quick basis setup

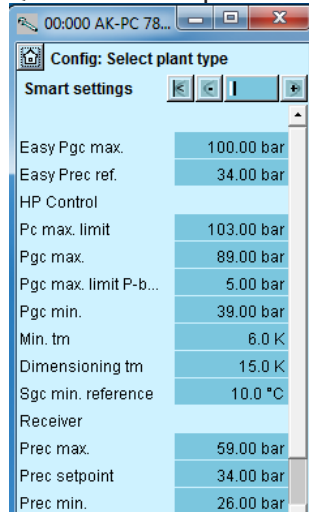

Adjust only the two lines with "Easy"

(Only when the refrigerant selected is CO₂) Here you can adjust the overall values for the system

- Regulation Pgc max
- Regulation Receiver reference.

The controller will then suggest values for all settings connected with this. Fine adjustments can be made if necessary.

Set control of compressors

1. Go to Configuration menu

2. Select Suction group

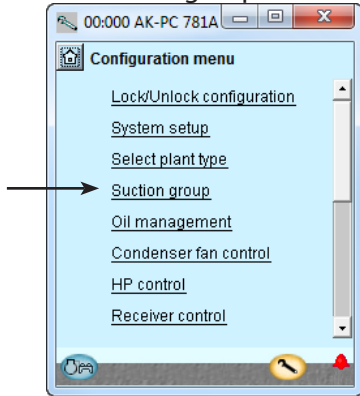

The configuration menu in the Service Tool has changed now. It shows the possible settings for the selected plant type.

3. Set values for the reference

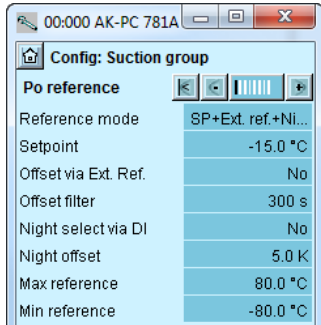

In our example we select the settings:
 - Suction set point = -15°C
 - Night offset value = 5 K.
 The settings are shown here in the display.

Press the +-button to go on to the next page

4. Set values for capacity control

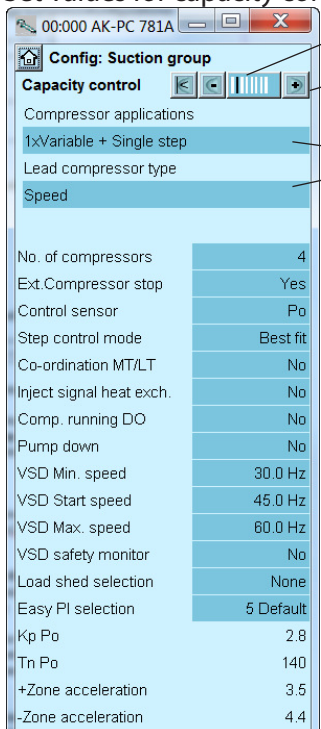

There are several pages, one after the other. The black bar in this field tells you which of the pages is currently displayed. Move between the pages using the + and - buttons.

If a "Variable" or "screw compressor" is chosen in the first line, its type must be determined in the next line.

In our example we select:
 - External compressor stop
 -VSD + single step
 - 4 compressors
 - P0 as signal to the regulation
 - Best fit

3 - Reference mode

Displacement of suction pressure as a function of external signals
 0: Reference = set reference + night offset + offset from external 0-10 V signal

1: Reference = set reference + offset from P0 optimization

Setpoint (-80 to +30°C)

Setting of required suction pressure in °C

Offset via Ext. Ref

Select whether a 0-10V external reference override signal is required

Offset at max input (-100 to +100 °C)

Displacement value at max. signal (10)

Offset at min input (-100 to +100 °C)

Displacement value at min. signal (0 V)

Offset filter (10 - 1800 Sec)

Here you can set how quickly the reference must become effective.

Night Offset via DI

Select whether a digital input is required for activation of night operation. Night operation can alternatively be controlled via internal weekly schedule or via a network signal

Night Offset (-25 to +25 K)

Displacement value for suction pressure in connection with an active night setback signal (set in Kelvin)

Max reference (-50 to +80 °C)

Max. permissible suction pressure reference

Min reference (-80 to +25 °C)

Min. permissible suction pressure reference

4 - Compressor application

Select one of the available compressor configuration here

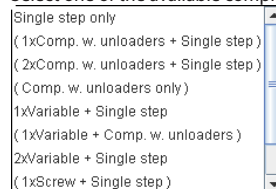

Lead compressor type

• Variable

The following options are available for variable:

- Speed
- Digital Scroll
- Stream4
- Stream6
- CRii4
- CRii6

Screw compressor

The following options are available for screw compressors

- Screw w. 2 steps (1 unl.) OSKA
- Screw w. 3 steps (2 unl.) HSK/HSN/OSKA
- Screw w. 4 steps (3 unl. + PWM) CSH

No. of compressors

Set number of compressors (total)

No. of unloaders

Set number of unloader valves

Ext. compressor stop

An external switch can be connected which will start and stop the compressor control.

Control sensor

Po: Suction pressure Po is used for control

S4: Media temperature S4 is used for control

Pctrl: Control pressure from the low-pressure circuit for cascade

Po refrigerant type

Select refrigerant type

P0 Refrigerant factors K1, K2, K3

Only used if "Po refrigerant type" is set to custom (contact Danfoss for information)

Pctrl refrigerant type

Select refrigerant type

Pctrl refrigerant factors K1, K2, K3

Only used if "Pctrl refrigerant type" is set to custom (contact Danfoss for information)

Step control mode

Select coupling pattern for compressors

Cyclic: Runtime equalisation between compressors (FIFO)

Best fit: Compressors are cut in/out in order to make the best possible fit to actual load

MT/LT coordination

Control methods between cold and frost for cascade.

MT Release: MT-control. The controller must connect to a relay so that a signal can be sent to the controller in the LT circuit.

LT Release:LT-control. The controller must receive a signal from the controller in the MT-circuit.

MT Coord: MT-control. A signal must both be received and sent.

LT Coord: LT-control. A signal must both be received and sent.



Press the + -button to go on to the next page

5. Set values for capacity of the compressors

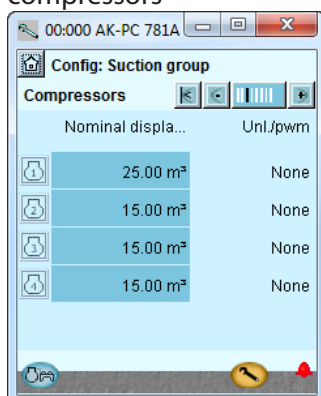

Press the + -button to go on to the next page

6. Set values for main step and any unloaders

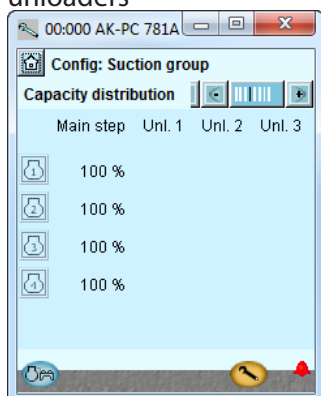

Press the + -button to go on to the next page

7. Set values for safe operation

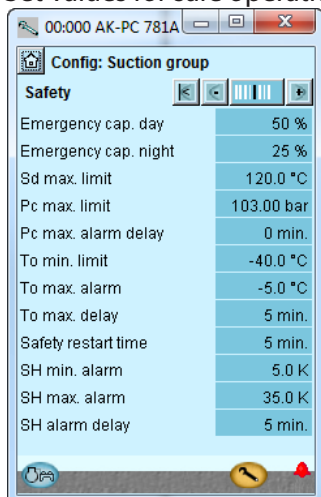

Press the + -button to go on to the next page

The compressor capacity is set in displaced volume per hour. m³/h. See compressor data.

In our example there are no unloaders and hence no changes.

In our example we select:

- Safety limit for discharge temperature = 120°C
- Safety limit for high condensing pressure = 103.5 bar
- Safety limit for low suction pressure = -40°C
- Alarm limit for high suction pressure = -5°C
- Alarm limit for min. and max. superheat, respectively = 5 and 35 K.

MT Coord release before start: LT starts and MT following. A signal must be both received and sent.

LT-Comp.request delay

LT-control. Delay on output signal to MT

LT Comp. release delay

LT-control. Delay on input signal from MT

MT-Comp.request delay

MT-control. Delay on input signal from LT

MT Comp. release delay

MT-control. Delay on output signal to LT

Injection heat exchanger

Selects whether an output signal is to be sent for start/stop of liquid injection in a cascade heat exchanger

Comp. run signal DO

If "yes" is selected, an output is reserved that shows if the compressors are operating.

Pump down

Select whether a pump down function is required on the last running compressor

Synchronous speed

No: There will be two analog outputs available.

Yes: There will be one analog output.

Pump down limit Po (-80 to +30 °C)

Set the actual pump down limit

VSD min speed (0.5 – 60.0 Hz)

Min. speed where the compressor must cutout

VSD start speed (20.0 – 60.0 Hz)

Minimum speed for start of Variable speed drive (Must be set higher than "VSD Min. Speed Hz")

VSD max speed (40.0 – 120.0 Hz)

Highest permissible speed for the compressor motor

VSD safety monitoring

Select this if input for monitoring of the frequency converter is required

PWM period time

Period time for bypass valve (on time + off time)

PWM Min. capacity

Minimum capacity in the period time (without a minimum capacity the compressor will not be cooled)

PWM Start capacity

Minimum capacity at which the compressor will start (must be set to a higher value than "PWM Min. capacity")

Load shed limits

Select which signal is to be used for load limitation (only via network, a DI + network or two DI + network)

Load limitation period

Set the maximum time permitted for load limitation

Load shed limit 1

Set max capacity limit for load shed input 1

Load shed limit 2

Set max capacity limit for load shed input 2

Override limit P0

Any load below the limit value is freely permitted. If the P0 exceeds the value, a time delay is started. If the time delay runs out, the load limit is cancelled

Override delay 1

Max. time for capacity limit, if P0 is too high

Override delay 2

Max. time for capacity limit, if P0 is too high

Easy PI Selection

Group setting for the 4 control parameters: Kp, Tn, + acceleration and - acceleration. If the setting is set to "user defined" the 4 control parameters can be fine-tuned.

Kp Po (0.1 – 10.0)

Amplifications factor for PI regulation

Tn Po

Integration time for PI-regulation

+ Zone acceleration (A')

Higher values result in a faster regulation

- Zone acceleration (A')

Higher values result in a faster adjustment

Advanced settings

Po filter

Reduce changes in the Po reference

Pc filter

Reduce changes in the Pc reference

Initial start time (15 – 900 s)

The time after start-up where the cut-in capacity is limited to the first compressor step.

Unloading mode

Select whether one or two capacity controlled compressors are allowed to be unloaded at the same time at decreasing capacity

AO filter

Absorber changes at the analog output

8. Set monitoring of compressor

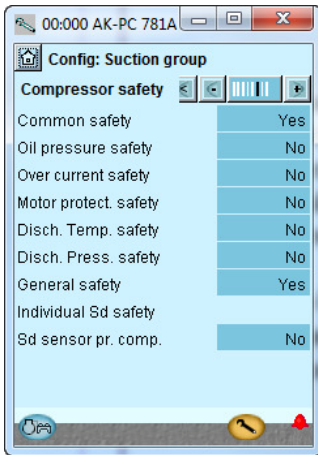

Press the + -button to go on to the next page

9. Set operation time for compressor

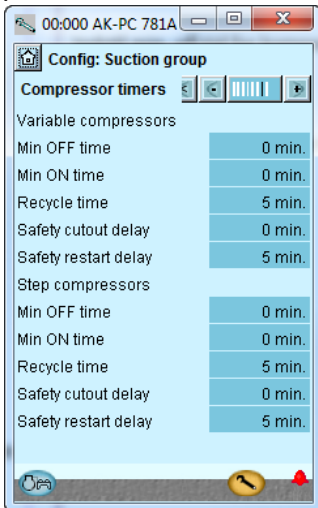

Press the + -button to go on to the next page .

10. Set Misc. functions

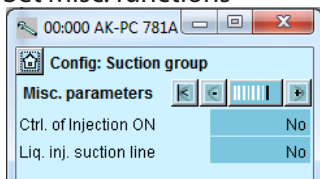

In our example we use:
 - Common high-pressure pressure control for all compressors
 - One general safety monitoring unit for each compressor

(The remaining options could have been selected if specific safety controls for each compressor had been required).

Set min. OFF-time for the compressor relay
 Set min. ON-time for the compressor relay
 Set how often the compressor is allowed to start

The settings only apply to the relay that cuts the compressor motor in and out. They do not apply to unloaders.

If the restrictions overlap, the controller will use the longest restriction time.

In our example we do not use these functions.

AO max. limit

Limit the voltage on the analog output.

5 - Compressors

In this screen the capacity distribution between the compressors is defined.

Capacities that need to be set depend upon the "compressor application" and "Step control mode" that has been selected.

Nominal capacity (0.0 – 1000.0 m³/h)

Set the nominal capacity for the compressor in question.

For compressors with variable speed drive the nominal capacity must be set for the mains frequency (50/60 Hz)

Unloader

Number of unload valves for each compressor (0-3)

6 - Capacity distribution

The installation is dependent on the combination of compressors and coupling pattern.

Main step

Set the nominal capacity of the main step (Set the percentage of the relevant compressor's nominal capacity) 0 - 100%.

Unload

Readout of the capacity on every unloading 0-100%.

7 - Safety

Emergency cap. day

The desired cut-in capacity for daily use in the case of emergency operations resulting from error in the suction pressure sensor/ media temperature sensor.

Emergency cap. night

The desired cut-in capacity for night operations in the case of emergency operations resulting from error in the suction pressure sensor/ media temperature sensor.

Sd max limit

Max. value for discharge gas temperature

10 K below the limit, the compressor capacity should be reduced and the entire condenser capacity will be cutin.

If the limit is exceeded, the entire compressor capacity will be cutout

Pc Max limit

Maximum value for the condenser pressure in °C

3 K below the limit, the entire condenser capacity will be cutin and the compressor capacity reduced.

If the limit is exceeded, the entire compressor capacity will be cutout.

Tc max. limit

Limit value read in °C

Pc Max delay

Time delay for the alarm Pc max

TO Min limit

Minimum value for the suction pressure in °C

If the limit is reduced, the entire compressor capacity will be cutout.

TO Max alarm

Alarm limit for high suction pressure P0

TO Max delay

Time delay before alarm for high suction pressure P0.

Safety restart time

Common time delay before restarting the compressor.

(Applicable to the functions: "Sd max. limit", Pc max. limit" and "P0 min. limit).

SH Min alarm

Alarm limit for min. superheat in suction line.

SH Max alarm

Alarm limit for max. superheat in suction line.

SH alarm delay

Time delay before alarm for min./max. superheat in suction line.

Sd cut out temperature

Set the desired cut-out temperature.

8 - Compressor safety

Common safety

Choose whether an overall, common safety input for all compressors is desired. If the alarm is activated, all compressors will be cutout.

Oil pressure etc

Define here whether this type of protection should be connected.

For "General", there is a signal from each compressor.

Individual Sd pr. compressor

Select whether an Sd measurement should be made for each compressor.

Max discharge temp.

Cutout temperature.

Sd compressor alarm delay

Delay time for the alarm

Sd compressor safety cutout

Set whether safety cut-out should be enabled

9 - Minimum operation times

Configure the operation times here so "unnecessary operation" can be avoided.

Restart time is the time interval between two consecutive starts.

Safety timer

Cutout delay

The time delay resulting from drop-out of automated safety measures and until the compressor-error is reported. This setting is common for all safety inputs for the relevant compressor.

Restart delay

Minimum time that a compressor should be OK after a safety cut-out. After this interval it can start again.

10 - Misc. functions

Injection On

DO: Select this function if a relay must be reserved for the function. (The function must be wired to controllers with expansion valves in order to close liquid injection for the safety cut-out of the last compressor.)

Network: The signal is sent to the controllers via data communication.

Compressor start delay

Delay time for compressor start

Injection Off delay

Delay time for "Injection off"

Liq. inj suction line

Select the function if a liquid injection is required in the suction line in order to keep the discharge gas temperature down.

Regulation can be done either using a solenoid valve and a TEV, or using an AKV valve.

AKV OD suction line

Opening degree of the valve in %

Inject start SH

Superheat value where the liquid injection starts

Inject diff SH

Differential when adjusted for superheat

Inject start Sd temp.

Start temperature for liquid injection in suction line

Inject diff. Sd temp.

Differential when adjusted on Sd

SH Min suction line

Minimum superheat in suction line

SH Max suction line

Maximum superheat in suction line

AKV period time

Period time for AKV valve

Inject delay at start up

Delay time for liquid injection at start-up

SCREW COMPRESSOR CONTROL

Use Economizer

Choose the compressor to control an EVR to an ECO function

Use Liq. injection (individual Sd)

Choose whether to be liquid injection into the compressor at high Sd. Stopped again 20 K below "Max. Discharge "

Output type

Select valve signal to the stepper or analog signal

Max. liquid injection OD

Set max. opening degree of the valve in %

Max. discharge temp

Max Sd temperature by individual Sd measurements.

Set oil management

1. Go to Configuration menu

2. Select Oil management

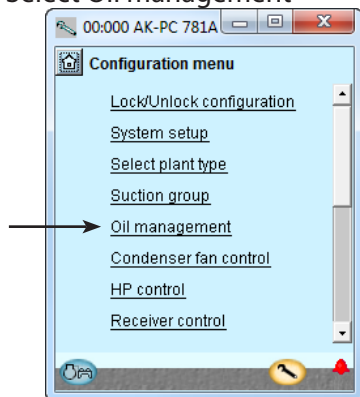

3. Set refrigeration circuit

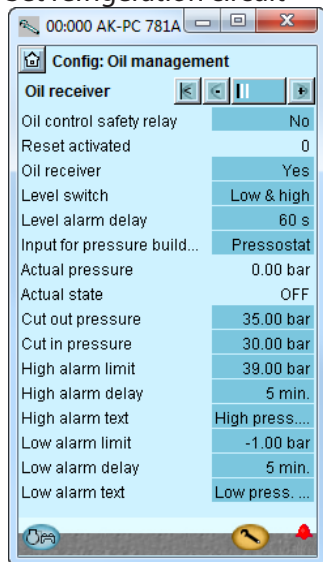

Press the +-button to go on to the next page

We do not use safety relays in our example.

In this example, we want to control the oil receiver. This is done with a pressostat. Here, we have chosen a pressostat. The pressostat should be set as follows:

- Select pressure transmitter
- When the pressure drops in the receiver, the valve should open.
- Set the pressure level at which the valve should open. Set at 35 bar, here.
- Set the pressure level, at which the valve should close completely again. Set at 30 bar, here.

In the example, we have two level switches in the receiver. Both one high and one low.

3

Oil control safety relay

If this setting is set to YES, the controller will reserve a safety relay for each compressor. The relay terminal is connected in series to the compressor relay. The relay can hereby stop the compressor, if a lack of oil is registered when the compressor is force controlled. (Forced controlled to ON with the setting "Manual" or with the "changeover" on an extension module.)

Danfoss recommends this function to avoid any compressor damages due to lack of care.

(In order to keep things simple, this function is not used as an example.)

LT sync to MT

Select this if the controller is on low pressure control and should be synchronised with high pressure regulation.

Oil receiver

Select whether you wish to activate pressure regulation in one of the oil receivers.

Level switch receiver

Define the desired level sensors. High / Both Low and High

Level alarm delay

Delay time for level alarm

Input for pressure build

Select whether the pressure is controlled by a pressostat or signal from the pulse counter.

Comp. per. to start seq.

(For pulse counter): Percentage value of total pulses of the different compressors

Pressure buildup seq.

(For pulse counter) Select between:

Only pulses from the HP circuit. Pulses from both HP and LP are included

Actual pressure

Measured value

Actual state

Status of oil separation

Cut out pressure

Receiver pressure for shutting off oil

Cut in pressure

Receiver pressure for turning on oil

High alarm limit

An alarm is given if a higher pressure is registered

High alarm delay

Time delay for alarm

High alarm text

Write an alarm text

Low alarm limit

An alarm is given if a lower pressure is registered

Low alarm delay

Time delay for alarm

Low alarm text

Write an alarm text

4. Set oil management for the compressors

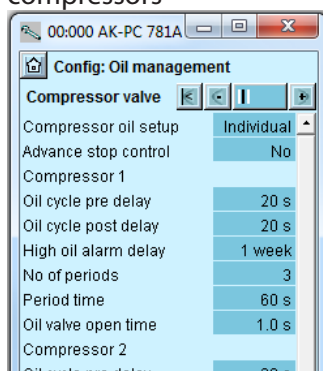

Press the + button to go on to the next page.

5. Set oil separator

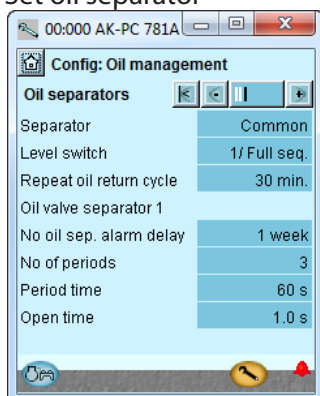

In our example, the oil supply is controlled separately for each individual compressor.

The settings are shown here in the diagram.

The process is as follows:

20 seconds after the signal from the level switch is given, the oil injection starts. This pulsates three times with one minute intervals. Each pulse lasts one second. Then there is a pause for 20 seconds. If the level switch has not registered any oil at this point, the compressor is stopped.

In our example, there is only one single separator that has just one level switch.

The settings are shown here in the diagram.

The process is as follows:

When a signal is given from the level switch, the discharging process to the receiver commences. This pulsates three times with one minute intervals. Each pulse lasts one second. If the level switch does not register an oil drop at this point, an alarm is given when the delay time has expired.

4

Compressor oil setup

Select whether the oil supply to all the compressors is to be shared at the same time or whether each compressor is to be controlled separately.

Advanced stop

'Yes' means pulses will be allowed following compressor stop

Oil cycle pre delay

Delay time before oil pulses commence

Oil cycle post delay

Delay time for signal that will stop oil pulses

High oil alarm delay

If an activation of the level switch is not registered before the time has expired, an alarm will be given. (the compressor not use the oil).

No of periods

No. of pulses that are to be enabled in a oil filling sequence

No of periods before stop (Advanced stop = yes)

If oil is still missing after this number of pulses, the compressor is stopped. The remaining number of pulses will then be permitted.

Period time

Time between pulses

Oil valve open time

The valve's opening time for each pulse.

5

Separator

Select whether there should be one shared separator for all the compressors or one separator for each compressor.

Level detection

Select whether the separator is to be controlled by "Full sequence", "To Level" or "low and high" level switches.

Level alarm delay

Alarm given when using a level switch for low level.

Repeat oil return cycle

Time period between repeat emptying processes from the separator if the level switch stays at high level.

No oil sep. alarm delay

Alarm delay when a signal is given that oil is not being separated ("high" level contact not activated)

No of periods

No. of times the valve should open in emptying sequence

Period time

Time between valve openings.

Open time

The open time of the valve

Setup control of condenser fans

1. Go to Configuration menu

2. Select Condenser fan control

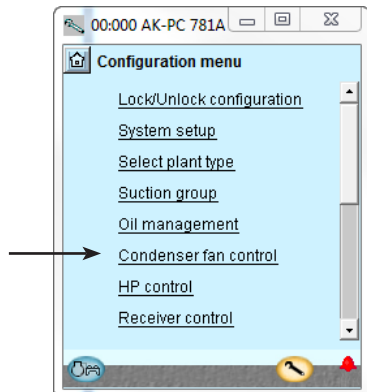

3. Set control mode and reference

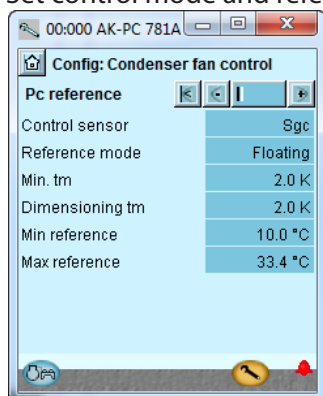

Press the + -button to go on to the next page

4. Set values for capacity regulation

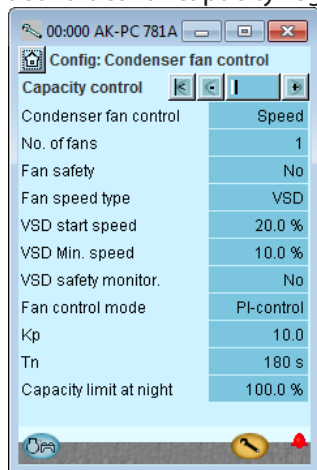

In our example the condenser pressure is controlled on the basis of the Sgc and from Sc3 (floating reference). The settings shown here in the display.

In our example we use a number of fans that are all speed-controlled in parallel. The settings shown here in the display.

For your information the function "Monitor fan safety" will require an input signal from each fan.

3 - PC reference

Control sensor

Pc: The condensing pressure PC is used for regulation
Sgc: The temperature at the outlet of the gas cooler (CO2 transcritical only)

S7: Media temperature is used for regulation

Reference Mode

Choice of condenser pressure reference

Fixed setting: Used if a permanent reference is required = "Setting"

Floating: Used if the reference is changed as a function of Sc3 the external temperature signal, the configured "Dimensioning tm K"/"Minimum tm K" and the actual cut in compressor capacity. (Liquid is recommended for CO2 and heat recovery.)

Setpoint

Setting of desired condensing pressure in bar

Min. tm

Minimum average temperature difference between Sc3 air and Pc condensing temperature with no load.

Dimensioning tm

Dimensioning average temperature differential between Sc3 air and Pc condensing temperature at maximum load (tm difference at max load, typically 8-15 K).

Min reference

Min. permitted condenser pressure reference

Max reference

Max. permitted condenser pressure reference

4 - Capacity control

Capacity control mode

Select control mode for condenser

Step: Fans are step-connected via relay outputs

Step/speed: The fan capacity is controlled via a combination of speed control and step coupling

Speed: The fan capacity is controlled via speed control (frequency converter)

Speed 1.step: First fan speed controlled, rest step coupling

No of fans

Set number of fans.

Monitoring fan safety

Safety monitoring of fans. A digital input is used to monitor each fan.

Fan speed type

VSD (and normal AC motors)

EC motor = DC controlled fan motors

VSD start speed

Minimum speed for start of speed control (Must be configured higher than "VSD Min. Speed %")

VSD min Speed

Minimum speed whereby speed control is cut-out (low load).

VSD safety monit.

Choice of safety monitoring of frequency converter. A digital inlet is used for monitoring the frequency converter.

EC Start capacity

The regulation awaits this need to arise before supplying voltage to the EC motor

EC voltage min

Voltage value at 0% capacity (20% = 2V @ 0-10V)

EC voltage max

Voltage value at 100% capacity (80% = 8V @ 0-10V)

EC Voltage abs. max

Permissible live voltage for EC motor (overcapacity)

Absolut max Tc

Max value for Tc. If this Tc value is exceeded, the EC voltage will be raised to the value in "EC Voltage abs. max." Continues

Continued

Control type

Choice of control strategy

P-band: The fan capacity is regulated via P-band control. The P band is configured as "Proportional band Xp"

PI-Control: The fan capacity is regulated by the PI controller.

Kp

Amplification factor for P/PI controller

Tn

Integration time for PI controller

Capacity limit at night

Setting of maximum capacity limit during night operations. Can be used to limit fan speed at night in order to limit the noise level.

The following settings are not available when the refrigerant selected is CO₂.

Monitor Air flow

Choose whether monitoring is required of the condenser's air flow via an intelligent error-detection method.

Monitoring requires the use of a Sc3 outer temperature sensor, which must be fitted by the condenser's air inlet.

FDD setting

Set error-detection function

Tuning: The controller makes an adjustment to the condenser concerned. Note that tuning should only be done when the condenser is operating under normal operating conditions.

ON: Tuning is completed and monitoring has commenced.

OFF: Monitoring is cut out.

FDD sensitivity

Set the sensitivity of error-detection on the condenser's air flow. Must only be changed by trained staff.

Air flow tuning value

Actual tuning values for air flow.

Setup control of high pressure

1. Go to Configuration menu

2. Select HP control

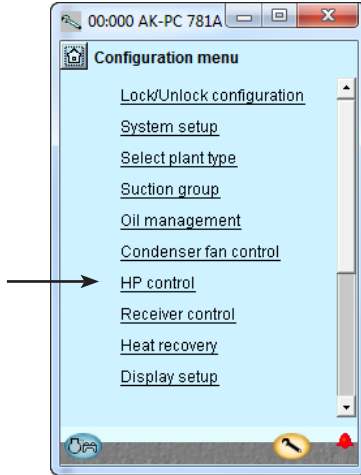

3. Set regulation values

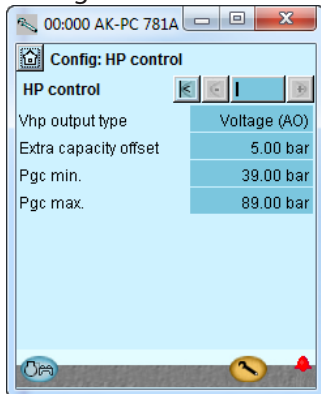

The settings are shown here in the display

3 - HP control

Vhp output type

Select the signal type for controlling the ICMTS valve.

- Voltage signal (ICMTS must have 0-10 V signal)

- Stepper motor signal via AK-XM 208C

- 2 Stepper motor signals for parallel valves

Extra capacity offset

Adjust how much the pressure shall be increased by when the function "Extra capacity offset" is activated.

Pgc min.

Min. acceptable pressure in the gas cooler

Pgc max.

Max. acceptable pressure in the gas cooler

Advanced settings

Pgc max. limit P-band

P-band under "Pgc max" where the valve's degree of opening is increased

dT Subcool

Desired subcooling temperature

Kp

Amplification factor

Tn

Integration time

Valve min. OD

Restriction of the ICMTS valve's degree of closing

Valve max. OD

Restriction of the ICMTS valve's degree of opening

Pgc HR min.

Read the min. acceptable pressure in the high pressure circuit during heat recovery

Pgc HR offset

Read the pressure increase during heat recovery

Ramp down bar/min.

Here you may select how quickly the reference must be changed after a completed heat recovery

Temp. at 100 bar

Temperature at 100 bar. Here you may define the regulation curve during transcritical operation. Set the required temperature value.

V3gc

Indicates whether a gas bypass valve is used on the gas cooler.

Bypass low limit

If the sensor Sgc records a temperature that is lower than the selected value, the gas will be routed outside of the gas cooler (e.g. startup during very low ambient temperatures).

Bypass permitted after

Minimum time during which the gas must be fed through the gas cooler before bypass is permitted.

Warning

If the regulation is stopped during high-pressure regulation, the pressure will rise.

The system must be dimensioned to the higher pressure; otherwise, there will be a loss of charge.

Setup control of receiver pressure

1. Go to Configuration menu

2. Select Receiver control

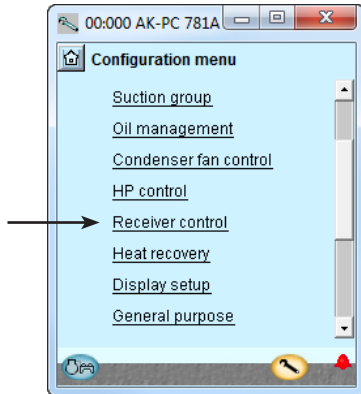

3. Set regulation values

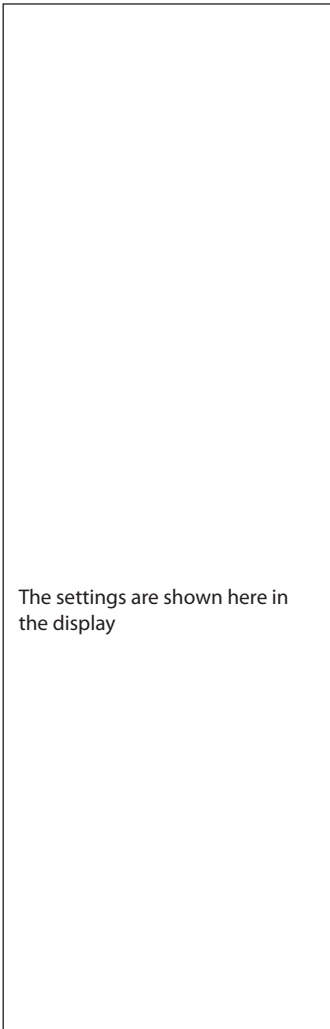
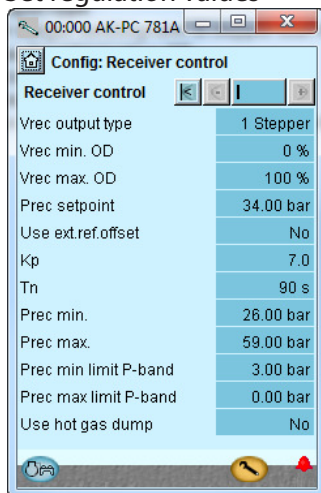

The settings are shown here in the display

3 - Receiver control

Vrec output type

Select the signal type for controlling the gas bypass valve:

- Voltage signal
- Stepper motor signal via AK-XM 208C
- 2 stepper motor signal for parallel valves

Valve min. OD

Limitation of the CCM valve's degree of closing

Valve max. OD

Limitation of the CCM valve's degree of opening.

Prec set point

Select the set point for the pressure in the receiver

Use ext. ref. offset

A 0-10 V signal must displace the temperature reference.

Max. ext. ref. offset

Reference displacement at max. signal (10 V)

Kp

Amplification factor

Tn

Integration time

Prec min.

Min. permissible pressure in the receiver

Prec max.

Max. permissible pressure in the receiver

(Also becomes regulation reference if the compressors are stopped with the "External compressor stop" function)

Prec min. limit P-band

P-band under "Prec min" where the ICMTS valve's degree of opening is increased

Prec max. limit P-band

P-band over "Prec max" where the ICMTS valve's degree of opening is decreased

Use hot gas dump

Select whether hot gas should be supplied if the receiver pressure falls too low

Prec hot gas dump

Receiver pressure at which hot gas is turned on

Prec gas dump diff.

Difference at which hot gas is turned off again

IT comp. state

The signal received from the IT controller can be read here

IT comp. start

Opening degree for the Vrec valve when the IT compressor is to start.

IT comp. delay

The opening degree of the Vrec must be higher during the entire delay time before the relay pulls, thereby sending a signal to the IT controller.

IT comp. Sgc min.

The temperature limit for operation with IT compressor. Will not start when a lower value is detected, regardless of the opening degree of the Vrec valve.

Setup control of heat recovery

1. Go to Configuration menu

2. Select heat recovery

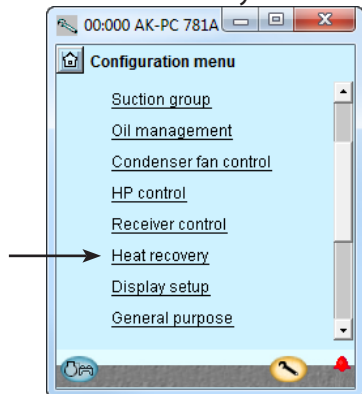

3. Define heat recovery circuits

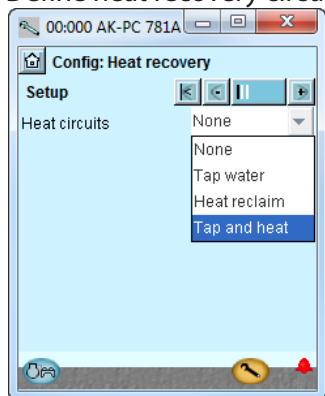

4. Define heat circuit requirement for pressure variation

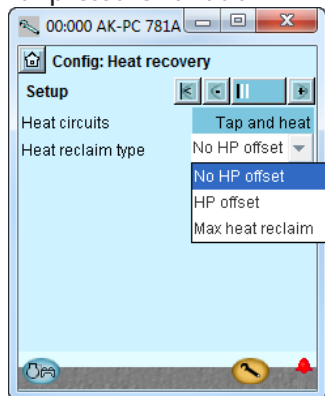

 Press the + -button to go on to the next page

3 - Heat recovery

Heat recovery mode (applies only when the refrigerant selected is not CO₂). See also page 109.

Choice of method for heat recovery

No: Heat recovery not used

Thermostat: Heat recovery operated from thermostat

Digital input: Heat recovery operated from signal on a digital input.

Heat recovery relay

Choose whether an output is required that should be activated during heat recovery.

Heat recovery ref

Reference for the condensing pressure, when heat recovery is activated.

Heat recovery ramp down

Configure how quickly the reference for the condenser pressure should be ramped down to normal level after heat recovery. Configure in Kelvin per minute.

Heat recovery cutout

Temperature value where the thermostat cuts-out the heat recovery.

Heat recovery cutin

Temperature value where the thermostat cuts-out the heat recovery.

HFC

Heat recovery circuit (applies only when the refrigerant selected is CO₂). See also page 112.

Here you select which recovery circuits shall be regulated:

- None
- Circuit for hot tap water
- Circuit for heating
- Both hot tap water and heating

CO₂

In our example, we have selected CO₂ as the refrigerant. This opens for the displayed settings. In our example we have both a circuit for hot tap water and a circuit for heating.

4 - Heat reclaim type for heating

Here you define how the condensing pressure (HP) shall be regulated when the recovery circuit for heating requires heat:

- No HP offset (simple control)
- HP offset. Here the controller must receive a voltage signal. The offset values that apply to the max. value must be defined in the heat circuit settings. See next page.
- Max heat reclaim. Here the controller must receive a voltage signal, but the regulation is increased to also control the pump, fans and gas cooler bypass.

5. Setup values for tap water circuits

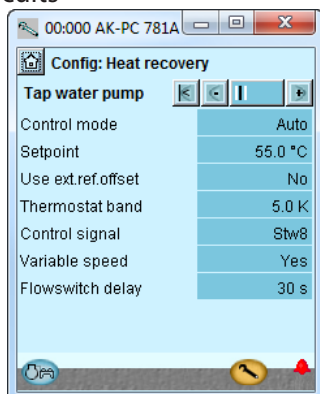

Press the + -button to go on to the next page

6. Setup values for heating circuit

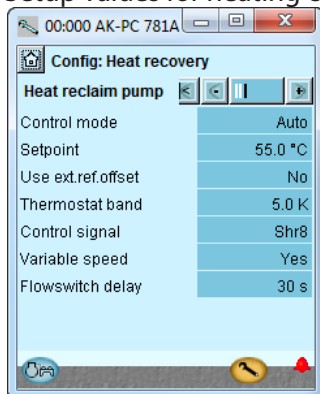

In our example we use the settings shown

In our example we use the settings shown

5 - **Tap water circuits** (settings are available only when the refrigerant selected is CO₂, and shall be regulated on a circuit for tap water).

Control mode: Here the regulation of the circuit can be started (auto) and stopped (off).

Setpoint: The required temperature for the sensor Stw8 can be set here.

Use ext. ref. offset

A 0-10 V signal must displace the temperaturreference.

Max. Ext. ref. offset

Reference displacement at max. signal (10 V)

Thermostat band: The acceptable temperature variation around the reference:

Control signal. . Choose between:

Stw8: if regulation shall be done using only this sensor.

S4-S3: (and a Delta T value) if the controller shall regulate using this temperature difference, until the Stw8 reference is met. (During S4-S3 regulation, the pump must always be speed-regulated).

Stw8 + Stw8A: if two temperature sensors are installed in the hot water receiver.

Stw4: regulation is done using this sensor

Variable speed: Here the pump type is selected. Either variable speed or on/off.

Advanced settings: The following options are made available:

Flow switch: Must normally be selected for safety purposes

Kp: Amplification factor

Tn: Integration time

Min. pump speed: Pump speed for start/stop

Max. pump speed: The pump's max. permissible speed

Flowswitch delay: Duration of stable signal before the new status is used in the regulation.

6 - **Heat reclaim circuits** (settings are available only when the refrigerant chosen is CO₂, and regulation shall be done using a circuit for heating).

Control mode: Here the regulation of the circuit can be started (auto) and stopped (off).

Setpoint: Here the required temperature of sensor Shr8 (or Shr4) is set.

Use ext. ref. offset

A 0-10 V signal must displace the temperaturreference.

Max. Ext. ref. offset

Reference displacement at max. signal (10 V)

Thermostat band: The permissible temperature variation around the reference:

Control signal: Choose between:

Shr8: if regulation shall be done using only this sensor.

S4-S3: (and a Delta T value) if the controller shall regulate using this temperature difference, until the Shr8 reference has been met.

Shr4: regulation is done using this sensor. (During S4-S3 regulation or Shr4 regulation the pump shall always be speed-regulated).

Variable speed: Here the pump type is selected. Either variable speed or on/off.

Heat consumers: (Only when the condensation pressure shall be increased during heat recovery). The number of signals that can be received is set here. The signal can be either 0-10 V or 0-5 V. (Settings under "Advanced" will be used 0-100% for the signal).

Heat consumer filter

The highest of the received signals are made known over this period

Additional heat output

The function will reserve a relay. The relay will pull in when the signal for the heat removers reaches 95%.

Flowswitch delay: Duration of stable signal before the new status is used in the regulation.

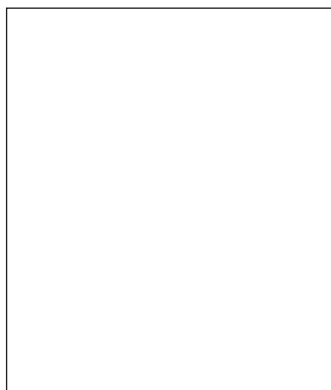

Advanced settings: The following options are made available:

Flow switch: Must normally be selected for safety purposes

Kp: Amplification factor

Tn: Integration time

Tc max HR: Value at which the bypass of the gas cooler will terminate.

HR PUMP CONTROL

Min. pump speed: Pump speed for start/stop

Max. pump speed: The pump's max. permissible speed

Pump stop limit: Signal in % at which the pump is stopped again

Pump start limit: Signal in % at which the pump is started

HP CONTROL

Pgc HR min: Basic reference for the pressure when external voltage signal is received.

Pgc HR offset: Pressure displacement at max. voltage signal

HP low limit: Signal in % at which "Pgc HR min." comes into force.

HP high limit: Signal in % at which "Pgc HR offset" value is used.

FAN CONTROL

Fan - Max Cond. Ref offset: Set the displacement at which the fans shall fully stop.

Fan low limit: Signal in % at which throttling of the fans commences

Fan high limit: Signal in % at which the fans are stopped

BYPASS CONTROL

V3gc bypass stop limit: Signal in % at which the gas cooler connects again after completed disconnect.

V3gc bypass start limit: Signal in % at which the gas cooler is disconnected.

Setup Display

1. Go to Configuration menu

2. Select Display setup

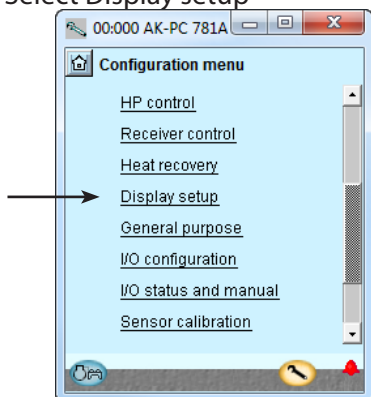

3. Define which readings are to be shown for the individual outputs

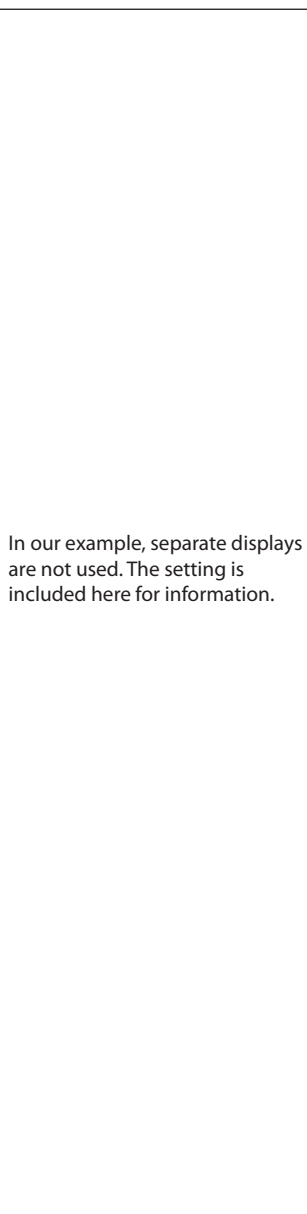
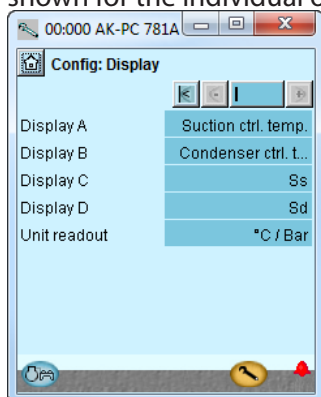

In our example, separate displays are not used. The setting is included here for information.

3 - Display setup

Display

The following can be read for the four outputs..

- Comp. control sensor
- P0 in temperature
- P0 i bar-absolute
- Pctrl bar-absolute
- S4
- Ss
- Sd
- Cond. control sensor
- Tc
- Pc bar-absolute
- S7
- Sgc
- Shp
- Pgc bar-absolute
- Prec bar-absolute
- Stw8
- Shr8
- Speed Compressor

Unit readout

Choose whether readings are to be in SI units (°C and bar) or (US-units °F and psi)

Setup Functions for General purpose

1. Go to Configuration menu

2. Select General purpose

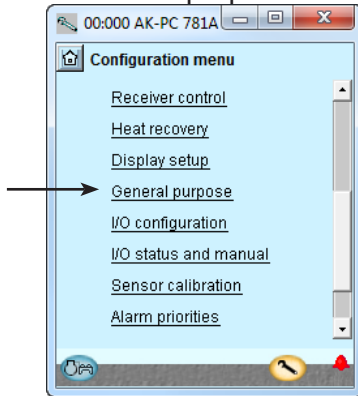

3. Define number of required functions

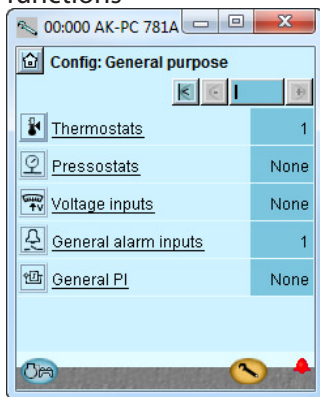

In our example we select one thermostat function for temperature control in the compressor room and one alarm function for monitoring the liquid level in the receiver.

The following number of different functions can be defined:

- 5 thermostats
- 5 pressostats
- 5 voltage signal
- 10 alarm signals
- 3 PI-regulations

Separate thermostats

1. Select thermostats

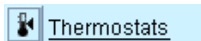

2. Select actual thermostat



3. Define the required thermostat functions

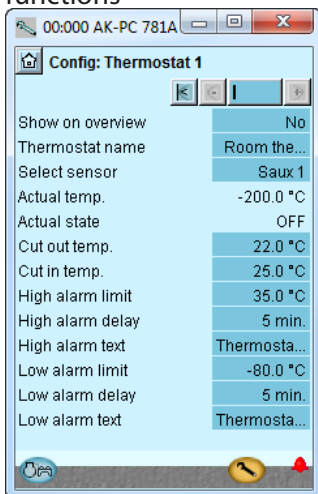

In our example we select one thermostat function for monitoring the plant room temperature.

We have subsequently entered a name for the function.

3 - Thermostats

The general thermostats can be used to monitor the temperature sensors that are used, as well as 4 extra temperature sensors. Each thermostat has a separate outlet to control external automation.

For each thermostat adjust

- Whether the thermostat should also be shown in overview display 1.

(The function is always shown in overview display 2)

- Name
- Which of the sensors is used

Actual temp.

Temperature measurement on the sensor that is attached to the thermostat

Actual state

Actual status on the thermostat outlet

Cut out temp.

Cut-out value for the thermostat

Cut in temp.

Cut-in value for the thermostat

High alarm limit

High alarm limit

Alarm delay high

Time delay for high alarm

Alarm text high

Indicate alarm text for the high alarm

Low alarm limit

Low alarm limit

Alarm delay low

Time delay for low alarm

Alarm text low

Indicate alarm text for low alarm

Separate pressostats

1. Select pressostats

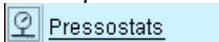

2. Select actual pressostat



3. Define the required pressostat functions

In our example, separate pressostat functions are not used.

3 - Pressostats

Settings as the thermostats

Separate voltage signals

1. Select Voltage inputs

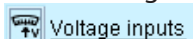

2. Select actual voltage signal



3. Define the required names and values attached to the signal

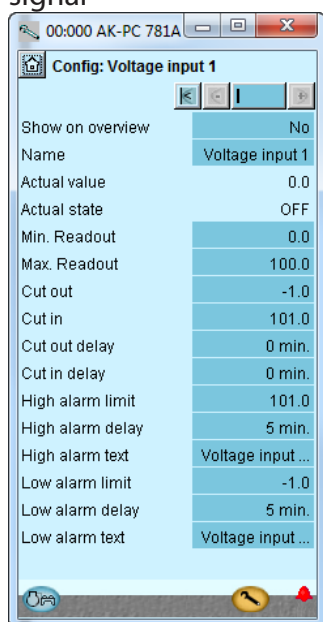

In our example we do not use this function, so the display has been included for your information only.

The name of the function may be xx and further down in the display the alarm texts may be entered.

The values "Min. and Max. Readout" are your settings representing the lower and upper values of the voltage range. 2V and 10V, for example. (The voltage range is selected during the I/O setup).

For each voltage input defined the controller will reserve a relay output in the I/O setup. It is not necessary to define this relay if all you require is an alarm message via the data communication.

3 - Voltage inputs

The general volt inlet can be used to monitor external voltage signals. Each volt inlet has a separate outlet to control external automatic controls.

Set the number of general voltage inputs, specify 1-5:

Show on overview

Name

Actual value

= read-out of the measurement

Actual state

= read-out of outlet status

Min. readout

State read-out values at minimum voltage signal

Max. readout

State read-out values at maximum voltage signal

Cutout

Cut-out value for outlet (scaled value)

Cutin

Cut-in value for outlet (scaled value)

Cutout delay

Time delay for cut-out

Cut in delay

Time delay for cut-in

High alarm limit

High alarm limit

High alarm delay

Time delay for high alarm

High alarm text

Set alarm text for high alarm

Low alarm limit

Low alarm limit

Low alarm delay

Time delay for low alarm

Low alarm text

Indicate alarm text for low alarm

Separate alarm inputs

1. Select General alarm inputs

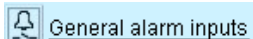

2. Select actual alarm signal



3. Define the required names and values attached to the signal

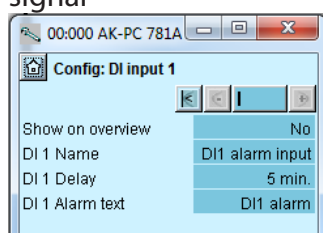

In our example we select one alarm function for monitoring the liquid level in the receiver. We have subsequently selected a name for the alarm function and for the alarm text.

3 - General alarm input

This function can be used to monitor all kinds of digital signals.

No. of inputs

Set the number of digital alarm inputs

Adjust for each input

- Show on overview
- Name
- Delay time for DI alarm (common value for all)
- Alarm text

Separate PI functions

1. Select PI functions

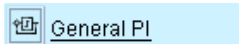

2. Select actual PI-function



3. Define the required names and values attached to the function

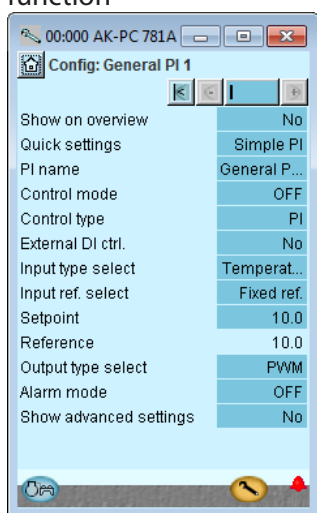

In our example we do not use this function, so the display has been included for your information only.

3 - General PI Control

The function can be used for optional regulation.

Adjust for each regulation

- Show on overview
- Name
- Quick settings

Here is a list of suggestions for PI regulations:

- Simple P
- Simple PI
- Heat control
- Cooling control
- Heat + Amb. Comp
- Pump delta P
- De-superheat
- Floor heat
- Dry cool 3WV
- Dry cool fan
- Convert 0-5V
- Convert 5-10V
- Temp. to volt

- Control mode: Off, Manual or Auto
- Control type: P or PI
- External DI ctrl: Adjusted to On if there is an external switch that can start/stop the regulation.
- Input type: Choose which signal the regulation shall receive: Temperature, pressure, pressure converted to temperature, voltage signal, Tc, Pc, Ss, Sd etc.
- Reference: Either fixed or signal for the variable reference: Choose between: : Non, temperature, pressure, pressure converted to temperature, voltage signal, Tc, Pc, Ss, DI etc..
- Setpoint: If fixed reference is chosen
- Reading the total reference
- Output. Here you select the outlet function (PWM = pulse width modulated (fx AKV valve)), Stepper signal for a stepper motor or voltage signal.
- Alarm mode: Choose whether an alarm shall be attached to the function. If it is set to ON, alarm texts and alarm limits can be entered.
- Advanced ctrl. settings:
 - Ref. X1, Y1 and X2,Y2: Points that define and limit the variable reference
 - PWM period time: Period during which the signal has been on and off.
 - Kp: Amplification factor
 - Tn: Integration time
 - Filter for reference: Duration for smooth changes to the reference
 - Max. error: Maximum permissible fault signal at which the integrator remains in the regulation
 - Min. control output: Lowest permitted output signal
 - Max. control output: Maximum permitted output signal
 - Start up time: Time at startup at which the output signal is force-controlled
 - Startup output: The output signal size at the startup time.
 - Stop output signal. Size of the output signal when regulation is off.

Configuration of inputs and outputs

1. Go to Configuration menu

2. Select I/O configuration

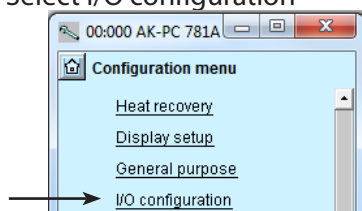

3. Configuration of Digital outputs

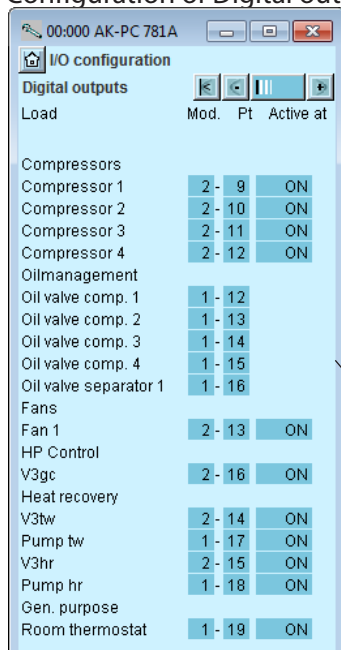

Press the + button to go on to the next page

4. Setup On/off inputs

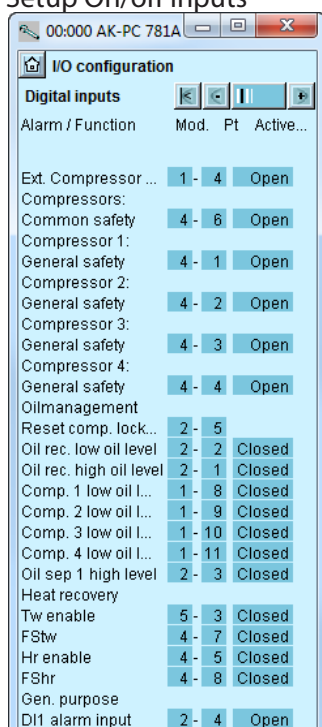

The following displays will depend on the earlier definitions. The displays will show which connections the earlier settings will require. The tables are the same as shown earlier.

- Digital outputs
- Digital inputs
- Analog outputs
- Analog inputs

Load	Output	Module	Point	Active at
Solenoid valve, oil, Comp. 1	DO1	1	12	ON
Solenoid valve, oil, Comp. 2	DO2	1	13	ON
Solenoid valve, oil, Comp. 3	DO3	1	14	ON
Solenoid valve, oil, Comp. 4	DO4	1	15	ON
Solenoid valve, oil separator	DO5	1	16	ON
Circulation pump tw	DO6	1	17	ON
Circulation pump hr	DO7	1	18	ON
Room fan	DO8	1	19	ON
Compressor 1	DO1	2	9	ON
Compressor 2	DO2	2	10	ON
Compressor 3	DO3	2	11	ON
Compressor 4	DO4	2	12	ON
Start /stop of VLT for fans	DO5	2	13	ON
3-way valve, tap water, V3tw	DO6	2	14	ON
3-way valve, Heat circuit, V3hr	DO7	2	15	ON
3-way valve, gas cooler, V3gc	DO8	2	16	ON

We set up the controller's digital outputs by keying in which module and point on this module each one of these has been connected to. We furthermore select for each output whether the load is to be active when the output is in pos. **ON** or **OFF**.

Attention! Relay outputs must not be inverted at unloader valves. The controller inverts the function itself. There will be no voltage at the bypass valves when the compressor is not in operation. Power is connected immediately before the compressor is started.

Function	Input	Module	Point	Active at
External compressor stop	AI4	1	4	Closed
Level switch, oil, comp.1	AI8	1	8	Closed
Level switch, oil, comp.2	AI9	1	9	Closed
Level switch, oil, comp.3	AI10	1	10	Closed
Level switch, oil, comp.4	AI11	1	11	Closed
Level switch, oil, receiver High	AI1	2	1	Closed
Level switch, oil, receiver Low	AI2	2	2	Closed
Level switch, oil, Separator	AI3	2	3	Closed
Level switch, CO2 receiver	AI4	2	4	Open
Reset of compressor stop	AI5	2	5	Pulse signal
Compressor 1 Gen. Safety	DI1	4	1	Open
Compressor 2 Gen. Safety	DI2	4	2	Open
Compressor 3 Gen. Safety	DI3	4	3	Open
Compressor 4 Gen. Safety	DI4	4	4	Open
Start/stop of heat recovery hr	DI5	4	5	Closed
All compressors common safety	DI6	4	6	Open
Flow switch FStw	DI7	4	7	Open
Flow switch FShr	DI8	4	8	Open
Start/stop of heat recovery tw	AI2	5	3	Closed

We set up the controller's digital input functions by keying in which module and point on this module each one of these has been connected to. We furthermore select for each output whether the function is to be active when the output is in pos. **Closed** or **Open**. Open has been selected here for all the safety circuits. This means that the controller will receive signal under normal operation and register it as a fault if the signal is interrupted.

3 - Outputs

The possible functions are the following:

- Comp. 1
- Unloader 1-1
- Unloader 1-2
- Unloader 1-3
- Do for Compressor. 2-8
- Oil valve comp. 1-8
- Lp comp. oil pulse
- Oil valve 1-4 (8)
- Oil valve separat. 1-8
- MT Comp. release
- LT Comp. request
- Injection heat exchanger
- Injection suction line
- Injection ON
- Fan 1
- Fan 2 - 8
- HP Control
- Valve gas cooler V3gc
- Heat recovery
- Valve tap water V3tw
- Pump tap water tw
- Valve heat recov. V3hr
- Pump heat recov. hr
- Additional heat
- Alarm
- I'm alive relay
- Thermostat 1 - 5
- Pressostat 1 - 5
- Volt input 1 - 5
- PI 1-3

4 - Digital inputs

The possible functions are the following:

- Ext. Main switch
- Ext. compr. stop
- Ext. power loss
- Night setback
- Load shed 1
- Load shed 2
- LT Comp. Release
- MT Comp. Request
- All compressors:
- Common safety
- Comp. 1
- Oil pressure safety
- Over current safety
- Motor protect. safety
- Disch. temp. safety
- Disch. press. safety
- General safety
- VSD comp. Fault
- Do for Comp. 2-8
- Fan 1 safety
- Do for fan 2-8
- VSD cond safety
- Reset comp. lockout
- LP comp.oil counter
- Oil receiver low
- Oil receiver high
- Oil level comp.1-8
- Oil separator low 1-8
- Oil separator high 1-8
- Heat recovery
- tw enable
- hr enable
- Flow switch tw
- Flow switch hr
- DI 1 Alarm input
- DI 2-10 ...
- PI-1 Di ref
- External DI PI-1



Press the + button to go on to the next page.

5. Configuration of Analog outputs

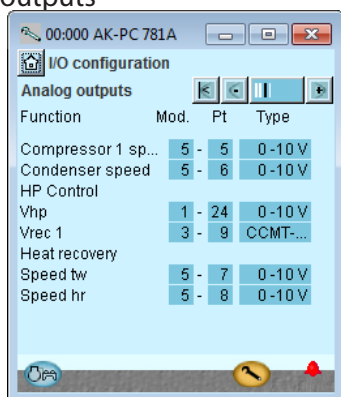

Press the + button to go on to the next page.

6. Configuration of Analog Input signals

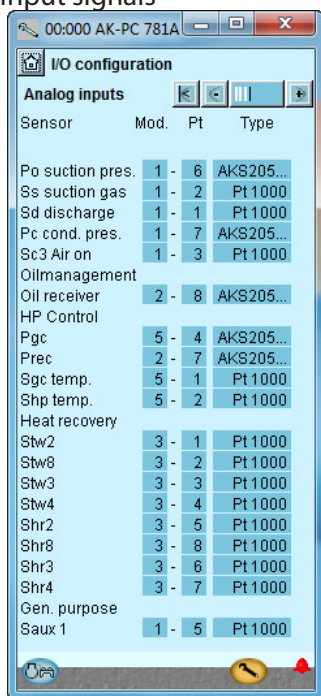

Function	Output	Module	Point	Type
Voltage signal for high pressure valve, ICMTS	AO1	1	24	0-10 V
Stepper signal for by-pass valve, CCMT	Step 1	3	9	CCMT
Speed control, compressor	AO1	5	5	0-10 V
Speed control, gas cooler fan	AO2	5	6	0-10 V
Speed control, pump - tw	AO3	5	7	0-10 V
Speed control, pump - hr	AO4	5	8	0-10 V

Sensor	Input	Module	Point	Type
Disch. gas temperature - Sd	AI1	1	1	Pt 1000
Suction gas temperature - Ss	AI2	1	2	Pt 1000
Outdoor temp. - Sc3	AI3	1	3	Pt 1000
Thermostat sensor in plant room - Saux1	AI5	1	5	Pt 1000
Suction pressure - Po	AI6	1	6	AKS 2050-59
Condenser pressure - Pc	AI7	1	7	AKS 2050-159
Refrigerant receiver, Prec-CO2	AI7	2	7	AKS 2050-159
Oil receiver, Prec-Oil	AI8	2	8	AKS 2050-159
Tap water temperature - Stw2	AI1	3	1	Pt 1000
Tap water temperature - Stw3	AI2	3	2	Pt 1000
Tap water temperature - Stw4	AI3	3	3	Pt 1000
Tap water temperature - Stw8	AI4	3	4	Pt 1000
Heat reclaim temperature Shr2	AI5	3	5	Pt 1000
Heat reclaim temperature Shr3	AI6	3	6	Pt 1000
Heat reclaim temperature Shr4	AI7	3	7	Pt 1000
Heat reclaim temperature Shr8	AI8	3	8	Pt 1000
Temp. gas cooler outlet Sgc	AI1	5	1	Pt 1000
Temp. by-passed gas Shp	AI2	5	2	Pt 1000
Gas cooler pressure Pgc	AI4	5	4	AKS 2050-159

5 - Analog outputs

The possible signals are the following:

- 0 - 10 V
- 2 - 10 V
- 0 - 5 V
- 1 - 5 V
- 10 - 0 V
- 5 - 0 V
- Stepper output
- Stepper output 2
- Stepper user defined: See section "Miscellaneous"

6 - Analog inputs

The possible signals are the following:

- Temperature sensors:
- Pt1000
 - PTC 1000

Pressure transmitters:

- AKS 32, -1 - 6 bar
- AKS 32R, -1 - 6 bar
- AKS 32, -1 - 9 bar
- AKS 32R, -1 - 9 bar
- AKS 32, -1 - 12 bar
- AKS 32R, -1 - 12 bar
- AKS 32, -1 - 20 bar
- AKS 32R, -1 - 20 bar
- AKS 32, -1 - 34 bar
- AKS 32R, -1 - 34 bar
- AKS 32, -1 - 50 bar
- AKS 32R, -1 - 50 bar
- AKS 2050, -1 - 59 bar
- AKS 2050, -1 - 99 bar
- AKS 2050, -1 - 159 bar
- MBS 8250, -1 - 159 bar
- User defined (only ratiometric, min. and max value of the pressure range must be set)

S4 Cold brine
Pctrl

Po suction pres.

Ss suction gas

Sd disch. temp.

Pc Cond. Pres.

S7 Warm brine

Sc3 air on

Ext. Ref. Signal

• 0 - 5 V,

• 0 - 10 V

Oilie receiver

HP control

Pgc

Prec

Sgc

Shp

Stw2,3,4,8

Shr2,3,4,8

HC 1-5

Heat recovery

Saux 1 - 4

Paux 1 - 3

Voltage input 1 - 5

• 0 - 5 V,

• 0 - 10 V,

• 1 - 5 V,

• 2 - 10 V

PI-in temp

PI-ref temp

PI- in voltage

PI-in pres.

PI-ref pres.

Set alarm priorities

1. Go to Configuration menu

2. Select Alarm priorities

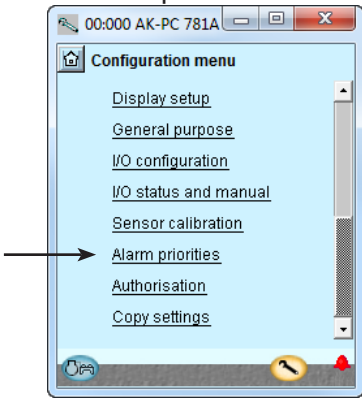

3. Set priorities for Suction group

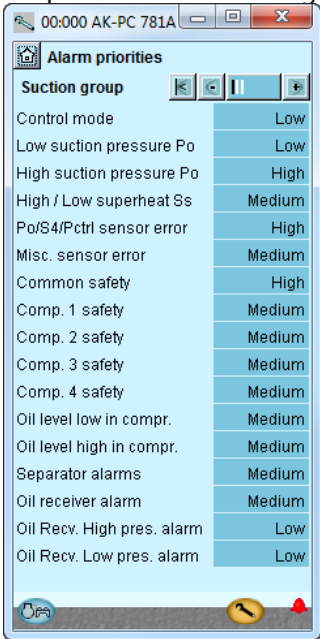

Press the + -button to go on to the next page

4. Set alarm priorities for condenser

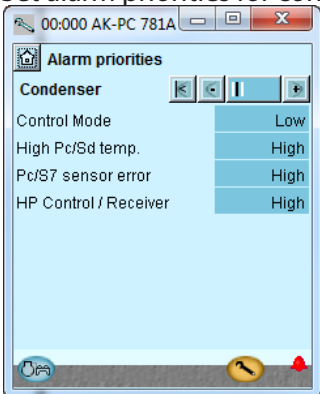

Very many functions have an alarm connected. Your choice of functions and settings has connected all the relevant alarms that are current. They will be shown with text in the three pictures.

All alarms that can occur can be set for a given order of priority:

- "High" is the most important one
- "Log only" has lowest priority
- "Disconnected" gives no action

The interdependence between setting and action can be seen in the table.

Setting	Log	Alarm relay selection			Net-work	AKM-dest.
		Non	High	Low - High		
High	X		X	X	X	1
Medium	X			X	X	2
Low	X			X	X	3
Log only	X					4
Discon- nected						

See also alarm text page 134.

In our example we select the settings shown here in the display

 Press the + -button to go on to the next page

5. Set alarm priorities for thermostat and extra digital signals

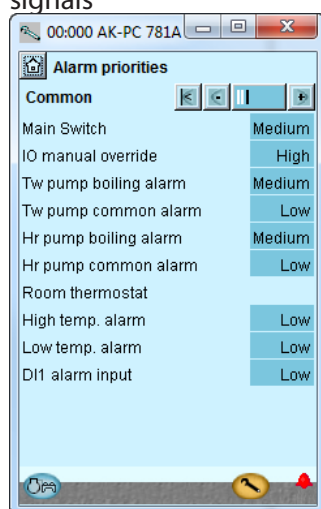

In our example we select the settings shown here in the display

Lock configuration

- 1. Go to Configuration menu
- 2. Select Lock/Unlock configuration

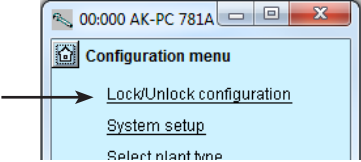

- 3. Lock Configuration

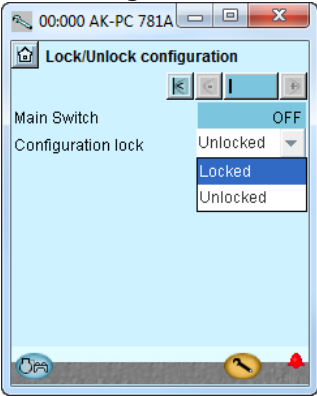

The controller will now make a comparison of selected functions and define inputs and outputs. The result can be seen in the next section where the setup is controlled.

Press in the field against **Configuration lock**.

Select **Locked**.

The setup of the controller has now been locked. If you subsequently want to make any changes in the controller's setup, remember first to unlock the configuration.

Check configuration

1. Go to Configuration menu

2. Select I/O configuration

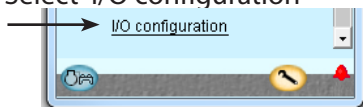

3. Check configuration of Digital Outputs

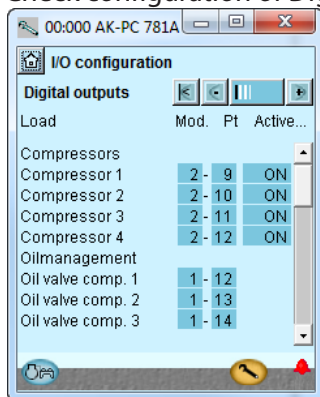

Press the +-button to go on to the next page

4. Check configuration of Digital Inputs

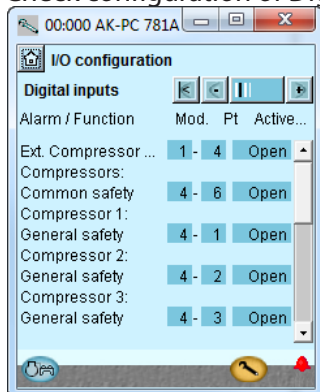

Press the +-button to go on to the next page

This control requires that the setup is locked

(Only when the setup is locked are all settings for in- and outputs activated.)

The setup of the digital outputs appears as it is supposed to according to the wiring made.

The setup of the digital inputs appears as it is supposed to according to the wiring made.

An error has occurred, if you see the following:

0 - 0 ON

A **0 - 0** next to a defined function. If a setting has reverted to 0-0, you must control the setup again.

This may be due to the following:

- A selection has been made of a combination of module number and point number that does not exist.
- The selected point number on the selected module had been set up for something different.

The error is corrected by setting up the output correctly.

Remember that the setup must be unlocked before you can change module and point numbers..

1 - 19 ON

The settings are shown on a **RED** background. If a setting has turned red, you must control the setup again.

This may be due to the following:

- The input or the output has been set up; but the setup has later been changed so that it should no longer be applied.

The problem is corrected by setting **module number to 0 and point number to 0.**

Remember that the setup must be unlocked before you can change module and point numbers.

5. Check configuration of Analog Outputs

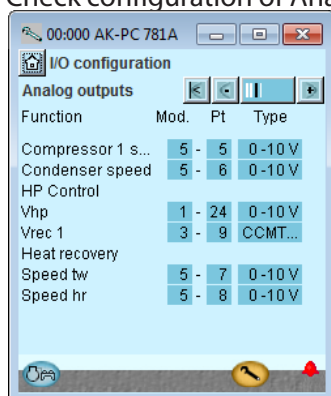

The setup of the analog outputs appears as it is supposed to according to the wiring made.

Press the + -button to go on to the next page

6. Check configuration of Analog Inputs

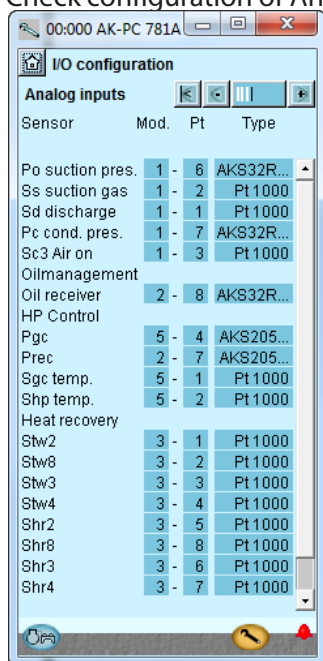

The setup of the analog inputs appears as it is supposed to according to the wiring made.

Check of connections

1. Go to Configuration menu

2. Select I/O status and manual

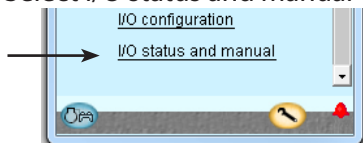

3. Check Digital Outputs

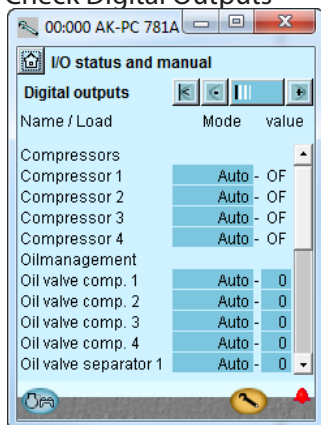

Press the +-button to go on to the next page

4. Check Digital Inputs

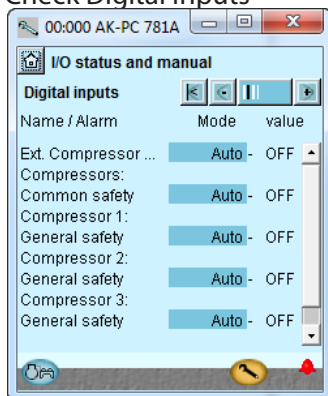

Press the +-button to go on to the next page

Before the control is started we check that all inputs and outputs have been connected as expected.

This controls requires that the setup is locked

By means of the manual control of each output it can be checked whether the output has been correctly connected.

AUTO	The output is controlled by the controller
MAN OFF	The output is forced to pos. OFF
MAN ON	The output is forced to pos ON

Cut out the safety circuit for compressor 1.
Check that LED DI1 on the extension module (module 2) goes out.

Check that the value of the alarm for the safety monitoring of compressor 1 changes to **ON**.
The remaining digital inputs are checked in the same way.

5. Check Analog outputs

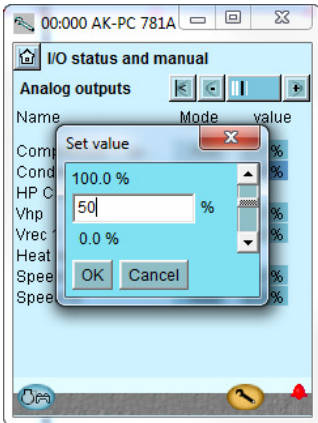
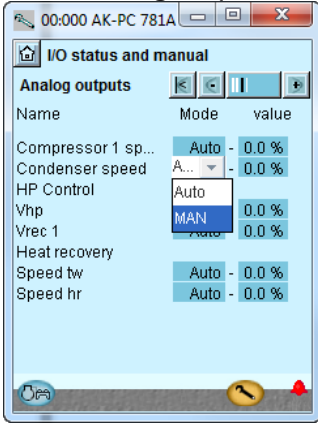

Set Control of output voltage to manual
Press in the **Mode** field.

Select **MAN**.

Press in the **Value** field
Select for example **50%**.

Press **OK**.

On the output you can now measure the expected value: In this example 5 volts

Example of the connection between a defined output signal and a manual set value.

Definition	Setting		
	0 %	50 %	100 %
0 - 10 V	0 V	5 V	10 V
1 - 10 V	1 V	5.5 V	10 V
0 - 5 V	0 V	2.5 V	5 V
2 - 5 V	2 V	3.5 V	5 V
10 - 0V	10 V	5 V	0 V
5 - 0 V	5 V	2,5 V	0 V

6. Put the control of the output voltage back to automatic

Press the +-button to go on to the next page

7. Check Analog inputs

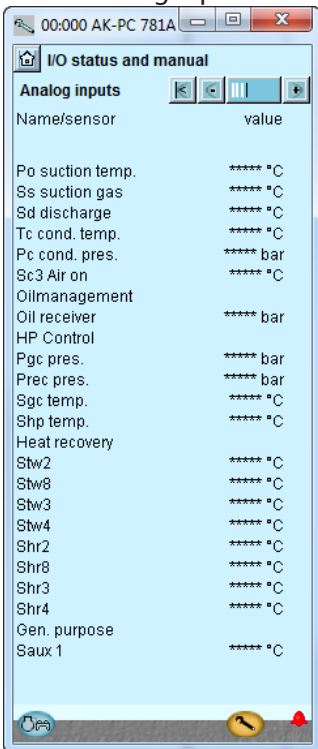

Check that all sensors show sensible values.

In our case we have no values. This may be due to the following:

- The sensor has not been connected.
- The sensor is short-circuited.
- The point or module number has not been set up correctly.
- The configuration is not locked.

Check of settings

1. Go to the overview

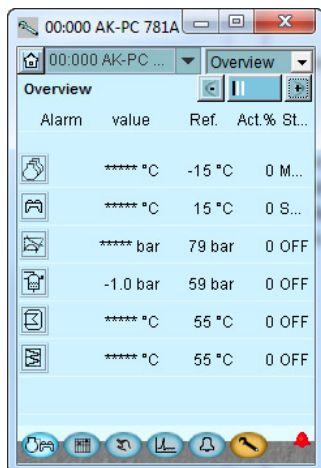

Before the control starts, we check that all the settings are as they should be.

The overview display will now show one line for each of the general functions. Behind each icon there is a number of displays with the different settings. It is all these settings that have to be checked.

2. Select suction group



3. Move on through all the individual displays for the suction group



Change displays with the +- button. Remember the settings at the bottom of the pages – the ones that can only be seen via the "Scroll bar".

4. Safety limits

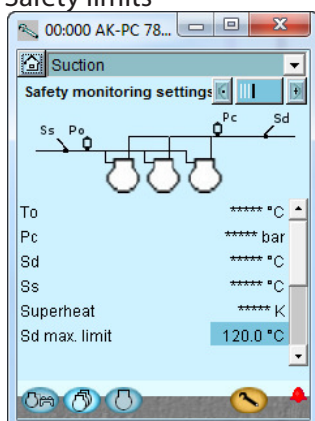

The last page contains safety limits and restart times.

5. Go back to the overview



6. Select condenser group



7. Move on through all the individual displays for the condenser group.



Change displays with the +- button. Remember the settings at the bottom of the pages – the ones that can only be seen via the "Scroll bar".

8. Safety limits

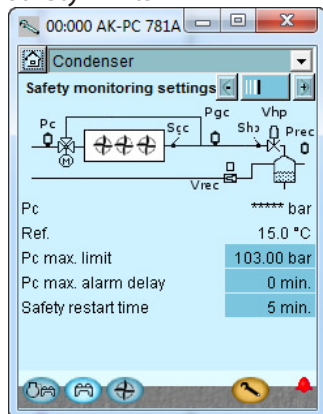

The last page contains safety limits and restart times.

9. Go back to the overview and move on to the rest of the functions.

10. General functions

When all the functions in overview display 1 have been reviewed, it is time to look at the "General functions" in overview display 2. Press the + button to access.

The first is the thermostat group



Check the settings.

11. Then the pressure switch group



Check the settings.

12. Proceed with the remaining functions.

13. The controller setup has been completed.

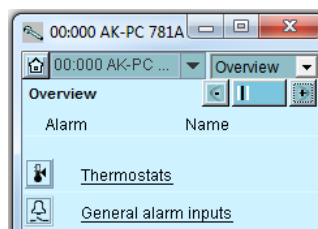

All the defined general functions are shown in overview display 2. In addition to always being shown in display 2, functions can be selected to be shown in display 1. Individual functions can be selected for display in display 1 via the "Show in overview display" setting.

Schedule function

1. Go to Configuration menu



2. Select schedule



3. Setup schedule

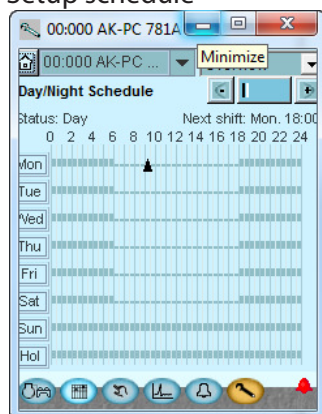

Before regulation is started we will set the schedule function for the night setback of the suction pressure.
In other cases where the controller is installed in a network with one system unit, this setting may be made in the system unit which will then transmit a day/night signal to the controller.

Press a weekday and set the time for the day period.

Continue with the other days.

A complete weekly sequence is shown in the display.

Installation in network

1. Set the address (here, for example 3)

Turn the right-hand address switch so that the arrow will point at 3.

The arrow of the two other address switches must point at 0.

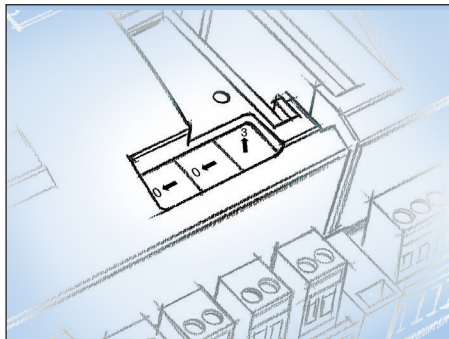

2. Push the Service Pin

Press down the service pin and keep it down until the Service Pin LED lights up.

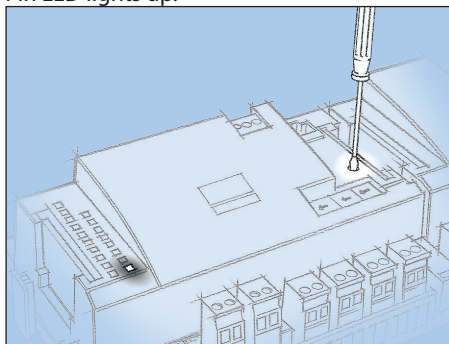

3. Wait for answer from the system unit

Depending on the size of the network it may be up to one minute before the controller receives an answer as to whether it has been installed in the network.

When it has been installed the Status LED will start to flash faster than normal (once every half second). It will continue with this for about 10 minutes

4. Carry out new login via Service Tool



If the Service Tool was connected to the controller while you installed it in the network, you must carry out a new login to the controller via the Service Tool.

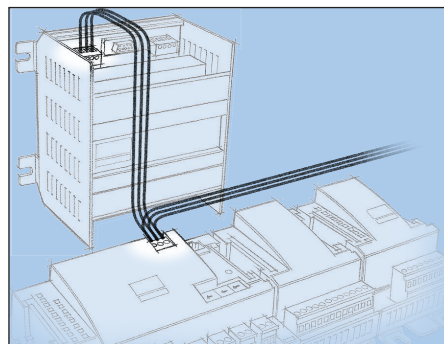

The controller has to be remote-monitored via a network. In this network we assign address number 3 to the controller.

The same address must not be used by more than one controller in the same network.

Requirement to the system unit

The system unit must be a gateway type AKA 245 with software version 6.0 or higher. It is capable of handling up to 119 AK controllers.

Alternatively, it can be an AK-SM 720. It is capable of handling up to 200 AK controllers.

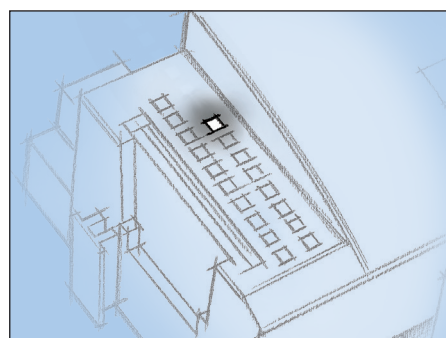

If there is no answer from the system unit

If the Status LED does not start flashing faster than normal, the controller has not been installed in the network. The reason for this may be one of the following:

The controller has been assigned an address out of range

Address 0 cannot be used.

If the system unit in the network is an AKA 243B Gateway only the addresses between 1 and 10 can be used.

The selected address is already being used by another controller or unit in the network:

The address setting must be changed to another (vacant) address.

The wiring has not been carried out correctly.

The termination has not been carried out correctly.

The data communication requirements are described in the document: "Data communication connections to ADAP-KOOL® Refrigeration Controls" RC8AC.

First start of control

Check alarms

1. Go to the overview



Press the blue overview button with the compressor and condenser at the bottom left of the display.

2. Go to the Alarm list



Press the blue button with the alarm bell at the bottom of the display.

3. Check active alarms

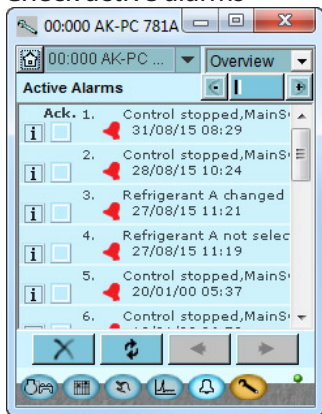

In our case, we have a series of alarms. We will tidy them up so that we only have those that are relevant.

4. Remove cancelled alarm from the alarm list



Press the red cross to remove cancelled alarms from the alarm list.

5. Check active alarm again

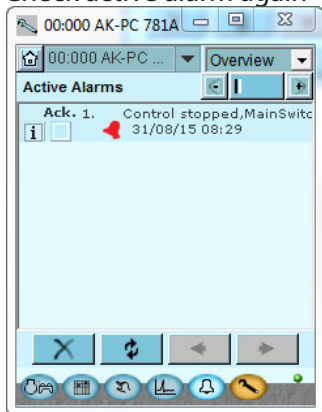

In our case an active alarm remains because the control has stopped. This alarm must be active when control has not started. We are now ready for the startup of control.

Please note that active plant alarms are automatically cancelled when the main switch is in pos. OFF. If active alarms appear when the control is started the reason for these should be found and remedied.

Start the control

1. Go to Start/Stop display



Press the blue manual control button at the bottom of the display.

2. Start control

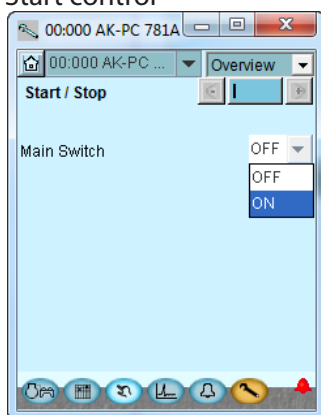

Press in the field against **Main switch**.
Select **ON**.

The controller will now start controlling the compressors and the fans.

Note:
Control does not start until both the internal and external switch are "ON".

Any external compressor stop breaker must be ON for the compressors to start.

Manual capacity control

1. Go to overview



2. Select suction group



Press the suction group button for the suction group that is to be controlled manually.



Press the +-button to go on to the next page

3. Set capacity control to manual

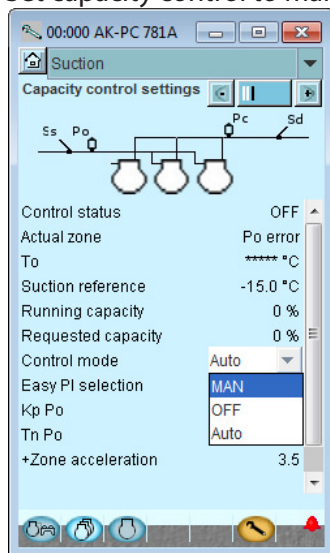

4. Set capacity in percent

Press in the blue field against **Manual capacity**.

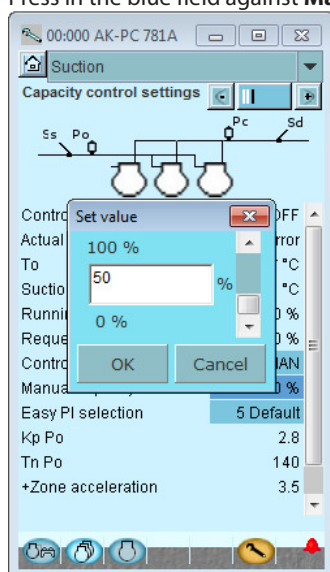

If you need to manually adjust the capacity of the compressors, you can use the following procedure:

WARNING!

If you force control the compressors, the oil management will be shut down. This could cause compressor damages. (If the wiring of the compressors includes safety relays, monitoring will continue. See Regulating functions.)

Press the blue field against **Control mode**
Select **MAN**.

Set the capacity to the required percentage.
Press **OK**.

5. Regulating functions

This section describes how the different functions work

Suction group

Controlling sensor selection

Depending on use, the capacity distributor can regulate according to the suction pressure P₀, a media temperature S₄ or separate control pressure P_{ctrl} in a different refrigeration circuit, e.g. cascade system.

Cap. Ctrl sensor = P₀ / S₄ / P_{ctrl}

Example 1 – P₀

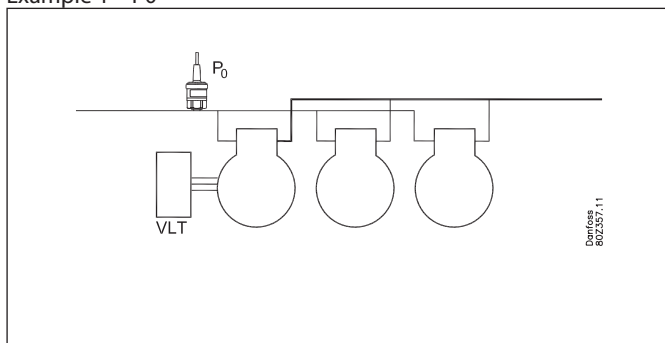

Example 2 – S₄ media sensor

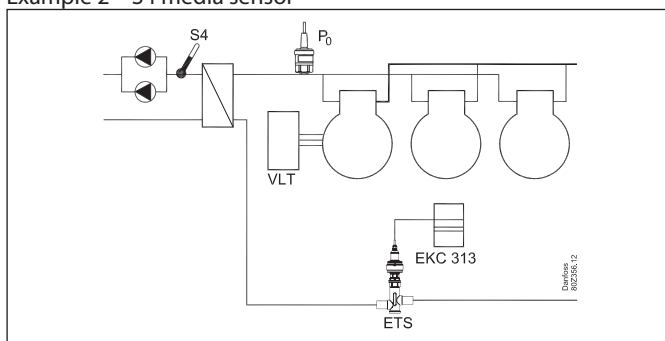

When the controlling sensor is selected as S₄, P₀ is used as a safety function for low suction pressure and will ensure disconnection of compressor capacity (frost protection).

Example 3 – P_{ctrl} sensor

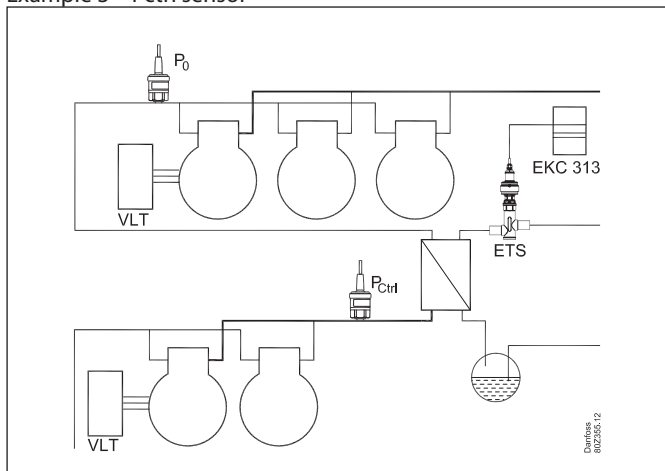

When P_{ctrl} is used as controlling sensor, a refrigerant type for this pressure transmitter must be set, e.g. CO₂.

P₀ is used as a safety function against insufficient suction pressure and will ensure disconnection of compressor capacity.

On cascade systems the signal from P_{ctrl} can be used by both the high-pressure and low-pressure controls either for the controlling sensor or high-pressure monitoring.

Parallel compression

(Only on CO₂ system and control of receiver pressure)

If the controller is to control an IT compressor for parallel compression, the following regulation settings will be required:

- The system type must be set to LT
- The regulation sensor must be set to P₀ (the signal received from the receiver - Prec).

Handling of sensor error

Cap. Ctrl. Sensor = P₀

When P₀ is used as the regulating sensor, an error in the signal will mean that regulation continues with 50% cut-in in daily operation and 25% cut-in at night, but for a minimum of one step.

Cap. Ctrl. Sensor = S₄

Provided that S₄ is used as a regulating sensor, an error in this sensor will mean that regulation continues from the P₀ signal, but in accordance with a reference that lies 5K under the real reference. If there is an error on both S₄ and P₀, regulation will continue with 50% cut-in in daily operations and 25% of cut-in in night operations, but for a minimum of one step.

Cap. Ctrl. Sensor = P_{ctrl}

When P_{ctrl} is used as a controlling sensor, an error in this sensor will mean that regulation continues after the P₀ signal, but in accordance with a reference that lies 5 K under the real reference. If there is an error on both P_{ctrl} and P₀, regulation will continue with e.g. 50% cut-in in daily operations and e.g. 25% cut-in in night operations, but for a minimum of one step.

Reference

The reference for the regulation can be defined in 2 ways:

Either

$P0Ref = P0 \text{ setting} + P0 \text{ optimization} + \text{night displacement}$
or

$P0Ref = P0 \text{ setting} + \text{night displacement} + \text{Ext. Ref}$

P0 setting

A basic value for the suction pressure is set.

P0 optimization

This function displaces the reference so that regulation will not take place with a lower suction pressure than required.

The function cooperates with controllers on the individual refrigeration appliances and a system manager. The system manager obtains data from the individual regulations and adapts the suction pressure to the optimum energy level. The function is described in the manual for the System manager.

With this function you can read which appliance is most heavily loaded at the moment as well as the displacement allowed for the suction pressure reference.

Night displacement

The function is used to change the suction pressure reference for night time operation as an energy saving function.

With this function the reference can be displaced by up to 25 K in positive or negative direction. (When you displace to a higher suction pressure, a positive value is set).

Displacement can be activated in three ways:

- Signal on an input
- From a master gateway's override function
- Internal time schedule

The "night displacement" function should not be used when regulation with the override function "P0-optimisation" is performed. (Here the override function will itself adapt the suction pressure to the max. permissible).

If a short change in the suction pressure is needed (for example, up to 15 minutes in connection with defrosting) the functions can be applied. Here the PO-optimisation will not have time to compensate for the change.

Override with a 0 - 10 V signal

When a voltage signal is connected to the controller the reference can be displaced. In the setup it is defined how big a displacement is to take place at max. signal (10 V) and at min. signal.

Limitation of reference

To safeguard yourself against a too high or too low regulation reference, a limitation of the reference must be set.

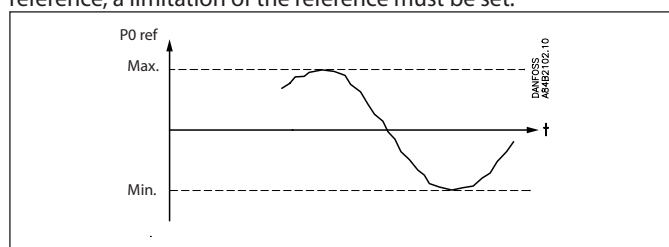

Forced operation of the compressor capacity in the suction group

A forced operation of the capacity can be carried out which disregards the normal regulation.

Depending on the selected form of forced operation, the safety functions will be cancelled.

Forced operation via overload of requested capacity

The control is set to manual and the desired capacity is set in % of the possible compressor capacity.

Forced operation via overload of digital outlets

The individual outputs can be set to MAN ON or MAN OFF in the software. The control function disregards this but an alarm is sent out that the outlet is being overridden.

Forced operation via change-over switches

If the forced operation is done with the switch-over on the front of an expansion model, this is not registered by the control function and no alarm is sounded. The controller continues to run and couples with the other relays.

Capacity control of compressors

Capacity control

AK-PC 781A can control up to 10 compressors. Each compressor can have up to 3 unloaders. One or two of the compressors can be equipped with speed regulation.

The cut-in capacity is controlled by signals from the connected pressure transmitter/temperature sensor and the set reference. Set a neutral zone around the reference.

In the neutral zone, the regulating compressor controls the capacity so that pressure can be maintained. When it can no longer maintain the pressure within the neutral zone, the controller will cut out or cut in the next compressor in the sequence. When further capacity is either cut out or cut in, the capacity from the regulating compressor will be modified accordingly to maintain the pressure within the neutral zone (only where the compressor has variable capacity).

- When the pressure is higher than the “reference + a half neutral zone”, cut-in of the next compressor (arrow up) is permitted.
- When the pressure is lower than the “reference - a half neutral zone”, cut-out of a compressor (arrow down) is permitted.
- When the pressure is within the neutral zone, the process will continue with the currently activated compressors. Unload valves (if present) will activate, depending on whether suction pressure is above or below the reference value.

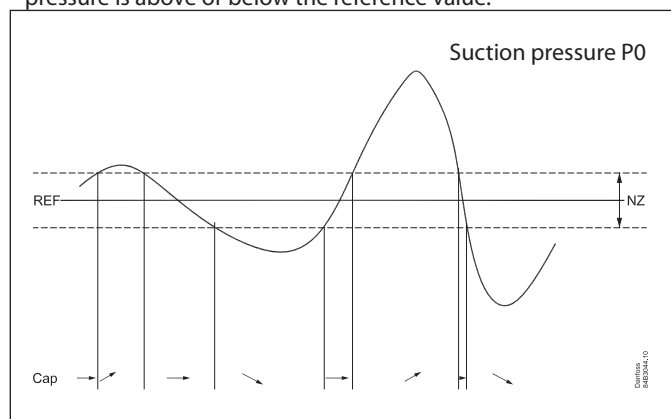

Change capacity

The controller will cutin or cutout capacity based on these basic rules:

Increase capacity:

The capacity distributor will start extra compressor capacity as soon as the requested capacity has increased to a value, which allows the next compressor step to start. Referring to below example - a compressor step is added as soon as there is “Room” for this compressor step below the requested capacity curve.

Decrease capacity:

The capacity distributor will stop compressor capacity as soon as the requested capacity has decreased to a value, which allows the next compressor to stop. Referring to below example - a compressor step is stopped as soon as there is no more “Room” for this compressor step above the requested capacity curve.

Example:

4 compressor of equal size - The capacity curve will look like this

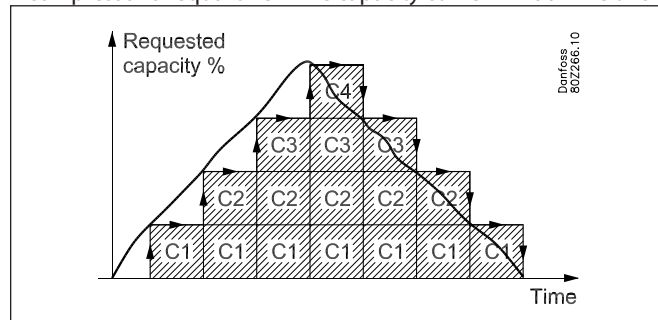

Cut-out of the last compressor stage:

Normally, the last compressor step will only be cut-out when the required capacity is 0% and the suction pressure is below the neutral zone.

Operation time first step

At start-up the refrigeration system must have time to be stable before the PI controller takes over the control. For this purpose at start-up of a plant a limitation is made of the capacity so that only the first capacity step will cutin after a set period (to be set via “runtime first step”).

Pump down function:

To avoid too many compressor starts/stops with low load, it is possible to define a pump down function for the last compressor.

If the pump down function is used, the compressors will be cut-out when the actual suction pressure is down to the configured pump down limit.

Note that the configured pump down limit should be set higher than the configured safety limit for low suction pressure “Min Po”.

Variable integration time

There are two parameters, so T_n can be made variable. This allows control to be more rapid, the further pressure deviates from the reference.

The A^+ setting will lower T_n when the pressure is above the reference, and the A^- setting will lower T_n when the pressure is below the reference.

T_n has been set to 120 s in the graph below, and falls to 60 s if the pressure is above the reference and to 40 s if the pressure is below the reference.

Above the reference: Set T_n divided by the A^+ value.

Below the reference: Set T_n divided by the A^- value.

The controller calculates the curve, such that regulation is smooth.

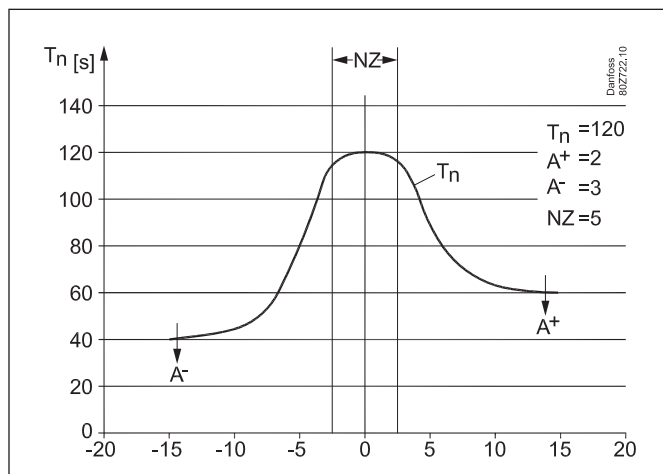

Regulation parameters

To make it easier to start up the system, we have grouped regulation parameters into sets of commonly used values, called "Easy-settings". Use these to choose between sets of settings appropriate for a system which responds slowly or quickly. The factory setting is 5.

If you need to fine tune the control, select the "User defined" setting. All parameters can then be freely adjusted.

Easy-Settings	Regulation parameters			
	Kp	Tn	A+	A-
1 = Slowest	1.0	200	3.5	5.0
2	1.3	185	3.5	4.8
3 = Slower	1.7	170	3.5	4.7
4	2.1	155	3.5	4.6
5 = Default	2.8	140	3.5	4.4
6	3.6	125	3.5	4.2
7 = Faster	4.6	110	3.5	4.1
8	5.9	95	3.5	4.0
9	7.7	80	3.5	3.8
10 = Fastest	9.9	65	3.5	3.5
User defined	1.0 - 10.0	10 - 900	1.0 - 10.0	1.0-10.0

Capacity distribution methods

The capacity distributor can work based on 2 distribution principles.

Coupling pattern – Cyclical operation:

This principle is used if all compressors are of the same type and size.

The compressor cuts-in and cuts-out in accordance with the "First In First Out" principle (FIFO) to equalise operating hours between the compressors.

Speed-regulated compressors will always be cut in first, and the variable capacity is used to fill capacity gaps between the subsequent steps.

Timer restrictions and safety cut outs

If a compressor is prevented from starting because it is "hanging" on the restart timer or is safety cut out, this step is replaced by another compressor.

Operating time equalisation

The operating hour equalizing is carried out between compressors of the same type with the same total capacity.

- At the different startups the compressor with the lowest number of operating hours will be started first.
- At the different stops the compressor with the highest number of operating hours will be stopped first.
- For compressors with several steps, the operating time equalizing is carried out between the compressors' main steps.

Compressor runtime	Equaliza...	24h	Total
0 h	0.0 %	0 h	0 h
0 h	0.0 %	0 h	0 h
0 h	0.0 %	0 h	0 h
0 h	0.0 %	0 h	0 h

- The left column shows the operating hours, according to which the controller equalises.
- The middle column shows (as a percentage) to what extent the individual compressor has been activated within the last 24 hours.
- The right column shows the compressor's current operating time. The value should be reset when the compressor is replaced.

Coupling pattern – Best fit operation

This principle is used if the compressors are of different sizes. The capacity distributor will cut-in or cut-out the compressor capacity in order to ensure the least possible capacity jump.

Speed-regulated compressors will always be cut in first, and the variable capacity will be used to fill capacity gaps between the subsequent steps.

Timer restrictions and safety cut outs

If a compressor is prevented from starting because it is "hanging" on the restart timer or is safety-cut out, this step is replaced by another compressor or another combination.

Power pack types – compressor combinations

The controller is able to control power packs with up to 10 compressors of various types:

- One or two speed controlled compressor
- Capacity controlled piston compressors with up to 3 unloader valves
- Single step compressors – piston

The chart below shows the compressor combination which the controller is capable of controlling. The chart also shows which coupling pattern can be set for the individual compressor combinations.

Combination	Description	Coupling pattern	
		Cyclical	Best fit
	One-step compressors. *1	x	x
	A compressor with an unloader valve, combined with one-step compressors. *2	x	
	Two compressors with unloader valves, combined with one-step compressors. *2	x	
	All compressors with unloader valves. *2	x	
	A speed-regulated compressor combined with one-step compressors. *1 and *3	x	x
	A speed-regulated compressor combined with several compressors with unloader valves. *2 and *3	x	
	Two speed-regulated compressors combined with one-step compressors *4	x	x
	Screw compressor combined with one-step compressors	x	
	Two screw compressors combined with one-step compressors	x	
	Three screw compressors combined with one-step compressors	x	

The following types of screw compressor may be used for regulation		
Screw with unloader 0%, 75%, 100%	Screw with two unloaders 0, 50%, 75%, 100%	Screw with three unloaders + PWM 0 - 100%

- *1) For a cyclical coupling pattern, the one-step compressors must be the same size.
- *2) For compressors with unloader valves, it is generally true that they must have the same size, the same number of unloader valves (max 3) and the same sized main steps. If compressors with unloader valves are combined with one-step compressors, all compressors should be the same size.
- *3) Speed-regulated compressors can have different sizes in relation to subsequent compressors.
- *4) When two speed-regulated compressors are used, they must have the same frequency range.
For cyclical coupling patterns, the two speed-regulated compressors should be the same size and the subsequent one-step compressors should also be the same size.

In appendix A there is a more detailed description of the coupling patterns for the individual compressor applications with associated examples.

The following is a description of some general rules for handling capacity-regulated compressors, speed-regulated compressors and also for two speed-regulated compressors.

Capacity-regulated compressors with unloader valves

"Unloader control mode" determines how the capacity distributor should handle these compressors.

Unloader control mode = 1

Here the capacity distributor allows only one of the compressors to be unloaded at a time. The advantage of this setting is that it avoids operating with several compressors unloaded, which is not energy efficient.

For example:

Two capacity-regulated compressors of 20 kW, each with 2 unloader valves, cyclical coupling pattern.

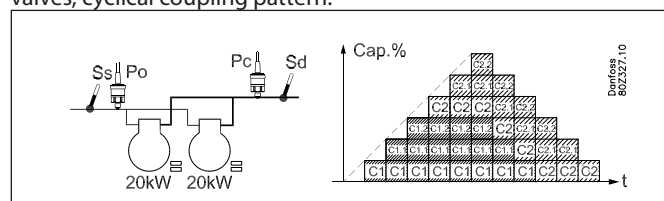

- For decreasing capacity, the compressor with the most operating hours is unloaded (C1).
- When C1 is completely unloaded, it is cut-out before compressor C2 is unloaded.

Unloader control mode = 2

Here the capacity distributor allows two compressors to be unloaded while capacity is decreasing. The advantage of this setting is it reduces the number of compressor start/stops.

For example:

Two capacity-regulated compressors of 20 kW, each with 2 unloader valves, cyclical coupling pattern.

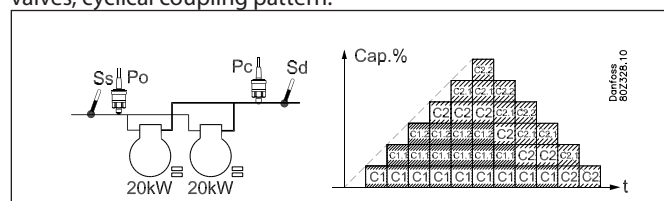

- For decreasing capacity, the compressor with the most operating hours is unloaded (C1).
- When C1 is completely unloaded, compressor C2 with one-step is unloaded before C1 is cut out.

Attention!

Relay outputs must not be inverted at unloader valves. The controller inverts the function itself. There will be no voltage at the bypass valves when the compressor is not in operation. Power is connected immediately before the compressor is started.

Speed control compressors:

The controller is able to use speed control on the leading compressor in different compressor combinations. The variable part of the speed controlled compressor is used to fill in capacity gaps of the following compressor steps.

General regarding handling:

One of the defined capacity steps for the compressor regulation may be connected to a speed control unit that may be a frequency converter type VLT, for example.

An output is connected to the frequency converter's ON/OFF input and at the same time an analog output "AO" is connected to the frequency converter's analog input. The ON/OFF signal will start and stop the frequency converter and the analog signal will indicate the speed. It is only the compressor defined as compressor 1 (1+2) that can be speed controlled.

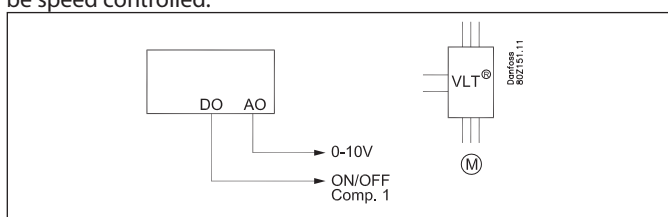

When the step is in operation it will consist of a fixed capacity and a variable capacity. The fixed capacity will be the one that corresponding to the mentioned min. speed and the variable one will lie between the min. and max. speed. To obtain the best regulation the variable capacity must be bigger than the subsequent capacity steps it has to cover during the regulation. If there are major short-term variations in the plant's capacity requirement it will increase the demand for variable capacity.

This is how you cut the step in and out:

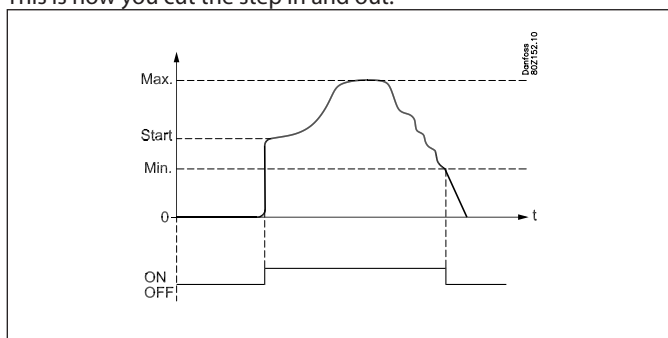

Cutin

The speed-controlled compressor will always be the first to start and the last to stop. The frequency converter will be started when a capacity requirement corresponding to the mentioned "Start speed" arises (the relay output changes to ON and the analog output is supplied with a voltage corresponding to this speed). It is now up to the frequency converter to bring the speed up to "Start speed".

The capacity step will now be cut in and the required capacity determined by the controller.

The start speed always ought to be set so high that a fast lubrication of the compressor is obtained during the start.

Controlling – increasing capacity

If the need for capacity becomes larger than "Max. Speed" then the subsequent compressor step will be cut-in. At the same time, the speed on the capacity step will be reduced so the capacity is reduced with a size that corresponds to exactly the cut-in compressor step. Thereby a completely "frictionless" transition is achieved without capacity holes (refer also to sketch).

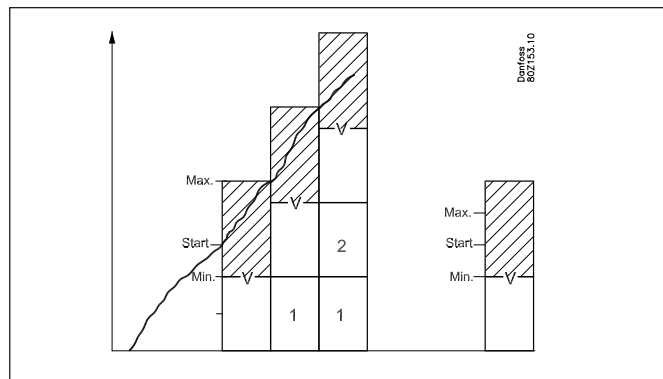

Controlling – decreasing capacity

If the capacity requirement becomes less than "Min. speed" then the subsequent compressor step will be cut-out. At the same time, the speed on the capacity step is increased so the capacity is increased with a size that corresponds to exactly the cut-out compressor step.

Cut-out

The capacity step will be cut-out when the compressor has reached "Min. Speed" and the requested capacity has dropped to 1%.

Timer restriction on speed controlled compressor

If a speed controlled compressor is not allowed to start due to a timer restriction, no other compressor is allowed to start. When the timer restriction has expired the speed controlled compressor will start.

Safety cutout on speed controlled compressor

If the speed controlled compressor is cutout on safety other compressors are allowed to start. As soon as the speed controlled compressor is ready to start it will be the first compressor to start.

As mentioned before the variable part of the speed capacity should be bigger than the capacity of the following compressor steps in order to achieve a capacity curve without "holes". In order to illustrate how the speed control will react at different pack combinations a couple of examples will be given here:

a) Variable capacity bigger than following compressor steps:

When the variable part of the speed controlled compressor is bigger than the following compressors there will be no “holes” in the capacity curve.

Example:

- 1 speed controlled compressor with a nominal capacity at 50Hz of 10kW - Variable speed range 30 – 90Hz
- 2 one step compressors of 10 kW

Fixed capacity = 30 HZ / 50 HZ x 10 kW = 6 kW

Variable capacity = 60 HZ / 50Hz x 10 kW = 12 kW

The capacity curve will look like this:

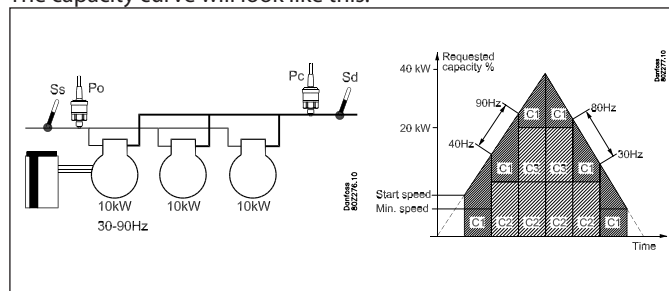

As the variable part of the speed controlled compressor is bigger than the following compressor steps, the capacity curve will be without holes.

- 1) The speed controlled compressor will be cut in when the requested capacity has reached the start speed capacity.
- 2) The speed controlled compressor will increase speed until it reaches max speed at a capacity of 18 kW.
- 3) The one step compressor C2 of 10 kW is cut in and the speed on C1 is reduced too so that it corresponds to 8kW (40Hz)
- 4) The speed controlled compressor will increase speed until the total capacity reaches 28 kW at max speed
- 5) The one step compressor C3 of 10 kW is cut in and the speed on C1 is reduced too so that it corresponds to 8kW (40Hz)
- 6) The speed controlled compressor will increase speed until the total capacity reaches 38 kW at max speed
- 7) When reducing capacity the one step compressors will be cut out when the speed on C1 is at minimum

b) Variable part smaller than following compressor steps:

If the variable part of the speed controlled compressor is smaller than the following compressors there will be “holes” in the capacity curve.

Example:

- 1 speed controlled compressor with a nominal capacity at 50Hz of 20kW - Variable speed range 25 – 50Hz
- 2 one step compressors of 20 kW

Fixed capacity = 25 HZ / 50 HZ x 20 kW = 10 kW

Variable capacity = 25 HZ / 50Hz x 20 kW = 10 kW

The capacity curve will look like this:

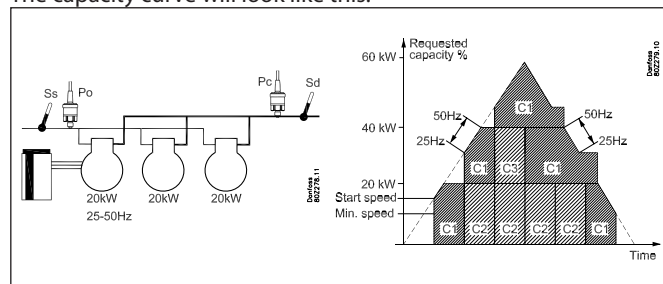

As the variable part of the speed controlled compressor is smaller than the following compressor steps the capacity curve will have some holes that can not be filled out by the variable capacity.

- 1) The speed controlled compressor will be cut in when the requested capacity has reached the start speed capacity.
- 2) The speed controlled compressor will increase speed until it reaches max speed at a capacity of 20 kW.
- 3) The speed controlled compressor will stay at max speed until the requested capacity has increased to 30 kW.
- 4) The one step compressor C2 of 20 kW is cut in and the speed on C1 is reduced to min. so that it corresponds to 10kW (25Hz). Total capacity = 30 kW.
- 5) The speed controlled compressor will increase speed until the total capacity reaches 40 kW at max speed
- 6) The speed controlled compressor will stay at max speed until the requested capacity has increased to 50 kW.
- 7) The one step compressor C3 of 20kW is cut in and the speed on C1 is reduced to min. so that it corresponds to 10kW (25Hz). Total capacity = 50 kW
- 8) The speed controlled compressor will increase speed until the total capacity reaches 60 kW at max speed
- 9) When reducing capacity the one step compressors will be cut out when the speed on C1 is at minimum speed.

Two speed-regulated compressors

The controller is capable of regulating the speed of two compressors of the same or different sizes. The compressors can be combined with one-step compressors of the same or different sizes, depending on the choice of coupling pattern.

General regarding handling:

Generally, the two speed-regulated compressors are managed according to the same principle as for one speed-regulated compressor. The advantage of using two speed-regulated compressors is that it allows for a very low capacity, which is an advantage for low loads. At the same time, it produces a very large, variable regulating area.

Compressor 1 and 2 both have their own relay outlets to start/stop separate frequency converters, for example of type VLT. Both frequency converters use the same analog output signal AO which is connected to the frequency converters' analog signal input. The relay outputs will start and stop the frequency converter and the analog signal will indicate the speed.

The precondition for using this regulating method is that both compressors have the same frequency range.

The speed-regulated compressors will always be the first to start and the last to stop.

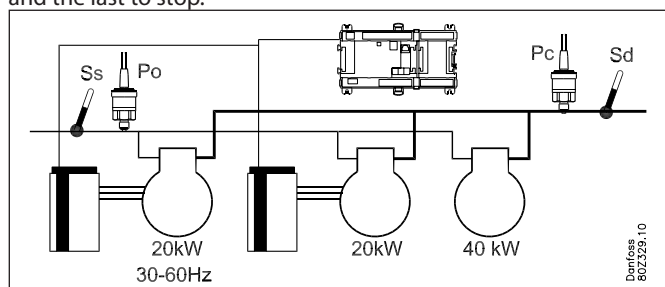

Cut-in

The first speed-regulated compressor will be started when there is a capacity requirement which matches the setting.

The "Start speed" (relay outlet changes to on and the analog outlet is supplied with a voltage that matches this speed). It is now up to the frequency converter to bring the speed up to the "Start speed".

The capacity step will now be cut in and the desired capacity determined by the controller.

The start speed should always be set so high that a good lubrication of the compressor is quickly reached during start-up.

For a cyclical coupling pattern, the subsequent speed-regulated compressor will be cut in when the first compressor runs at max. speed and the desired capacity has reached a value that allows the cut-in of the next speed-regulated compressor at start speed. Afterwards, both compressors will be cut in together and will run in parallel. The following one-step compressors will be cut in and out in accordance with the selected coupling pattern.

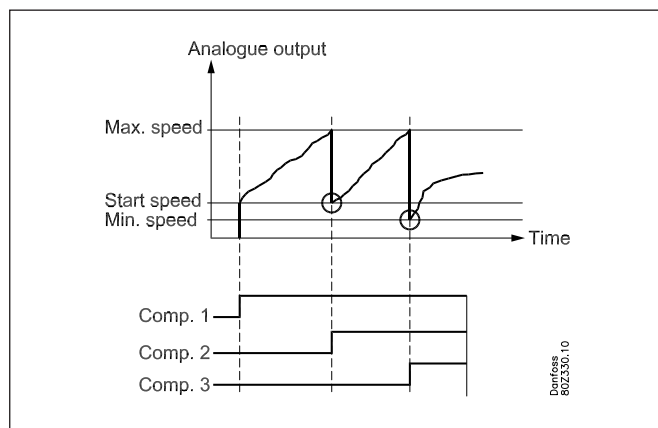

Controlling – decreasing capacity

The speed-regulated compressors will always be the last compressors running.

When the capacity requirement during cyclical operations becomes less than "Min. speed" for both compressors, the speed-regulated compressor with the most operating hours will be cut-out. At the same time, the speed of the last speed-regulated compressor increases so that the capacity is increased to the level that matches the cut-out compressor's step.

Cutout

The last speed-regulated compressor will be cut-out when the compressor has reached "Min. speed" and the capacity requirement (desired capacity) has decreased to under 1% (see however the section on the pump down function).

Timer restriction and safety cut-outs

Timer limits and safety cut-outs on speed-regulated compressors should be managed in accordance with the general rules for individual coupling patterns.

Short descriptions and examples are given below of the handling of two speed-regulated compressors for the individual coupling patterns. For a more detailed description, refer to the appendix at the end of the chapter.

Cyclical operation

For cyclical operations, both speed-regulated compressors will have the same size and operating hours will be equalized between the compressors in accordance with the First-in-First-Out Principle (FIFO). The compressor with the least operating hours will be the first to start. The following speed-regulated compressor will be cut in when the first compressor runs at max. speed and the desired capacity has reached a value that allows the cut-in of the next speed-regulated compressor at start speed. Afterwards, both compressors will be cut in together and they will run in parallel. The following one-step compressors will be cut in and out in accordance with First-In-First-Out principle in order to equalise operating hours.

Example:

- Two speed-regulated compressors with a nominal capacity of 20 kW and frequency range 25-60 Hz
- Two one-step compressors, each of 20 kW

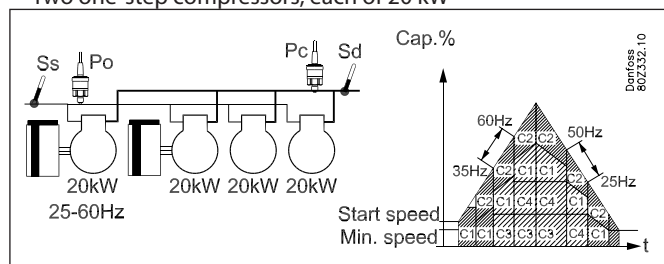

Best fit

During best-fit operations, the speed-regulated compressors can have different sizes and they will be handled in such a way that the best possible capacity adjustment is achieved. The smallest compressor will be started first, then the first will be cut-out and the second compressor will cut in. Finally, both compressors will be cut in together and will run in parallel.

The following one-step compressors will, in every case, be handled in accordance with the best-fit coupling pattern.

Example:

- Two speed-regulated compressors with a nominal capacity of 10 kW and 20 kW respectively
- Frequency range of 25-60 Hz
- Two one-step compressors of 20 and 40 kW respectively

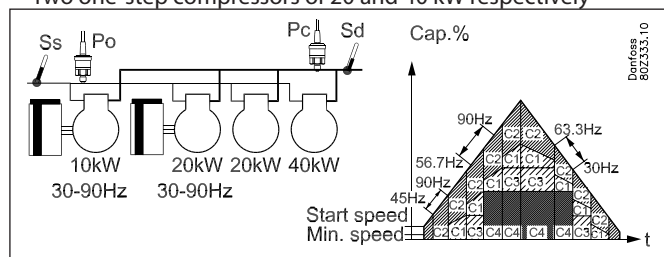

Two independent speed-regulated compressors

If the two speed-regulated compressors need to be controlled asynchronously, they must each have their own analogue voltage signal.

The controller first starts one of the speed-regulated compressors. If more capacity is required, the other speed-regulated compressor is started, and then the single compressors.

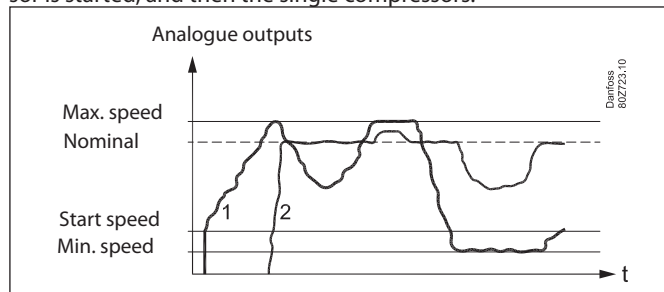

The first is run up to maximum speed. Number two is then activated and run up to nominal speed – and kept there. The speed of number one is reduced at the same time, so the capacity is balanced. All variations are now handled by number one. If number one reaches maximum speed, number two will also be raised. If number one reaches minimum speed, it will be kept there while number two takes over the variation below its nominal speed. When engaging and disengaging, the total hours of operation for the compressors is compared, so they are run an equal number of hours.

Compressor timers

Time delays for cutins and cutouts

To protect the compressor against frequent restarts three time delays can be put in.

- A minimum time to run from a compressor's startup and until it may be restarted.
- A minimum time (ON-time) for the compressor to operate before it may be stopped again.
- A minimum OFF time to run from a compressor stops and until it may be restarted

When unloaders are cut in and out, the time delays will not be used.

Timer

The operating time of a compressor motor is registered continuously. You can read out:

- operating time for the previous 24-hour period
- total operating time since the timer was last set to zero-set.

Equalizing operating hours

Operating hours are also summed in the "Equalization time" field. During cyclical operation, this field is used for equalizing operating hours.

Coupling counter

The number of relay cutins and cutouts is registered continuously. The number of starts can be read out here:

- Number during the previous 24-hour period
- Total number since the counter was last set to zero-set.

Compressor with variable capacity

Digital scroll compressor

The capacity is divided into period times as "PWM per". 100% capacity is delivered when cooling takes place for the whole period. An off time is required by the by-pass valve within the period and an on time is also permitted. There is "no cooling" when the valve is on.

The controller itself calculates the capacity needed and will then vary it according to the cut-in time of the by-pass valve.

A limit is introduced if low capacity is needed so that the cooling does not go below 10%. This is because the compressor can cool itself. This value can be increased if necessary.

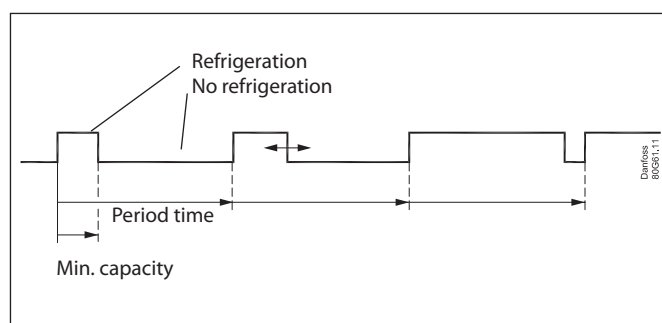

Copeland Stream compressor

The PWM signal can also be used to control one stream compressor with one unloader valve (Stream 4) or one with two unloaders (Stream 6).

Stream 4: The compressor capacity is distributed by up to 50% for one relay and the remaining 50-100% for the unloader.

Stream 6: The compressor capacity is distributed by up to 33% for one relay and the remaining 33-100% for the unloader.

Bitzer CR11 Ecoline

CR11 4: The pulse signal can also be used to control one CR11 with two unloaders (4-cylinder version).

The compressor capacity can be controlled from 10 to 100%, depending on the pulsation of the unloaders. The compressor start signal is connected to a relay output, and the unloaders are connected to solid state output fx DO1 and DO2.

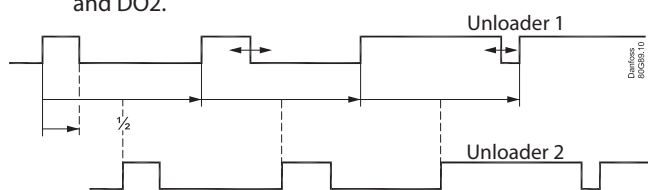

Unloader 2 follows unloader 1, but it remains displaced by a half period.

CR11 6: The pulse signal can also be used to control one CR11 with three unloaders (6-cylinder version).

The compressor signal is connected to one relay output. The two unloaders are connected to solid state output fx DO1 and DO2. The third is connected to a relay output. The compressor capacity can be controlled from 10 to 67%, depending on the pulse of the unloaders. The relay is then connected to the third unloader. When this relay is off, the capacity will be controlled between 33 and 100%.

Individual Sd monitoring

When regulating with Sd monitoring, one of the three compressor types will increase capacity if the temperature nears the Sd limit. This will result in better cooling of the unloaded compressor.

Load shedding

On some installations there is the desire to limit the cut-in compressor capacity so that one can limit the total electrical load in the store for periods.

This limitation can be activated in the following way:

- Via signal from the network
- Via signal on one DI input + signal via the network
- Via signal on two DI inputs + signal via the network

The signal via the network will result in the same function as if the signal were received on DI 1.

For each digital inlet a limit value is attached for the maximum allowable cut-in compressor capacity so that one can carry out the capacity limitation in 2 steps.

When a digital inlet is activated, the maximum allowable compressor capacity is limited to the set limit. This means that if the actual compressor capacity upon activation of the digital inlet is higher than this limit, then so much compressor capacity is cut-out that it will then be on or under the set maximum limit value for this digital inlet.

The threshold value may not be set lower than the compressor's lowest capacity step/"Start speed".

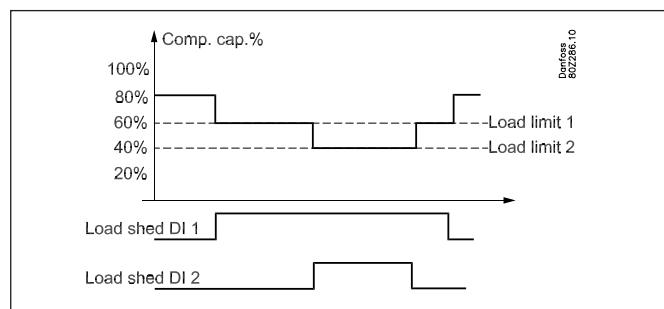

When both load-shedding signals are active, the lowest limit value for the capacity will be the one that is applicable.

Max. time

A max. period with low compressor capacity can be set. When the period expires, the system switches to normal regulation until the suction pressure is once again in place. Load shedding will then be permitted.

Overriding of load shedding:

To avoid load shedding leading to temperature problems for the chilled products, an overriding function is fitted.

A overriding limit is set for the suction pressure as well as a delay time for each digital inlet.

If the suction pressure during load shedding exceeds the set P0 overriding limit and the attached delay times for the two digital inlets expire then load shedding overrides the signals so that the compressor capacity can be increased until the suction pressure is again under the normal reference value. The load shedding can then be activated again.

Alarm:

When a load shedding digital inlet is activated, an alarm will be activated to inform that the normal control has been bypassed. This alarm can however be suppressed if so desired.

Injection signal to heat exchanger control

An injection into the cascade heat exchanger must usually be coordinated with the start-up of the first compressor. AK-PC 781A allows the injection to begin when the controller is ready to run with the first compressor. Depending on system type/design, it will be advantageous to synchronise the injection with the signal "MT comp.release output before start".

The relay output can e.g. be used to control a magnet valve or to signal to a controller. E.g. an EKC 313.

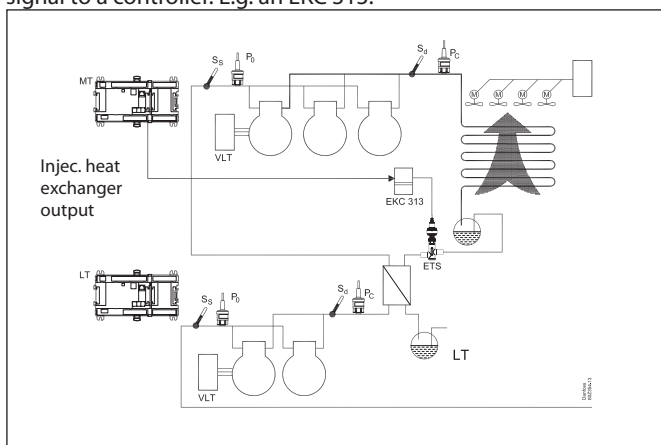

Here an injection signal from the LT controller can be used to request start of MT compressors.

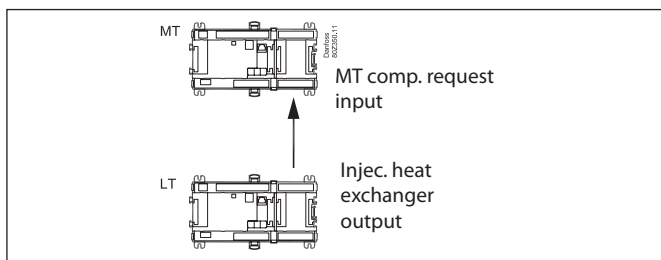

- The LT controller's injection signal is connected to the MT controller's input signal "MT compressor requirement".

When the LT controller starts the first compressor, the injection signal will be activated and thereby request MT compressor start. When any delay in the MT control has expired, the first MT compressor will start.

Sequens

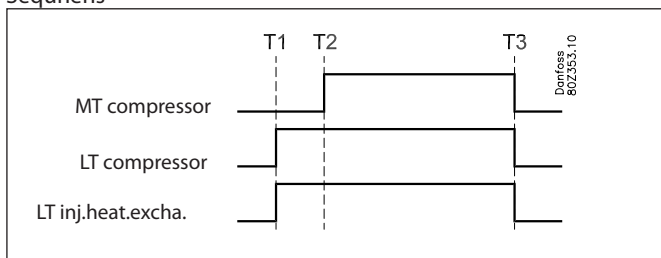

- T1: The load on the LT circuit requires compressor capacity. LT starts compressor and activates injection signal and thereby the input "MT request" on the MT controller.
- T2: First MT compressor starts after expiry of delays.
- T3: Last LT compressor stops which removes the compressor requirement signal and the last MT compressor stops.

Injection ON

The electronic expansion valves in the refrigeration appliances must be closed when all the compressors are prevented from starting. In this way the evaporators will not be filled with liquid which is subsequently passed on to a compressor when regulation is restarted.

One of the compressor control relays may be used for this function, or the function can be obtained via data communication

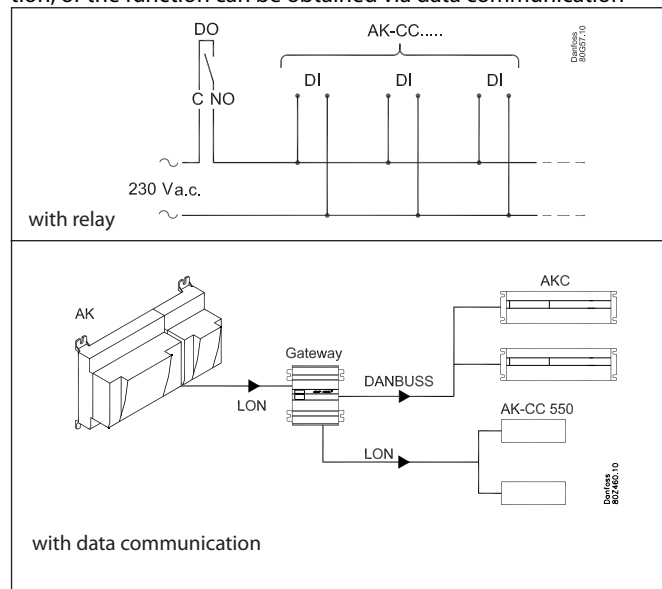

- The function is described based on the sequence of events below:
- T1) The last compressor is cut-out
 - T2) The suction pressure has increased to a value corresponding to $P_o \text{ Ref} + \frac{1}{2} \text{ NZ} + 2 \text{ K}$ but no compressor can start due to re-start timers or safety cut-out
 - T3) The time delay "Injection OFF delay" elapses and the injection valves are forced to close via relay signal or via network signal.
 - T4) The first compressor is now ready to start. The forced closure signal via the network is now cancelled.
 - T5) The time delay "Comp. Start delay" expires and the forced closure signal via the relay switch is cancelled simultaneously with the first compressor being allowed to start.

The reason why the forced closure signal via the network is cancelled before the first compressor starts, is that it will take some time to distribute the signal to all appliance controllers via the network.

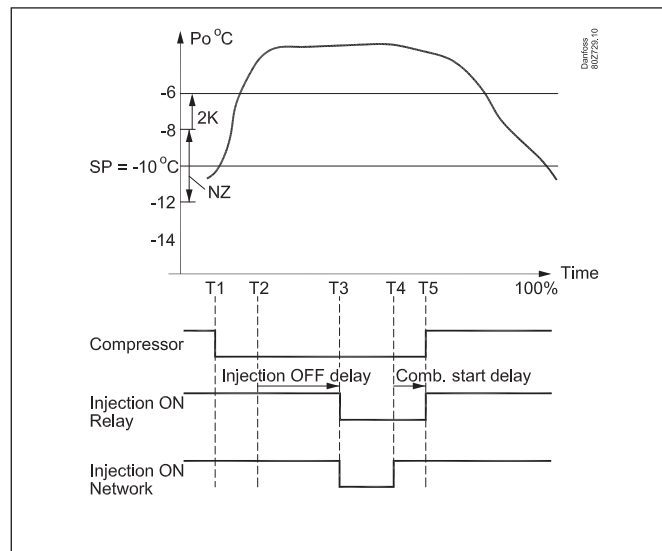

Liquid injection in common suction line

The discharge pressure gas temperature can be kept down by means of liquid injection into the suction line..

- With a thermostatic expansion valve in series with a solenoid valve. The solenoid valve is connected to the controller.

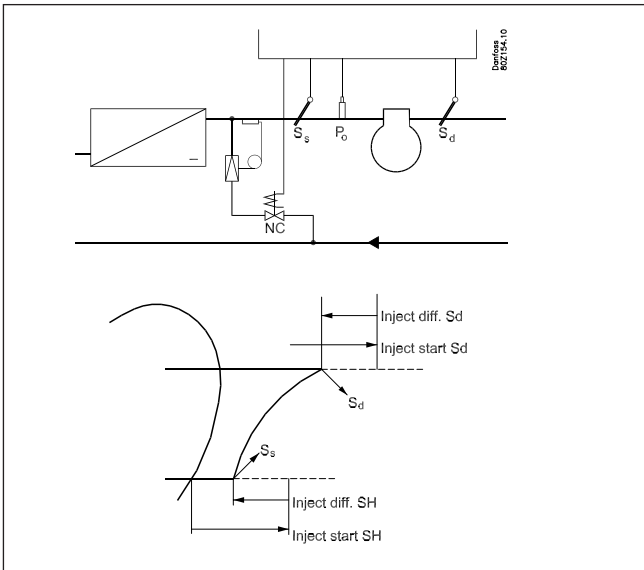

Control can be carried out in two ways:

1. The liquid injection is exclusively controlled on the basis of the superheat in the suction line. Two values are set – a starting value and a differential where the injection is stopped again.
2. The liquid injection is both controlled by the superheat (as described above) and by discharge temperature S_d . Four values are set – two as mentioned above and two for the S_d function, a starting value and a differential. The liquid injection is started when one of the starting values have been passed, and is stopped again when just one of the two functions cuts out.

- Direct using an electrically operated expansion valve of the type AKV

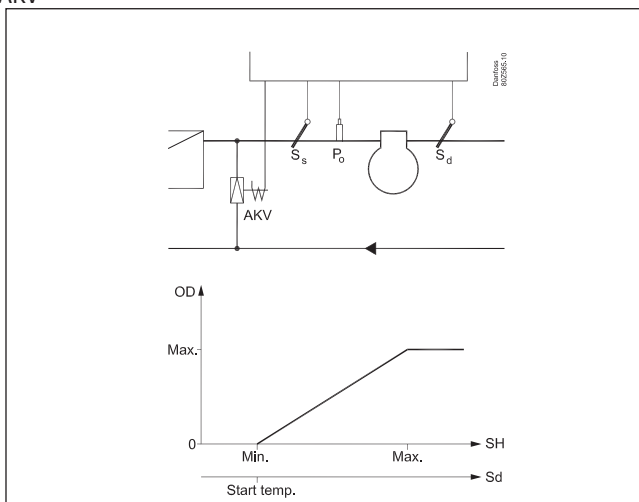

Four values are adjusted -- a start value for the S_d temperature, min. and max. values for overheating and a period time for the AKV valve.

The pulse width modulating signal for the AKV valve shall be taken from one of the controller's four solid state outputs.

Time delay

A time delay can be set which ensures that the injection is delayed during start up.

Safety functions

Signal from the compressor's safety controls

The controller can monitor the status of each compressor's safety circuit. The signal is taken directly from the safety circuit and connected to an input.

(The safety circuit must stop the compressor without involving the controller).

If the safety circuit is cut out the controller will cut out all output relays for the compressor in question and give an alarm. Regulation will continue with the other compressors.

General safety circuit

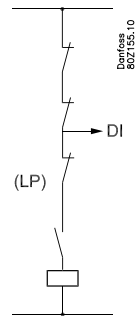

If a low-pressure switch is placed in the safety circuit it must be placed at the end of the circuit. It must not cut out the DI signals. (There is a risk that the regulation will become locked and that it will not start again). This also applies to the example below.

If an alarm is needed which also monitors the low-pressure thermostat, a "general alarm" can be defined (an alarm that does not affect the control). See the following section "General monitoring functions".

Extended safety circuit

Instead of a general monitoring of the safety circuit this monitoring function can be extended. In this way a detailed alarm message is issued which tells you which part of the safety circuit has dropped out.

The sequence of the safety circuit must be established as shown, but not all of them need necessarily be used.

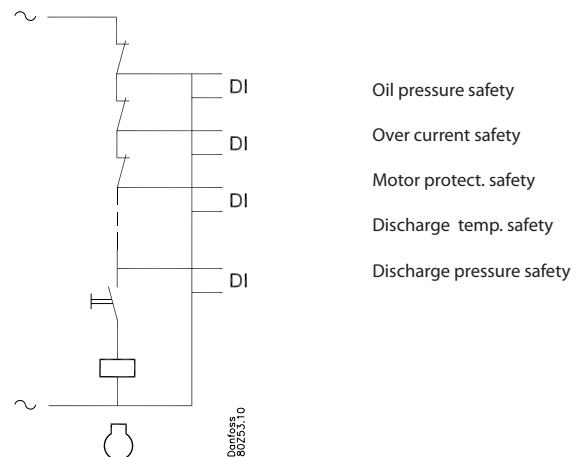

Common safety circuit

A common safety signal can also be received from the whole suction group. All compressors will be cut out when the safety signal cuts out. The function may not be connected to an external main switch.

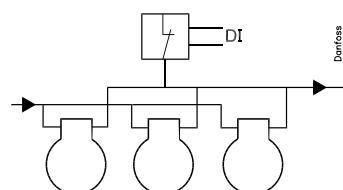

Time delays with safety cut-out:

In connection with safety monitoring of a compressor it is possible to define two delay times:

Cut-out delay time: Delay time from alarm signal from the safety circuit until the compressor outlet cuts out (note that the delay time is common to all security inlets for the compressor concerned)

Safety re-start time: The minimum time a compressor must be OK after a safety cut-out until it may start again.

Monitoring of superheat

This function is an alarm function which continuously receives measured data from suction pressure P0 and suction gas Ss. If superheat is registered which is lower or higher than the set limit values, an alarm will be given when the time delay has passed.

Monitoring of max. discharge gas temperature (Sd)

Common Sd monitoring

The function gradually cuts out compressor steps if the discharge temperature becomes higher than permitted. The cutout limit can be defined in the range from 0 to +195°C.

The function is started at a value that is 10 K below the set value. At this point the entire condenser capacity is cut in at the same time as 25% of the compressor capacity is cut out (but minimum one step). This is repeated every 30 seconds. The alarm function is activated.

If the temperature rises to the set limit value all compressor steps are immediately cut out.

The alarm is cancelled and renewed cutin of compressor steps is permitted when the following conditions are met:

- the temperature has dropped to 10 K below the limit value
 - the time delay prior to restart has been passed. (see later)
- Normal condenser control is permitted again when the temperature has dropped to 10 K below the limit value.

Individual Sd monitoring

The affected compressor will be disconnected here when the temperature exceeds the threshold value.

- The piston compressor will be reconnected when the temperature has dropped 10 K.
- The screw compressor will be reconnected when the temperature has dropped 20 K.
- The capacity of compressors with variable capacity is increased if the temperature is approaching the limit. Once it has been cut out, it will only be connected when the temperature has dropped 10 K.

If signals are also obtained from the embedded NTC sensor, the disconnect value for this temperature will always remain at 130°C and the reconnect value at 120°C.

Monitoring of min. suction pressure (P0)

The function promptly cuts out all compressor steps if the suction pressure becomes lower than the permitted value.

The cutout limit can be defined in the range from -120 to +30°C. The suction is measured with pressure transmitter P0.

At cutout the alarm function is activated:

The alarm is cancelled and renewed cutin of compressor steps is permitted when the following conditions are met:

- the pressure (temperature) is above the cutout limit
- the time delay has elapsed (see later).

Monitoring of max. condensing pressure (Pc)

The function cuts in all condenser steps and cuts out compressor steps one by one if the condensing pressure becomes higher than permitted. The cutout limit is set in bar. The condensing pressure is measured with pressure transmitter Pc_.

The function takes effect at a value which is 3 K below the set value. At this time the entire condenser capacity is cut in at the same time as 33% of the compressor capacity is cut out (but min. one step). This is repeated every 30 seconds. The alarm function is activated.

If the temperature (pressure) rises to the set limit value, the following will happen:

- all compressor steps will immediately be cut out
- the condenser capacity will remain cut in

The alarm will be cancelled and renewed cutin of compressor steps is permitted when the following conditions are met:

- the temperature (pressure) falls to 3 K below the limit value
- the time delay for restart has been passed.

Delay of Pc max alarms

It is possible to delay the "Pc max alarm" message.

The controller will still disconnect the compressors, but the sending of the alarm itself is delayed.

The delay is useful on cascade systems where the max. Pc limit is used to disconnect compressors in the low-pressure circuit if the high-pressure compressors have not started.

Time delay

There is a joint time delay for "Monitoring of max. discharge gas temperature" and "Min. suction pressure".

After a cutout, regulation cannot be recommenced until the time delay has been passed.

The time delay starts when the Sd temperature has again dropped to 10 K below the limit value or P0 has risen above the P0 min. value.

Alarm for too high suction pressure

An alarm limit can be set which will become effective when the suction pressure becomes too high. An alarm will be transmitted when the set time delay has been passed. The regulation continues unchanged.

Oil management

Principle

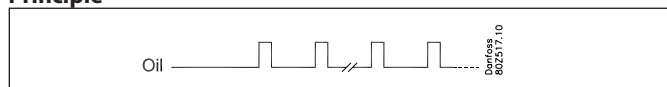

The controller turns on the oil flow for e.g. 1 second. The system then pauses while the oil once again settles. This is repeated a certain number of times, which will be determined by the plant and control principles.

The pulse time, pause time and number of pulses can be adjusted.

The system can be controlled by signal from:

- Level switch on compressor
- Level switch on oil separator
- Level switch on oil receiver
- Pressure transmitter on oil receiver
- In special circumstances the pulse counter can also be used to control, but this is not energy efficient.

Examples of oil circuits

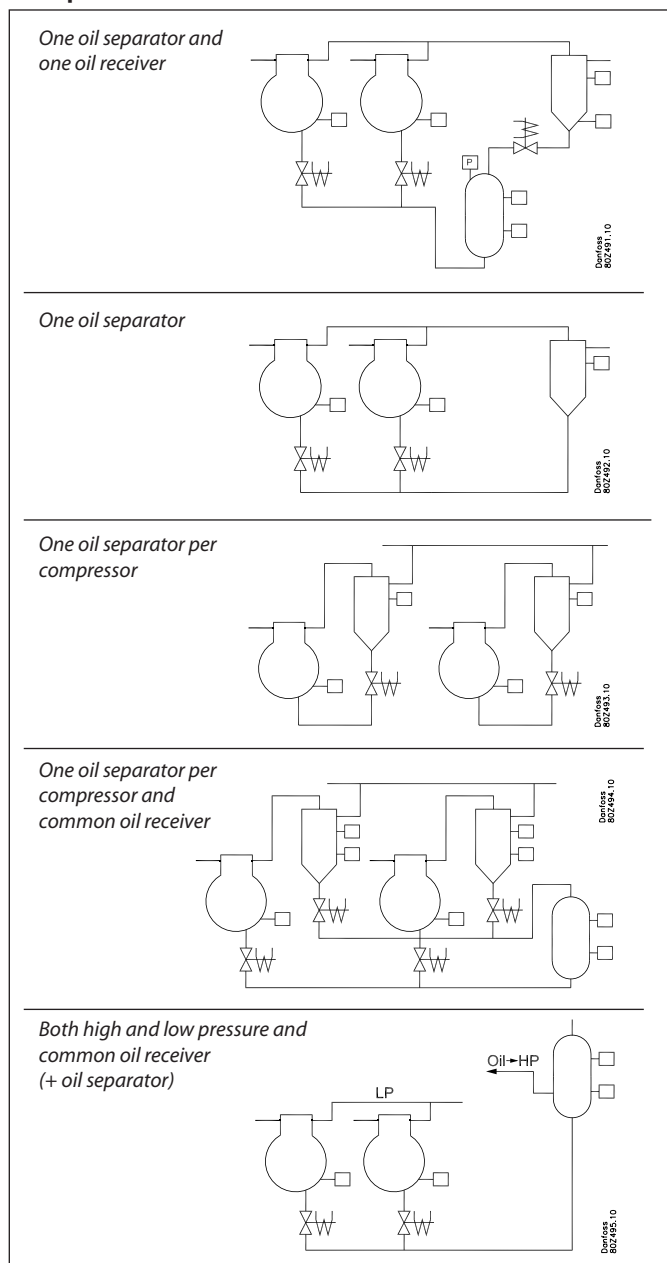

Safety relays

The controller can manage the oil supply to the compressors during normal regulation. However if the compressors are force controlled, this will be done outside the normal regulation. To avoid compressor damages, a safety relay can be incorporated in the control circuit so the controller can cutout the compressor if the oil supply is absent during forced control.

The function "Safety relay" can be selected under setup and wiring should be done as shown.

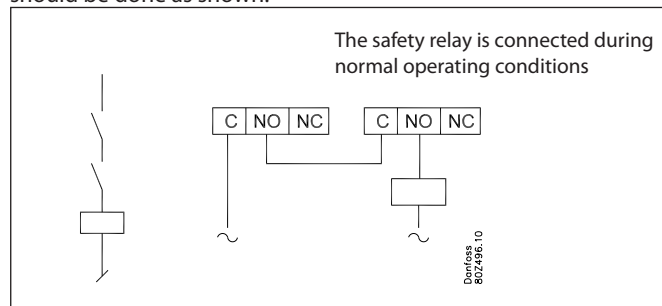

Control principle for compressor

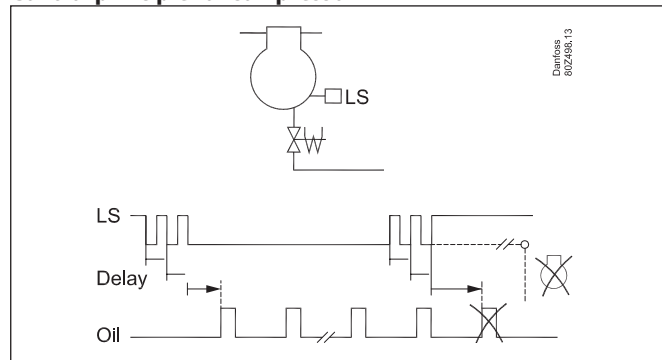

A compressor that is shut down does not receive any oil. When the compressor is in operation, a signal from the compressors oil-level switch is expected. When the signal is given, the following process is carried out:

- Adjustable delay time, re-started in case of chatter.
- Oil injection commences after delay time sequence.
- The solenoid valve follows the pulse process and the oil is injected. Pulse time, period time and the total number of pulses are set for the current plant.
- After the defined number of pulses, the oil injection is stopped again. If the level switch registers a stable oil signal before the sequence of the defined number of pulses finishes, the remaining pulses are omitted.
- If the level switch registers a lack of oil when the last pulse has stopped, the compressor will be shut down and an alarm will be given. If the oil level is deemed to be OK again, the alarm will be cancelled and the compressor can restart. If an OK on oil level is absent, the compressor will stop and can then only be manually started using the reset function.
- Advanced stop. (allows pulses when the compressor is stopped) This function divides the pulse count by two. The compressor will then stop, after which the remaining pulses will be made.

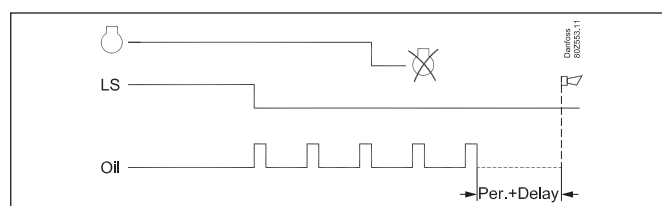

Control principle for emptying the oil separator in the receiver

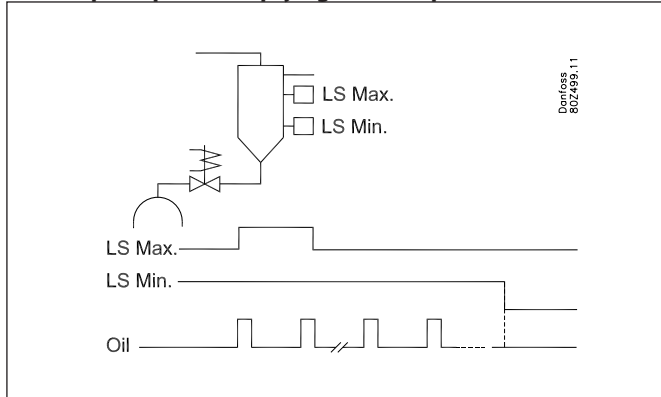

The system can then be controlled by signal(s) from one or two-level switches:

- One-level switch:
 - Full sequence. When the level switch registers oil, the oil is emptied over in the receiver in a user-defined pulse sequence. The system determines the pulse length, period time between pulses and number of pulses.
 - To level. Here a user-defined pulse sequence starts, but the sequence stops immediately once the oil level falls below the level switch.
- Two-level switches
 - Here, the high-level switch will start the pulse sequence, and the low-level switch will stop the pulse sequence.

If the high level switch is still registering oil after the total number of pulses has finished, an alarm is given for high oil level in the separator.

If the low level switch is still registering oil after the total number of pulses is finished, an alarm is given for remaining oil in the separator.

An alarm for signal failure is also given if the high level switch registers oil while a low level switch does not register oil.

If either the high or low level switch is activated in the set time interval, a "no oil separated" alarm is given.

If an oil separator has been fitted for each compressor, it is the level switch in the compressor, that determines the emptying process of oil into the compressor. The level switch in the separator can be used for monitoring.

If "partial shared oil separators" have been fitted, the distribution from compressor 1 and up will be as follows: The order **cannot** be changed but the number of compressors that belong to the individual separators need to be set.

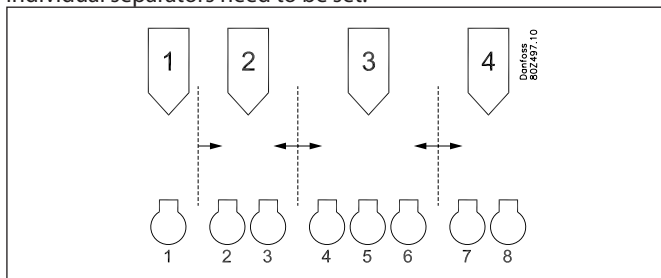

Control principle for pressure in the receiver

Pressostat

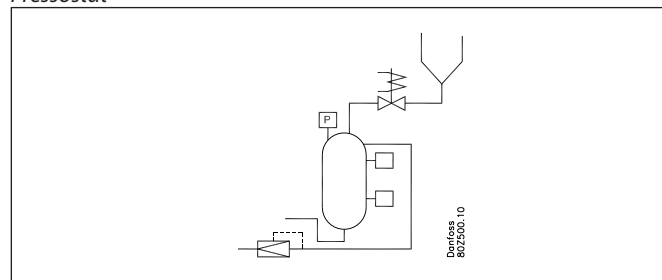

- In the case of lack of pressure difference to fill the MT compressors, the solenoid valve is opened in user defined pulses and the pressure is taken from the oil separator. The pulse length and the period time between the pulses is determined by the system and are the same as those set for the oil separator.
- When the pressure transmitter registers the required pressure, the pulses are stopped.
- Alarm limits and texts for maximum and minimum pressure, respectively, can be set.

Pulse counter

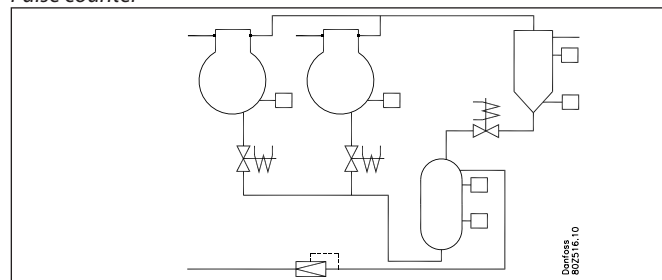

Here, the controller uses a pulse count to determine the pressure build-up in the receiver.

Basis: The controller has counted the number of the set pulses in a period time for all compressors. This value is divided by the number of compressors.

Reading: The controller registers the number of pulses sending oil to the compressors.

Action: When the measured number of pulses reaches a percentage of the basis (factory setting = 50%), the pulse sequence is started from the separator to the receiver.

The function is normally used only with MT compressors, but can also be used in MT+LT operation. This requires, however, an extra extension module, AK-XM 107A, which counts pulses from the LT circuit (the pressostat function is recommended instead).

Level signal

High and low level signals can also be received from the receiver. These signals are only used for monitoring and alarms.

Miscellaneous

All oil valves are closed when the "Main switch" is off.

If you wish to carry out a manual oil injection, this can be done via the function "Manual operation". Here, you can send one or more pulses. The length of the pulse can be set in milliseconds.

If a compressor falls out due to lack of oil, it can be reconnected manually in the plant itself. This can be done via a pulse signal on a defined analogue input. There is one reset and this applies to all compressors. Upon reset, all the counters are reset. It can also be reconnected via the service tool indicated in the "Safety monitoring" picture.

Condenser

Capacity control of the condenser can be accomplished via step regulation or speed control of the fans.

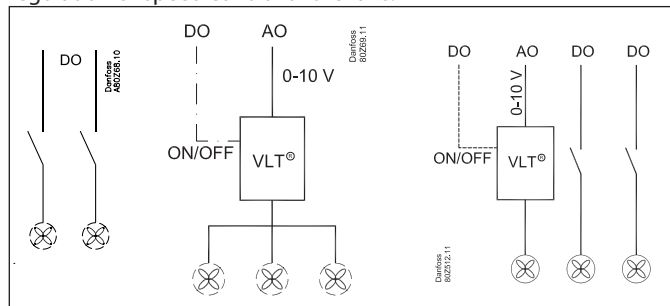

- **Step regulation**
The controller can control up to 8 condenser steps that are cut in and out sequentially.
- **Speed control**
The analog output voltage is connected to a speed control. All fans will now be controlled from 0 to max. capacity. If an ON/OFF signal is required it can be obtained from a relay output. Regulation can be carried out based on one of the following principles:
 - all fans operate at the same speed
 - Only the necessary number of fans is cut in.
 - Combination with one fan speed regulated and the rest step regulated.

Capacity control of condenser

The cut-in condenser capacity is controlled by the condenser pressure's actual value and depends on whether the pressure is rising or falling. Regulation is performed by a PI controller which may however be changed into a P controller if the design of the plant necessitates this.

PI regulation

The controller cuts in capacity in such a way that the deviation between the actual condensing pressure and the reference value becomes as small as possible.

P regulation

The controller cuts in capacity that depends on the deviation between the actual condensing pressure and the reference value. The proportional band X_p indicates the deviation at 100% condenser capacity.

The adjustments are carried out using amplification factor K_p , where $K_p = 100/X_p$.

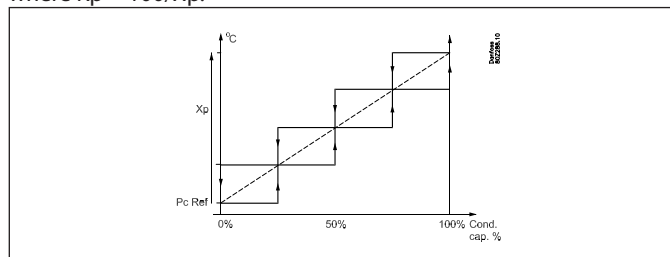

Regulating sensor selection

The capacity distributor can either regulate from the condenser pressure P_c or from the average temperature S_7 . If the refrigerant is CO₂ and transcriticaly regulated, use a temperature sensor S_{gc} , located at the outlet for the gas cooler.

Cap. Ctrl sensor = $P_c / S_7 / S_{gc}$

If the regulation sensor is selected for media temperature S_7 , then P_c is still used as the safety function for high condenser pressure

and will therefore ensure cut-out of the compressor capacity when condenser pressure is too high.

Handling sensor errors:

Cap. Ctrl. Sensor = P_c

If P_c is used as the regulation sensor, an error in the signal will result in condenser capacity being controlled as a function of the connected compressor capacity. The compressor regulation will remain normal.

Cap. Ctrl. Sensor = S_7

If S_7 is used as the regulation sensor, an error in this sensor will result in further regulation that follows the P_c signal, but in accordance with a reference that is 5K over the actual reference. If there is an error on both S_7 and P_c , 100% condenser capacity cuts-in, but the compressor regulation remains normal.

Cap. Ctrl. Sensor = S_{gc}

In the event of failure this sensor switches over to S_{hp} if installed. If S_{hp} cannot provide a signal, the controller switches over to an "emergency cooler sequence" that attempts to maintain regulation.

Reference for condensing pressure

The reference for the regulation can be defined in two ways. Either as a fixed reference or as a reference that varies according to the outdoor temperature.

Fixed reference

The reference for the condensing pressure is set in °C.

Floating reference

This function allows the condensing pressure's reference value to vary within a defined range. The reference varies according to the outdoor temperature and the connected compressor capacity. By combining floating condensing pressure with electronic expansion valves a lot of energy saving can be achieved. The electronic expansion valves enables the controller to decrease the condensing pressure according to outdoor temperature and thereby reduce energy consumption by around 2% for each degree the temperature can be decreased.

The measured outdoor temperature is also used by the controller to optimise the regulation algorithm. The function can be compared to a variable K_p value, which is higher during warm periods and lower during cold periods. There is no setting.

PI regulation

The reference is based on:

- the outdoor temperature measured with S_{c3} sensor
- The minimum temperature difference between the air temperature and the condensing temperature at 0% compressor capacity.
- the condenser's dimensioned temperature difference between the air temperature and the condensing temperature at 100% compressor capacity (Dim tmK)
- how large a part of the compressor capacity has been cut in.

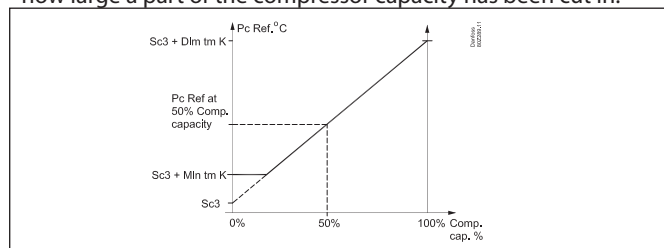

The minimum temperature difference (min t_m) at low load should be set at approximately 6 K as this will eliminate the risk that all fans will be running when no compressors are running. Set the dimensioned difference (dim t_m) at max. load (e.g. 15 K).

The controller will now contribute with a value to the reference which depends on how large a part of the compressor capacity has been cut in.

P-regulation

With P regulation the reference will be three degrees above the measured outdoor temperature. The proportional band X_p indicates the deviation with 100% condenser capacity.

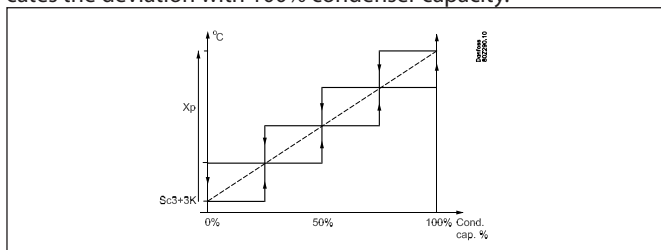

Heat recovery function (for all refrigerants except CO₂. For CO₂ see later section in the condensation description).

The heat recovery function can be used on the installation when you want to make use of warm gas for heating purposes. When the function is activated the reference for the condenser temperature will be raised to a set value and the attached relay outlet is used to activate a solenoid valve. The function can be activated in two ways:

1. A digital input signal is received

In this instance, the heat recovery function is activated via an external signal from, for example a building management system. When the function is activated the reference for the condenser temperature will be raised to a set value and the attached relay outlet is used to activate a solenoid valve.

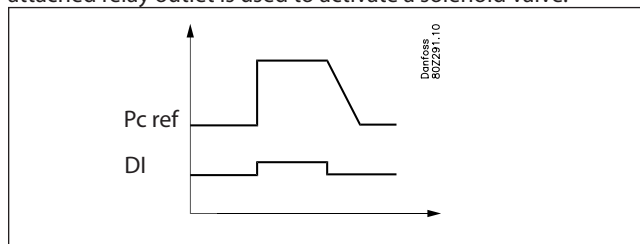

2. Use of a thermostat for the function.

This function can be used with advantage where the heat recovery is used to warm up a water tank. A temperature sensor is used to activate/deactivate the heat recovery function. When the temperature sensor becomes lower than the set cut in limit, the heat recovery function is activated and the reference for the condenser temperature will be raised to a set value and simultaneously the chosen relay outlet is used to activate a solenoid valve which leads the warm gas through the heat exchanger in the water tank. When the temperature in the tank has reached the set value, the heat recovery is cut-out again.

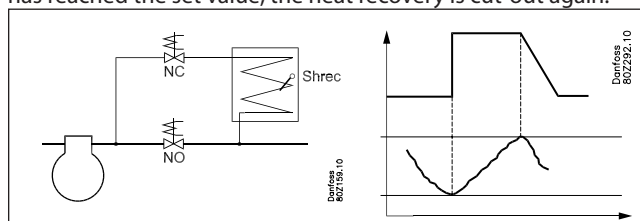

In both cases it applies that when the heat recovery function is de-activated, the reference for the condensing temperature will then decline slowly in accordance with the set rate in Kelvin/minute.

Limitation of the reference

To safeguard yourself against a too high or too low regulation reference, a limitation of the reference must be set.

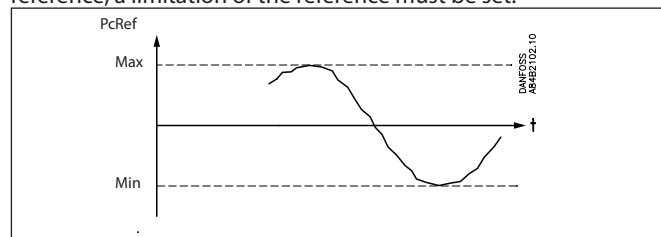

Forced operation of condenser capacity

Forced operation of the capacity can be arranged where the normal regulation is ignored.

The safety functions are cancelled during forced operation.

Forced operation via setting

The regulation is set to Manual.

The capacity is set in percent of the regulated capacity.

Forced operation of relays

If the forced operation is carried out with the switches at the front of an extension module, the safety function will register any exceeding of values and transmit alarms, if required, but the controller cannot cut the relays in or out in this situation.

Capacity distribution

Step regulation

Cut-ins and cutouts are carried out sequentially. The last cut-in unit will be cut out first.

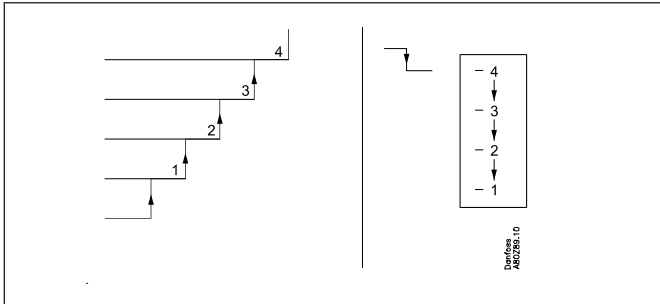

Speed regulation + step regulation

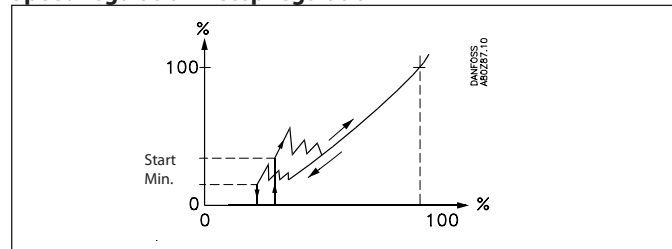

The controller starts the frequency converter and the first fan when the capacity requirement corresponds to the set starting speed.

The controller cuts in several fans step by step as the capacity requirement grows and then adapts the speed to the new situation.

The controller cuts out fans when the capacity requirement becomes lower than the set minimum speed.

Speed regulation

When an analog output is used the fans can be speed regulated, e.g. with a frequency converter type VLT or a EC motor.

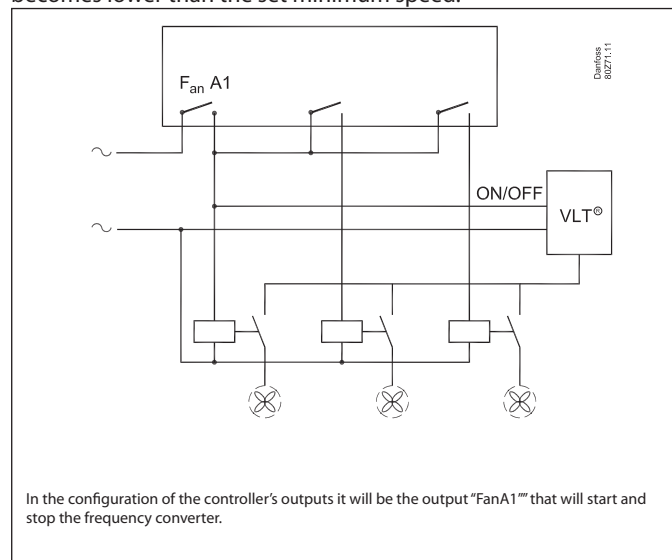
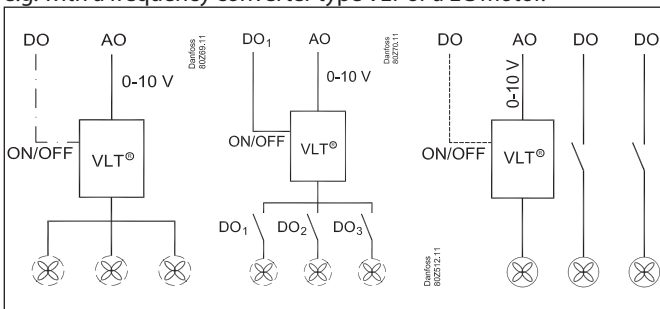

In the configuration of the controller's outputs it will be the output "FanA1" that will start and stop the frequency converter.

Joint speed regulation

The analog output voltage is connected to the speed regulation. All fans will now be regulated from 0 to max. capacity. If an ON/OFF signal is required for the frequency converter, so that the fans can be stopped completely, a relay output can be defined.

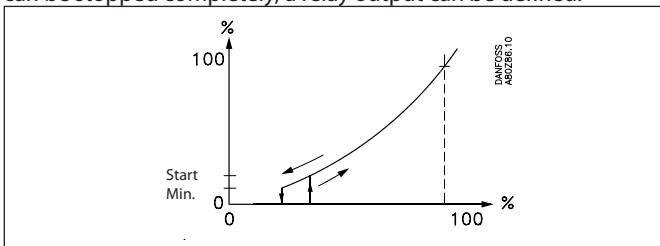

The controller starts the frequency converter when the capacity requirement corresponds to the set starting speed. The controller stops the frequency converter when the capacity requirement becomes lower than the set minimum speed.

Speed regulation of first fan + step regulation of the rest

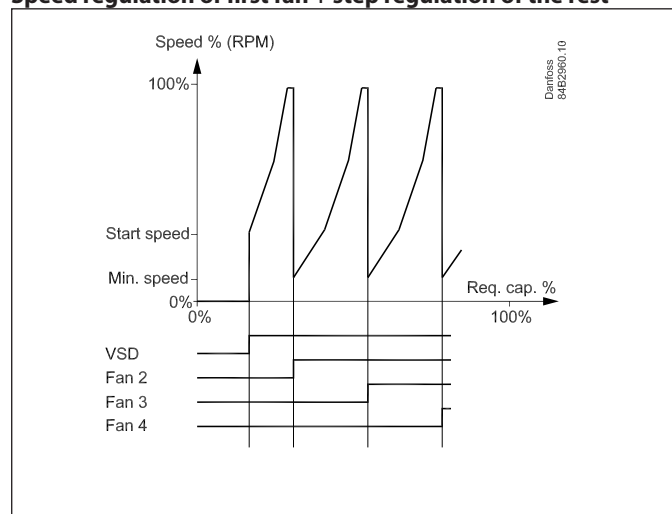

The controller starts the frequency converter and increases the speed of the first fan.

If additional capacity is required, the next fan cuts in at the same time as the first fan switches to minimum speed. From here, the first fan can increase speed again, etc.

Capacity limitation during night operation

The function is used to reduce the noise from the fans to a minimum. It is primarily used in conjunction with a speed control, but it will also be active when steps are cut in and out.

The setting is arranged as a percentage of the max. capacity.

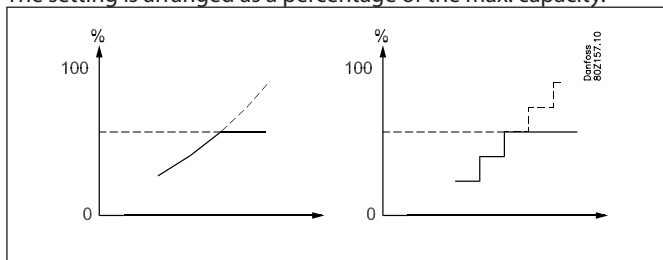

The limitation will be disregarded when safety functions Sd max. and Pc max. take effect.

EC motor

The voltage signal to the EC motor is defined by the following settings:

EC min (0%)

EC max (100%)

EC absolute max. (overcapacity)

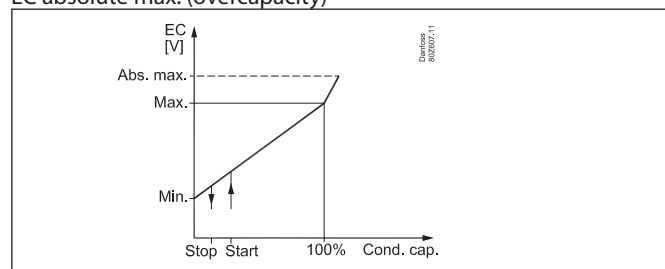

Condenser couplings

Coupling of condenser steps

There are no time delays in connection with cutin and cutout of condenser steps beyond the time delay inherent in the PI/P-regulation.

Timer

The operating time of a fan motor is registered continuously. You can read out:

- operating time for the previous 24-hour period
- total operating time since the timer was last set to zero-set.

Coupling counter

The number of couplings is registered continuously. Here the number of starts can be read out:

- number during the previous 24-hour period
- total number since the counter was last set to zero-set.

Exercising fans

The last fans are unlikely to be activated during winter months. To ensure that the fans are 'exercised' a test will be carried out every 24 hours to check whether all relays have been in operation. The relays that have not been used will now be activated for 5 seconds (from 13:00) but with a pause of 5 min. between individual relays. A speed control is run at "Start speed".

Safety functions for condenser

Signal from fan and frequency converter's safety controls

The controller can receive signals on the status of each individual condenser step's safety circuit.

The signal is obtained directly from the safety circuit and connected to a "DI" input.

If the safety circuit is cut out the controller will give alarm. Regulation continues with the remaining steps.

The ancillary relay outlet is not cut-out. The reason for this is that the fan are often connected in pairs but with one safety circuit. With fault on the one fan, the other will continue to operate.

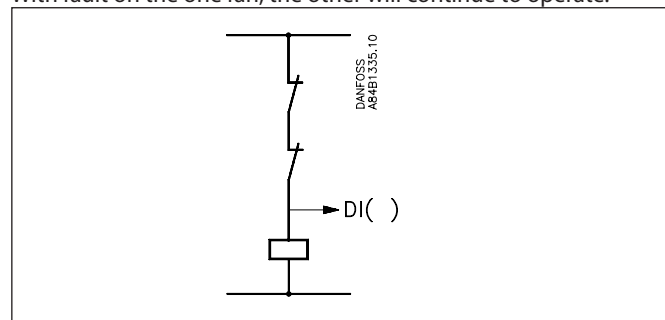

Intelligent fault detection (FDD) on the condenser's air flow

(The function is not active when the selected refrigerant is CO₂). The controller collects measurements from the condenser control and will advise if/when the condenser's capacity is reduced. The most frequent reasons for the information will be:

- gradual accumulation of dirt on the fins
- foreign body in the suction
- fan stop

The function requires a signal from an outdoor temperature sensor (Sc3).

In order to detect accumulation of dirt it is necessary for the monitoring function to be connected to the relevant condenser. This is accomplished by tuning the function when the condenser is clean. The tuning must not be started until the plant has been run in and runs under normal operation conditions.

CO₂ transcritical system and heat recovery

General

When the refrigerant in the system is CO₂, the higher pressure and temperature make it possible to recover heat for tap water and heating. The excess heat is removed using a gas cooler. Regulation is carried out during transcritical and subcritical states and the controller will control the gas pressure/condensing pressure so that the system achieves the optimum COP when the recovered heat is taken into account.

The regulation of the heat recovery circuits is done with regard to the cooling system. In the event of conflict, the safety situation is that the cooling system has higher priority than the recovery circuits.

The two heat recovery circuits can be considered as independent circuits - also with regard to the cooling system.

First, the circuit for hot tap water will take the energy it needs to use. The remaining energy is then available for use by the next circuit. This also takes what is available. If there is then any excess energy this is removed via the gas cooler.

There must be a cooling requirement in order to supply for heat recovery.

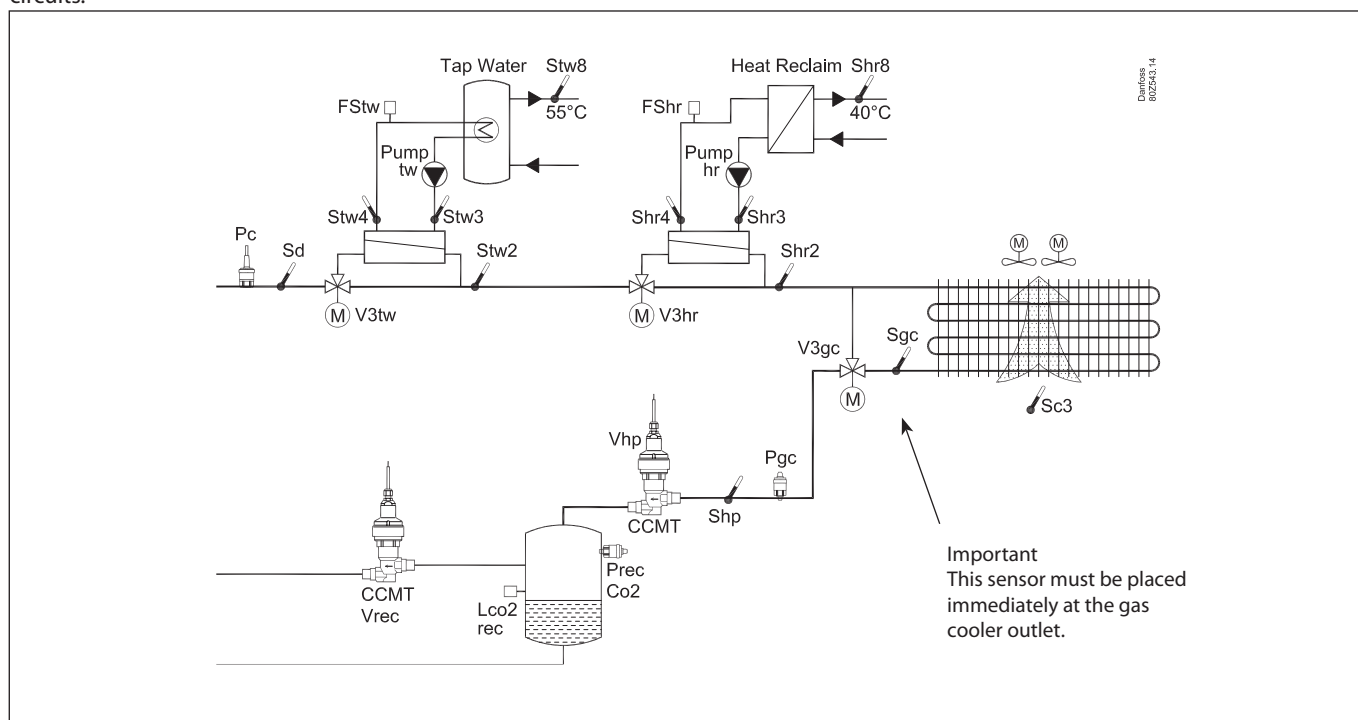

Info

In normal operating conditions, the temperature at Sd will be between 60 and 70°C - depending on whether it is winter or summer. If the "Heat reclaim" function is to raise the condensing pressure, the temperature may increase to 90° or higher.

The Sc3 sensor should be positioned so that it measures the air intake temperature for the gas cooler. If it measures a temperature that is too high, the system's COP will become impaired.

The Sgc signal must be stable. If this cannot be done using a system sensor, it may be necessary to use an immersion tube sensor.

If the power supply to AK-PC 781A or the high pressure valve Vhp fails, the system cannot be controlled. We recommend installing an emergency supply (UPS) for both the controller and the valve to avoid faults. A relay in the UPS should be incorporated into the controller's safety circuit so that it can restart safely.

Remember the isolation amplifier

If signals are received from different controls, e.g. heat recovery for one of the inputs, a galvanically insulated module should be inserted.

There are safety functions for the individual regulation functions, for example:

- Boiling at S3, S4 and S8
- A S3 temperature must be lower than the gas temperature that can be sent into the heat exchanger. If the S3 temperature is higher, the circuit is not connected.

The pump is kept running for a little while before and after the gas valves connect. It can take up to 2 minutes for the gas valve to change position.

Circuit for heat recovery or hot tap water

Application

This regulation can only be carried out when the selected refrigerant is CO₂, which makes it possible to supply hot gas for heating a receiver vessel.

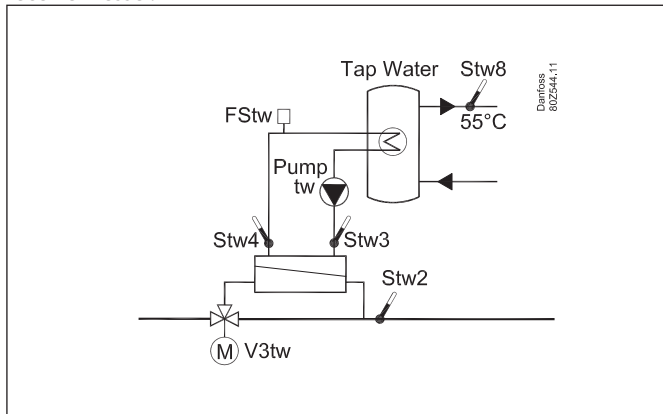

Reference

Regulation is done for a tap water temperature of typically 55°C, where the value is adjustable. A temperature sensor Stw8 is installed in the hot water receiver, and the temperature is held in a band around the adjusted value.

If Stw8 or Stw4 is selected as the controller sensor, the reference can be displaced based on an external 0-10 V signal. 0 V results in no displacement. 10 V results in a displacement indicated by the set value.

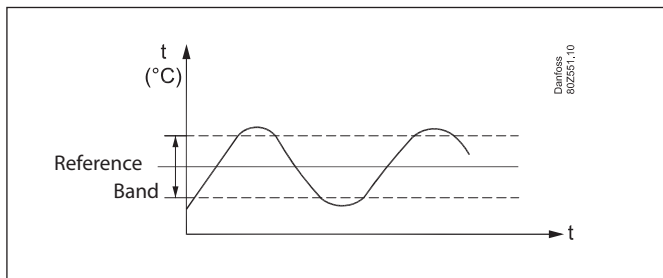

Valve - V3tw

When tap water heating is required, the gas valve changes over and routes the gas in through the heat exchanger. When the temperature goes above the reference plus half the band, the gas will be routed outside of the heat exchanger.

Regulation

Regulation can be done using one of the following principles:

- Only Stw8. The temperature here is regulated using an on/off thermostat. The pump can be controlled on/off or variably.
- Only Stw4. The temperature is regulated using an on/off thermostat. The pump has to be variably controlled.
- Stw4 - Stw3. Here "Delta T" over the heat exchanger is used for regulation. Here the pump must be controlled using variable speed. When the Stw8 temperature has been achieved, the gas is routed outside of the heat exchanger. (With a Delta T controller, the reference cannot be displaced using an external signal.)
- Stw8 and Stw8a. Here regulation is done using the two temperature sensors in the receiver. Stw8 is placed at the top and Stw8a further down.

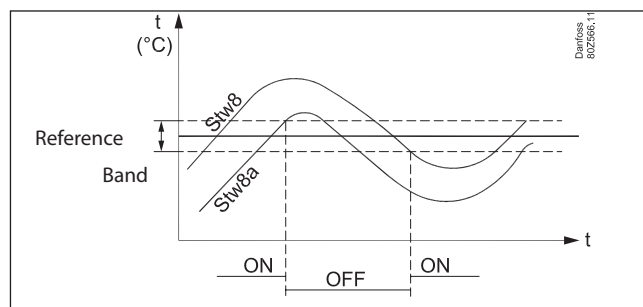

The pump is controlled via on/off and is connected when Stw8 is below the reference plus half the difference. It is disconnected when Stw8a is above the reference plus half the difference.

The pump - Pump tw

It is recommended to use a pump with variable speed, so that the regulation flows and does not display great fluctuations in the condensing pressure.

Flow switch - FStw

A flow switch should be installed for safety reasons, in case of pump failure. The controller will then disconnect the entire recovery circuit.

Sensors - Stw2, Stw3, Stw4 and Stw8

All sensors must be installed due to safety reasons:

- Stw2: The controller must know the temperature of the gas that is sent for condensation
- Stw3: Heat exchanger cold access. Used for temperature regulation
- Stw4: Heat exchanger hot outlet. Used for temperature regulation
- Stw8: Receiver temperature and in relation to the reference.

Circuit for recovery for heating

Application

This regulation can only be carried out when the selected refrigerant is CO₂, which makes it possible to supply hot gas for heating a receiver vessel.

Regulation can be carried out using one of the following three principles, when the circuit calls for heat:

- 1. Basic control (no HP offset).
- 2. Offset of the condensing pressure (HP offset)
- 3. Offset and regulation of the gas cooler and pump (max. hr)

Generally, for all three principles:

Valve - V3hr

When heating of the circuit is required, the gas valve will change over and route the gas in through the heat exchanger.

When the temperature goes above the reference plus half the band, the gas will be routed outside of the heat exchanger.

Pump - Pump hr

It is recommended to use a pump with variable speed, so that the regulation flows and does not display great fluctuations in the condensation pressure.

Flow switch - FShr

A flow switch should be installed for safety reasons, in case of pump failure. The controller will then disconnect the entire recovery circuit.

Sensors - Shr2, Shr3, Shr4 and Shr8 (Stw2/Sd)

All sensors must be installed due to safety reasons:

Shr2: The controller must know the temperature of the gas that is sent for condensation.

Shr3: Heat exchanger cold access. Used for temperature regulation

Shr4: Heat exchanger hot outlet Used for temperature regulation

Shr8: Receiver temperature and in relation to the reference.

Stw2 or Sd: The regulation must know the temperature of the gas that is sent into the heat exchanger.

1. Basic control (no HP offset).

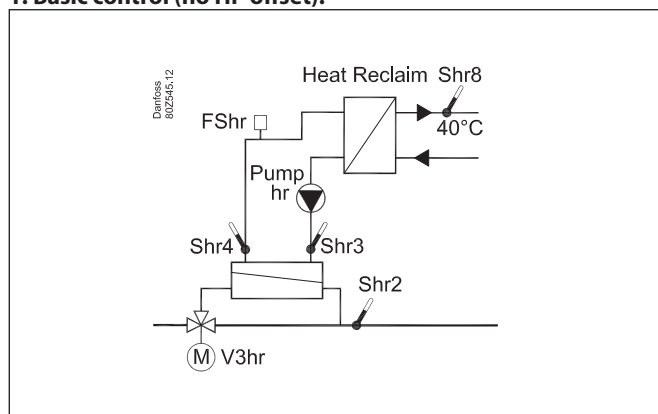

Reference

Regulation is done using a receiver temperature of e.g. 40°C, the value is adjustable. A temperature sensor Shr8 is installed in the receiver, and the temperature is maintained in a band around the selected value.

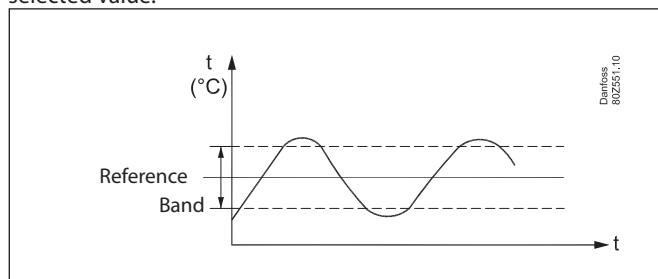

When the temperature goes above the reference plus half the band, the gas will be routed outside of the heat exchanger.

The reference can be displaced variably using an external 0-10 V signal. 0 V results in no displacement. 10 V results in a displacement indicated by the set value.

Regulation

The following can be used as a regulation sensor:

- Shr8
- Shr4
- Delta T via heat exchanger (Shr4-Shr3) of e.g. 4K, but still using Shr8 as a reference.

The pump can be controlled on/off or variably. For Shr4 or Delta T regulation it must be controlled variably. During variable operation the pump will stop when the regulation desires a lower capacity than the selected min. speed capacity for the pump.

2. Offset of the condensing pressure

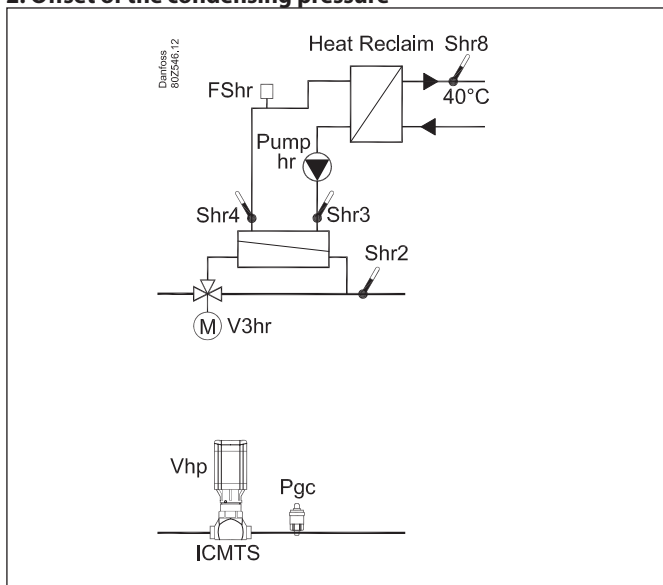

Reference

Regulation is done using a heat exchanger temperature/receiver temperature of e.g. 40°C, the value is adjustable. A temperature sensor Shr is installed in the receiver and the temperature is maintained in a band around the selected value.

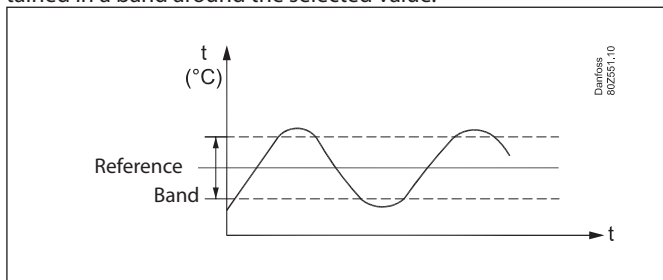

When the temperature goes above the reference plus the half band, the gas is routed around the heat exchanger. The reference can be displaced variably using an external 0-10 V signal. 0 V results in no displacement. 10 V results in a displacement indicated by the set value.

Regulation

The following can be used as a regulation sensor:

- Shr8
- Shr4
- Delta T via the heat exchanger (Shr4-Shr3) of e.g. 4K, but still using Shr8 as the thermostat sensor.

The pump can be controlled on/off or variably. For Shr4 or DeltaT regulation it **must** be variably controlled. During variable operation the pump will stop when the regulation request a lower capacity than the selected min. speed capacity for the pump. .

Increasing the condensing pressure

When the temperature is below the reference and heat recovery is carried out, the condensation pressure may be increased. The pressure is measured using the pressure transmitter Pgc and the controller at the valve Vhp. How much the pressure shall be increased by is determined using a setting and an analogue voltage signal. The signal must be a 0-10 V signal or a 0-5 V signal.

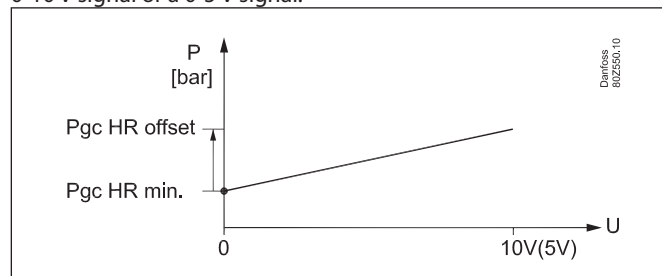

During heat recovery and a signal of 0 V, the pressure is increased to "Pgc HR min."

At max. signal (e.g. 10 V) the pressure will increase according to the setting "Pgc HR offset".

Up to 5 signals can be received from external regulations. They can all increase the pressure, and the controller will use the signal that requires the largest offset. The signal employed is filtered over a time period. The length of the period can be set.

Relay output

A relay can be reserved that will pull in if the received signal exceeds 9.5 V (4.75 V) for more than 10 minutes. The relay is defined in the function: "Additional heat output".

Remember the isolation amplifier

If signals are received from different controls, e.g. heat recovery for one of the inputs, a galvanically insulated module should be inserted.

3. Offset and regulation of the gas cooler and pump (max. heat recovery)

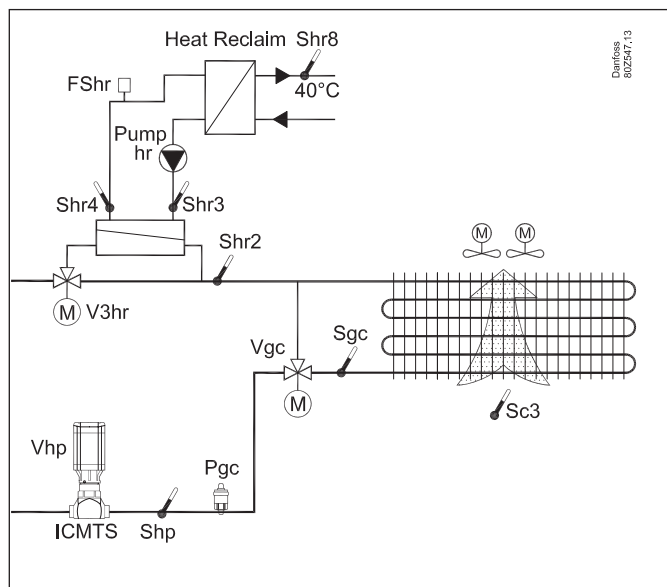

Reference

Regulation is done using a heat exchanger temperature/receiver temperature of e.g. 40°C, the value is adjustable. A temperature sensor Shr is installed in the receiver, and the pump speed is controlled so that the temperature is kept to the set value. The controller does not start until a signal has been received from the external controller and the signal has started the pump. If Shr8 or Shr4 is selected as the controller sensor, the reference can be displaced based on an external 0-10 V signal. 0 V results in no displacement. 10 V results in a displacement indicated by the set value.

Regulation

The following can be used as a regulation sensor:

- Shr8
- Shr4
- Delta T via heat exchanger (Shr4-Shr3) of e.g. 4K. (With a Delta T controller, the reference cannot be displaced using an external signal.)

The pump can be controlled on/off or variably (recommended). For Shr4 or Delta T regulation it **must** be controlled variably. During variable operation the pump will stop when the regulation require a lower capacity than the selected min. speed capacity for the pump.

Increasing the condensation pressure

The external controller will emit a signal between 0 and 10 V (0-5 V), which the controller will use to start the following functions in order to achieve maximum heat recovery:

1. Signal on DI input for heat recovery is received
2. The pressure Pgc is increased to Pgc HR min.
3. The external voltage signal is registered (the higher the value, the greater the need for heat).
The signal must be a 0-10 V signal or a 0-5 V signal. The signal is converted by the controller to 0-100% capacity and will have the following impact:
 - a. Control of the pump
The pump is released to operation. The valve is coupled up.
 - b. Pressure increase
The pressure is measured using the pressure transmitter Pgc and the controller at the valve Vhp. If necessary, the pressure will be kept at a value between Pgc HR min. and Pg HR offset.

c. Fan control

The fan's capacity is tuned down so the temperature is increased. The temperature is measured with Sgc. If necessary, the temperature reference will not be increased to the value Max. Cond. Ref. Offset. At this value, the fans will stop completely.

d. Disconnect the gas cooler

The valve V3gc routes the gas outside the gas cooler and the sensor Shp now registers the temperature instead of Sgc. (If the controller has had the gas cooler disconnected, a timer function will start when the system switches over once again to gas cooler operation. The timer function will keep the regulation in gas cooler mode for 3,600 seconds, until a disconnection is permitted again.)

The "Heat recovery status" picture shows the current regulation status.

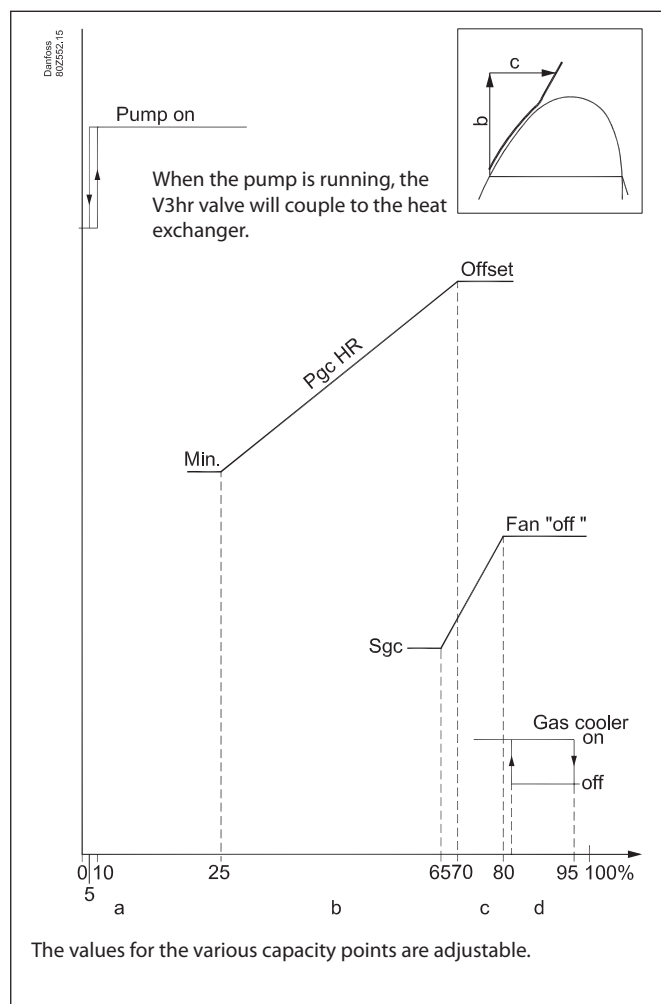

Up to 5 signals can be received from external regulations. The controller will use the signal that requires the most capacity. The signal employed is filtered over a time period. The length of the period can be set.

Relay output

A relay can be reserved that will pull in if the received signal exceeds 9.5 V (4.75 V) for more than 10 minutes. The relay is defined in the function: "Additional heat output".

Circuits for control of CO2 gas pressure

Application

The function can be used in systems with transcritical and subcritical cooling control systems where CO2 is used as a refrigerant. The controller regulates the pressure in the gas cooler (condenser) so that the system achieves the optimal COP.

The controller will always optimise to a subcritical state.

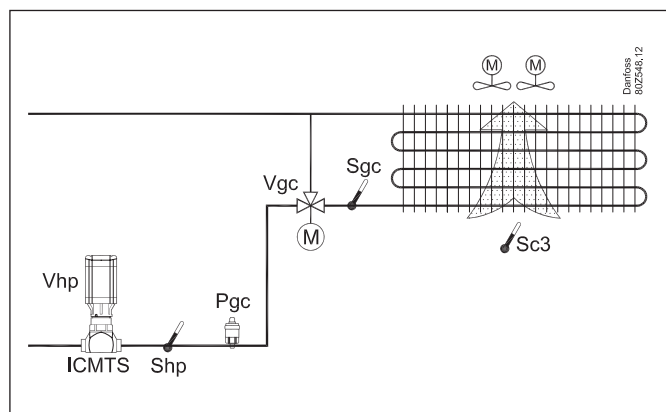

The pressure in the gas cooler is controlled by the valve.

Instead of an ICMTS valve, a CCMT valve with stepper motor can be used.

Regulation must have inputs from both a pressure transmitter Pgc and a temperature sensor Sgc. Both must be fitted in the outlet immediately after the gas cooler. If the gas can be routed outside of the gas cooler, a Shp sensor **must** be installed. Should the Shp sensor record too high a temperature, the gases will be routed through the gas cooler once again.

The valve is an ICMTS valve, which has been specially developed for the pressure conditions that exist in a transcritical CO2 system. The motor section of the valve is an ICAD actuator and is controlled by a 0-10 V signal from the controller.

The valve's degree of opening can be restricted both at the closing point and in the entire open point.

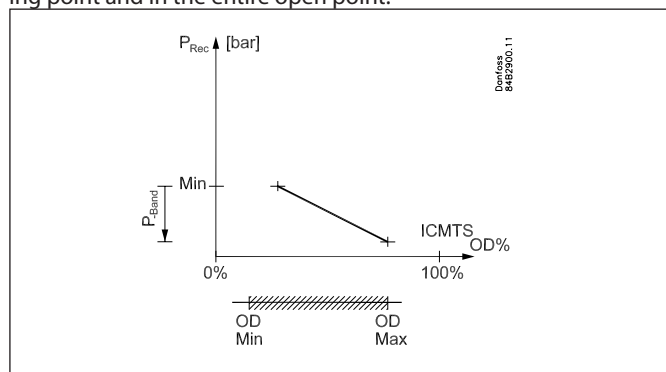

The settings OD Min. and OD max. are adjusted as % of the degree of opening and will restrict the voltage signal for the valve.

Maximum COP control

During normal operation without override, the controller will maintain the optimum pressure in the transcritical area.

Overview

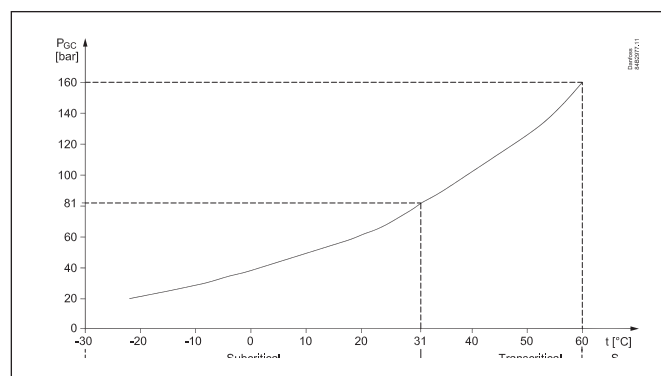
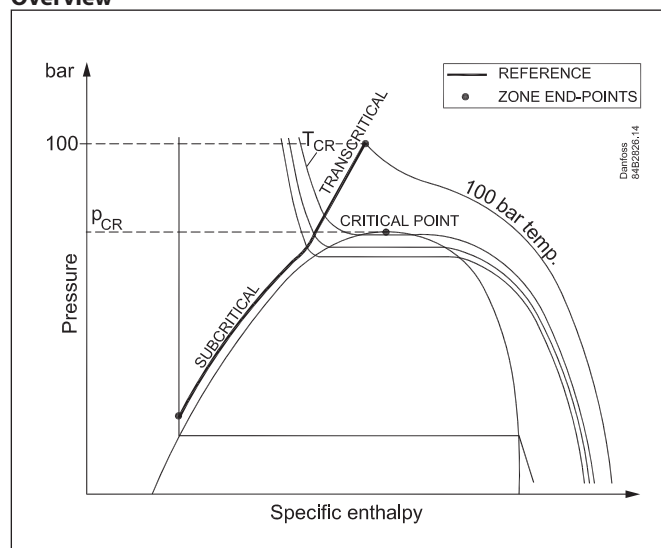

Reference curve

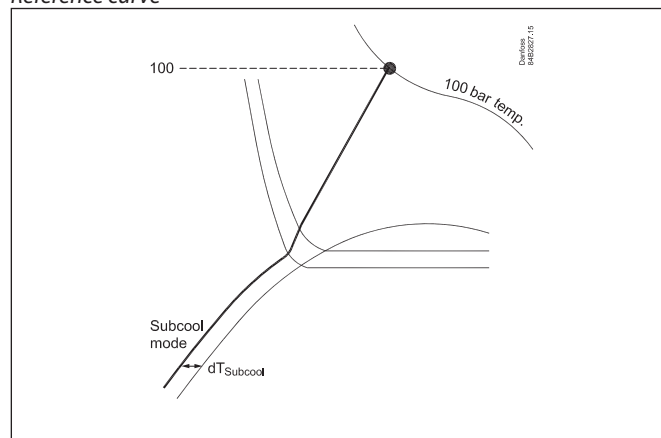

The controller is pre-programmed to follow the optimal COP from the pressure/enthalpy chart. The top point is defined at 100 bar, 39°C. (Optimal theoretical COP is achieved at the curve that passes through 100 bar and 39°C. The point of intersection can be changed by setting a value other than the default).

Regulation will now follow the set reference curve, but will never go above the set permitted max. pressure for the gas cooler.

The current reference can be read from the controller's overview screen.

Subcooling

Subcooling can be used in the subcritical range.

Extra refrigeration capacity ("extra compressor")

This function improves the system's refrigeration capacity by increasing the pressure in the gas cooler. The function will start when the compressor capacity has been at 100% for 5 minutes. The cooling performance increases to Q_0+d_h0 .

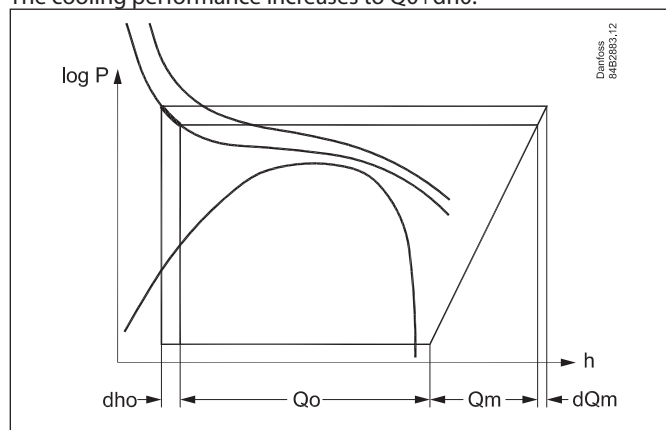

The function also increases the load on the compressor motor as pressure increases. Power consumption increases to Q_m+dQ_m .

Start-up at a very low temperature

It will be necessary to route the gas outside of the gas cooler if the gas temperature is too low.

Temperature limits are set under the function **"Bypass low limit"**. When the function is active, the gas temperature is measured by the Shp sensor. When the sensor records a value that is 5K higher than the set value, it will switch back again so that the gas is routed through the gas cooler. The switch will only take place after the pre-set delay time **"Bypass permitted after"** has passed.

Warning

Remember that the controller controls the gas pressure. If the regulation is stopped by the internal or external main switch, this control will stop as well.

Risk of loss of charge.

If the compressors are stopped via the function "External compressor stop", control of the gas pressure will continue.

Increasing pressure reference with heat recovery

The function will increase the gas pressure reference to the P_{gc} HR Min. value when it receives a signal.

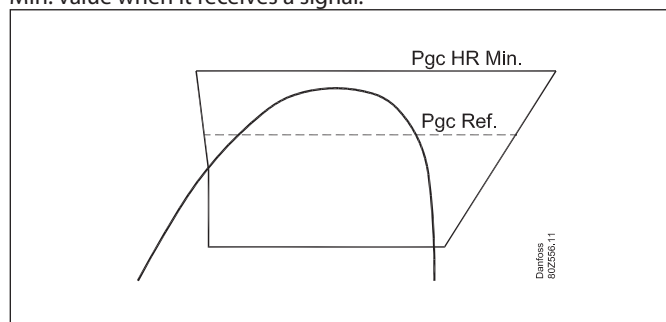

The function is activated by signal from the heat recovery

Increasing pressure reference with heat recovery, variable reference

The function will increase the gas pressure reference to the value where it receives a signal.

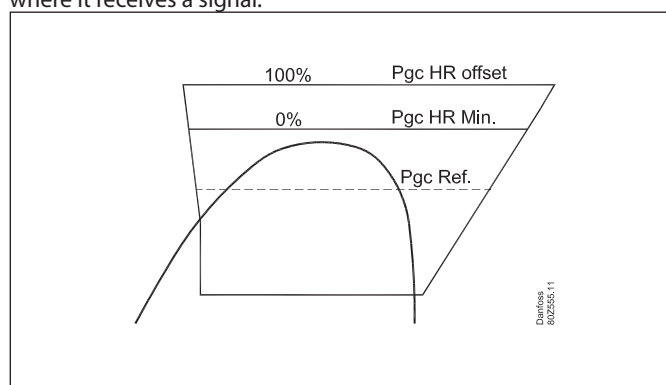

The function is activated by a signal from the heat recovery.

- From ON at 0%: Here the reference is changed to "Pgc HR Min."
- To ON at 100%: Here the reference will increase further using the setting "Pgc HR offset".
- Between 0 and 100% the reference is variable.

Receiver control

The receiver pressure can be controlled so that it is kept at a set reference point. This control requires the installation of an CCM valve a (ETS valve) and a pressure transmitter. It is possible to regulate using two parallel valves.

If only monitoring and not control is required, the valve should not be installed. Install the pressure transmitter only.

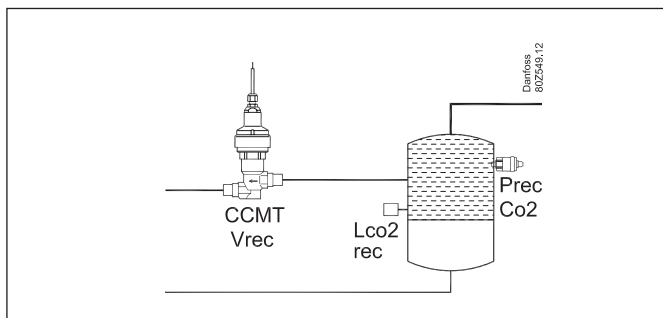

There are two safety functions for the receiver. They are only available for gas-cooled regulation.

A P-belt must be installed to be able to regulate the function, but both are standard set to zero, which makes the function inactive.

Receiver pressure's max. limit

Set a max. receiver pressure that will typically be the maximum receiver pressure. If the controller records that the receiver pressure slips into the P-band, shutdown of the high-pressure valve Vhp commences. The opening degree will be linear through the p-band so that the Vhp will be totally closed by pressing 'set max. receiver pressure' (A complete shutdown assumes that the configuration for the high-pressure valve - "Min. OD%" is set to 0%)

Receiver pressure's min. limit:

A minimum receiver pressure limit can be set. If the controller register receiver pressure below the set value, the ICMTS valve will be opened. The opening degree will be linear through the p-band, and the maximum permitted opening degree of the ICMTS will be present by pressing 'set min. receiver pressure' minus 'set-p-band'. If the setting of the valve's opening degree is limited and it cannot be fully opened, the set opening degree value will be at the pressure 'set min. receiver pressure' minus 'set p-band'.

Hot gas dump

The controller has a function that can turn on the hot gas to the receiver if the pressure becomes lower than the set value. The hot gas will shut off again when the pressure exceeds the difference.

Stop of compressors

If the compressors are stopped via the function "External compressor stop", the reference for the receiver control will be to the setting "Max. receiver pressure".

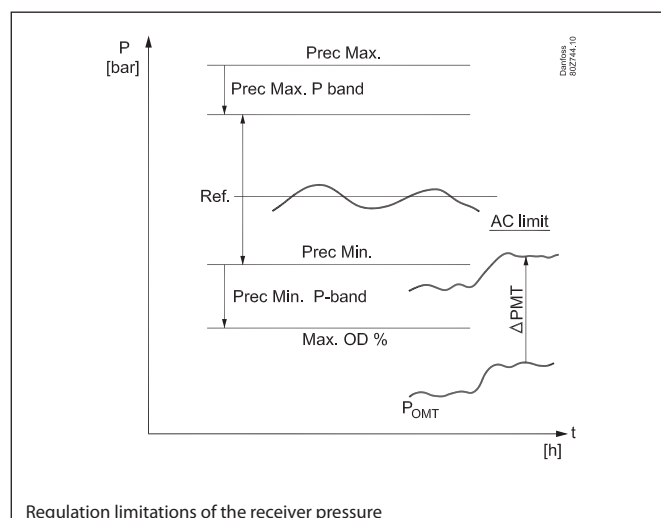

Regulation limitations of the receiver pressure

Note

The PI regulation of the receiver pressure must have space to regulate without restrictions.

This means that there should be sufficient space for the PI regulation to move around the reference, i.e. at least 2-3 bars – both over and below the reference.

The value is very dependent on the tuning of the PI regulation and the system dynamics.

An example may be a 40-bar plant in which the receiver's reference pressure is set to 35 bars. Here the system can interfere with normal regulation because the high pressure limit is very stringent.

COP optimisation

As a transition to this receiver control, a separate compressor control can be installed, which will optimise COP via parallel compression.

This function is described on the next page.

Parallel compression

Principle

On transcritical systems installed in slightly warmer surroundings than normal, the COP will be significantly improved by using parallel compression.

One or more compressors are used to help maintain the receiver pressure during warm periods when the outdoor temperature becomes high — primarily during the summer months.

The ordinary capacity regulation is carried out by two AK-PC 781A units. One is for low temperature regulation (LT), and the other is for medium temperature regulation (MT). MT regulation also controls the entire condenser circuit, with heat recovery, gas cooling and receiver pressure.

The parallel compression (intermediate temperature, 'IT') is controlled by the third AK-PC 781A. It receives signals from two pressure transmitters and from the controller on the MT circuit, and it will start the compressor as needed, so that the receiver pressure is kept at the desired level. The compressor capacity will be variable, and the controller will emit a 0-10 V signal that indicates the desired capacity.

The function is activated by the MT controller, which regularly records the opening degree of the Vrec valve. When the opening degree is greater than the set value, the MT controller will pull a relay. This signal is recorded by the IT controller, which starts the IT compressor. The controller will now speed-regulate the IT compressor so that the pressure in the receiver is kept at the desired level.

When the IT compressor is running, the IT controller will pull a relay. This is recorded by the MT controller, which then closes the Vrec valve.

The reference for the receiver pressure is raised to the max. when the IT compressor is running.

When the IT capacity's need drops to min. capacity, the compressor will stop, the signal (IT relay) to the MT controller will disappear, and the MT controller will assume pressure control of the receiver by regulation of the Vrec valve.

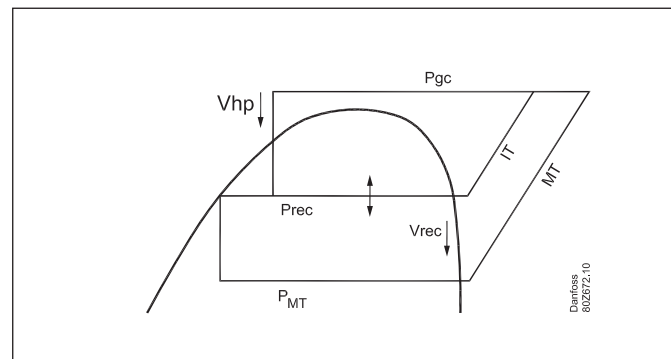
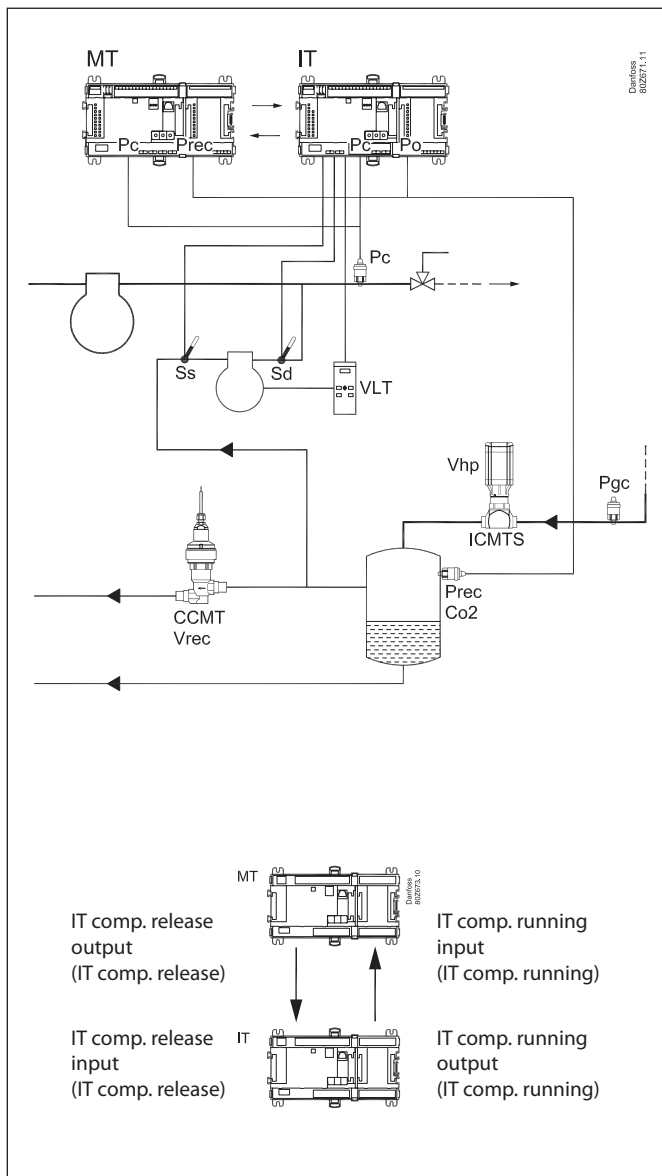

Settings in MT controller

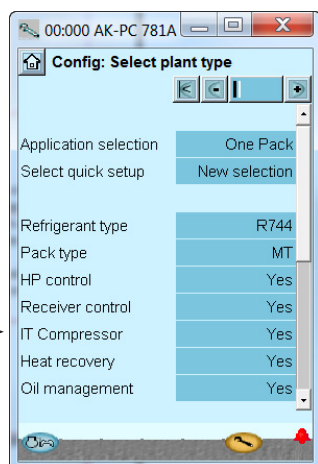

Initiates coordination with the IT controller.
 - Relay output, which emits signals.
 - DI input, which receives signals when the IT compressor is running.

Settings in IT controller

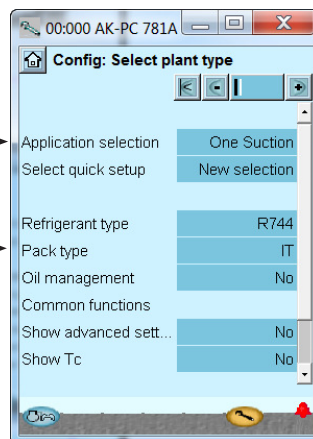

Select suction group
 Select IT
 Select IT compressor
 From where the coordination with the MT controller is initiated.
 - DI input, which receives signals when the IT compressor is to begin.
 - Relay output, which emits signals when the compressor is running.

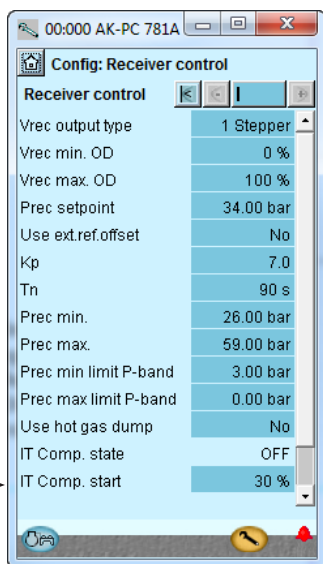

The Vrec valve's opening degree when the parallel compression is to start.
 The start signal is first emitted when the opening degree is higher during the entire delay period.
 The function will not come into effect if Sgc detects a temperature that is lower than the set value.

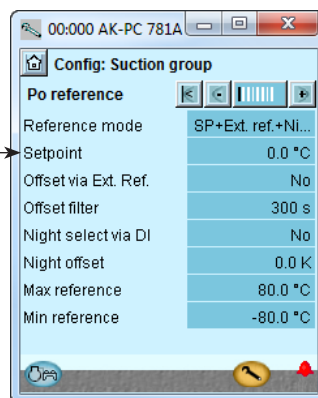

The reference in the IT controller is set in °C.
 (The receiver pressure is set in relative bar.)

Receiver pressure [bar relativ]	Po Ref [°C]
34	0
35	1
36	2
37	3
38	4
39	5
40	6
41	7
42	8

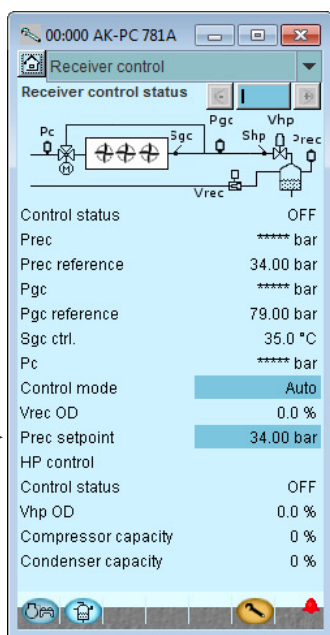

The reference for the receiver pressure is set in relative bar.
 (The "IT comp. state" read-out is the signal received from the IT controller.)

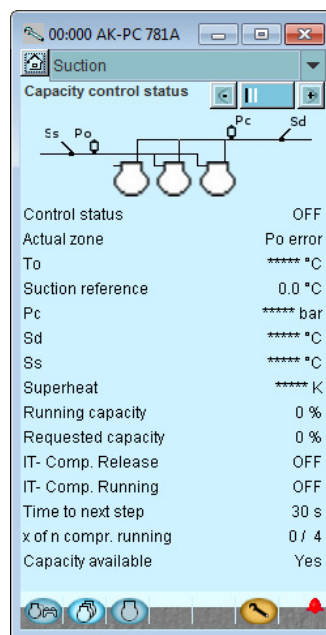

The receiver pressure, Prec, must be connected to the Po input on the IT controller.

← Signal from MT
 ← Signal to MT

General monitoring functions

General alarm inputs (10 units)

An input can be used for monitoring an external signal.

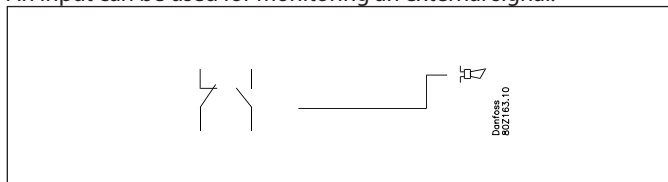

The individual signal can be adapted to the relevant use as it is possible to give the alarm function a name and to indicate your own alarm text.

A time delay can be set for the alarm.

General thermostat functions (5 units)

The function may freely be used for alarm monitoring of the plant temperatures or for ON/OFF thermostat control. An example could be thermostat control of the fan in the compressor compartment.

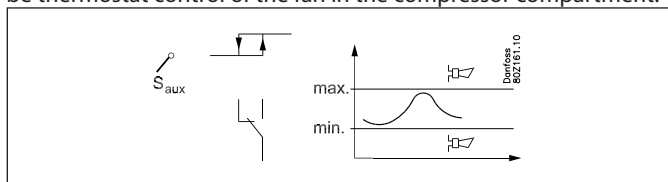

The thermostat can either use one of the sensors used by the regulation (Ss, Sd, Sc3) or an independent sensor (Saux1, Saux2, Saux3, Saux4).

Cutin and cutout limits are set for the thermostat. Coupling of the thermostat's output will be based on the actual sensor temperature. Alarm limits can be set for low and high temperature, respectively, including separate alarm delays.

The individual thermostat function can be adapted to the relevant application as it is possible to give the thermostat a name and to indicate alarm texts.

General pressure control functions (5 units)

(If the receiver is being pressure controlled, one of the five is used for this function. This means that there subsequently are four general pressure switches.)

The function may freely be used for alarm monitoring of plant pressure or for ON/OFF pressure control regulation.

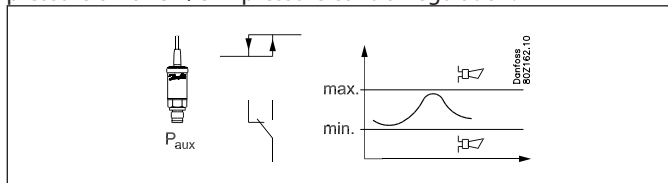

The pressure control can either use one of the sensors used by the control function (Po, Pc) or an independent sensor (Paux1, Paux2, Paux3).

Cutin and cutout limits are set for the pressure control. Coupling of the pressure control's output will be based on the actual pressure. Alarm limits can be set for low and high pressure, respectively, including separate alarm delays.

The individual pressure control function can be adapted to the relevant application as it is possible to give the pressure control a name and indicate alarm texts.

General voltage input with ancillary relay (5 units)

5 general voltage inputs are accessible for monitoring of various voltage measurements of the installation. Examples are monitoring of a leak detector, moisture measurement and level signal - all with ancillary alarm functions. The voltage inputs can be used to monitor standard voltage signals (0-5V, 1-5V, 2-10V or 0-10V). If required, one can also use 0-20mA or 4-20mA if external resistance is placed at the inlet to adjust the signal to the voltage. A relay outlet can be attached to the monitoring so that one can control external units.

For each inlet, the following can be set/read out:

- Freely definable name
- Selection of signal type (0-5V, 1-5V, 2-10V, or 0-10V)
- Scaling of read-out so it corresponds to measuring unit
- High and low alarm limit including delay times
- Freely definable alarm text
- Attach a relay output with cut in and cut-out limits including delay times

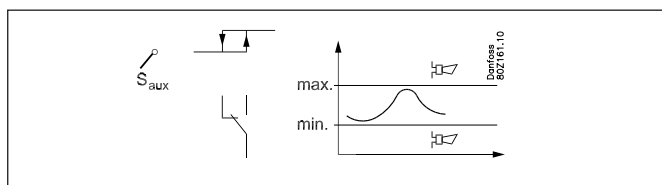

General PI functions (3 units)

The function can be freely used for controlling a required function, or it can be used to send signals to the controller regarding operating states. An example could be an out/in control for the use of the heat recovery function.

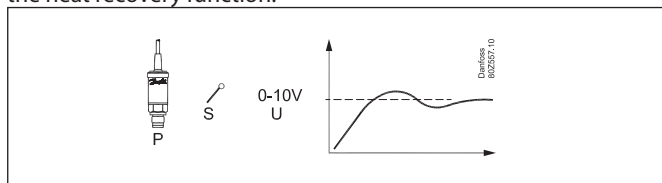

Signals can be received from the following:

- Temperature sensor
- Pressure transmitter
- Saturation temperature
- Voltage signal
- Internal signals such as: Tc, Pc, Ss and Sd

Signals can be sent to the following:

- Voltage signal
- Valve with stepper motor
- PWM (pulse width modulated) signal for AKV valve.

The PI function is shown overleaf.

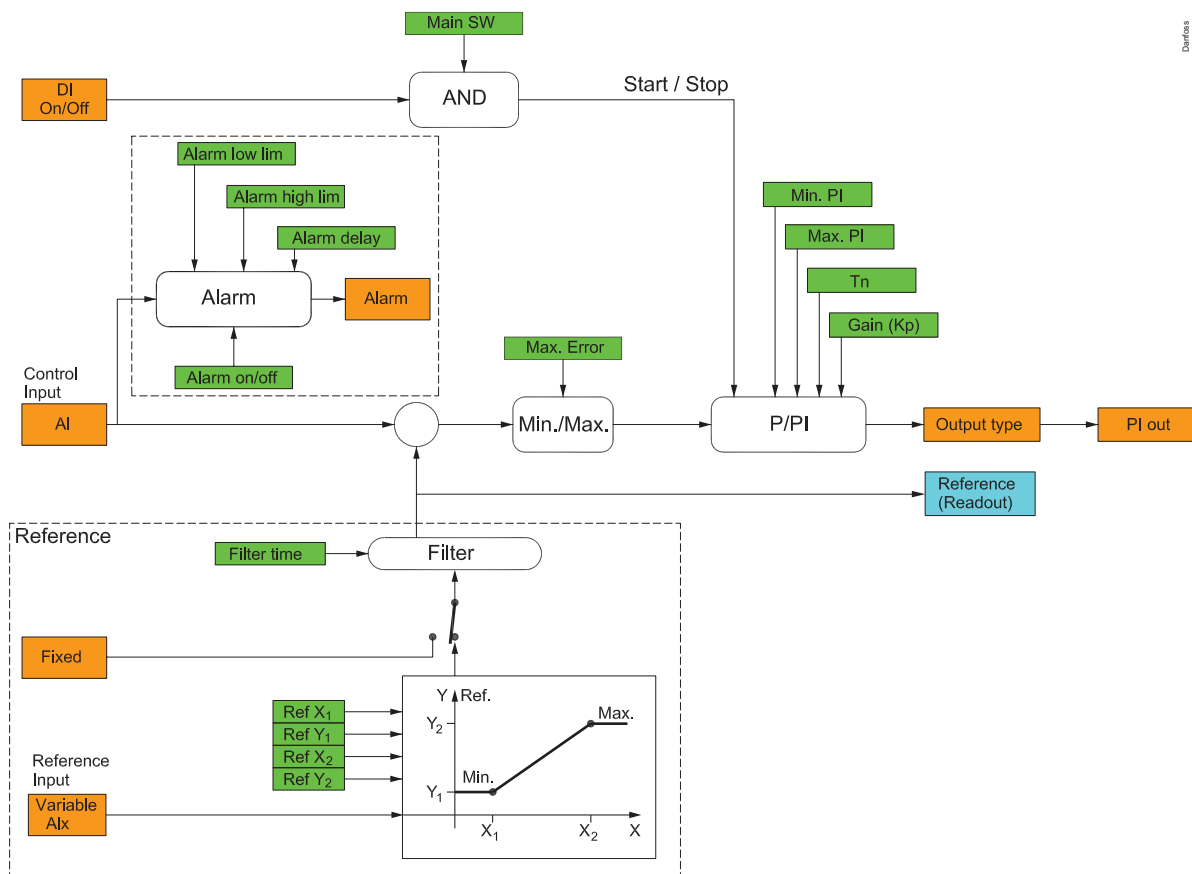

General

Signal and setting values are converted and adjusted as a percentage value of the signal.

A slow process will normally not be critical for the setting of P-part and I-part. However, if the process is quick, more careful setup is required.

A general balancing might be:

- Check max. and min. settings
- Increase the integration time so that it is not mixed up with the balancing
- Reduce Kp to start with
- Start the process
- Adjust Kp until the process starts fluctuating and is constantly fluctuating
- Adjust Kp to half the value
- Adjust Tn down until the process starts fluctuating again
- Adjust Tn to double values

Settings

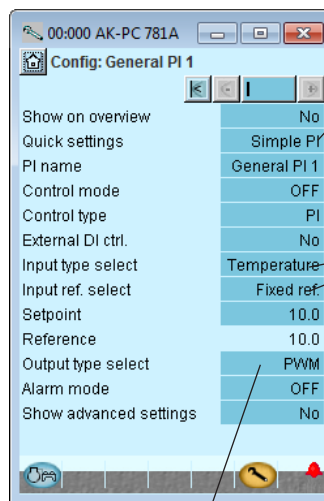

prepared examples

- Simple P
- Simple PI
- Heat control
- Cooling control
- Heat + Amb. Comp
- Pump delta P
- De-superheat
- Floor heat
- Dry cool 3WV
- Dry cool fan
- Convert 0-5V
- Convert 5-10V
- Temp. to volt

Temperature	Vaux1
Pressure	Vaux2
Press.to temp	Vaux3
Voltage	S7
Tc	SH
Pc	Comp. capaci
Ss suction	DI1-Alarm
Sd disch.	DI2-Alarm
To	DI3-Alarm
Sc3	DI4-Alarm
Sgc	DI5-Alarm
Shp	DI6-Alarm
Stw8	DI7-Alarm
Shr4	DI8-Alarm
Shr8	DI9-Alarm
Saux 1	DI10-Alarm
Saux 2	0 (Null)
Saux 3	
Po	
Pgc	
Prec	
Paux1	
Paux2	
Paux3	

PWM
Stepper
Voltage

Miscellaneous

Main switch

The main switch is used to stop and start the controlling function.

The switch-over has 2 positions:

- Normal controlling state (Setting = ON)
- Control stopped. (Setting = OFF)

In addition, one can also choose to use a digital input as an external main switch.

If the switch-over or the external main switch is set at OFF, all the control's functions are inactive and an alarm is generated to draw attention to this – all other alarms cease.

External switch for stopping compressors

The switch will stop the compressors, but all other functions will continue to be regulated.

Refrigerant

Before regulation can be commenced, the refrigerant must be defined.

You can select one of the following refrigerants:

1 R12	12 R142b	23 R410A	34 R427A
2 R22	13 User defined	24 R170	35 R438A
3 R134a	14 R32	25 R290	36 R513A
4 R502	15 R227	26 R600	37 R407F
5 R717	16 R401A	27 R600a	38 R1234ze
6 R13	17 R507	28 R744	39 R1234yf
7 R13b1	18 R402A	29 R1270	40 R448A
8 R23	19 R404A	30 R417A	41 R449A
9 R500	20 R407C	31 R422A	42 R452A
10 R503	21 R407A	32 R413A	
11 R114	22 R407B	33 R422D	

The refrigerant can only be changed if the "Main switch" is set at "stopped control".

A set glide value for all refrigerants in the R400 series.

Warning: Incorrect selection of refrigerant can cause damage to the compressor.

Sensor failure

If lack of signal from one of the connected temperature sensors or pressure transmitters is registered an alarm will be given.

- When there is a P0 error regulation will continue with 50% cut-in capacity during day operation and 25% cut-in capacity during night operation – but minimum one step.
- When there is a Pc error 100% condenser capacity will be cut in, but the compressor regulation will remain normal.
- When there is an error on the Sd sensor the safety monitoring of the discharge gas temperature will be discontinued.
- When there is an error on the Ss sensor the monitoring of the superheat on the suction line will be discontinued.
- When there is an error on the outdoor temperature sensor Sc3 the "FDD" function will cease. Regulation with variable condensing pressure reference cannot either be carried out. Instead you use the PC ref. min. value as reference.
- In the event of Sgc faults, further adjustments are carried out using the Shp signal.

Note: An incorrect sensor must be in order for 10 minutes before the sensor alarm deactivates.

Safety disconnection signal

Unexpected disconnection of the compressor, condensation fan or frequency convertor can result in unexpected temperature increases in the system. If necessary, use the necessary safety signals to ensure that the controller receives signals about disconnections.

Sensor calibration:

The input signal from all connected sensors can be corrected. A correction will only be necessary if the sensor cable is long and has a small cross-sectional area. All displays and functions will reflect the corrected value.

Clock function

The controller contains a clock function.

The clock function is used only to change between day/night. The year, month, date, hour and minutes must be set.

In the event of a power failure, the time setting will be remembered for at least 12 hours.

If the controller is connected to an installation with an AKA-gateway or an AK system manager, this will automatically reset the clock function.

Alarms and messages

In connection with the controller's functions, there are a number of alarms and messages that become visible in cases of fault or erroneous operation.

Alarm history:

The controller contains an alarm history (log) that contains all active alarms as well as the last 40 historical alarms. In the alarm history you can see when the alarm began and when it stopped. In addition, one can see the priority of each alarm as well as when the alarm has been acknowledged and by which user.

Alarm priority:

Differentiation is made between important and not-so-important information. The importance – or priority – is set for some alarms whilst others can be changed voluntarily (this change can only be done with attachment of AK-ST service tool software to the system and settings must be made in each individual controller).

The setting decides which sorting / action must be carried out when an alarm is sounded.

- "High" is the most important
- "Log only" is the lowest
- "Interrupted" results in no action

Alarm relay

One can also choose whether one requires an alarm output on the controller as a local alarm indication. For this alarm relay it is possible to define on which alarm priority it must react to – one can choose between the following:

- "Non" – no alarm relay is used
- "High" – Alarm relay is activated only with alarms with high priority
- "Low - High" – Alarm relay is activated only with alarms with "low" priority, "medium" or "high" priority.

The relationship between alarm priority and action appears in the schedule below.

Setting	Log	Alarm relay			Send Network	AKM destination
		Non	High	Low-High		
High	X		X	X	X	1
Medium	X			X	X	2
Low	X			X	X	3
Log only	X					4
Interrupted						

Alarm acknowledgement

If the controller is connected to a network with an AKA gateway or an AK system manager as alarm receiver, these will automatically acknowledge the alarms that are sent to them.

If the controller on the other hand is not included in a network, the user must acknowledge all alarms.

Alarm LED

The alarm LED on the front of the controller indicates the controller's alarm status.

Blinking: There is an active alarm or an unacknowledged alarm.
 Fixed light: There is an active alarm that has been acknowledged.
 Switched off: There are no active alarms and no unacknowledged alarms.

I'm alive relay

The function reserves a relay that is pulled under normal regulation.

The relay will be released if:

- The regulation is stopped by the internal or external main switch
- The controller fails

IO Status and manual

The function is used in connection with installation, servicing and fault-finding on the equipment.

With the help of the function, the connected outputs are controlled.

Measurements

The status of all inlets and outlets can be read and controlled here.

Forced operation

One can carry out an override of all outlets here to control whether these are correctly attached.

Note: There is no monitoring when the outlets are overridden.

Logging/registration of parameters

As a tool for documentation and fault-finding, the controller provides the possibility of logging of parameter data in the internal memory.

Via AK-ST 500 service tool software one can:

- a) Select up to 10 parameter values the controller will continuously register
- b) State how often they must be registered

The controller has a limited memory but as a rule of thumb, the 10 parameters can be saved, which are registered every 10 minutes for 2 days.

Via AK-ST 500 one can subsequently read the historical values in the form of graph presentations.

(The log only works when the clock has been set.)

Forced operation via network

The controller contains settings that can be operated from the system units forced operation function via data communication.

When the forced operation function asks about one change, all the connected controllers on this network will be set simultaneously.

There are the following options:

- Change to night operation
- Forced closure of injection valves (Injection ON)
- Optimization of suction pressure (Po)

Operating AKM / Service tool

The setup of the controller itself can only be carried out via AK-ST 500 service tool software. The operation is described in fitters on site guide.

If the controller is included in a network with an AKA gateway one can subsequently carry out the daily operation of the controller via AKM system software, i.e. one can see and change daily read-outs/settings.

Note: AKM system software does not provide access to all configuration settings of the controller. The settings/read-outs that may be made appear in the AKM menu operation (see also Literature overview).

Authorisation / Passwords

The controller can be operated with System software type AKM and service tool software AK-ST 500.

Both methods of operation provide the possibility for access to several levels according to the user's insight into the various functions.

System software type AKM:

The various users are defined here with initials and key word. Access is then opened to exactly the functions that the user may operate.

The operation is described in the AKM manual.

Service tool software AK-ST 500:

The operation is described in fitters on site guide.

When a user is created, the following must be stated:

- a) State a user name
- b) State a password
- c) Select user level
- d) Select units – either US (e.g. °F and PSI) or Danfoss SI (°C and Bar)
- e) Select language

Access is given to four user levels.

- 1) DFLT – Default user – Access without use of password
See daily settings and read-outs.
- 2) Daily – Daily user
Set selected functions and carry out acknowledgement of alarms.
- 3) SERV – Service user
All settings in the menu system except for creation of new users
- 4) SUPV – Supervisor user
All settings including the creation of new users.

Display of suction pressure and condensing pressure

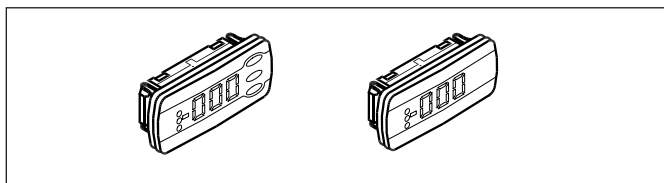

One to four separate displays can be connected to the controller. Connection is accomplished by means of wires with plug connections. The display may be placed in a control box front, for example.

When a display is connected, it will show the value for what is indicated in the setup. It can be:

compressors regulation sensor

P0 i temperature

P0 i bar-absolute

Pctrl bar-absolute

S4

Ss

Sd

Condensers regulation sensor

Tc

Pc bar-absolute

S7

Sgc

Shp

Pgc bar-absolute

Prec bar-absolute

Stw8

Shr8

Speed Compressor

Display	Primary readout *	Secondary readout
A	Regulation sensor suction pressure	Regulation sensor condenser
B	Regulation sensor condenser	Regulation sensor suction pressure
C	SS	None
D	SD	None

* The primary reading can be changed to other measurements, if required.

When (on plug A) a display with control buttons is chosen, a simple operation via a menu system can be performed in addition to the display of suction pressure and condensing pressure:

No.	Function	Cond.	Suction	Pack
o57	Capacity settings for condenser 0: MAN, 1: OFF, 2: AUTO	x		x
o59	Capacity setting for suction group 0: MAN, 1: OFF, 2: AUTO		x	x
h15	High pressure. Setting of Pgc minimum			x
h16	High pressure. Setting of HP-control mode: Automatic / manual			x
h17	High pressure. Manuel mode. Setting of valves opening degree			x
h18	Heat recovery. Reference for Shr8-temperature			x
h19	Heat recovery. Setting of heat recovery control mode: Automatic / off			x
o30	Refrigerant setting	x	x	x
o58	Manual setting of condenser capacity	x		x
o60	Manual setting of suction capacity		x	x
o62	Select of predefined configuration This setting will give a selection of predefined combinations which at the same time establish the connections points.. At the end of the manual an overview of options and connection points is shown. After the configuration of this function the controller will shut down and restart	x	x	x
o93	Lock of configuration It is only possible to select a predefined configuration or change refrigerant when the configuration lock is open. 0 = Configuration open 1 = Configuration locked	x	x	x
r12	Main switch 0: Controller stopped 1: Regulating	x	x	x
r23	Set point suction pressure Setting of required suction pressure reference in °C		x	x

r24	Suction pressure reference Actual reference temperature for compressor capacity		x	x
r28	Set point condenser Setting of required condenser pressure in °C	x		x
r29	Condenser reference Actual reference for temperature for condenser capacity	x		x
r57	Po evaporating pressure in °C		x	x
r86	Receiver control. Reference for Prec			x
r87	Receiver control. Setting of the receiver control mode : Automatic / manual			x
r88	Receiver control. Manual mode. Setting of the valves opening degree			x
t49	Hot water. Reference for Stw8-temperature			x
t50	Hot water. Setting of hot water control mode: Automatic / off			x
u16	Actual media temperature measured with S4		x	x
u21	Superheat in suction line		x	x
u44	Sc3 out door temperature in °C	x		x
u48	Actual regulation status on condenser 0: Power up 1: Stopped 2: Manuel 3: Alarm 4: Restart 5: Standby 6: Unloaded 7-9: Part loaded 10: Full loaded 11: Running	x		x
u49	Cut in condenser capacity in %	x		x
u50	Reference for condenser capacity in %	x		x
u51	Actual regulation status on suction group MT-circuits 0: Standby 1: Normal control 2: Compressor alarm 3: ON timer aktiv 4: OFF timer aktiv 5: Normal control 6: Injection ON delay 7: Coordination 8: Compressor 1 delay is activ 9: Pump down 10: Sensor error 11: Load shed is activ 12: High Sd 13: High Pc 14: Manuel control 15: OFF 16: Inrush guard 17: Min. cap. req 18: Pump delay		x	x
u52	Cut in compressor capacity in %		x	x
u53	Reference for compressor capacity		x	x
u54	Sd discharge gas temperature in °C		x	x
u55	Ss Suction gas temperature in °C		x	x
u98	Actual temperature for S7 media sensor		x	x
u99	Pctrl pressure in °C (cascade pressure)		x	x
U01	Actual Pc condensing pressure in °C	x		x
AL1	Alarm suction pressure		x	x
AL2	Alarm condenser	x		x
-- 1	Initiation, Display is connected to output "A", (- 2 = output "B" etc.)	x	x	x

If you want to see one of the values for what is given under "function" you should use the buttons in the following way:

1. Press on the upper button until a parameter is shown
2. Press on the upper or lower button and find the parameter you want to read
3. Press on the middle button until the value of the parameter is displayed.

After a short time, the display will return automatically to the "Read out display".

Light-emitting diodes on the controller

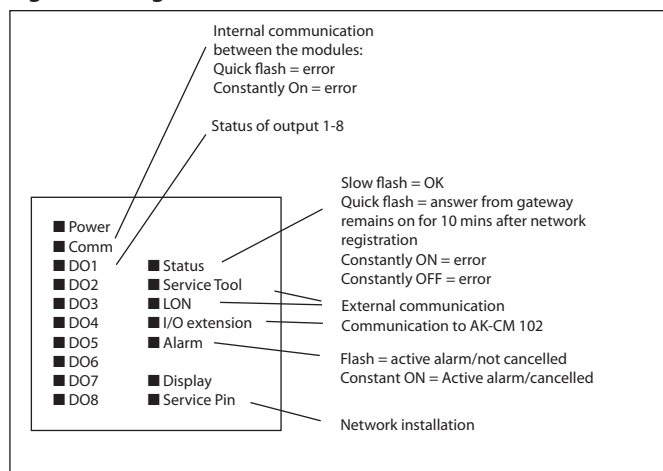

Graphic display MMIGRS2

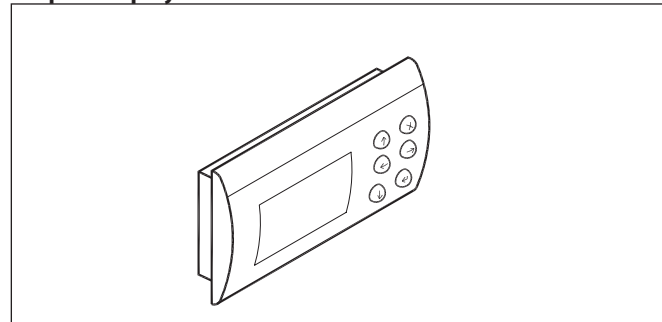

With the display is access to most of the controller functions. For access, connect the display to the controller and activate the address on MMIGRS2. (A separate power supply does **not** need to be connected) Power is supplied directly from the controller via the cable.

Setting:

1. Press both the "x" and "enter" buttons and hold in for 5 seconds. The BIOS menu is then displayed.
2. Select the "MCX selection" line and press "enter"
3. Select the "Man selection" line and press "enter"
4. The address will be displayed. Check that it is 001, press "enter".
Data will then be collected from the controller.

Stepper Motor Valves

When selecting a Danfoss stepper motor valve, all settings are factory set. Here, it is only necessary to select the type of valve. If a valve from other manufacturers is used the following settings has to be made. Get data from the valve manufacturer:

Max Operating Steps.

The number of steps that correspond to a valve position of 100%. This value is limited to a range of 0 - 10,000 steps.

Hysteresis

The number of steps needed to correct for mechanical hysteresis when a reduction gear is part of the valve design. This adjustment is only applied, if an additional opening of the valve is requested.

If this is the case the valve opens an additional amount equal to this value, before driving the valve in the closing direction by this same value.

This value is limited to 0 - 127 steps.

Step Rate

The desired valve drive rate in steps per second. This value is limited to 20 - 500 steps / sec.

Holding Current

The percent of the programmed Max Phase Current that should be applied to each phase of the stepper output when the valve is stationary. If required, this current ensures that the valve maintains its last programmed position. This value is limited to a range of 0 - 70% given in 10% steps.

Overdrive at Valve Init

During valve initialization, the amount to overdrive the valve, beyond the 0% position, to ensure that the valve has fully closed. This value is limited to a range of 0 - 31%.

Phase Current

The current applied to each phase of the stepper motor during actual valve movement. This value is limited to 7 bits and a range of 0 - 800 mA given in 10ma steps. Verify the range against the stepper valve controller in the actual design.

Please be aware, that this value has to be set in a RMS value. Some valve manufacturers are using peak current!

Soft Landing after Valve Init

At power on the valve is performing a valve Initialization i.e. closing the valve with "Max Operating Steps" plus "Overdrive At Valve Init" steps to generate a zero point calibration of the system. Hereafter a "Soft landing after Valve Init" is made to minimize the closing force on the valve seat with a few opening steps according to setting of "Hysteresis" or min 20 steps

Failsafe Position

During failsafe mode of operation (e.g., resulting from a loss of communications to this module), specifies the default valve position. This value is limited to a range of 0 - 100%.

Appendix A – Compressor combinations and coupling patterns

In this section, there is a more detailed description of the compressor combinations and the associated coupling patterns.

Compressor application 1 – single step

The capacity distributor is capable of managing up to 10 one-step compressors according to the following coupling patterns:

- Cyclical
- Best fit

Cyclical operation - example

Here, all compressors are of the same size and the compressors are cut in and cut-out in accordance with the First-In-First-Out (FIFO) principle, in order to equalise operating hours between the compressors.

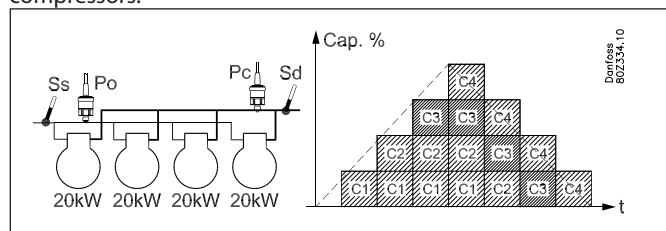

- There is operating time equalizing between all compressors
- The compressor with the fewest running hours starts first
- The compressor with the most running hours stops first.

Best fit - example

Here at least two compressors are of different sizes. The capacity distributor will cut in and cut-out the compressors to produce the best possible capacity fit (the least possible capacity jump).

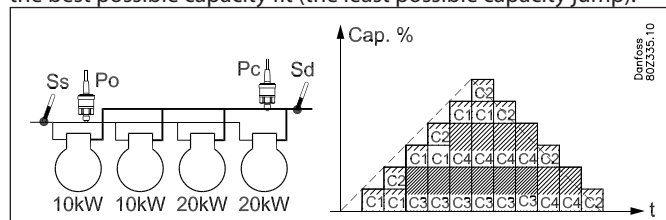

- There is operating time equalizing between the compressors 1 and 2 (same size in example).
- There is operating time equalizing between the compressors 3 and 4 (same size in example).

Compressor application 2 – 1 x unload + single step

The controller is able to control a combination of one capacity controlled and multiple single step compressors. The advantage of this combination is that the unloader valves will be used to fill in capacity gaps and thereby achieve many capacity steps via few compressors.

Preconditions for using this compressor application are:

- All compressors are the same size
- The capacity-regulated compressor can have up to three unload valves.
- The main step and the unload valves can be different sizes, i.e. 50%, 25% and 25%.

This compressor combination can be handled in the following coupling patterns:

- Cyclical

General regarding Handling:

Cutin

The capacity-regulated compressors with unloader valves start before one-step compressors. The capacity controlled compressor will always be fully loaded before cutting-in of subsequent one-step compressors.

Cutout

The capacity regulated compressor will always be the last to stop. The capacity controlled compressor will always be fully loaded before cut-in of subsequent one-step compressors.

Unloader valves

At cyclical operation unloader valves are used to close capacity holes from the subsequent one-step compressors.

Anti-cycle timer restrictions

In case a capacity controlled compressor is prevented in starting due to anti-cycle timer restrictions, then the start of any subsequent one-step compressors is not allowed. The capacity controlled compressor is started when the timer restriction has expired.

Cyclical operation - example

The one-step compressors will be cut in and cut-out in accordance with The First-In-First-Out (FIFO) principle in order to equalise operating hours between the compressors.

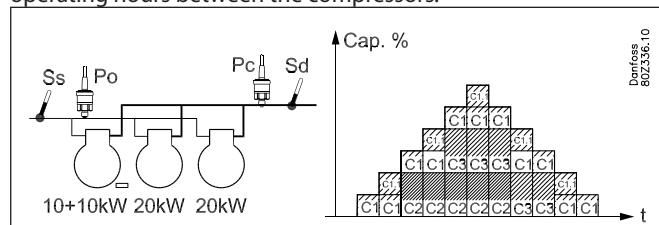

- The capacity controlled compressor is the first to start and the last to stop.
- Unloader valves are used to close capacity holes
- There is operating time equalizing between the compressors 2 and 3 (same size in example).

Compressor application 3 – 2 x unload + single step

The controller is able to control a combination of capacity controlled and multiple single step compressors. The advantage of this combination is that the unloader valves will be used to fill in capacity gaps and thereby achieve many capacity steps via few compressors.

Preconditions for using this compressor application are:

- All compressors are the same size
- The capacity-regulated compressors have the same number of unload valves (max 3)
- The main step on the capacity-regulated compressors have the same size
- The main step and the unload valves can be different sizes, i.e. 50%, 25% and 25%.

This compressor combination can be handled in accordance with the following coupling patterns:

- Cyclical

In general, regarding handling of the capacity-regulated compressors:

Cutin

The capacity-regulated compressors with unloader valves start before one-step compressors. The capacity controlled compressor will always be fully loaded before cutting-in of subsequent one-step compressors.

Cutout

The capacity regulated compressor will always be the last to stop. Handling of the unload valves depends on the setting of "unloader ctrl mode".

Unloader valves

At cyclical operation unloader valves are used to close capacity holes from the subsequent one-step compressors.

Anti-cycle timer restrictions

In case a capacity controlled compressor is prevented in starting due to anti-cycle timer restrictions, then the start of any subsequent one-step compressors is not allowed. The capacity controlled compressor is started when the timer restriction has expired.

Cyclical operation - example

The one-step compressors will be cut in and cut out in accordance with the First-In-First-Out (FIFO) principle in order to equalise operating hours between the compressors.

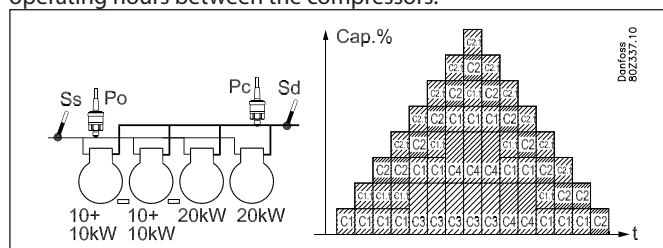

- The capacity controlled compressor is the first to start and the last to stop.
- Operating hours are equalised between the capacity-regulated compressors
- The unload valve on the capacity-regulated compressor is used to fill capacity gaps
- Operating hours are equalised between the one-step compressors 3 and 4.

Compressor application 4 – Only capacity controlled compressors

The controller is capable of controlling capacity-regulated piston compressors of the same size with up to 3 unload valves.

Preconditions for using this compressor application are:

- All compressors are the same size
- The capacity-regulated compressors have the same number of unload valves (max 3)
- The main step on the capacity-regulated compressors are the same size
- The main step and the unload valves can be different sizes, i.e. 50%, 25% and 25%.

This compressor combination can be handled in the following coupling patterns:

- Cyclical

Cyclical operation - example

The compressors are cut in and cut out in accordance with the First-In-First-Out (FIFO) principle to equalise operating hours between compressors.

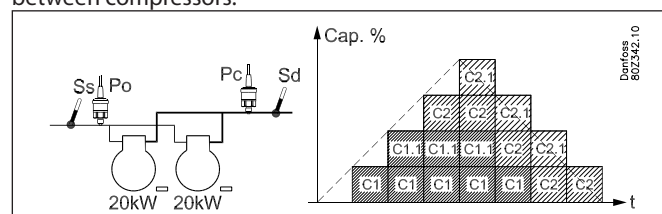

- For cyclical operation, the compressor with the fewest running hours starts (C1)
- Only when compressor C1 is completely loaded, should compressor C2 be cut in
- For cut-out, the compressor with the most operating hours should be unloaded (C1)
- When this compressor is completely unloaded, the second compressor is unloaded by one step before the main step on the completely unloaded compressor (C1) is cut out.

Compressor application 5 – 1 x Speed + single step

The controller is capable of controlling one speed-regulated compressor combined with one-step compressors of the same or different sizes.

Preconditions for using this compressor application are:

- A speed-regulated compressor that can be of a different size than the following one-step compressors
- Up to 3 one-step compressors of the same or different capacity (depending on coupling pattern)

This compressor combination can be handled in accordance with the following coupling patterns:

- Cyclical
- Best fit

Handling the speed-regulated compressor.

For more information on the general handling of the speed-regulated compressor, refer to section "Power pack types".

Cyclical operation - example

Here, the one-step compressors are of the same size.

The speed-regulated compressor is always the first to start and the last to stop.

One-step compressors should be cut in and cut out in accordance with the First-In-First-out principle in order to equalise operating hours.

The speed-regulated compressor is used to fill the capacity gaps between the one-step compressors.

Example:

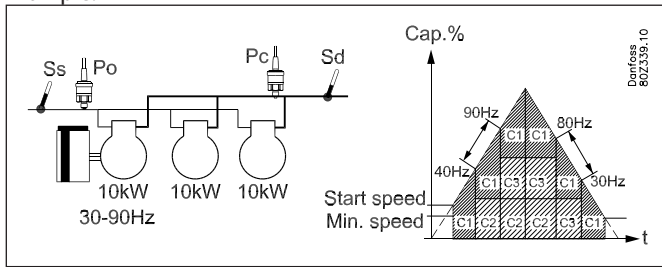

Increasing capacity:

- The speed-regulated compressor starts when the desired capacity equals the start speed
- The following one-step compressor with the smallest number of operating hours cut in when the speed-regulated compressor is running at full speed (90 Hz)
- When a one-step compressor cuts in, the speed-regulated compressor reduces speed (40 Hz) equivalent to the capacity of the one-step compressor.

Decreasing capacity:

- The following one-step compressors with the most operating hours should be cut out when the speed-regulated compressor reaches minimum speed (30 Hz)
- When a one-step compressor is cut out, the speed-regulated compressor's speed increases (80 Hz), equivalent to the capacity of the one-step compressor
- The speed-regulated compressor is the last compressor to be cut out when the preconditions for this are fulfilled.

Best fit - example:

Here, at least two of the one-step compressors are of different sizes.
The speed-regulated compressor is always the first to start and last to stop.
The capacity distributor cuts in and cuts out the one-step compressors in order to achieve the best possible capacity fit (least possible capacity jump)
The speed-regulated compressor is used to fill out the capacity gaps between the one-step compressors.

Example:

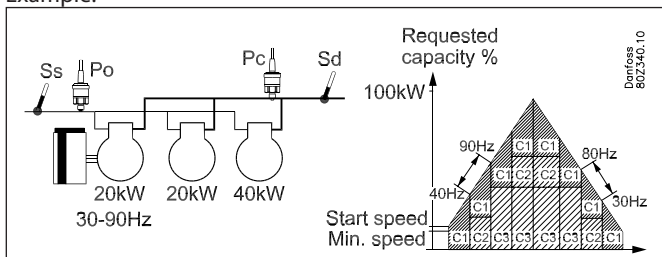

Increasing capacity:

- The speed-regulated compressor starts when the desired capacity matches the start speed
- The smallest one-step compressor is cut in when the speed-regulated compressor runs at full-speed (90 Hz).
- When the speed-regulated compressor again reaches max. speed (90 Hz), the smallest one-step compressor is cut out (C2) and the big one-step compressor (C3) is cut in.
- When the speed-regulated compressor again reaches max speed (90 Hz), the smallest one-step compressor (C2) is cut in again.

- When the one-step compressor is cut in, the speed is reduced on the speed-regulated compressor (40 Hz) equivalent to the capacity of the cut in capacity

Decreasing capacity:

- The small one-step compressor is cut out when the speed-regulated compressor has reached minimum speed (30 Hz)
- When the speed-regulated compressor again reaches minimum speed (30 Hz), the smallest one-step compressor (C2) is cut out and the big one-step compressor (C3) is cut in.
- When the speed-regulated compressor again reaches min. speed (30 Hz), the large one-step compressor (C3) is cut out and the small one-step compressor (C2) is cut in again.
- When the speed-regulated compressor again reaches min. speed (30 Hz), the small one-step compressor (C2) is cut in.
- The speed-regulated compressor is the last compressor to be cut out when the requirements for this are fulfilled.
- When the one-step compressor's capacity is cut out, the speed-regulated compressor increases speed (80 Hz) equivalent to the cut out capacity.

Compressor application 6 - 1 x Speed + unloader

The controller can operate one speed-regulated compressor combined with several capacity-regulated compressors of the same size and with the same number of unloaders.

The advantage of this combination is that the variable part of the speed-regulated compressor only needs to be large enough to cover the following unload valves in order to achieve a capacity curve without gaps.

Preconditions for using this compressor application are:

- A single speed-regulated compressor that can be of a different size than the following compressors
- The capacity-regulated compressors are the same size and have the same number of unload valves (max. 3)
- The main step on the capacity-regulated compressors are the same size
- The main step and the unload valves can be different sizes, i.e. 50%, 25% and 25%.

This compressor combination can be handled in the following coupling patterns:

- Cyclical

Handling the speed-regulating compressor.

For further information on the general handling of the speed-regulated compressor, refer to section "Power pack types".

Cyclical operation - example

The speed-regulated compressor is always the first to start and last to stop.

The capacity-regulated compressors are cut in and cut out in accordance with the First-in-First-Out principle in order to equalise operating hours

The speed-regulated compressor is used to fill the capacity gaps between the unload valves/main steps.

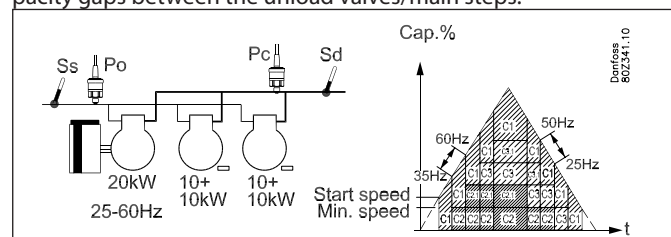

Increasing capacity:

- The speed-regulated compressor starts when the desired capacity matches the start speed
- The main step on the capacity-regulated compressor with fewest operating hours (C1) is cut in when the speed-regulated compressor runs at full speed (60 Hz)
- The unload valves are cut in gradually as the speed-regulated compressor again reaches max. speed (60 Hz)
- The main step on the last capacity-regulated compressor (C2) is cut in when the speed-regulated compressor again reaches max. speed (60 Hz)
- The unload valves are cut in gradually as the speed-regulated compressor again reaches max. speed (60 Hz)
- When the main step or unload valves are cut in, the speed is reduced on the speed-regulated compressor (35 Hz) is equivalent to the capacity of the cut in capacity.

Decreasing capacity:

- The capacity-regulated compressor with the most operating hours (C2) cuts out an unload valve when the speed-regulated compressor has reached min. speed (25 Hz)
- When the speed-regulated compressor again reaches min. speed (25 Hz), the unload valve is cut out on the next capacity-regulated compressor (C3)
- When the speed-regulated compressor again reaches min. speed (25 Hz), the main step is cut out on the capacity-regulated compressor with the most operating hours (C2)
- When the speed-regulated compressor again reaches min. speed (25 Hz), the main step is cut out on the last capacity-regulated compressor (C3)
- The speed-regulated compressor is the last compressor that is cut out when the conditions for this are fulfilled
- When the main step or unload valves are cut out, the speed of the speed-regulated compressor increases (50 Hz) to equivalent to the cut out capacity

Compressor application 7 – 2 x Speed + single

The controller can control two speed-regulated compressors combined with several one-step compressors that may be the same or different in size (depending on the selected coupling pattern). The advantage of using two speed-regulated compressors is that it is then possible to reach a very low capacity, which is an advantage with low loads while at the same time a very high variable regulating range is possible.

Preconditions for using this compressor application are:

- Two speed-regulated compressors which can be of a different size than the following one-step compressors
- The speed-regulated compressors can be the same or different sizes (depending on the choice of coupling pattern)
- The same frequency band for both speed-regulated compressors
- One-step compressors of the same or different sizes (depending on the choice of coupling pattern)

This compressor combination can be handled in accordance with the following coupling patterns:

- Cyclical
- Best fit

Handling the speed-regulated compressor.

For more information on the general handling of the speed-regulated compressors, refer to section "Power pack types".

Cyclical operation - example

Here the speed-regulated compressors are the same size
The one-step compressors should also be the same size.

The speed-regulated compressor is always the first to start and the last to stop.

The other compressors cut in and cut out in accordance with the operating time (First-In-First-Out principle).

The speed-regulated compressor is used to fill the capacity gaps between the following one-step compressors.

Example:

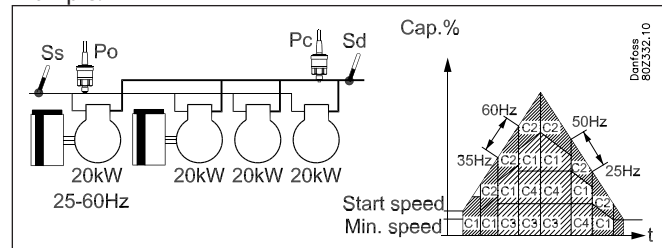

Increasing capacity:

- The speed-regulated compressor with the least operating hours (C1) starts when the desired capacity equals the start speed
- The following speed-regulated compressor C2 is cut in when the first speed-regulated compressor (C1) has reached max. speed (60 Hz) so that the compressors run in parallel.
- When the two speed-regulated compressors reach full speed (60 Hz) the one-step compressor with the fewest operating hours is cut in (C3)
- When the two speed-regulated compressors again reach full speed (60 Hz) the last one-step compressor cuts in (C4)
- When one-step compressors are cut in, the speed is reduced on the speed-regulated compressor (35 Hz) equivalent to the cut in capacity.

Decreasing capacity:

- The one-step compressor with the most operating time (C3) is cut out when the speed-regulated compressor reaches min. speed (25 Hz)
- When the two speed-regulated compressors again reach min. speed (25 Hz), the last one-step compressor is cut out (C4)
- When the two speed-regulated compressors again reach min. speed (25 Hz), the speed-regulated compressor with the most operating hours is cut out (C1)
- The last speed-regulated compressor (C2) is cut out when the requirements for this are fulfilled
- When one-step compressors are cut out, the speed-regulated compressors' speed increases (50 Hz), equivalent to the cut out capacity.

Best fit - examples

Here, either the two speed-regulated compressors are of different sizes, or the following one-step compressors are of different sizes. The speed-regulated compressors are always the first to start and the last to stop.

The capacity distributor cuts in and cuts out both speed-regulated and one-step compressors in order to reach the best possible capacity adjustment (least possible capacity jump).

Example 1

In this example, the speed-regulated compressors are of the same size and the following one-step compressors are of different sizes

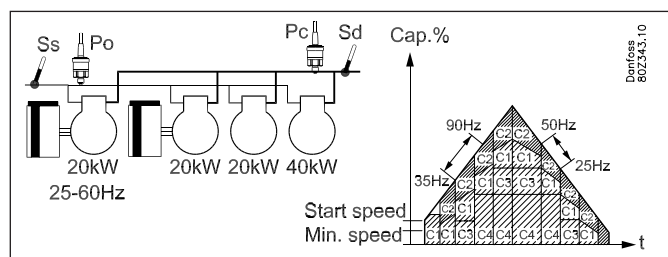

Increasing capacity:

- The speed-regulated compressor with the least operating hours (C1) starts when the desired capacity equals the start speed
- When the first speed-regulated compressor (C1) has reached max. speed (60 Hz), the second speed-regulated compressor (C2) cuts in so that the compressors run in parallel
- When the two speed-regulated compressors reach full speed (60 Hz), the small one-step compressor (C3) is cut in
- When the two speed-regulated compressors again reach full speed (60 Hz), the large one-step compressor (C4) is cut in and the small one-step compressor (C3) is cut out
- When the two speed-regulated compressors again reach full speed (60 Hz), the small one-step compressor (C4) is cut in again.
- When the one-step compressor is cut in, the speed is reduced on the speed-regulated compressor (35 Hz) corresponding to the cut in capacity

Decreasing capacity:

- The small one-step compressor (C3) is cut out when the speed-regulated compressor reaches the min. speed (25 Hz)
- When the two speed-regulated compressors again reach min. speed (25 Hz), the big one-step compressor (C4) is cut out and the small one-step compressor (C3) is cut in
- When the two speed-regulated compressors again reach min. speed (25 Hz), the small one-step compressor (C3) is cut out
- When the two speed-regulated compressors again reach min speed (25 Hz), the speed-regulated compressor with the most operating hours (C1) is cut out
- The last speed-regulated compressor (C2) is cut out when the requirements for this are fulfilled
- When one-step compressors cut out, the speed-regulated compressors increase speed (50 Hz), corresponding to the cut out capacity

Increasing capacity:

- The smallest speed-regulated compressor (C1) starts when the desired capacity equals the start speed
- When the smallest speed-regulated compressor (C1) has reached max. speed (90 Hz), the large speed-regulated compressor (C2) cuts in and the small speed-regulated compressor cuts out.
- When the large speed-regulated compressor reaches max. speed (90 Hz), the small speed-regulated compressor (C1) cuts in again so that the compressors run in parallel
- When the two speed-regulated compressors reach full speed (90 Hz), the small one-step compressor (C3) is cut in
- When the two speed-regulated compressors again reach full speed (90 Hz), the big one-step compressor (C4) cuts in and then the small one-step compressor (C3) cuts out
- When the two speed-regulated compressors again reach full speed (90 Hz), the small one-step compressor (C3) is cut in again.
- When the one-step compressors are cut in, the speed decreases on the speed-regulated compressor (56.7 Hz) corresponding to the cut in capacity

Decreasing capacity:

- The small one-step compressor (C3) is cut out when the speed-regulated compressor reaches min. speed (30 Hz)
- When the two speed-regulated compressors again reach min. speed (30 Hz) the big one-step compressor (C4) cuts out and the small one-step compressor (C3) cuts in.
- When the two speed-regulated compressors again reach min. speed (30 Hz), and the small one-step compressor (C3) cuts out.
- When the two speed-regulated compressors again reach min. speed (30 Hz), the small speed-regulated compressor (C1) cuts out.
- When the big speed-regulated compressor reaches min. speed (30 Hz), it is cut out and the small speed-regulated compressor is cut in (C1)
- The small speed-regulated compressor (C1) is cut out when the conditions for this are met.
- When the one-step compressors are cut out, the speed-regulated compressors' speed increases (63.3 Hz) equivalent to the cut out capacity.

Example 2:

In this example, the speed-regulated compressors are of different sizes and the following one-step compressors are also of different sizes.

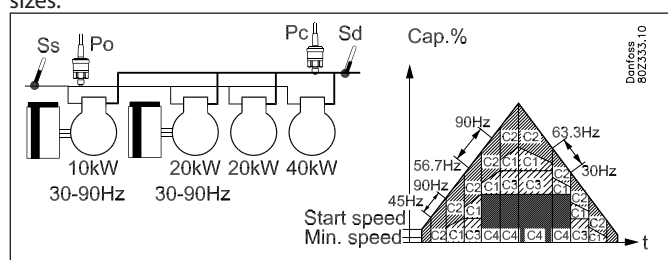

Appendix B - Alarm texts

Settings	Priority (factory)		English alarm texts	Description
Suction group				
Low suction pressure P0	Low		Low pressure P0	Minimum safety limit for suction pressure P0 has been exceeded
High suction pressure P0	High		High pressure P0	High alarm limit for P0 has been exceeded
High/Low superheat Ss	Medium		High superheat suction A	Superheat in suction line too high
			Low superheat section A	Superheat in suction line too low
Load shedding	Medium		Load Shed active	Load shedding has been activated
P0/S4/Pctrl sensor error	High		P0A sensor error	Pressure transmitter signal from P ₀ is defective
			S4A sensor error	Temperature signal from S4 media temp. sensor defective
			Pctrl sensor error	Pressure transmitter signal from Pctrl is defective
			Sgc sensor error	Temperature signal from gas cooler is defective
			Prec sensor error	Pressure transmitter signal from the receiver is defective
			Pgc sensor error	Pressure transmitter signal from the gas cooler is defective
Misc. sensor error	Medium		SsA sensor error	Temperature signal from Ss suction gas temp. is defective
			SdA sensor error	Temperature signal from Sd discharge gas temp. is defective
			Sc3 sensor error	Temperature signal from Sc3 air on condenser defective
			Heat recovery sensor error	Temperature signal from Shrec heat recovery thermostat defective
			Stw sensor error	Temperature signal from hot water circuit is defective
			Shr sensor error	Temperature signal from heat circuit is defective
			Saux_ sensor error	Signal from extra Temp.sensor Saux_ is defective
			Paux_ sensor error	Signal from extra pressure sensor Paux_ is defective
All compressors				
Common safety	High		Common compr. Safety cutout	All compressors have been cut out on common safety input
Comp. 1 safety Comp. 2 safety Comp. 3 safety <hr/> Comp. 10 safety	Medium		Comp. X oil pressure cut out	Compressor no. x has been cut out on oil pressure safety
			Comp. x over current cut out	Compressor no. x has been cut out on over current safety
			Comp. 1 motor prot. cut out	Compressor no. x has been cut out on motor protection safety
			Comp. 1 disch. Temp cut out	Compressor no. x has been cut out on discharge temperature safety
			Comp. 1 disch. Press. Cut out	Compressor no. x has been cut out on discharge pressure safety
	Comp. 1 General safety cut out	Compressor no. x has been cut out on general safety		
VSD safety	Medium		Comp. 1 FCD safety error	Variable speed drive for comp. x has been cut out on safety
Comp. Low oil lvl	Medium		Low oil level comp. x	Oil level too low in compressor x
Comp. High oil lvl	Medium		High oil level in compressor x	Oil level too high in compressor x
Separator alarms	Medium		Low oil in separator x	Oil level too low in separator x
			No oil separated sep. x	No oil in oil separator x
			To high oil in separator x	Oil level too high in separator x
			Remaining oil separator x	Separator x can not be emptying total for oil
Receiver alarm	Medium		Oil recv. high level	Oil level too high in receiver
			Oil recv. low level	Oil level is too low in receiver
Rec. high pressure	Medium		Recv. High pressure alarm	Pressure too high in receiver
Rec. low pressure	Medium		Recv. Low pressure alarm	Pressure too low in receiver

Condensor				
High Sd temp.	High		High disch. temp. SdA	Safety limit for discharge temperature has been exceeded
High Pc pressure	High		High pressure Pc	High safety limit for condensing pressure Pc has been exceeded
Pc/S7 Sensor error	High		PcA sensor error	Pressure transmitter signal from Pc is defective
			S7A sensor error	Temperature signal for S7 media temperature sensor is defective
Detect blocked air flow	Medium		Air flow reduced cond. A	The intelligent air flow monitoring of the condenser reports that a cleaning is due
Fan/VSD safety	Medium		Fan Alarm 1	Fan no. X is reported defective via safety input
			Fan VSD alarm	Variable speed drive for condenser fans has been cut out on safety

Various alarms				
Standby mode	Medium		Control stopped, MainSwitch=OFF	The control has been stopped via the setting "Main switch" = Off or the external Main switch is off
Thermostat x – Low temp. alarm	Low		Thermostat x - Low alarm	The temperature for thermostat no. x has been below the low alarm limit for longer time than set delay
Thermostat x – High temp. alarm	Low		Thermostat x - High alarm	The temperature for thermostat no. x has been above the high alarm limit for longer time than set delay
Pressostat x – Low pressure alarm	Low		Pressostat x - Low alarm	The pressure for pressostat no. x has been below the low alarm limit for longer time than set delay
Pressostat x – alarm limit high pressure	Low		Pressostat x - High alarm	The pressure for pressostat no. x has been above the high alarm limit for longer time than set delay
Voltage input x – Low alarm	Low		Analog input x - Low alarm	The voltage signal has been below the low alarm limit for longer time than set delay
Voltage input x – High alarm	Low		Analog input x - High alarm	The voltage signal has been above the high alarm limit for longer time than set delay
User def. alarm text	Low		Custom alarm x -define text	Alarm on general alarm input DI x
No flow	High		Flow switch alarm	There is no flow in the heating circuit Check the pump
Boiling alarm	High		Boiling alarm	The temperature in the heat circuit is too high
Receiver alarm	High		Prec...	Alarm from the receiver
External power loss	High		External power loss	Supply is interrupted. A message alert. All other alarms stopped.
Stappervalue	High		Stepper - Vhp, Vrec, Pl, Vliq. Open coil, Shorted output, Error, Power failure	Check the supply to the current valve. In the event of an error or power failure: check the supply to the stepper module.

System alarms				
The alarm priority can not be altered on system alarms				
Control mode	Low		Manual comp. cap. Control A	Compressors capacity control runs i manual mode
Control mode	Low		Manual cond. cap. Control A	Condense capacity control runs i manual mode
	Low		Refrigerant A not selected	Refrigerant has not been selected
Refrigerant changed	Low		Refrigerant changed	Refrigerant type has been changed
	Medium		Time has not been set	Time has not been set
	Medium		System Critical exception	A unrecoverable critical system failure has occurred – exchange the controller
	Medium		System alarm exception	A minor system failure has occurred – power off controller
	Medium		Alarm destination disabled	When this alarm is activated the alarm transmission to the alarm receiver has been deactivated. Check and wait. When the alarm is cleared the alarm transmission to the alarm receiver has been activated again
	Medium		Alarm route failure	Alarms can not be transmitted to alarm receiver – check communication
	High		Alarm router full	The internal alarm buffer has an overrun – this might occur if the controller can not send the alarms to the alarm receiver. Check communication between controller and system unit.
	Medium		Device is restarting	The controller is restarting after flash updating of the software
	Medium		Common IO Alarm	There is a communication fault between the controller module and the extension modules – the fault must be corrected as soon as possible

Manual control				
	Low		MAN DI.....	The in put in question has been put in manual control mode via the AK-ST 500 service tool software
	Low		MAN DO.....	The output in question has been put in manual control mode via the AK-ST 500 service tool software
	Low		Man set	The output in question has been put in manual control mode via the AK-ST 500 service tool software
	Low		Man control	The output in question has been put in manual control mode via the AK-ST 500 service tool software

Appendix C - Recommended connection

Function

The controller has a setting where you can choose between various types of installation. If you use these settings, the controller will suggest a series of connection points for the different functions. These points are shown below. (The options shown are determined by previous settings in the menu, e.g. cooling agent and "Pack type".)

Even if your installation is not 100% as described below, you can still use the function. After use, you need only adjust the divergent settings.

The given connection points in the controller can be changed if you wish.

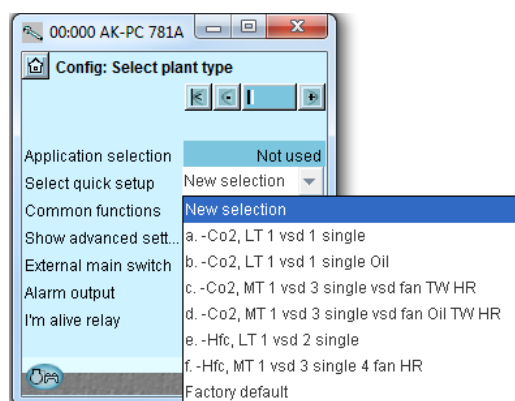

Appl.	Compressor	Fan	Description	Module	Point number					
					1	2	3	4	5	6
a			LT 1 vsd comp. 1 single CO ₂	Modul 1 - Controller Modul 2 - AK-XM 102B	LT Comp. Release Comp. 1 safety	Loadshed 1 Comp. 2 safety	Loadshed 2			Main Sw.
b			LT 1 vsd comp. 1 single CO ₂ , Oil valve	Modul 1 - Regulator Modul 2 - AK-XM 102B	LT Comp. Release Comp. 1 safety	Loadshed 1 Comp. 1 safety	Loadshed 2	Oil lvl. Comp. 1	Oil lvl. Comp. 2	Main Sw.
c			MT 1 vsd comp. 3 single vsd-fans Boost Gas cooler Receiver TW HR CO ₂	Modul 1 - Regulator Modul 2 - AK-XM 102B Modul 3 - AK-XM 103A Modul 4 - AK-XM 208C Modul 5 - AK-XM 205A	MT Comp. Request Comp. 1 safety	Loadshed 1 Comp. 2 safety	Loadshed 2 Comp. 3 safety	Sgc Comp. 4 safety	Shp VSD C.1 safety	Main Sw. Fan 1 safety
d			MT 1 vsd comp. 3 single vsd-fans Boost Gas cooler Receiver Oil sep. Oil receiver Oil valve TW HR CO ₂	Modul 1 - Regulator Modul 2 - AK-XM 102B Modul 3 - AK-XM 103A Modul 4 - AK-XM 208C Modul 5 - AK-XM 205A Modul 6 - AK-XM 205A	MT Comp. Request Comp. 1 safety	Loadshed 1 Comp. 2 safety	Loadshed 2 Oil Low Receiver Oil Hi Receiver	Sgc Comp. 4 safety Power loss	Shp VSD C.1 safety	Main Sw. Fan 1 safety
e			LT 1 vsd comp. 2 single HFC Cascade	Modul 1 - Regulator Modul 2 - AK-XM 102B	LT Comp. Release Comp. 1 safety	Loadshed 1 Comp. 2 safety	Loadshed 2 Comp. 3 safety	Night		Main Sw.
f			MT 1 vsd comp. 3 single 4 fans HFC Cascade HR	Modul 1 - Regulator Modul 2 - AK-XM 102B Modul 3 - AK-XM 205A	MT Comp. Request Comp. 1 safety	Loadshed 1 Comp. 2 safety	Loadshed 2 Comp. 3 safety	Night Comp. 4 safety	Heat recovery VSD C.1 safety	Main Sw.

Appl.	Point number														
	7	8	9	10	11	12	13	14	15	16	17	18	19	24	25
a		Sd	Ss	P0	Pc	Comp. 1	Comp. 2					Alarm	LT Comp. Request	Comp. speed	
b	Reset lockout	Sd	Ss	P0	Pc	Comp. 1	Comp. 2	Oil Valve C1	Oil Valve C2	Oil lvl. Safety C1	Oil lvl. Safety C2	Alarm	LT Comp. Request	Comp. speed	
c	Sc3	Sd	Ss	P0	Pc	Comp. 1	Comp. 3	Comp. 3	Liq. Inject suction	Fan 1	Fan 2	Comp. 4	MT Comp. Release	Comp. speed	Fan speed
	Fan 2 safety	VSD cond safety													
	Speed tw	Speed hr													
	HR Shr4	HR Shr8	Vrec CCM	Vhp CCMT											
	GasCool. Pgc	Receiver Prec	HR tw V3tw	HR tw Pump tw	HR V3hr	HR pump hr		GasCool. V3gc	Thermost. 1	Alarm					
d	Sc3	Sd	Ss	P0	Pc	Comp. 1	Comp. 2	Comp. 3	Liq. Inject suction	Fan 1	Fan 2	Comp. 4	MT Comp. Release	Comp. speed	Fan speed
	Fan 2 safety	VSD cond safety													
	Speed tw	Speed hr													
	HR Shr4	HR Shr8	Vrec CCM	Vhp CCMT											
	GasCool. Pgc	Receiver Prec	HR tw V3tw	HR tw Pump tw	HR V3hr	HR pump hr	Oil valve Separat.1	GasCool. V3gc	Thermost. 1	Alarm					
		Poil rec	Oil Valve C1	Oil Valve C2	Oil Valve C3	Oil Valve C4	Oil lvl. Safety C1	Oil lvl. Safety C2	Oil lvl. Safety C3	Oil lvl. Safety C4					
e		Sd	Ss	P0	Pc	Comp. 1	Comp. 2	Comp. 3				Alarm	LT Comp. Request	Comp. speed	
f	Sc3	Sd	Ss	P0	Pc	Comp. 1	Comp. 2	Comp. 3	Comp. 4	Fan 1	Fan 2	Fan 3	Fan 4	Comp. speed	
	Volt input 1	Saux 1				Volt input 1 (DO)	MT Comp. Release	Liq. Inject Heat Ex.	Thermost. 1	Heat recovery					

Installation considerations

Accidental damage, poor installation, or site conditions, can give rise to malfunctions of the control system, and ultimately lead to a plant breakdown.

Every possible safeguard is incorporated into our products to prevent this. However, a wrong installation, for example, could still present problems. Electronic controls are no substitute for normal, good engineering practice.

Danfoss will not be responsible for any goods, or plant components, damaged as a result of the above defects. It is the installer's responsibility to check the installation thoroughly, and to fit the necessary safety devices.

Special reference is made to the necessity of signals to the controller when the compressor is stopped and to the need of liquid receivers before the compressors.

Your local Danfoss agent will be pleased to assist with further advice, etc.