



**Installation Guide**

System Manager  
Type **AK-SM 800A series**



AN307930531782en-000301

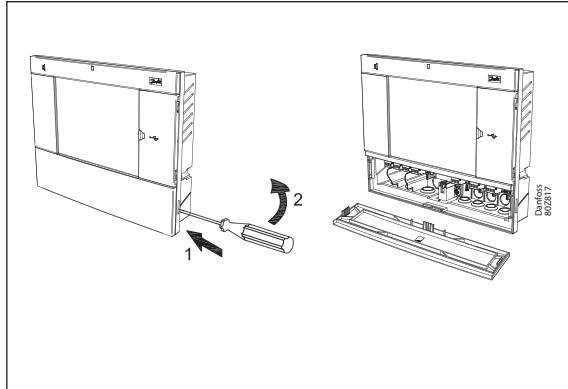

**UL** us Listed

-10 °C < t<sub>amb</sub> < 50 °C  
14 °F < t<sub>amb</sub> < 120 °F  
0 – 95% RH, non condensing  
IP20

UL file: E31024

61B5

Class 2 or LPS in accordance with NEC.  
For supply connections, use 16 AWG or larger wires rated for at least 75 °C (167 °F).  
Use copper conductors only.

Enclosure rating type 1

FCC ID: X02SPB209A

IC ID: 8713A-SPB209A

**Panel mount**

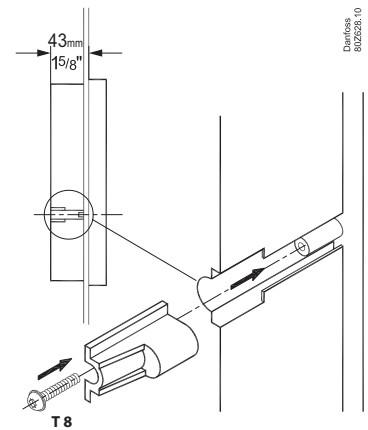
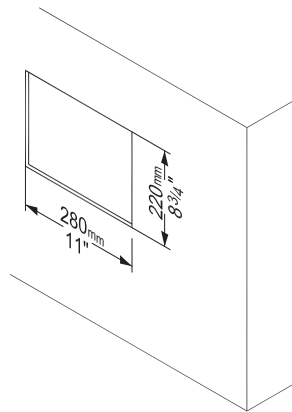
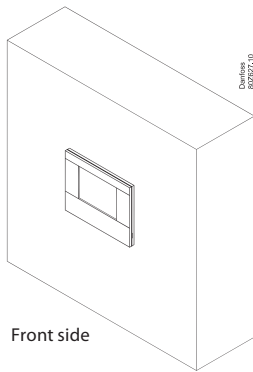

**Wall mount**

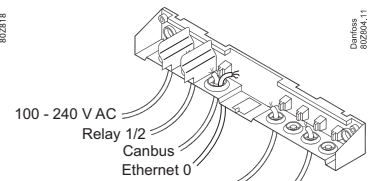
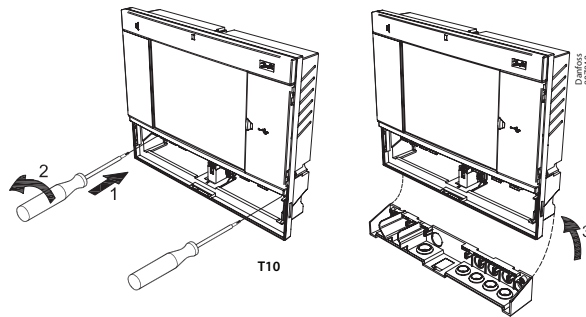
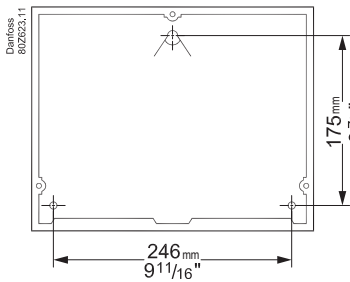

100 - 240 V AC  
Relay 1/2  
Canbus  
Ethernet 0  
MODBUS 1/2  
LON / TP78

CANbus is not currently activated.

**Supply**

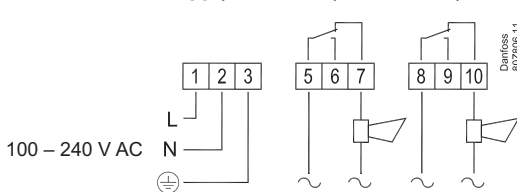

**Relay 1**

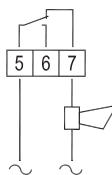

**Relay 2**

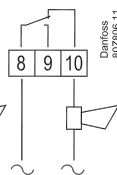

**LON-version**

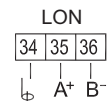
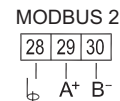
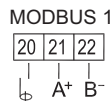

**Canbus**

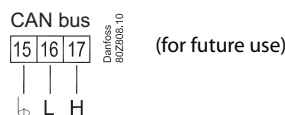

**TP 78-version**

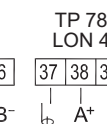
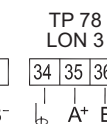
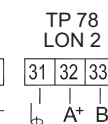
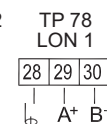
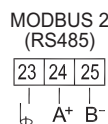
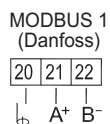

Selve installationen af datakommunikationskablet skal overholde de krav, som er nævnt i dokumentet "Datakommunikation imellem ADAP-KOOL® Køleanlægssystemer". Litteraturnummer = [RC8AC901](#).

The actual installation of the data communication cable must comply with the requirements mentioned in the document "Data communication between ADAP-KOOL® Refrigeration controls". Literature sheet number = [RC8AC902](#).

Beim Verlegen des Datenkommunikationskabels sind die im dokument "Datenkommunikation zwischen ADAP-KOOL® Kälteanlagenregelsysteme" enthaltenen Anforderungen einzuhalten. Literaturnummer = [RC8AC903](#).

L'installation elle-même du câble de transmission de données doit respecter les contraintes citées dans le document "Transmission de données ADAP-KOOL® Commande d'installation frigorifiques". Référence documentaire = [RC8AC904](#).

La instalación práctica del cable de comunicación de datos debe cumplir con los requisitos mencionados en el documento "Comunicación de datos entre controles de refrigeración ADAP-KOOL®". Número de documento = [RC8AC907](#).

**Terminering  
Termination  
Terminierung  
Terminaison  
Terminación**

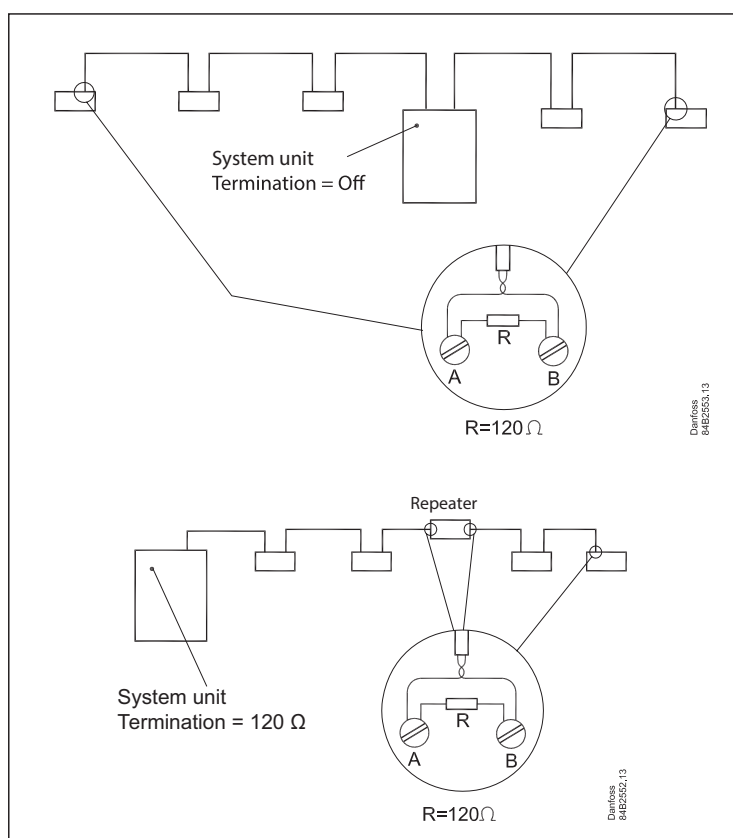
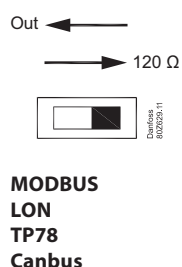

When all cables have been mounted on the different units, the cable must be terminated.

A section must be terminated at both ends. The section must be terminated using either an external resistor or a contact. Please see the relevant device.

A repeater will normally terminate two cable sections.

The termination should be made with a 120-ohm resistor. (The resistor can be in the range 100 – 130 ohms.)

A repeater will always terminate two cable sections.

**Connectivity**

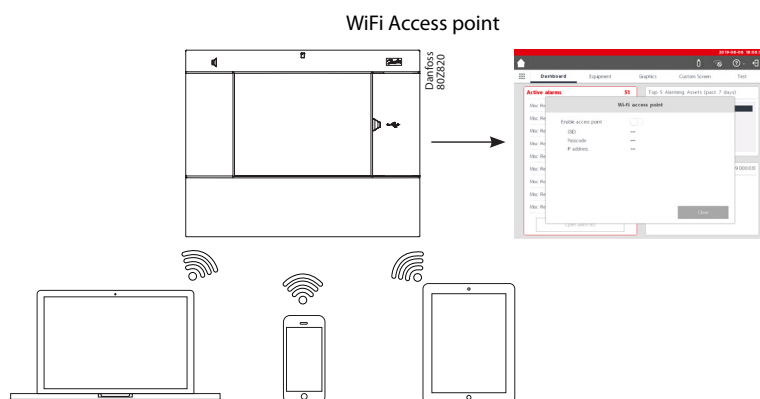
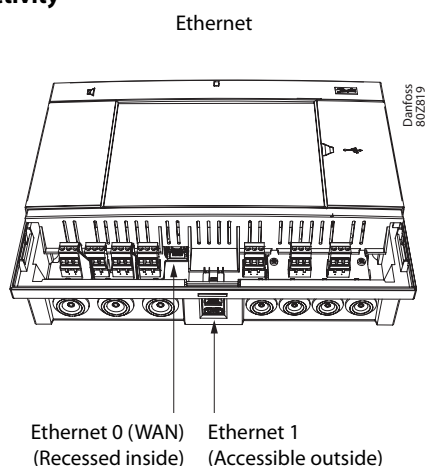

1. Activate WiFi access point from local screen
2. Follow on-screen instructions

**First time start-up**

AK-SM 820A  
 AK-SM 850A  
 AK-SM 880A

Address  
 Adresse  
 Dirección

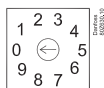

0 = Master  
 1 - 9 = Slave

Initial settings:



1. Legal terms
2. Select language for local screen
3. Set up user
4. Set Date/time
5. Select Units
6. Set Communication
7. OK and Finish

**IMPORTANT!**



Method 1: Offline  
 Download firmware from  
[ak-sm800a.danfoss.com](http://ak-sm800a.danfoss.com)



Method 2: Online  
 Use software update utility in the web interface.

## Statements for the AK-SM 800A

### FCC COMPLIANCE STATEMENT

CAUTION: Changes or modifications not expressly approved could void your authority to use this equipment

This device complies with Part 15 of the FCC Rules. Operation to the following two conditions: (1) This device may not cause harmful interference, and (2) this device must accept any interference received, including interference that may cause undesired operation

### INDUSTRY CANADA STATEMENT

This device complies with Industry Canada license-exempt RSS standard(s). Operation is subject to the following two conditions: (1) this device may not cause interference, and (2) this device must accept any interference, including interference that may cause undesired operation of the device.

Le présent appareil est conforme aux CNR d'Industrie Canada applicables aux appareils radio exempts de licence. L'exploitation est autorisée aux deux conditions suivantes : (1) l'appareil ne doit pas produire de brouillage, et (2) l'utilisateur de l'appareil doit accepter tout brouillage radioélectrique subi, même si le brouillage est susceptible d'en compromettre le fonctionnement.

## NOTICE

### FCC COMPLIANT NOTICE

This equipment has been tested and found to comply with the limits for a Class B digital device, pursuant to part 15 of the FCC Rules. These limits are designed to provide reasonable protection against harmful interference in a residential installation. This equipment generates, uses and can radiate radio frequency energy and, if not installed and used in accordance with the instructions, may cause harmful interference to radio communications. However, there is no guarantee that interference will not occur in a particular installation. If this equipment does cause harmful interference to radio or television reception, which can be determined by turning the equipment off and on, the user is encouraged to try to correct the interference by one or more of the following measures:

- Reorient or relocate the receiving antenna.
- Increase the separation between the equipment and receiver.
- Connect the equipment into an outlet on a circuit different from that to which the receiver is connected.
- Consult the dealer or an experienced radio/TV technician for help.

Modifications: Any modifications made to this device that are not approved by Danfoss may void the authority granted to the user by the FCC to operate this equipment.

Any regulatory related concerns contact: [global\\_approvals@danfoss.com](mailto:global_approvals@danfoss.com)

Danfoss Cooling  
11655 Crossroads Circle  
Baltimore, Maryland 21220  
United States of America  
[global\\_approvals@danfoss.com](mailto:global_approvals@danfoss.com)  
[www.danfoss.com](http://www.danfoss.com)

### EU CONFORMITY NOTICE

Hereby, Danfoss A/S declares that the radio equipment type AK-SM 800A is in compliance with Directive 2014/53/EU. The full text of the EU declaration of conformity is available at the following internet address: [www.danfoss.com](http://www.danfoss.com)

Danfoss A/S  
Nordborgvej 81  
6430 Nordborg  
Denmark  
[global\\_approvals@danfoss.com](mailto:global_approvals@danfoss.com)  
[www.danfoss.com](http://www.danfoss.com)

### DISCLAIMER: Professional Use Only

This product is not subject to the UK PSTI regulation, as it is for supply to and use only by professionals with the necessary expertise and qualifications. Any misuse or improper handling may result in unintended consequences.

By purchasing or using this product, you acknowledge and accept the professional-use-only nature of its application. Danfoss does not assume any liability for damages, injuries, or adverse consequences ("damage") resulting from the incorrect or improper use of the product and you agree to indemnify Danfoss for any such damage resulting from your incorrect or improper use of the product.

### SUBTEL technical declaration (Chile):

