

CE

Coils and Electronics



Danfoss

Coils and Electronics

Application Notes

Robust Coils

Danfoss Robust Coils are specifically designed for harsh, operating environments. Compared to standard coils, they have higher tolerances to temperature extremes, voltage spikes, and water ingress due to power spray, or immersion in water, snow or mud. Typical applications include asphalt machinery, agricultural equipment with chemical and power wash exposure, snow plows and salt-spreader machines.

Benefits of our robust coils:

- **Water Ingression Protection:** Designed to be highly water and chemical resistant. They have passed tests for Salt Fog, Chemical Splash, and Humidity.
- **Fully Encapsulated Windings:** The coil is designed with a protective layer of encapsulated plastic. A special molding technique prevents moisture build-up while the plastic is applied.
- **High Input Voltage Tolerance:** Robust coils are rated for an input of 75% to 133% of nominal voltage
- **Protective Metal Casing:** The metal exterior casing protects against dramatic temperature changes and physical damage to the coil. Robust coils have passed the Drop test, vibration test, and the mechanical shock test.
- **IP69K with Integral Connectors:** Robust coils with Deutsch, Amp SuperSeal, and Flying Leads are rated for IP69K.

ToughCoils™

Danfoss ToughCoils™ have been designed to provide industry leading environmental protection and solenoid performance in a compact and rugged package. ToughCoils™ with integrated connectors are rated up to IP69K environmental protection. ToughCoils™ are available with a variety of popular integrated connection options and with wire leads. The best in class, one-piece, shell encapsulated, design meets the most stringent environmental requirements for mobile and industrial applications.

Benefits of ToughCoils:

- **IP69K Environmental Protection:** This rating provides protection against the ingress of dust and high pressure jet stream. The IP69K test was designed specifically for rating protection against a high-pressure jet stream, high liquid temperature and close nozzle distance from the enclosure surface. IP69K protection is standard on ToughCoils™ with MetriPac1 or Deutsch integrated connectors.
- **“Thermal Shock Dunk” Test:** ToughCoils™ have been qualified to withstand the toughest Mobile Equipment “Thermal Shock Dunk” tests. Integrated Deutsch, MetriPack¹ and Leadwire² connectors exceed “Thermal Shock Dunk” test qualifications at 140°C. The “Thermal Shock Dunk” test requires coils to be heated, reaching a stabilized temperature of 100°C, then immediately immersed in a solution at 0°C. The thermal shock is repeated five times with the coil monitored for dielectric strength in the solution and functional performance is verified. In addition, ToughCoils™ passed a more severe powered dunk test conducted from 100° C to 0° C with 115% rated voltage applied.
- **Steel shell encapsulated design:** ToughCoils™ provide protection against physical and environmental damage.

¹MetriPack® 150 and MetriPack® 280 are registered trademarks of Delphi Packard Electric Systems

²Coils with integrated connectors are recommended for applications in harsh environments.

Coils and Electronics

Application Notes

Coil Termination Specifications

Code	Termination	Specifications
AJ	Amp Junior	Integral to coil
AS	Amp SuperSeal 1.5 (also conforms to MetriPak 150 Type 1)	Integral to coil; mating connector is Delphi-Packard Part Number 12052641
C	Deutsch	DT04-2P on wire leads
D	MetriPak 150	Integrated (DC only), Mating Connector: Delphi 12052641
DE	Deutsch	Integral to coil; mating connector is Deutsch IPD (Industrial Products Division) Part Number DT06-2S
DED	Deutsch with diode	Integral to coil; mating connector is Deutsch IPD (Industrial Products Division) Part Number DT06-2S
DN	DIN 43650	DIN 43650A / ISO 4400 standard electrical connector
F	Flying Leads	C13/C16, DC only
FL & FL600	Flying leads	Two 18 AWG wires, 600 mm [24 in] long
FLD	Flying leads with diode	Two 18 AWG wires, 600 mm [24 in] long
G	DIN 43650	DIN 43650A / ISO 4400 standard electrical connector
H	DIN 43650	DIN 43650A / ISO 4400 standard electrical connector
J	MetriPak 280	Integrated (DC only), Mating Connector: Delphi 15300027
L	Lead Wires	Two 18 AWG wires, 457 mm [18 in] long
M2	Metri-Pak 150 Type 1 (also conforms to Amp SuperSeal 1.5)	Integral to coil; mating connector is Delphi-Packard Part Number 12052641
N	Deutsch	DT04-2P integrated (DC only), Mating Connector: Deutsch DT06-2S
S	Dual Spade	Two 6.35 mm [0.25 in] wide Type 1B spade terminals per SAE J858A
U	DIN 43650	DIN 43650A / ISO 4400 standard electrical connector
W	Flying Leads	Refer to each coil page for length specifications
Y	Amp Junior	DC only, Mating Connector: AMP 963040-3 or equivalent
Y	MetriPak 150	Male on leads

PLUS+1™ Compliant

Danfoss ICS solenoid valves are PLUS+1™ compliant. PLUS+1 compliance means our coils are directly compatible with the PLUS+1 machine control architecture. Adding solenoid valves to your application using PLUS+1 GUIDE software is as easy as drag-and-drop. Software development that used to take months can now be done in just a few hours. For more information on PLUS+1 GUIDE,

<https://www.danfoss.com/en/products/dps/software/software-and-tools/plus1-software/plus1-guide/>.

The table below details available GUIDE function blocks for controlling Danfoss ICS coils.

Guide function blocks

On-off	SW00001452
On-off-on	SW00001453
Proportional (two way):	SW00001949
Dual Proportional (three way):	SW00002294

Coils and Electronics

Quick Reference

Coil name	Description	Page
M13	20W Standard Coil	5
R13	16W Robust Coil	7
S series	20W ToughCoil	9
P series	23W ToughCoil	11
C13	Standard Coil	13
M16	26W Standard Coil	14
R16	20W Robust Coil	16
J series	23W ToughCoil	18
K series	10W ToughCoil	20
H series	29W ToughCoil	21
L series	28W Large ToughCoil	23
C16	Standard Coil	24
M19	33W Standard Coil	25
D14E [30W]	30W Robust Coil	27
R series	30W Large ToughCoil	29
M19P	22W Proportional Coil	30
D14E [35W]	35W Proportional Coil	31
EPV series	EPV Proportional Coil	32
E series	EFV Proportional Coil	33
DIN connectors		34

Coils and Electronics

M13

20W Standard Coil

■ PERFORMANCE DATA

Duty cycle	100% at 115% of rated voltage at 40°C [104°F]
Magnet wire insulation	200°C [392°F]
Ambient temperature range	-20 to 40 °C [-4 to 104 °F]
Input voltage range	85% to 115% of rated voltage
Temperature rise at 115% of rated voltage	130°C [266°F] above ambient
Weight	0.2 kg [0.44 lb]

■ ENVIRONMENT PROTECTION

Rating	Connector Type
IP65	FL, FLD, and DN
IP67	AJ, AJD, AS, and ASD
IP69K	DE, DED

■ ELECTRICAL SPECIFICATIONS

Voltage	10 VDC	12 VDC	20 VDC	24 VDC	110 VAC*	220 VAC*
Resistance (Ohms) @ 20 °C [68 °F]	5	7.2	20	29	530	2306
Current draw (A) @ 20 °C [68 °F]	2	1.67	1	0.83	0.18	0.085
Power (W)	20	20	20	20	18.5	17

*External rectifier required

■ PERFORMANCE CURVES

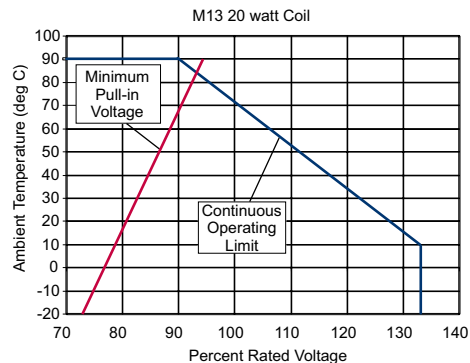

Diode Information

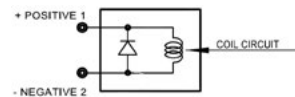

Built-in, uni-directional polarity diode
(Model # 1N5406)

■ MODEL CODE

M13 - 10D - 20W - AJ

Coil Voltage

Code	Coil Voltage
10D	10VDC
12D	12 VDC
20D	20 VDC
24D	24 VDC
110A	110 VAC*
220A	220 VAC*

*DIN only - external rectifier needed

Coil Power

Connector Type

Code	Connector Type
AJ	Amp Junior
AJD	Amp Junior with Diode
AS	AMP SuperSeal 1.5
ASD	AMP SuperSeal with Diode
DE	Deutsch
DED	Deutsch with Diode
FL	Flying Leads
FLD	Flying Leads with Diode
DN	DIN 43650

■ DIMENSIONS

mm [in]

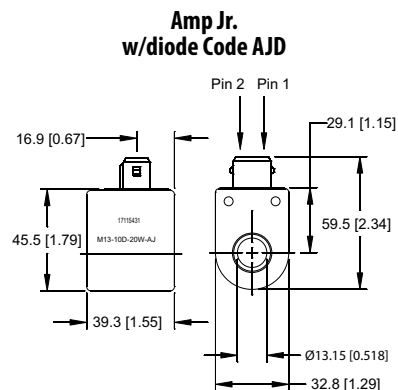
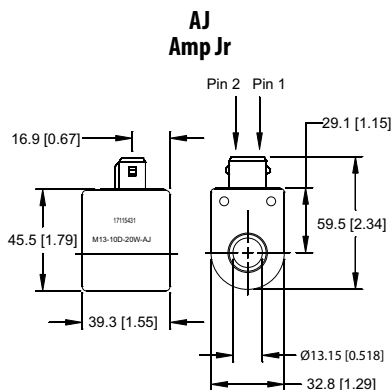

Coils and Electronics

M13

20W Standard Coil

■ DIMENSIONS

mm [in]

AS
Amp SuperSeal 1.5/MetriPak 150 Type 1

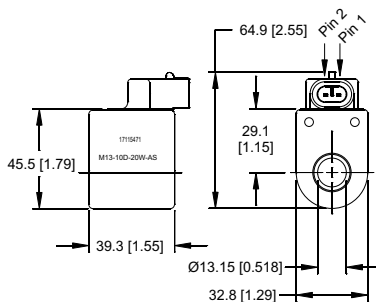

ASD
Amp SuperSeal 1.5/MetriPak 150 Type 1 w/diode

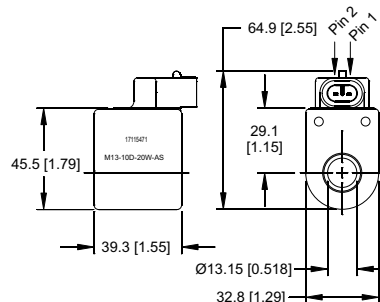

DE
Deutsch

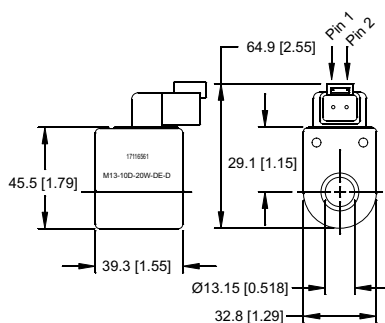

DED
Deutsch w/diode

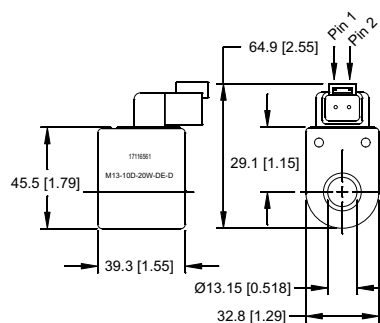

FL
Lead wires

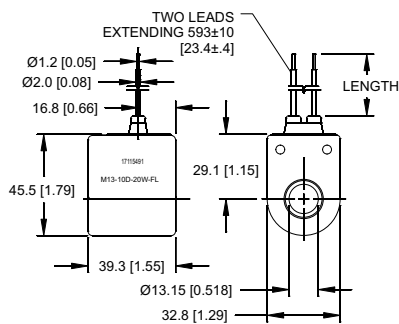

FLD
Lead wires w/diode

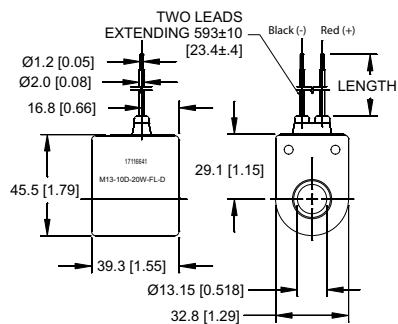

DN
ISO 4400 (DIN 43650)

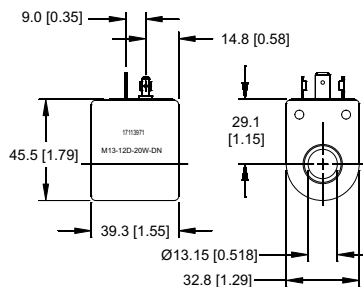

Coils and Electronics

R13

16W Robust Coil

PERFORMANCE DATA

Duty cycle	100% at 133% of rated voltage and 70°C [158°F]
Magnet wire insulation	200°C [392°F]
Ambient temperature range	-40 to +70 °C [-40 to 158 °F]
Input voltage range	75% to 133% of rated voltage
Weight	0.22 kg [0.49 lb]

ENVIRONMENT PROTECTION

Rating	Connector Type
IP69K	AS, ASDB, DE, DEDB, FL, FLDB

ELECTRICAL SPECIFICATIONS

Voltage	10 VDC	12 VDC	20 VDC	24 VDC
Resistance (Ohms) @ 20 °C [68 °F]	6.2	9	25	36
Current draw (A) @ 20 °C [68 °F]	1.62	1.34	0.81	0.67
Power (W)	16	16	16	16
Retainer Color	Green	Gray	Blue	Yellow

PERFORMANCE CURVES

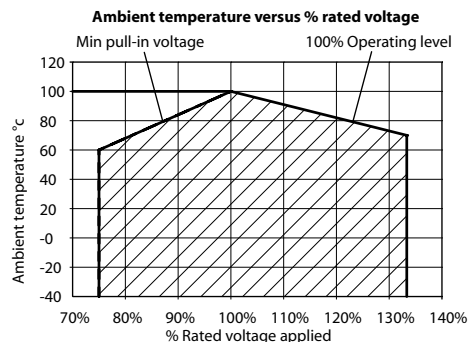

Diode Information

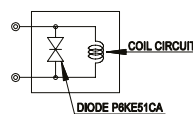

Bi-directional, transient voltage suppression diodes:
Non polarity dependent, 51 volt nominal breakdown voltage.

MODEL CODE

R13 - 10D - 16W - AJ - UL

Coil Voltage

Code	Coil Voltage
10D	10VDC
12D	12 VDC
20D	20 VDC
24D	24 VDC

Coil Power

Connector Type

Code	Connector Type
AS	AMP SuperSeal 1.5
ASDB	AMP SuperSeal with Diode
DE	Deutsch
DEDB	Deutsch with Diode
FL	Flying Leads
FLDB	Flying Leads with Diode

UL Rating

Omit - Non-UL rated
UL - UL rated (DE only)
*Certificate available upon request

DIMENSIONS

mm [in]

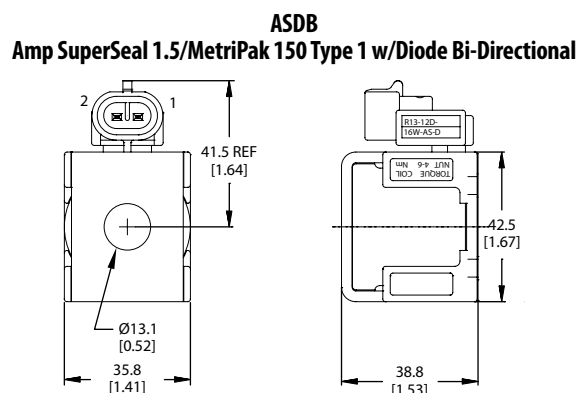
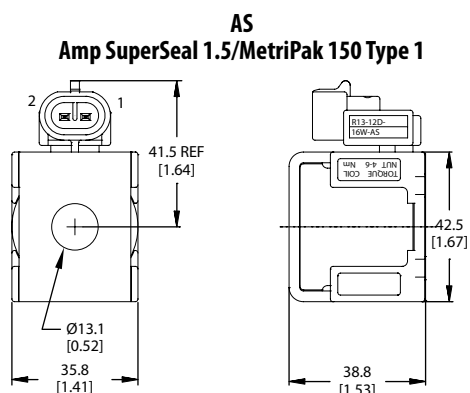

Coils and Electronics

R13

16W Robust Coil

■ DIMENSIONS

mm [in]

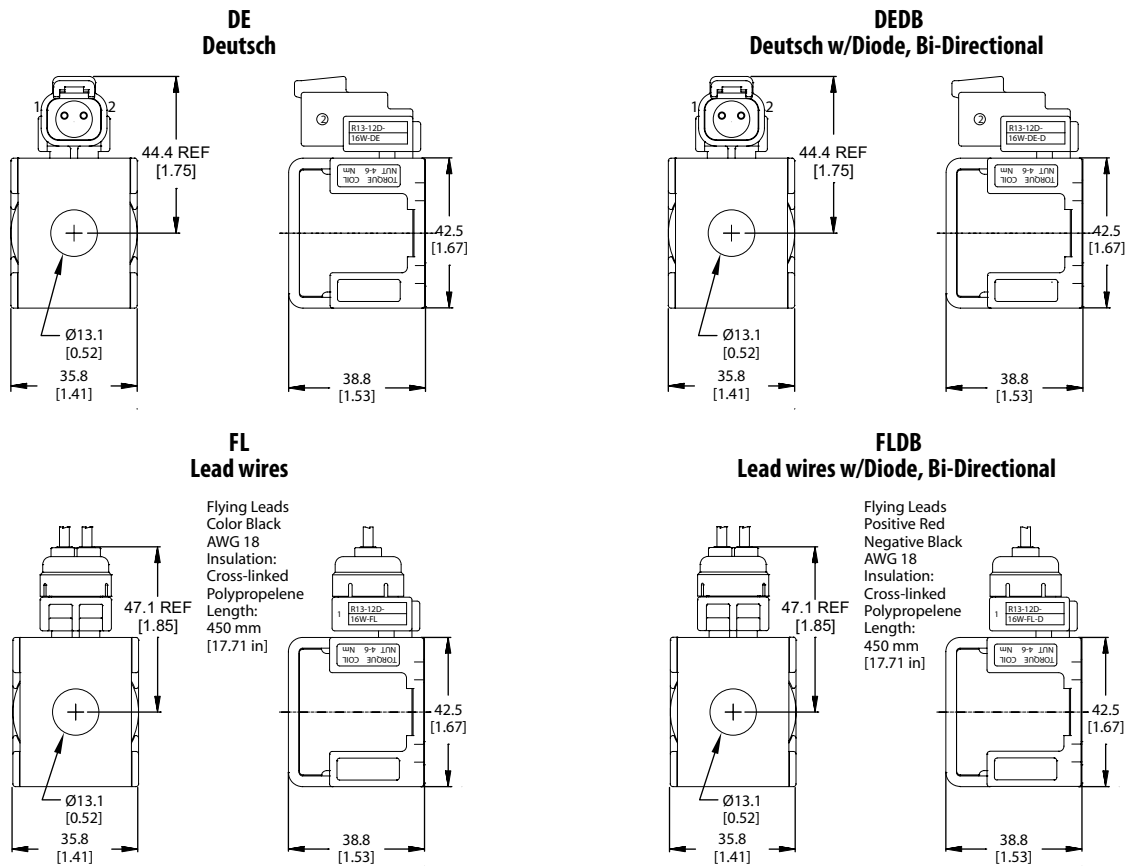

Coils and Electronics

S series

20W ToughCoil

■ PERFORMANCE DATA

Duty cycle	100% at 110% of rated voltage
Magnet wire insulation	U.L. class N, 200°C [392°F] NEMA pub. No. MW 1000, section MW 35 – C [single]
Ambient temperature	100°C [212°F] continuous @ rated voltage
Input Voltage Range	85% to 110% of rated voltage
UL Rated (certificate available upon request)	

■ ENVIRONMENT PROTECTION

Rating	Connector Type
IP65	G0*
IP67	Y0, W0
IP69K	NO, DO, JO
Thermal shock dunk	W0 ¹ , NO, DO, JO

¹Passed environmental testing, but not as robust as other connectors

*Rating dependent on mating connector

■ ELECTRICAL SPECIFICATIONS

Voltage	12 VDC	24 VDC	115 VAC	230 VAC
Current (A)	1.67	0.83	0.19	0.10
Power (W)	20	20	20	20

*Nominal voltage 25°C (77°F).

Diode Information

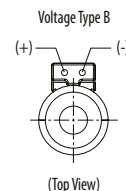

Flyback diode (arc suppressor), maximum recurrent peak reverse voltage - 800V

■ MODEL CODE

MCSC - S - 012 - D - G0 - 0 - 00 - 10

Coil Series
S - Size 8 [210 bar]

Coil Voltage

Code	Coil Voltage
012	12 VDC
024	24 VDC
115	115 VAC
230	230 VAC

Voltage Type
D - DC
B - DC/with flyback diode
A - AC/with full bridge rectifier

Lead Length
0 - None
A - 152mm [6.0 in] (Standard length with connector)
B - 610mm [24.0 in] (Standard length without connector)

Connector Type
G0 - ISO 4400 DIN 43650
Q0 - Spade terminals
W0 - Flying lead
NO - Deutsch (DC only)
Y0 - Amp JR (DC only)
DO - Metripack 150 male (DC only)
JO - Metripack 280 male (DC only)

■ PART NUMBERS (300AA00 ____ - COMPLETE PART NUMBER IS 11 DIGITS)

Voltage	G0** Connector	Q0 Connector	W0 Connector	NO Connector	Y0 Connector	DO Connector	JO Connector
12VDC	001A	009A	015A	021A	026A	031A	036A
24VDC	002A	010A	016A	022A	027A	032A	037A
115VAC	005A						
230VAC	006A						
12VDC*	007A	013A	019A	024A	029A	034A	039A
24VDC*	008A	014A	020A	025A	030A	035A	040A

*With flyback diode. (Voltage Type B)

**DIN 43560 mating connector for "G0" style coil – 02-166796 or AXP14116.

Coils and Electronics

S series

20W Standard Coil

■ DIMENSIONS

mm [in]

G0
DIN 43650

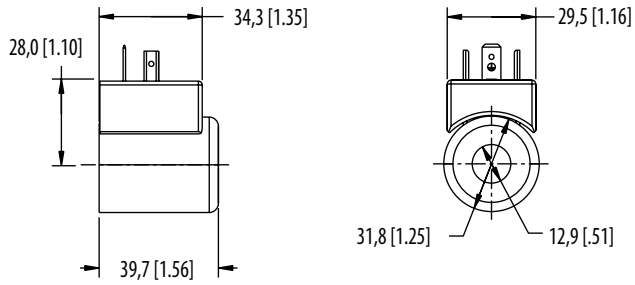

Q0
Spade connector

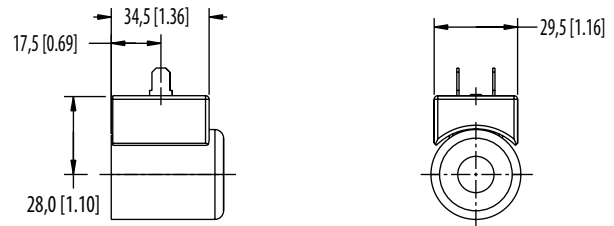

W0
Leadwire

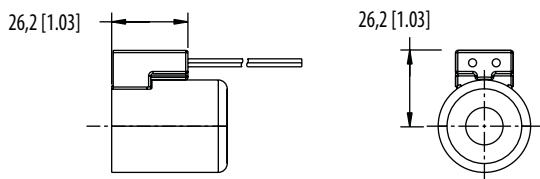

N0
Deutsch Male DT04-2P

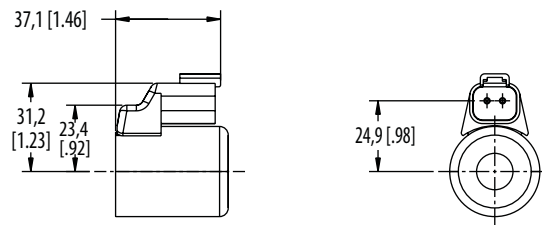

Y0
AMP Junior

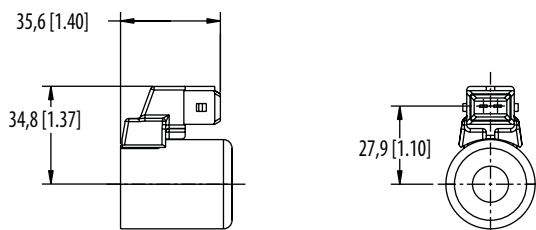

D0
Metri-Pack 150 Male

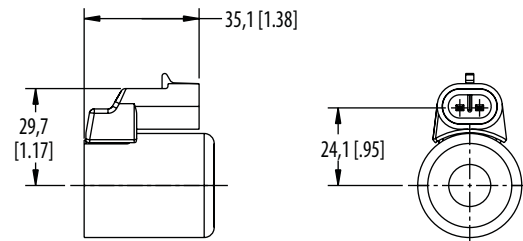

J0
Metri-Pack 280 Male

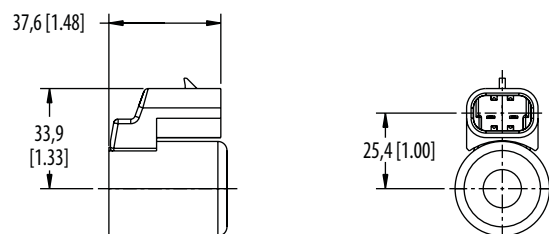

Coils and Electronics

P series

23W ToughCoil

■ PERFORMANCE DATA

Duty cycle	100% at 110% of rated voltage
Magnet wire insulation	U.L. class N, 200°C [392°F] NEMA pub. No. MW 1000, section MW 35 – C [single]
Ambient temperature	100°C [212°F] continuous @ rated voltage
Input Voltage Range	85% to 110% of rated voltage
UL Rated (certificate available upon request)	

■ ENVIRONMENT PROTECTION

Rating	Connector Type
IP65	G0*
IP67	Y0, W0
IP69K	NO, DO, JO
Thermal shock dunk	W0, NO, DO, JO

*Passed environmental testing, but not as robust as other connectors

*Rating dependent on mating connector

■ ELECTRICAL SPECIFICATIONS

Voltage	12 DC	24 DC	115 AC	230 AC
Current (A)	1.92	0.96	0.22	0.11
Power (W)	23	23	23	23

*Nominal voltage 25°C (77°F).

Diode Information

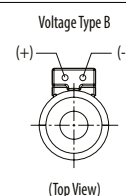

Flyback diode
(arc suppressor),
maximum recurrent
peak reverse voltage
- 800V

■ MODEL CODE

MCSC - P - 012 - D - NO - 0 - 00 - 10

Coil Series

P - Size 8 [350 Bar]

Coil Voltage

Code	Coil Voltage
012	12 VDC
024	24 VDC
115	115 VAC
230	230 VAC

Voltage Type

D - DC
B - DC/with flyback diode
A - AC/with full bridge rectifier

Lead Length

0 - None
A - 152mm [6.0 in]
(Standard length with connector)
B - 610mm [24.0 in]
(Standard length with connector)

Connector Type

G0 - ISO 4400 DIN 43650
Q0 - Spade terminals
W0 - Flying lead
NO - Deutsch (DC only)
YO - Amp JR (DC only)
DO - Metripack 150 male (DC only)
JO - Metripack 280 male (DC only)

■ PART NUMBERS (300AA00_____ - COMPLETE PART NUMBER IS 11 DIGITS)

Voltage	G0** Connector	Q0 Connector	W0 Connector	NO Connector	YO Connector	DO Connector	JO Connector
12VDC	041A	049A	055A	061A	066A	071A	076A
24VDC	042A	050A	056A	062A	067A	072A	077A
115VAC	045A						
230VAC	046A						
12VDC*	047A	053A	059A	064A	069A	074A	079A
24VDC*	048A	054A	060A	065A	070A	075A	080A

*With flyback diode. (Voltage Type B)

**DIN 43560 mating connector for "G0" style coil – 02-166796 or AXP14116.

Coils and Electronics

P series

23W ToughCoil

■ DIMENSIONS

mm [in]

G0
DIN 43650

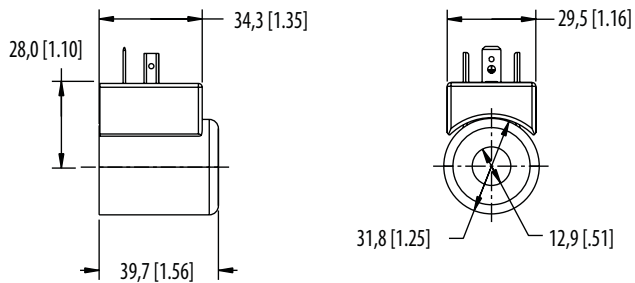

Q0
Spade connector

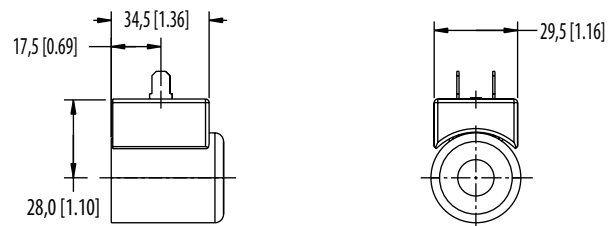

W0
Leadwire

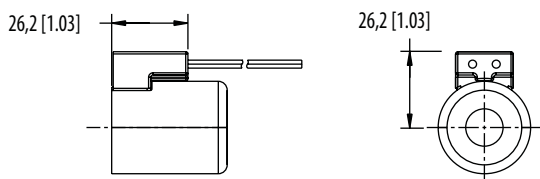

N0
Deutsch Male DT04-2P

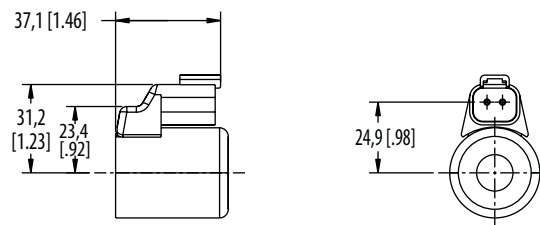

Y0
AMP Junior

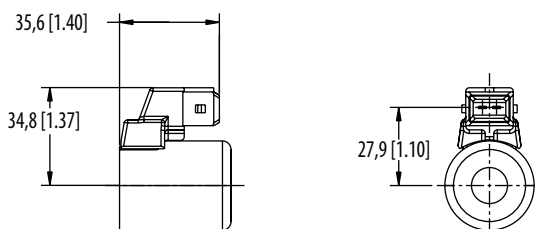

D0
Metri-Pack 150 Male

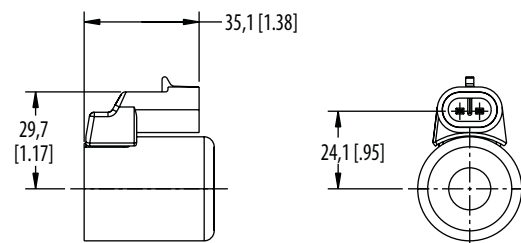

J0
Metri-Pack 280 Male

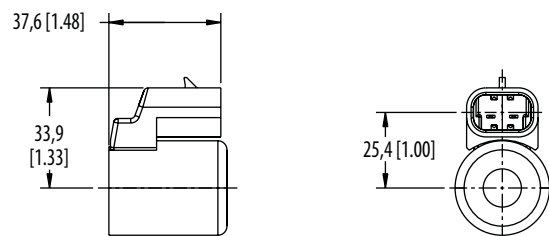

Coils and Electronics

C13

Standard Coil

■ PERFORMANCE DATA

Duty cycle 100% at 110% rated voltage between -20°C and 40°C

Magnet wire insulation 200°C [392° F]

Input Voltage Range 90% to 110% of rated voltage

■ MODEL CODE

C13 - H - 24 - 22

Coil Series
C13 -13 mm tube

Coil Power
14 -14 Watt
22 -22 Watt
27 -27 Watt

Connector Type

Code	Connector Type
H	DIN43650 ISO Standard
F	Flying Leads [12 and 24 VDC only]
DM	Deutsch Moulded [12 and 24 VDC only]

Coil Voltage

Code	Coil Voltage
12	12 VDC
24	24 VDC
110	110 VAC*
220	220 VAC*

*External rectifier required: AXP9997-115 or AXP9997-230

■ DIMENSIONS

mm [in]

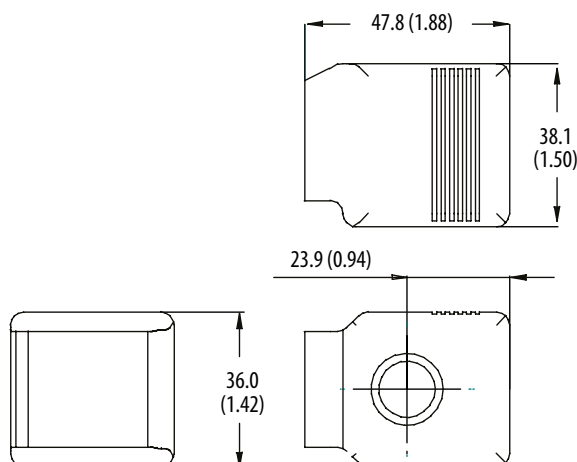

Coils and Electronics

M16

26W Standard Coil

PERFORMANCE DATA

Duty cycle	100% at 115% of rated voltage at 40°C [104°F]
Magnet wire insulation	200°C [392°F]
Ambient temperature range	-20 to 40 °C [-4 to 104 °F]
Input voltage range	85% to 115% of rated voltage
Temperature rise at 115% of rated voltage	130°C [266°F] above ambient
Weight	0.24 kg [0.53 lb]

ENVIRONMENT PROTECTION

Rating	Connector Type
IP65	FL, FLD, and DN
IP67	AJ, AJD, AS, and ASD
IP69K	DE and DED

ELECTRICAL SPECIFICATIONS

Voltage	10 VDC	12 VDC	20 VDC	24 VDC	110VAC*	220 VAC*
Resistance (Ohms) @ 20 °C [68 °F]	4	5.6	15	22	420	1600
Current draw (A) @ 20 °C [68 °F]	2.5	2.14	1.33	1.1	0.23	0.12
Power (W)	26	26	26	26	22	22

*External rectifier required

PERFORMANCE CURVES

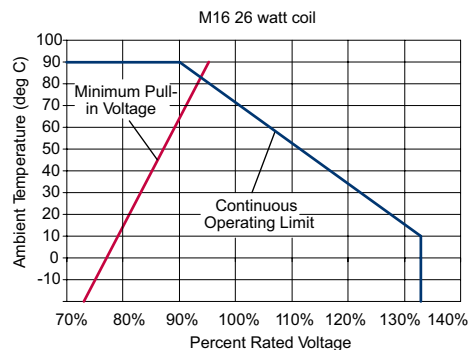

Diode Information

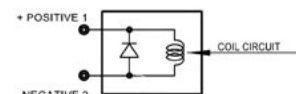

Built-in, uni-directional polarity diode
(Model # 1N5406)

MODEL CODE

M16 - 10D - 26W - AJ

Coil Voltage		Coil Power	Connector Type	
Code	Coil Voltage		Code	Connector Type
10D	10VDC	26	AJ	Amp Junior
12D	12 VDC		AJD	Amp Junior with Diode
20D	20 VDC		AS	AMP SuperSeal 1.5
24D	24 VDC		ASD	AMP SuperSeal with Diode
110A	110 VAC*		DE	Deutsch
220A	220 VAC*		DED	Deutsch with Diode
			FL	Flying Leads
			FLD	Flying Leads with Diode
			DN	DIN 43650

*DIN only - external rectifier needed

DIMENSIONS

mm [in]

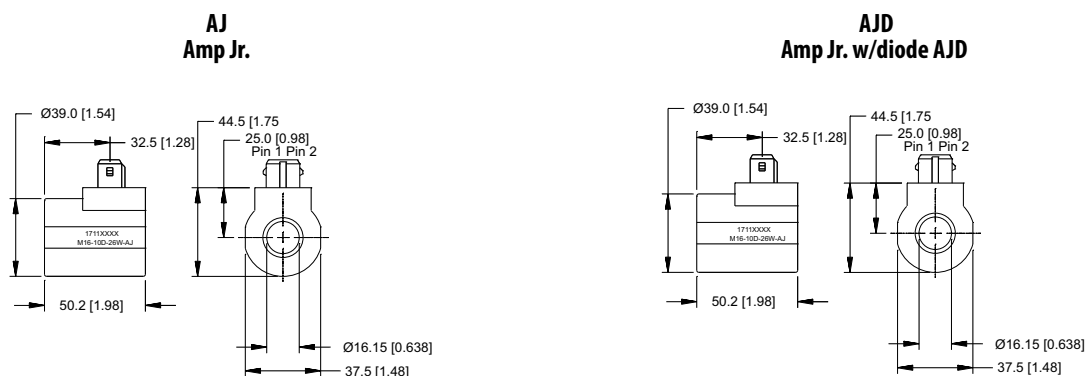

Coils and Electronics

M16

26W Standard Coil

■ DIMENSIONS

mm [in]

AS
Amp SuperSeal 1.5/MetriPak 150 Type 1

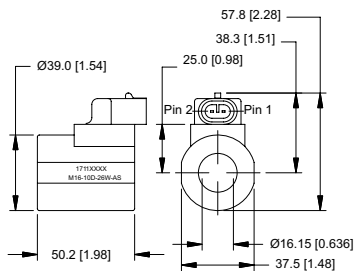

ASD
Amp SuperSeal 1.5/MetriPak 150 Type 1 w/diode

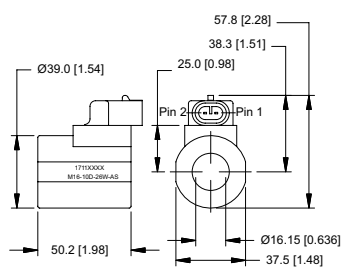

DE
Deutsch

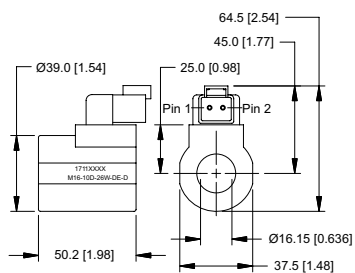

DED
Deutsch w/diode

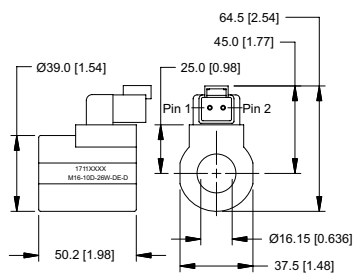

FL
Lead wires

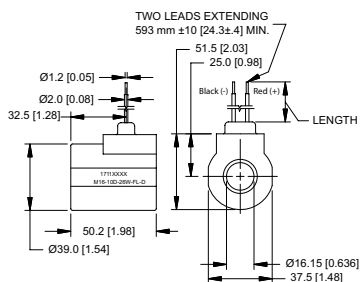

FLD
Lead wires w/diode

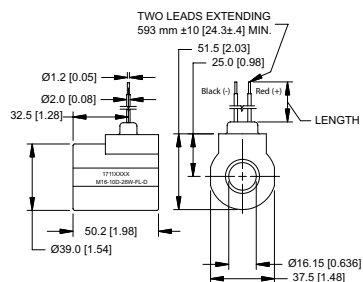

DN
ISO 4400 (DIN 43650)

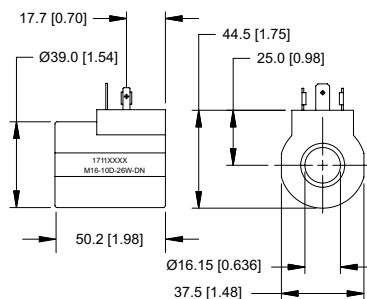

Coils and Electronics

R16

20W Robust Coill

■ PERFORMANCE DATA

Duty cycle	100% at 133% of rated voltage and 70°C [158°F]
Magnet wire insulation	200°C [392°F]
Ambient temperature range	-40 to +70 °C [-40 to 158 °F]
Input voltage range	75% to 133% of rated voltage
Weight	0.34 kg [0.75 lb]

■ ENVIRONMENT PROTECTION

Rating	Connector Type
IP69K	AS, ASDB, DE, DEDB, FL, FLDB

■ ELECTRICAL SPECIFICATIONS

Voltage	10 VDC	12 VDC	20 VDC	24 VDC
Resistance (Ohms) @ 20 °C [68 °F]	4.8	6.9	20	28
Current draw (A) @ 20 °C [68 °F]	2.08	1.74	1.01	0.85
Power (W)	20	20	20	20
Retainer Color	Green	Gray	Blue	Yellow

■ PERFORMANCE CURVES

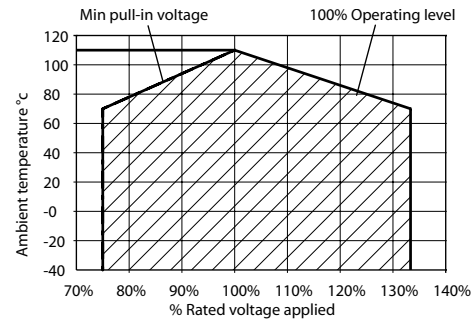

Diode Information

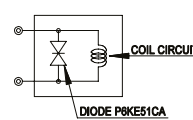

Bi-directional, transient voltage suppression diodes:
Non polarity dependent, 51 volt nominal breakdown voltage.

■ MODEL CODE

R16 - 10D - 20W - AJ - UL

Code	Coil Voltage
10D	10 VDC
12D	12 VDC
20D	20 VDC
24D	24 VDC

Coil Power

Connector Type

Code	Connector Type
AS	Amp SuperSeal 1
ASDB	Amp SuperSeal 1.5 with bi-directional diode
DE	Deutsch
DEDB	Deutsch with Diode
FL	Flying Leads
FLDB	Flying Leads with Diode

UL rating

Omit -Non-UL rated
UL -UL Rated (DE only)
*Certificate available upon request

■ DIMENSIONS

mm [in]

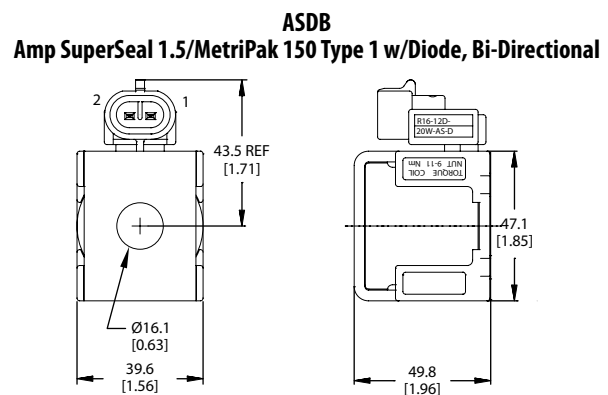
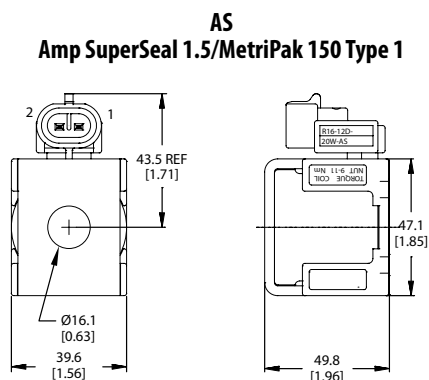

Coils and Electronics

R16

20W Robust Coill

■ DIMENSIONS

mm [in]

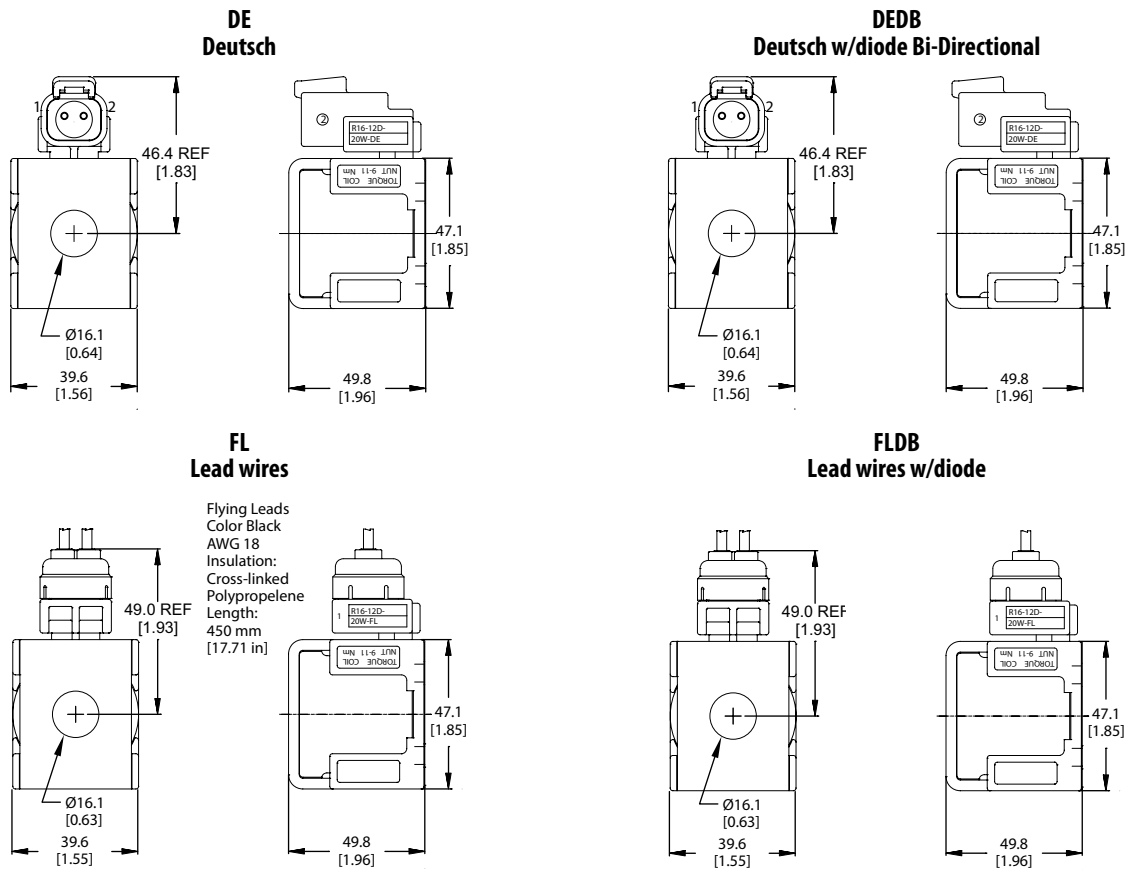

Coils and Electronics

J series

23W ToughCoil

■ PERFORMANCE DATA

Duty cycle	100% at 110% of rated voltage
Magnet wire insulation	U.L. class N, 200°C [392°F] NEMA pub. No. MW 1000, section MW 35 – C [single]
Ambient temperature	100°C [212°F] continuous @ rated voltage
Input Voltage Range	85% to 110% of rated voltage
UL Rated (certificate available upon request)	

■ ENVIRONMENT PROTECTION

Rating	Connector Type
IP65	G0*
IP67	Y0, W0
IP69K	NO, DO, JO
Thermal shock dunk	W0 ¹ , NO, DO, JO

¹Passed environmental testing, but not as robust as other connectors

*Rating dependent on mating connector

■ ELECTRICAL SPECIFICATIONS

Voltage	12 VDC	24 VDC	115 VAC	230 VAC
Current (A)	1.92	0.96	0.22	0.11
Power (W)	23	23	23	23

*Nominal voltage 25°C (77°F).

Diode Information

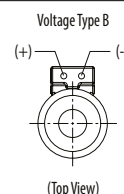

Flyback diode (arc suppressor), maximum recurrent peak reverse voltage - 800V

■ MODEL CODE

MCSC - J - 012 - D - G0 - 0 - 00 - 10

Coil Series
J - Size 10, 12, 16, 20 [210 Bar]

Coil Voltage

Code	Coil Voltage
012	12 volt
024	24 volt
115	115 volt
230	230 volt

Voltage Type
D - DC
B - DC/with flyback diode
A - AC/with full bridge rectifier

Lead Length
0 - None
A - 152mm [6.0 in] (Standard length with connector)
B - 610mm [24.0 in] (Standard length without connector)

Connector Type
G0 - ISO 4400 DIN 43650
Q0 - Spade terminals
W0 - Flying lead
NO - Deutsch (DC only)
YO - Amp JR (DC only)
DO - Metripack 150 male (DC only)
JO - Metripack 280 male (DC only)

■ PART NUMBERS - (300AA00_____ - COMPLETE PART NUMBER IS 11 DIGITS)

Voltage	G0** Connector	Q0 Connector	W0 Connector	NO Connector	YO Connector	DO Connector	JO Connector
12VDC	081A	089A	095A	101A	106A	111A	116A
24VDC	082A	090A	096A	102A	107A	112A	117A
115VAC	085A						
230VAC	086A						
12VDC*	087A	093A	099A	104A	109A	114A	119A
24VDC*	088A	094A	100A	105A	110A	115A	120A

*With flyback diode. (Voltage Type B)

**DIN 43560 mating connector for "G0" style coil – 02-166796 or AXP14116.

Coils and Electronics

J series

23W ToughCoil

■ DIMENSIONS

mm [in]

G0
DIN 43650

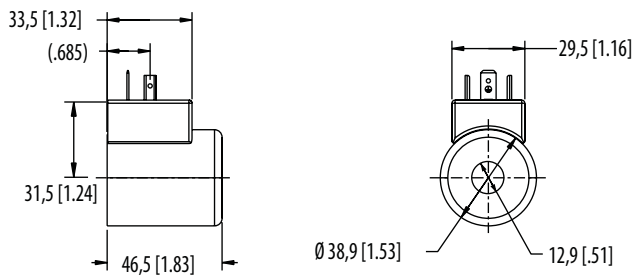

Q0
Spade connector

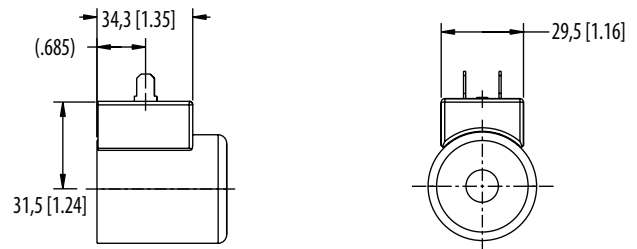

W0
Leadwire

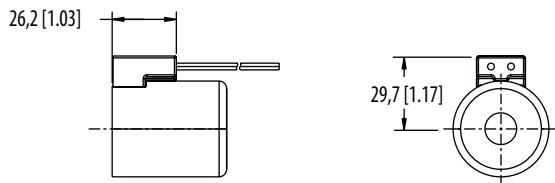

N0
Deutsch male DT04-2P integrated connector

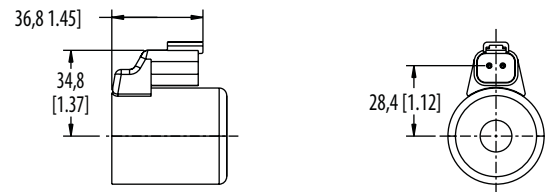

Y0
AMP Junior timer integrated connector

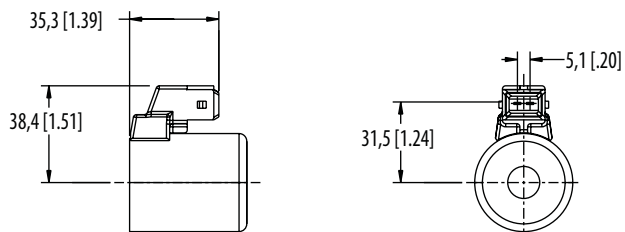

D0
Metri-Pack 150 Male, integrated connector

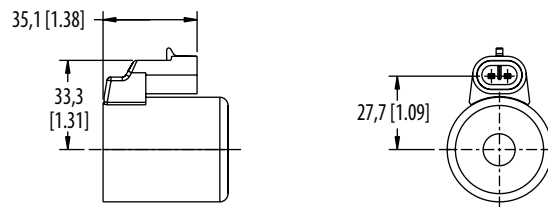

J0
Metri-Pack 280 Male, integrated connector

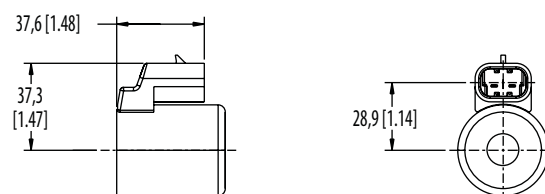

Coils and Electronics

K series

10W ToughCoil

■ PERFORMANCE DATA

Duty cycle	100% at 110% of rated voltage
Magnet wire insulation	U.L. class N, 200°C [392°F] NEMA pub. No. MW 1000, section MW 35 – C [single]
Ambient temperature	100°C [212°F] continuous @ rated voltage
Input Voltage Range	85% to 110% of rated voltage

■ ENVIRONMENT PROTECTION

Rating	Connector Type
IP69K	NO
Thermal shock dunk	NO

■ ELECTRICAL SPECIFICATIONS

Voltage	12 VDC	24 VDC
Current (A)	0.78	0.41
Power (W)	10	10

*Nominal voltage 25°C (77°F).

■ MODEL CODE

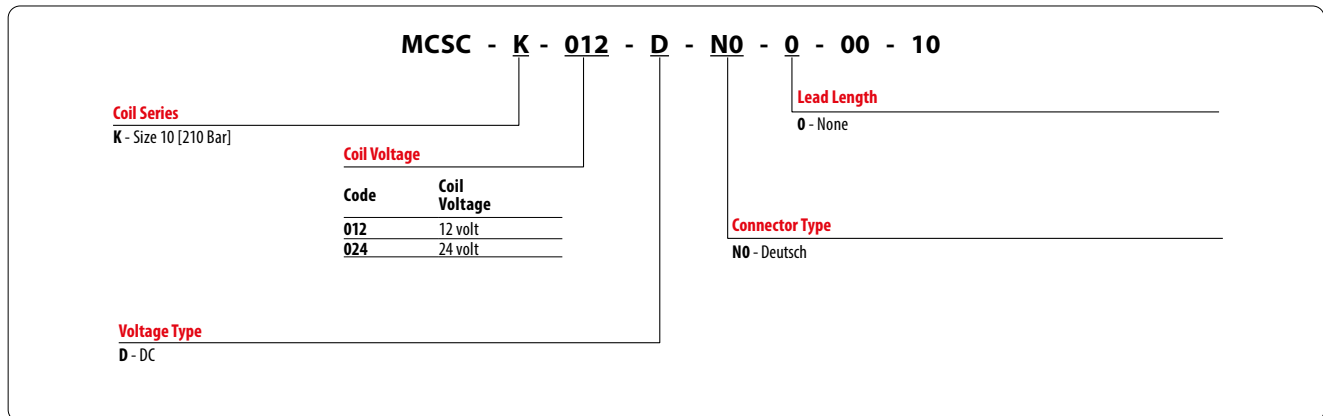

■ PART NUMBERS

Voltage	NO Connector
12VDC	12007809
24VDC	12007810

■ DIMENSIONS

mm [in]

NO
Deutsch male DT04-2P integrated connector

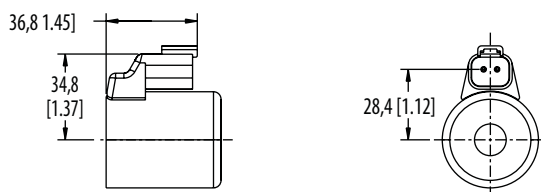

Coils and Electronics

H series

29W ToughCoil

■ PERFORMANCE DATA

Duty cycle	100% at 110% of rated voltage
Magnet wire insulation	U.L. class N, 200°C [392°F] NEMA pub. No. MW 1000, section MW 35 – C [single]
Ambient temperature	100°C [212°F] continuous @ rated voltage
Input Voltage Range	85% to 110% of rated voltage
UL Rated (certificate available upon request)	

■ ENVIRONMENT PROTECTION

Rating	Connector Type
IP65	G0*
IP67	Y0, W0
IP69K	NO, DO, JO
Thermal shock dunk	W0 ¹ , NO, DO, JO

¹Passed environmental testing, but not as robust as other connectors

*Rating dependent on mating connector

■ ELECTRICAL SPECIFICATIONS

Voltage	12 DC	24 DC	115 AC	230 AC
Current (A)	2.42	1.21	0.28	0.14
Power (W)	29	29	29	29

*Nominal voltage 25°C (77°F).

Diode Information

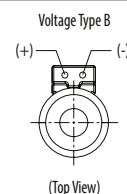

Flyback diode (arc suppressor), maximum recurrent peak reverse voltage - 800V

■ MODEL CODE

MCSC - H - 012 - D - W0 - A - 00 - 10

Coil Series

H - Size 10, 12, 16, 20 [350 Bar]

Coil Voltage

Code	Coil Voltage
012	12 volt
024	24 volt
115	115 volt
230	230 volt

Voltage Type

D - DC
B - DC/with flyback diode
A - AC/with full bridge rectifier

Lead Length

0 - None
A - 152mm [6.0 in]
(Standard length with connector)
B - 610mm [24.0 in]
(Standard length without connector)

Connector Type

G0 - ISO 4400 DIN 43650
Q0 - Spade terminals
W0 - Flying lead
N0 - Deutsch (DC only)
Y0 - Amp JR (DC only)
D0 - Metripack 150 male (DC only)
J0 - Metripack 280 male (DC only)

■ PART NUMBERS - (300AA00_____ - COMPLETE PART NUMBER IS 11 DIGITS)

Voltage	G0** Connector	Q0 Connector	W0 Connector	N0 Connector	Y0 Connector	D0 Connector	J0 Connector
12VDC	121A	129A	135A	141A	146A	151A	156A
24VDC	122A	130A	136A	142A	147A	152A	157A
115VAC	125A	–	–	–	–	–	–
230VAC	126A	–	–	–	–	–	–
12VDC*	127A	133A	139A	144A	149A	154A	159A
24VDC*	128A	134A	140A	145A	150A	155A	160A

*With flyback diode. (Voltage Type B)

**DIN 43560 mating connector for "G0" style coil – 02-166796 or AXP14116.

Coils and Electronics

H series

29W ToughCoil

■ DIMENSIONS

mm [in]

G0
DIN 43650

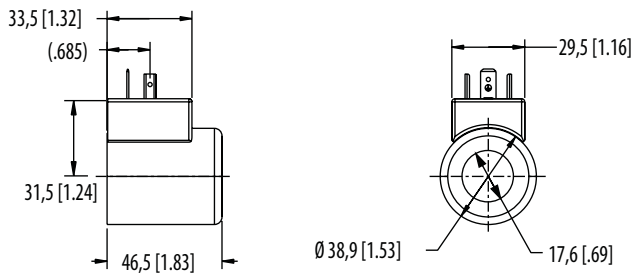

Q0
Spade connector

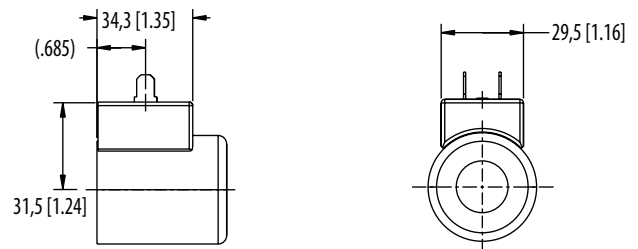

W0
Leadwire

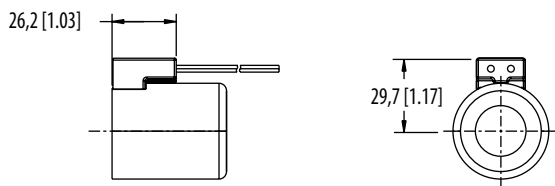

N0
Deutsch male DT04-2P integrated connector

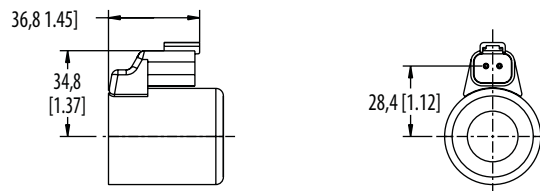

Y0
AMP Junior timer integrated connector

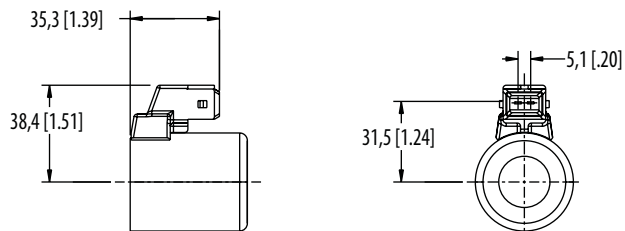

D0
Metri-Pack 150 Male, integrated connector

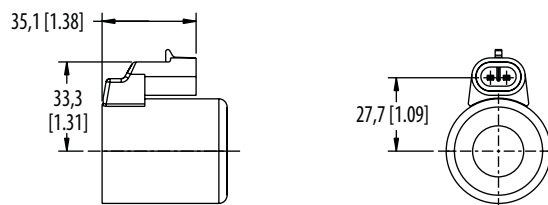

J0
Metri-Pack 280 Male, integrated connector

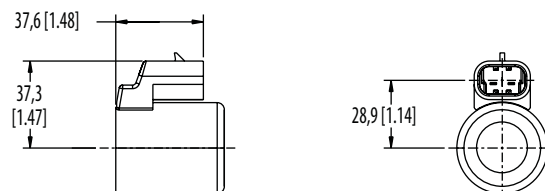

Coils and Electronics

L series

28W Large ToughCoil

■ PERFORMANCE DATA

Duty cycle	100% at 85% to 110% of rated voltage
Operating temperature	100°C (212°F) continuous @ rated voltage
Magnet Wire Insulation	U.L. class N, 200°C (392°F) NEMA pub. No. MW 1000, section MW 35 – C (single)

■ ENVIRONMENT PROTECTION

Rating	Connector Type
IP69K	NO
Thermal shock dunk	NO

■ ELECTRICAL SPECIFICATIONS

Voltage	12 VDC	24 VDC
Current (A)	2.35	1.17
Power (W)	28	28

*Nominal voltage 25°C (77°F).

■ MODEL CODE

LTC - 2 - AG - L - 012 - K - NO - 0 - 00 - 10

<p>Control type 2 - Voltage Control (on/off)</p> <p>Power rating AG - 28W (standard for L series)</p> <p>Coil Series L - 10 size (17.6 mm inner diameter)</p> <p>Coil Voltage</p> <table border="1"> <thead> <tr> <th>Code</th> <th>Coil Voltage</th> </tr> </thead> <tbody> <tr> <td>012</td> <td>12 volt</td> </tr> <tr> <td>024</td> <td>24 volt</td> </tr> </tbody> </table>	Code	Coil Voltage	012	12 volt	024	24 volt	<p>Connector Type</p> <table border="1"> <thead> <tr> <th>Code</th> <th>Connector Type</th> </tr> </thead> <tbody> <tr> <td>NO</td> <td>Deutsch male, DT04-2P, integrated</td> </tr> </tbody> </table> <p>Voltage Type K - DC with no protection</p>	Code	Connector Type	NO	Deutsch male, DT04-2P, integrated
Code	Coil Voltage										
012	12 volt										
024	24 volt										
Code	Connector Type										
NO	Deutsch male, DT04-2P, integrated										

■ PART NUMBERS - 309AA00_____ (COMPLETE PART NUMBER IS 11 DIGITS)

Voltage	NO Connector
12VDC	041A
24VDC	042A

For other voltages and connectors contact your Danfoss representative.

■ DIMENSIONS

mm [in]

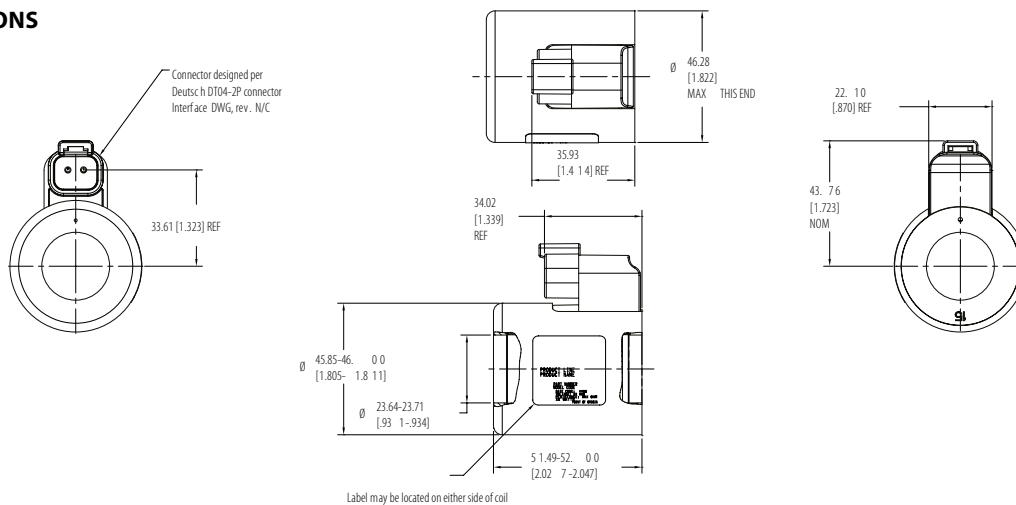

Coils and Electronics

C16

Standard Coil

■ PERFORMANCE DATA

Duty cycle 100% at 110% rated voltage between -20°C and 40°C

Magnet wire insulation 200°C [392° F]

Input Voltage Range 90% to 110% of rated voltage

■ MODEL CODE

C16 - H - 24 - 19

Coil Series
C16 -16 mm tube

Coil Power
19 -19 Watt
29 -29 Watt

Connector Type

Code	Connector Type
H	DIN43650 ISO Standard
F	Flying Leads [12 and 24 VDC only]
DM	Deutsch Moulded [12 and 24 VDC only]

Coil Voltage

Code	Coil Voltage
12	12 VDC
24	24 VDC
110	110 VAC*
220	220 VAC*

*External rectifier required: AXP9997-115 or AXP9997-230

■ DIMENSIONS

mm [in]

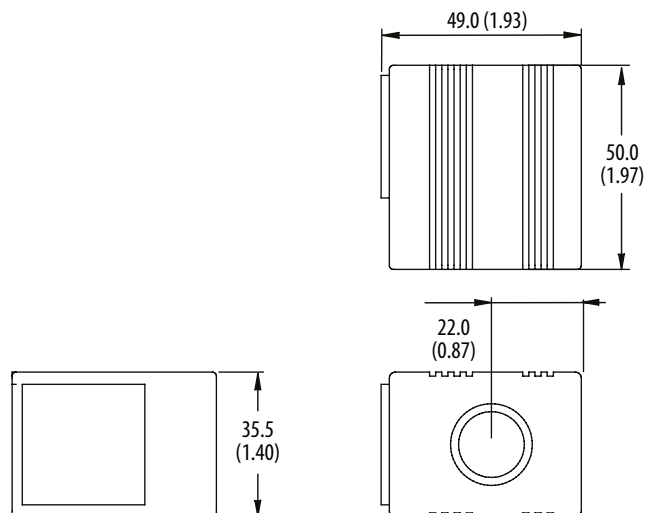

Coils and Electronics

M19

33W Standard Coil

■ PERFORMANCE DATA

Duty cycle	100% at 115% of rated voltage at 40°C [104°F]
Magnet wire insulation	200°C [392°F]
Ambient temperature range	-20° to 40° C [-4° to 104° F]
Input voltage range	85% to 115% of rated voltage
Temperature rise at 115% of rated voltage:	130° C [266° F] above ambient temperature
Weight	0.37 kg [0.82 lb]

■ ENVIRONMENT PROTECTION

Rating	Connector Type
IP65	DN, FL
IP67	AJ, AJD
IP69K	DE, DED

■ ELECTRICAL SPECIFICATIONS

Voltage	12 VDC	24 VDC	110 VAC*	220 VAC*
Resistance (Ohms) @ 20 °C [68 °F]	4.4	17	287	1190
Current draw (A) @ 25 °C [68 °F]	2.76	1.38	0.337	0.163
Power (W)	33	33	33	33

*External rectifier required

■ PERFORMANCE CURVES

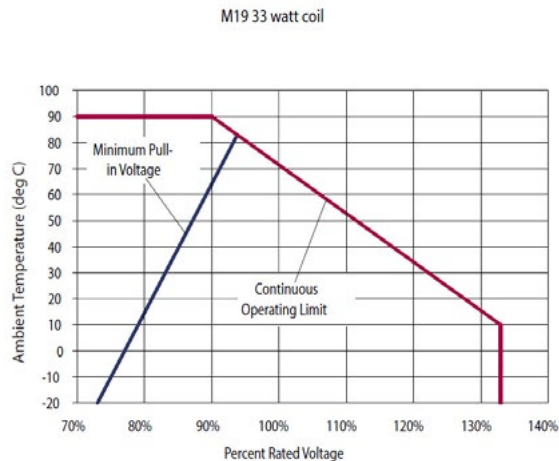

Diode Information

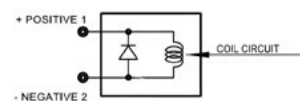

Built-in, uni-directional polarity diode
(Model # 1N5406)

■ MODEL CODE

M19 - 12D - 33W - AJ

Coil Voltage

Code	Coil Voltage
12D	12 VDC
24D	24 VDC
110RA	110VAC*
220RA	220VAC*

*DIN only - external rectifier needed

Coil Power

Connector Type

Code	Connector Type
AJ	Amp Junior
AJD	Amp Junior with Diode
DE	Deutsch
DED	Deutsch with Diode
FL	Flying Leads
DN	DIN 43650

■ DIMENSIONS

mm [in]

AJ
Amp jr.

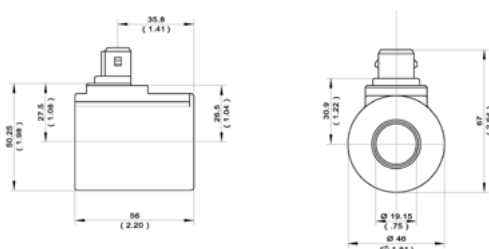

AJD
Amp jr. with diode

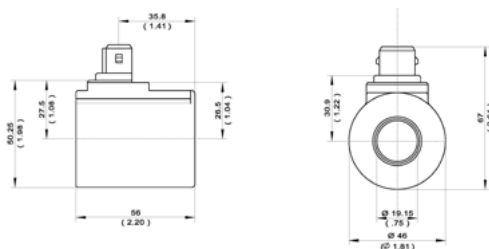

Coils and Electronics

M19

33W Standard Coil

■ DIMENSIONS

mm [in]

FL Lead wires

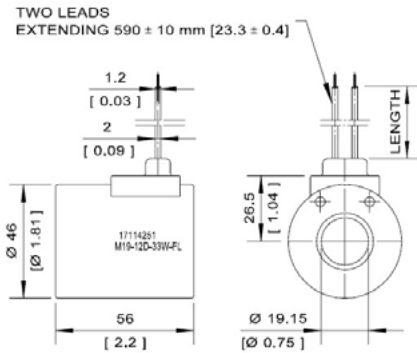

DN ISO 4400 (DIN 43650)

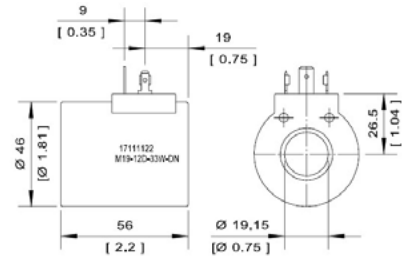

DE DEUTSCH

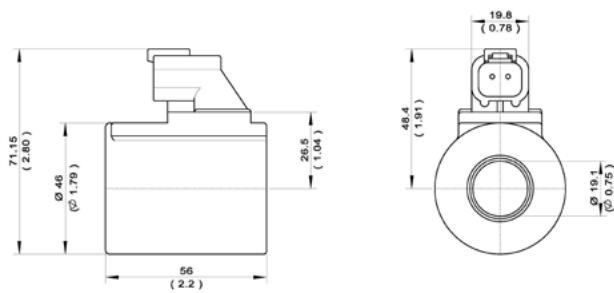

DED DEUTSCH WITH DIODE

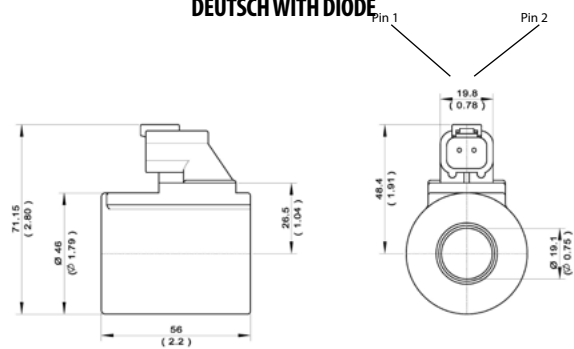

Coils and Electronics

D14E [30W]

30W Robust Coil

PERFORMANCE DATA

Duty cycle	100% at 133% of rated voltage and 50°C [122°F]
Magnet wire insulation	200°C [392°F]
Ambient temperature range	-40 to 50 °C [-40 to 112 °F]
Input voltage range	75% to 133% of rated voltage

ENVIRONMENT PROTECTION

Rating	Connector Type
IP65	H
IP67	AJ, M2
IP69K	DE, DED, L, and DLD

ELECTRICAL SPECIFICATIONS

Voltage	10 VDC	12 VDC	20 VDC	24 VDC
Resistance (Ohms) @ 20 °C [68 °F]	3.3	4.8	13	19
Current draw (A) @ 25 °C [68 °F]	3	2.5	1.5	1.25
Power (W)	30	30	30	30
Retainer Color	Green	Gray	Blue	Yellow

PERFORMANCE CURVES

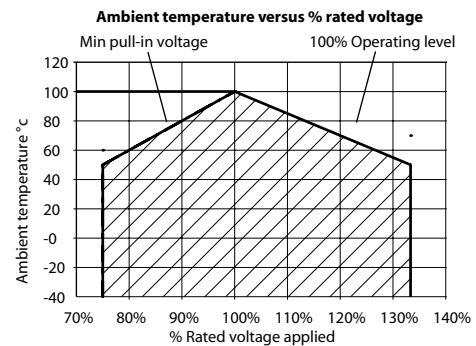

Diode Information

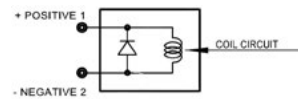

MODEL CODE

D14E - 30W - 10D - AJ

Coil Power

Coil Voltage

Code	Coil Voltage
10D	10 VDC
12D	12 VDC
20D	20 VDC
24D	24 VDC

Connector Type

AJ - Amp Junior
 DE - Deutsch
 DED - Deutsch w/Diode
 H - DIN 43650
 L - Lead Wires
 DLD - Lead Wires w/Diode
 M2 - MetriPack 150, Type 1
 S - Dual Spade

DIMENSIONS

mm [in]

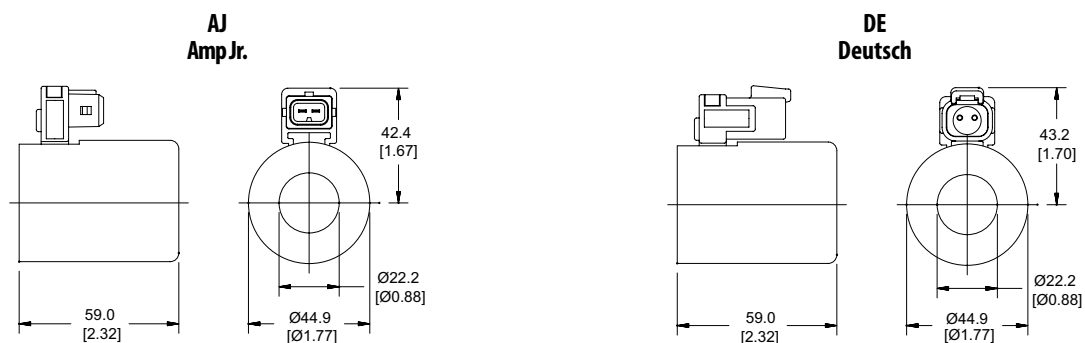

Coils and Electronics

D14E [30W]

30W Robust Coil

■ DIMENSIONS

mm [in]

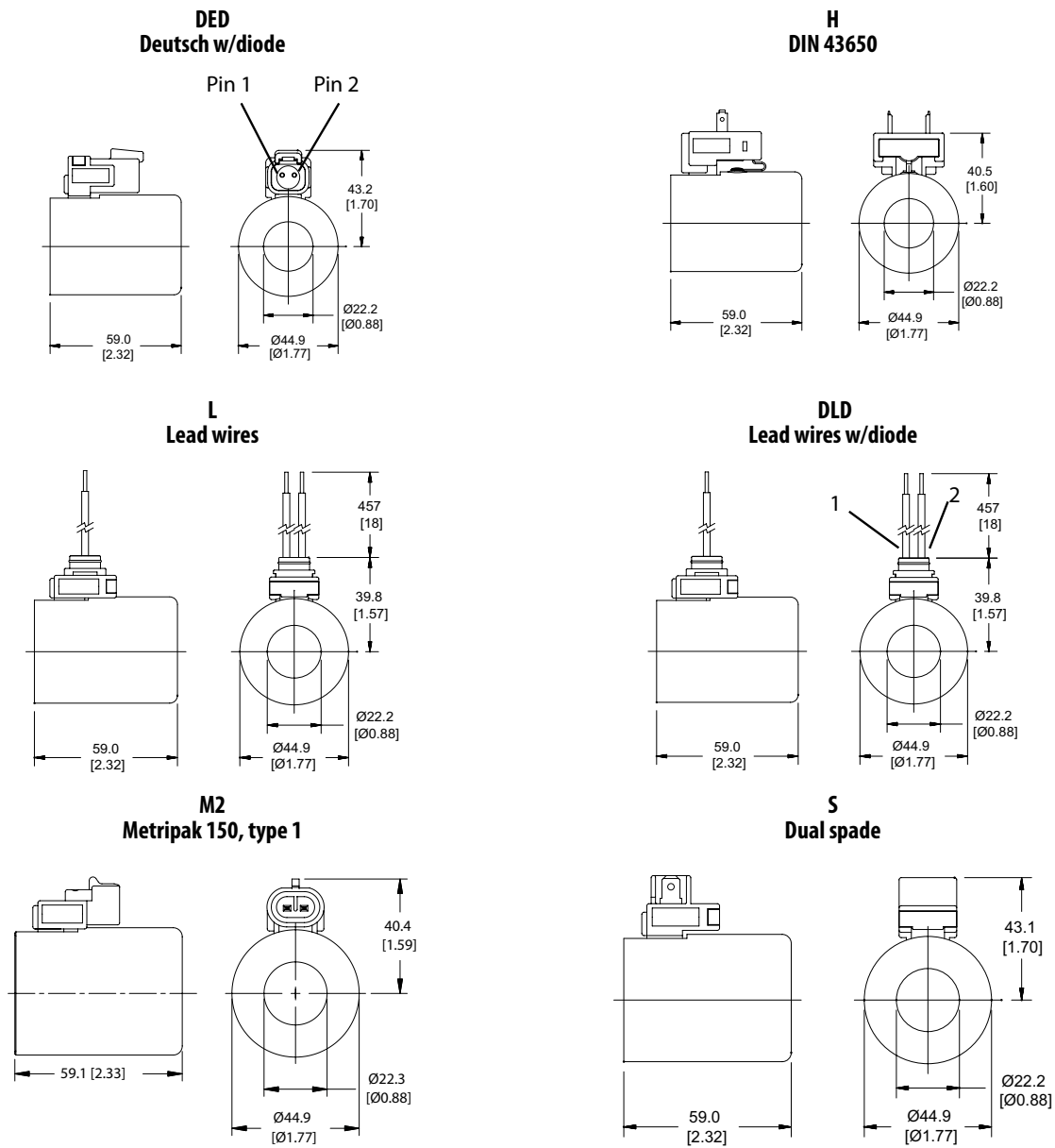

Coils and Electronics

R series

30 Watt Large ToughCoil

■ PERFORMANCE DATA

Duty cycle	100% at 85% to 110% of rated voltage
Ambient temperature	100°C (212°F) continuous @ rated voltage
Power Rating	130°C [266°F] above ambient
Insulation	U.L. class N, 200°C (392°F) NEMA pub. No. MW 1000, section MW 35 – C (single)

■ ELECTRICAL SPECIFICATIONS

Voltage	12 VDC	24 VDC
Current (A)	2.50	1.25
Power (W)	30	30

*Nominal voltage 25°C (77°F).

■ MODEL CODE

LTC - 2 - AA - R - 012 - K - NO - 0 - 00 - 10

<p>Control type 2 - Voltage Control (on/off)</p> <p>Power rating AA - 30W (standard for R series)</p> <p>Coil Series R - 10 and 12 size used on SV*M solenoid valves (23.6mm inner diameter)</p>	<p>Connector Type NO-Deutsch (DC only)</p> <p>Voltage Type K - DC with no protection M - DC w/ bi-directional Diode</p> <p>Coil Voltage</p> <table border="1"> <thead> <tr> <th>Code</th> <th>Coil Voltage</th> </tr> </thead> <tbody> <tr> <td>012</td> <td>12 VDC</td> </tr> <tr> <td>024</td> <td>24 VDC</td> </tr> </tbody> </table>	Code	Coil Voltage	012	12 VDC	024	24 VDC
Code	Coil Voltage						
012	12 VDC						
024	24 VDC						

■ PART NUMBERS - 309AA00_____ (COMPLETE PART NUMBER IS 11 DIGITS)

Voltage	NO Connector
12VDC	001A
24VDC	017A
12VDC*	007A
24VDC*	008A

*With bi-directional diode. (Voltage type M)

■ DIMENSIONS

mm [in]

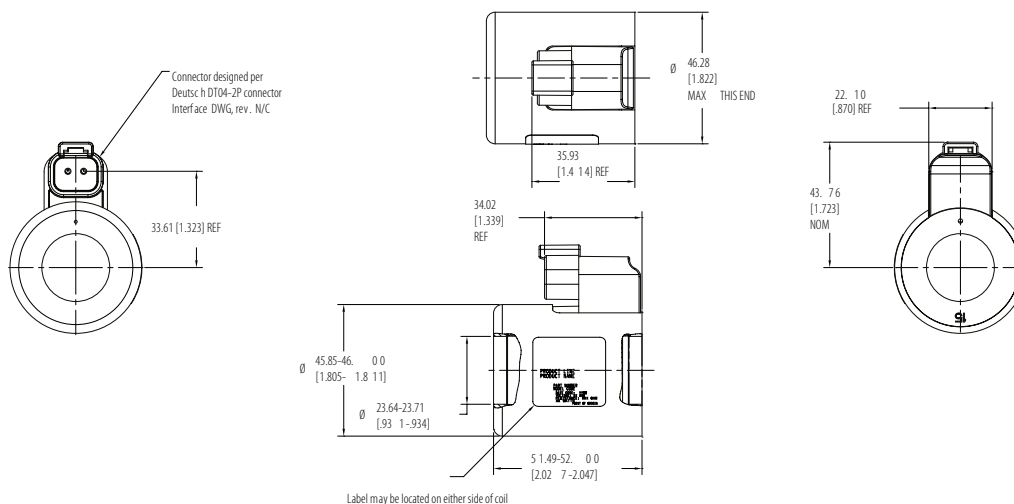

Coils and Electronics

M19P

22W Proportional Coil

■ PERFORMANCE DATA

Magnet wire insulation	200°C [392°F]
Maximum Continuous Current	1.8 A [at 12 V] 0.9 A [at 24 V]
Ambient temperature range	-20 to 40 °C [-4 to 104 °F]
Weight	0.37 kg [0.82 lb]

■ ELECTRICAL SPECIFICATIONS

Voltage	12 VDC	24 VDC
Resistance (Ohms) @ 20 °C [68 °F]	3.7	15.5
Maximum continuous current	1.8	0.9
Power (W)	22	22

■ ENVIRONMENT PROTECTION

Rating	Connector Type
IP65	all other connectors
IP69K	DE

■ MODEL CODE

M19P - 12D - 1.8A - AJ

Coil Voltage

Code	Coil Voltage
12D	12 VDC
24D	24 VDC

Maximum Control Current

1.8A - 12 VDC
0.9A - 24 VDC

Connector Type

Code	Connector Type
AJ	Amp Junior
DE	Deutsch
FL	Flying Leads
DN	DIN 43650

■ DIMENSIONS

mm [in]

AJ
Amp jr.

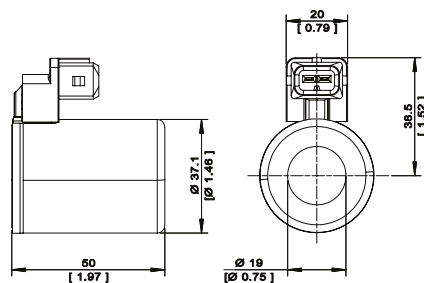

DE
Deutsch

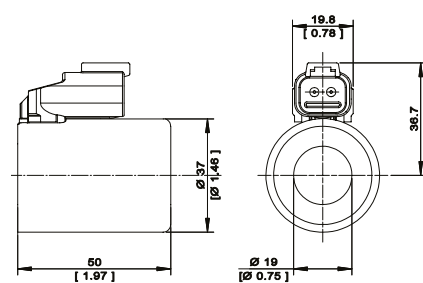

FL
Lead wires

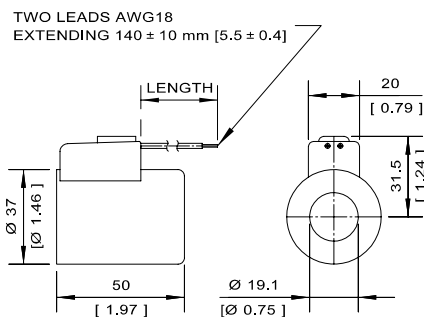

DN
ISO 4400 (DIN 43650)

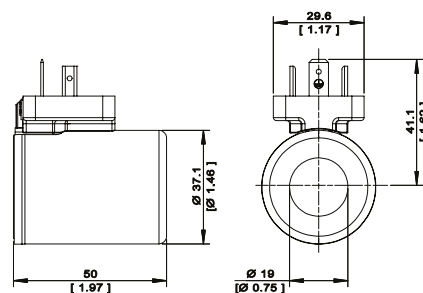

Coils and Electronics

D14E [35W]

35W Proportional Coil

PERFORMANCE DATA

Magnet wire insulation	200°C [392° F]
Ambient temperature range	-40 to 50 °C [-40 to 122 °F]

Used only on proportional valves with current control

ELECTRICAL SPECIFICATIONS

Voltage	12 VDC	24 VDC
Resistance (Ohms) @ 20 °C [68 °F]	4.1	17
Maximum Continuous Current (A)	1.8	0.9
Retainer Color	Gray	Yellow
Power (W)	35	35

DIMENSIONS

mm [in]

ENVIRONMENT PROTECTION

Rating	Connector Type
IP65	All others connectors
IP67	AJ, AS
IP69K	DE, FL

MODEL CODE

D14E - 12D - 1.8A - AJ	
Coil Voltage	Connector Type
Code	Coil Voltage
12D	12 VDC
24D	24 VDC
Maximum Control Current	Connector Type
1.8A - 12 VDC	AJ - Amp Junior
0.9A - 24 VDC	AS - Amp SuperSeal
	1.5/MetriPak 150 Type 1
	DE - Deutsch
	DN - DIN 43650
	FL - Lead Wires

AJ
Amp Jr.

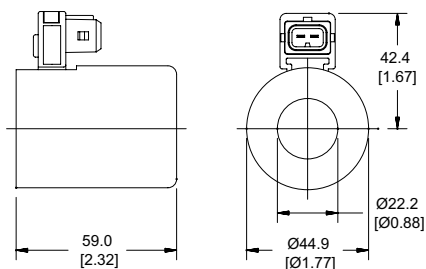

AS
Amp SuperSeal 1.5/MetriPak 150 Type 1

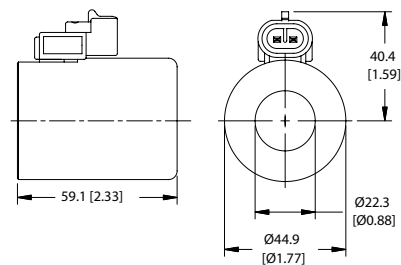

DE
DEUTSCH

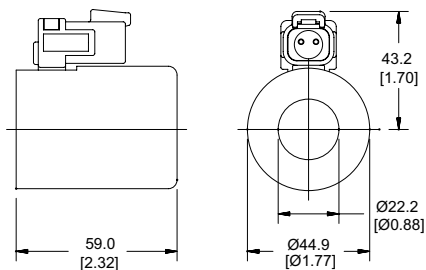

DN
DIN 43650

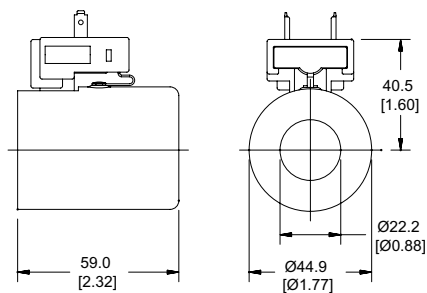

FL
LEAD WIRES

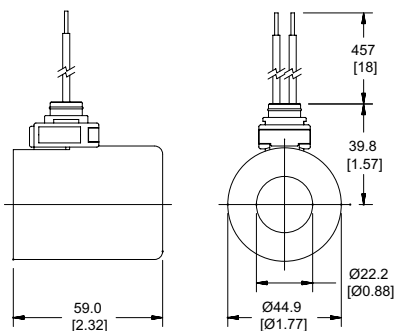

Coils and Electronics

EPV series

EPV Proportional Coil

■ PART NUMBERS (COIL ONLY)

Voltage	N	U*	W	Y
12VDC	02-154124	02-154422	02-154416	02-300823
24VDC	02-301294	02-154423	02-154417	02-300824

*DIN 43650 mating connector for "U" style coil - 02166796

■ ELECTRICAL SPECIFICATIONS

Voltage	12 VDC	24 VDC
Current (A)	1.4	0.7
Power (W)	16.8	16.8
Lead color	Red	Black

*Nominal voltage 25°C (77°F).

■ EPV10 COIL KITS

Code	Connector Type	12 VDC	24 VDC
W	Leadwire (DC only)	02-361830	02-363310
U	DIN 43650	02-361837	02-363321
Y	Metri-Pack 150 male	02-361845	02-363322
N	Deutsch DT04-2P	02-361849	02-364329

*Coil kits include coil, O-ring and coil nut

■ EPV16 COIL KITS

Code	Connector Type	12 VDC	24 VDC
W	Leadwire (DC only)	02-154072	02-154073
U	DIN 43650	02-154070	02-154071
Y	Metri-Pack 150 male	02-301212	02-301213
N	Deutsch DT04-2P	02-390736	02-391885

■ DIMENSIONS

mm [in]

W
Lead Wire (24 in)

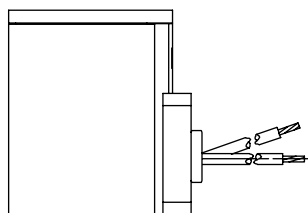

Diameter - all options

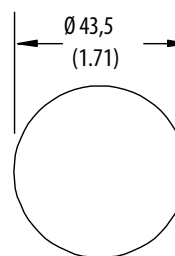

U
DIN 43650

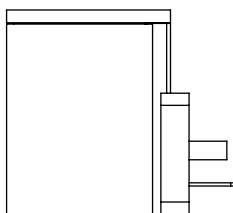

Y
Metri-Pack 150 male on leads

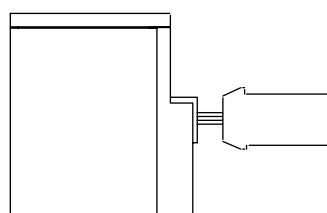

Coils and Electronics

E series

EFV Proportional Coil

ENVIRONMENT PROTECTION

Rating	Connector Type
IP65	All other connectors
IP69K	DE

ELECTRICAL SPECIFICATIONS

Voltage	12 VDC	24 VDC
Resistance (Ohms) @ 20 °C [68 °F]	4.7 Ω	19.0 Ω
Power (W)	30W	30W

MODEL CODE

MCSC - 024 - D - C - E - 06

<p>Coil Voltage</p> <table border="1"> <thead> <tr> <th>Code</th> <th>Coil Voltage</th> </tr> </thead> <tbody> <tr> <td>012</td> <td>12 VDC</td> </tr> <tr> <td>024</td> <td>24 VDC</td> </tr> </tbody> </table> <p>Voltage Type</p> <p>D - DC</p>	Code	Coil Voltage	012	12 VDC	024	24 VDC	<p>Lead length</p> <p>00 - None 05 - 127mm [5.0 in] 06 - 152mm [6.0 in]</p> <p>Series</p> <p>E - E series, 30W</p> <p>Connector Type</p> <table border="1"> <thead> <tr> <th>Code</th> <th>Connector Type</th> </tr> </thead> <tbody> <tr> <td>G</td> <td>ISO 4400 DIN 43650</td> </tr> <tr> <td>W</td> <td>Flying lead</td> </tr> <tr> <td>C</td> <td>Deutsch Male, DT04-2P, On wire leads</td> </tr> </tbody> </table> <p><small>*DIN 43560 mating connector for "G" style coil: 02-166796"</small></p>	Code	Connector Type	G	ISO 4400 DIN 43650	W	Flying lead	C	Deutsch Male, DT04-2P, On wire leads
Code	Coil Voltage														
012	12 VDC														
024	24 VDC														
Code	Connector Type														
G	ISO 4400 DIN 43650														
W	Flying lead														
C	Deutsch Male, DT04-2P, On wire leads														

COIL KITS

Model code	Part number
MCSC-012-D-G-E-00	6034440-001
MCSC-024-D-G-E-00	6034440-002
MCSC-012-D-W-E-00	6034441-001
MCSC-012-D-C-E-06	6034442-002

DIMENSIONS

mm [in]

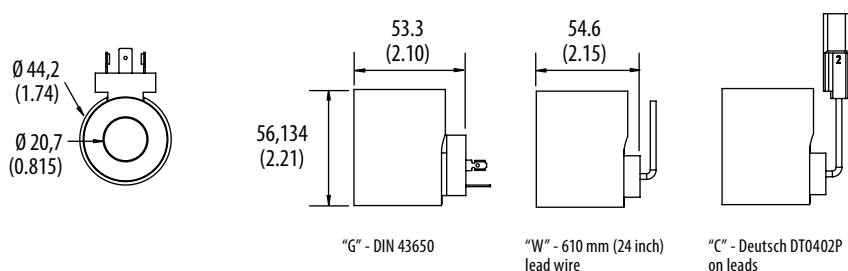

Coils and Electronics

DIN Connectors

STANDARD CONNECTORS TO DIN 43650

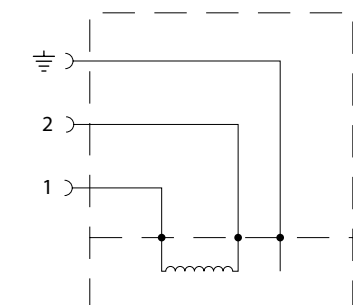

TYPE A CONNECTOR

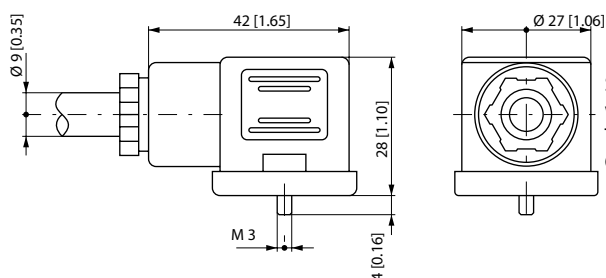

Standard connector for use with DC input.
Type A
Order no. R088010080

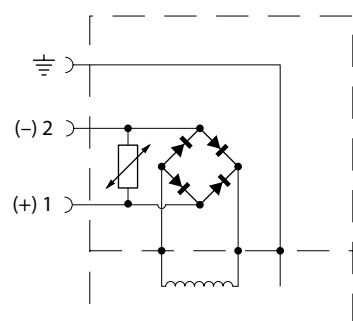

TYPE C CONNECTOR

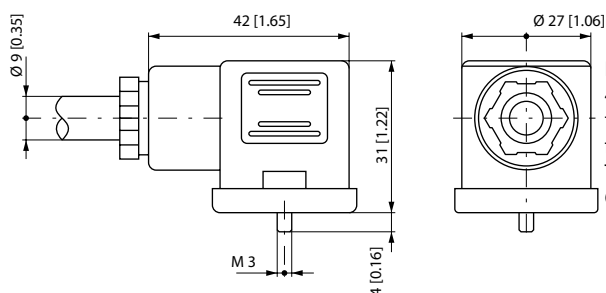

Full wave bridge rectifier with 4 diodes and VDR protecting the a.c. side against overvoltage from electrical power supply.
Type C
Order no. R088010060

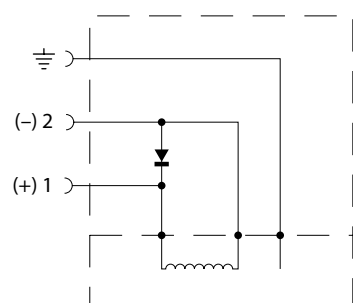

TYPE E CONNECTOR

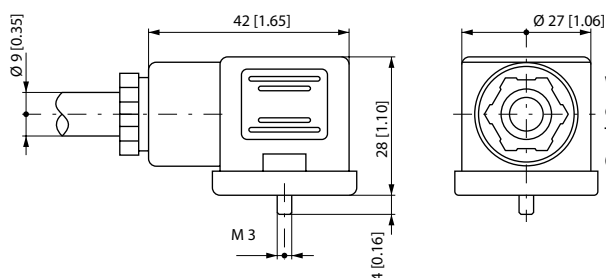

With diode blocking overvoltage on opening.
Type E
Order no. R088010410

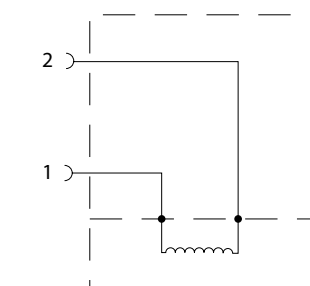

TYPE K CONNECTOR

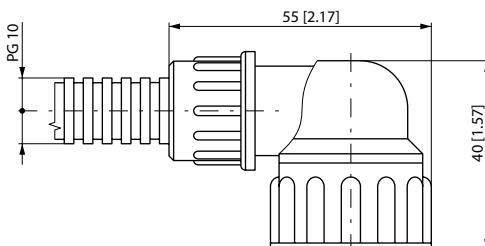

Standard connector to Kostal pattern, for use with DC input.
Type K
Order no. R088010350

REMARK

For details of use, see technical data relevant to the individual solenoid valves. All connector are supplied unassembled. Connectors with indicator lights are available on request (Consult factory).

Danfoss