



Ikargo2 Transmitter

Remote Control



Revision history

Table of revisions

Date	Changed	Rev
May 2026		0401
July 2024	Updated safety, technical description, maintenance information, and maintenance sections	0301
February 2021	Changed name Ikargo10 to Ikargo2	0201
July 2019	Rebranded to Danfoss.	0101

Safety instructions

FCC rules.....	4
General safety.....	4
Safety warnings.....	5
Data Encryption.....	5

Technical description

Ikargo2 Dimensions.....	6
Ikargo2 Start-up.....	7
Ikargo 2 Start Up 2.4GHz.....	8
Ikargo2 Detailed Description.....	9
Display Menu on Ikargo Transmitters 2.4GHz.....	10
Multikey.....	15
Additional Transmitter Features.....	16

Maintenance

Ikargo2 Maintenance Recommendations.....	17
Troubleshooting (400-900 MHz).....	17
Troubleshooting 2.4GHz.....	18

Charger and battery

Charger and battery.....	20
BC70K Battery Charger and BT11K specifications.....	20
BC70K Battery Charger Set-up.....	20
BC70K Charger LEDs Status	22
Battery Charging Recommendations.....	22
BC70K Battery Charger Dimensions.....	23

Safety instructions

FCC rules

This equipment has been tested and found to comply with the limits for a Class A digital device, pursuant to Part 15 of the FCC Rules.

Note

Changes or modifications not expressly approved by the manufacturer can void the user's authority to operate the equipment.

Note

To comply with FCC RF exposure compliance requirements, this device and its antenna must not be collocated with, or operating in conjunction with, any other antenna or transmitter, may not cause harmful interference, and must accept any interference received, including interference that may cause undesired operation.

The limits are designed to provide reasonable protection against harmful interference when the equipment is operated in a commercial environment. This equipment generates, uses, and can radiate radio frequency energy, and if not installed and used in accordance with the instruction manual, may cause harmful interference to radio communications.

Operation of this equipment in a residential area is likely to cause harmful interference in which case the user will be required to correct the interference at his own expense.

Warning

Le présent appareil est conforme aux CNR d'Industrie Canada applicables aux appareils radio exempts de licence. L'exploitation est autorisée aux deux conditions suivantes:

1. l'appareil ne doit pas produire de brouillage, et
2. l'utilisateur de l'appareil doit accepter tout brouillage radioélectrique subi, même si le brouillage est susceptible d'en compromettre le fonctionnement.

Ikargo2 General Safety

The following safety instructions must be read carefully to install and use the product properly, and to keep it in perfect working condition, and to reduce the risk of miss use.

- **Danfoss recommends the use of ESD PPEs (electrostatic discharge personal protection equipment).**
- Strictly adhere to the installation instructions contained in this document.
- Make sure that professional and competent personnel carry out the installation.
- Ensure that all on site and prevailing safety regulations are fully respected.
- The Electrical Installation where it may be connected, The receiver may be connected through an automatic magneto thermic switch (with omnipolar cut capacitance: F+N) and differential with characteristics according to the Low Voltage Recommendations.
- Make sure that this document is permanently available to the operator and maintenance personnel.
- Keep the transmitter out of reach of non-authorized personnel.
- Remove the transmitter key when the set is not in use.
- Check each working day the STOP button and other safety features. When in doubt, press the STOP button.
- Whenever several sets have been installed, make sure the transmitter is the right one. Identify the machine controlled on the label for this purpose on the transmitter or by using the display (in case it does have one).
- Service the equipment periodically.
- Avoid High Pressure water Spraying to Receivers while cleaning the machine
- When carrying out repairs, use spare parts supplied by Danfoss only.

 **Warning**

Potential damage to the operator or the product. Do not use this product on machines in potentially explosive atmospheres unless the model is ATEX/RATEX certified to work in such conditions.

Ikargo2 Safety Quick Guide

Follow the Safety Quick Guidelines below to reduce risk of injury to the operator or the product.

Changes or modifications not approved by Danfoss can void the user's authority to operate this product.

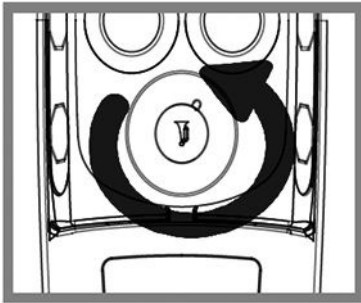

Remove the transmitter key only when the set is not in use or to deny the access.

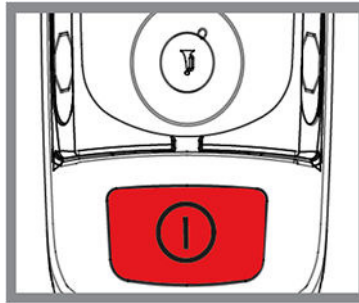

When in doubt, press the STOP button.

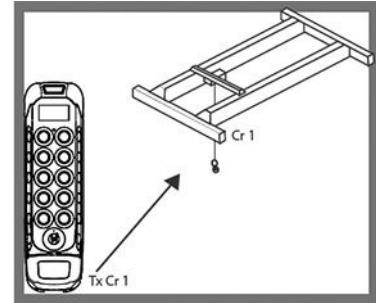

Make sure the transmitter works with the machine to be handled.

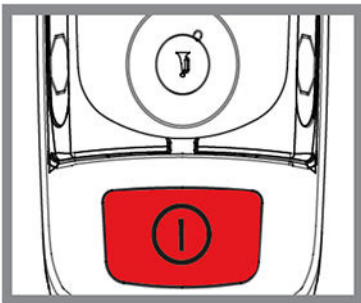

After use, press the STOP button and remove the Multikey.

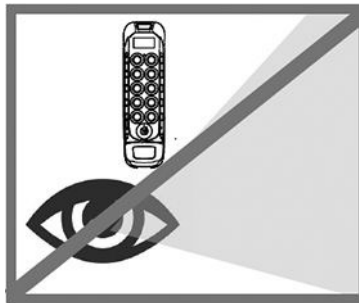

Do not use the set when visibility is limited.



Avoid knocking or dropping the set.

Data Encryption

In alignment with **Commission Delegated Regulation (EU) 2022/30**, supplementing the **Radio Equipment Directive (RED) 2014/53/EU**, we are introducing **encryption for radio communication** in TM80 2.4 GHz platform. This measure is designed to:

- Protect the integrity and confidentiality of transmitted data
- Prevent unauthorized access and misuse of network resources

Technical description

Ikargo2 Dimensions

Dimensions (mm)

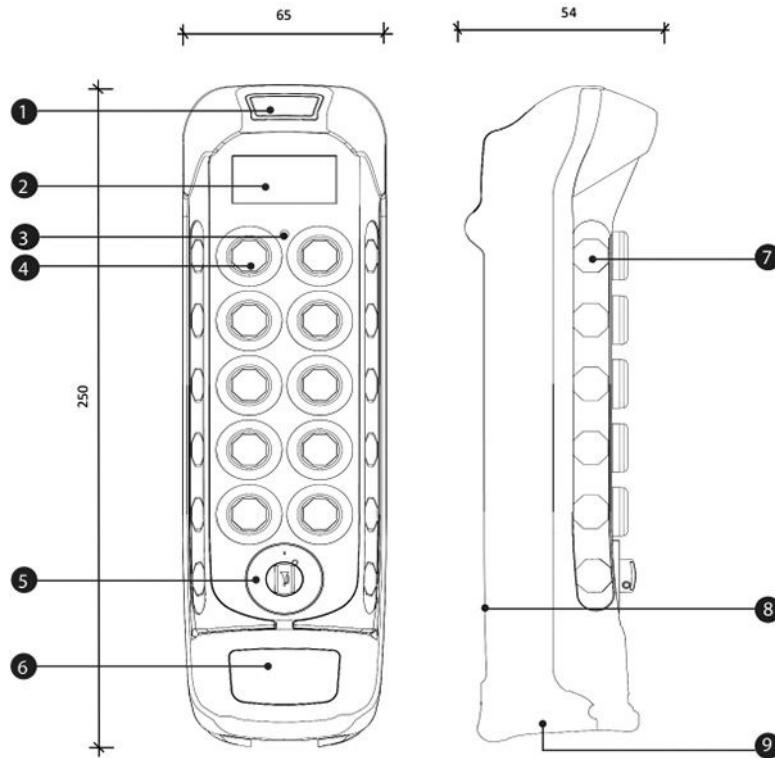

1. Range limiter infrared sensor
2. RGB display
3. Status LED
4. Maneuver push button (2 steps)
5. Multikey/START
6. STOP button
7. Movement pictogram housing
8. BT11K battery housing
9. Extractable EEPROM housing

Ikargo2 Start-up

In order to turn the transmitter on - **OPERATION mode**, follow the steps bellow:

1. Insert the charged BT11K battery model in the transmitter and ensure the EEPROM module is in place.
The battery must be charged according to the Battery charging instruction manual.

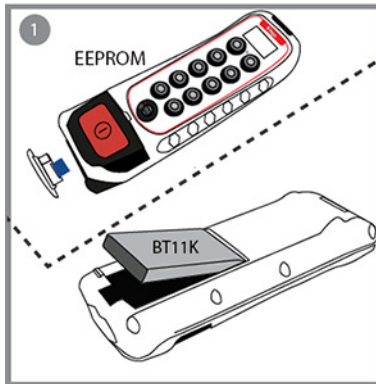

2. Turn the multikey from the position 0 to the 1 position.
The multikey cannot be removed while in the 1 position.



3. Push and pull out the stop button.

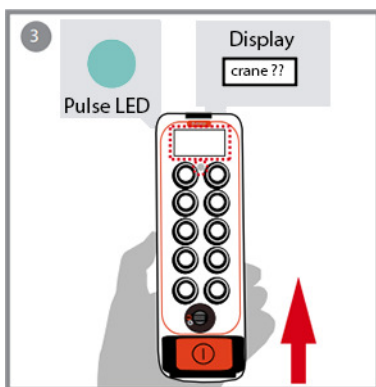

The LED will blink in green color and the battery level will appear on the display. It is recommended to introduce the machine identifier (example: EOT crane number).

4. Press START with the multi-key until the radio link is performed.

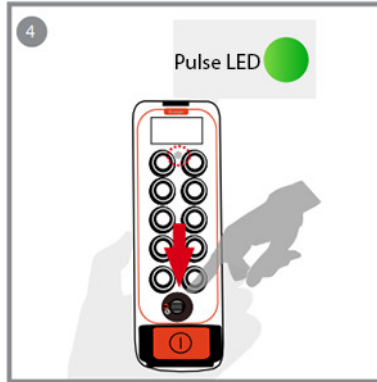

The LED color will turn green to indicate that the transmitter and receiver link is confirmed.

5. After confirmation, press the maneuver buttons to verify corresponding movements.

Ikargo 2 Start Up 2.4GHz

In order to turn the transmitter on (OPERATION mode), follow the next steps.

1. Insert a fully charged BT11K battery model in the transmitter and ensure the EEPROM module is in place. The battery must be charged according to the Battery charging instructions manual.

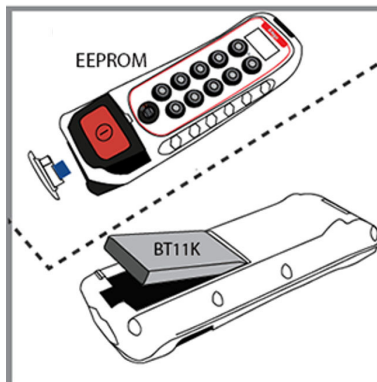

2. Turn the multikey from the position 0 to the 1 position. The multikey can only be inserted or extracted on the "Key" position.



3. Push the Stop pushbutton, **wait 2 seconds**, and pull the Stop button.

This process is required to check the Status of the STOP button before starting operation.

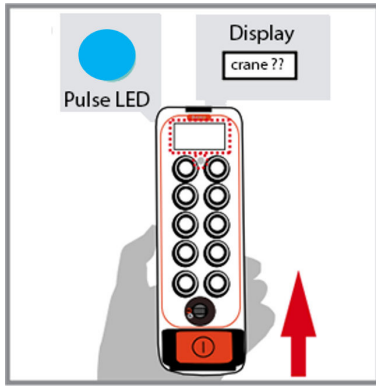

4. LED will flash, blinking blue until it reaches the Stand-by mode (fixed blue). If the transmitter includes a Display, it will display the identification of the machine if it has been pre-programmed, as well as the battery level.

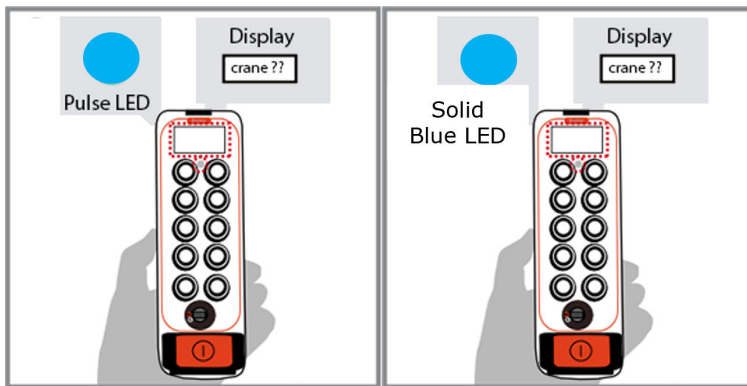

5. Press the **START** button, and wait for the status LED to turn to fixed green. The status LED will start blinking green, meaning the transmitter is trying to connect with the receiver. Once the Tx is linked, LED will turn to fixed green.

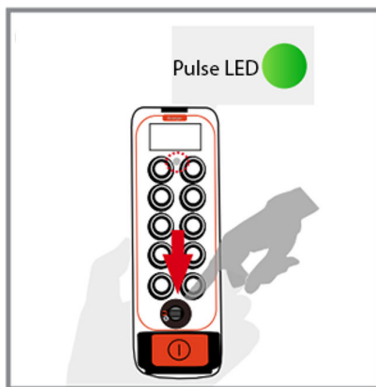

6. Press any of the transmitter buttons and check its corresponding output is activated.

Ikargo2 Detailed Description

Technical Data

Specification	Value
Stop function (400 - 900 MHz)	Cat. 3-PLd
Stop function (2.4 GHz)	Cat. 3-PLe
Ingress Protection	IP65/NEMA4
Anti-condensation system	N/A

Technical Data (continued)

Specification	Value
Frequency bands - ERP	433.050 to 434.040 MHz; ERP<1 mW
	434.040 to 434.790 MHz; ERP<10mW
	869.700 to 870.000 MHz; ERP<5 mW
	902.000 to 928.000 MHz; ERP<1mW
	2405MHz to 2475MHz 20dBm/100mW
Range Line of sight (guaranteed)	100m
Main mechanisms	Pushbutton (10) + Multikey(1) + STOP
Auxiliary mechanisms	N/A
Removable EEPROM	External
Battery model	BT11K
Battery life	8 hours (100% duty cycle)
Response Time	100ms
Operating temperature	-20° to 70° C (-4° to 158° F)
Storage Temperature Range (24h)	-25°C to 75°C (-13°F to 167°F)
Storage Temperature Range (long periods)	-25°C to 55°C (-13°F to 131°F)
Relative humidity	max. 95% without condensation
Weight (with battery)	450g
Dimensions LxWxH mm	252x68x60
Harness	Hand/shoulder strap
Display	Yes
Options	
Fast Teleteaching	N/A
Buzzer	Yes
Vibration	Yes
Free Fall Detection (2.4GHz)	Yes
Tilt Switch (2.4GHz)	N/A
Link Quality Indication (2.4GHz)	Yes
RFID User Validation (2.4GHz)	N/A
Tether connection	N/A
Range limiter	Yes
Associated receivers (400 - 900 MHz)	R06, R13 B, R13 F, R70
Associated receivers (2.4 GHz)	R13F, R70, MPCAN, MP08A, MP20A

Display Menu on Ikargo Transmitters 2.4GHz

Ikargo Transmitters are furnished with an LCD display. This Display apart of presenting the different feedback values programmed as per the specific application, does provide additional information such as the Icon Status Bar, default windows and some Error message windows.

On this chapter we will explain the following:

- 1.- Icon Status Bar
- 2.- Default Transmitter Windows
- 3.- Error Message Windows
- 4.- Settings Menu

- 1.- ICON Status Bar

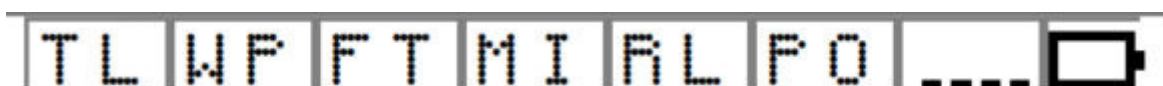

Meaning:

TL: TiLt (tilt Function not available on Ikargo Transmitters).

WP: Wrong Position: The position of the Multikey is not the correct one to Start the system.

FT: Fast Teleteaching: Fast Teleteaching being performed.

MI: Magnetic Interference: The transmitter is blocked due to Magnetic interference being detected.

RL: Range Limiter: Range limiter option being used.

PO: Present Order: A pushbutton does have the present order enabled at the time of starting the system. The transmitter will not transmit.

Link quality Indication: The Icon will have the following 5 states:



meaning from top to bottom:

Critical Battery, Battery needs replacing.

Battery low capacity

Medium Battery status

Fully charged Battery

2.- Default Transmitter Windows:

The default window if nothing is defined on the system will be the Danfoss Logo.

3.- ERROR Message windows:

Line 1	Line 2	Meaning
ERROR	EEPROM	Wrong EEPROM or not inserted
	RADIO	RF Module ERROR
	OTHER	HW Error
	PO and Mask	EEPROM file does not correspond to the transmitters configuration
	Multikey	Multikey wrongly inserted or in the Wrong position
	Configuration File	Mismatch between EEPROM configuration and Display configuration file
	Invalid File	
	Start is not allowed	When in Tandem Mode
	Back to last Position	When in Tandem Mode
	Critical Battery	
	Signature	Compliance block mismatch between EEPROM and Controller signatures
	Pairing	Pairing Mode Error
	Transmitter Dropped	
	During Start up	

(continued)

Line 1	Line 2	Meaning
	Switching off	When timeout or Battery low time take place
	Releasing Receiver	When in Tandem Mode

4.- Settings Menu

Ikargo Transmitters allow the operator to enter the Settings Menu before pressing START.

Pushbuttons Functions:

Pushbutton 1: DOWN. This way we will move on the menus in a descending order.

Pushbutton 2: UP. This way we will move on the menus on an ascending order.

Pushbutton 3: ESCAPE. This button will help us to leave a menu.

Pushbutton 4: ENTER. This button will validate the current selected menu.

The process to enter the settings Menu is as follows:

1.- Insert a fully charged Battery

2.- Place the Key on the ON position.

3.- Release the STOP Button.

4.- Wait until the transmitter has established the Radio Link with the Receiver. Receiver must be ON and on range.

5.- Press Pushbutton 4 (second speed). The system enters on the Settings Menu. The LED will blink in pink once every 2 seconds.

Settings Menu:

Backlight

Label

Timeout

File Name

Input Calibration

Reset Options

Quit

6.- Move through the different Menus with pushbutton 1 (down) or 2 (up) until reaching the desired Menu.

7.- Once reached the desired Menu, Press pushbutton 4 (enter).

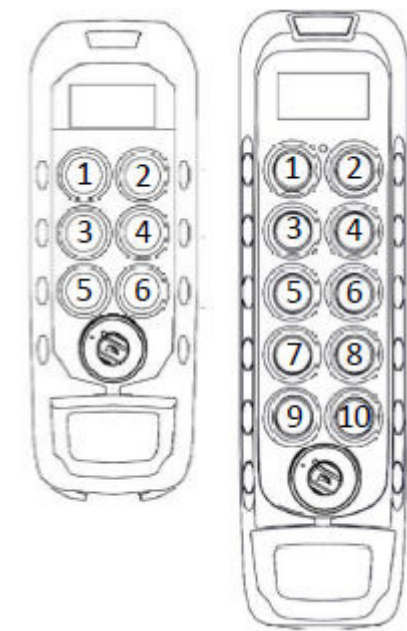

Sub Menus

Sub Menu	Name	Description
1	Backlight	Change Backlight intensity
2	Label	Perform the Label Edition
3	Timeout	Time to Reduce the Backlight after the last change on the Display
4	File Name	Display SW Version
5	Input Calibration	Perform the feedback calibration for proportional inputs
6	Reset Options	Reset Values
7	Quit	Go back to Standby

1.- BackLight

Once we are on the Backlight Menu, the intensity % will increase by pressing the UP button or Decrease by pressing the Down button. Follow the steps.

1.1.- Press ENTER to enter the Backlight Menu. You will see the current value.

1.2.- Press ENTER again and the Backlight intensity may be changed.

1.3.- Pressing UP or DOWN you will increase or decrease the intensity by 10%. Once achieved the desired intensity, Press ENTER The New intensity value is stored.

1.4.- Press SCAPE and yo will return to the Settings Menu or press STOP.

2.- Label Edition

Once reached the desired Menu, in this case Label, Press ENTER (pushbutton 4).

2.1.- Once entered on the Mode LABEL, the Display will show the stored Label. When never done previously, the default text is "Label Line 1", "Label Line 2". Press ENTER (Pushbutton 4) again to start editing the Label.

The cursor will blink on the First Character. Once in this position, we will be able to edit the Label with Pushbutton 1 to 4

Pushbutton Functions:

Pushbutton 1: DOWN. This way we will move on the character list in a descending order.

Pushbutton 2: UP. This way we will move on the character list in an ascending order.

Pushbutton 3: ESCAPE. This button will jump out to a window in which it will allow you to Discard the Changes performed to the Label Edition or Save the Label without needing to go to the last character.

Pushbutton 4: ENTER. This button will validate the current selected character and will move to the next character (to the right). When the last Character is Reached By pressing ENTER the Label is saved and leaves the Label Edition process

Proceed accordingly until the machine identification is completed.

2.2.- To leave the process press STOP or navigate through the Menu until getting to the Quit one.

3.- Timeout

The timeout time selected on this menu is related to the time the backlight of the display is on after receiving a New Feedback signal. After this time the backlight will reduce to save on Battery life, and will switch on always a New value is Received.

3.1.- Press ENTER to be able to change the value. The value is tenths of second.

Use Pushbuttons UP and DOWN to increase or decrease the Timeout time in tenths of second.

3.2.- Press ENTER to Store the new value or ESCAPE to discard the new time entered.

3.3.- Press ESCAPE to return to the Settings MENU or STOP to leave the settings.

4.- File Name

4.1.- When entering this menu by pressing ENTER, the Display will show the firmware version related to the Display. Press ENTER or ESCAPE to go back to the settings MENU.

5.- Input Calibration

Start the transmitter and place a Known load suspended such that the value can be read. We will introduce the First value in Calibration mode.

Switch off the remote control and start the system entering in CALIBRATION mode. In order to do so, it is necessary to do the following:

5.1.- Once reached Input Calibration, Press ENTER (pushbutton 4). On all the STEPS pressing ENTER on the Back button the system will go back to the previous submenu.

5.2.- You will enter on Input Calibration Receivers selection.

5.3.- Select the Receiver that appears with a number. If there is only one Receiver select it by pressing ENTER (pushbutton 4).

5.4.- Now we do enter on Menu, Input Calibration Analog Input. By pressing up & down select the corresponding input. In this case there are 2 inputs select one of them corresponding to the desired value that needs calibration. Press ENTER (Pushbutton 4).

5.5.- Now we do enter on the Menu: Input Calibration select Option. By pressing Down & Up (pushbuttons 1 & 2) Select the value to calibrate:

Back to go back one menu.

1.- Value1 to calibrate the Known load value.

2.- Value2 to calibrate the hoist with no load. (usually 0).Recommended.

3.- Dot Pos

4.- Unit

5.6.- Press ENTER (pushbutton 4) on the desired value, for example Value1.

The system will switch ON, and the reading on the proportional input card will appear as is. Then, by pressing UP & Down, Reach the desired value. Once the desired value is reached, press Enter, pushbutton 4 to confirm.

5.7.- Switch the transmitter off, Switch the transmitter on again and start operation and select the second known load value. Once this second load is suspended in the air, switch off the transmitter, and perform the same procedure as before (steps 5.1 to 5.6) by just selecting the second value on the menu, this is, the one that has not been used.

5.8.- By pressing ENTER the system goes back to the calibration submenu

5.9.- Dot position

5.9.1- Press enter to preview the Dot position on the value to be shown.

5.9.2.- Press ENTER to be able to move the dot position a preview will appear on the right hand side.

5.9.3.- Press ENTER to confirm the selected preview.

5.9.4.- Press ESCAPE to go back to the Calibration Submenu.

5.10.- Unit:

5.10.1.- Press Enter to edit the Units to be shown on the Display

5.10.2.- By pressing UP or Down, select the desired letters to define the unit, Press ENTER to move the cursor forward. By Pressing ESCAPE a menu will pop up, to Save or Discard the Unit edition.

Once finished the feedback calibration process, the system will be calibrated.

At this point the system is ready to work normally. Until calibration is performed, data appearing in the display may be inconsistent.

Calibration generates a linear interpolation of the possible values. This means that it can be used with all systems that generate linear proportional outputs. For non linear systems the interpolation will not generate a correct display value. Calibration allows to obtain negative values.

Example of calibration of a load cell:

Enter into the calibration mode and introduce the value corresponding to the hook without load (1st value).

Validate the value pressing START. Switch off the transmitter.

Start the system again and raise a known load.

Switch off the transmitter and enter again to the calibration mode for the edition of the 2nd value.

Press START to validate the value.

Press pushbutton 1 to edit the units.

Press START to validate the units.

Switch off the transmitter.

The equipment is already ready to work normally.

6.- Reset Options

6.1.- Press ENTER to enter the Reset Option Submenu.

a.- Calibration

a.1.- Pressing ENTER on Calibration the Calibrated values will be reset.

a.2.- The Message: *Reset Done Switch transmitter off* will appear on the screen.

a.3.- Press STOP to exit

b.- Labels

b.1.- Pressing ENTER on Labels the Labels will be reset.

b.2.- The Message: *Reset done Switch transmitter off* will appear on the screen.

b.3.- Press STOP to Exit

c.- Factory reset

c.1.- Pressing ENTER on Factory Reset. By doing Factory Reset the following: Calibration, Labels, Timeout and Backlight to the original values set on the system.

c.2.- The Message: *Reset done Switch transmitter off* will appear on the screen.

c.3.- Press STOP to exit.

d.- Quit

d.1.- By pressing ENTER on Quit, the system will go back to the Settings MENU.

7.- Quit

7.1.- Pressing ENTER the Transmitter goes back to STANDBY waiting to Start functioning.

Multikey

The Multikey is a device connected to the Transmitter via RFID. It does engulf the following features:

Extractable Key (RFID) + START Pushbutton + Up to 5 position Selector switch.

There are different options for the Multikey, being the most common:

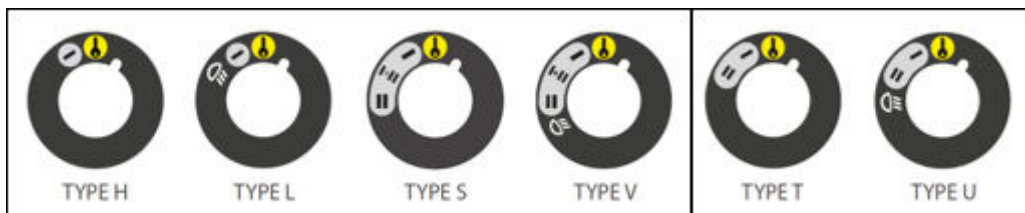

Type H multikey is the Basic Key, having the single position and START pushbutton.

Type T multikey is the key with 2 position selector that could as an example duplicate functions (shift key) depending on the position of the multikey and the button being pressed.

Type S or V multikeys are thought for single and dual operation either on the same receiver or when using 2 Receivers to work on a "tandem" operation.

The Multikey gives a wide variety of options regarding configuration and system behavior depending on the multikey being used on the same Transmitter.

New Multikey configurations may be released upon demand.

Additional Transmitter Features

Handheld and Console Box Transmitters do have the following Features and Options:

Frequency management (400-900 MHz)

Display and Feedback information

Range Limiter

Multi System Configuration

To get further information please do follow the Link to obtain the related manuals:

PLUS+1® remote controls | Danfoss

Maintenance

Ikargo2 Maintenance Recommendations

This product is designed for use in an industrial environment that may shorten the product's lifespan. Use these recommendations to maximize the lifespan of the product.

- Use the hook/shoulder strap/belt provided with the transmitter to prevent the transmitter from falling
- Do not clean the transmitter with solvents or pressurized water; use a damp cloth or soft brush for cleaning
- If the push buttons show signs of deterioration, contact the Authorized Technical Service for repair.
- Check the battery contacts are clean and battery is inserted correctly.
- Be sure to recharge or replace battery regularly.

Maintenance tips quick reference

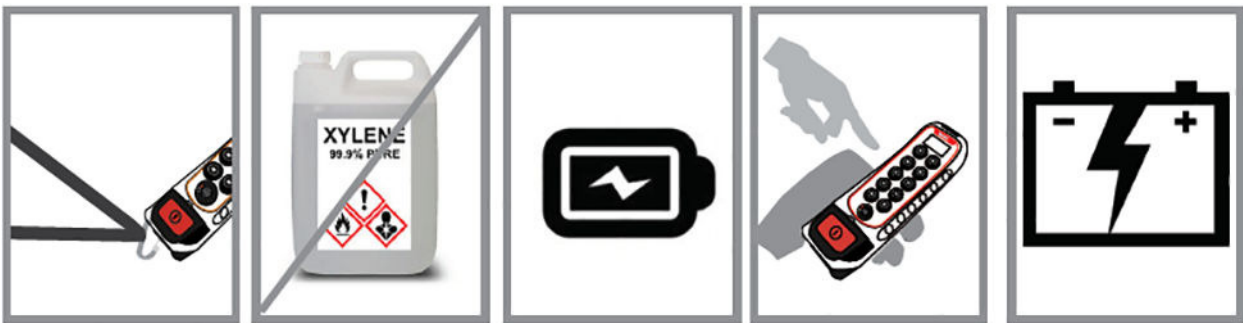































Troubleshooting (400-900 MHz)

The transmitter has status monitoring LED's which help identify irregularities. The most common signals are contained in the table below:

Color and frequency	Pulse frequency	Description	Action
Green continuous		Working	Operate
Green slow pulses		Standby; no action has been taken for some time	Press START to return to operation mode
		Status Rx on Tx Function: Receiver No Link	The Receiver has lost connection with Transmitter. Press START to link again
Green fast pulses		Transmitter Reading New EEPROM	Wait until finished
		Status Rx on Tx and Autoconnect Functions: Transmitter trying to link with Rx (START being Transmitted)	Once Receiver connected will turn into solid Green.
Red slow pulses		Battery Low signal	Replace or recharge battery
Red fast pulses		EEPROM module missing or corrupt	Check EEPROM and reprogram if necessary
Red double pulses		An order is active at transmitter start up process; may indicate hardware damage if no order is active	Release the order or replace transmitter if necessary
Red continuous		General hardware failure	Replace transmitter

Troubleshooting 2.4GHz

Status LED (on all Transmitters)		Display Message	Description	Action
Color and frequency	Pulse frequency			
Blue fast pulses		Danfoss Logo	Starting the system; establishing communications with radio and EEPROM	Wait
Blue continuous		Label - Press start to link	Standby mode. Set up system, waiting user's action	Press START to enter operation mode
Green fast pulses		Connecting..	Attempting to link with the receiver and waiting its answer	Wait
Green continuous		Label or Feedback information	Working	Operate
Green slow pulses		Blank Display	Standby; no action has been taken for some time	Press START to return to operation mode
Green very fast pulses			Near Link Lost. The link may drop	Check Distance or RF interference
Red slow pulses		ERROR EEPROM	EEPROM module missing or corrupt	Check EEPROM and reprogram if necessary
Red double pulses		ERROR RADIO	Radio error; radio communications error	Replace transmitter
Red 3 pulses		ERROR DISPLAY	Display Error. Display communication Error	Replace Display or Transmitter
Red 4 pulses		ERROR MULTIKEY	Multikey Error. Multikey not in ON position or Broken.	Check Multikey or Replace it.
Red 5 pulses		ERROR CAN	CAN Error	
Red 6 pulses		FREE FALL	FREE FALL has been detected.	Reset the transmitter
Red 7 pulses			Display and EEPROM settings do not Match	Check files and reprogram EEPROM and/or Display
Red Long + Short pulse		ERROR RFID	RFID Signature Check Error	Use a correct RFID card and/or configuration
Red 1 Long + 2 short pulses		ERROR PAIRING	Pairing Error	Check the Tether connection and Receiver is ON.
Red 1 Long + 3 short pulses			User validation process aborted. More than one card or card removed before the validation process is completed.	Start the process again
Red 1 Long + 4 short pulses			User validation invalid UID. The PLC does not accept this UID	Start the process again, with another UID card
Red continuous		ERROR	General hardware failure	Replace transmitter
Orange slow pulses			Critical battery signal	Replace batteries with charged ones
Orange double pulses		LABEL	Activated Order	Release Order
Orange 3 pulses			Hall effect interference. Some mechanisms are disabled	Wait until interference disappears
Orange 4 pulses			Range Limiter warning. Out of Range	Check Range Limier is ON with the correct ID.
Orange 5 pulses			Wrong Selector Position	Press Start to link in this position, or return to the original position.
Orange 6 pulses			Release Function: Release Button + START Pressed	The transmitter will switch off after release is done.
Orange 7 pulses			Tilt Warning. Transmitter is tilted more than the number of degrees set up in the EEPROM configuration for Pitch and Roll axis	Bring the transmitter to normal position

Status LED (on all Transmitters)		Display Message	Description	Action
Color and frequency	Pulse frequency			
Pink 1 pulse			Display Value Settings Menu	Perform the Display settings
Pink Continuous		EEPROM copy - Replace EEPROM	EEPROM copy mode	Press related button to perform the copy
Pink Fast pulses		EEPROM copy - Writing EEPROM	EEPROM being copied	Wait until solid pink
Pink 3 pulses			Saving in Pairing Mode	Wait until saved
Blue + Pink 3 pulses			RFID User Validation Waiting UID Validation	Wait until UID approved or denied
Blue + Pink 1 pulse			RFID User Validation waiting User	Please place UID close to RFID reader

Charger and battery

Charger and battery



Disposal note:

This symbol on the product indicates that it may not be disposed of as household waste. It must be handed over to the applicable take-back scheme for the recycling of electrical equipment.

- Dispose of the product through channels provided for this purpose.
- Comply with all local and currently applicable laws and regulations.

BC70K Battery Charger and BT11K specifications

BC70K battery charger

Specification	Value
AC power supply	110-230V, 50/60Hz, $\pm 10\%$, automatic switching
DC power supply, nominal	12-24V

BT11K battery

Specification	Value
Voltage	3.7V
Capacity	1130 mAh Li-ion
Charging temperature	0°C to 45°C
Discharge temperature	-20°C to 60°C
Full Charge	4h \pm 30 min
Weight	23g

BC70K Battery Charger Set-up

The battery charger has two charging compartments that can simultaneously charge two BT11K batteries. Use the information below to set up the BC70K battery charger.

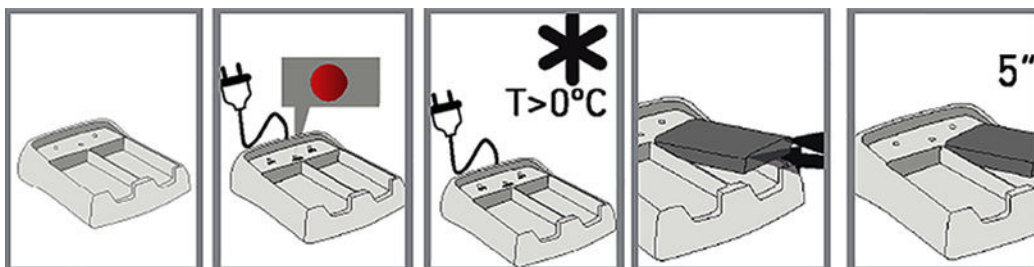

1. Connect the charger to a power source using the provided power supply.
The red LED will switch on if the charger is properly connected.
2. Place the batteries on the charger.
3. Optional: When charging two batteries, wait at least five seconds before inserting the second battery into the compartment.

 **Warning**

Possible damage to battery.

The Battery Charger must be installed in a dry/interior environment. Make sure to charge batteries in environments with temperatures over 0°C.

BC70K Charger LEDs Status

The BC70K charger has a LED for each compartment (**BAT 1** and **BAT 2**) and a common indicator (**POWER**).

LED color / frequency	Description
Green LED / pulsing (BAT 1, BAT 2)	The battery is being charged
Green LED / continuous (BAT 1, BAT 2)	The battery is completely charged
Red LED / pulsing or continuous (BAT 1, BAT 2)	The battery charger fault
Red LED / continuous (POWER)	The charger is properly connected to power source

Battery Charging Recommendations

Charge the battery fully before use. This ensures that the battery's full capacity will be available. The battery lifespan is estimated to 500 recharging cycles and is largely dependent on the conditions of use. To maximize the lifespan of the batteries and battery charger, follow these recommendations:

- Do not recharge the battery until it is completely flat, as shown with red LED slow pulse on the transmitter
- Always charge the batteries at temperatures between 0° and 45°C (the batteries will not become fully charged at temperatures exceeding 45°C)
- Do not leave the battery charger or batteries in a direct sunlight
- Charge batteries at least once every three months
- Make the charge of at least 40% of the full charge.
- Ideal Battery storage temperature should be between 15°C and 25°C.
- Avoid short circuits between the battery contacts; do not carry charged batteries in toolboxes or next to other metal objects (keys, coins, etc.)
- Always keep contacts clean
- Caution! Risk of Explosion if Battery is Replaced by an incorrect type. Non Danfoss Battery use may void warranty

BC70K Battery Charger Dimensions

Dimensions (mm)

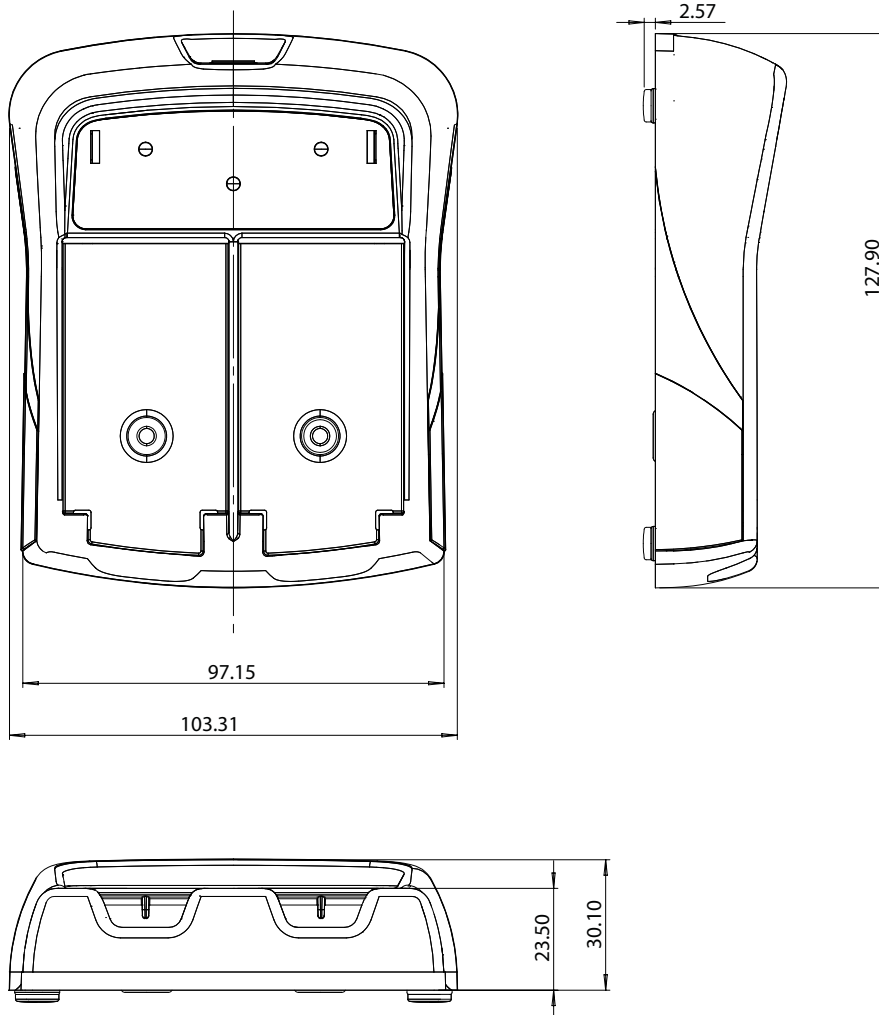



Hydro-Gear

www.hydro-gear.com

Daikin-Sauer-Danfoss

www.daikin-sauer-danfoss.com

Explore our solutions at danfoss.com.

Additional product literature is available at powersource.danfoss.com.

**Danfoss
Power Solutions (US) Company**
2800 East 13th Street
Ames, IA 50010, USA
Phone: +1 515 239 6000

**Danfoss
Power Solutions GmbH & Co. OHG**
Krokamp 35
D-24539 Neumünster, Germany
Phone: +49 4321 871 0

**Danfoss
Power Solutions ApS**
Nordborgvej 81
DK-6430 Nordborg, Denmark
Phone: +45 7488 2222

**Danfoss
Power Solutions Trading
(Shanghai) Co., Ltd.**
Building #22, No. 1000 Jin Hai Rd
Jin Qiao, Pudong New District
Shanghai, China 201206
Phone: +86 21 2080 6201

Danfoss can accept no responsibility for possible errors in catalogues, brochures and other printed material. Danfoss reserves the right to alter its products without notice. This also applies to products already on order provided that such alterations can be made without subsequent changes being necessary in specifications already agreed. All trademarks in this material are property of the respective companies. Danfoss and the Danfoss logotype are trademarks of Danfoss A/S. All rights reserved.