

ENGINEERING
TOMORROW

Danfoss

Brochure | Compressors for Commercial Air Conditioning

Savings now and **for a lifetime**

Danfoss compressors reduce costs across the entire product lifespan in the application. Build your business with a 360° perspective and experience the benefits of true savings.

New compressor options in 2020

to comply with low
GWP and efficiency
regulations.

airconditioning.danfoss.com

An investment providing a lifetime of **savings**

Danfoss solutions provide **a lifetime of savings**

Driven by the global need to reduce CO₂ emissions, new legislations around the world are demanding air conditioning systems with higher energy performance as well as non-ODP⁽¹⁾ and lower-GWP⁽²⁾ refrigerants. These legislations affect all unit types and lead to the redesign a large number of HVAC ranges.

As well as conforming to strict new standards, next-generation systems need to meet the challenges of complex applications, increased energy efficiency and varied climates, while also providing flexibility and top comfort. As a result, the HVACR industry is facing increasing complexity and multiple challenges in terms of development, running and maintenance costs.

(1) ODP: Ozone Depletion Potential

(2) GWP: Global Warming Potential

Save on

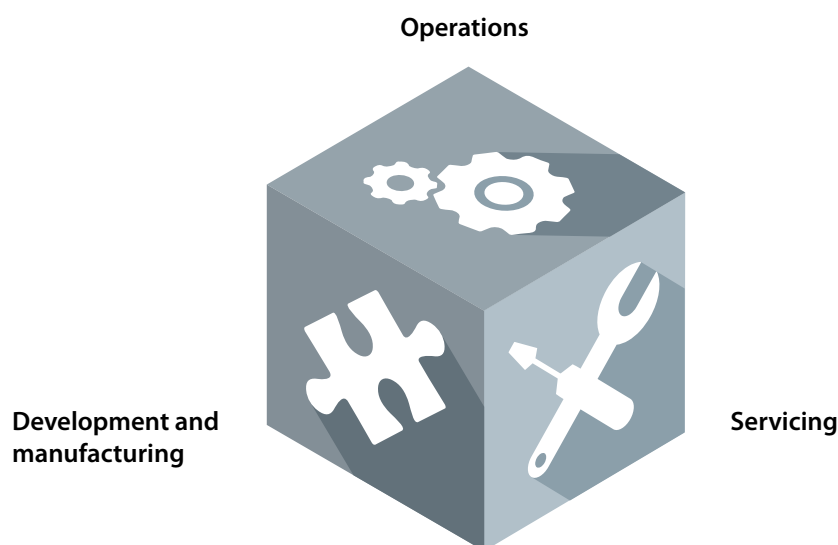

A global overview of CO₂ emissions and regulations impacting HVAC markets

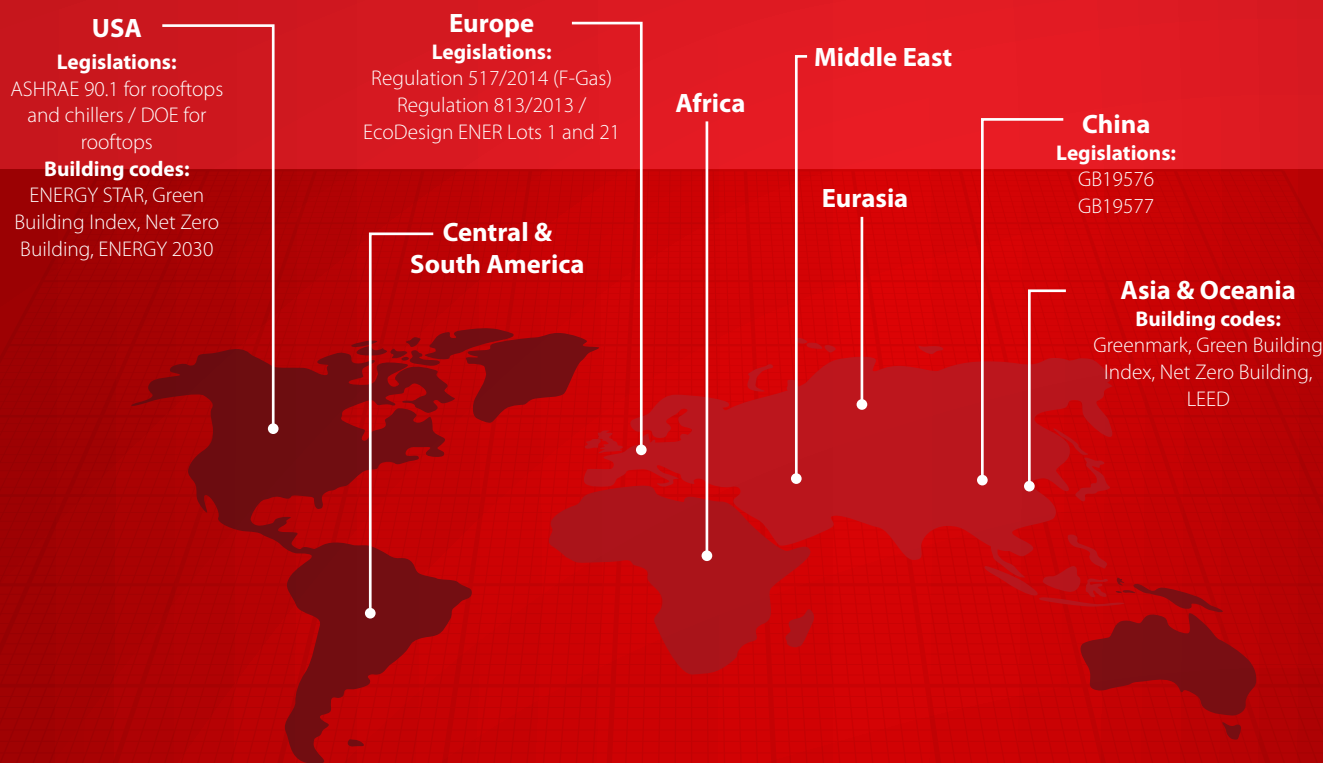

A revolution in the A/C market ...

Increasing population, level of comfort and high penetration of IT technologies are putting strong pressure on electric grids and driving up overall energy consumption

The increased demand for air conditioning systems and improved comfort is being driven by several factors. Examples include modern office architecture with large windows, as well as new development or renovation of hospitals, hotels, museums or data centers where air conditioning is critical.

New technologies spur the growth of multiple innovative applications, changing the way we live, communicate, conduct business and interact with machines. But new

technologies require more energy. This explosive combination is driving up energy demand and utility peak loads.

Strong pressure to reduce CO₂ emissions

The growing need to reduce CO₂ emissions and save energy has led governments to implement regulations to protect the environment and encourage the development of energy efficient solutions.

... opens up new opportunities

A few years ago, 60-80% of air conditioning systems (chillers, rooftops, etc.) did not comply with the new standards and needed to be redesigned⁽³⁾. Original Equipment Manufacturers are increasingly being challenged. OEMs

need to provide integrated solutions with superior reliability and efficiency that are easy to install and maintain. All this calls for new thinking and a new set of technologies.

Danfoss innovations support OEMs in the challenge of improving part-load efficiency and maintaining full-load performance while transitioning to low-GWP alternatives and keeping development costs at competitive levels. Our technologies provide OEMs and end-users alike with a lifetime of savings.

(3) Source Danfoss – Simulation based on Eurovent database and European draft for Ecodesign ENTR LOT 21 Tier2 level in 2014.

Danfoss compressors for air conditioning – a lifetime of savings

To meet the needs of an increasingly complex HVAC market, our extensive range of compressors offer functional benefits and savings throughout the lifecycle of the system from development and operating costs to servicing and maintenance.



Development costs

The flexibility, optimization and efficiency of Danfoss compressors ensure competitive design costs and short development times



Running costs

Danfoss technologies offer the widest portfolio for superior full and part-load efficiencies to reduce the running costs of the system



Service costs

The reliability, design and long working life of Danfoss compressors minimize maintenance and servicing costs while eliminating unplanned downtime







Savings on development costs

Commercial and office buildings, hotels, shopping malls, airports, hospitals, data centers, schools, museums... Every type of building, occupancy, comfort requirements and climate, place different demands on HVAC system design and technological options.

Whatever the target application or industry, Danfoss provides OEMs flexible and competitive design solutions for commercial rooftops, chillers, close controls, heat pumps and process chillers with shorter time to market and competitive applied costs.



Manifold configurations enable competitive design costs and staged modulation

Several compressors can be installed in a single system to provide flexible modulated cooling capacity. This approach extends capacity and performance while maintaining design and applied costs at competitive levels.

Manifold configurations allow a wide system line up with few compressor models. Manifolding also offers a lower sound level compared to alternative technologies.

Our expertise in manifold design enables Danfoss to provide a wide range of potential configurations, from 5 to 150TR in a single circuit. Danfoss goes through a full set of lab qualification tests in order to provide reliable solutions for piping strength, oil balancing, sound and vibrations.





Applying **variable speed** technology keeps getting easier

Variable speed technology offers flexible design possibilities with a wide range of cooling capacities to match different applications and needs. It offers savings in reduced inventory and complexity. In addition, some system components are not always longer needed, including soft starter, phase protectors, etc., and water buffer tanks have been either reduced or eliminated – all of which helps to ensure the competitiveness of development costs.

Danfoss inverter scrolls VZH – 3rd generation with IDVs

3rd generation of Danfoss inverter scrolls have been optimized for part-load operations to deliver a high level of efficiency across a wide range of applications. The prequalified compressor and drive packages reduce development time while increasing reliability. The Danfoss inverter scroll VZH with IDVs ranges from 4 to 26TR (52TR when used in hybrid tandems@ full speed) in one circuit. The 3rd generation of inverter scrolls VZH features extended operating map to fit more applications especially Close Control / CRAC units. It is the widest variable speed scroll lineup available in the world commercial HVAC market today.



IDV technology

Intermediate Discharge Valves (IDVs) are mechanical valves that improve the part-load efficiency of air conditioning systems.

Danfoss patented IDVs are being integrated into the 7.5 to 50 ton range of the Danfoss DSH scrolls, in the DSF scrolls and in the VZH inverter scrolls. The Danfoss DSH and VZH scroll ranges with IDVs are **backward compatible** with existing Danfoss scrolls to reduce complexity and minimize any need for redesign and qualification.

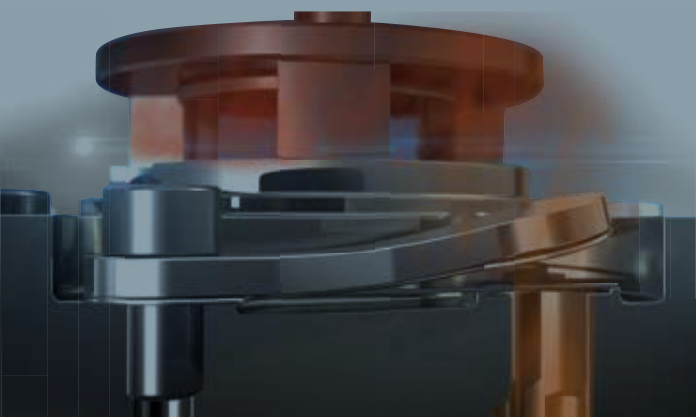

Danfoss Turbocor® compressors

Danfoss Turbocor® compressors have transformed the commercial HVAC market with innovative technology that redefines lifetime operating costs for chiller applications. Danfoss Turbocor®'s family of centrifugal compressors is the world's first range of totally oil-free compressors. They feature innovative yet proven technologies including magnetic bearings, variable-speed centrifugal compression and digital controls.

All Danfoss Turbocor® TTS and TGS have the same physical size and connection locations. They also use the same controls and monitoring interface module and standard mounts. Their extremely compact size and low weight allows OEMs and contractors to cost-effectively install the compressor with a much smaller footprint than conventional compressors. Exceptional low-noise operation with no vibration eliminates the need for additional noise protection.





Savings on running costs with the widest portfolio for superior part-load efficiency

Reduce CO₂ emissions and energy consumption to get to the energy efficiency standards:
Danfoss provides three options to help OEM customers meet the challenge

Manifold compressors

Enhancing part-load efficiency with staged modulation

The number of compressors running at any one time can be adapted to building occupancy and demand levels. This improves cooling efficiency and reduces energy use. Energy

performance is further enhanced with Danfoss IDV technology. In other terms, the benefits for the running costs of this type of system include:

- Up to 12 steps of capacity modulation for precise load-matching capabilities (trio in 4 circuits)
 - high part-load / seasonal efficiency
- Our even and uneven manifold configurations up to 150TR in one circuit offer wide staged capacity modulation. For example, a system

with six manifold compressors in two circuits offers capacity modulation from 17% to 100%. This enables higher part-load efficiency compared to screw technology in a system of equivalent capacity. Danfoss IDV technology, implemented in the 7.5-50 ton range of the fixed-speed Danfoss Scrolls DSH/DSF and Danfoss inverter Scrolls, further enhances energy efficiency under part load conditions.



Superior part-load efficiency with Danfoss IDVs

A/W Chillers with 2 trio circuits 3x25TR

Reduced yearly power demand (kWh)

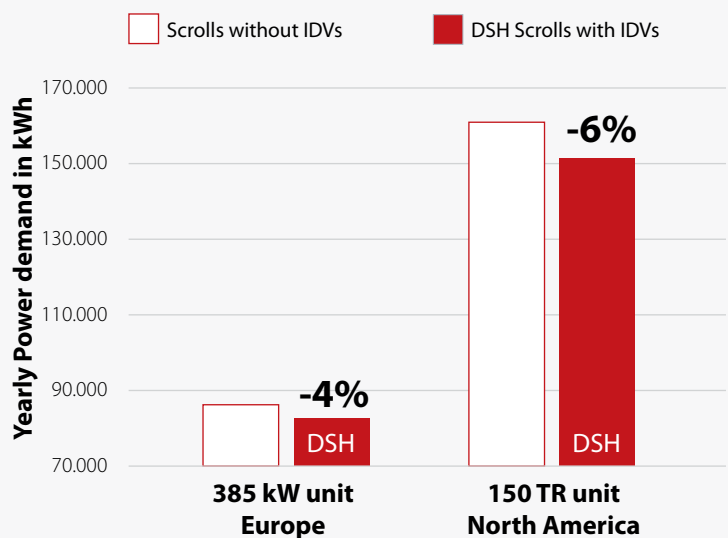

➤ Low Pressure Ratio, part-load, discharge pressure is low, IDVs open

➤ High Pressure Ratio, full load and heating mode, discharge pressure is high, IDVs close

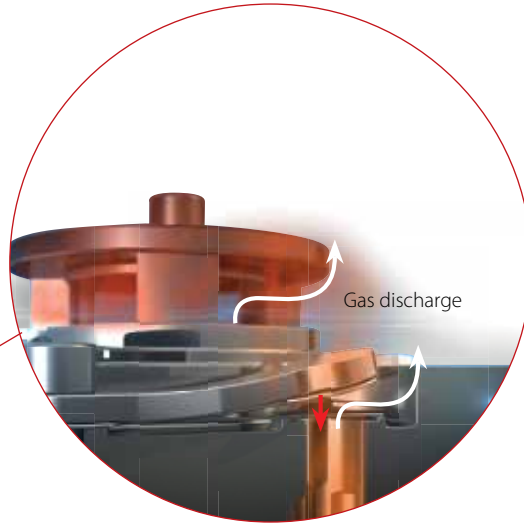

Danfoss IDVs

Danfoss Intermediate Discharge Valves (IDVs) mechanically reduce excessive compression of refrigerant under part-load conditions while maintaining the same cooling capacity. They adapt the effort of the motor to the pressure conditions in the system by opening when the pressure ratio (part-load) fall

below the built-in optimization point of the scroll. This reduces the effort of the motor and its electrical consumption thus improving the system's seasonal energy efficiency. IDV technology enhances system efficiency by 10-12% on average in Water-to-Water chillers and by 8-10% in rooftops and 6-8% in Air-to-Water chillers.

Less CO₂ emissions

European SEER according to EN14825

385 kW A/W Chillers

Variable outlet water temperature control from 7 to 11.5°C

Chiller parameters:

Tcond: 50° C

Tevap: 3.5° C

Fan Pw: 9.5% of Compressor Power at full load

North American IPLV according to ANSI/AHRI standard 550/590

150 TR A/W Chillers

Fixed outlet water temperature control @ 44°F

Chiller parameters:

Tcond: 122° F

Tevap: 39° F

Fan Pw: 9.5% of Compressor Power at full load

	Std. Scrolls	DSH	Difference
EERnet	2.89	2.87	
SEER	4.15	4.37	+5%
Pw demand (kWh)	86 223	82 516	-4%
Running costs (€) (*)	14 658	14.028	-630 €
CO₂ emission (metric Tons) (**)	34.5	33.0	-1.5

(*) based on European average climate: 2 602 running hours
17 €cents per kWh: European average for commercial buildings
(**) 0.0004 Tons of CO₂ per kWh, EU average 2015

	Std. Scrolls	DSH	Difference
EER	10.2	10.2	
IPLV	15.5	16.65	+7%
Pw demand (kWh)	160 943	151 402	-6%
Running costs (US\$) (*)	17 092	16 079	-1 013 \$
CO₂ emission (metric Tons) (**)	95.4	89.7	-5.7

(*) based on 2 973 running hours
10.62\$cents per kWh: US average for commercial buildings
(**) 0.000593 Tons of CO₂ per kWh, US average 2015



Savings on running costs



Variable speed technology

Continuously matches cooling needs with high efficiency

Variable speed technology is the premium solution in commercial air conditioning when it comes to energy savings, optimal comfort, accurate humidity and temperature control and controlled impact on the electrical network.

Around 85% of traditional commercial air conditioning installations are oversized to enable them to handle peak load conditions (about 3% of the operating time). Variable speed technology continuously matches building cooling demand under part-load conditions which is the vast majority of operating time. It also handles peak load conditions in a cost effective way. With a very low starting current and the ability to manage power fluctuations, Danfoss variable speed solutions ease the strain on power grids.

Danfoss is a world leader in this segment and offers the widest available range of commercial scroll, reciprocating and oil-free centrifugal inverter compressors for systems from 3 to 350 tons in single compressor/circuit configurations. Capacities of over 1,000 tons can be achieved by using multiple compressors and circuits.

Danfoss Inverter Scrolls VZH – 3rd generation with IDVs

3rd generation Danfoss inverter scrolls feature an Interior Permanent Magnet (IPM) and dedicated variable speed drive designed to provide maximum efficiency across the full operating range. Adapting to varying pressure ratios, it delivers the highest level of efficiency across a wide range of applications. Numerous case studies in renovation projects and laboratory testing demonstrate energy savings of up to 35%.

Savings with Danfoss inverter scrolls VZH

European SEER according to EN14825
100kW A/W Rooftop: 1 circuit

	Tandem 15TR	Inverter scroll VZH117	Difference
EERnet	3.22	3.17	-2%
SEER	3.16	4.15	31%
Annual En. Input (kWh)	29 386	22 470	-24%
Running cost (€) (*)	4 996	3 820	-1 176 €
CO₂ emission (metric Tons) (**)	11.8	9.0	-2.8

Rooftop parameters:
Tcond: 50° C
Tevap: 11° C
Fan Pw(*): 9.5%
Evap. Fan Pw(*): 18.0%
(*): of Comp. Pw at full load

(*) based on European average climate: 2602 running hours
 17 € cents per kWh: European average for commercial buildings (VAT incl.)
 (**) 0.0004 Tons of CO₂ per kWh, EU average 2015



Savings with Danfoss Turbocor® compressors TT 200 TR (700 kW) Air-cooled Chiller

Danfoss Turbocor® oil-free centrifugal technology

The Turbocor® family of compressors delivers outstanding energy efficiency in full- and part-load operation with energy savings of more than 42% compared to traditional compressors. The outstanding integrated part-load efficiency is the result of optimum energy performance through the entire operating range from 100% to ~20%.

The Danfoss Turbocor® compressor uses an integrated variable frequency drive to reduce compressor speed and maximize energy cost savings as the condensing temperature and/or heat load decreases. The soft start module, which is standard on every Danfoss Turbocor® compressor, significantly reduces the in-rush current at start up, provides advantages to line power systems and reduces thermal stress on the stator.

* Same chiller manufacturer for both

** Performance degradation resulting from oil logging in heat exchangers

featuring	Inverter Screw	TT350	Savings
Compressor/Chiller Specifics			
Nb of compressors	2	2	—
Performance/physical data Comparison			
Full Load Efficiency (compressor COP)	3.70	3.81	3%
Full Load Efficiency (example chiller* COP)	3.10	3.40	10%
Part Load Efficiency (example chiller* ESEER)	4.60	5.60	22%
Sound power levels (unattenuated chiller* dBA)	101	92	-9
Physical weight (compressor kg)	745	136	82%
Footprint (compressor cubic meters)	0.62	0.20	68%
Annualized lifetime maintenance cost (USD)	2 260	900	1 360
Design/Operation Comparison			
Operating Map (temperature) Flexibility	High	Med	Screw
Unloading for Extreme Temperature Applications	High	Med	Screw
Design Life	20 years	20 years	—
Quick Restart. Loading and Adjustment	Med	High	Turbocor®
Long-Term Performance Sustainability – Oil Free	No**	Yes	Turbocor®
Maintenance – Oil free	No	Yes	Turbocor®
Reliability – Oil free	No	Yes	Turbocor®



Savings on service and maintenance costs

HVAC units often operate under harsh conditions that can affect the lifetime and reliability of the unit itself: Frequent on/off cycling, high ambient start-up, defrost mode, low superheat conditions, high ambient operations, oil equalization and oil return at part-load operations can all have severe effects on the entire lifetime and compressor applications.

Danfoss scrolls DSH and DSF: a proven level of compressor robustness and system reliability

Danfoss has over 15 years of experience in R410A scroll compressors and billions of compressor operating hours in chiller applications worldwide. Building on this knowledge, Danfoss reliability and R&D teams use advanced statistical tools and psychrometric laboratory tests to study and measure the implications of system operations in critical conditions on compressor reliability. This has enabled Danfoss to develop the necessary countermeasures to improve compressor durability in many different applications. The generation of DSH and DSF Danfoss scrolls include several innovative features to improve compressor and system robustness.

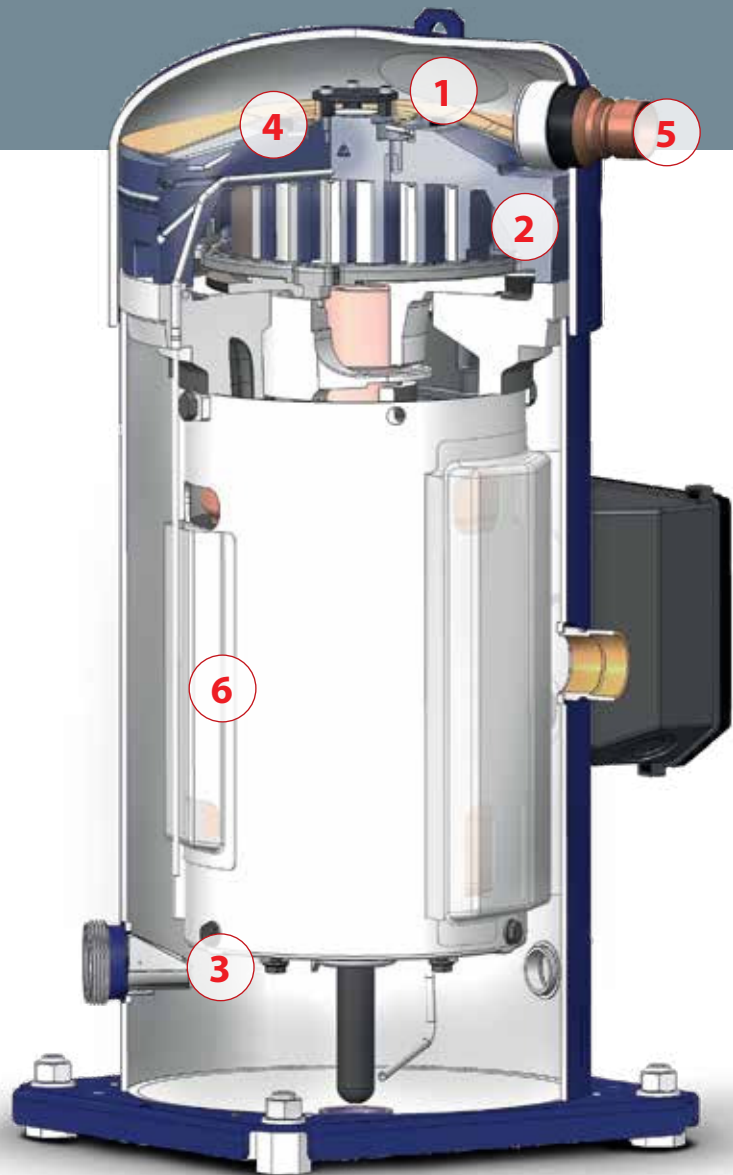

1. Intermediate Discharge Valves:

Reduce the load on mechanical parts at start up, provide safer operation at high condensing and evaporating temperatures and contribute to better liquid management

2. Surface coating on thrust bearing and polymer bearings:

Improves compressor robustness in low lubrication conditions (start-up)

3. Organ pipe:

Maintains safe oil level at part-load in manifold configurations

4. Integrated Non-Return Valve:

Reduces refrigerant migration from high-pressure to low-pressure side after compressor shutdown

For DSH and DSF Large 20 to 50TR (240 to 600):

5. Integrated discharge temperature protection:

Prevents operation outside the operating envelope

6. Modified gas flow path (Snorkel) and sealed lower bearing:

Improves flooded start capabilities and overall compressor robustness against liquid slugs

Additional Reverse Vent Valve on DSH 090 to DSH 184 and DSF prevent from reversed rotation in case of wrong phase connection

Extended equipment life and minimal scheduled maintenance with oil-free Danfoss Turbocor® compressors

Reduced maintenance and mechanical complexity are primarily driven by the elimination of oil from the refrigerant circuit. Friction-free magnetic bearing technology eliminates the cost of oil-related equipment and management hardware as well as the maintenance costs associated with oil service.

This helps maintain long-term heat exchanger performance and delivers outstanding sustainability and long service life.

Onboard intelligent electronic controls enable effective monitoring, control and self-diagnosis/correction of system operation. This eliminates some traditional OEM control and power panel costs and creates a sustainable, energy-efficient solution.

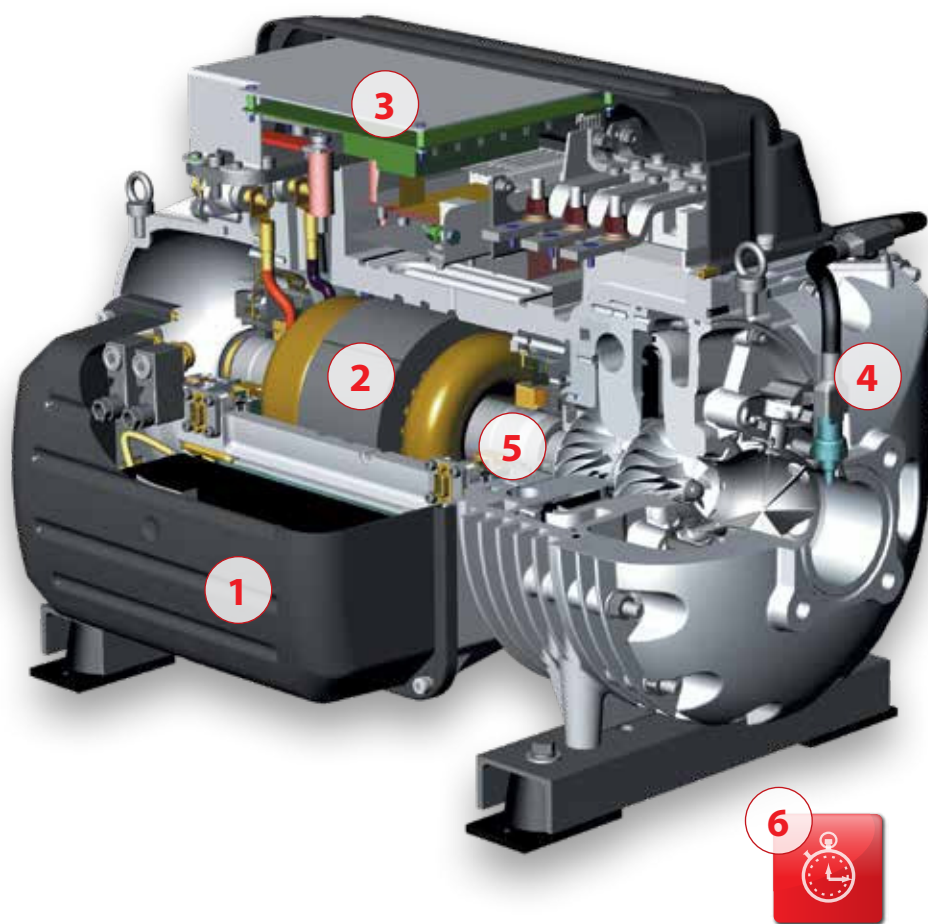

1. Motor and bearing control

Onboard digital electronics monitor compressor operation for optimization, reliability and diagnosis.

2. Permanent magnet motor

High-speed permanent magnet motor provides outstanding full-load efficiency.

3. Soft-Starter

The built-in soft-starter significantly reduces high in-rush current at start up to only 2 amps and is maintenance free.

4. Pressure and temperature sensors

Feed information back to the controller to ensure the compressor operates within its designed envelope at all times.

5. Magnetic levitation

Totally oil-free design eliminates performance degradation and maintenance of oil-related equipment.

6. Fast Re-Start

The compressor can be configured to restart in less than 30 seconds following a power outage without the need for a UPS which allows the Chiller to resume operation quickly.

Danfoss solutions for a lifetime of savings

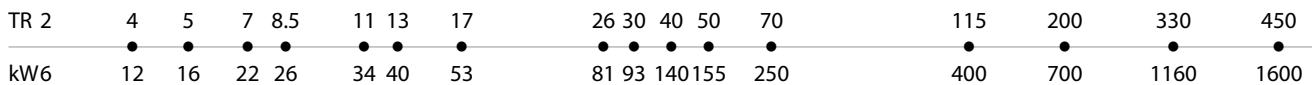
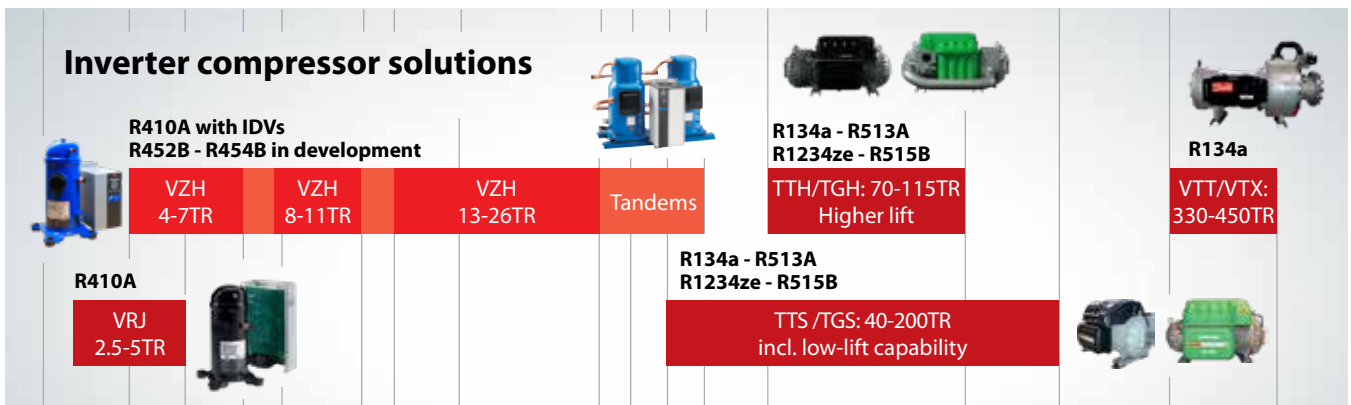
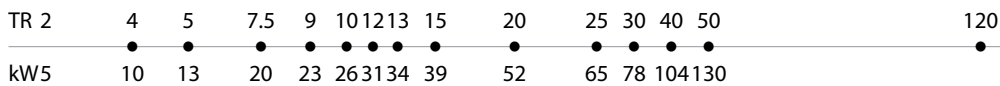
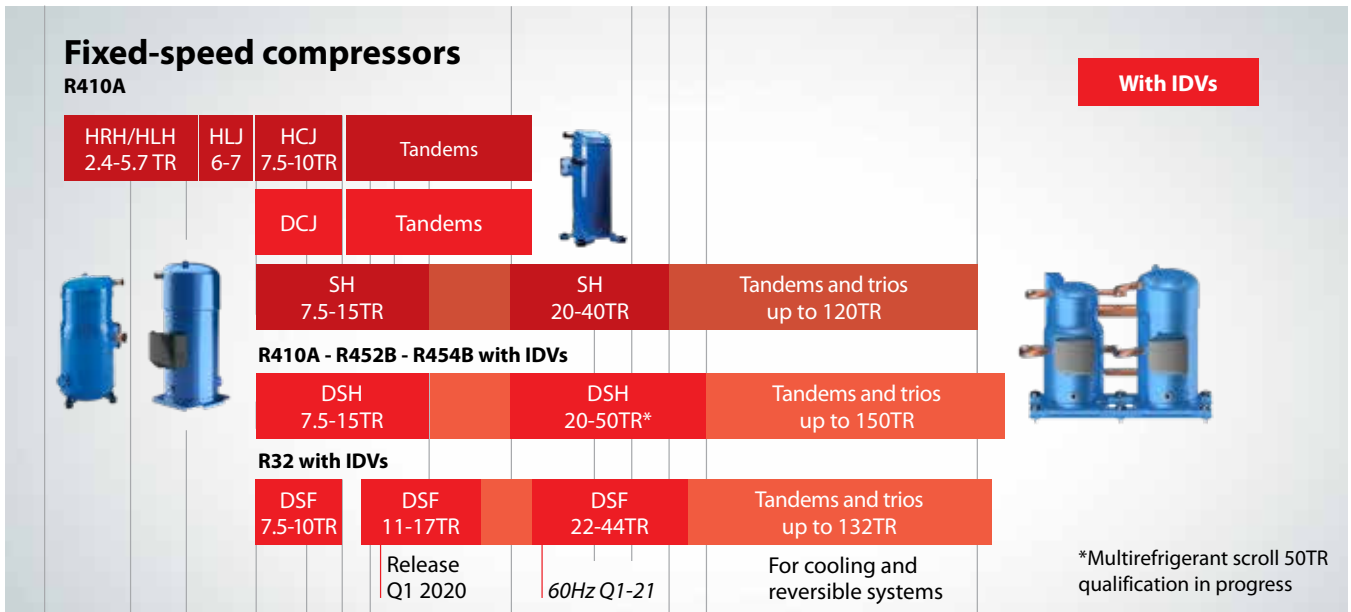

Rating (TR): ARI 45°F / 145°F / SH 20°F / SC 10°F
 Rating (kW): EN12900 5°C / 50°C / SH 10K / SC 0K - data at max speed for inverter scrolls
 Rating conditions are for Scroll compressors only.

Danfoss Scrolls H, SH, DSH and DSF series

R410A - 400V / 3 ~ / 50Hz

Model	Nominal cooling capacity	50 Hz, EN12900 ratings	
		Cooling capacity	Efficiency
	TR - 60Hz	W	COP in W/W
HRH029	2.4	6,300	2.86
HRH031	2.6	6,700	2.77
HRH032	2.7	6,800	2.77
HRH034	2.8	7,500	2.88
HRH036	3.0	7,800	2.79
HRH038	3.2	8,200	2.72
HRH040	3.3	9,000	2.79
HRH041	3.3	8,900	2.88
HRH044	3.7	9,600	2.77
HRH049	4.1	10,700	2.96
HRH051	4.3	11,400	3.01
HRH054	4.5	11,900	2.96
HRH056	4.7	12,300	2.98
HLH061	5.1	13,200	3.01
HLH068	5.7	15,000	3.11
HLJ072	6.0	15,800	3.11
HLJ075	6.3	16,500	3.12
HLJ083	6.9	18,200	3.13
DCJ091	7.5	19,600	3.09
DCJ106	8.8	23,000	3.12
DCJ121	10	26,250	3.11
DSH090	7.5	20,050	3.06
DSH105	9	23,580	3.08
DSH120	10	26,790	3.11
DSH140	12	30,370	3.13
DSH161	13	34,890	3.16
DSH184	15	39,040	3.16
DSH240	20	52,730	3.10
DSH295	25	64,520	3.17
DSH381	32	81,490	3.11
DSH485	40	103,530	3.16
DSH600	50	128,860	3.18

R454B - 400V / 3 ~ / 50Hz

Model	50 Hz, EN12900 ratings	
	Cooling capacity	Efficiency
	W	COP in W/W
DSH090	19,350	3.05
DSH105	22,940	3.18
DSH120	26,220	3.23
DSH140	29,880	3.24
DSH161	34,150	3.28
DSH184	37,930	3.26
DSH240	51,570	3.25
DSH295	63,310	3.32
DSH381	78,860	3.19
DSH485	101,650	3.34

R32 - 400V / 3 ~ / 50Hz

Model	50 Hz, EN12900 ratings	
	Cooling capacity	Efficiency
	W	COP in W/W
DSF270	60,040	3.34
DSF325	72,500	3.37
DSF485	107,100	3.38
DSF530	117,000	3.41

Data given for Code 4: 400V - 50Hz

Net weight with oil charge
 TR = Ton of Refrigeration
 COP = Coefficient Of Performance,
 400V / 3ph / 50Hz
 EER = Energy Efficiency Ratio,
 460V / 3ph / 60Hz
EN12900: evap. temp. 5 °C/41°F; cond.
 temp. 50 °C/122°F; superheat: 10 K/18°F;
 subcooling: 0 K

Ready for

GWP
<750

refrigerants: R452B,
 R454B and R32.



For full data details, capacity tables or use with other refrigerants, please refer to the Coolselector®2:
coolselector.danfoss.com

Danfoss Scrolls H, SH and DSH series

R410A - 460V / 3~ / 60Hz

Model	Nominal cooling capacity	60 Hz, ARI ratings			
		Cooling Capacity		Efficiency	
		TR - 60Hz	W	Btu/h	COP in W/W
HRH029	2.4	8,500	29,000	2.99	10.20
HRH031	2.6	9,100	31,100	2.99	10.20
HRH032	2.7	9,400	32,100	3.02	10.31
HRH034	2.8	10,100	34,500	2.99	10.20
HRH036	3.0	10,400	35,500	2.99	10.20
HRH038	3.2	11,100	37,900	2.93	10.00
HRH040	3.3	12,200	41,600	3.02	10.31
HRH041	3.3	12,100	41,300	2.99	10.20
HRH044	3.7	13,000	44,400	3.02	10.31
HRH049	4.1	14,300	48,800	3.08	10.51
HRH051	4.3	15,200	51,900	3.14	10.72
HRH054	4.5	16,000	54,600	3.11	10.61
HRH056	4.7	16,700	57,000	3.11	10.61
H LH061	5.1	18,100	61,800	3.17	10.82
H LH068	5.7	20,100	68,600	3.20	10.92
H LJ072	6.0	21,200	72,400	3.19	10.89
H LJ075	6.3	22,300	76,100	3.25	11.09
H LJ083	6.9	24,300	82,900	3.22	10.99
DCJ091	7.5	27,100	92,500	3.23	11.01
DCJ106	8.8	31,500	107,400	3.25	11.11
DCJ121	10	35,700	121,900	3.21	10.96
DSH090	7.5	27,470	93,800	3.21	10.96
DSH105	9	32,280	110,200	3.22	11.00
DSH120	10	36,630	125,000	3.26	11.11
DSH140	12	41,510	141,700	3.26	11.12
DSH161	13	47,220	161,200	3.21	10.96
DSH184	15	53,160	181,400	3.25	11.09
DSH240	20	71,720	244,800	3.20	10.91
DSH295	25	87,570	298,900	3.25	11.09
DSH381	32	110,210	376,200	3.20	10.91
DSH485	40	141,850	484,100	3.25	11.10
DSH600	50	189,860	601,610	3.27	11.15

R454B - 460V / 3~ / 60Hz

DSH090	-	19,350	66,010	3.05	10.41
DSH105	-	22,940	78,270	3.18	10.85
DSH120	-	26,220	89,470	3.23	11.02
DSH140	-	29,880	101,950	3.24	11.06
DSH161	-	34,150	116,530	3.28	11.19
DSH184	-	37,930	129,410	3.26	11.12
DSH240	-	51,570	175,970	3.25	11.09
DSH295	-	63,310	216,020	3.32	11.33
DSH381	-	78,860	269,080	3.19	10.88
DSH485	-	101,650	346,850	3.34	11.40

Ready for
GWP
<750
refrigerants: R454B,
R32 in development

Data given for Code 4: 460V - 60Hz: 3 phases.

Net weight with oil charge
TR = Ton of Refrigeration
COP = Coefficient Of Performance,
400V / 3ph / 50Hz
EER = Energy Efficiency Ratio, 460V /
3ph / 60Hz

ARI: evap. temp. 7.2 °C/45°F; cond. temp.
54.4 °C/130°F; superheat 11.1 K/20°F;
subcooling 8.3 K/15°F



For full data details, capacity tables or use with other refrigerants, please refer to the Coolselector®2:
coolselector.danfoss.com

Manifold configurations with Danfoss Scrolls

A wide line-up with few compressor models

Rating conditions – R410A

Evaporating temp.:	50 Hz - EN12900 5°C / 41°F	60 Hz - ARI 7.2°C / 45°F
Condensing temp.:	50°C / 122°F	54.4°C / 130°F
Super heat:	10K / 18°F	11.1K / 20°F
Sub-cooling:	0K	8.3K / 15°F

○ Tandem ● Trio

Cooling capacity in TR @ 60Hz ARI

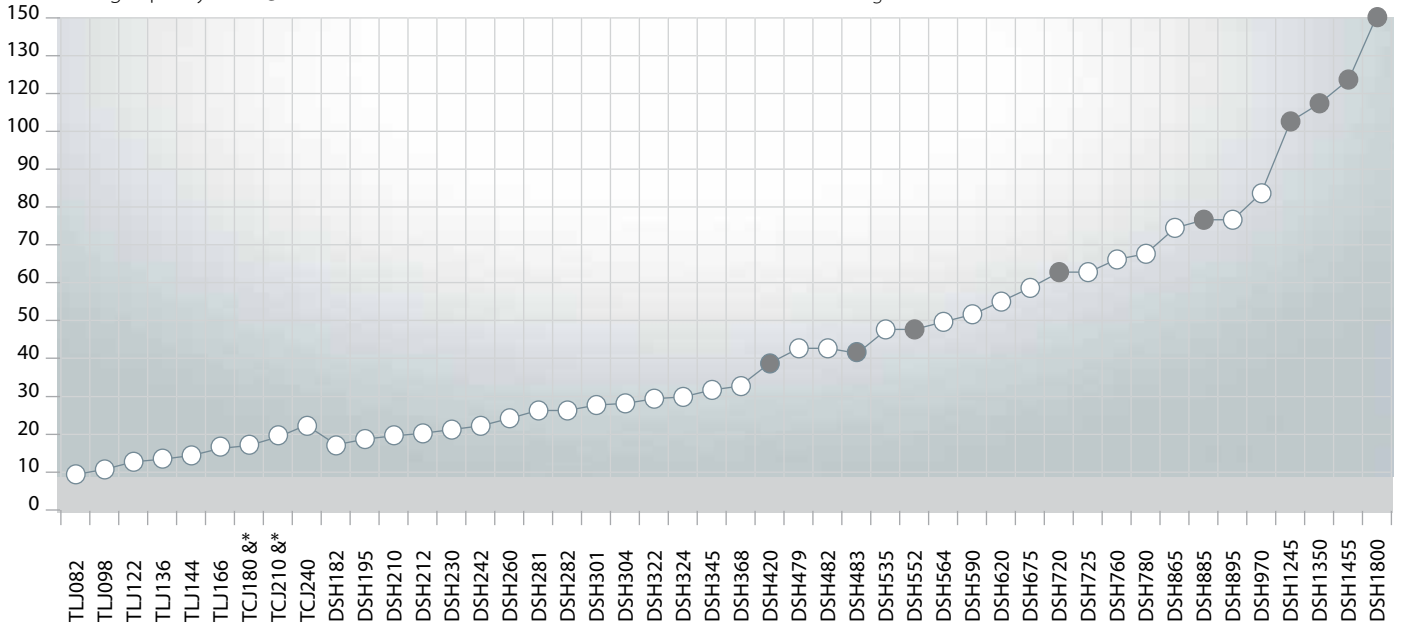

&*: see complete list of combinations of the same cooling capacity in the table below.

Model	Composition	Cooling capacity – R410A	
		60 Hz – TR ARI	50 Hz – W EN 12900
TLJ082	HRH041 + HRH041	7	18,800
TLJ098	HRH049 + HRH049	8	21,400
TLJ122	HLH061 + HLH061	10	26,200
TLJ136	HLH068 + HLH068	11	29,900
TLJ144	HLJ072 + HLJ072	12	31,600
TLJ166	HLJ083 + HLJ083	14	36,200
TCJ180	H CJ090 + H CJ090	15	39,600
TCJ181	H CJ091 + H CJ091	15	40,000
DCJ181	DCJ091 + DCJ091	15	39,300
TCJ210	H CJ105 + H CJ105	17.5	46,200
DCJ212	DCJ106 + DCJ106	17.5	46,000
TCJ211	H CJ105 + H CJ105	17.5	46,600
TCJ211	H CJ105 + H CJ105	17.5	46,600
TCJ240	H CJ120 + H CJ120	20	52,000
TCJ241	DCJ121 + DCJ121	20	52,500
DSH090			19,350
DSH105			22,940
DSH120			26,220
DSH140			29,880
DSH161			34,150
DSH182	DSH090 + DSH090	15	39,300
DSH184			37,930
DSH195	DSH090 + DSH105	16	43,300
DSH210	DSH090 + DSH120	17.5	46,100
DSH212	DSH105 + DSH105	17.5	47,200
DSH230	DSH090 + DSH140	19	50,200
DSH240			51,570
DSH242	DSH120 + DSH120	20	52,800
DSH260	DSH120 + DSH140	21.5	57,000
DSH281	DSH120 + DSH161	23.5	60,700
DSH282	DSH140 + DSH140	23.5	61,100
DSH295			63,310

Model	Composition	Cooling capacity – R410A	
		60 Hz – TR ARI	50 Hz – W EN 12900
DSH301	DSH140 + DSH161	25	64,900
DSH304	DSH120 + DSH184	25.5	65,800
DSH322	DSH161 + DSH161	27	68,600
DSH324	DSH140 + DSH184	27	70,000
DSH345	DSH161 + DSH184	29	73,700
DSH368	DSH184 + DSH184	30.5	78,800
DSH381			78,860
DSH420	3 x DSH140	36	89,100
DSH424	DSH184 + DSH240	35	90,900
DSH479	DSH184 + DSH295	40	102,600
DSH482	DSH240 + DSH240	40	105,420
DSH483	3 x DSH161	39	102,400
DSH485			10,650
DSH535	DSH240 + DSH295	45	117,230
DSH552	3 x DSH184	45	114,500
DSH564	DSH184 + DSH381	47	119,400
DSH590	DSH295 + DSH295	49	129,040
DSH620	DSH240 + DSH381	52	132,380
DSH675	DSH295 + DSH381	56	144,190
DSH720	3 x DSH240	60	156,050
DSH725	DSH240 + DSH485	60	155,210
DSH760	DSH381 + DSH381	63	159,340
DSH780	DSH295 + DSH485	65	167,020
DSH865	DSH381 + DSH485	72	182,170
DSH885	3 x DSH295	75	191,020
DSH895	DSH600 + DSH295	75	193,380
DSH970	DSH485 + DSH485	80	204,990
DSH1245	2 x DSH381 1 x DSH485	100	260,600
DSH1350	1 x DSH381 2 x DSH485	110	303,800
DSH1455	3 x DSH485	120	303,460
DSH1800	3 x DSH600	150	386,600

Danfoss Inverter Scrolls VZH series

**New
MCX
15/20B2**

includes control logic libraries*

Technical data

VZH 4-7TR (3~)				Cooling			Heating			
				Capacity	Efficiency		Capacity	Efficiency		
Models	Speed	Conditions	TR	kW	EER [Btu/Wh]	COP [W/W]	Speed	kW	EER [Btu/Wh]	COP [W/W]
VZH028	15 RPS	Part load (1)	0.71	2.5	17.17	5.03	30 RPS	3.77	9.52	2.79
	Full speed 100 RPS	ARI (2)	4.15	14.6	9.59	2.83	Full speed 100 RPS	13.26	9.89	2.90
		EN12900 (3)	3.67	12.9	9.18	2.71				
VZH035	15 RPS	Part load (1)	0.91	3.2	21.97	5.00	30 RPS	4.71	9.76	2.86
	Full speed 100 RPS	ARI (2)	5.26	18.5	10.17	3.00	Full speed 100 RPS	16.47	10.30	3.02
		EN12900 (3)	4.66	16.4	9.72	2.87				
VZH044	15 RPS	Part load (1)	1.20	4.2	20.68	5.14	30 RPS	6.00	9.93	2.91
	Full speed 100 RPS	ARI (2)	6.77	23.8	10.44	3.06	Full speed 100 RPS	21.04	10.44	3.06
		EN12900 (3)	5.97	21.00	10.00	2.93				
VZH 8.5-11TR (3~)										
VZH052	17 RPS	Part load (1)	1.64	5.80	21.18	6.20	40 RPS	8.15	8.47	2.48
	Full speed 110 RPS	ARI (2)	8.67	30.50	10.09	2.96	100 RPS	26.81	9.67	2.83
		EN12900 (3)	7.70	27.05	9.74	2.85				
VZH065	17 RPS	Part load (1)	2.02	7.10	21.13	6.19	40 RPS	10.50	8.47	2.48
	110 RPS	ARI (2)	10.75	37.80	10.21	2.99	100 RPS	33.20	9.84	2.88
	Full speed 110 RPS	EN12900 (3)	9.56	33.62	9.93	2.91				
VZH 13-26TR (3~)										
VZH088	25 RPS	Part load (1)	4.11	14.45	21.81	6.39	25 RPS	10.47	9.45	2.77
	Full speed 100 RPS	ARI (2)	13.42	47.21	10.20	2.99	Full speed 100 RPS	42.72	10.20	2.99
		EN12900 (3)	11.90	41.85	9.79	2.87				
VZH117	25 RPS	Part load (1)	5.53	19.46	22.56	6.61	25 RPS	13.70	10.00	2.93
	Full speed 100 RPS	ARI (2)	17.89	62.93	10.50	3.08	Full speed 100 RPS	56.45	10.54	3.09
		EN12900 (3)	15.85	55.75	10.10	2.96				
VZH170	25 RPS	Part load (1)	8.05	28.32	22.11	6.48	25 RPS	20.10	10.17	2.98
	Full speed 100 RPS	ARI (2)	26.19	92.11	10.85	3.18	Full speed 100 RPS	80.95	10.85	3.18
		EN12900 (3)	23.15	81.41	10.44	3.06				

RATING CONDITIONS:

- (1) Part load: Evaporating Temp 7.2°C; Condensing Temp 35°C; Superheat 11.1K; Subcooling 8.3K
 (2) ARI: Evaporating Temp 7.2°C; Condensing Temp 54.4°C; Superheat 11.1K; Subcooling 8.3K
 (3) EN12900: Evaporating Temp 5°C; Condensing Temp 50°C; Superheat 10K; Subcooling 0K
 (4) Heating mode: Evaporating Temp -7°C; Condensing Temp 50°C; Superheat 5K; Subcooling 5K.
 All data include drive losses.

* map control, oil management and CDS drive control of VZH inverter scroll compressors and the Modbus master and Heat-sink Control of the CDS drive.

NOTES:

All data are for 380-480V
 Also available for 200-240V

Danfoss Turbocor® Compressors TTS, VTT, TGS, TTH and TGH series

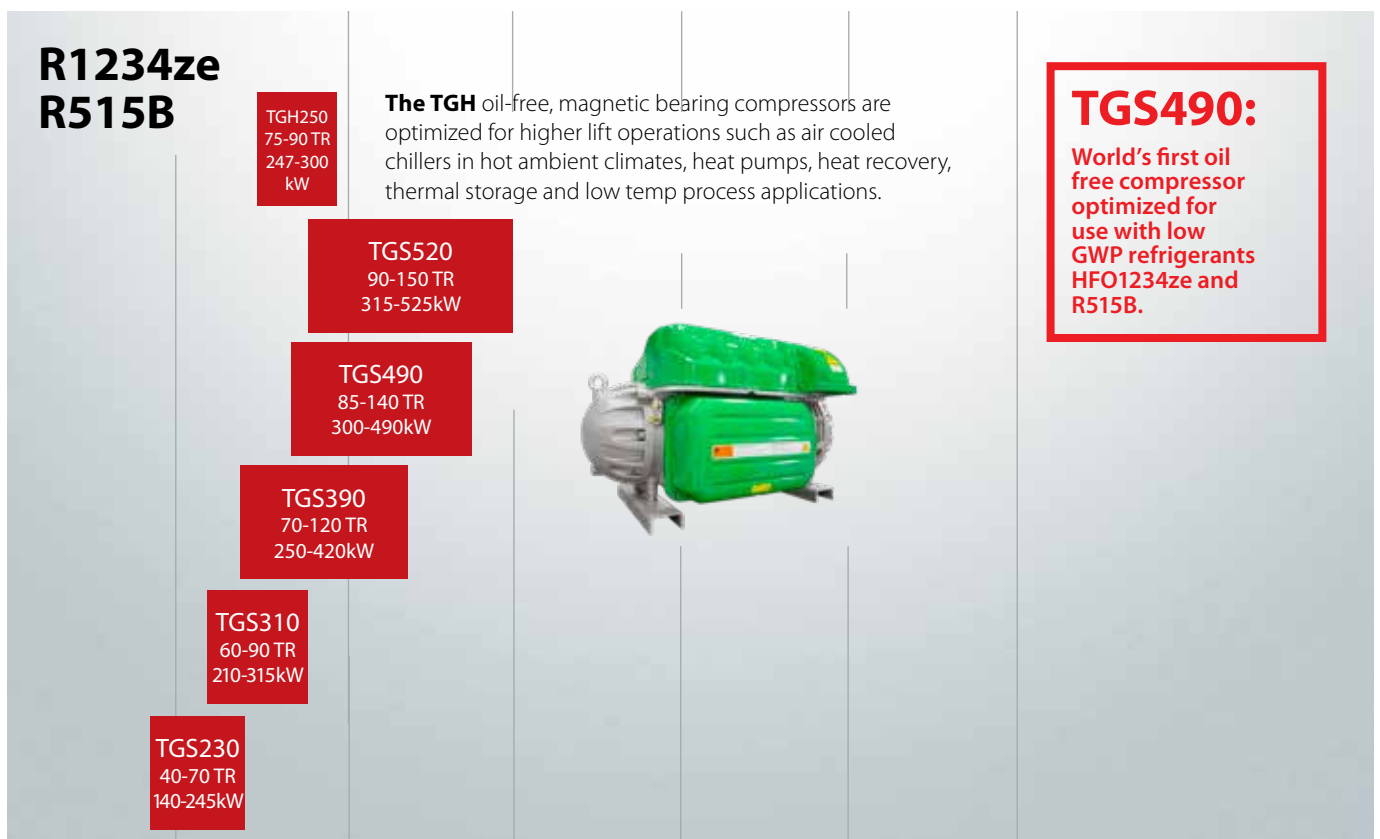
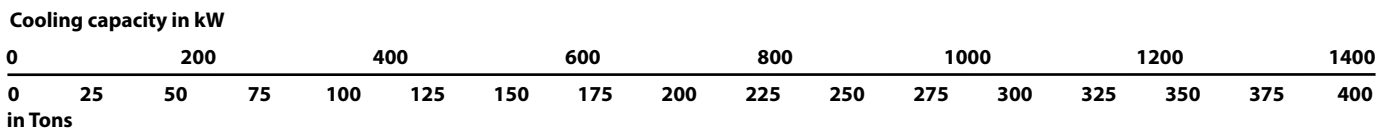
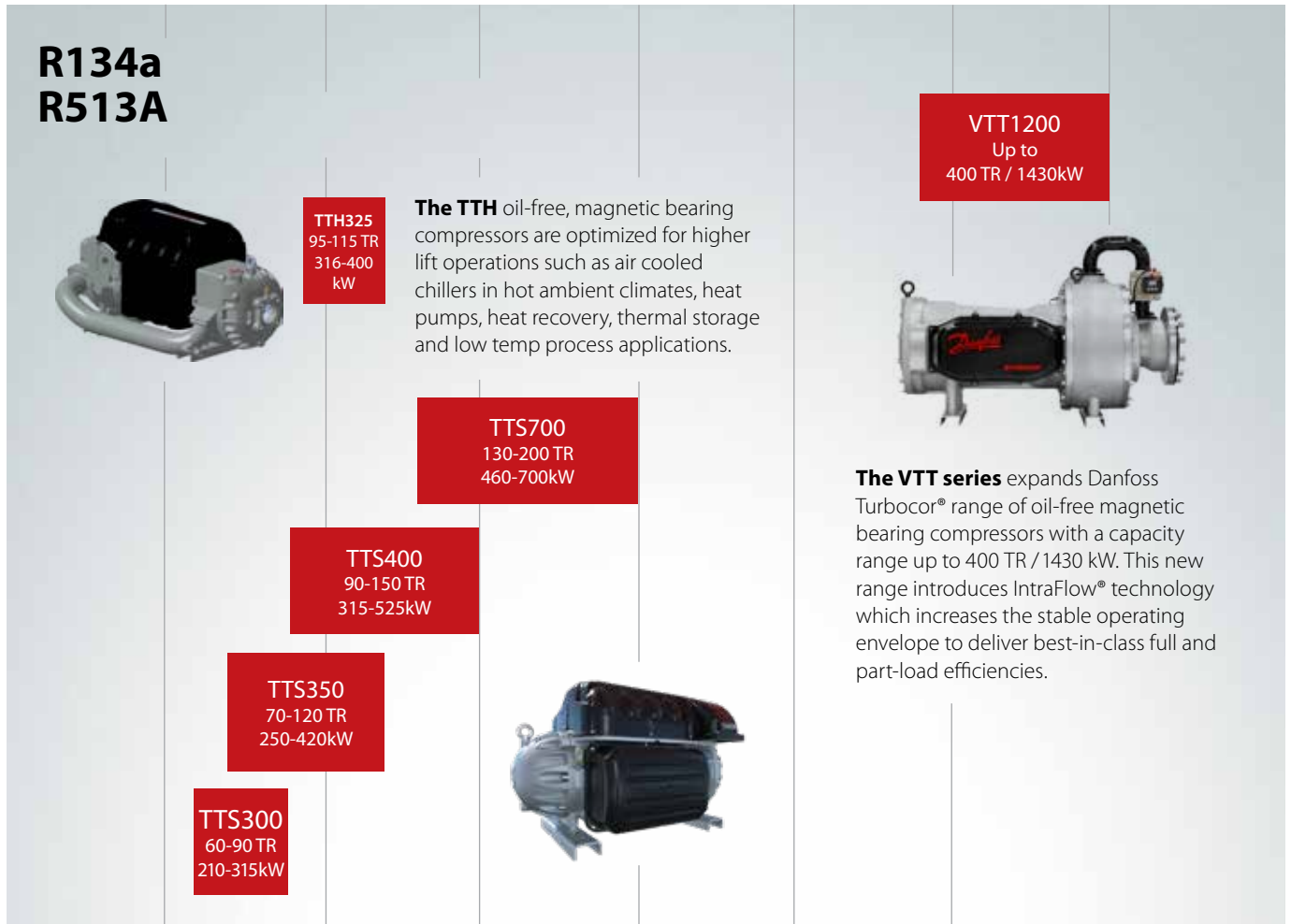

More questions?

Online Self-Service 24/7

- Solutions for air conditioning: airconditioning.danfoss.com
- Product selection: coolselector.danfoss.com
- Literature about commercial compressors: cc.danfoss.com
- Learning platform: learning.danfoss.com
- About inverter technology: invertercompressor.danfoss.com



Danfoss Cooling



Danfoss



@DanfossCool

For more support, contact Danfoss, askcc@danfoss.com

Danfoss can accept no responsibility for possible errors in catalogues, brochures and other printed material. Danfoss reserves the right to alter its products without notice. This also applies to products already on order provided that such alterations can be made without subsequential changes being necessary in specifications already agreed. All trademarks in this material are property of the respective companies. Danfoss and the Danfoss logotype are trademarks of Danfoss A/S. All rights reserved.