

## Installation Guide

### AB-QM installation instructions, Sizes 1/2" to 1 1/4"

#### Contents within box

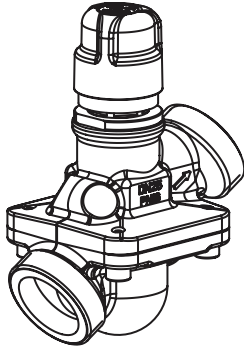

AB-QM 1/2" to 1- 1/4"  
 Max. pressure rating: 300 psi (20 bar)  
 Maximum medium temperature: 250 °F (120 °C)  
 Maximum differential: 60 psi (4 bar)

Description	Code No.
AB-QM 1/2" LF	003Z1321
AB-QM 1/2"	003Z1322
AB-QM 3/4"	003Z1323
AB-QM 1"	003Z1324
AB-QM 1 1/4"	003Z1325
AB-QM 1/2" HF	003Z1332
AB-QM 3/4" HF	003Z1333
AB-QM 1" HF	003Z1334
AB-QM 1 1/4" HF	003Z1335

#### Dimensions:

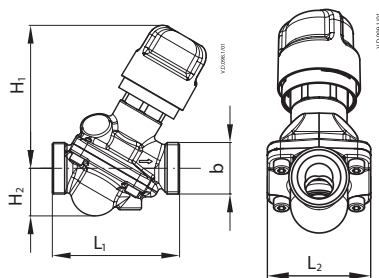

Valve type	Dimensions, in (mm)							
	L <sub>1</sub>	L <sub>1</sub> + tailpieces			L <sub>2</sub>	H <sub>1</sub>	H <sub>2</sub>	b
		MNPT	F. Solder	FNPT				
1/2" LF & 1/2"	2.56 (65)	4.69 (119)	-	1.8 (45)	3.11 (79) 3.18 (81)	0.98 (25)	3/4" NPSM	
1/2" HF	3.23 (82)	5.6 (142)	5.3 (135)	2.2 (56)	3.18 (81) 3.26 (83)	1.3 (33)	1" NPSM	
3/4"	4.09 (104)	6.82 (173)	6.38 (162)	2.8 (71)	3.5 (88)	1.65 (42)	1 1/4" NPSM	
3/4" HF	5.12 (130)	8.12 (206)	-	3.5 (90)	4.02 (102)	1.97 (50)	1 1/2" NPSM	

\* Dimensions shown are approximated and should be verified.

#### Tail pieces:

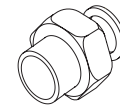

#### Required Tail pieces (Ordered Separately)

Valve Size	MNPT	F. Solder	FNPT
1/2 "	003Z0282	003Z0292	/
3/4 "	003Z0283	003Z0293	003Z1416
1"	003Z0284	003Z0294	003Z1417
1 1/4"	003Z0285	003Z0295	/

Connection to		Description	
Valve	Pipe		
1/2"	1/2"	AB-QM 1/2" to 1/2" Press Fitting kit	DTPK-15-050P
1/2"	3/4"	AB-QM 1/2" to 3/4" Press Fitting kit	DTPK-15-075P
3/4"	1/2"	AB-QM 3/4" to 1/2" Press Fitting Kit	DTPK-20-050P
3/4"	3/4"	AB-QM 3/4" to 3/4" Press Fitting Kit	DTPK-20-075P
1"	1/2"	AB-QM 1" to 1/2" Press Fitting Kit	DTPK-25-050P
1"	3/4"	AB-QM 1" to 3/4" Press Fitting Kit	DTPK-25-075P
1"	1"	AB-QM 1" to 1" Press Fitting Kit	DTPK-25-100P
1 1/4"	1"	AB-QM 1 1/4" to 1" Press Fitting Kit	DTPK-32-100P
1 1/2"	1"	AB-QM 1 1/2" to 1" Press Fitting Kit	DTPK-40-100P

#### General Warnings:

- Prior to the installation of the AB-QM review the entire installation instructions procedure
- Verify AB-QM valve size for installation from valve body plate and box label
- AB-QM valve body is a normally open valve, this means the valve will remain open without an actuator mounted
- Do not power actuator prior to mounting onto the valve body.
- ⚠, Be aware of the ATTENTION symbol

## VALVE INSTALLATION

- ✓ Prior to valve installation review the below step by step procedure and the referenced sections.
- 1. Remove valve from the box. Confirm valve matches installation location
- 2. Install the appropriate tail pieces to the piping, refer to Accessory table.
- 3. Insert gaskets between the tail piece and valve
- 4. Prior to installing the valve:
  - a. Identify proper flow direction through the valve (refer to Flow Direction)
  - b. Properly orient the valve, (refer to Orientation Section)
  - c. Provide proper clearance for actuator (refer to Actuator Instructions)
- 5. Properly tighten the union nuts as per Tightening section
- 6. Insulate valve if needed (refer to Insulation)
- 7. Fill and flush the valve.

## Flow Direction

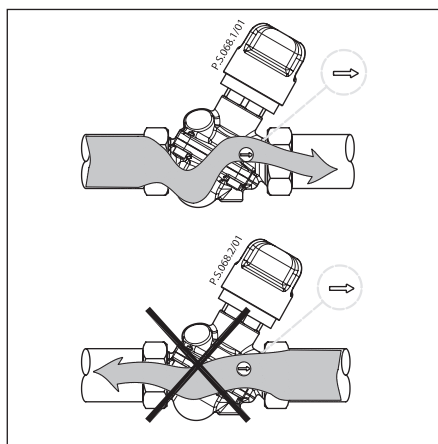

Stamped into the body of the AB-QM valve is an arrow reflecting the proper flow through the valve. If the valve is improperly installed a resulting hammering noise will be heard from the assembly when the valve closes. Prolonged use of the valve in this incorrect orientation can result in internal damage to the valve.

## Insulation

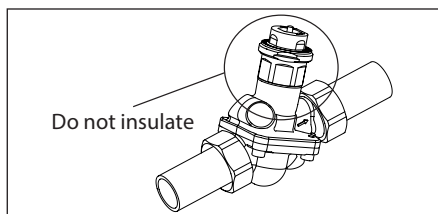

Insulation should not be installed on the upper neck of the valve where the actuator will be mounted and the valve adjustment will be made. The rest of the valve can be insulated.

Max. flow	Flow (GPM)								
	1.2	2.0	4.0	7.5	14.1	5.0	7.5	12.0	17.5
Setting	1/2" LF	1/2"	3/4"	1"	1-1/4"	1/2" HF	3/4" HF	1" HF	1-1/4" HF
20%	0.24	0.40	0.8	1.5	2.8	1.00	1.5	2.4	3.5
25%	0.30	0.50	1.0	1.9	3.5	1.25	1.9	3.0	4.4
30%	0.36	0.60	1.2	2.2	4.2	1.50	2.2	3.6	5.3
35%	0.42	0.70	1.4	2.6	4.9	1.75	2.6	4.2	6.1
40%	0.48	0.80	1.6	3.0	5.6	2.00	3.0	4.8	7.0
45%	0.54	0.90	1.8	3.4	6.3	2.25	3.4	5.4	7.9
50%	0.6	1.0	2.0	3.7	7.0	2.5	3.7	6.0	8.8
55%	0.66	1.10	2.2	4.1	7.7	2.75	4.1	6.6	9.6
60%	0.72	1.20	2.4	4.5	8.4	3.00	4.5	7.2	10.5
65%	0.78	1.30	2.6	4.9	9.2	3.25	4.9	7.8	11.4
70%	0.84	1.40	2.8	5.2	9.9	3.50	5.2	8.4	12.3
75%	0.90	1.50	3.0	5.6	10.6	3.75	5.6	9.0	13.1
80%	0.96	1.60	3.2	6.0	11.3	4.00	6.0	9.6	14.0
85%	1.02	1.70	3.4	6.4	12.0	4.25	6.4	10.2	14.9
90%	1.08	1.80	3.6	6.7	12.7	4.50	6.7	10.8	15.8
95%	1.14	1.90	3.8	7.1	13.4	4.75	7.1	11.4	16.6
100%	1.20	2.00	4.0	7.5	14.1	5.00	7.5	12.0	17.5

Glycol or any additive that changes the density of the fluid through the ABQM will affect the correlated flow percentage and confirmed flow rate through the valve.

## Tightening

Over tightening of the union nut can result in excessive torque applied to the pipe and fittings and potential damage to the gasket. Refer to the table below for proper tightening of the union nuts for the various sizes.

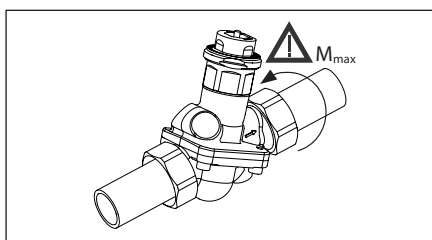

Valve Size	Torque	Degree of turn
1/2"	265.5 - 575.2 lbf.in	60° - 90°
3/4"	442.5 - 885 lbf.in	45° - 75°
1"	1106.3 - 1770.1 lbf.in	
1 1/4"	1593.1 - 2212.6 lbf.in	

## Determination of Flow Percentage

To determine the necessary flow setting percentage, a calculation is required:

$$\frac{\text{Flow requirement}}{\text{Maximum flow rate of valve} \times \sqrt{SG}} \times 100 = \text{Percentage setting}$$

SG...Specific Gravity

Fluid temperature and percent by volume should be taken into consideration for specific gravity of fluid

## Setting of Flow Percentage

- No tools required for flow setting
- Electric actuator should not be assembled on the valve
- Ensure proper differential pressure at critical valve. (refer to minimum pressure drop section)
- Initial setting of the valve when received is at 100% full open.

- A fully closed valve will go below 20% and stop at 90%. A fully open valve can go above 100%.

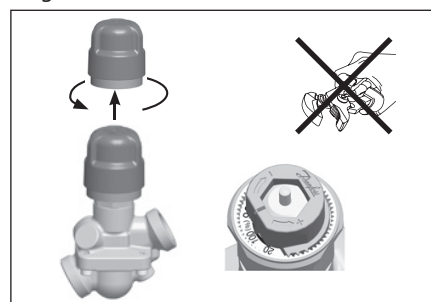

1. Loosen plastic shut off cap and remove it by pulling it off. The grey adjustment knob will be exposed.

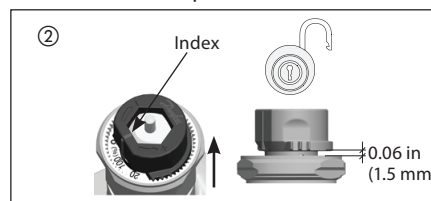

2. Lift the grey adjustment knob above the setting grooves. Located on the adjustment knob is a red line which is the index for the adjustment.

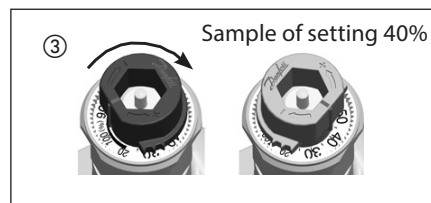

3. Rotate the knob to the required flow percentage. Clockwise to decrease the setting percentage, counter-clockwise to increase the setting percentage.

## Locking

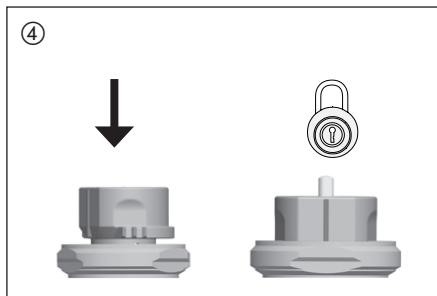

When the flow setting is reached, press down the grey adjustment knob. The teeth on the knob should settle flush into the setting grooves. If the teeth do not fully drop into the grooves, a slight rotation of the knob will be necessary to allow for alignment.

## Minimum Pressure Drop

A minimum differential pressure is required for the internal pressure regulator to operate for the AB-QM valves as seen in the table below.

Valve Size	Minimum ΔP	Maximum ΔP
	psi	
1/2" LF	2.3	60
1/2"		
3/4"		
1"	2.9	
1 1/4"		
1/2" HF		
3/4" HF		
1" HF		
1 1/4" HF		

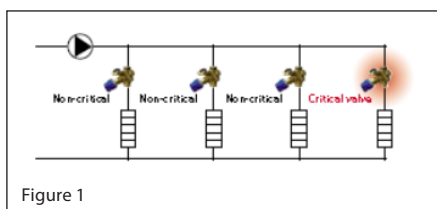

Figure 1

To verify that an installation functions according to the design specifications checking only the most critical valve in the installation is needed. The critical valve is generally the furthest valve away resulting in the lowest available differential pressure (see figure 1). If there is not enough differential pressure the valve will not regulate properly. An adjustment to the optimization of the pump will be required to provide sufficient differential pressure. With the required differential pressure met across the critical valve, the AB-QM valves prior to this valve in the piping will function properly.

In verifying the flow through the coil a differential pressure measurement should be done across the supply and return of the coil

## Orientation

If no electric actuator will be installed, the AB-QM valve can be installed in any direction. When an electric actuator is used, the valve should not be installed upside down. If condensation were to form, it could damage the actuator in this downward orientation. Ensure there is appropriate clearance around the assembly for accessibility.

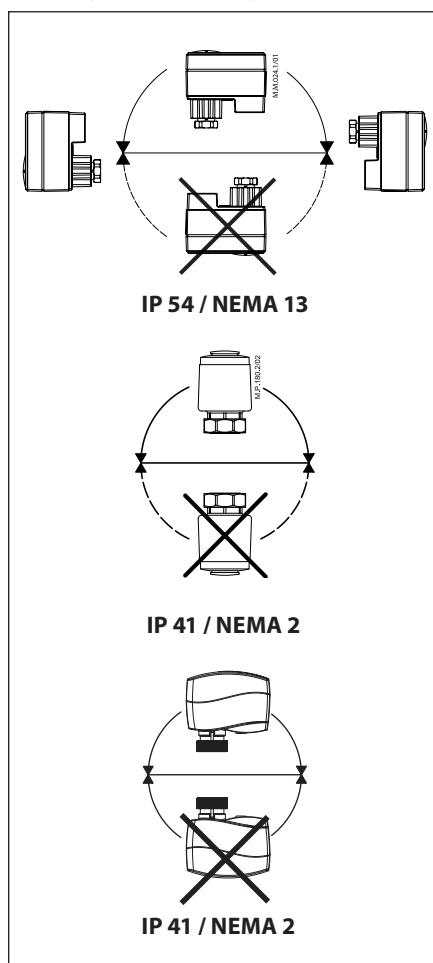

## ACTUATOR INSTALLATION

Factory received actuators are received fully opened. Actuator can be mounted to the valve after flow percentage setting but prior to fill and flush. Refer to installation instructions for proper mounting and wiring of selected actuators for AB-QM valves.

