

## Data Sheet

# eco, Intelligent Radiator Thermostat

## Application



eco is a stand-alone intelligent electronic and programmable radiator thermostat for residential use.

eco is easy to install, in just 30 seconds! Adapters are available for all thermostatic valves manufactured by Danfoss and most other radiator valve manufacturers.

eco is battery powered, compact and very easy to operate with only three buttons.

### Features:

- Energy savings
- Easy to install
- Easy to operate - only three buttons
- Provides high comfort
- Open-window function
- Valve exercise function
- PID control (precise control)
- Adaptive learning
- Weekly programs with adjustable temperature set-backs
- Min./max. temp. range
- Child lock
- Travel Programme
- Frost protection
- Backlit display

## Ordering

Adapters (included)	Instruction - languages	Code no.
Danfoss RA / K (M30 x 1.5)	UK/DK/SE/FI/LT/EE/LV/IS	<b>014G0051</b>
Danfoss RA / K (M30 x 1.5)	UK/DE/FR/PL/NL/NO/CZ/HU/SK/SI/ES/IT	<b>014G0064</b>



## Accessories

Type	Code no.
Adapters for RAV & RAVL valves	<b>014G0250</b>
Adapter for RA valves	<b>014G0251</b>
Adapter for K (M30 x1.5) valves	<b>014G0252</b>
Adapter for RTD valves	<b>014G0253</b>
Adapter for M28 MMA valves	<b>014G0255</b>
Adapter for M28 Herz valves	<b>014G0256</b>
Adapter for M28 Orkli valves	<b>014G0257</b>
Adapter for M28 COMAP valves	<b>014G0258</b>





## Data Sheet

## eco, Electronic Radiator Thermostat

## Specifications

Thermostat type	Programmable electronic radiator valve controller
Recommended use	Residential (pollution degree 2)
Actuator	Electromechanical
Display	Grey digital with backlight
Software classification	A
Control	PID
Power supply	2 x 1.5 V alkaline AA batteries (not included)
Power consumption	3 $\mu$ W in standby 1.2 W when active
Battery life	Up to 2 years
Low battery signal	Battery icon will flash in display. If battery level is critical, the whole display will flash.
Ambient temperature range	0 to 40 °C
Transportation temperature range	-20 to 65 °C
Maximum water temperature	90 °C
Temperature setting range	4 to 28 °C
Measurement interval	Measures temperature every minute
Clock accuracy	+/- 10 min/year
Spindle movement	Linear, up to 4.5 mm, max. 2 mm on valve (1 mm/s)
Noise level	<30 dBA
Safety classification	Type 1
Open-window function	Activated at temperature decrease of approx. 0.5 °C over 3 minutes
Weight (incl. batteries)	177 g (with RA adapter)
IP class	20 (not to be used in hazardous installations or in places where it will be exposed to water)
Approvals, markings etc.	  

Pre-installed  
Programmes

	Programme without automatic temperature reduction. This programme maintains the comfort temperature of 21 degrees constant all day and night.
	Saving programme which as default lowers the temperature to 17 °C at night (22:30 - 06:00 hrs). Time and temperature are configurable.
	Extended saving programme which as default lowers the temperature to 17 °C at night (22:30 - 06:00 hrs), and during the day on weekdays (08:00 - 16:00 hrs). Time and temperature are configurable.
	Travel programme which lowers the temperature when you are away. Time and temperature are configurable.
	Frost protection programme. The thermostat will maintain a constant temperature of 4-10 °C in the room, ensuring frost protection.

## Data Sheet

## eco, Electronic Radiator Thermostat

**Measuring the room temperature**

eco is measuring the temperature with two built-in sensors - one behind the display and one near the valve.

Based on both readings the room temperature is calculated for an area approx. 20 cm in front of the display. This allows eco to control the actual room temperature very accurately.

Be aware that sources of cold or heat, e.g. fire-place, direct sun or draft, might affect the function of eco.

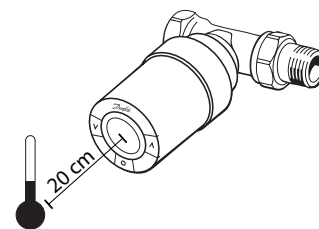

*Note! The displayed temperature is always the set temperature, not the actual room temperature.*

**Main features****Open-window function**

eco features an Open-window function, which closes the valve if the room temperature is falling dramatically, thus reducing the heat loss. The heat is turned off for up to 30 minutes, before eco returns to its original settings.

When Open-window has been activated, the function is quarantined for 45 minutes.

**Adjusting to the valve**

During the first night of operation eco will shut off the radiator heat and then open again to detect the exact opening point of the valve. This will allow eco to control the heat as efficiently as possible. If necessary, the procedure is repeated once a night for up to a week.

You might experience the valve being warm during the adjustment procedure, regardless of the room temperature.

**Child lock**

Activating the child lock feature will protect the settings from tampering.

**Intelligent Control (Forecast)**

During the first week of operation eco learns when it is necessary to start heating the room in order to reach the correct temperature at the correct time.

The intelligent control will continuously adjust the heating time compared to seasonal temperature changes.

**Automatic valve exercising**

To keep the radiator valve functional and at its best, eco automatically exercises the valve every Thursday at approx. 11:00 hrs by opening it fully and then return to normal setting.

**Daylight saving time**

As default eco will automatically shift between daylight saving time and normal time. If necessary, the daylight saving time function can be disabled.

**Installation**

 must be flashing on the display before installation.

1. Start by mounting the appropriate adapter.
2. Tighten RA adapter using the 2 mm Allen key. Hand-tighten K adapter.
3. Screw the thermostat onto the adapter and tighten by hand (max. 5 Nm).
4. Press  for 4 seconds to deactivate the mounting mode. (An adapter guide is included to identify the correct adapter to mount.)

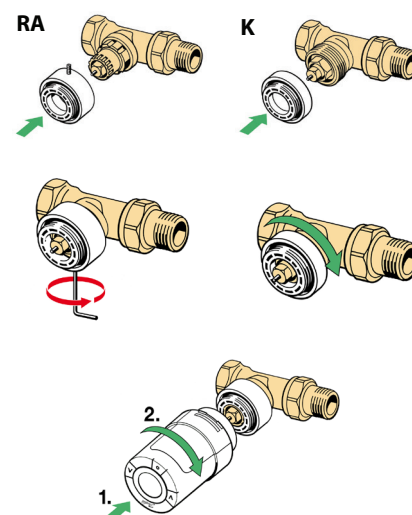

## Dimensions

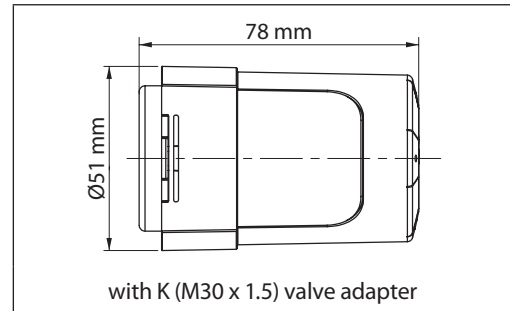
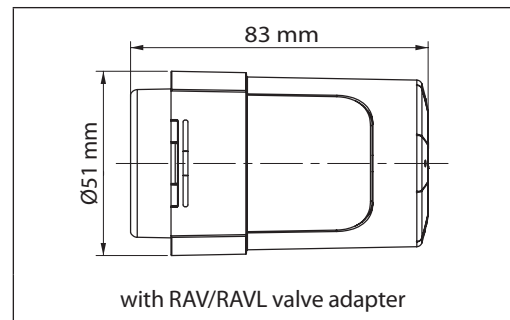
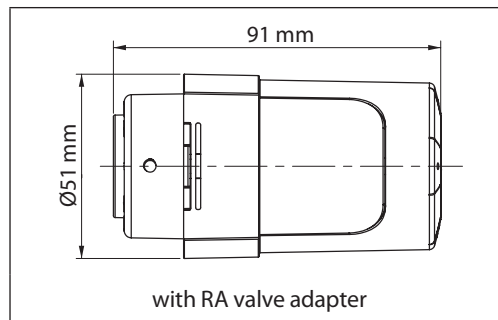
**Danfoss A/S**

Heating Solutions

Haarupvaenget 11

8600 Silkeborg

Denmark

Phone: +45 7488 8000

Fax: +45 7488 8100

Email: [heating.solutions@danfoss.com](mailto:heating.solutions@danfoss.com)[www.heating.danfoss.com](http://www.heating.danfoss.com)