

Installation guide

Sight glass

Type SGP X, SGP I, SGP N, SGP RX, SGP RI, SGP RN, SGR, SGI, SGRI, SGN, SGRN

014R9572

014R9572

Refrigerant: SGP (I indicator): R290, R600, R600a, R22
 SGP (N indicator): R410A, R404A, R507, R134a, R407C, R32, R22, R1270, R744, R407A, R407F, R448A, R449A, R450A, R452A, R513A, R454B, R1234ze

SG (I indicator): R22
 SG (N indicator): R22, R134a, R404A, R407C, R507, R407A, R407F, R448A, R449A, R450A, R452A, R513A

For complete list of approved refrigerants, go to <http://products.danfoss.com/all-products/>
 For the application use with R744 as part of a secondary loop or cascade system should refer to the datasheet for more attentions.

Media temperature: T_{min.}: -50 °C / -58 °F
 T_{max.}: +80 °C / +175 °F

Max. working Pressure PS / MWP: SGP: 52 bar / 754 psig
 SG: 35 bar / 508 psig

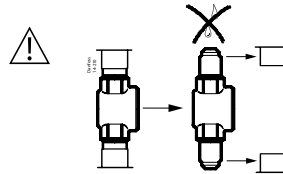
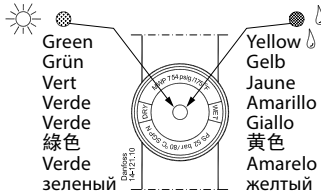

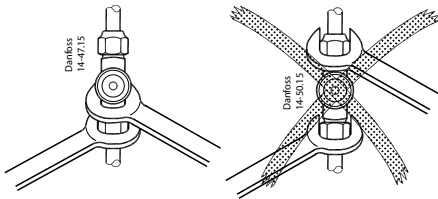
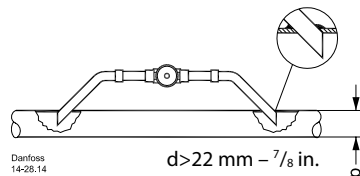
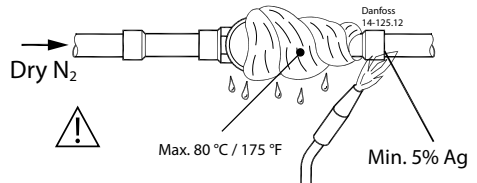

Type	W		W	
	mm	in.	mm	in.
SGP/SG flare 6	14	9/16	16	5/8
SGP/SG flare 10	19	3/4	22	7/8
SGP/SG flare 12	22	7/8	24	15/16
SGP/SG flare 16	27	1 1/16	27	1 1/16
SGP/SG flare 19	32	1 1/4	32	1 1/4

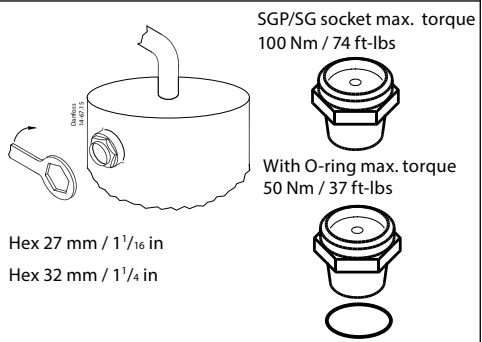

Max. torque		
Size	Nm	ft-lbs
1/4 in / 6 mm	20	15
3/8 in / 10 mm	30	22
1/2 in / 12 mm	60	44
5/8 in / 16 mm	100	74
3/4 in / 19 mm	200	148



Sight glass type SGP X, SGP I, SGP N, SGP RX, SGP RI, SGP RN, SGR, SGI, SGRI, SGN, SGRN

<p></p> <p>Only SGP solder version are allowed for flammable refrigerants</p> <p>All Danfoss products fulfill the requirements in REACH. One of the obligations in REACH is to inform customers about presence of Candidate list substances if any, we hereby inform you about one substance on the candidate list:</p> <p>A moisture indicator in a sight glass contains a paper which is impregnated with Cobalt Dichloride (CAS no: 7646-79-9) in a concentration above 0.1% w/w. If the valve has been damaged or dismantled:</p> <ul style="list-style-type: none"> - Avoid skin contact with the paper - Do not inhale the dust from the paper - The paper must be disposed as hazardous waste 	<p></p> <p>仅SGP焊接版本适用于易燃制冷剂</p> <p>所有丹佛斯产品都符合REACH的要求。REACH中的义务之一是通知客户关于候选清单上物质的存在，因此我们特此通知您关于在候选名单上的一个物质：</p> <p>视液镜中的湿度指示器含有浸着二氯化钴的试纸 (CAS 号：7646-79-9)，其浓度质量比大于0.1%。如果阀被损坏或拆卸时：</p> <ul style="list-style-type: none"> - 避免皮肤与试纸接触 - 不要吸入试纸上的粉尘 - 试纸必须作为危险废物处置