

Installation guide

Solenoid valve

Types EVUL 1 - EVUL 8, EVU 1 - EVU 8, EVUB, and EVUF

032R9551

032R9551

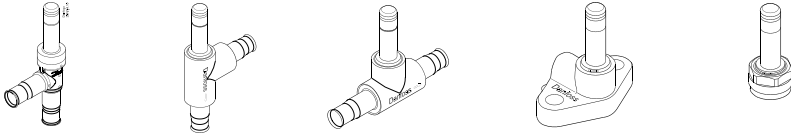

Refrigerants

R744, R22/R407C, R404A/R507, R410A, R134a, R407A, R23, R290 (only EVUL), R407F, R448A, R449A, R450A, and R452A.

For complete list of approved refrigerants, visit www.products.danfoss.com and search for individual code numbers, where refrigerants are listed as part of technical data.

⚠ Special note only for EVUL and R290:

Only EVUL is approved for R290 and is validated in accordance to ATEX, ISO 5149, IEC 60335, and UL. Ignition risk is evaluated in accordance to ISO 5149, and IEC 60335.

Max. working pressure

EVUL 1 - EVUL 8: 90 bar / 1305 psig
 EVU 1 - EVU 8: 70 bar / 1015 psig
 EVUB and EVUF: 45.2 bar / 655 psig

Max. opening diff. pressure (MOPD):

Coil dependent

Ambient temperature:

-40 °C / -40 °F – 50 °C / 122 °F

Media temperature:

-40 °C / -40 °F – 105 °C / 221 °F

Mounting

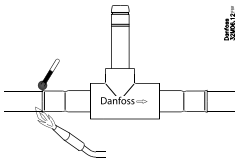

Valve connection:
 Max. 700 °C / 1300 °F

Copper tube: 10 - 15 sec

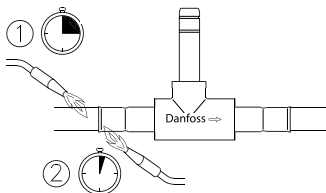

Valve connection: 2 - 5 sec

⚠ Special note for EVU:

Danfoss recommends that a suitable filter or filter drier (max. size of 40 - 50 µm) is installed ahead of each EVU valve to keep scale, solder material and other foreign dirt and particles out of the valve.

Mounting angle

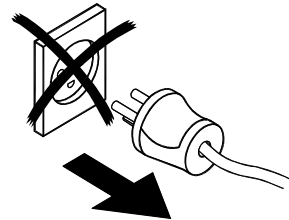
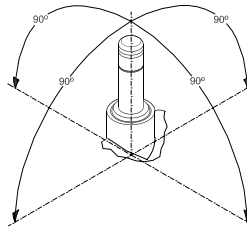

⚠ Always disconnect power from the coil when dismantled from the valve. The coil may be damaged and there is risk of injuries and burns.

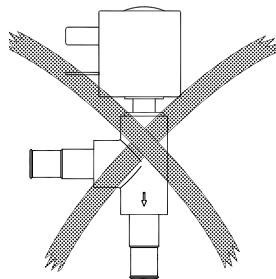
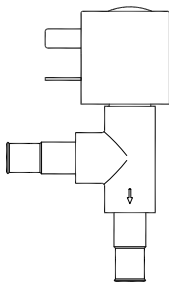
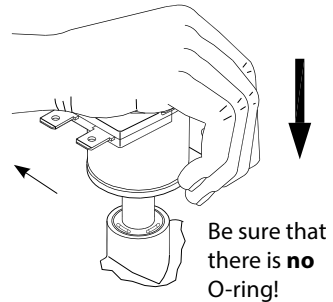
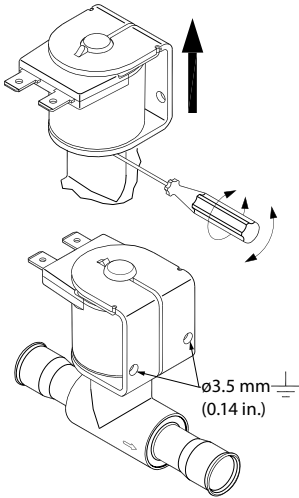
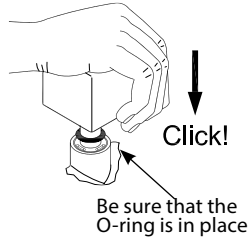
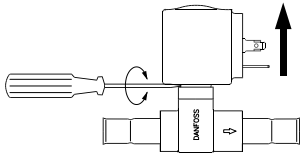

To ensure correct sealing between coil and valve make sure that the coil is fully clicked on to the valve.

- ⚠** Only EVUL can be applied on systems with R290 as the working fluid. For countries where safety standards are not an indispensable part of the safety system Danfoss recommends the installer gets a third party approval of any system containing flammable refrigerant. **Note:** Please follow specific selection criteria stated in the datasheet for this particular refrigerants.