

Operating Guide

# NovoCon® S - High Accuracy Actuator

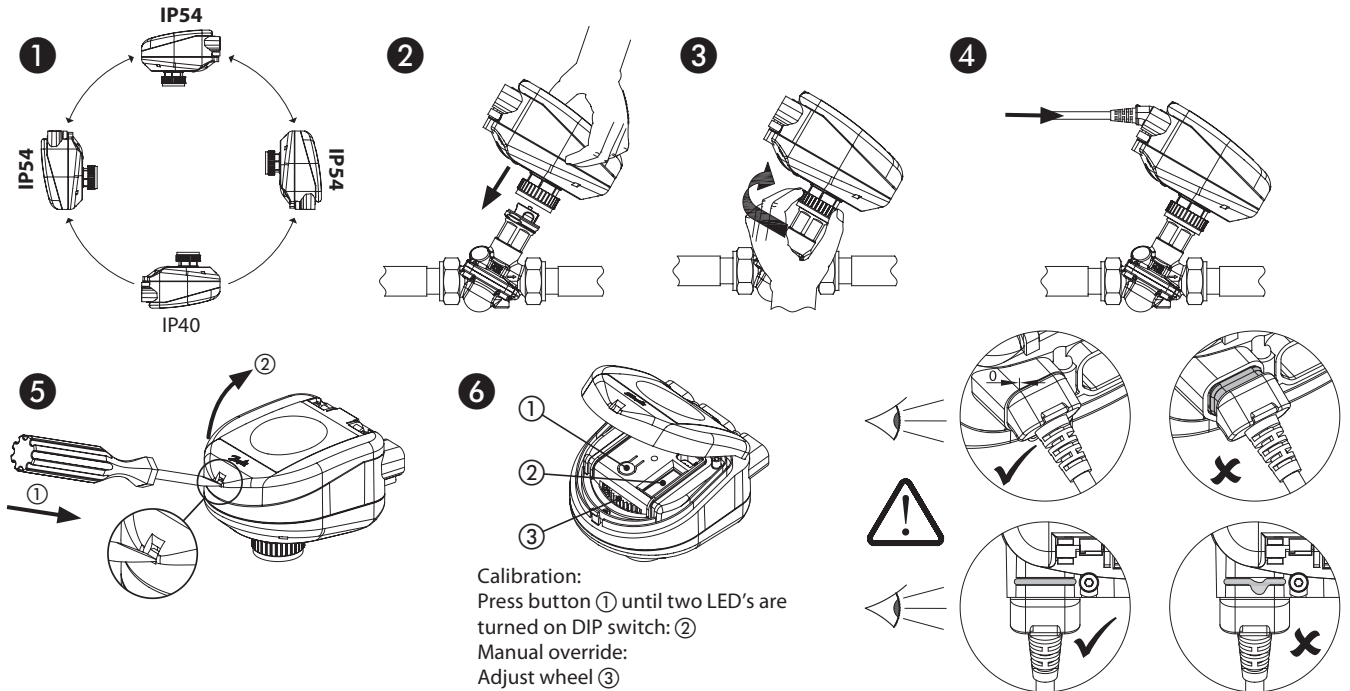

**7**

Common ground shall be used for all devices on the same network.

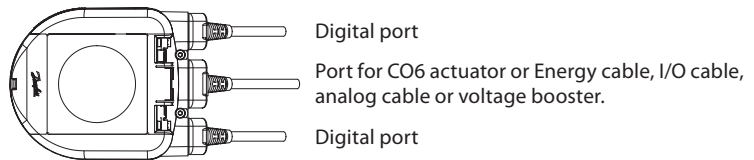

**NovoCon® digital cable**

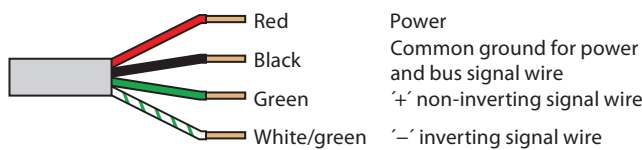

**NovoCon® analog cable**

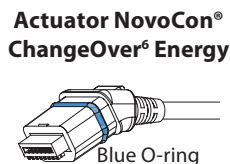
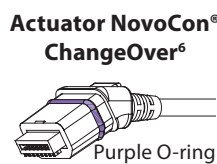
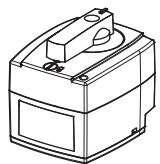

**Actuator NovoCon® ChangeOver® Flexible**



**NovoCon® Energy cable**

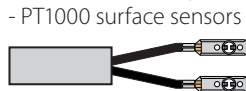

**NovoCon® Energy cable**



**NovoCon® I/O cable**

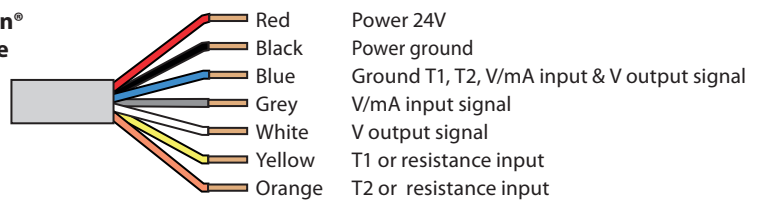

**Cable NovoCon® Temperature I/O**

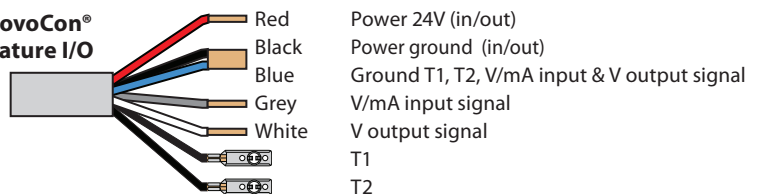

**NovoCon® S - High Accuracy Actuator**

8



Serial number and QR code can be removed from the NovoCon® S label and added to installation drawing.



Device Object Instance Number

9

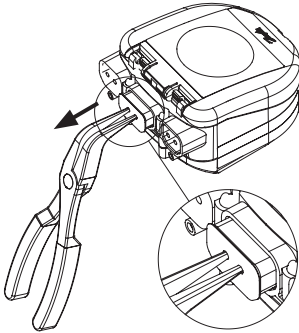

10

**DIP Switch**

1	2	3	4	5	6	7	8	9	10
							ON		
							OFF		

DIP Switches 1 to 7 are used to assign the MAC address manually. Default MAC address assignment method is Auto MAC addressing for BACnet MS/TP and DIP Switches for Modbus RTU. For termination of last unit on the field bus, turn DIP Switch 8 ON. Dip switch 9 is not used. Dip switch 10 is used to select between BACnet MS/TP (OFF=Default) and Modbus RTU (ON). When the protocol is changed on DIP Switch 10, a power cycle is required.

11

**Presettings**

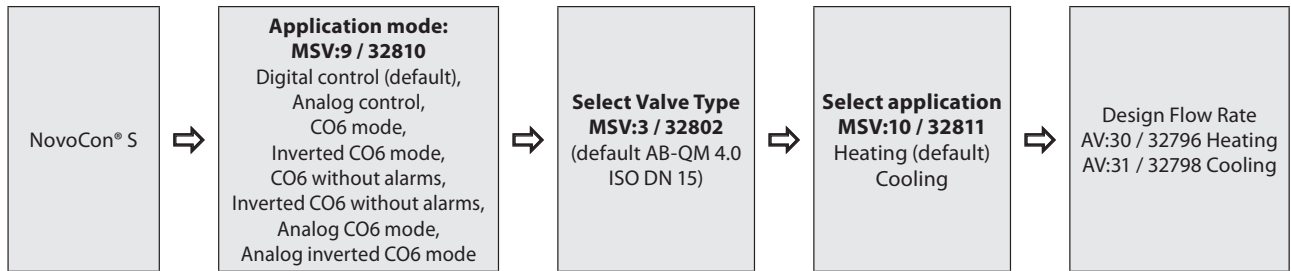

12

**Safety Note**

To avoid injury and damage to persons and devices, it is absolutely necessary these instructions are carefully read and observed prior to assembly and commissioning. Necessary assembly, start-up, and maintenance work must be performed only by qualified, trained and authorised personnel. Switch off the power line before wiring the actuator.

**Safety Note**

If the NovoCon® S network is supplied with two or more AC power boosters, caution must be observed when disconnecting one of the transformers from the high voltage power line. As the NovoCons are connected in a daisy chain, there may be high voltage on the primary side of the disconnected power supply. Disconnect always both the primary and secondary side of the transformer.

**Safety Note**

Connect via safety isolating transformer. Galvanic separations shall be provided for segments crossing buildings.

**Disposal instruction**

This product should be dismantled and its components sorted if possible, in various groups before recycling or disposal. Always follow the local disposal regulations.

Part Name 部件名称	Hazardous Substances Table/有害物质含量表					
	Pb/铅	Hg/汞	Cd/镉	Cr(VI)/ 六价铬	PBB/ 多溴联苯	PBDE/ 多溴二苯醚
Union nut/ 连接螺母	X	O	O	O	O	O

O: Indicates that this hazardous substance contained in all of the homogeneous material for this part is below the limit requirement in GB/T 26572;  
O: 表示该有害物质在该部件所有均质材料中的含量均在GB/T 26572规定的限量要求以下。

X: Indicates that this hazardous substance contained in at least one of the homogeneous material for this part is above the limit requirement in GB/T 26572;  
X: 表示该有害物质至少在该部件的某一均质材料中的含量超出GB/T 26572规定的限量要求。

Danfoss can accept no responsibility for possible errors in catalogues, brochures and other printed material. Danfoss reserves the right to alter its products without notice. This also applies to products already on order provided that such alterations can be made without subsequent changes being necessary in specifications already agreed. All trademarks in this material are property of the respective companies. Danfoss and the Danfoss logotype are trademarks of Danfoss A/S. All rights reserved.