

Facts worth knowing about Oil nozzles



Facts worth knowing about Danfoss oil nozzles

Contents



	Page
Oil nozzles and the complete oil-burning plant	3
What is there to know about oil nozzles?	4
What has a Danfoss oil nozzle to offer?	5
How is a Danfoss oil nozzle built up?	6
How does a Danfoss oil nozzle work?	7
What must be done to the oil to make it burn?	8
But how does the combustion itself take place?	9
What does clean economic combustion mean?	10
What effect has atomizing pressure?	11
What effect has oil quality and temperature?	12
What effect has air supply on the oil burner?	13
Where must the oil nozzle be located?	15
For how long can an oil nozzle be used?	16
How should an oil nozzle be handled?	17
Can an oil nozzle be cleaned?	18
What do the numbers and letters on the nozzle mean?	19
How is the correct oil nozzle chosen?	20
Is it possible to compare oil nozzles of different makes	21
What causes an oil nozzle to drip?	22
What makes the flame lopsided?	23
What is the cause of no oil from the nozzle?	24
What causes oil coke on the nozzle and ignition electrodes?	25
Why "shooting start" in the flame?	26
What produces a greasy malodorous deposit in the boiler and how can it be removed?	27
Why does soot form in the flame?	28
What causes the oil to ignite with a bang?	29
What can be wrong if there is no flame?	30
What causes leakage between oil nozzle and nozzle fixture?	31
Can the nozzle be the reason for the flue-gas temperature being too high?	32
Can the nozzle cause too low a flue-gas temperature?	33
What makes the flame too long?	34
What causes oil and coke to collect around nozzle and combustion head?	35
Why does nozzle output suddenly begin to vary?	36
What to do with old, worn out nozzles?	37
Nozzle capacities	39

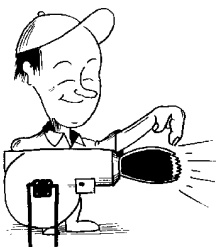

Oil nozzles and the complete oil-burning plant

A complete oil-burning plant begins at the oil tank filling connection and ends at the chimney pipe.

Every one of the many parts which go to make up the plant must function so that the plant is CLEAN, STABLE and ECONOMIC.

Hidden from view at the heart of the plant is a small interesting gadget which looks more like a very nicely done pipe plug than anything else – this is the oil nozzle.

The oil nozzle plays a vital role in combustion and it is quite impossible to get CLEAN, STABLE and ECONOMIC plant operation if it is not handled correctly.

A technician in the oil burner field will, naturally – or to put it more strongly – necessarily, know about the function of the oil nozzle and of its significance in the combustion sequence.

Fortunately, to learn about oil nozzles it is not necessary to read for a science degree. Instead, more convenient means are to hand – a moment or two, somewhere to relax, and this book.

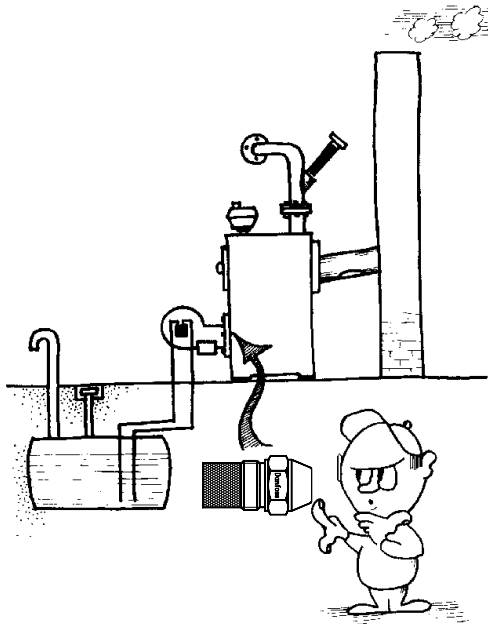

What is there to know about oil nozzles?

In general, the answer to this question is, "A great deal!" However, what is "necessary" knowledge depends on whether it is the manufacture of oil nozzles or their use is concerned.

To make good oil nozzles, a very comprehensive knowledge of the following is necessary:

- Characteristics of fuel oil and combustion.
- The nature of atomizing and spray patterns.
- Oil-burning plant design.
- Precision machine work.

On top of all this, a manufacturer must have a department where necessary and very critical inspection and testing of the finished nozzles takes place. Nozzles play an important part in the everyday work of oilburner technicians. That is why it is important for them to follow manufacturers-instructions. In this way they will exploit to the full all the knowledge and experience the manufacturer is passing on through those instructions to gain clean, stable and economic combustion.

Even today, there are a great many plants running with poor combustion because of incomplete knowledge of oil nozzles. Such a lack of knowledge can have other unfortunate consequences; attempts are sometimes made to cure faults by changing the nozzle when in reality the faults have nothing to do with the nozzle.

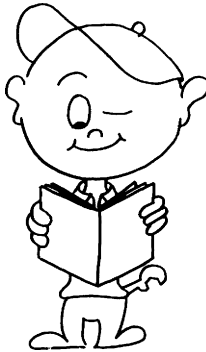

What has a Danfoss oil nozzle to offer?

Danfoss oil nozzle are known for their high level of quality.

Precision manufacture of individual parts and fine accuracy form the basis of Danfoss oil nozzles offer:

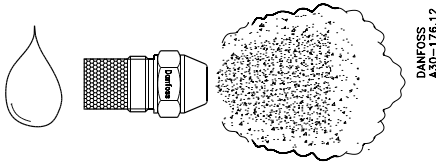

– Perfect atomizing of the oil.

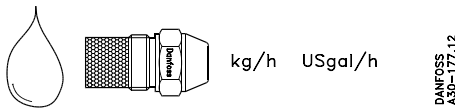

– Marking in accordance with CEN norm (at 10 bar) and Gal/h (at 7 bar).

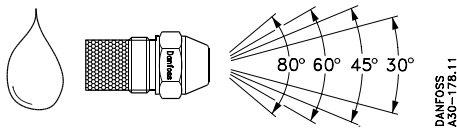

– Four different spray angles.

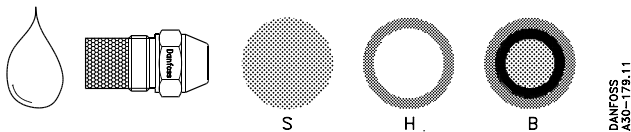

– Three different spray patterns.

Danfoss oil nozzles also offer high uniformity and two nozzles with the same marking will be identical. This makes life easy when replacing and old nozzle by a new one.

How is a Danfoss oil nozzle built up?

A Danfoss oil nozzle is a bit more than just a lump of metal with a little hole through it.

To be able to meet the requirements of effective atomizing, accurate dosing, and a constant spray pattern and angle, the nozzle is built up of several small fine-machined parts.

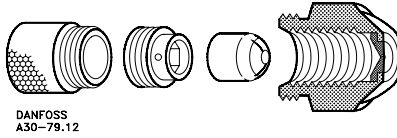

Danfoss oil nozzles are fitted with the following types of filter:

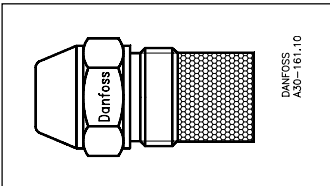

A. Capacity range:
0.40 - 0.45 USgal/h
45 µm sintered bronze filter

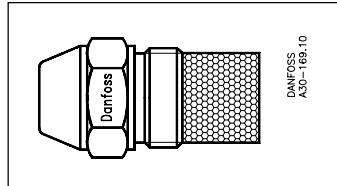

B. Capacity range:
0.50 - 1.00 USgal/h

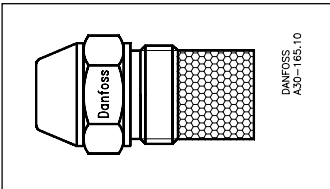

C. Capacity range:
1.10 - 1.35 USgal/h
120 µm sintered bronze filter

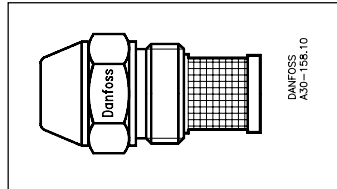

D. Capacity range:
1.50 - 11.0 USgal/h
140 µm monel mesh filter

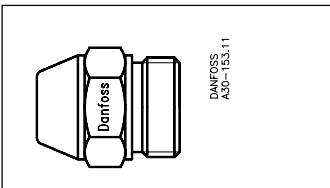

E. Capacity range:
12.0 USgal/h and over without filter

How does a Danfoss oil nozzle work?

To find the answer to this question it is necessary first to take a close look at how the oil travels through the small slots in the nozzle.

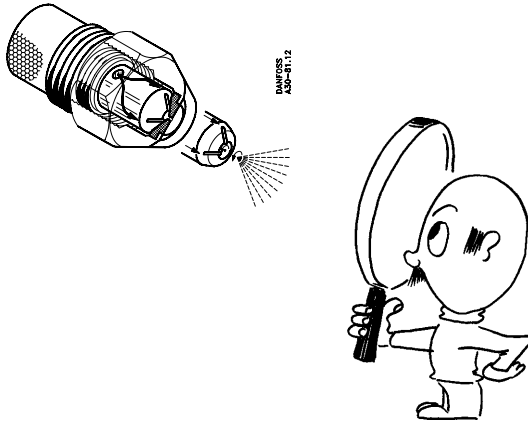

Oil enters through the filter and continues through the bottom screw and its side holes. From there, the oil runs along the side of the cone and into the cone slots.

When the oil, under high pressure, is forced through the cone slots it enters the swirl chamber. On its way through the cone slots some of the oil pressure is converted into rotational energy.

In the swirl chamber, the oil gains strong rotary motion and a rotating oil film is formed which moves towards the nozzle orifice.

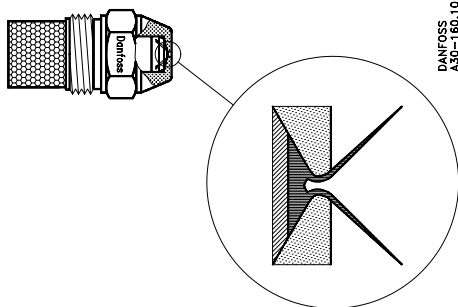

The velocity of the oil film is so great that a “tube” of oil is formed in the nozzle orifice. With the help of that part of the pressure not converted into rotational energy this “oil tube” is forced through the nozzle orifice. On being propelled from the orifice, the “oil tube” is expanded so much that it breaks up into very small oil drops.

What must be done to the oil to make it burn

Even though oil is rightly regarded as inflammable, it cannot burn in its liquid state, it must first be transformed into vapour.

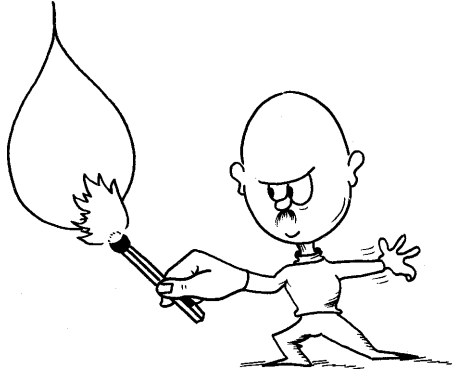

Since oil can only vapourize from its surface, it is necessary to create as large an oil surface area as possible. If the oil is transformed into vapour quickly the chances of clean and effective combustion are increased. If the oil in liquid form is forced through a nozzle with a suitable pressure it will burst into an astronomical number of small drops which, on becoming mixed with the air from the combustion head, will form an oil mist of uniform consistency. The total surface area of all these droplets is very large and it is this area the oil vaporizes from. It is in this way the oil is prepared for combustion, by first atomizing it through an oil nozzle. To better understand this process an example can be given: The amount of oil sent through a Danfoss 0.50 USgal/h oil nozzle in one hour is transformed into about 40,000,000,000 microscopic drops of oil which provide the very extensive evaporating surface needed for clean and effective combustion – the kind of performance demanding a nozzle of high quality and much attention to the way the nozzle is handled.

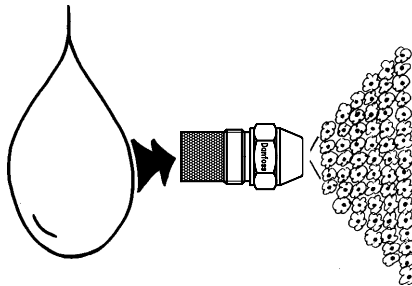

But how does the combustion itself take place?

The main ingredients of oil are: carbon and hydrogen

Air contains: oxygen and nitrogen

When oil vapour mixes with the oxygen in the air, in the right proportions, the mixture will burn on ignition and generate heat. At first sight, there would seem to be few big problems involved in burning a little oil, but there is more to it than that. The need is for stability, cleanliness and economy; in other words, the oil must be burned with as little excess air as possible without producing soot. To get oil to burn like this assumes, among other things, a correct choice of oil nozzle and attention to the way the nozzle is handled.

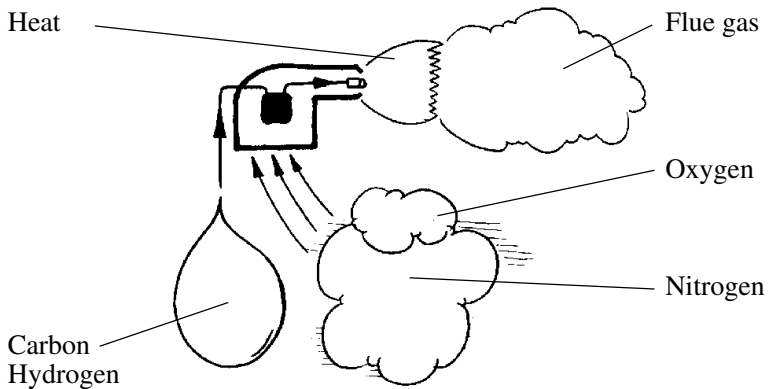

What does clean economic combustion mean?

When talking about oil burners, clean combustion means soot-free combustion. Soot in a boiler can obstruct heat transfer and results in less economic operation. Soot outside the boiler ruins the surroundings and brings oil heating into discredit.

Economic combustion means soot-free combustion with the least possible amount of excess air. If more air is present in the chamber than is necessary for combustion, the excess will merely be blown up the chimney taking with it a lot of valuable heat – a very uneconomic process. All this indicates how important it is for the oil burner to be adjusted correctly so that clean and economic combustion is obtained. The next few pages deal with the factors that affect combustion.

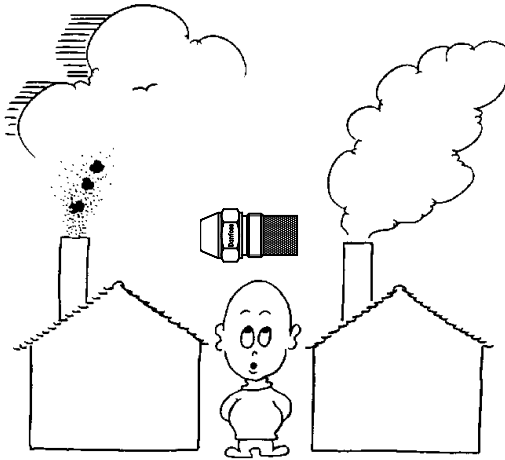

What effect has atomizing pressure?

Atomizing pressure is the pressure the oil has when it enters the nozzle. At Danfoss, the characteristics of the nozzle, i.e. how much oil it yields per hour, the size of the oil droplets, the spray angle and pattern of distribution are all established and checked with an oil pressure of 7 bar (100 psi).

If the oil pressure is altered the characteristics of the nozzle also alter, therefore it is quite wrong to judge the performance of a nozzle without first checking the oil pressure with a reliable gauge.

At an oil pressure of more than 7 bar the most noticeable thing is that the nozzle yields more than the amount which is stamped on it.

Oil consumption is thus dependent on atomizing pressure, as shown in the diagram below.

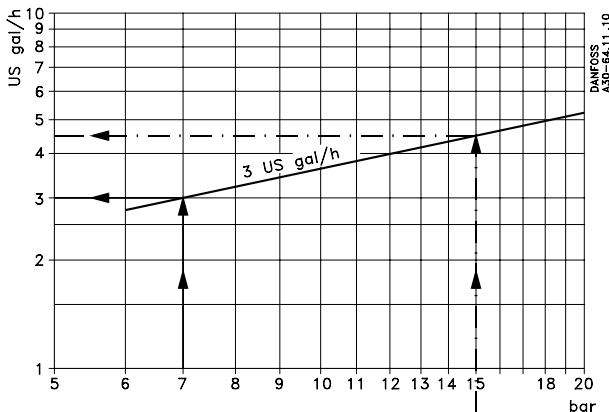

The diagram shows how much oil is discharged from a nozzle marked 3 USgal/h at different atomizing pressures. Worth noticing is the bold line. It starts at the horizontal scale (7 bar) and intersects the inclined line (3 USgal/h line) at 3 USgal/h, illustrating that a 2 USgal/h nozzle does yield precisely that figure when atomizing pressure is 7 bar.

This corresponds well with the paragraphs above regarding the value stamped on each Danfoss oil nozzle – it is a fixed and checked figure exactly right at an atomizing pressure of 7 bar.

An example given by the dotted line shows that a 3 USgal/h oil nozzle at an atomizing pressure of 15 bar gives approx. 4.5 USgal oil per hour. Danfoss nozzle diagrams are made up as the diagram shown and are used in the same way.

What effect has oil quality and temperature?

The characteristics of the oil nozzle are factory-checked with a standard fuel oil having closely fixed flow properties (viscosity) measured at 20°C. Viscosity is given in the oil nozzle leaflets.

When oil is cooled down it becomes thicker – its viscosity rises. If it is warmed up, oil becomes thinner and its viscosity drops.

The fuel oil normally supplied for oil burners has a viscosity which scarcely alters for temperature changes between 0°C and 30°C. Combustion will therefore not alter significantly as long as oil temperature is held between these figures.

On plant where the oil tank may be exposed to temperatures lower than 0°C certain problems can occur. An outdoor tank for example can easily become quite cold so that the oil in it thickens enough to change the atomizing pattern of the nozzle.

A change such as this will result partly in the oil droplets becoming bigger so making the flame longer and more "sluggish" in burning, and partly in an increase in nozzle output which will usually mean that combustion becomes sooty.

For these reasons, oil tanks which are outside and above ground, and all the exposed pipes, ought to be insulated to avoid problems in wintertime.

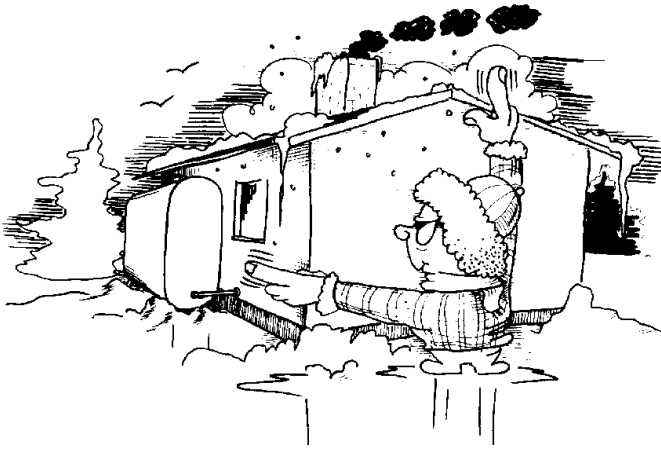

Note!

Any water in an exposed oil tank (condensation perhaps) is an extra hazard. When temperatures drop to around freezing point the water will turn into ice and may block the oil pipe.

What effect has air supply on the oil burner?

Even the best-atomized oil will not produce correct combustion if there are problems with the air supply to the burner.

What problems can occur with the air supply? Assuming the right choice of nozzle for a particular burner has been made, and that the nozzle is fitted and used in the way prescribed in the instruction book, air supply problems can occur because:

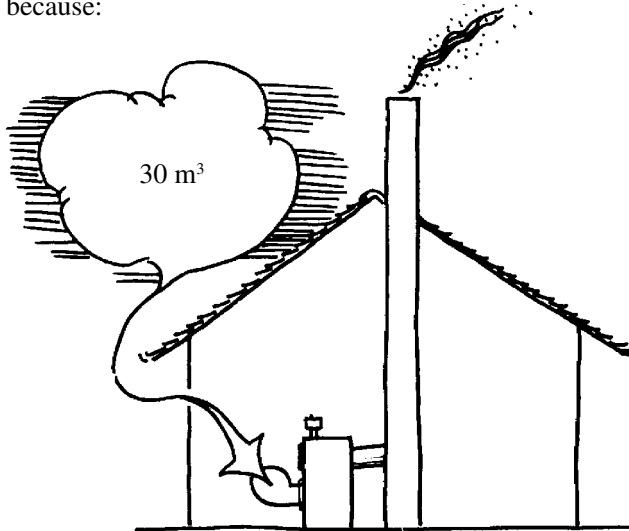

There is a lack of ventilation in the boiler room, i.e. sufficient air is unable to enter the boiler room and the burner fan cannot "breathe". A normal domestic oil-heating plant **MUST** receive approximately 30 m³ air per hour. If the fan is prevented from receiving this amount of air, combustion will rise to soot formation.

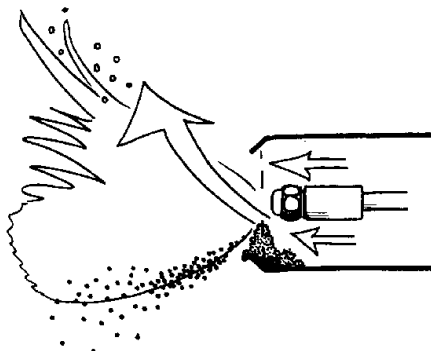

Some of the particles mentioned above continue through the system and lodge in the burner tube causing a poor and uneven oil/air mixture, finally resulting in the flame being lopsided and sooty.

The oil burner fan works something like a vacuum cleaner. This means that air sucked in carries dust particles, hairs from the dog, etc., etc. Gradually, the fan inlet becomes partly blocked, the amount of air received gets smaller and smaller, and the flame again produces more and more soot.

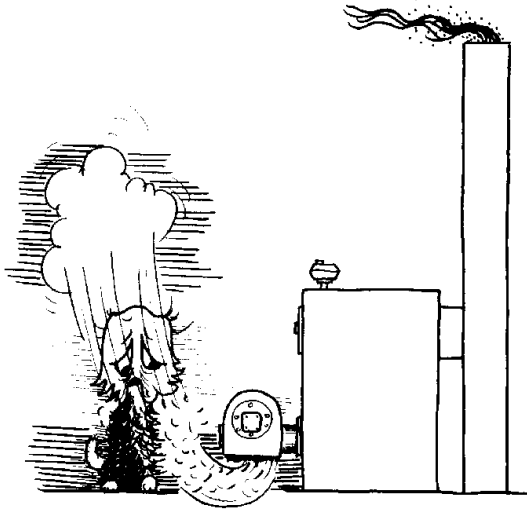

An unstable draught can also have an unfortunate effect on the air supply.

Put simply: it is most annoying to have otherwise good combustion ruined just because the air supply for it is not correct.

Where must the oil nozzle be located?

Oil burner manufacturers have made many experiments to find exactly that position in their burners where the nozzle will produce the best combustion results. Therefore, the nozzle must always be located precisely as stated in the oil burner instruction book.

If it is necessary to replace the nozzle fixture the new one must be fitted exactly as before in relation to the combustion head in order not to change the flame pattern.

A nozzle placed too far forward causes too great an air velocity around the nozzle and ignition often becomes more like an explosion. If a flame is formed at all it will be very erratic and dispersed.

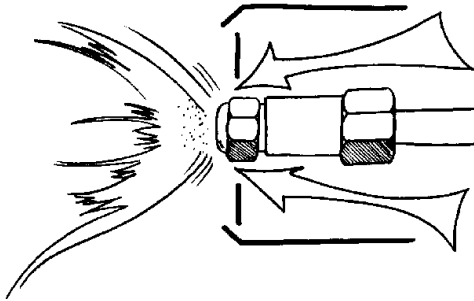

Oil sprayed from a nozzle placed too far back will be caught by the combustion head and may result in oil flooding from the burner tube. Here, it must be pointed out that the higher the fan pressure the plant works with the more accurate must the oil nozzle be located in relation to the burner tube, ignition electrode and combustion head. These remarks principally concern plants which run at 2800 rev/min.

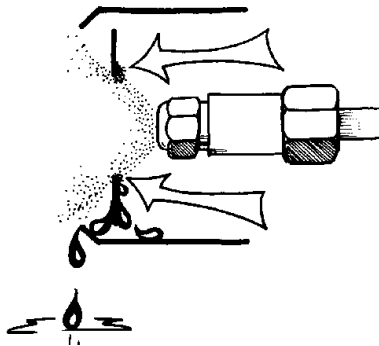

For how long can an oil nozzle be used?

An oil nozzle can be used for as long as a reasonable carbon dioxide percentage ($\text{CO}_2\%$) and a passably low soot count can be maintained. How long the period can be is hard to estimate since wear on the nozzle depends very much on how many hours the plant is run and how clean the oil is which passes through the nozzle.

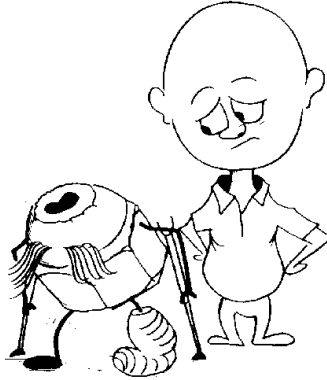

The question is often asked, "Can an oil nozzle become worn?". The answer of course is, "Yes it can". To better explain this over-simplification it is necessary to look at the volume of oil handled by the nozzle.

A 0.50 USgal/h nozzle in a normal domestic plant using 1300 USgal per year will, during that time, operate for approximately 2650 hours.

Expressing this in a more picturesque way: if the oil coming from the nozzle were to be a long uninterrupted jet it would leave the nozzle at a velocity of 45 m.p.h. To make this picture even more graphic: such an uninterrupted jet would be about 120,000 miles long – 4 1/2 times round the world at the equator.

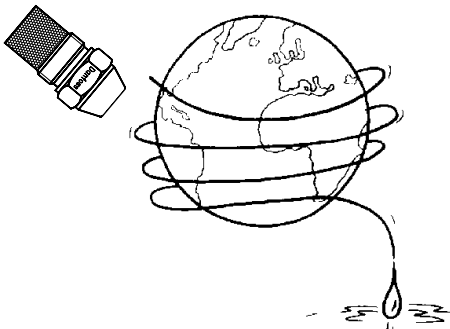

It is easy to see that the absence of a nozzle filter or perhaps a pump filter, the presence of dirt, this or that part defective, will considerably shorten the life of the oil nozzle. Another danger: Heat radiation from brightly glowing firebricks or other linings will cause oil coke build-up on the tip of the nozzle and so reduce nozzle life.

How should an oil nozzle be handled?

The short answer to this question is that an oil nozzle should be treated like the good friend it is – protectively and considerately.

To ensure that after it is installed a brand-new nozzle retains all the good characteristics designed into it, it must be stored and transported with care.

Storing:

Always leave the nozzle in its protective covering until the last minute before installation.

Never fit a brand-new nozzle in an oil burner due to be put in store.

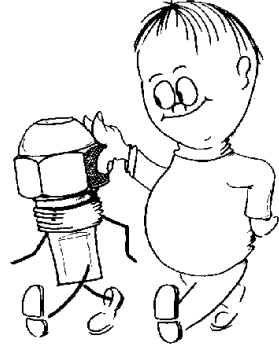

Handling in transit:

Always use the Danfoss nozzle case for transport; the nozzle will be well-protected in this way.

Never install a nozzle which is ice-cold.

Wait until it becomes “acclimatized”.

Do not touch the tip of the nozzle, especially with dirty fingers – the orifice is easily blocked. To pick up the nozzle, the spanner flats are easy to grip.

Never carry an unprotected nozzle in a pocket or in a toolcase.

Never use excessive force when fitting the nozzle. If too much force is used the sealing surfaces between nozzle and fixture may be damaged.

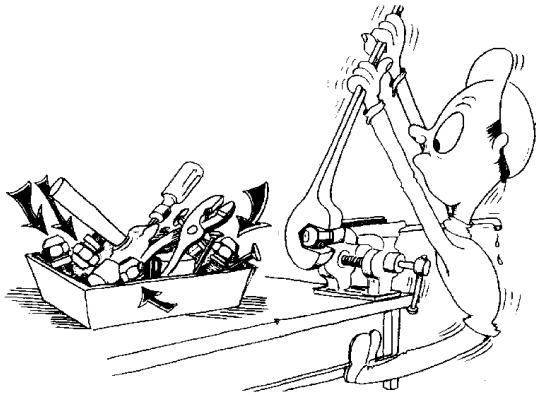

Can an oil nozzle be cleaned?

Preferably, nozzles should always be changed rather than cleaned to ensure maximum performance.

Deposits or particles which sit firmly around the nozzle orifice cannot be scraped off without inevitable damage to the nozzle resulting in a distorted spray angle and atomizing pattern. The same thing happens if the nozzle is taken apart and attempts are made to scrape out the cone slots.

With nozzles of small capacity, without the aid of a microscope, it is practically impossible to see whether the cone slots are thoroughly clean. In these circumstances, the cost of replacing a nozzle is far less than a possible further service entailing a nozzle change in any case. Keep nozzles in their original containers and in a nozzle box to keep them clean and to prevent damage.

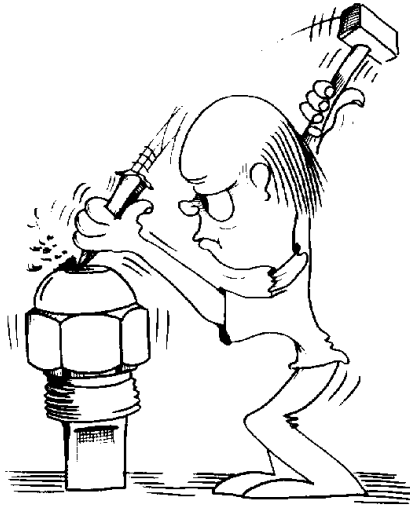

What do the numbers and letters on the nozzle mean?

It is wise to become really familiar with the numbers and letters which are stamped on each nozzle so that the correct one can be chosen.

New CEN definition point

Test oil: Viscosity 3,4 mm²/s
density: 840 kg/m³
Atomizing pressure: 1000 kPa ($\times 10^{-2}$ bar)

Existing oil nozzles must be tested under the above new test conditions. This of course produces new data on capacity, pattern and angle.

Example of new marking:
CEN marking + existing marking

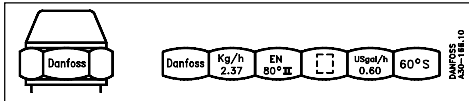

The nozzles will in future carry the two different markings:

The new CEN marking which gives information under the CEN definition point, marked **EN (European-standard)**.

The existing marking gives: information on *the existing* capacity in USgal/h, spray angle and spray pattern.

The new CEN marking gives: *Nozzle capacity* in kg/h at an atomizing pressure of 1000 kPa ($\times 10^{-2}$ bar) in test oil 3.4 mm²/s, 840 kg/m³.

Because the nozzles remain *unchanged* as regards cone and orifice insert, the new CEN test data on capacities will often give uneven figures, e.g. 2.37 kg/h.

Because the CEN standard contains a **stricter requirement on capacity tolerance ($\pm 4\%$)**, we cannot round off the new nominal values.

Marking on standard nozzles
The existing marking (old) giving information on *the existing* capacity in USgal/h, spray angle and spray pattern at 700 kPa ($\times 10^{-2}$ bar) in test oil 3.4 mm²/s and 820 kg/m³.

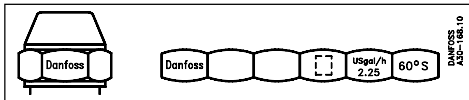

Hvordan How is the correct oil nozzle chosen?

When a Danfoss nozzle needs replacing and all that has to be done is swap old for new, it is a simple matter to make sure that the numbers and letters on each nozzle correspond.

If the designation on the old nozzle has become illegible (something that happens most often because of clumsy handling) the instruction book will contain details as to the right type and size of nozzle to use.

Should the nozzle designation be illegible and the instruction book lost, the size of nozzle must be chosen to match the boiler capacity, its output or its size. This information will be on a plate fitted to the side of the boiler.

kW

Kilowatt. This designation is coming into use more and more since it is part of the SI system of measurement.

1 litre of fuel oil produces 10 kW.

BTU/h

A boiler capacity given in BTU/h can be converted to kW:

100.000 Btu/h ~30 kW.

Note!

Regarding the choice of spray angle and pattern; when there is no information available it is best to start with a nozzle having a 60° spray angle of pattern S.

Is it possible to compare oil nozzles of different makes?

The situation can arise where a nozzle from another manufacturer is to be replaced by one from Danfoss. Then, the question is how to compare the different makes.

Instruction books often contain advice and give information on the different makes and types to use.

Capacities given for the different types of nozzle can be directly compared.

Spray angles too can be compared for this information is stamped on the nozzles.

There is no standard symbol or designation for spray patterns. Therefore, direct comparisons are a little uncertain.

Drawings of spray patterns from the different nozzle manufacturers can be compared and used as a basis in choosing a nozzle, but a combustion analysis must be done to see that the choice is correct.

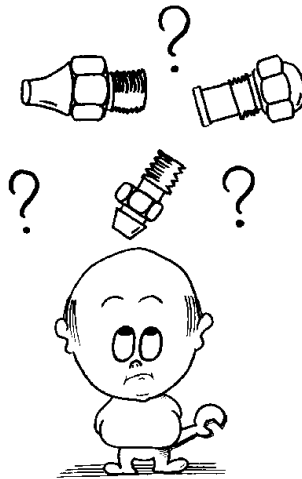

What causes an oil nozzle to drip?

Drips from an oil nozzle are not always the fault of the nozzle but regardless of the reason, dripping must be stopped. Oil in places where it is not wanted, inside or outside the boiler, creates a terrible mess.

Drips from the nozzle on start-up.

If the oil gets through the system with too low a pressure in the start-up period it will merely drip out of the nozzle since atomizing will not occur until pressure becomes sufficiently high.

The cause of low pressure is usually to be found in the solenoid valve or in the hydraulic valve in the oil pump, both of which can collect dirt or become faulty.

Drips from the nozzle during operation.

There can be several reasons:

- The oil nozzle is too far behind the combustion head.
- The ignition electrodes are wrongly placed and protrude into the oil mist.
- The nozzle does not sit tight in its fixture.
Note! Do not use too much force when installing a nozzle.
- Dirt in the nozzle or oil coke in or around the nozzle orifice.
- Defects caused by attempts to clean the nozzle orifice.
- Oil pressure too low. Remember to check the pressure gauge itself now and again.

Drips from the nozzle on stopping.

If the nozzle continues to yield oil when combustion stops instead of totally cutting off, the most likely reasons are:

- Air in the oil pressure pipe between pump and nozzle.
- Solenoid valve or hydraulic valve in the pump dirty or defective.

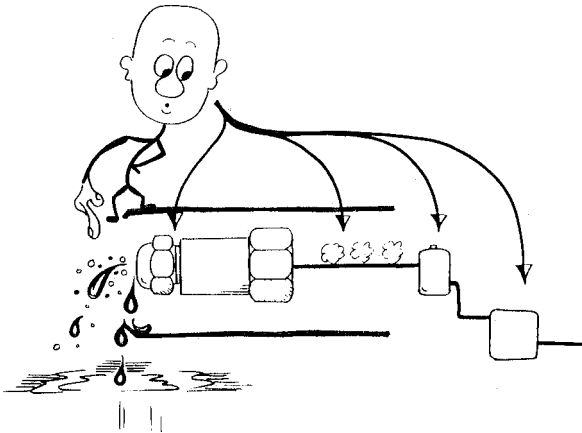

What makes the flame lopsided?

A lopsided flame is a guarantee for bad combustion and must be put right immediately.

The flame can become lopsided from:

- Wear in the oil nozzle.
- Dirt inside the nozzle – in the cone slots for example.
- Attempts to clean the nozzle with sharp instruments or by brute force.
- Oil coke on the tip of the nozzle.
- Off-centre installation of the nozzle in the burner tube. It must be precisely central.
- Unsymmetrical air supply because of a faulty combustion head. A dirty or clogged combustion head will cause an unbalanced air supply.

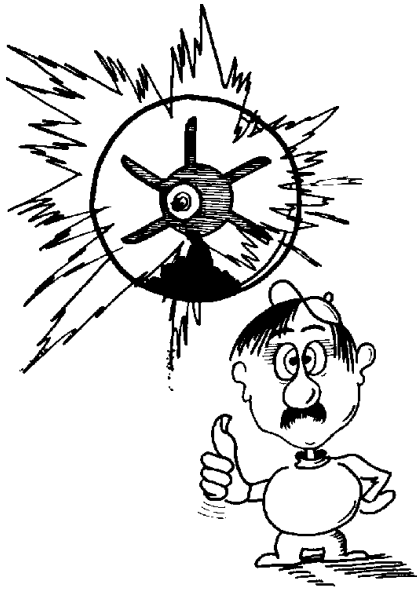

What is the cause of no oil from the nozzle?

To say the least, it is irritating if not one drop of oil emerges from the nozzle. To eliminate the cause, follow the step-by-step approach below.

- Is there oil in the tank.
- Is the valve on the suction line open or closed.
- Is the check-valve on the suction line the wrong way round.
- Does the pump rotate. Sometimes the pump/motor coupling can break up.
- Does the pump suck. How much suction does the vacuum meter show.
- Can the presence of air be seen in a transparent test hose on the suction side of the pump. Air can enter because of too high a vacuum, or from a leak in the suction line.
- Is the pump filter clean and in good order.
- Are the pump hydraulic and solenoid valves open and working as they should be.
- Is there dirt in the oil pipe to the nozzle.
- Is the nozzle filter clean and in good order.
- Is the nozzle blocked.
- Is the oil very cold and thick. Perhaps some water in the oil has turned into ice.
- Has the fire valve operated.

If all these factors are checked and ordered as necessary there should no longer be a problem.

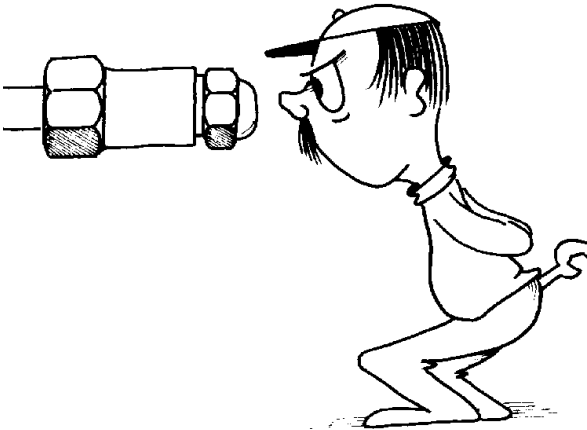

What causes oil coke on the nozzle and ignition electrodes?

When liquid oil is heated above a certain temperature a process takes place called “cracking” and a stone-hard black carbon (coke) settles out. Under normal operating conditions the amount of carbon deposited on the nozzle and ignition electrodes will be unnoticeable. But just a slight scratch on the tip of the nozzle can create a path along which small amounts of oil can find their way. This oil will not of course be atomized and will be exposed to radiant heat from the flame. Consequently, it will produce carbon on the tip of the nozzle and cause interference with the atomizing process and poorer combustion.

The same thing can happen if the nozzle drips.

If the ignition electrodes sit incorrectly they can form a projection for the oil spray to hit and any oil appearing on the tips of the electrodes will receive heat from the flame and carbon deposits will start to build up.

Eventually the electrodes will short circuit, the ignition spark will become non-existent and plant restart impossible.

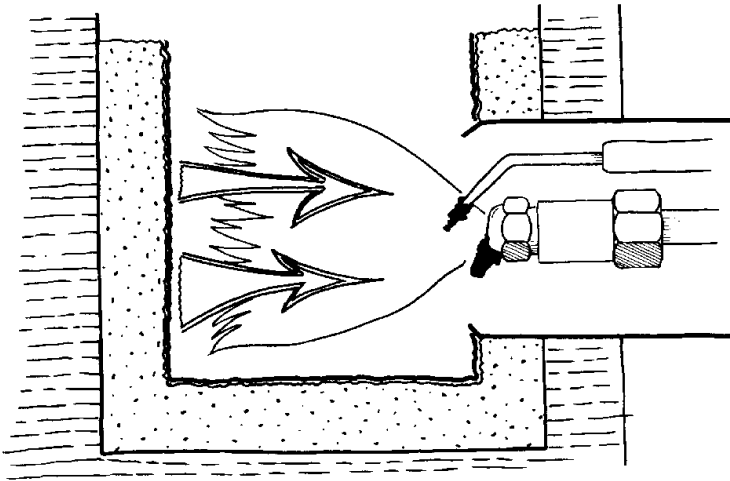

The tendency towards coking is worse on boilers with a heavy fire-brick lining. The reason is that fire-bricks give off strong return radiation which will reach oil particles on the nozzle, ignition electrodes and combustion head during the periods when those parts are not being cooled down by air blast.

Note!

Coke formation on nozzle and electrodes will always lead to poor performance and must at all costs be avoided.

Why “shooting stars” in the flame?

It was the Chinese who first discovered that powdered carbon added to fireworks produces certain effects and ever since, the sparkle from the little carbon particles when a firework is ignited has delighted everyone. Not so pleasing are the “fireworks” that occur in the combustion chambers of many oil-heating plants. With bad atomizing, the oil mist will contain such large drops that before the drops have a chance to evaporate, they will crack and produce the small carbon particles and the “shooting stars”. Unfortunately, this process produces much mess in the boiler and should be avoided. The large drops will not all be completely burned and gradually the heating surfaces and boiler floor will get covered with a mixture of soot and coke which will ruin the heat transfer, so leading to poor operating economy. Shooting stars in the flame when there is a large volume of excess air will be evident from a soot test, for the soot paper will show yellowish-brown spots from the unburnt oil.

Shooting stars in the flame can come from:

- Too low an oil pressure.
- Defective combustion head, or possibly a defective nozzle.
- Oil too thick, (too cold?).
- Too much excess air.

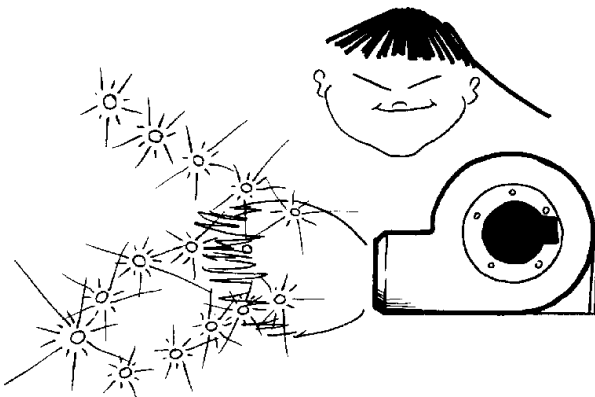

What produces a greasy malodorous deposit in the boiler and how can it be removed?

When an oil-heating plant can be detected from a distance by its smell, the most frequent cause is the interior of the boiler being covered with a black shiny greasy substance which is not so easy to remove.

This substance is usually created when the oil burner has too large an excess of air. Some of the ignited oil becomes cooled down so violently that it is extinguished before being completely burned out.

Since the lightest contents in the oil are the first to be burned, what is left if the oil is not completely consumed are the tars. Tarry deposits are avoidable so long as oil combustion does not involve too much excess air. Also, as high a CO₂ percentage must always be maintained – without forgetting the soot count.

Tarry deposits can be burnt off, but if they are very thick the advice of a chimney cleaning specialist should be sought. Consulting the local fire brigade is also a good idea.

Basically, burning-off is a matter of reducing the air supply and increasing boiler temperature by using the boiler thermostat.

Tarry deposits most often occur because:

- Oil combustion is accompanied by too much superfluous air.
- Too low an oil pressure, or a defective nozzle, produce oil drops which are too large.



Why does soot form in the flame?

The theoretical reason for the formation of soot in a flame is very complicated, but, in general, oil vapour can form soot if there is a deficiency of air for combustion.

Every one of the millions of oil droplets must have the right amount of air on combustion – neither an excess nor a deficiency.

This means:

- Effective atomizing.
- Effective mixing of oil and air in the correct proportions.

Soot-free, or virtually soot-free, combustion can be obtained by:

- Correct use of a high quality oil nozzle.
- Correct combination of nozzle and combustion head.
- Correct oil pressure.
- Ensuring the required air supply to the boiler room.
- Good cleaning and maintenance of the fan housing, burner tube, impeller, combustion head and nozzle. In other words, all these parts must be free of damage and dirt.
- Insulating the chimney to ensure stable draught.
- Oil must not be cooled too much.

Since layers of soot have very unfortunate effects both on operating economy and the environment, every time adjustments are made to the plant a soot count ought to be taken.

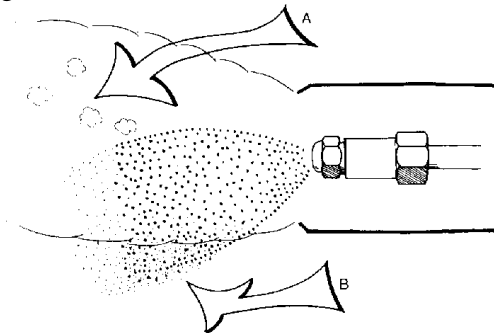

Note!

As indicated by the sketch, if the pattern of oil and air supply does not correspond there is a risk of either an air deficiency with soot formation or an excess of air with unburnt oil. These conditions often arise when the nozzle is faulty and causes poor atomizing, and when air supply becomes unsymmetrical owing to the combustion head being dirty or defective.

Arrow A shows an excess of air and arrow B an air deficiency.

What causes the oil to ignite with a bang?

One experience of the mess that mistimed ignition can make is enough to make most people try and avoid its repetition.

When oil ignites with an explosion there can be several reasons:

- The ignition spark can jump from an electrode to the combustion head instead of from one electrode to the other – as a rule, because the electrodes are incorrectly located.
- After many attempts to restart the plant manually, a cloud of oil vapour may have collected inside the boiler, when ignition does take place this oil cloud will ignite with a bang. If ignition does not occur after one or two attempts, it is wise to find out why, rather than attempt further re-starts.
- The nozzle may have been installed so far forward that the air velocity around it is high enough to blow the air/oil mixture away from the nozzle and ignition spark. Then, the mixture in the chamber in front of the nozzle becomes so charged that it enlarges and reaches the spark so that an uncontrollably large amount of oil ignites in one big bang.
- Too low an oil pressure and atomizing lopsided because of a defective nozzle.
- Oil can collect in the burner tube because of drips from the nozzle or leakage between nozzle and nozzle fixture. At some time or other this oil will become heated sufficiently for it to start vapourizing. Then, if an uncontrolled amount of this vapour enters the combustion chamber, there will be a minor explosion.

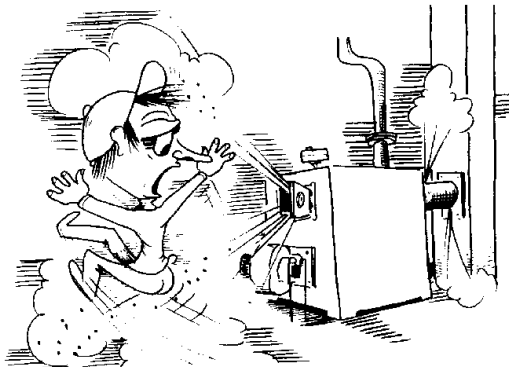

What can be wrong if there is no flame?

After carefully doing everything to make the plant run it is very frustrating when no flame appears.

There can be many reasons, among them:

- No oil in the tank.
- Leakage in the suction line.
- The valve in the suction line is closed or perhaps the line has been trodden flat.
- The oil pump will not suck.
- The oil pump does not rotate because the coupling is worn out.
- The solenoid valve on the oil pressure line will not open.
- Dirt in the oil tank is being sucked up to block the pump and nozzle.
- Oil nozzle blocked because dirt has entered when fitting it.
- No spark because of a fault in the transformer or because of faulty leads.
- No spark due to short-circuited electrodes – or oil coke or soot deposits on the porcelain insulators.
- Pump rotates in the wrong direction.
- If valve on the suction line is the wrong way round.
- The oil is too thick (too cold?).
- Pressure pipe to the oil nozzle blocked up.
- Suction and return lines reversed.
- The oil supply to the pump may have been set up for a two-pipe system where a one-pipe system exists, (or vice versa).
- Oil pump hydraulic valve defective.
- Oil pump pressure too low.
- Air in the suction line because of too high a vacuum (5 - 6 m wg).

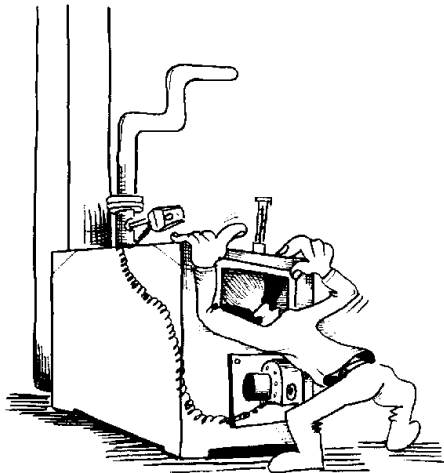

What causes leakage between oil nozzle and nozzle fixture?

Dirt between the joint surfaces of nozzle and fixture can cause leakage, but the worst danger is from the use of excessive force when screwing the nozzle into its fixture. Just as with all other spanner work, too much force does more harm than good and with nozzles and fixtures it will result in damage to the very carefully machined joint surfaces.

Therefore, excessive force must never be applied, the use of packing twine, joint paste or the like is also not permissible.

The two most important rules for making a good seal between the nozzle and its fixture are: careful handling to avoid damage to the joint surfaces and making sure that the surfaces are clean before assembly.

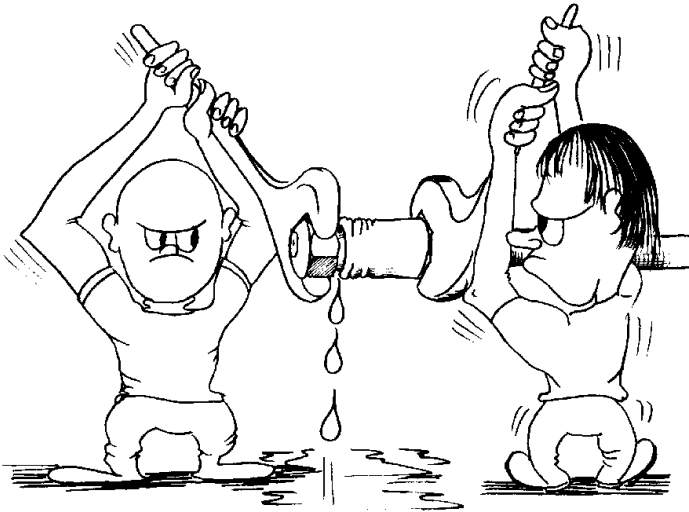

Can the nozzle be the reason for the flue-gas temperature being too high?

High flue-gas temperature, for example 300-350°C, is a sign that the plant is not running economically and it should be looked into. There are many reasons for excessive flue-gas temperature but it is important to know which of them can be attributed to the oil nozzle:

- Oil combustion is accompanied by too much excess air, thus CO₂ percentage is too low.
- Soot deposits on the boiler heating surfaces prevent heat transfer to the water in the boiler.
- Too high an oil pressure. Remember, a 0.75 USgal/h nozzle will yield 1.1 USgal of oil if the pressure is for some reason increased from 7 bar to 15 bar.
- Too large a nozzle has been chosen in relation to boiler capacity. See section “How is the correct oil nozzle chosen?”
- The boiler baffle plate which is used to improve the heat transfer in the boiler may have been removed or burnt away.
- Fire-bricks laid incorrectly or collapsed.

Note!

Remember to check whether the thermometer reads correctly.

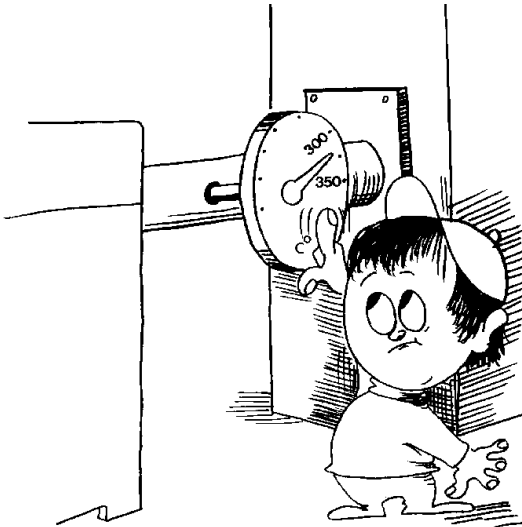

Can the nozzle cause too low a flue-gas temperature?

When the flue-gas temperature is too low, for example 170-180°C, it is usually a sign of good operating economy. However, since there is a danger that water vapour in the gas (1 litre water vapour per kg oil) will condense and cause damage inside the chimney and draught pipe, the reason for the low temperature ought to be established. The following causes should be investigated:

- Too small an oil nozzle has been chosen in relation to boiler capacity. See section “How is the correct oil nozzle chosen?”
- Too low an oil pressure. Although this will most often give rise to poor combustion with soot formation.
- Perhaps the boiler baffle plates are too effective for the plant. This can reveal that the relation between nozzle size and boiler capacity is incorrect.
- Cold air entry into the flue pipe cools the gas down so that its temperature appears to be low. This condition can be checked by taking CO₂% measurements in the pipe. If the CO₂% is low, 4-5% for example, while that measured in the combustion chamber is up on 10-12%, it is a sure sign of air penetration through the boiler casing or through the joint between boiler casing and flue pipe.

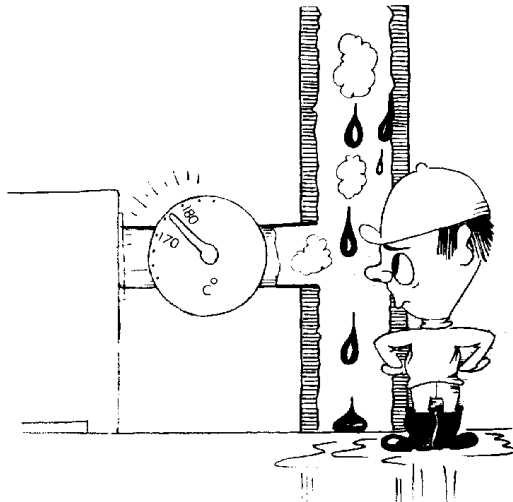

Note!

A lower flue-gas temperature to gain better operating economy is more defensible on a plant with a well-lined chimney than on one with a poor chimney lining (and, without doubt, internal chimney dimensions which are altogether too large).

What makes the flame too long?

If the flame becomes too long it may lick the boiler heating surfaces and cause sooty combustion. Under certain circumstances, cracked oil can cake around the combustion chamber walls.

The flame can become too long because:

- The nozzle chosen has too small a spray angle –30° instead of 60° for example.
- Oil too cold. When oil becomes too cold it gets thicker and produces larger oil drops. These larger drops need to travel through the air for a longer time than small drops before being burned up. That is why the flame increases in length.
- Nozzle capacity too large for the size of the combustion chamber – or vice versa. This relationship should be checked against that given in the instruction book.
- Nozzle spray and atomizing pattern does not correspond with the atomizing pattern of the burner (consult the instruction book).
- Combustion head assembled or located incorrectly. Again, see what advice the instruction book contains.
- Oil pressure too low. See if it corresponds to the pressure prescribed for the burner.
- Nozzle capacity too high, possibly because of too high an atomizing pressure.

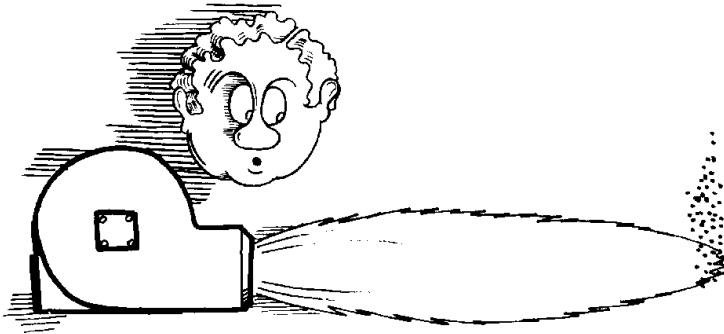

What causes oil and coke to collect around nozzle and combustion head?

A filthy burner tube not only looks unappetizing, but accumulations of oil and coke on the components in the tube (nozzle and fixture combustion head, electrodes, ignition cables, flame monitor etc.) can have very adverse effects on combustion and operating economy. Such sad conditions as the ones suggested by the sketch are, unfortunately, not rare and it may be useful to outline how they can arise:

- Defective nozzle. There may be coke on the tip of the nozzle.
- Incorrect nozzle. Perhaps the spray angle is too large.
- Oil pressure too high or spray pattern incorrect. If the oil pressure is too high, the conical atomizing pattern opens up (the spray angle increases) so that oil can be bounced backwards.
- Nozzle incorrectly placed in relation to the combustion head.
- Defective or wrongly assembled combustion head.
- Hair or other foreign matter in the combustion head.
- Bad oil cut-off on stopping and starting. The solenoid valve and shut-off valve in the oil pump must be examined. Be very careful to properly bleed the plant of air.
- Electrodes protrude into the oil mist.
- Momentary over-pressure in the boiler combustion chamber. A poor chimney can be the cause.
- Varying oil pressure because of a defective pressure regulating valve in the pump.
- Leakage between nozzle and fixture. Remember not to use excessive force when tightening the nozzle to avoid damaging the joint surfaces.

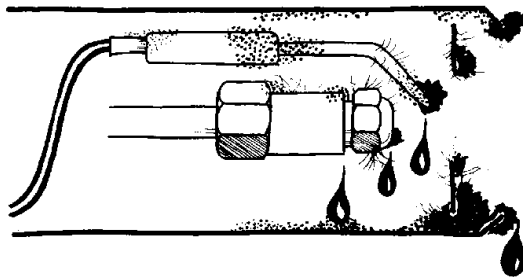

Why does nozzle output suddenly begin to vary?

Since oil and air volumes must have a definite relation before the oil can be burned cleanly and economically, the consequences of sudden variations in oil supply are not exactly favourable. The reason for this fault could most likely be pinned down with the help of a pressure gauge, but it certainly can arise from, among other things:

- Defective pressure regulating valve in the pump.
- Wear in the oil pump.
- Dirty oil filters in pump or nozzle.
- Leaking or dirty check-valve in the suction line.
- Varying pump speed owing to a defective coupling.
- Defective or dirty solenoid valve.

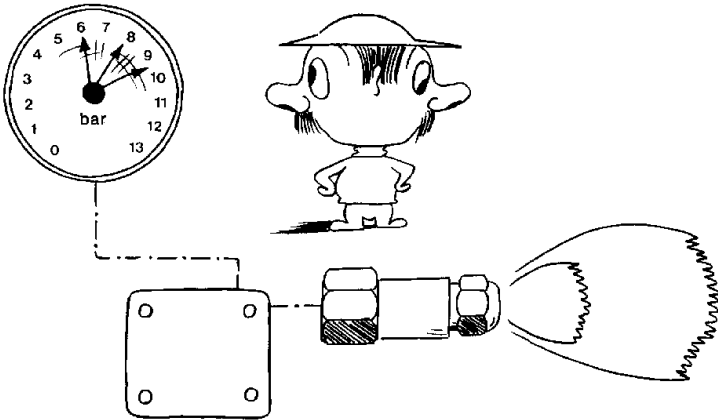

What to do with old, worn out nozzles?

Avoiding waste and re-use are topical subjects at the moment and there are many things which can be used again and again. Not so the oil nozzle. It is a good friend when new, but an old or worn nozzle should not be used as a spare.

For the sake of economy, and safety, old nozzles must be thrown away.

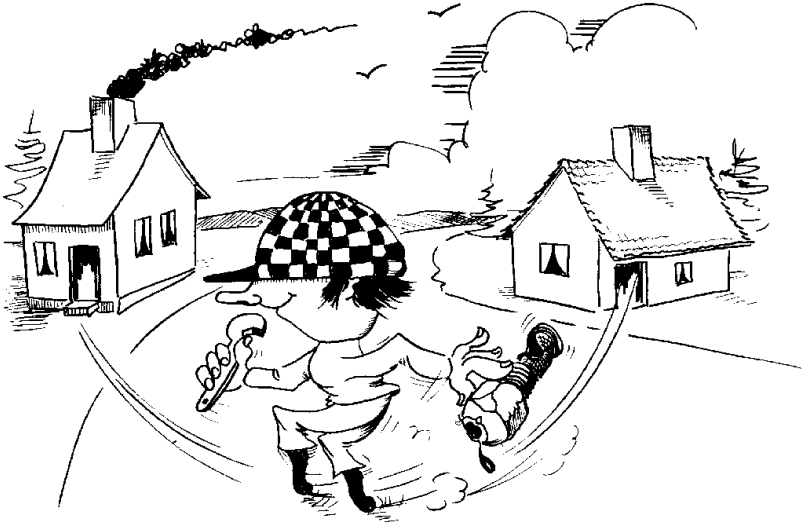

Choosing the correct nozzle for burners using EL fuel oil

Example:

Boiler effect:

$P = 25 \text{ kW}$ (approx. 21.500 kcal/h)

Boiler efficiency:

$\eta = 0.88$ (estimate)

Net calorific value of EL fuel oil:

$H_U = 11.86 \text{ kWh/kg}$
(approx. 10.200 kcal/kg)

$$\text{Oil flow rate } m = \frac{P}{H_U \cdot \eta} = \frac{25 \text{ kW kg}}{0.88 \cdot 11.86 \text{ kWh}} = 2.4 \frac{\text{kg}}{\text{h}}$$

Assuming a density of 0.84 kg/l for EL fuel oil the oil flow rate

$$m = 2.4 \text{ kg/h is converted into } \dot{v} = \frac{2.4 \text{ kg}}{\text{h} \cdot 0.84 \text{ kg}} = 2.85 \frac{\text{l}}{\text{h}}$$

With $1 \text{ l/h} = 0.2642 \text{ USgal/h}$ the oil flow rate

$\dot{v} = 0.2642 \times 2.85 = 0.75 \text{ USgal/h}$ which is reached at a pump pressure of 7 bar using a nozzle 0.75 USgal/h.

When using a nozzle 0.65 USgal/h the pump pressure has to be increased to approx 9.5 bar.

Nozzle capacities – CEN

Nozzle capacities in USgal/h as a function of the atomizing pressure at a viscosity of $3.4 \text{ mm}^2/\text{s}$ and a density of 840 kg/m^3 .

Reference pressure

6 bar kg/h	7 bar kg/h	8 bar kg/h	10 bar kg/h	12 bar kg/h	14 bar kg/h
1.13	1.22	1.30	1.46	1.59	1.72
1.28	1.38	1.48	1.66	1.81	1.96
1.44	1.56	1.67	1.87	2.04	2.21
1.63	1.76	1.88	2.11	2.31	2.49
1.83	1.98	2.11	2.37	2.59	2.80
2.06	2.23	2.38	2.67	2.92	3.15
2.27	2.45	2.62	2.94	3.22	3.47
2.56	2.76	2.96	3.31	3.62	3.91
2.88	3.11	3.32	3.72	4.07	4.40
3.28	3.54	3.79	4.24	4.64	5.01
3.44	3.72	3.98	4.45	4.87	5.26
3.64	3.94	4.21	4.71	5.15	5.57
4.00	4.32	4.62	5.17	5.66	6.11
4.52	4.88	5.22	5.84	6.39	6.90
4.70	5.08	5.43	6.08	6.66	7.19
5.07	5.48	5.85	6.55	7.17	7.55

Nozzle capacities

Nozzle capacities in USgal/h as a function of the atomizing pressure at a viscosity of 3.4 mm²/s and a density of 820 kg/m³.

Reference pressure

6 bar GPH	7 bar GPH	8 bar GPH	10 bar GPH	12 bar GPH	14 bar GPH
0.37	0.40	0.43	0.48	0.52	0.56
0.46	0.50	0.53	0.60	0.65	0.71
0.51	0.55	0.59	0.66	0.72	0.78
0.55	0.60	0.64	0.72	0.78	0.85
0.60	0.65	0.69	0.78	0.85	0.92
0.69	0.75	0.80	0.90	0.98	1.06
0.79	0.85	0.91	1.02	1.11	1.20
0.92	1.00	1.07	1.19	1.31	1.41
1.01	1.10	1.17	1.31	1.44	1.55
1.11	1.20	1.28	1.43	1.57	1.70
1.16	1.25	1.34	1.49	1.64	1.77
1.25	1.35	1.44	1.61	1.77	1.97
1.39	1.50	1.60	1.79	1.96	2.12
1.52	1.65	1.76	1.97	2.16	2.33
1.62	1.75	1.87	2.09	2.29	2.47
1.85	2.00	2.14	2.39	2.62	2.83
2.08	2.25	2.41	2.69	2.95	3.18
2.31	2.50	2.67	2.99	3.27	3.54
2.54	2.75	2.92	3.29	3.60	3.89
2.78	3.00	3.21	3.59	3.93	4.24
3.24	3.50	3.74	4.18	4.58	4.95
3.47	3.75	4.01	4.48	4.91	5.30
3.70	4.00	4.28	4.78	5.24	5.66
4.17	4.50	4.81	5.38	5.89	6.36
4.64	5.00	5.35	5.98	6.55	7.07
5.09	5.50	5.88	6.57	7.20	7.78
5.55	6.00	6.41	7.17	7.85	8.48
6.02	6.50	6.95	7.77	8.51	9.19
6.94	7.50	8.02	8.96	9.82	10.61
7.87	8.50	9.09	10.16	11.13	12.02
9.26	10.00	10.69	11.95	13.09	14.14
10.18	11.00	11.76	13.15	14.40	15.56
11.11	12.00	12.83	14.34	15.71	16.97
12.50	13.50	14.43	16.14	17.67	19.09
13.89	15.00	16.04	17.93	19.64	21.21
15.74	17.00	18.17	20.32	22.26	24.04
18.05	19.50	20.85	23.31	25.53	27.58
20.37	22.00	23.52	26.29	28.80	31.11
23.14	25.00	26.73	29.88	32.73	35.35
25.92	28.00	29.93	33.47	36.66	39.60
29.16	31.50	33;67	37.65	41.24	44.55

$$Q_2 \sim Q_1 \times \sqrt{\frac{P_2}{P_1}} \quad 1 \text{ USgal} \sim 3.785 \text{ l}$$

Danfoss can accept no responsibility for possible errors in catalogues, brochures and other printed material. Danfoss reserves the right to alter its products without notice. This also applies to products already on order provided that such alterations can be made without subsequential changes being necessary in specifications already agreed. All trademarks in this material are property of the respective companies. Danfoss and the Danfoss logotype are trademarks of Danfoss A/S. All rights reserved.

The Danfoss logo is written in a red, cursive script font. The word "Danfoss" is written in a fluid, handwritten style with a slight shadow or underline effect beneath the letters.