

Data sheet

# Radiator thermostats type RA2000, valve bodies type RA-FN (series D) and RA-G

## Application



RA2000 013G2910  
Built-in sensor



RA2000 013G2920  
tamperproof



RA2000 013G5062  
remote temperature adjuster



RA-FN straight



RA-FN angle



RA-FN horizontal angle



RA-G straight



RA-G angle

Robustly built and designed to meet the rigours of the commercial and industrial sectors, a comprehensive range of RA2000 radiator thermostats is available for practically all systems and installation conditions.

Sensors and valve bodies are packed separately so that they can be mixed and matched for any duty.

**RA-FN fixed capacity valve bodies** are used in two-pipe heating systems.

Versions: straight and angled in sizes from DN 10 to DN 25 and horizontal angled in sizes from DN 10 to DN 20.

**RA-G high capacity valve bodies** are used in gravity systems or in pumped one-pipe systems. Versions: straight and angled in sizes from DN 15 to DN 25.

RA-FN and RA-G valve bodies are made of nickel-plated brass. The pressure pin of the gland seal is of chromium steel and works in a lifetime lubricated O-ring seal. The gland assembly can be replaced without draining down the system.

The protective cap supplied with each new valve may be used for manual control during installation only. It should not be used as isolation device. A manual shut off device is available as a spare part.

**Sensors** are available as in standard and tamper-proof versions, with built-in or remote sensors. Remote temperature adjusters are available with 2, 5 and 8 m of capillary tube.

All sensors have facilities for temperature range limiting and locking.

### RA2000 features:

- Robust construction
- Accurate temperature control
- Temperature range limiting and locking
- Tamper resistant models
- Built-in and remote sensor models
- Remote temperature adjustment models
- Low temperature models

System

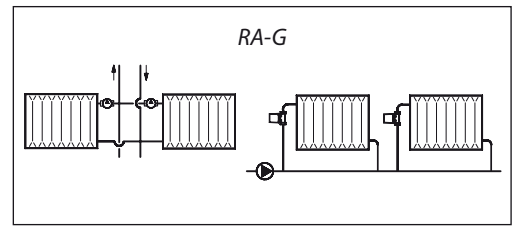
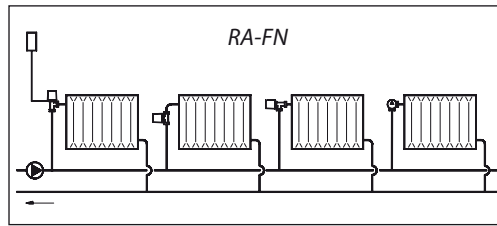

Code Nos. and Technical Data for RA2000 sensors

Type	Sensor	Temp. range <sup>1)</sup> Xp = 2K	Code no.
RA 2910	Built-in sensor	5 - 26 °C	<b>013G2910</b>
RA 2912	Remote sensor, 0 - 2 m capillary tube <sup>2)</sup>	5 - 26 °C	<b>013G2912</b>
RA 2914	Built-in sensor, limited temperature range	5 - 22 °C	<b>013G2914</b>
RA 2916	Remote sensor, 0 - 2 m capillary tube <sup>2)</sup> , limited temperature range	5 - 22 °C	<b>013G2916</b>
RA 2920	Built-in sensor, tamperproof model	5 - 26 °C	<b>013G2920</b>
RA 2922	Remote sensor, 0 - 2 m capillary tube <sup>2)</sup> , tamperproof model	5 - 26 °C	<b>013G2922</b>
RA 5062	Remote temperature adjuster <sup>3)</sup> , 0 - 2 m capillary tube <sup>2)</sup>	8 - 28 °C	<b>013G5062</b>
RA 5065	Remote temperature adjuster <sup>3)</sup> , 0 - 5 m capillary tube <sup>2)</sup>	8 - 28 °C	<b>013G5065</b>
RA 5068	Remote temperature adjuster <sup>3)</sup> , 0 - 8 m capillary tube <sup>2)</sup>	8 - 28 °C	<b>013G5068</b>

<sup>1)</sup> Temperatures shown are for units with built-in sensors which are subject to influence from radiation and flow temperature. Without these influences, max. temperature is 2 °C higher at design load condition.

<sup>2)</sup> Remote sensors are supplied with all the capillary tube coiled within the sensor. When installing the sensor, only the length required should be uncoiled.

<sup>3)</sup> Remote temperature adjusters are supplied with adapters for RA-valves. Adaptors for older valves can be ordered separately: RAVL-adaptor, code no. 013G5192 and RAV-adaptor, code no. 013G5193.

## Data Sheet

## Radiator thermostats type RA2000, valve bodies type RA-FN (series D) and RA-G

Code Nos. and Technical  
Data for RA-FN valves

Type	Design	Connections		$k_v$ -value <sup>1)</sup> (m <sup>3</sup> /h at 1 bar pressure drop) P-band = K				
		Inlet	Outlet	0.5K	1.0K	1.5K	2.0K	$k_{vs}$
RA-FN 10	angle	Rp 3/8	R 3/8	0.17	0.34	0.47	0.56	0.65
RA-FN 10	straight	Rp 3/8	R 3/8	0.17	0.34	0.47	0.56	0.65
RA-FN 10	horiz.	Rp 3/8	R 3/8	0.17	0.34	0.47	0.56	0.65
RA-FN 15	angle	Rp 1/2	R 1/2	0.22	0.43	0.57	0.73	0.90
RA-FN 15	straight	Rp 1/2	R 1/2	0.22	0.43	0.57	0.73	0.90
RA-FN 15	horiz.	Rp 1/2	R 1/2	0.22	0.43	0.57	0.73	0.90
RA-FN 20	angle	Rp 3/4	R 3/4	0.30	0.58	0.83	1.04	1.40
RA-FN 20	straight	Rp 3/4	R 3/4	0.30	0.58	0.83	1.04	1.40
RA-FN 20	horiz.	Rp 3/4	R 3/4	0.25	0.50	0.67	0.80	1.00
RA-FN 25	angle	Rp 1	R 1	0.30	0.58	0.83	1.04	1.40
RA-FN 25	straight	Rp 1	R 1	0.30	0.58	0.83	1.04	1.40

1) The  $k_v$ -value indicates the water flow (Q) in m<sup>3</sup>/h at a pressure drop ( $\Delta p$ ) across the valve of 1 bar;  $k_v = Q : \sqrt{\Delta p}$ .  
The  $k_v$ -value is stated according to EN 215, at  $Xp = 2K$  i.e. the valve is closed at 2°C higher room temperature.  
At lower settings the  $Xp$  value is reduced to 0.5K. The  $k_{vs}$ -value states the flow Q at a maximum lift, i.e. at fully open valve.

Type	Design	Max. pressure <sup>2)</sup>			Max. flow temp. °C	Code no.
		Work.	Diff.	Test		
		bar	bar	bar		
RA-FN 10	angle	10	0.6	16	120	<b>013G0021</b>
RA-FN 10	straight	10	0.6	16	120	<b>013G0022</b>
RA-FN 10	horiz.	10	0.6	16	120	<b>013G0141</b>
RA-FN 15	angle	10	0.6	16	120	<b>013G0023</b>
RA-FN 15	straight	10	0.6	16	120	<b>013G0024</b>
RA-FN 15	horiz.	10	0.6	16	120	<b>013G0143</b>
RA-FN 20	angle	10	0.6	16	120	<b>013G0025</b>
RA-FN 20	straight	10	0.6	16	120	<b>013G0026</b>
RA-FN 20	horiz.	10	0.6	16	120	<b>013G0145</b>
RA-FN 25	angle	10	0.6	16	120	<b>013G0027</b>
RA-FN 25	straight	10	0.6	16	120	<b>013G0028</b>

2) Working pressure = static + differential pressure. The maximum differential pressure specified is the maximum pressure at which the valves give satisfactory regulation. As with any device which imposes a pressure drop in the system, noise may occur under certain flow/pressure conditions. To ensure quiet operation, maximum pressure drop should not exceed 30 to 35 kPa. The differential pressure can be reduced by the use of the Danfoss differential pressure regulators types AVD, AVDL, AVDS, IVD or ASV-P.

Data Sheet

Radiator thermostats type RA2000, valve bodies type RA-FN (series D) and RA-G

Code nos. and Technical Data for RA-G valves

Type	Design	Connection ISO 7-1		$k_v$ -values <sup>1)</sup> [m <sup>3</sup> /h] P-Band [K]				
		Inlet	Outlet	0.5	1.0	1.5	2.0	$k_{vs}$
RA-G 15	angle	R <sub>p</sub> 1/2	R 1/2	0.54	1.07	1.61	2.06	4.30
RA-G 15	straight	R <sub>p</sub> 1/2	R 1/2	0.51	0.94	1.35	1.63	2.30
RA-G 20	angle	R <sub>p</sub> 3/4	R 3/4	0.57	1.11	1.16	2.20	5.01
RA-G 20	straight	R <sub>p</sub> 3/4	R 3/4	0.54	1.07	1.61	2.06	3.81
RA-G 25	angle	R <sub>p</sub> 1	R 1	0.59	1.27	1.77	2.41	5.50
RA-G 25	straight	R <sub>p</sub> 1	R 1	0.57	1.16	1.71	2.27	4.58

1) The  $k_v$ -value indicates the water flow (Q) in m<sup>3</sup>/h at a pressure drop ( $\Delta p$ ) across the valve of 1 bar.

$k_v = Q: \sqrt{\Delta p}$  The  $k_{vs}$ -value states the flow Q at a maximum lift, i.e. at fully open valve. . The  $k_{vs}$ -value

states the flow Q at a maximum lift, i.e. at fully open valve.

Type	Design	Max. pressure			Max. flow temp. °C	Code no.
		Work. bar	Diff. <sup>2)</sup> bar	Test bar		
RA-G 15	angle	16	0.20	25	120	<b>013G1676</b>
RA-G 15	straight	16	0.20	25	120	<b>013G1675</b>
RA-G 20	angle	16	0.20	25	120	<b>013G1678</b>
RA-G 20	straight	16	0.20	25	120	<b>013G1677</b>
RA-G 25	angle	16	0.16	25	120	<b>013G1680</b>
RA-G 25	straight	16	0.16	25	120	<b>013G1679</b>

2) Working pressure = static + differential pressure. The maximum differential pressure specified is the maximum pressure at which the valves give satisfactory regulation. As with any device which imposes a pressure drop in the system, noise may occur under certain flow/pressure conditions. To ensure quiet operation, maximum pressure drop should not exceed 30 to 35 kPa. The differential pressure can be reduced by the use of the Danfoss differential pressure regulators.

Accessories

Accessories for RA2000 sensors

Code no.

Theft protection plugs, 50 pcs.	<b>013G1232</b>
Temperature range limiting pins, 30 pcs.	<b>013G1237</b>
Scale cover for 013G2920 and 013G2922 tamperproof sensors	<b>013G1233</b>
Toolkit - Allen key and locking pin tool	<b>013G1236</b>

Accessories for RA-FN and RA-G valves

Code no.

Gland seal, 10 pcs.	<b>013G0290</b>
Manual shut-off knob	<b>013G5002</b>
Spare protective cap	<b>013G0275</b>
Service insert DN 15/20*	<b>013G1706</b>
Service insert DN 25*	<b>013G1707</b>

\*RA-G valves only

Replacement of gland seal

All Danfoss radiator thermostats manufactured since the early 1960's have gland seals which are replaceable without the need to drain down the system (see p. 7).

Replacement sensors for earlier Danfoss thermostats

In order to provide a service and upgrade option for earlier RAV and RAVL valve bodies, a range of service sensors is available. Please request details.

**Setting the temperature**

The required room temperature is set by turning the setting dial. The temperature scales show the correlation between scale values and the room temperature.

The temperature values stated are for guidance only as the obtained room temperature will often be influenced by installation conditions.

The temperature scales are stated according to European standards at  $X_p = 2^\circ\text{C}$ . This means that the radiator thermostats close at a sensor temperature which is  $2^\circ\text{C}$  higher than stated on the temperature scales.

Locking and limitation of the temperature set-point of RA sensors are carried out using the limitation pins placed at the back of the sensor.

Locking and max./min limitation of the remote temperature adjuster type RA 5060 are carried out by limiter tabs. The limiter tabs will be covered by the setting dial.

The procedure is described in the instruction, following the product.



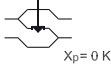

$X_p = 0\text{ K}$

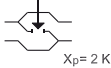

$X_p = 2\text{ K}$

RA 2914 / 2916

I	*	1	2	...	3	.
$5^\circ$	$7^\circ$	$13^\circ$	$17^\circ$	$20^\circ$	C	

\* = Frost protection setting



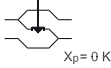

$X_p = 0\text{ K}$

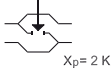

$X_p = 2\text{ K}$

RA 2910 / 2912 / 2920 / 2922

I	*	1	2	...	3	...	4	5	I
$5^\circ$	$7^\circ$	$13^\circ$	$17^\circ$	$20^\circ$	$23^\circ$	$26^\circ$	C		

\* = Frost protection setting





$X_p = 0\text{ K}$



$X_p = 2\text{ K}$

RA2000 5062 / 5065 / 5068

*	1	2	...	3	...	4	5
$8^\circ$	$12^\circ$	$16^\circ$	$20^\circ$	$24^\circ$	$28^\circ$		

\* = Frost protection setting

**Setting the temperature Fig. 1: Operating principles of thermostats**

The function of the thermostat is to measure the ambient temperature, compare this with the required temperature and correct the valve setting in accordance with the difference. The European Standard EN215 requires that radiator thermostats meet various operating criteria.

Danfoss radiator thermostats meet or exceed these requirements in every respect.

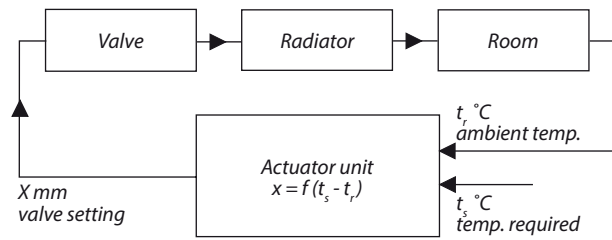

**Fig. 2: Differential pressure dependence**

The closing characteristic of a radiator thermostat is depending on the pressure conditions in the valve. Curve 1 applies to the actuator unit without counterpressure from system differential pressure, while curve 2 shows the offset when the counterpressure increases proportionately to the valve closure. The effect is a result of the elasticity of the actuator unit.

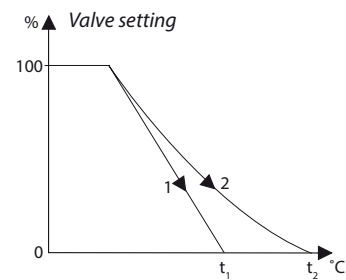

**Fig. 3: Time constant**

In order to provide a steady control of the room temperature, a radiator thermostat must respond quickly on temperature variations. The time constant is depending on the specific heat and surface of the sensor.

At a sudden change in ambient temperature at time 0, the thermostat will respond as shown. The time constant is defined as the time used by the spindle for 63% of its full movement.

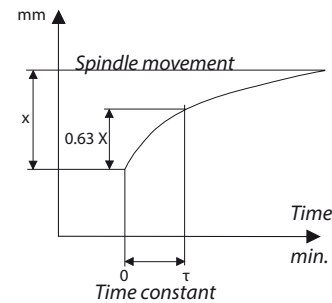

**Fig. 4: Flow temperature dependence**

Radiator thermostats with built-in sensors might experience flow temperature dependence, when heat is transferred from the valve body to the sensor. The actuator unit responds to a temperature different from the actual room temperature, resulting in a lower temperature than required. Insulating materials for the thermostat base, internal heat shields and high quality product design in positioning the sensing element away from the heat source, help reduce this dependence. Danfoss recommend that radiator thermostat sensors are mounted horizontally, away from the effects of heat rising from hot valve and pipework.

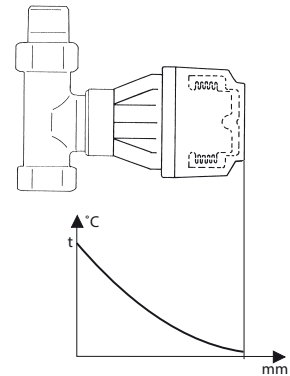

**Fig. 5: Hysteresis**

If the spindle movement of an actuator unit is measured at increasing and then decreasing temperatures, there will be a difference between the point where the valve just closes and the point where it opens again. This difference is termed hysteresis and is caused by friction in the actuator unit and valve body. Hysteresis should be as small as possible.

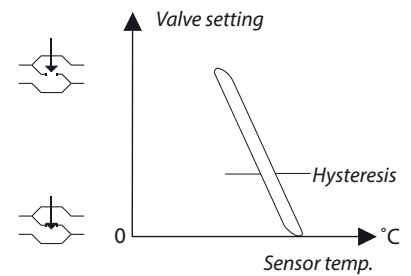

**Sensor operating principle** The RA2000 thermostatic sensor consists of a bellows system with a saturated vapour charge, which provides proportional control, as opposed to on/off.

The sensor is actuated by ambient temperature changes. The calibrated pressure in the bellows corresponds to the temperature of the charge. This pressure is balanced by the force of a regulating spring.

On a rise in ambient temperature, the vapour pressure increases inside the bellows, moving the valve cone towards the "closed" position.

On a drop in ambient temperature, the vapour pressure falls, allowing the bellows to contract and the valve cone to move towards the "open" position.

The vapour charge will always condense at the coldest part of the sensor, usually furthest away from the valve body. The radiator thermostat will therefore always respond to changes in room temperature and will not be affected by the system water temperature.

However, when the air around the sensor is heated by the hot valve body and pipework, then the sensor can detect a temperature higher than the room temperature. To avoid this, Danfoss recommend that the sensor is mounted horizontally whenever possible.

### Sensor operating principle

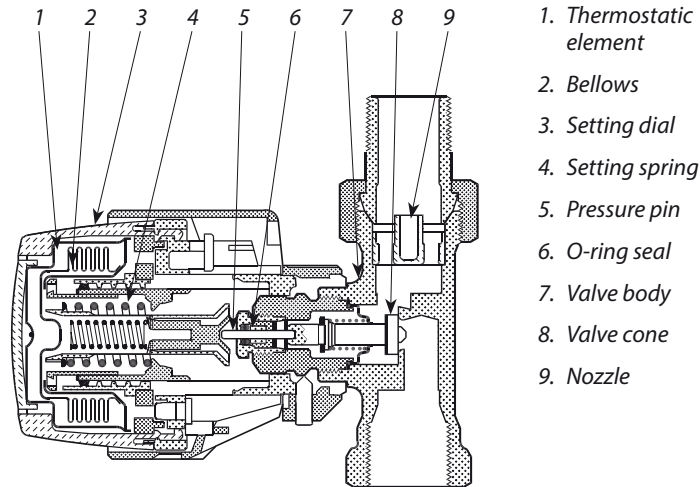

### Hydraulic balance

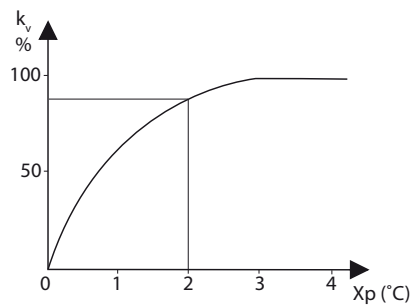

To ensure that the valve capacity of a fully opened valve is not significantly greater than that at 2 degrees C P-deviation, all RA-FN valves have a modified valve characteristic. This improved valve characteristic maintains hydraulic balance during start-up.

### Definitions

#### $k_v$ -coefficient of flow

The  $k_v$ -value is a measure for the quantity of liquid in  $m^3/h$  that the valve will pass with a pressure drop of 1 bar across the valve. The  $k_v$ -value is used in the following formulae to calculate flow rates for valve sizing purposes.

$$Q = k_v \sqrt{\Delta p} \quad \text{or} \quad \Delta p = \left[ \frac{Q}{k_v} \right]^2 \quad \text{or} \quad k_v = \frac{Q}{\sqrt{\Delta p}}$$

where:  $Q$  = flow of liquid in  $m^3/h$   
 $k_v$  = flow coefficient  
 $\Delta p$  = differential pressure (pressure drop) across the valve in **bar**



**Proportional band**

The purpose of a proportional temperature controller is to respond to any deviation from a set temperature level by opening or closing the heat input, until the required room temperature is achieved.

A Danfoss radiator thermostat operates with a small P-band of only 0.5K – 2K, which ensures lesser deviations from the set room temperature than conventional room thermostats.

The difference from the set temperature, which is necessary for the controller to change from closed to open (or vice versa), is called the proportional band or just P-band. This is measured in K (°C).

**Capacities**

**RA-FN**

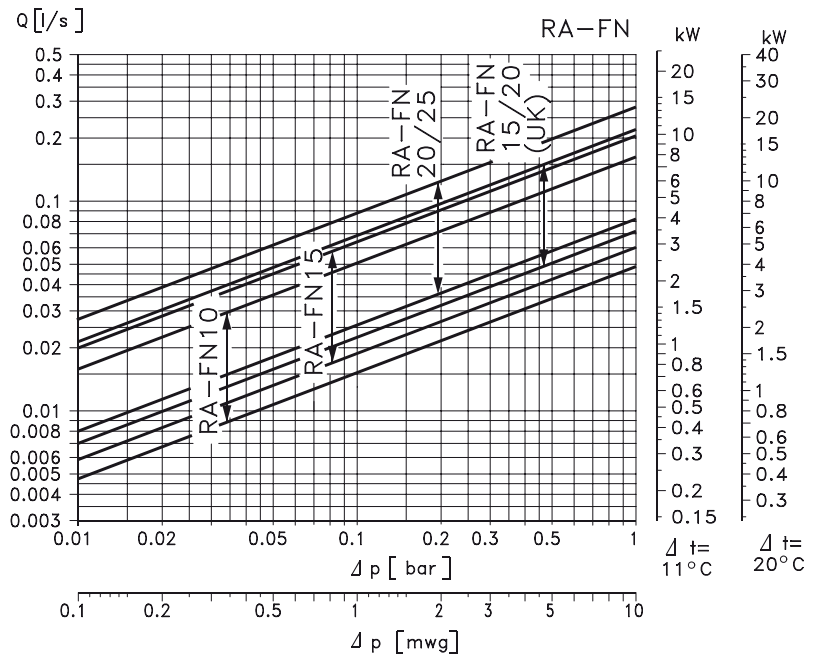

Capacity with P-band between 0.5K and 2K with RA 2000 sensor.

RA-G

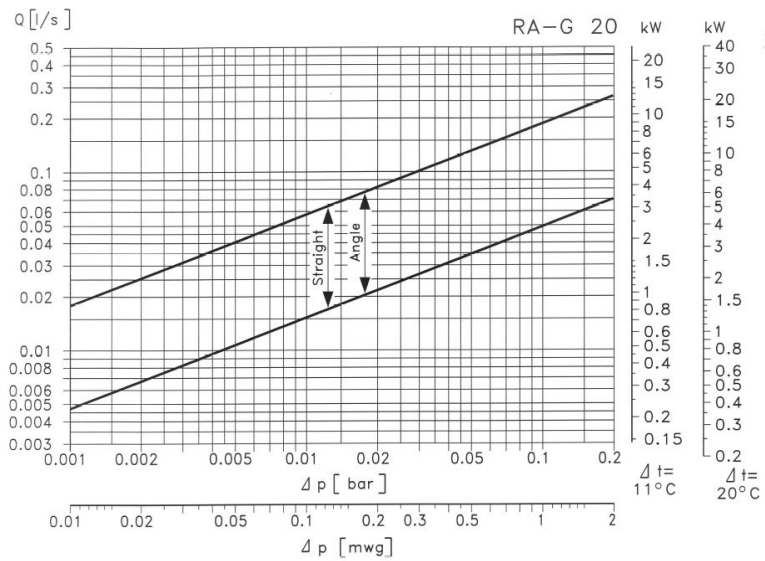
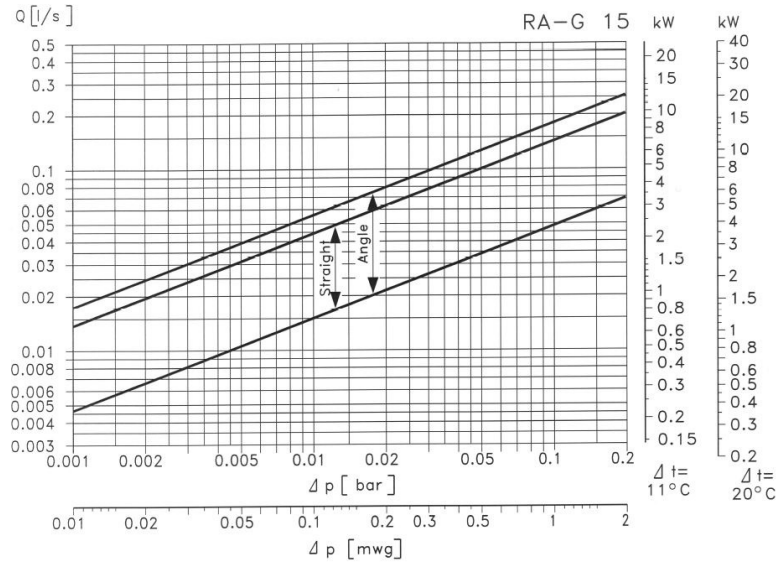

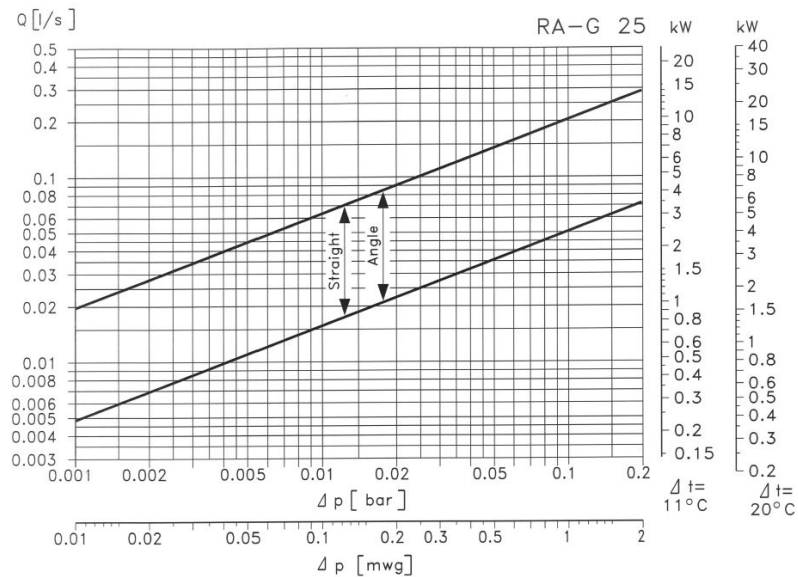

*Note:* As with any device which imposes a pressure drop system, noise may occur under certain flow/pressure conditions. To ensure quiet operation, maximum pressure drop should not exceed 40 to 45 kPa

#### Example

Heat requirement: 2.05 kW  
 Temperature drop: 11 °C  
 Differential pressure across the radiator: 0.05 bar (5 kPa)

#### Solution

Water flow through the radiator per hour:

$$Q = \frac{2.05}{4.2 \times 11} = 0.044 \text{ l/s}$$

The P-band value depends on the chosen valve, i.e. RA-FN 15 will work with a P-band of 2K. RA-FN 20 will work with a P-band of about 1.4K.

The  $k_v$ -value can also be calculated on the basis of this formula:

$$k_v = \frac{Q}{\sqrt{\Delta p}}$$

$$0.044 = \frac{0.044 \times 3600}{1000} = 0.158 \text{ m}^3/\text{h}$$

$$k_v = \frac{0.158}{\sqrt{0.05}} = 0.71$$

*Note:* 1 m<sup>3</sup>/h = 0.278 l/s

**Choose the right sensor**

Always choose a type of thermostatic sensor, which is able to detect the temperature of the ambient air.

Radiator thermostats with built-in sensors should always be fitted horizontally so that the ambient air can pass freely over the sensor.

Danfoss does not recommend the fitting of a built-in sensor in vertical position, because heat transfer from the valve body and possibly surface pipes will cause incorrect operation of the thermostat.

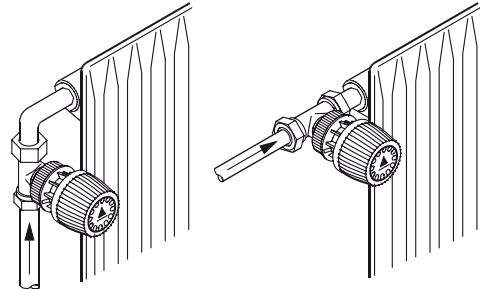

Radiator thermostats with remote sensor should be used when:

- Curtains cover the sensor
- Sensor is affected by surface pipes
- Sensor is affected by draught
- It is necessary to mount the sensor in vertical position.

The remote sensor must be mounted on the wall, away from curtains, or on the skirting board beneath the radiator, if free of surface pipes.

All remote sensors are supplied with a ultra-thin capillary tube. Simply pull out the required length and fix the tube using clips provided or a special tacker gun.

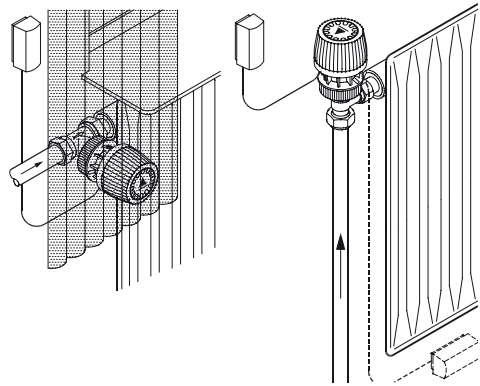

Radiator valves with remote adjustment - the remote temperature adjuster is used on radiators or convectors, which are hidden in a cabinet or in other ways inaccessible to the user. In addition, the room temperature adjuster is used in integral sockets and installation ducts.

The sensor and the setting part of a remote setting unit are integrated.

The remote temperature adjuster is placed in an easily accessible place, where the ambient air can pass freely over the sensor. The remote temperature adjuster should be mounted 1.2 to 1.6 m above the floor.

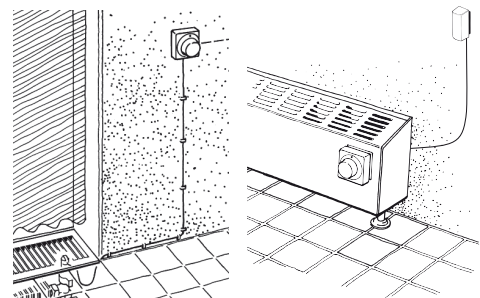

Replacing the gland seal

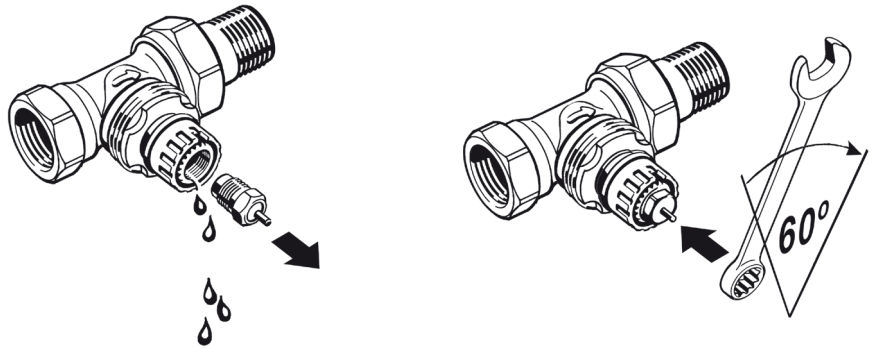

If a valve begins leaking from the gland seal, the seal can be easily replaced while the system is in operation.

Use a KW 10 spanner to remove the old gland seal and to tighten the new.

Dimensions

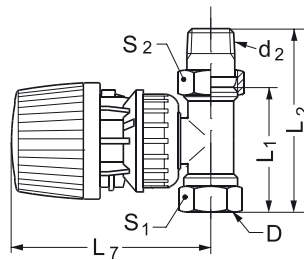

RA2000 built-in sensor on RA-FN or RA-G valve

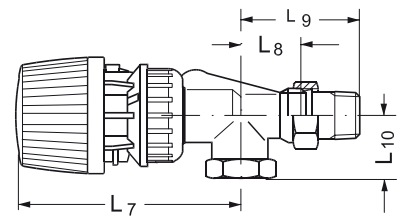

RA2000 built-in sensor on RA-FN valve, horizontal angle

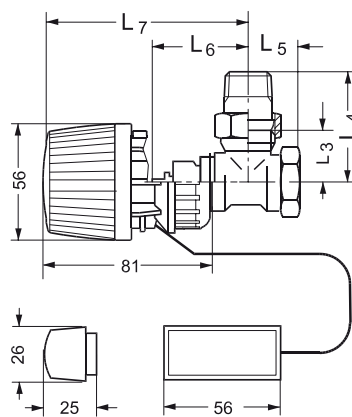

RA2000 remote sensor on RA-FN or RA-G valve

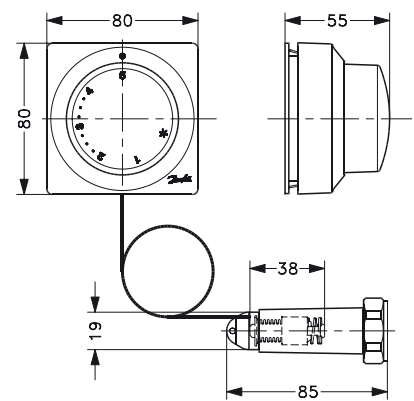

RA2000 remote temperature adjuster

Type	ISO 7-1		L <sub>1</sub>	L <sub>2</sub>	L <sub>3</sub>	L <sub>4</sub>	L <sub>5</sub>	L <sub>6</sub>	L <sub>7</sub>	L <sub>8</sub>	L <sub>9</sub>	L <sub>10</sub>	Arc. flats	
	D	d <sub>2</sub>											S <sub>1</sub>	S <sub>2</sub>
RA-FN 10	Rp 3/8	R 3/8	60	85	27	52	22	47	96				22	27
RA-FN 10 horiz.	Rp 3/8	R 3/8						61	110	26	51	22	22	27
RA-FN 15	Rp 1/2	R 1/2	67	95	30	58	26	47	96				27	30
RA-FN 15 horiz.	Rp 1/2	R 1/2						60	111	29	57	27	27	30
RA-FN 20	Rp 3/4	R 3/4	74	106	34	66	29	47	96				32	37
RA-FN 20 horiz.	Rp 3/4	R 3/4						61	110	34	66	30	32	37
RA-FN 25	Rp 1	R 1	90	125	40	75	34	52	101				41	46
RA-G 15	Rp 1/2	R 1/2	68	96	30	58	27	50	99				27	30
RA-G 20	Rp 3/4	R 3/4	74	106	34	66	30	50	99				32	37
RA-G 25	Rp 1	R 1	90	126	42	78	34	54	103				41	46

**Danfoss A/S**

Heating Segment  
Haarupvaenget 11  
8600 Silkeborg  
Denmark

Phone: +45 7488 8000

Fax: +45 7488 8100

Email: [heating.solutions@danfoss.com](mailto:heating.solutions@danfoss.com)

www.heating.danfoss.com

Danfoss can accept no responsibility for possible errors in catalogues, brochures and other printed material. Danfoss reserves the right to alter its products without notice. This also applies to products already on order provided that such alterations can be made without subsequential changes being necessary in specifications already agreed.  
All trademarks in this material are property of the respective companies. Danfoss and the Danfoss logotype are trademarks of Danfoss A/S. All rights reserved.