

Data Sheet

Fixed Capacity Valves Type RA-FN (Series D)

Application



RA-FN straight



RA-FN angle



RA-FN horizontal angle

The RA-FN valve bodies are used in two-pipe heating systems.

The valves are manufactured from brass with nickel plating. The pressure pin of the gland seal is of chromium steel and works in a lifetime lubricated O-ring seal. The complete gland assembly can be replaced without draining down the system.

The valves are supplied with a grey protective cap, which can be used for manual regulation during the construction phase. The protective cap must not be used as a manual shut off device. A special manual shut off device (code no. 013G3300) should be used.

Compression fittings for 15 mm, 10 mm or 8 mm copper tube are available for RA-FN with 3/8" and 1/2" connections.

In order to avoid deposition and corrosion, the composition of the hot water must be in accordance with the VDI 2035 guideline (Verein Deutscher Ingenieure).

It is recommended that formulations containing mineral oil are avoided.

All RA-FN valve bodies can be used together with all types of thermostatic elements in the Danfoss RA2000 series.

Approved to EN 215



All Danfoss RA-FN (series D) fixed capacity valves are manufactured to the highest standards, and are approved to the European Standard EN 215.

Code Nos. and Technical Data

Valve bodies for two-pipe systems type RA-FN (series D)

Type	Design	Connections		k _v -value ¹⁾ (m ³ /h at 1 bar pressure drop), P-band = K					Max. working temp.	Code no.
		Inlet	Outlet	0.5K	1.0K	1.5K	2.0K	k _{v5}		
RA-FN 10	angle	Rp 3/8	R 3/8	0.17	0.34	0.47	0.56	0.65	120 °C	013G0021
RA-FN 10	straight	Rp 3/8	R 3/8	0.17	0.34	0.47	0.56	0.65	120 °C	013G0022
RA-FN 10	horizontal	Rp 3/8	R 3/8	0.17	0.34	0.47	0.56	0.65	120 °C	013G0141
RA-FN 15	angle	Rp 1/2	R 1/2	0.22	0.43	0.57	0.73	0.90	120 °C	013G0023
RA-FN 15	straight	Rp 1/2	R 1/2	0.22	0.43	0.57	0.73	0.90	120 °C	013G0024
RA-FN 15	horizontal	Rp 1/2	R 1/2	0.22	0.43	0.57	0.73	0.90	120 °C	013G0143
RA-FN 20	angle	Rp 3/4	R 3/4	0.30	0.58	0.83	1.04	1.40	120 °C	013G0025

RA-FN 20	straight	Rp 3/4	R 3/4	0.30	0.58	0.83	1.04	1.40	120 °C	013G0026
RA-FN 20	horizontal	Rp 3/4	R 3/4	0.25	0.50	0.67	0.80	1.00	120 °C	013G0145
RA-FN 25	angle	Rp 1	R 1	0.30	0.58	0.83	1.04	1.40	120 °C	013G0027
RA-FN 25	straight	Rp 1	R 1	0.30	0.58	0.83	1.04	1.40	120 °C	013G0028

Max. working pressure²⁾: 10 bar. Max. differential pressure: 0.6 bar Test pressure: 16 bar

- 1) The k_v -value indicates the water flow (Q) in m³/h at a pressure drop (Δp) across the valve of 1 bar;

$$K_v = Q : \sqrt{\Delta p}$$
 The k_v -value is stated according to EN 215, at $Xp = 2K$ i.e. the valve is closed at 2°C higher room temperature. At lower settings the Xp value is reduced to 0.5K. The k_{vs} -value states the flow Q at a maximum lift, i.e. at fully open valve.
- 2) Working pressure = static + differential pressure. The maximum differential pressure specified is the maximum pressure at which the valves give satisfactory regulation. As with any device which imposes a pressure drop in the system, noise may occur under certain flow/pressure conditions. To ensure quiet operation, maximum pressure drop should not exceed 30 to 35 kPa. The differential pressure can be reduced by the use of the Danfoss differential pressure regulators types AVD, AVDL, AVDS, IVD or ASV-P.

System

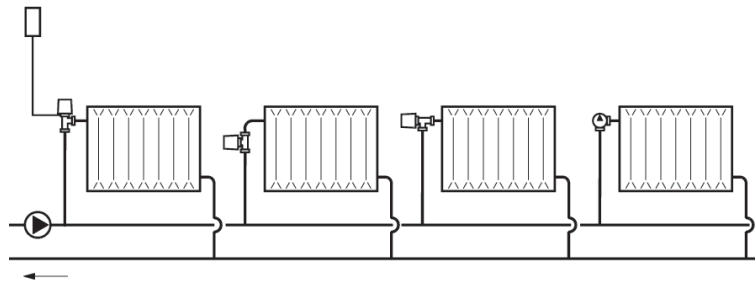

Capacities

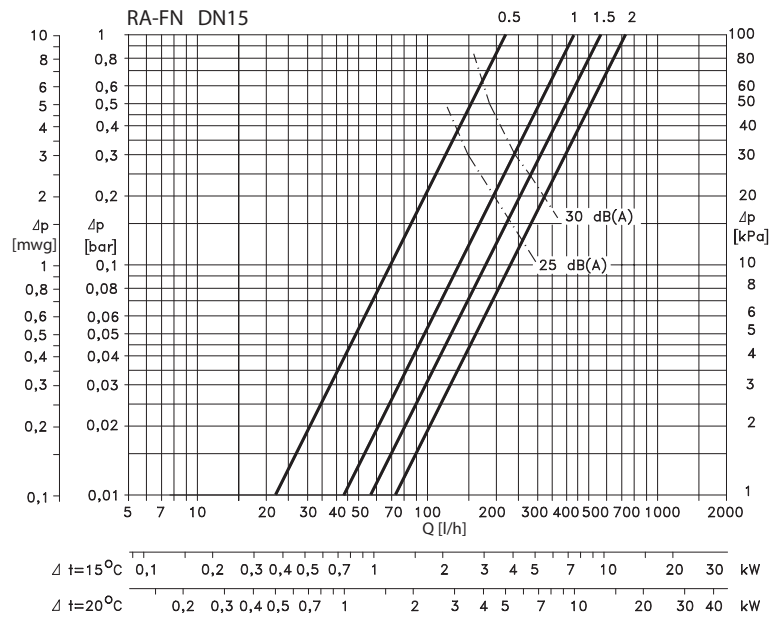
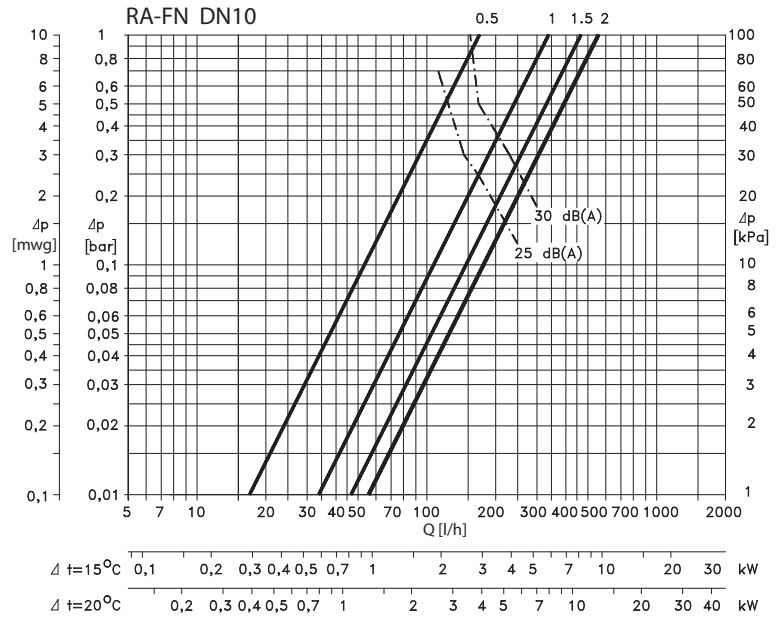

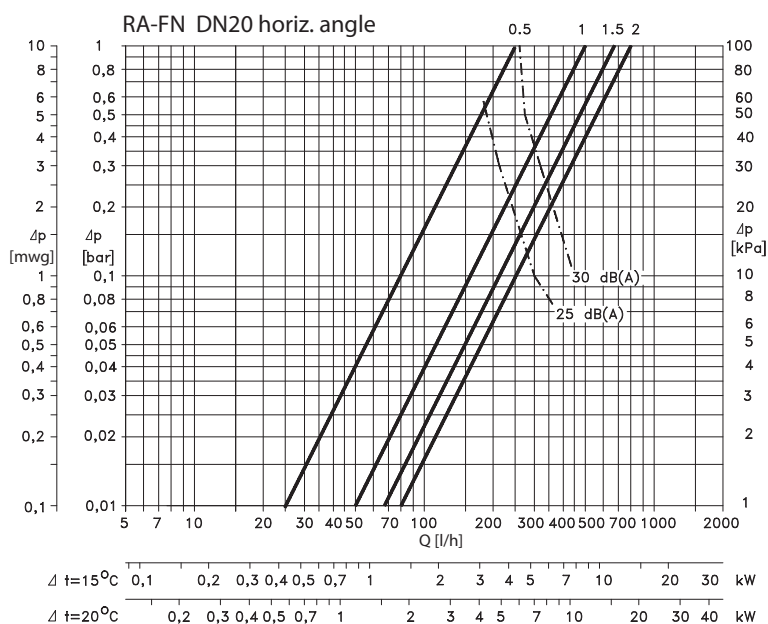
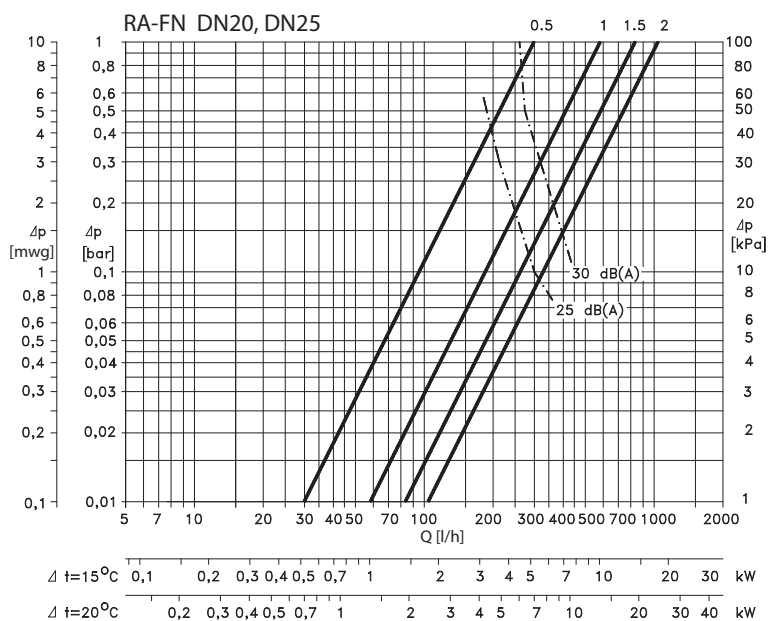

Note:

As with any device which imposes a pressure drop in the system, noise may occur under certain flow/pressure conditions.

To ensure quiet operation, maximum pressure drop should not exceed 30-35 kPa (3-3.5 mwg).

Design

A radiator thermostat consist of a thermostatic element of the RA 2000 series and a RA-FN valve.

The element and the valve body are ordered separately.

Materials in contact with water	
Valve body and other metal parts	Ms 58, brass
O-ring	EPDM
Valve cone	NBR
Pressure pin and valve spring	Chrome/Steel
Nozzle	PP

- 1. Gland seal
- 2. O-Ring
- 3. Pressure pin
- 4. Seal
- 5. Regulation spring
- 7. Valve body
- 8. k_v -nozzle

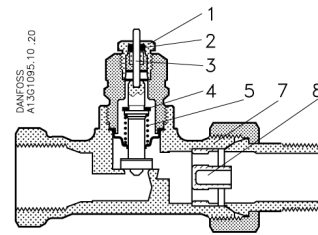

The RA-FN valves are nickle-plated on the outside.

Dimensions

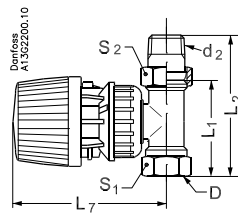

Straight valve with thermostatic sensor RA 2990

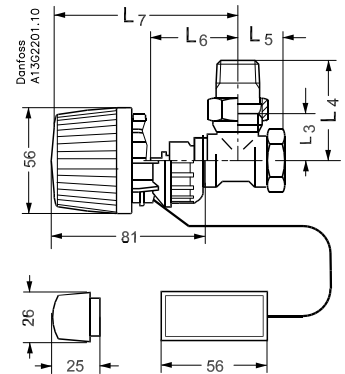

Angle valve with thermostatic sensor RA2992

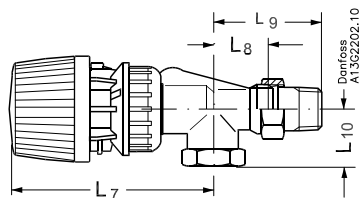

Horizontal angle valve with thermostatic sensor RA 2990

Type	ISO 7-1		L ₁	L ₂	L ₃	L ₄	L ₅	L ₆	L ₇	L ₈	L ₉	L ₁₀	Arc. flats	
	D	d ₂											S ₁	S ₂
RA-FN 10	Rp 3/8	R 3/8	60	85	27	52	22	47	96				22	27
RA-FN 10 horiz.	Rp 3/8	R 3/8						61	110	26	51	22	22	27
RA-FN 15	Rp 1/2	R 1/2	67	95	30	58	26	47	96				27	30
RA-FN 15 horiz.	Rp 1/2	R 1/2						62	111	29	57	27	27	30
RA-FN 20	Rp 3/4	R 3/4	74	106	34	66	29	47	96				32	37
RA-FN 20 horiz.	Rp 3/4	R 3/4						63	110	34	66	30	32	37
RA-FN 25	Rp 1	R 1	90	125	40	75	34	47	101				41	46

Danfoss A/S
Heating Solutions
Haarupvaenget 11
8600 Silkeborg
Denmark
Phone: +45 7488 8000
Fax: +45 7488 8100
Email: heating.solutions@danfoss.com
www.heating.danfoss.com

Danfoss can accept no responsibility for possible errors in catalogues, brochures and other printed material. Danfoss reserves the right to alter its products without notice. This also applies to products already on order provided that such alterations can be made without subsequential changes being necessary in specifications already agreed. All trademarks in this material are property of the respective companies. Danfoss and the Danfoss logotype are trademarks of Danfoss A/S. All rights reserved.
