

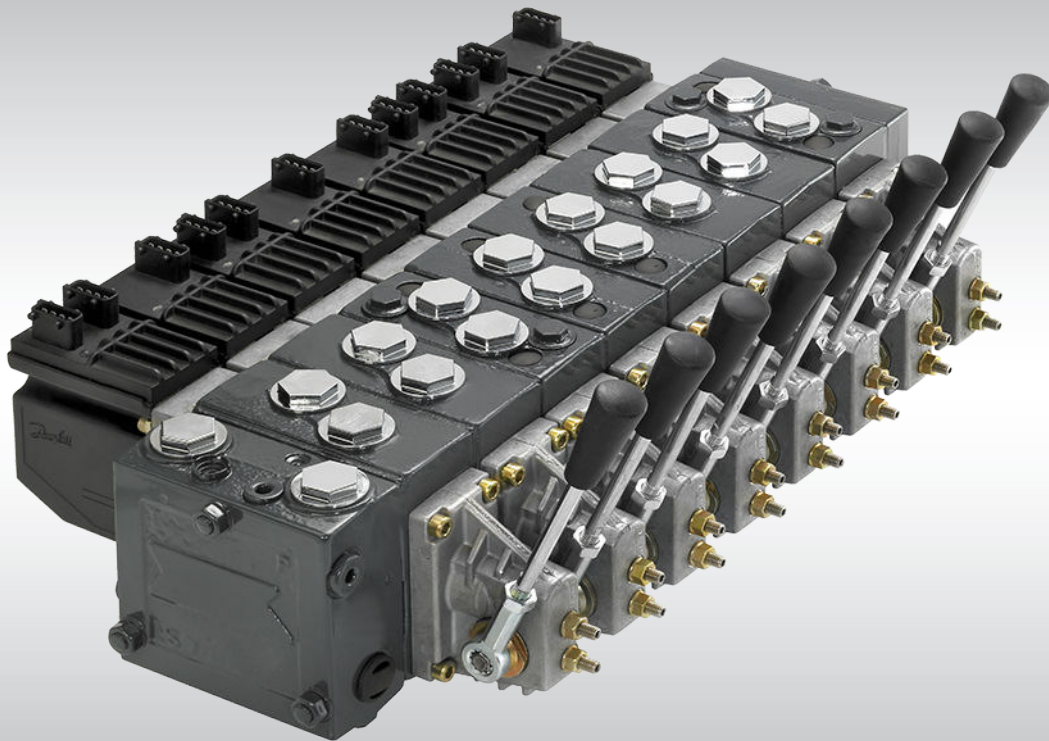

Technical Information

Proportional Valve Group PVG 32 Order Specifications



Revision History*Table of Revisions*

Date	Changed	Rev
Feb 2014	Converted to Danfoss layout – DITA CMS	JD
Feb 2006 - Jan 2012	Various changes	AB - JC
Jan 2005	New Edition	AA

Contents**Order specification**

Please state:.....	4
Standard and option assembly.....	4
Reordering.....	4
Pressure setting limits.....	4
PVG 32 order specification form.....	6

Module selection chart

Standard FC spools.....	7
Standard FC spools, hydraulic actuation.....	8
FC spools for mechanical float position, PVMF.....	8
FC spools for friction detent, PVMR.....	8
FC spools with linear flow characteristic	9
Standard PC spools	10
Standard PC spools, hydraulic actuation.....	11
PVB, basic valves.....	12
PVP, pump side module.....	13
PVE, electrical actuation.....	15

Order specification

The form can be obtained from the Danfoss Sales Organization. An order form for PVG 32 hydraulic valve is shown on the page [PVG 32 order specification](#).

Both the module selection chart on the previous pages and the order form are divided into fields 0, 1-1-12, 13, 14, 15, a, b, and c.

Each module has its own field:

0:

- Pump side module PVP
- Plug for external pilot oil supply PVPC
- Electrical LS unloading valve PVPX

1-12: Basic valves PVB

13: Main spool PVBS

a: Mechanical actuator PVM (or PVE when option mounted)

b:

- Shock and suction valve PVLP
- Suction valve PVLA

c:

- Cover for mechanical actuation PVMD
- Cover for hydraulic actuation PVH
- Electrical actuators PVE (or PVM when option mounted)

14: End plate PVS

15: Assembly kit PVAS

Please state:

- Code numbers of all modules required
- Required setting (P) for pump side module
- Required setting of LS_{A/B} pressure limiting valves, see pressure setting guidance below.

Standard and option assembly

The PVG 32 valve group is assembled the way the module selection chart shows if the code number for PVM is written in field 'a', and the code number for PVMD, PVE or PVH in field 'c'.

The valve group is assembled so that the mechanical actuator is mounted on the opposite end of the basic module, if the code number for PVM is written in field 'c' of the order form and the code numbers for PVMD, PVE or PVH in field 'a'.

Reordering

The space at the top right-hand corner of the form is for Danfoss to fill in. The code number for the whole of the specified valve group (PVG No.) is entered here.

In the event of a repeat order all you have to do is enter the number Danfoss has given on the initial confirmation of order.

Pressure setting limits

The maximum setting pressure for the pressure limiting valves LS_A or LS_B depends on the chosen pressure setting for shock valve PVLP. The maximum values recommended to avoid interaction can be read in the following table.

Technical Information PVG 32 Order Specifications

Order specification

The figures in the table have been calculated according to the following expressions:

- $PVLP \leq 150 \text{ bar}$: $LS_{A/B} \leq 0.8 \times P_{PVLP}$
- $PVLP > 150 \text{ bar}$: $P_{PVLP} - LS_{A/B} \geq 30 \text{ bar}$.

Max. pressure setting of LS_A and LS_B valves relative to PVLP shock valve

Pressure setting for PVLP	bar	32	50	63	80	100	125	140	150	160	175	190	210	230	240	250	265	280	300	320	350	380	400
	psi	460	725	914	1160	1450	1813	2031	2175	2320	2838	2755	3045	3335	3480	3625	3843	4061	4351	4641	5075	5511	5801
Max. for $LS_{A/B}$	bar	-	40	50	64	80	100	112	120	130	145	160	180	200	210	220	235	250	270	290	320	350	370
	psi	-	580	720	930	1160	1450	1625	1740	1885	2100	2320	2610	2900	3045	3190	3408	3625	3915	4205	4641	5075	5366
Min. for $LS_{A/B}$	30 bar [435 psi]																						

Order specification

PVG 32 order specification form

	PVG 32 Specification Sheet
Subsidiary / Dealer	PVG No.
Customer	Customer No.
Application	Revision No.

	Function	A-port		B-port
0	Inlet		P = bar	
1	a	f	LS _A = bar LS _B = bar	e
	b			c
2	a	f	LS _A = bar LS _B = bar	e
	b			c
3	a	f	LS _A = bar LS _B = bar	e
	b			c
4	a	f	LS _A = bar LS _B = bar	e
	b			c
5	a	f	LS _A = bar LS _B = bar	e
	b			c
6	a	f	LS _A = bar LS _B = bar	e
	b			c
7	a	f	LS _A = bar LS _B = bar	e
	b			c
8	a	f	LS _A = bar LS _B = bar	e
	b			c
9	a	f	LS _A = bar LS _B = bar	e
	b			c
10	a	f	LS _A = bar LS _B = bar	e
	b			c
11	a	f	LS _A = bar LS _B = bar	e
	b			c
12	a	f	LS _A = bar LS _B = bar	e
	b			c
13	a	f	LS _A = bar LS _B = bar	e
	b			c
14	a	f	LS _A = bar LS _B = bar	e
	b			c
15	End section			
16	PVAS section			
17	Reserved for painting			

Comments
Filled in by _____ Date _____

Separate specification pads are available under the literature no. **520L0515**.

Module selection chart
Standard FC spools

PVB is with LS _{A/B} shuttle valve							Code number 157B....		PVB is without LS _{A/B} shuttle valve						
Press. compensated flow: l/min [US gal/min]							ISO symbol	Symbol	Press. compensated flow l/min [US gal/min]						
F	E	D	C	B	A	AA			AA	A	B	C	D	E	F
130 [34.3]	100 [26.4]	65 [17.2]	40 [10.6]	25 [6.6]	10 [2.6]	5 [1.3]			5 [1.3]	10 [2.6]	25 [6.6]	40 [10.6]	65 [17.2]	100 [26.4]	130 [34.3]
7026	7024	7023	7022	7021	7020	7025	 157-02.10	 157-26.10	7005	7000	7001	7002	7003	7004	7006
7126	7124	7123	7122	7121	7120	7125	 157-03.10	 157-27.10	7105	7100	7101	7102	7103	7104	7106
-	-	-	-	-	-	-	 157-04.10	 157-28.10	-	7200	7201	7202	7203	7204	-
-	-	-	-	-	-	-	 157-05.10	 157-29.10	-	-	7301	7302	7303	7304	-
-	7424	7423	7422	7421	-	-	 157-06.10	 157-30.10	-	-	7401	7402	7403	7404	7406
-	7524	7523	7522	7521	-	-	 157-07.10	 157-31.10	-	-	7501	7502	7503	7504	-
-	7624	7623	7622	7621	7620	-	 157-139.10	 157-140.10	-	-	-	-	-	-	-



Technical Information PVG 32 Order Specifications

Module selection chart

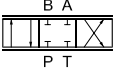
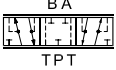
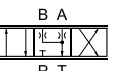
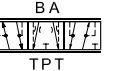
Standard FC spools, hydraulic actuation

PVB is with LS _{A/B} shuttle valve							Code number 157B....		PVB is without LS _{A/B} shuttle valve						
Press. compensated flow: l/min [US gal/min]							ISO symbol	Symbol	Press. compensated flow: l/min [US gal/min]						
E	D	C	B	A	AA				AA	A	B	C	D	E	
100 [26.4]	65 [17.2]	40 [10.6]	25 [6.6]	10 [2.6]	5 [1.3]				5 [1.3]	10 [2.6]	25 [6.6]	40 [10.6]	65 [17.2]	100 [26.4]	
9024	9023	9022	9021	9020	9025	  157-02.10 157-117.10 4-way, 3-position closed neutral position		9005	9000	9001	9002	9003	9004		
9124	9123	9122	9121	9120	9125	  157-03.10 157-118.10 4-way, 3-position Throttled open neutral position		9105	9100	9101	9102	9103	9104		

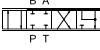
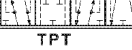
FC spools for mechanical float position, PVMF

PVB is with LS _{A/B} shuttle valve							Code number 157B....		PVB is without LS _{A/B} shuttle valve						
Press. compensated flow: l/min [US gal/min]							ISO symbol	Symbol	Press. compensated flow l/min [US gal/min]						
F	E	D	C	B	A	AA			AA	A	B	C	D	E	F
130 [34.3]	100 [26.4]	65 [17.2]	40 [10.6]	25 [6.6]	10 [2.6]	5 [1.3]			5 [1.3]	10 [2.6]	25 [6.6]	40 [10.6]	65 [17.2]	100 [26.4]	130 [34.3]
-	9824	9823	9822	9821	9820	9825	  157-09.10 157-464.10 4-way, 4 position Closed neutral position P → A → F		-	-	-	-	-	-	-
-	9624	623	9622	9621	-	-	  157-139.10 157-140.10 4-way, 4-position Closed neutral position Float P → B → F		-	-	-	-	-	-	-

FC spools for friction detent, PVMR

PVB is with LS _{A/B} shuttle valve							Code number 157B....		PVB is without LS _{A/B} shuttle valve						
Press. compensated flow: l/min [US gal/min]							ISO symbol	Symbol	Press. compensated flow: l/min [US gal/min]						
E	D	C	B	A	AA				AA	A	B	C	D	E	
100 [26.4]	65 [17.2]	40 [10.6]	25 [6.6]	10 [2.6]	5 [1.3]				5 [1.3]	10 [2.6]	25 [6.6]	40 [10.6]	65 [17.2]	100 [26.4]	

Technical Information PVG 32 Order Specifications







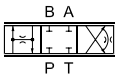
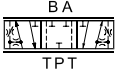
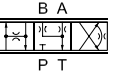

Module selection chart

PVB is with LS _{A/B} shuttle valve							Code number 157B....		PVB is without LS _{A/B} shuttle valve					
9724	9723	9722	9721	9720	-	-	 157-02.10	 157-117.10	-	9700	9701	9702	9703	9704
							4-way, 3-position closed neutral position							
9734	9733	9732	9731	9730	-	-	 157-03.10	 157-118.10	-	9710	9711	9712	9713	9714
							4-way, 3-position Throttled open neutral position							

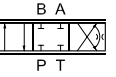
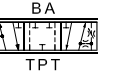
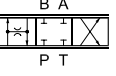
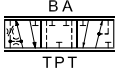
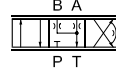
FC spools with linear flow characteristic

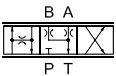
PVB is with LS _{A/B} shuttle valve							Code number 157B....		PVB is without LS _{A/B} shuttle valve						
Press. compensated flow: l/min [US gal/min]							ISO symbol	Symbol	Press. compensated flow: l/min [US gal/min]						
F	E	D	C	B	A	AA			AA	A	B	C	D	E	F
130 [34.3]	100 [26.4]	65 [17.2]	40 [10.6]	25 [6.6]	10 [2.6]	5 [1.3]			AA 5 [1.3]	A 10 [2.6]	B 25 [6.6]	C 40 [10.6]	D 65 [17.2]	E 100 [26.4]	F 130 [34.3]
-	9774	9773	9772	9771	-	-	 157-02.10	 157-26.10	-	9750	9751	9752	9753	9754	-
							4-way, 3-position Closed neutral position								
-	9784	9783	9782	9781	-	-	 157-03.10	 157-27.10	-	9760	9761	9762	9763	9764	-
							4-way, 3-position Throttled, open neutral position								
-	-	-	-	-	-	-	 157-06.10	 157-30.10	-	-	-	-	-	9794	-
							4-way, 3-position Throttled, A → T in neutral position								
-	-	-	-	-	-	-	 157-07.10	 157-31.10	-	-	-	-	-	9804	-
							4-way, 3-position B → T in neutral position								

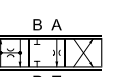
Module selection chart
Standard PC spools

PVB is with LS _{A/B} shuttle valve						Code number 157B....		PVB is without LS _{A/B} shuttle valve					
Press. compensated flow: l/min [US gal/min]						ISO symbol	Symbol	Press. compensated flow: l/min [US gal/min]					
E	D	C	B	A	AA			AA	A	B	C	D	E
100 [26.4]	65 [17.2]	40 [10.6]	25 [6.6]	10 [2.6]	5 [1.3]			5 [1.3]	10 [2.6]	25 [6.6]	40 [10.6]	65 [17.2]	100 [26.4]
-	7033	7032	7031	7030	7035	  157-143.10 157-121.10		7015	7010	7011	7012	7013	-
7134	7133	7132	7131	7130	7135	  157-146.10 157-128.10		7115	7110	7111	7112	7113	-
7064	7063	7062	7061	-	-	  157-144.10 157-123.10		-	7040	7041	7042	7043	7044
7074	7073	7072	7071	-	-	  157-145.10 157-122.10		-	7050	7051	7052	7053	7054
7164	7163	7162	7161	-	-	  157-147.10 157-130.10		-	7150	7151	7152	7153	7154
7174	7173	7172	7171	-	-	  157-148.10 157-132.10		-	7150	7151	7152	7153	7154
-	7473	7472	7471	7470	-	  157-149.10 157-142.10		-	-	-	7452	7453	-

Technical Information PVG 32 Order Specifications

Module selection chart

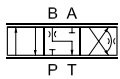
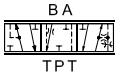
PVB is with LS _{A/B} shuttle valve						Code number 157B...		PVB is without LS _{A/B} shuttle valve					
-	7563	7562	-	-	-	 157-167,10	 157-188,10	-	-	7541	7542	7543	-
						4-way, 3-position Throttled, B → T neutral position, PC → A							

Standard PC spools, hydraulic actuation

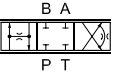
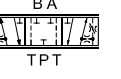
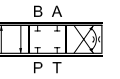
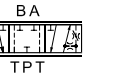
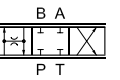
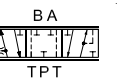
PVB is with LS _{A/B} shuttle valve						Code number 157B...		PVB is without LS _{A/B} shuttle valve							
Press. compensated flow: l/min [US gal/min]						ISO symbol		Symbol		Press. compensated flow: l/min [US gal/min]					
E	D	C	B	A	AA					AA	A	B	C	D	E
100	65	40	25	10	5					5	10	25	40	65	100
[26.4]	[17.2]	[10.6]	[6.6]	[2.6]	[1.3]					[1.3]	[2.6]	[6.6]	[10.6]	[17.2]	[26.4]
-	-	-	-	-	-	 157-143,10	 157-121,10	9015	9010	9011	9012	-	-	-	-
						4-way, 3-position Closed neutral position, PC → A and B									
-	-	-	-	-	-	 157-144,10	 157-123,10	-	-	-	9042	9043	9044	-	-
						4-way, 3-position Closed neutral position, PC → A									
-	-	-	-	-	-	 157-145,10	 157-122,10	-	-	-	9052	9053	9054	-	-
						4-way, 3-position Closed neutral position, PC → B									

Module selection chart

PVB, basic valves

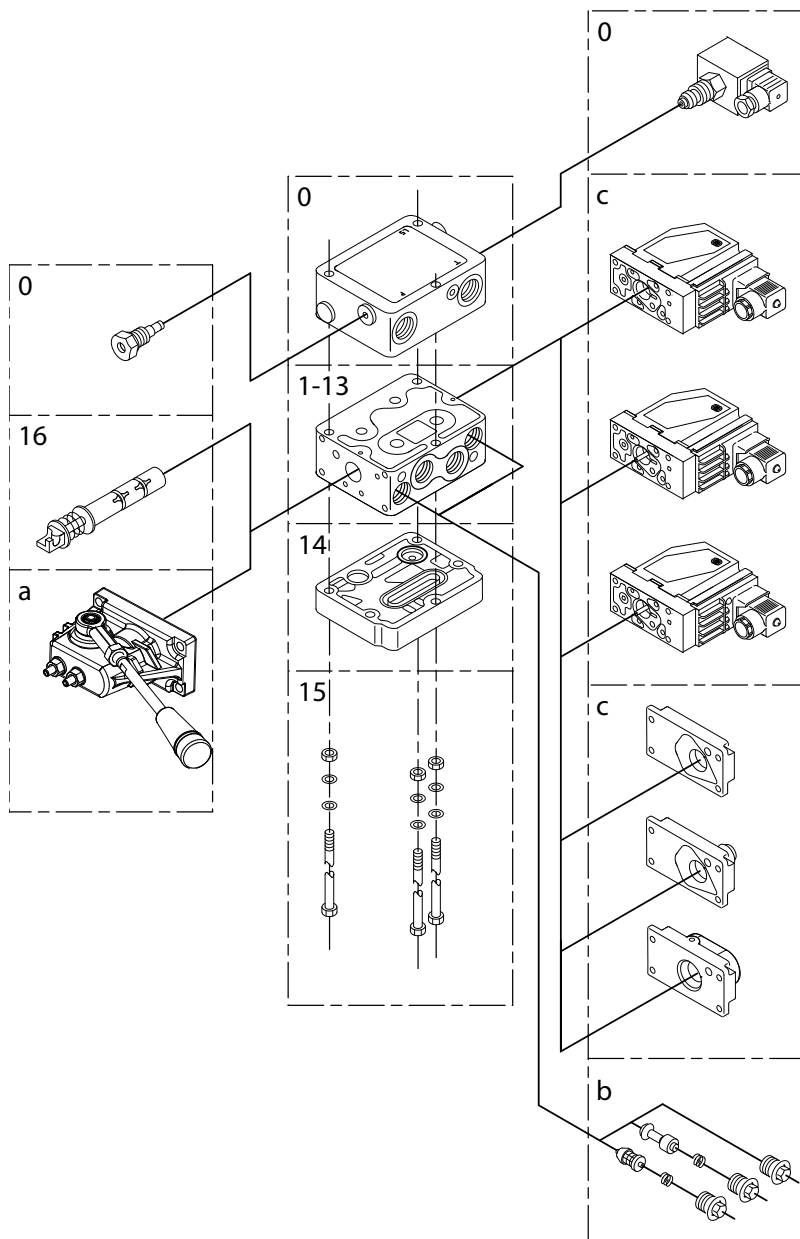

V310168.A

PVB, basic valves

Description	No facilities for shock valves A and B		Facilities for shock valves A and B	
	G ½	7/8 - 14 UNF	G ½	7/8 - 14 UNF
Without compensator /check valve	157B6000	157B6400	157B6030	157B6430
With check valve	157B6100	157B6500	157B6130	157B6530
With check valve and LSA/B shuttle valve	-	-	157B6136	157B6536
With compensator valve	157B6200	157B6600	157B6230	157B6630

Technical Information PVG 32 Order Specifications
Module selection chart
PVB, basic valves (continued)

Description	No facilities for shock valves A and B		Facilities for shock valves A and B	
	G ½	7/8 - 14 UNF	G ½	7/8 - 14 UNF
With damped compensator valve	157B6206	-	157B6236	-
With compensator valve, LSA/B relief valve and LSA/B shuttle valve	157B6203	157B6603	157B6233	157B6633
With damped compensator valve, LSA/B relief valve and LSA/B shuttle valve	157B6208	-	157B6238	-
Weight	kg [lb]	3.1 [6.8]	3.0 [6.6]	

PVPC, plugs

Description	G ½	½ in - 20	Weight	
			kg	[lb]
External pilot supply	157B5400	—	0.05	0.1
External pilot supply incl. check valve	157B5600	157B5700	0.05	0.1

PVM, mechanical actuation

Description	Alu		Alu anodized	Cast iron	Angle
	with stop screws	without stop screws	with stop screws	with stop screws	
Standard	157B3171	157B3191	157B3184	157B3161	22,5°/37,5°
Standard with base, without arm and button	157B3174	157B3194	—	—	22,5°/37,5°
Standard without base, without arm and button	157B3173	157B3193	157B3186	—	—
Weight kg [lb]	0.4 [0.9]			0.8 [1.8]	

PVAS, assembly kit

Code no. 157B....	0	1	2	3	4	5	6	7	8	9	10	11	12
PVB's	8000	8001	8002	8003	8004	8005	8006	8007	8008	8009	8010	8061	8062
PVB + PVPVM	-	8021	8022	8023	8024	8025	8026	17B8027	8028	8029	8030	8081	8082
Weight kg [lb]	0.1 [0.2]	0.15 [0.3]	0.25 [0.6]	0.30 [0.7]	0.40 [0.9]	0.45 [1.0]	0.50 [1.1]	0.60 [1.3]	0.65 [1.4]	0.70 [1.6]	0.80 [1.7]	0.85 [1.8]	0.9 [2.0]

PVP, pump side module
PVP, pump side module

Description		Without pilot supply		With pilot supply			
		for PVE	for PVE with facilit. for PVPX	for PVE	for PVE and facilit. for PVPX	for PVE and pilot oil pressure take-off	for PVH and pilot oil pressure take-off
Open center	P = G1/2, T = G3/4	157B5000	-	157B5010	157B5012	-	-
	P = 7/8 -14, T = 11/16 -12	157B5200	-	157B5210	157B5212	-	-

Technical Information PVG 32 Order Specifications
Module selection chart
PVP, pump side module (continued)

Description		Without pilot supply		With pilot supply			
		for PVE	for PVE with facilit. for PVPX	for PVE	for PVE and facilit. for PVPX	for PVE and pilot oil pressure take-off	for PVH and pilot oil pressure take-off
	P = G3/4, T = G3/4	157B5100	157B5102	157B5110	157B5112	157B5180	157B5190
	P = 1 1/16 -12, T = 11/16 -12	157B5300	-	157B5310	157B5312	157B5380	157B5390
Closed center	P = G1/2, T = G3/4,	157B5001	-	157B5011	157B5013	-	-
	P = 7/8 -14, T = 11/16 -12	157B5201	-	157B5211	157B5213	-	-
	P = G3/4, T = G3/4,	157B5101	157B5103	157B5111	157B5113	157B5181	157B5191
	P = 11/16 -12, T = 1 1/16 -12	157B5301	-	157B5311	157B5313	157B5381	157B5391
Weight	kg [lb]	3 [6.6]					

PVPX, electrical LS pressure relief valves

Description/ Supply voltage		Code No. Hirsch.	Code No. AMP	Weight kg [lb]
Normally open	12 V	157B4236	157B4981	0.3 [0.7]
	24 V	157B4238	157B4982	
Normally closed	12 V	157B4246	157B4983	
	24 V	157B4248	157B4984	
Normally open with manual override	12 V	157B4256	157B4985	
	24 V	157B4258	157B4986	
Plug		157B5601		0.06 [.13]

PVS and PVS1, end plate

Description		BSP	SAE	Weight kg [lb]
PVS, without connections		157B2000	157B2020	0.5 [1.1]
PVS, with LX connection G 1/8 [3/8 -24 UNF]		157B2011	157B2021	
PVS1, without connections		157B2014	157B2004	1.7 [3.6]
PVS1, with LX connections G 1/4 [1/2 -20 UNF]		157B2015	157B2005	

PVLP, shock/ and anti-cavitation valves

Code no.	157B203 2	157B205 0	157B206 3	157B208 0	157B210 0	157B212 5	157B214 0	157B215 0	157B216 0	157B217 5	157B219 0	
Settings	bar	32	50	63	80	100	125	140	150	160	175	190
	psi	460	725	914	1160	1450	1813	2031	2175	2320	2538	2755

Code no.	157B221 0	157B223 0	157B224 0	157B225 0	157B226 5	157B228 0	157B230 0	157B232 0	157B235 0	157B238 0	157B240 0	
Settings	bar	210	230	240	250	265	280	300	320	350	380	400
	psi	3045	3335	3480	3625	3845	4061	4351	4641	5075	5511	5801

Technical Information PVG 32 Order Specifications
Module selection chart
PVE, electrical actuation
PVE, electrical actuation

Description		Code No.			Weight kg [lb]
		Hirsch	AMP	Deut.	
PVEO, on-off	12 V	157B4216	157B4901	157B4291	0.6 [1.3]
	24 V	157B4228	157B4902	157B4292	
PVEO-R, on/off	12 V	157B4217	157B4903	-	
	24 V	157B4229	157B4904	-	
PVEM, prop. medium – Standard	12 V	157B4116	-	-	0.9 [2.0]
	24 V	157B4128	-	-	
PVEM, prop. medium – Float –> B	12 V	157B4416	-	-	1.0 [2.2]
	24 V	157B4428	-	-	
PVEA, active fault mon.		-	157B4734	157B4792	0.9 [2.0]
PVEA, passive fault mon.		-	157B4735	-	
PVEA-DI, active fault mon.		-	157B4736	157B4796	
PVEA-DI, passive fault mon.		-	157B4737	-	
PVEH active fault mon.		157B4032	157B4034	157B4092	1.0 [2.2]
PVEH passive fault mon.		157B4033	157B4035	157B4093	
PVEH float –> B, act. fault		157B4332	-	157B4392	
PVEH float –> A, act. fault		-	157B4338	-	
PVEH- DI active fault mon.		-	157B4036	157B4096	
PVEH - DI passive fault mon.		-	157B4037	-	
PVES, active fault mon.		157B4832	157B4834	157B4892	
PVES, passive fault mon.		157B4833	157B4835	-	

PVMD, PVMR, PVMF, PVH covers

Description	Code No.	Material	Anodized	Weight
				kg [lb]
PVMD Cover for PVB	157B0001	aluminium	no	0.1 [0.2]
	157B0009		yes	
	157B0021	cast iron	N/A	0.9 [2.0]
PVMR (Friction Detent)	157B0004	aluminium	no	0.3 [0.6]
	157B0012		yes	
	157B0024	cast iron	N/A	
PVMF (Mech. float position)	157B0005	aluminium	no	
Hydraulic actuation PVH 9/16-18 UNF	157B0007	aluminium	no	0.2 [0.4]
	157B0010		yes	
	157B0014	cast iron	N/A	
Hydraulic actuation PVH G1/4	157B0008	aluminium	no	0.9 [2.0]
	157B0011		yes	
	157B0016	cast iron	N/A	

Module selection chart

PVLA, anti-cavitation valve

Description	Code No.	Weight	
		kg	[lb]
Plug A or B	157B2002	0.04	0.09
Valve A or B	157B2001	0.05	0.1



Products we offer:

- Bent Axis Motors
- Closed Circuit Axial Piston Pumps and Motors
- Displays
- Electrohydraulic Power Steering
- Electrohydraulics
- Hydraulic Power Steering
- Integrated Systems
- Joysticks and Control Handles
- Microcontrollers and Software
- Open Circuit Axial Piston Pumps
- Orbital Motors
- PLUS+1® GUIDE
- Proportional Valves
- Sensors
- Steering
- Transit Mixer Drives

Danfoss Power Solutions is a global manufacturer and supplier of high-quality hydraulic and electronic components. We specialize in providing state-of-the-art technology and solutions that excel in the harsh operating conditions of the mobile off-highway market. Building on our extensive applications expertise, we work closely with our customers to ensure exceptional performance for a broad range of off-highway vehicles.

We help OEMs around the world speed up system development, reduce costs and bring vehicles to market faster.

Danfoss – Your Strongest Partner in Mobile Hydraulics.

Go to www.powersolutions.danfoss.com for further product information.

Wherever off-highway vehicles are at work, so is Danfoss.

We offer expert worldwide support for our customers, ensuring the best possible solutions for outstanding performance. And with an extensive network of Global Service Partners, we also provide comprehensive global service for all of our components.

Please contact the Danfoss Power Solution representative nearest you.

Comatrol

www.comatrol.com

Schwarz Müller-Inverter

www.schwarzmueller-inverter.com

Turolla

www.turollaocg.com

Valmova

www.valmova.com

Hydro-Gear

www.hydro-gear.com

Daikin-Sauer-Danfoss

www.daikin-sauer-danfoss.com

Local address:

Danfoss Power Solutions US Company
2800 East 13th Street
Ames, IA 50010, USA
Phone: +1 515 239 6000

Danfoss Power Solutions GmbH & Co. OHG
Krokamp 35
D-24539 Neumünster, Germany
Phone: +49 4321 871 0

Danfoss Power Solutions ApS
Nordborgvej 81
DK-6430 Nordborg, Denmark
Phone: +45 7488 2222

Danfoss Power Solutions (Shanghai) Co. Ltd.
Building #22, No. 1000 Jin Hai Rd
Jin Qiao, Pudong New District
Shanghai, China 201206
Phone: +86 21 3418 5200

Danfoss can accept no responsibility for possible errors in catalogues, brochures and other printed material. Danfoss reserves the right to alter its products without notice. This also applies to products already on order provided that such alterations can be made without subsequential changes being necessary in specifications already agreed. All trademarks in this material are property of the respective companies. Danfoss and the Danfoss logotype are trademarks of Danfoss A/S. All rights reserved.