

Application guide

**How to design**  
balancing and control solutions for  
**energy efficient hydronic applications**  
in residential and commercial buildings

44

applications with  
detailed descriptions  
about the investment,  
design, construction  
and control

# Content structure in this guide

## 1. Hydronic applications

### 1.1 Commercial

- 1.1.1 Variable flow
- 1.1.2 Constant flow

### 1.2 Residential

- 1.2.1 Two-pipe system
- 1.2.2 One-pipe system
- 1.2.3 Heating – special application

## 2. Mixing loop

## 3. AHU applications

- 3.1 AHU applications heating
- 3.2 AHU applications cooling

## 4. Chillers applications

## 5. Boiler applications

## 6. Hot water applications

## 7. Glossary and abbreviations

## 8. Control and valve theory

## 9. Energy efficiency analyses

## 10. Product overview

## Typical page shows you:

Chapter
Recommendation
Type of solution

Hydronic applications Commercial

Recommended

1.1.1.3

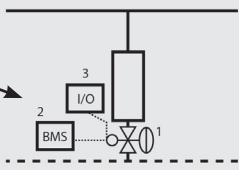

1. Pressure Independent Control Valve (PICV)  
2. Building Management System (BMS)  
3. Digital or Analogue Input/Output (I/O)

Temperature control of the terminal unit is ensured with pressure independent valves. This will ensure the right flow at all system loads, regardless of pressure fluctuations. The result will be stable\* and precise room temperature control to ensure a high  $\Delta T$  and prevent actuators from hunting. The additional features of digital, connected actuators will enable better system monitoring and reduce maintenance cost.

Applicable for all terminal units, included AHU (see page 34, 36)

Performance

Return of investment

poor

acceptable

excellent

Design

poor

acceptable

excellent

Operation/Maintenance

poor

acceptable

excellent

Control

poor

acceptable

excellent

10

Heating ■ Cooling ■

Variable flow: Pressure Independent Control (PICV) with digital actuator

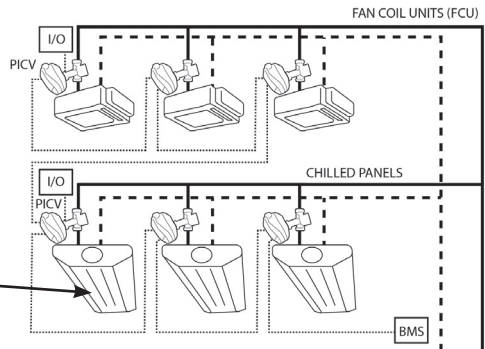

**Danfoss products:**



PICV: AB-QM 4.0 + NOVOCON S.

Explanation

Return of investment

- Reduction of components by eliminating the need for balancing valves
- Lower installation cost due to simplified installation
- Significant energy savings\* due to optimal working conditions for all components
- The higher cost for the SMART actuator can be offset by hardware savings like a reduced number of additional I/Os
- High occupant satisfaction because of perfect balance and control extended with predictive maintenance and pro-active alarm functions

Design

- Easy selection of valves based only on the flow requirement
- No Kv or authority calculation\* is needed, flow presetting calculation based on flow demand
- Proportional pump control is applicable. The pump(s) can be optimized easily \*
- Suitable for BMS applications to monitor the system and reduce energy usage
- Wide range of possible connected I/O devices ensures large number of BMS variants

Operation/Maintenance

- The full commissioning procedure can be run through BMS ensuring less complexity and high flexibility
- Low operational and upkeep cost because the system health can be monitored and maintained through BMS.
- High comfort (building classification) because of precise flow control at all loads
- High efficiency in chillers, boilers and pumping because of the optimized  $\Delta T$  in the system
- Flexible and expandable control system through BMS connectivity

Control

- No overflows at partial system loads
- Perfect control because of full authority \*
- Proportional control minimizes the flow circulation and optimized the pump head
- Pressure independent solution, so no pressure interdependency of the control circuits
- No low  $\Delta T$  syndrome \*

\*see page 54-55

# Introduction

Designing HVAC systems is not that simple. Many factors need to be considered before making the final decision about the heat- and/or cooling load, which terminal units to use, how to generate heating or cooling and a hundred other things.

This application guide is developed to help you make some of these decisions by showing the consequences of certain choices. For example, it could be tempting to go for the lowest initial cost (CAPEX) but often there would be compromises on other factors, like the energy consumption or the Indoor Air Quality (IAQ). In some projects the CAPEX might be the deciding factor but in another ones it is more about energy efficiency or control precision, therefore it differs from project to project. We collected the most important information concerning a particular solution on a single page with clear indications what consequences can be expected when certain choices are made.

The aim of this guide was not to cover each and every application because that would be impossible. Every day, smart designers come up with new solutions that might be relevant only to one specific problem or that is solving new problems. That is what engineers do. The drive for greener, more energy-friendly solutions is creating new challenges every day, so there are always some new applications. In this particular guide we will find to cover the applications that are the most common.

Danfoss also has many competent people available that can support you with specific challenges or that can support you with calculations. Please contact your local Danfoss office for support in your native language.

We hope this guide will help you in your daily work.

**Each application shown here is analyzed for four aspects:**

Return on Investment, Design, Operation/Maintenance, Control

### Return of investment



### Operation/Maintenance



### Design



### Control



**All of them are marked as:**

Technically and economically optimized solutions as recommended by Danfoss. This solution will result in efficiently operating systems.



**Recommended**

Depending on the situation and the particularities of the system this will result in a good installation. However, some trade-offs are made.



**Acceptable**

This system is not recommended since it will result in expensive and inefficient systems or the Indoor Air Quality is not ensured.



**Not Recommended**

# Notes

# Table of Contents

Content structure in this guide	2
Typical page shows you:	2
Introduction	3
<b>1. Hydronic applications</b>	
<b>1.1 Hydronic applications – commercial buildings</b>	6
<b>1.1.1 Commercial - Variable flow</b>	
1.1.1.1 Variable flow: Pressure Independent Control (PICV) with ON/OFF actuator	8
1.1.1.2 Variable flow: Pressure Independent Control (PICV) with proportional control	9
1.1.1.3 Variable flow: Pressure Independent Control (PICV) with digital actuator	10
1.1.1.4 Variable flow: Flow limitation (with flow limiter) on terminal unit with ON/OFF or modular actuator	11
1.1.1.5 Variable flow: Differential pressure control with ON/OFF or modulation	12
1.1.1.6 Variable flow: Shell and Core installation for Offices and Shopping malls*	13
1.1.1.7 Variable flow: Manual balancing	14
1.1.1.8 Variable flow: Manual balancing with reverse return	15
1.1.1.9 Variable flow: Four-pipe Changeover (CO6) for radiant heating/cooling panels, chilled beams, etc. with PICV control valve	16
1.1.1.10 Variable flow: Two-pipe heating/cooling system with central changeover*	17
<b>1.1.2 Commercial - Constant flow</b>	
1.1.2.1 Constant flow: 3-way valve with manual balancing (in fan-coil, chilled beam etc. application)	18
1.1.2.2 Constant flow: 3-way valve with flow limiter on terminal units (fan-coil, chilled beam etc. application)	19
<b>1.2 Hydronic applications - residential buildings</b>	
<b>1.2.1 Residential - Two pipes system</b>	
1.2.1.1 Two-pipe radiator heating system – risers with, thermostatic radiator valves (with presetting)	20
1.2.1.2 Two pipe radiator heating system – risers with, thermostatic radiator valves (without presetting)	21
1.2.1.3 Pressure Independent Control for radiator heating system	22
1.2.1.4 Subordinated risers (staircase, bathroom, etc.) in two- or one-pipe radiator heating system without thermostatic valve	23
1.2.1.5 $\Delta p$ control for manifold with individual zone/loop control	24
1.2.1.6 $\Delta p$ control and flow limitation for manifold with central zone control	25
<b>1.2.2 Residential - One pipe system</b>	
1.2.2.1 One-pipe radiator heating system renovation with automatic flow limitation and possible self-acting return temperature limitation	26
1.2.2.2 One-pipe radiator heating system renovation with electronic flow limitation and return temperature control	27
1.2.2.3 One-pipe radiator heating system renovation with manual balancing	28
1.2.2.4 One-pipe horizontal heating systems with thermostatic radiator valves, flow limitation and return temperature self-acting control	29
<b>1.2.3 Residential - Heating - special application</b>	
1.2.3.1 Three-pipe, flat station system; $\Delta p$ controlled heating and local DHW* preparation	30

<b>2. Mixing loop</b>	
2.1 Mixing with PICV – manifold with pressure difference	31
2.2 Injection (constant flow) control with 3-way valve	32
2.3 Mixing with 3-way valve – manifold without pressure difference	33
<b>3 AHU applications</b>	
<b>3.1 AHU applications - heating</b>	
3.1.1 Pressure Independent Control (PICV) for cooling	34
3.1.2 3-way valve control for cooling	35
<b>3.2 AHU applications - cooling</b>	
3.2.1 Pressure Independent Control (PICV) for heating	36
3.2.2 3-way valve control for heating	37
3.2.3 Keep proper flow temperature in front of AHU in partial load condition	38
<b>4. Chillers applications</b>	
4.1 Variable primary flow	39
4.2 Constant primary variable secondary (Step Primary)	40
4.3 Constant primary and variable secondary (Primary Secondary)	41
4.4 Constant primary & secondary (Constant Flow System)	42
4.5 District cooling system	43
<b>5. Boiler applications</b>	
5.1 Condensing boiler, variable primary flow	44
5.2 Traditional boilers, variable primary flow	45
5.3 System with manifolds de-couplers	46
<b>6. Domestic hot water</b>	
6.1 Thermal balancing in DHW circulation (vertical arrangement)	47
6.2 Thermal balancing in DHW circulation (horizontal loop)	48
6.3 Thermal balancing in DHW circulation with self-acting disinfection	49
6.4 Thermal balancing in DHW circulation with electronic disinfection	50
6.5 DHW* circulation control with manual balancing	51
<b>7. Glossary and abbreviations</b>	54
<b>8. Control and valve theory</b>	56
<b>9. Energy efficiency analyses</b>	65
<b>10. Product overview</b>	75

# Hydronic applications – commercial buildings

## Variable flow\* systems

### 1.1.1.1 - 1.1.1.6\*\*

Hydronic applications can be controlled and balanced based on a lot of different type of solutions. It is impossible to find the best one for all.

We have to take into consideration each system and its specific to decide what kind of solution will be the most efficient and suitable.

All applications with control valves are variable flow\* systems. Calculation is generally done based on nominal parameters but during operation flow in each part of the system is changing (control valves are working). Flow changes result in pressure changes. That's why in such case we have to use balancing solution that allows to respond to changes in partial load.

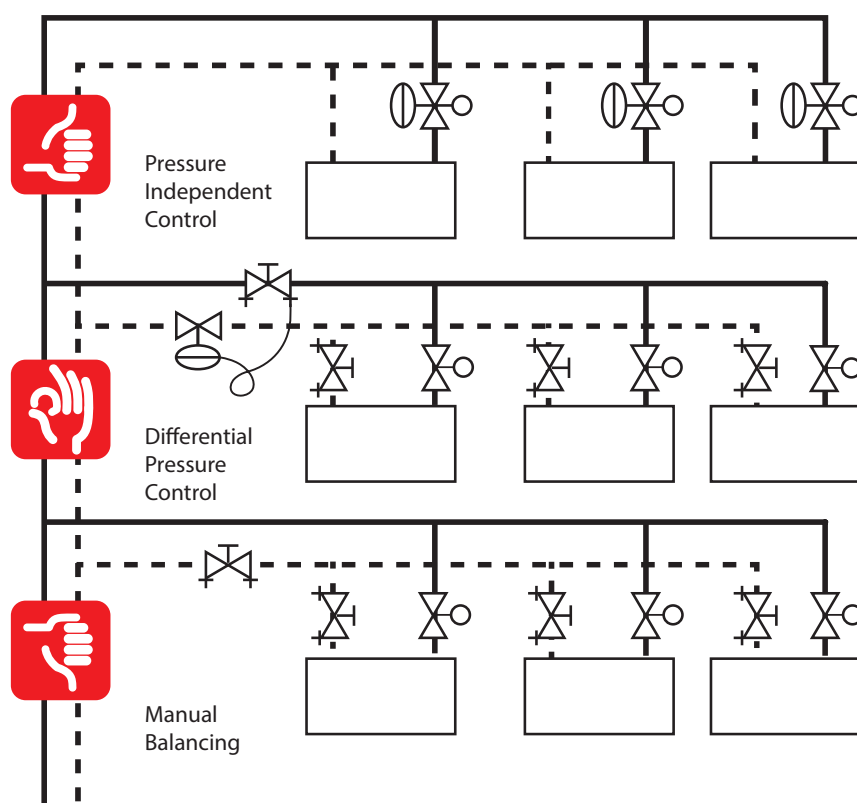

The evaluation of systems (Recommended/Acceptable/Not recommended) is principally based on combination of 4 aspects mentioned on page 3 (Return on investment/Design/Operation-Maintenance/Control) but the most important factors are the system performance and efficiency.

On application above the manual balanced system is Not recommended because the static elements are not able to follow the dynamic behaviour of variable flow\* system and during partial load condition huge overflow occurs on control valves (due to smaller pressure drop on pipe network).

The differential pressure controlled system performs much better (Acceptable) because the pressure stabilization is closer to control valves and although we still have manual balanced system inside the dp controlled loop, the overflow phenomenon mitigated. The efficiency of such system depends on location of differential pressure control valve. The closer it is to control valve, the better it works.

The most efficient (Recommended) system we can have is using PICV (pressure independent control valves). In this case the pressure stabilization is right on the control valve, therefore we have full authority\* and we are able to eliminate all unnecessary flow from the system.

## Notes

# Hydronic applications – commercial buildings

Variable flow\* system: PICV – ON/OFF vs modulating vs smart control

## 1.1.1.1 - 1.1.1.3\*\*

All these applications base on PICV (Pressure Independent Control Valve) technology. It means the control valve (integrated into the valve body) is independent from pressure fluctuation in the system during both full, and partial load conditions. This solution allows us to use different types of actuators (control method)

- With ON/OFF control, the actuator has two positions, open and closed
- With modulation control the actuator is able to set any flow between nominal and zero value
- With SMART actuator we can ensure (above modulation control) direct connectivity to BMS (Building Management System) to use advanced functions such as energy allocation, energy management etc.

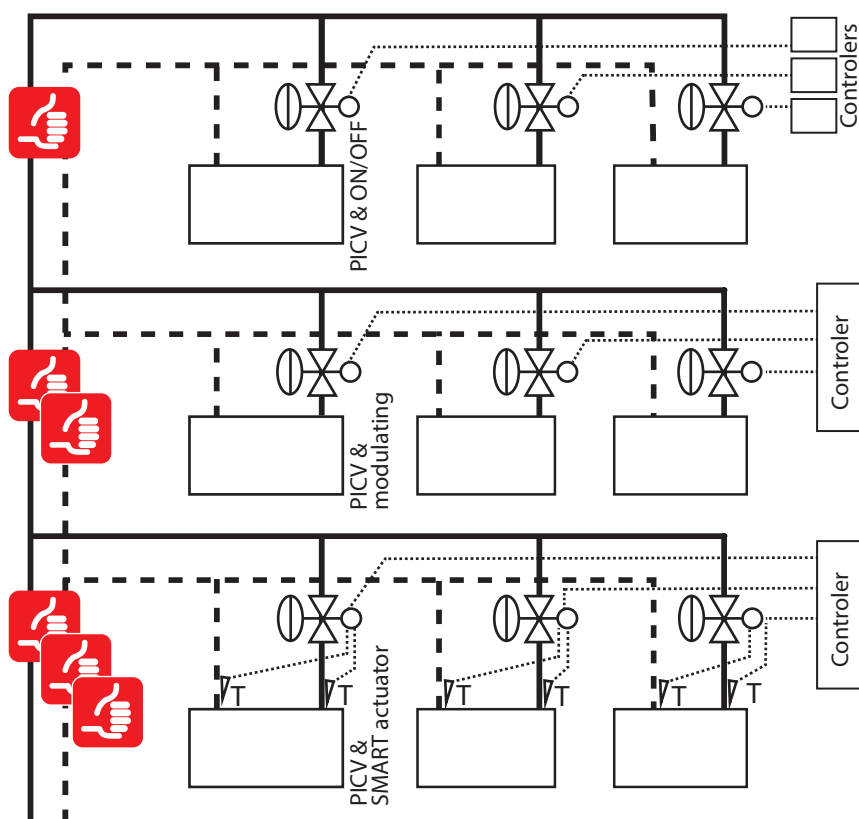

PICV technology allows us to use proportional or end point (based on  $\Delta p$  sensor) pump control

The above mentioned control types strongly affect on overall energy consumption of systems.

While ON/OFF control ensures either 100% or 0 flow during operation, the modulation control enables to minimize the flow rate through on terminal unit according real demand. For example, to the same 50% average energy demand we need around 1/3 of flow rate to modulation control, compared to ON/OFF control. (You can find more details in chapter 9)

The lower flow rate contributes to energy saving\* on more levels:

- Less circulation cost (fewer flow needs less electricity)
- Improved chiller/boiler efficiency (less flow ensures bigger  $\Delta T$  in the system)
- Smaller room temperature oscillation\* ensures better comfort and defines the room temperature setpoint

The SMART control – over the above mentioned benefits - enable to reduce the maintenance cost with remote access and predictive maintenance.

\*see page 54-55

\*\* applications below

## Notes



Recommended

## 1.1.1.1

Heating  Cooling 

## Variable flow: Pressure Independent Control (PICV) with ON/OFF actuator

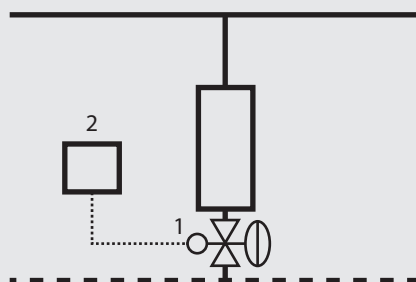

1. Pressure Independent Control Valve (PICV)
2. Room temperature Control (RC)

Balancing of the terminal unit by pressure independent valves. This will ensure the right flow at all system loads, regardless of pressure fluctuations. ON/OFF control will cause fluctuations in the room temperature. The system will not be operating optimally because the  $\Delta T$  is not optimized.

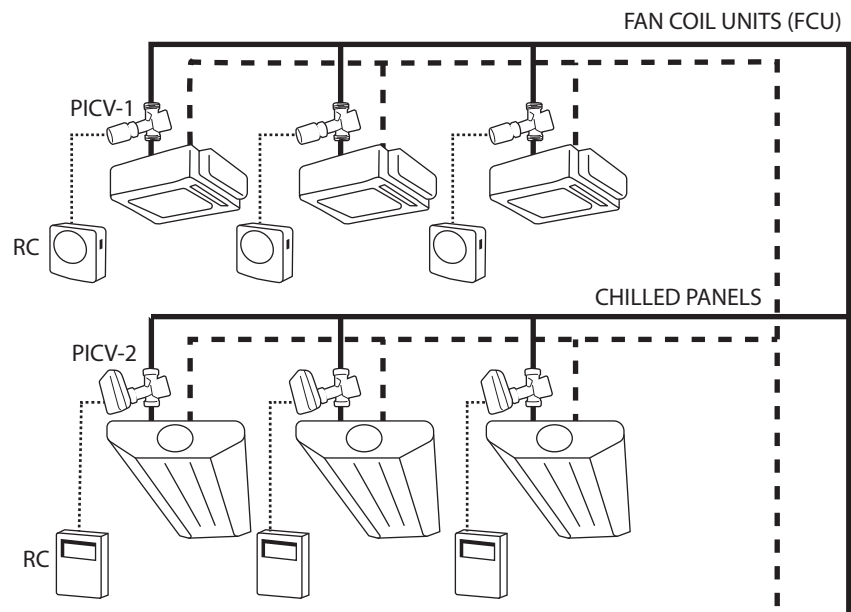

## Danfoss products:



PICV-1: AB-QM 4.0 + TWA-Q



PICV-2: AB-QM 4.0 + AMI-140



## Performance

## Return of investment



## Design

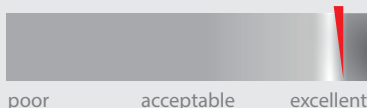

## Operation/Maintenance



## Control

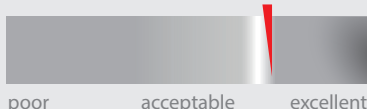

## Explanation

## Return of investment

- Reduction of components by eliminating the need for balancing valves
- Lower installation cost due to simplified installation
- The chillers and boilers operate efficiently but not optimally because the  $\Delta T$  is not optimized
- Handover of the building can easily be done in phases

## Design

- Easy selection of valves based only on the flow requirement
- No Kv or authority\* calculation is needed, the calculation is based on flow demand
- Perfect balance at all loads
- Proportional pump control is applicable and the pump(s) can be optimized\* easily
- Min available  $\Delta p$  demand on the valve can be taken for calculating the pump head

## Operation/Maintenance

- Simplified construction because of a reduction of components
- Set and forget, so no complicated balancing procedures
- Fluctuating room temperature, so some occupant complaints can be expected
- Low operational and upkeep cost, so occupants may experience discomfort
- Good but reduced efficiency in chillers, boilers and pumping because of a sub-optimized  $\Delta T$  in the system

## Control

- Temperature fluctuations \*
- No overflows\*
- Pressure independent solution, so no pressure changes do not affect control circuits
- Low  $\Delta T$  syndrome\* is unlikely to happen

\*see page 54-55



Heating  Cooling

# Variable flow: Pressure Independent Control (PICV) with proportional control

Recommended



## 1.1.1.2

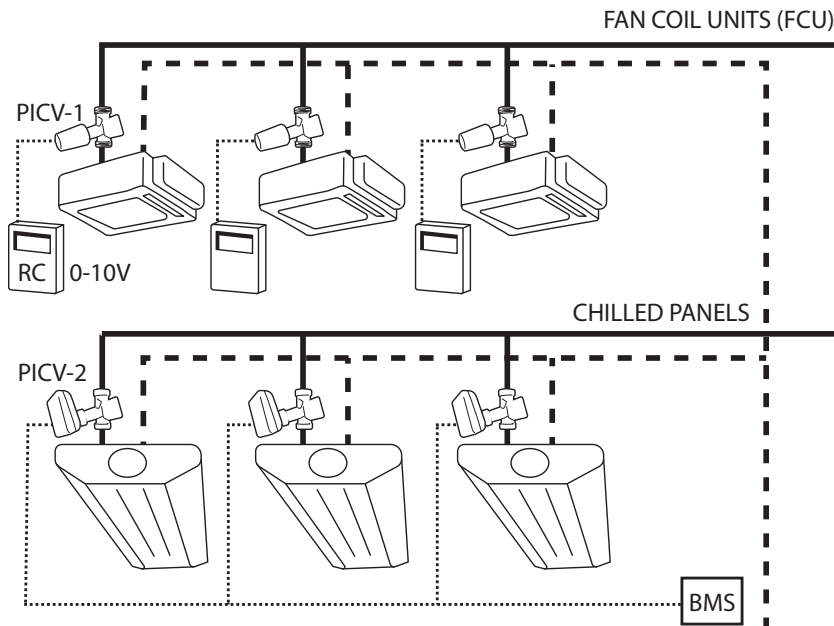

Danfoss products:



PICV-1: AB-QM 4.0 + ABNM A5

PICV-2: AB-QM 4.0 + AME 110 NL

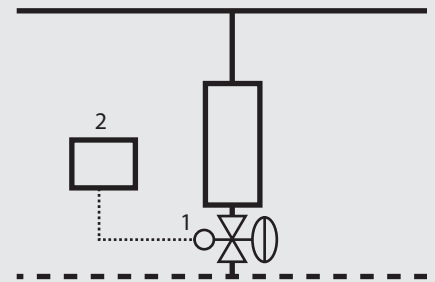

1. Pressure Independent Control Valve (PICV)
2. Building Management System (BMS) or Room temperature Control (RC)

Temperature control of the terminal unit is ensured with pressure independent valves. This will ensure the right flow at all system loads, regardless of pressure fluctuations. The result will be stable\* and precise room temperature control to ensure a high  $\Delta T$  and prevent actuators from hunting.

Applicable for all terminal units, included AHU (see page 34, 36)

### Explanation

#### Return of investment

- Reduction of components by eliminating the need for balancing valves
- Lower installation cost due to simplified installation
- Significant energy savings\* due to optimal working conditions for all components
- Handover of the building can easily be done in phases

#### Design

- Easy selection of valves based only on the flow requirement
- No Kv or authority\* calculation is needed, flow presetting calculation based on flow demand
- Proportional pump control is applicable. The pump(s) can be optimized easily \*
- Suitable for BMS applications to monitor the system and reduce energy usage

#### Operation/Maintenance

- Simplified construction because of a reduction of components
- Set and forget, so no complicated balancing procedures
- Good control at all loads, so no complaints by occupants
- Low operational and upkeep cost
- High comfort (building classification\*) because of precise flow control at all loads
- High efficiency in chillers, boilers and pumping because of the optimized  $\Delta T$  in the system

#### Control

- Perfect control because of full authority \*
- No overflows\* at partial system loads
- Proportional control minimizes the flow circulation and optimizes the pump head
- Pressure independent solution, so pressure interdependency of the control circuits
- No low  $\Delta T$  syndrome \*

### Performance

#### Return of investment

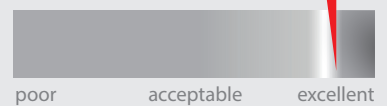

#### Design

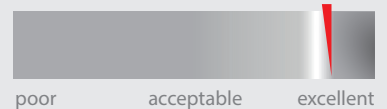

#### Operation/Maintenance

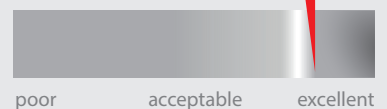

#### Control

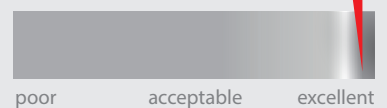

\*see page 54-55



Recommended

## 1.1.1.3

Heating  Cooling 

## Variable flow: Pressure Independent Control (PICV) with digital actuator

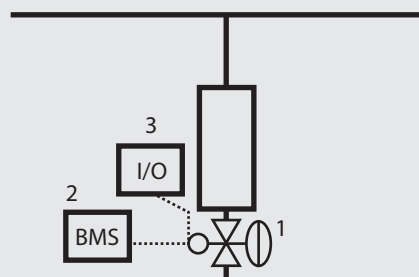

1. Pressure Independent Control Valve (PICV)
2. Building Management System (BMS)
3. Digital or Analogue Input/Output (I/O)

Temperature control of the terminal unit is ensured with pressure independent valves. This will ensure the right flow at all system loads, regardless of pressure fluctuations. The result will be stable and precise room temperature control to ensure a high  $\Delta T$  and prevent actuators from hunting. The additional features of digital, connected actuators will enable better system monitoring and reduce maintenance cost.

Applicable for all terminal units, included AHU (see page 34, 36)

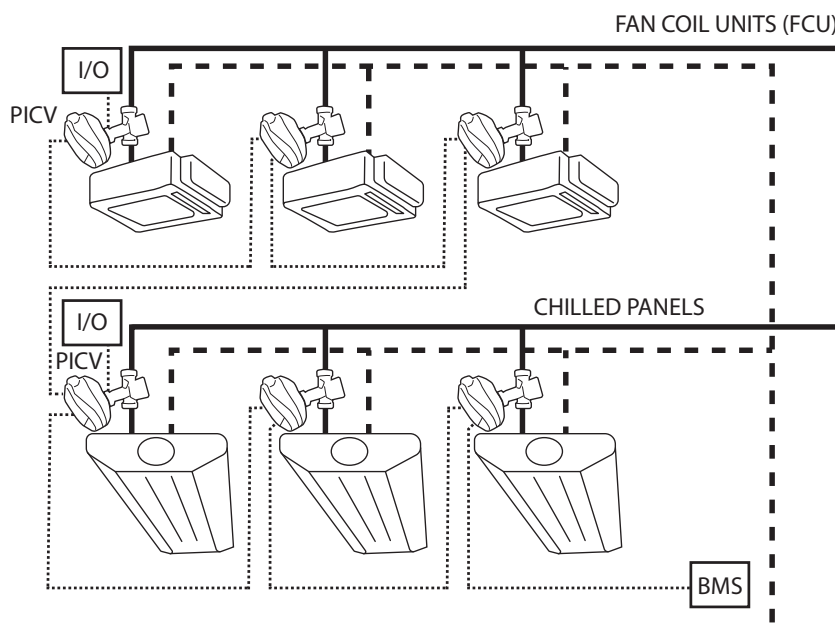

Danfoss products:



PICV: AB-QM 4.0 + NovoCon® S.

## Performance

## Return of investment

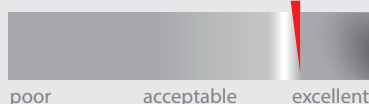

## Design

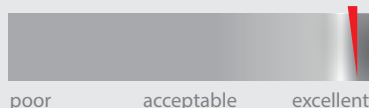

## Operation/Maintenance

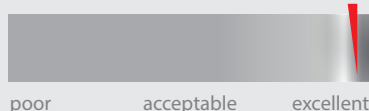

## Control

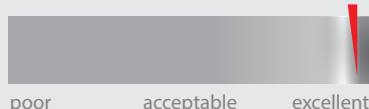

## Explanation

## Return of investment

- Reduction of components by eliminating the need for balancing valves
- Lower installation cost due to simplified installation
- Significant energy savings\* due to optimal working conditions for all components
- The higher cost for the SMART actuator can be offset by hardware savings like a reduced number of additional IOs
- High occupant satisfaction because of perfect balance and control extended with predictive maintenance and pro-active alarm functions

## Design

- Easy selection of valves based only on the flow requirement
- No Kv or authority calculation\* is needed, flow presetting calculation based on flow demand
- Proportional pump control is applicable. The pump(s) can be optimized easily \*
- Suitable for BMS applications to monitor the system and reduce energy usage
- Wide range of possible connected I/O devices ensures large number of BMS variants

## Operation/Maintenance

- The full commissioning procedure can be run through BMS ensuring less complexity and high flexibility
- Low operational and upkeep cost because the system health can be monitored and maintained through BMS.
- High comfort (building classification) because of precise flow control at all loads
- High efficiency in chillers, boilers and pumping because of the optimized  $\Delta T$  in the system
- Flexible and expandable control system through BMS connectivity

## Control

- No overflows at partial system loads
- Perfect control because of full authority \*
- Proportional control minimizes the flow circulation and optimizes the pump head
- Pressure independent solution, so pressure changes do not affect control circuits
- No low  $\Delta T$  syndrome \*

\*see page 54-55

Heating  Cooling

## Variable flow: Flow limitation (with flow limiter) on terminal unit with ON/OFF or modular actuator

Not Recommended



### 1.1.1.4

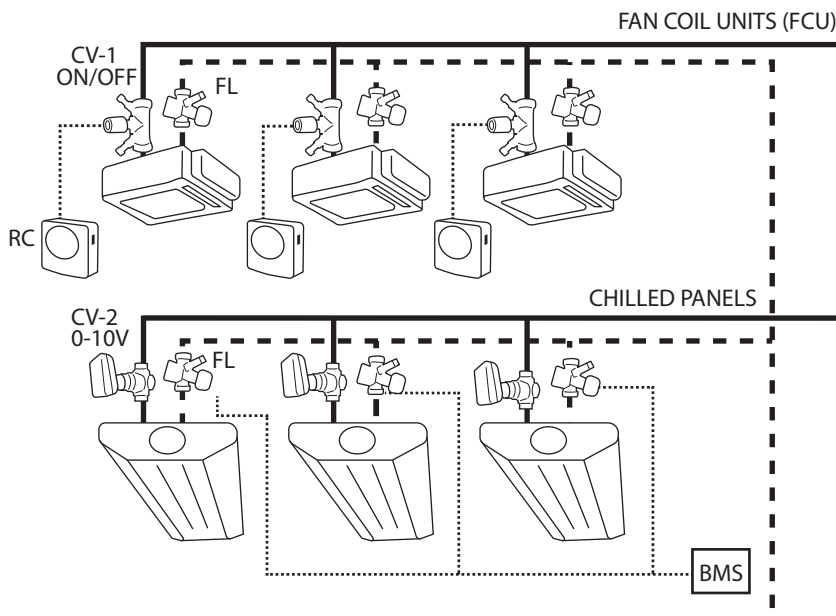

Danfoss products:



CV-1: RA-HC + TWA-A



CV-2: VZ2 + AME130



FL: AB-QM

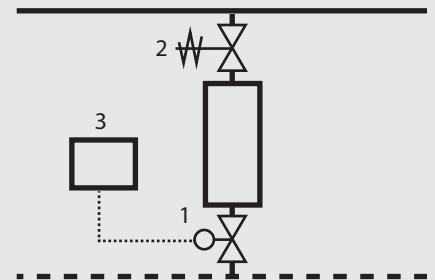

1. 2-way Control Valve (CV)
2. Flow Limiter (FL)
3. Building Management System (BMS) or Room temperature Control (RC)

Temperature control of the terminal unit is done by conventional motorized control valves (CV) while the hydronic balance in the system is realized by automatic flow limiter (FL). For ON/OFF control this could be an acceptable solution, provided that the pump head is not too high. For modulating control this is not acceptable. The FL will counteract the actions of the CV and fully distort the control characteristic. Therefore, modulation with this solutions is impossible.

#### Explanation

##### Return of investment

- Relatively high product cost because of 2 valves for all terminal units (one CV + FL)
- Higher installation costs although no manual partner valves\* are needed
- Variable speed pump is recommended (proportional pump control is possible)

##### Design

- Traditional calculation is needed but only the kvs of the control valve. It is not necessary to calculate the authority\* since the FL will take away the authority of the CV
- For ON/OFF control it is an acceptable solution (simple design: big kvs of zone valve, flow limiter selected based on flow demand)
- High pump head is needed because of the two valves (additional  $\Delta p$  on flow limiter)

##### Operation/Maintenance

- Closing force of actuator should be able to close the valve against the pump head at minimum flow
- Most flow limiters have pre-determined flow, no adjustment is possible.
- For flushing cartridges need to be removed from the system and placed back afterwards (emptying and filling the system twice)
- Cartridges have small openings and clog easily
- If modulation is attempted the lifetime of the CV is very short due to hunting at partial system loads
- High energy consumption with modulation control due to higher pump head and overflow on terminal units in partial load

##### Control

- Temperature fluctuations due to ON/OFF control, even with modulating actuators\*
- No overflows\*
- No pressure interdependency of the control circuits
- Overflow during partial load when modulating because the FL will keep the maximum flow if possible

#### Performance

##### Return of investment

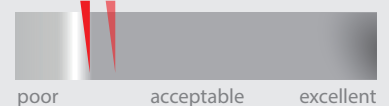

##### Design



##### Operation/Maintenance



##### Control



3-point or proportional control ON/OFF control

\*see page 54-55



## 1.1.1.5

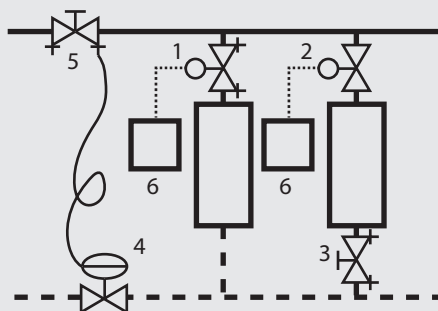

1. Zone Control Valve (with presetting) (CV)
2. Zone Control Valve (no presetting) (CV)
3. Manual Balancing Valve (MBV)
4.  $\Delta p$  Controller (DPCV)
5. Partner Valve\*
6. Building Management System (BMS) or Room temperature Control (RC)

Temperature control at the terminal unit is done by conventional motorized control valve (CV). Hydronic balance is achieved by differential pressure controllers (DPCV) on the branches and manual balancing valves (MBV) at the terminal unit. If the CV has a pre-setting option the MBV is redundant.

It guarantees that, regardless of pressure oscillations in the distribution network, we have the right pressure and flow in the pressure-controlled segment.

## Variable flow: Differential pressure control with ON/OFF or modulation

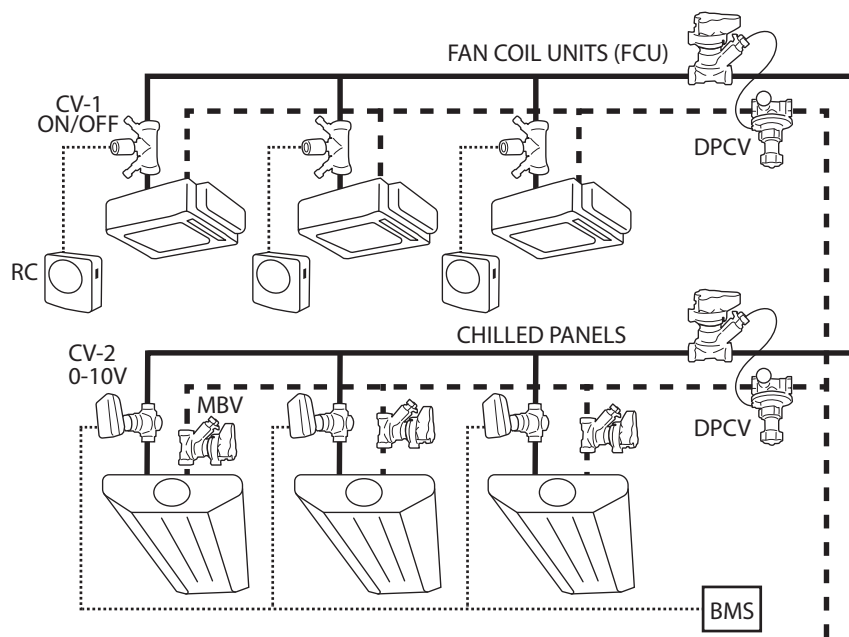

## Danfoss products:



CV-1: RA-HC +TWA-A

CV-2: VZ2 + AME130

MBV: MSV-BD

DPCV: ASV-PV+ASV-BD

## Performance

## Return of investment

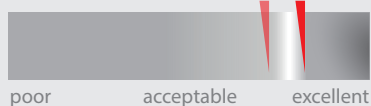

## Design

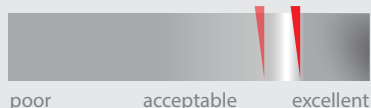

## Operation/Maintenance

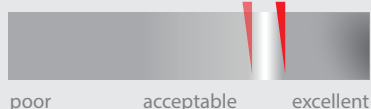

## Control

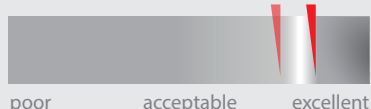

3-point or proportional control      ON/OFF control

## Explanation

## Return of investment

- Requires  $\Delta p$  controllers and partner valves\*.
- MBVs or pre-settable CV is needed for each terminal unit
- Cooling systems might require big and expensive (flanged)  $\Delta p$  controllers
- Good energy efficiency because there are only limited overflows\* in partial load

## Design

- Simplified design because the branches are pressure independent
- Kv calculation needed for  $\Delta p$  controller and control valve. An authority\* calculation is also needed for modulating control
- Pre-setting calculation for terminal units is necessary for proper water distribution within the branch
- The setting for the  $\Delta p$  controller needs to be calculated
- A variable speed pump is recommended

## Operation/Maintenance

- More components to install included impulse tube connection between  $\Delta p$  - and partner valve\*
- Simplified commissioning\* procedure because of pressure independent branches
- Balancing on the terminal units is still required although simplified by  $\Delta p$  controlled branch
- Phased commissioning is possible (branch by branch)

## Control

- Generally acceptable to good controllability
- Pressure fluctuations that impact the controllability can occur with long branches or and/or big  $\Delta p$  on terminal units
- Depending on the size of the branch overflows can still result in room temperature fluctuations.
- If we use flow limitation on partner valve\* connected to  $\Delta p$  controller (not on terminal units), higher overflow and room temperature oscillation\* are expected

Heating  Cooling

# Variable flow: Shell and Core installation for Offices and Shopping malls\*

Recommended



## 1.1.1.6

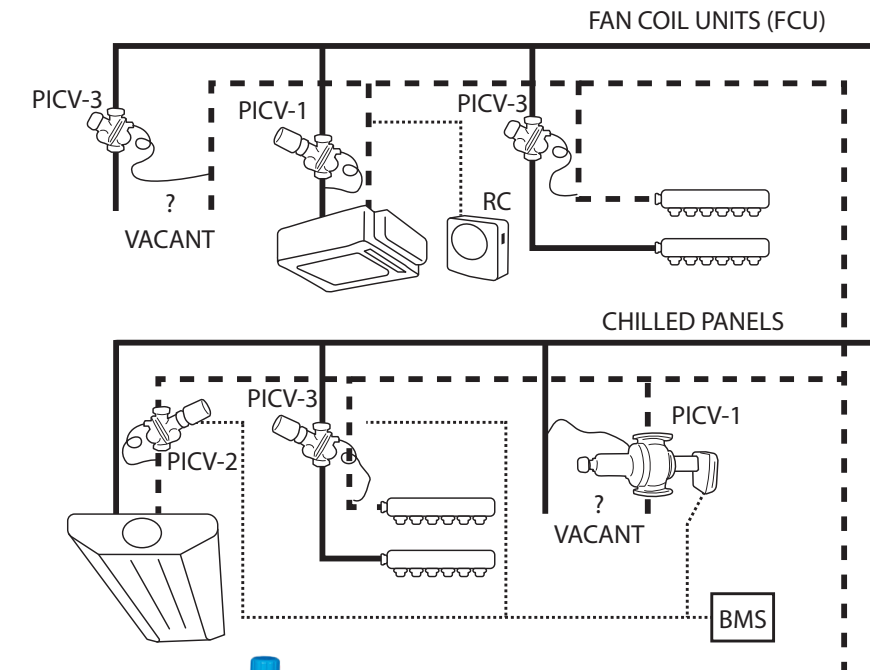

Danfoss products:



PICV-1: AB-PM+AME435QM



PICV-2 & PICV3: AB-PM + TWA-Q

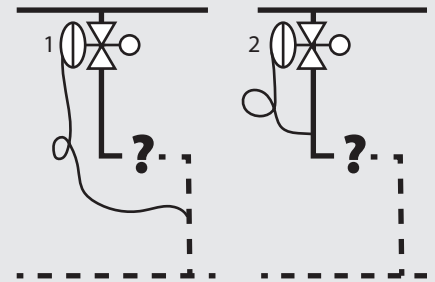

1. Combined Automatic Balancing Valve as  $\Delta p$  Controller (PICV 1)
2. Combined Automatic Balancing Valve as Flow Controller (PICV 2)

This application is useful specifically for situations where the system is built in two phases by different contractors. The first phase is usually the central infrastructure, like boilers, chillers and transport piping, while the second part includes the terminal units and room controls.

This commonly occurs in shopping malls, where the shops use their own contractor to do the shop's installation, or Shell & Core offices where the renter of an office floor fits out his own space, including the HVAC.

### Explanation

#### Return of investment

- Only one valve needed
- One actuator for zone or flow control
- Variable speed pump is recommended (proportional pump control is possible)

#### Design

- No kvs and authority\* calculation needed.
- Presetting calculation needed only based on flow and  $\Delta p$  demand of loop
- For loop design (later stage of installation) the set parameters are available

#### Operation/Maintenance

- Reliable solution for shop or floor connection
- Flow setting can be done based on measurements on the test plugs of the valve
- Central distribution is always correctly balanced and independent of any mistakes made in sizing on the occupant,s side
- Changes in secondary section of the system do not influence other shops or floors
- Easy trouble shooting, energy allocation, management, etc. with NovoCon

#### Control

- Stable pressure difference for shops or floors
- If only flow limitation is used small overflows can happen within the loop during partial load
- Actuator on valve (if applied) ensures either zone control ( $\Delta p$  control application) or flow control (flow control application)

\*\*Two different approaches can be chosen:

1. Flow and  $\Delta P$  limitation. Here the valve limits both the  $\Delta P$  and the flow.
2. Flow limitation only. This will require additional zone controls and balancing for the terminal units

### Performance

#### Return of investment

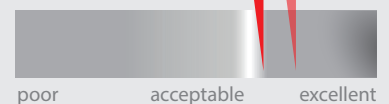

#### Design

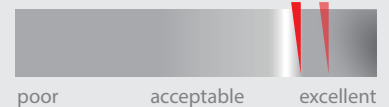

#### Operation/Maintenance

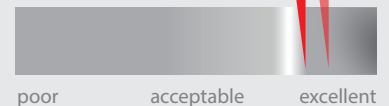

#### Control

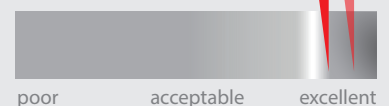

$\Delta p$  control application
 Flow control application

\*see page 54-55



Not Recommended

## 1.1.1.7

Heating Cooling 

## Variable flow: Manual balancing

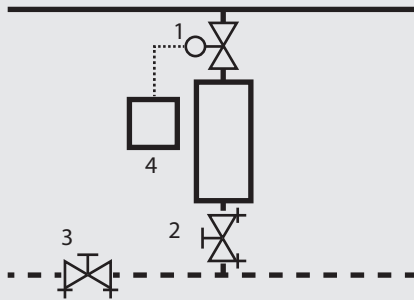

1. 2-way Control Valve (CV)
2. Manual Balancing Valve (MBV)
3. Partner Valve\* (MBV)
4. Building Management System (BMS) or Room temperature Control (RC)

The terminal units are controlled by conventional motorized control valves and the hydronic balance is achieved by manual balancing valve. Due to the static nature the MBV only ensures hydronic balance in full system load. During partial load under- and overflows can be expected in the terminal units, causing excessive energy consumption as well as cold and hot spots in the system.

## Performance

## Return of investment



## Design

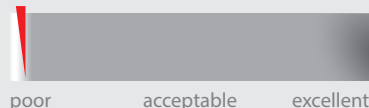

## Operation/Maintenance

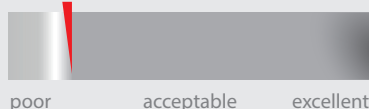

## Control

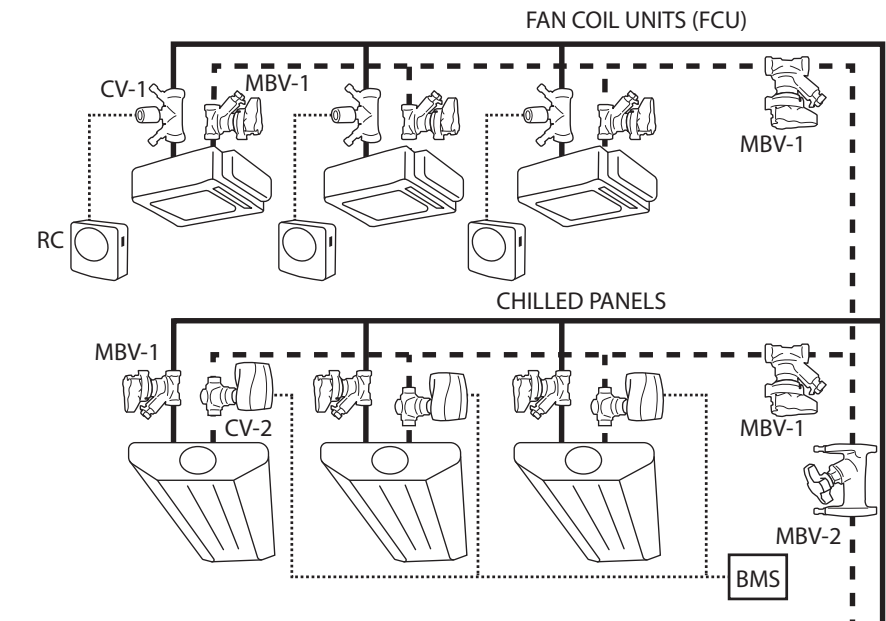
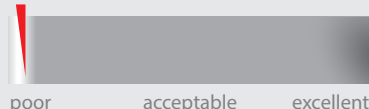

## Danfoss products:



CV-1: RA-HC + TWA-A



CV-2: VZ2 + AME130



MBV-1: MSV-BD

MBV-2: MSV-F2

## Explanation

## Return of investment

- Many components are needed: 2 valves per terminal unit and additional branch valves for commissioning\*
- Increased installation cost due to many valves
- Complex commissioning procedure is required increasing risk of a delayed.
- Variable speed pump is recommended with constant  $\Delta p$  function

## Design

- Precise sizing is required (Kv-value, authority\*)
- Authority\* calculations are crucial for acceptable modulation
- Constant  $\Delta p$  pump control is recommended because of the proper location for the pressure
- It is impossible to predict system behaviour in partial load

## Operation/Maintenance

- Complicated commissioning procedure that can only be executed by qualified staff
- Commissioning process can only be started at the end of the project with full load on the system and sufficient access to all balancing valves
- High complaint costs because of balancing issues, noise and inaccurate control during partial load
- Rebalancing needed regularly and in case of changes in the system
- High pumping costs\* because of overflows during partial load

## Control

- Interdependence of circuits creates pressure fluctuations, which influence control stability and accuracy
- The generated overflow reduces the system efficiency (high pumping cost\*, low  $\Delta T$  syndrome\* in cooling system, room temperature oscillation\*)
- Failure to create sufficient pressure drop on the valve will result in low authority\* which will make modulating control impossible

\*see page 54-55

Heating  Cooling

## Variable flow: Manual balancing with reverse return

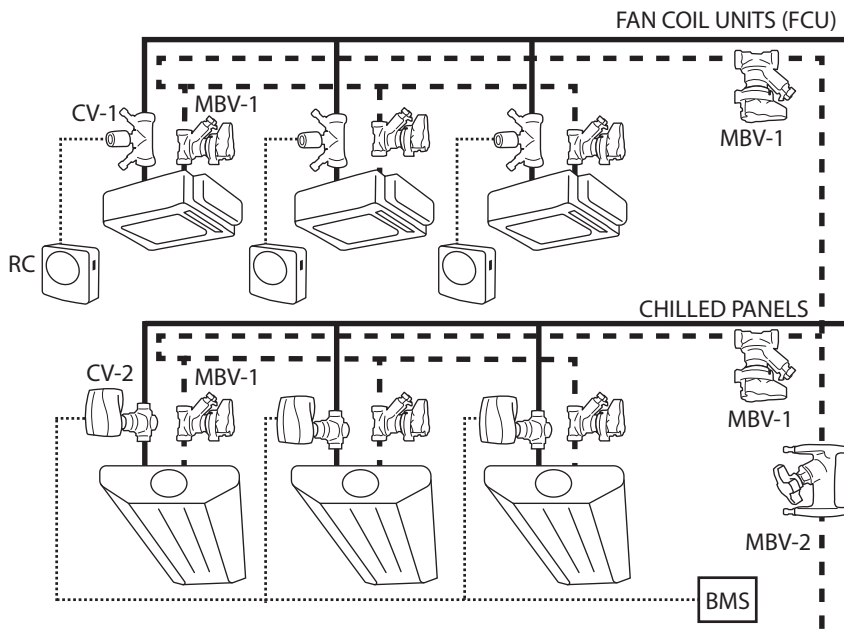

### Danfoss products:



CV-1: RA-HC + TWA-A   CV-2: VZ2 + AME130   MBV-1: MSV-BD   MBV-2: MSV-F2

### Explanation

#### Return of investment

- Due to extra pipe runs the investment is much higher
- More space needed in technical shaft for additional third pipe
- Bigger pump needed because of added resistance of additional piping
- High complaint costs because of the balancing issues, noise and inaccurate control during partial loads

#### Design

- Complicated piping design
- Precise control valve sizing is required (Kv-values, authority\*)
- Authority\* calculations are crucial for acceptable modulation
- Constant  $\Delta p$  pump control is recommended, it is impossible to use a  $\Delta p$  sensor
- The system is only balanced during full load conditions
- It is impossible to predict system behaviour in partial load

#### Operation/Maintenance

- Complicated commissioning\* procedure that can only be executed by qualified staff
- Commissioning process can only be started at the end of the project with full load on the system and sufficient access to all balancing valves
- $\Delta p$  sensor does not solve over pumping issues
- Rebalancing needed in case of changes in the system
- Extra high pumping costs\* because of third pipeline and overflows during partial load

#### Control

- Interdependence of circuits creates pressure fluctuations which influence control stability and accuracy
- The generated overflow reduces the system efficiency (high pumping cost\*, low  $\Delta T$  syndrome\* in cooling system, room temperature oscillation\*)
- Failure in creating sufficient pressure drop on the valve will result in low authority which\* will make modulating control impossible

Not Recommended



## 1.1.1.8

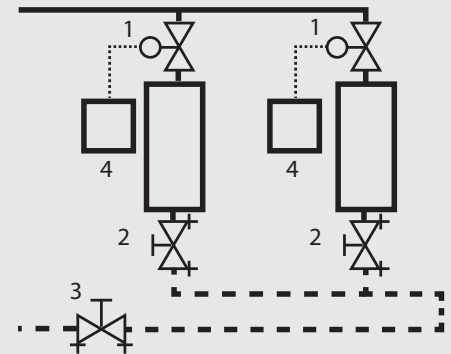

1. 2-way Control Valve (CV)
2. Manual Balancing Valve (MBV)
3. Partner Valve\* (MBV)
4. Building Management System (BMS) or Room temperature Control (RC)

In a reverse return system (Tichelmann), the piping is designed in such way that the first terminal unit on the supply is the last one on the return. The theory is that all terminal units have the same available  $\Delta p$  and therefore are balanced. This system can only be used if the terminal units are the same size and have constant\* flow. For other systems this application is unsuitable.

### Performance

#### Return of investment

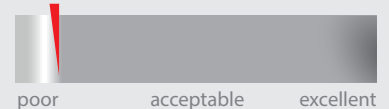

#### Design

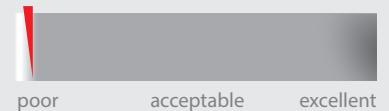

#### Operation/Maintenance

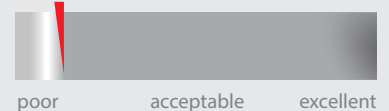

#### Control

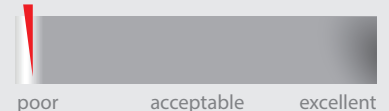

\*see page 54-55



Recommended

## 1.1.1.9

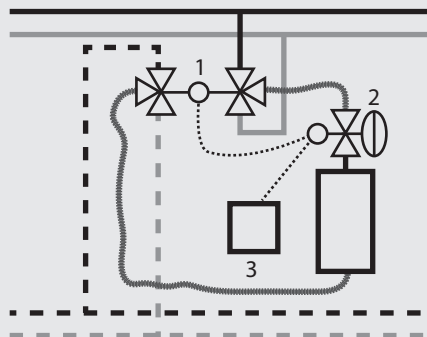
Heating  Cooling Variable flow: Four-pipe Changeover (CO6)  
for radiant heating/cooling panels, chilled  
beams, etc. with PICV control valve

1. 6-way Valve
2. Pressure Independent Control Valve (PICV)
3. Building Management System (BMS)

This application is useful if you have one heat exchanger that needs to do both heating and cooling. This fits well with radiant panel solutions. The application uses a 6-way valve for switching over between heating and cooling and a PICV is used to balance and control the flow.

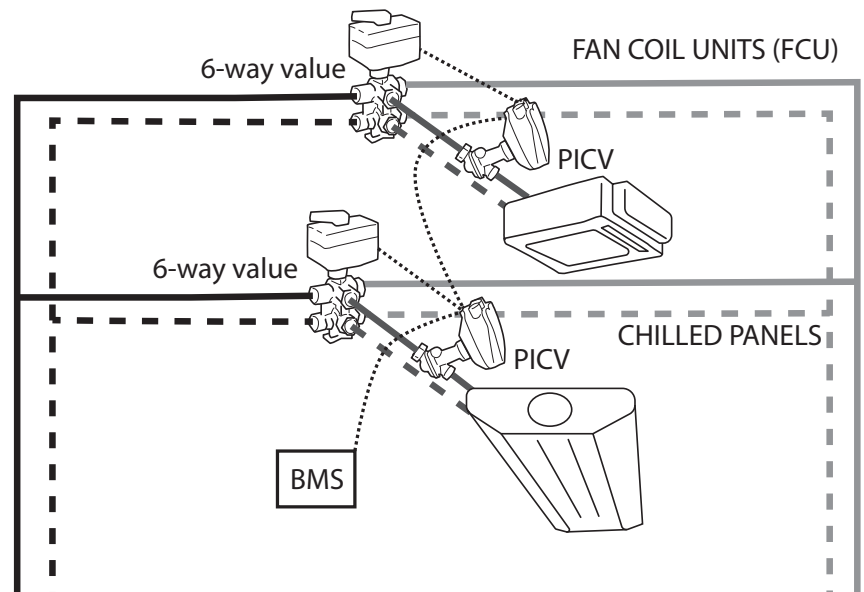

Danfoss products:

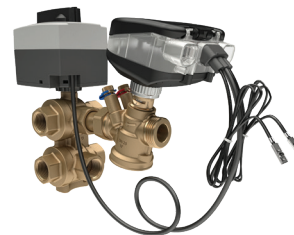

6-way valve + PICV: NovoCon ChangeOver6 +AB-QM

## Performance

## Return of investment

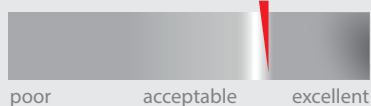

## Design

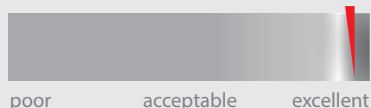

## Operation/Maintenance

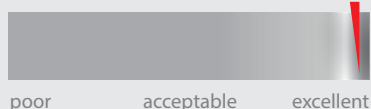

## Control

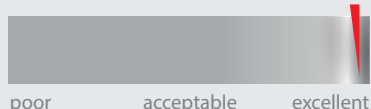

## Explanation

## Return of investment

- Only two valves are needed instead of four. One for changeover\* and one for heating/cooling control
- Very energy efficient thanks to high  $\Delta T$  and no overflows\*
- Low commissioning\* cost because only the flow needs to be set either on PICV or on BMS when using a digital actuator
- BMS costs are reduced because only one datapoint is needed

## Design

- Easy selection of PICV, only the flow is required for sizing
- No Kv or authority\* calculations needed
- The  $\Delta p$  on CO6 valve does need to be checked
- Perfect balance and control under all loads ensuring precise room temperature control

## Operation/Maintenance

- Simplified construction because of reduction of components and pre-built sets
- One valve controls both cooling and heating
- Low complaint costs because of perfect balance and perfect control at all loads
- No cross flow between heating and cooling
- Low operational and upkeep cost. Flushing, purging, energy allocation and management can all be done through BMS.

## Control

- Perfect control because of full authority\*
- Individual settings for cooling and heating (flow), so perfect control in both situations
- Precise room temperature control
- Digital actuator ensures further saving with energy measurement and management function



Heating  Cooling

## Variable flow: Two-pipe heating/cooling system with central changeover\*

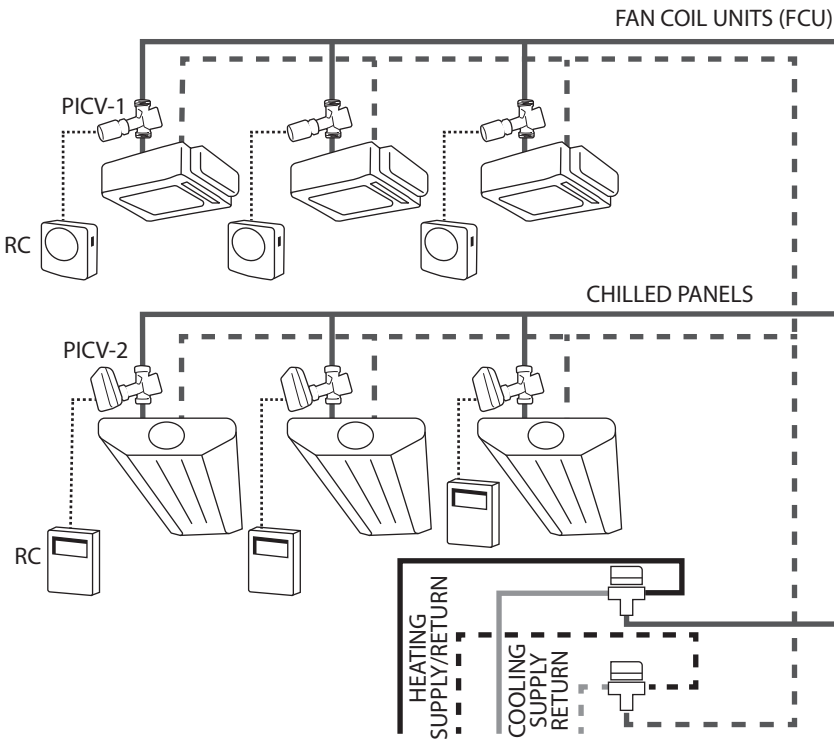

Danfoss products:

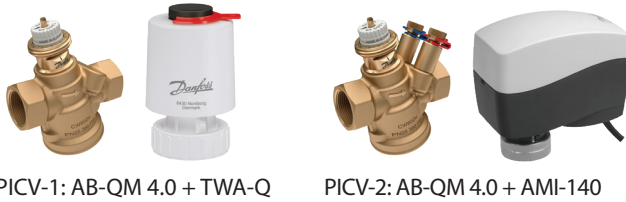

### Explanation

#### Return of investment

- Heavily reduced construction cost due to elimination of a second set of pipes
- Extra costs if automatic changeover\* is required
- Proportional pump control is recommended

#### Design

- Simple PICV selection according to cooling flow, which is usually the highest
- The change-over valve needs to be selected according to the biggest flow rate (cooling) and a big Kvs is recommend to reduce the pumping cost\*
- Different flow rates for heating and cooling need to be ensured, either by limiting the actuator stroke or by the ability to remotely set the maximum flow, (digital actuator)
- In most cases a different pump head is needed for heating and cooling

#### Operation/Maintenance

- Simple system setup with few valves, so low maintenance cost
- The seasonal changeover\* needs to be managed
- No overflow\* (if flow can be set for different heating/cooling mode)

#### Control

- Simultaneous heating and cooling in different rooms is not possible
- Perfect hydronic balancing and control with PICV
- ON/OFF control results in overflows when the flow limitation is not solved for lower flow demand (heating)

Acceptable



1.1.1.10

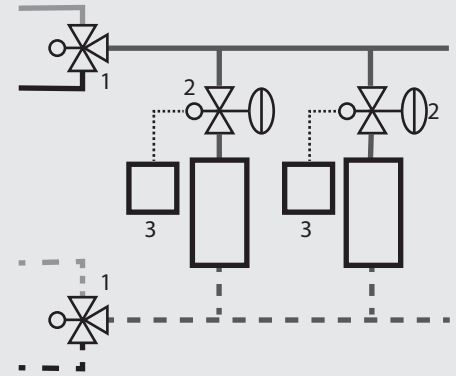

1. Central Changeover Valve
2. Pressure Independent Control Valve (PICV)
3. Room thermostat (RC)

In this application a central change guarantees that the rooms can be cooled and heated. It is strongly recommended to use a PICV to control the temperature because of the different flow requirements for the heating and cooling.

### Performance

#### Return of investment

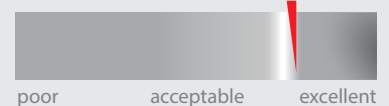

#### Design



#### Operation/Maintenance



#### Control

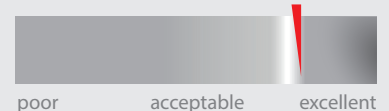

\*see page 54-55

**Not Recommended**

# 1.1.2.1

Heating  Cooling 

## Constant flow: 3-way valve with manual balancing (in fan-coil, chilled beam etc. application)

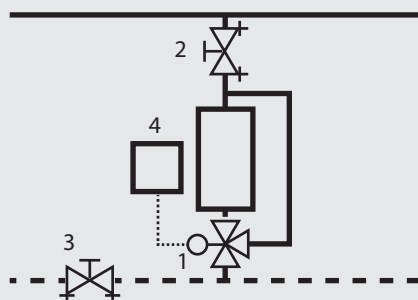

1. 3-way Control Valve (CV)
2. Manual Balancing Valve (MBV)
3. Partner Valve\* (MBV)
4. Building Management System (BMS) or Room temperature Control (RC)

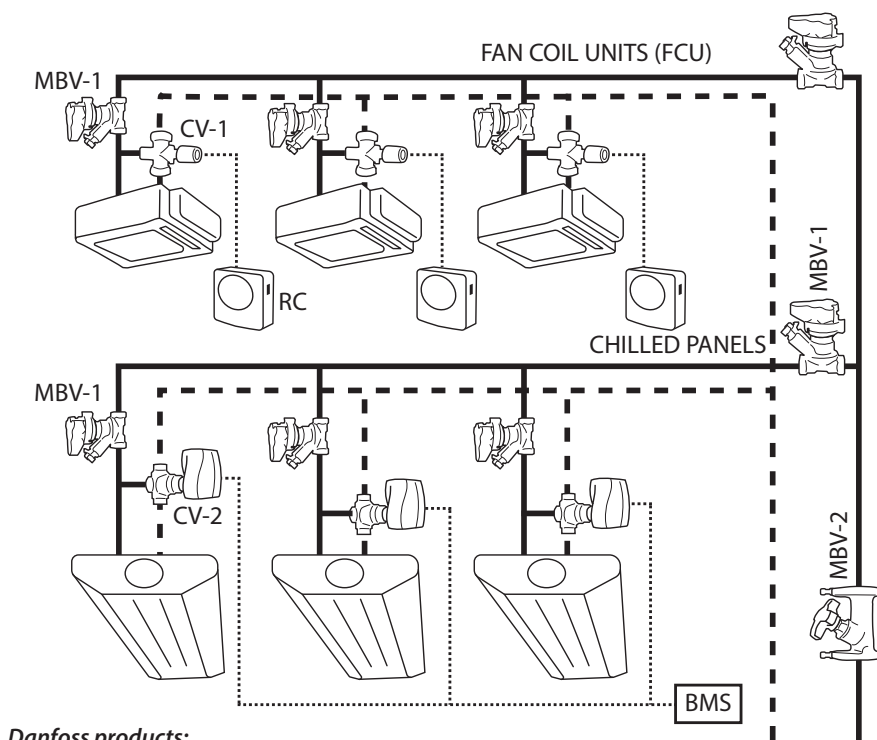
**Danfoss products:**

CV-1: VZL3 + TWA-ZL

CV-2: VZ3 + AME130

MBV-1: MSV-BD

MBV-2: MSV-F2

In this application temperature control on the terminal unit is done by using 3-way valves. Manual balancing valves are used to create hydronic balance in the system. This application should be avoided due to its high energy inefficiency.

### Performance

#### Return of investment

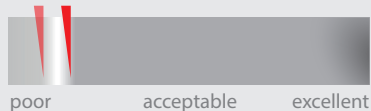

#### Design

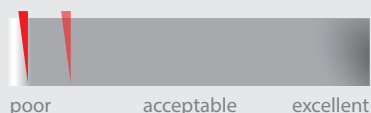

#### Operation/Maintenance

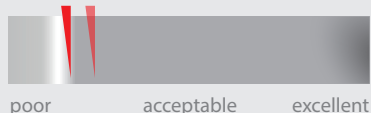

#### Control



ON/OFF control (represented by a red triangle) and Modulation control (represented by a red triangle).

### Explanation

#### Return of investment

- Many components are needed: a 3-way valve and a balancing valve per terminal unit and additional branch valves for commissioning\*
- Extremely high operational cost, very energy inefficient
- The flow is close to constant, no variable speed drive applied
- In partial loads very low  $\Delta T$  in the system, so boilers and chillers run at very low efficiency

#### Design

- Kv calculation is required, as well as an authority calculation\* for the 3-way valve in case of modulation
- A by-pass needs to be sized or a balancing valve should be fitted. Otherwise big overflows in partial loads can occur causing terminal unit starvation and energy inefficiencies.
- For the Pump head calculation partial load needs to be considered if overflows on the by-pass are expected

#### Operation/Maintenance

- Commissioning of the system is required
- The hydronic balance at full- and partial load is acceptable
- Huge pump energy consumption due to constant operation
- High energy consumption (low  $\Delta T$ )

#### Control

- The water distribution and the available pressure on the terminal units are more or less constant under all loads
- The room temperature control is satisfactory
- An oversized control valve will result in low rangeability and oscillation\* with modulation

Heating  Cooling

## Constant flow: 3-way valve with flow limiter on terminal units (fan-coil, chilled beam etc. application)

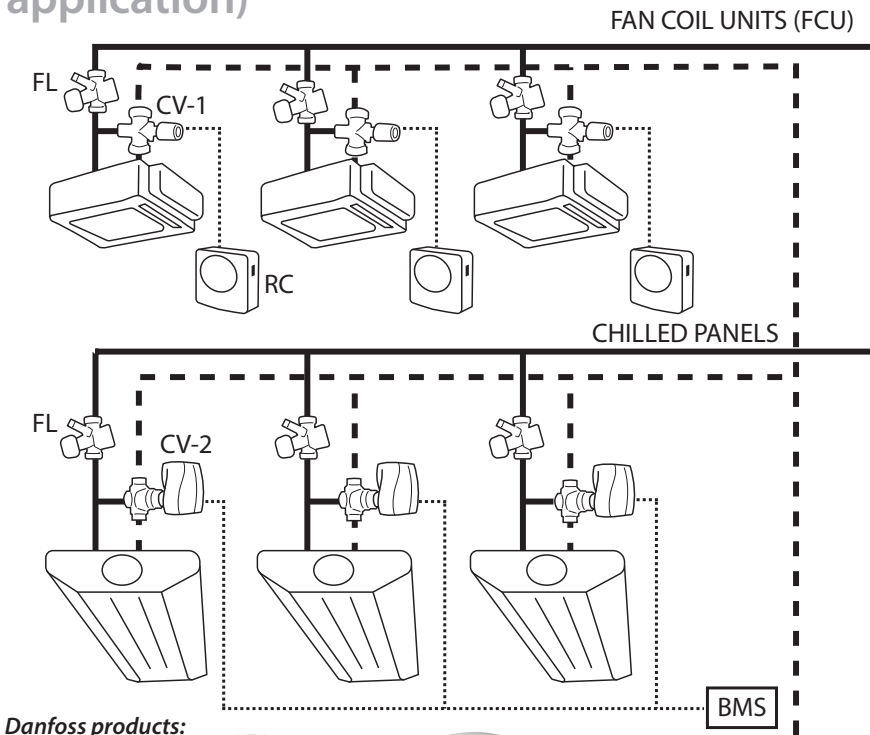

Danfoss products:



CV-1: VZL3 + TWA-ZL



CV-2: VZ3 + AMV-130



FL: AB-QM

Not Recommended



## 1.1.2.2

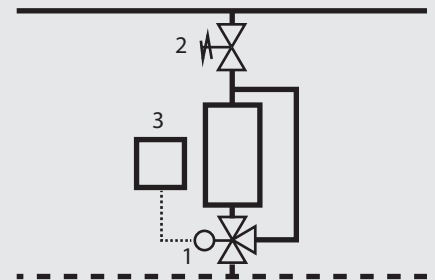

1. 3-way Control Valve (CV)
2. Flow Limiter (FL)
3. Building Management System (BMS) or Room temperature Control (RC)

In this application temperature control on the terminal unit is done by using 3-way valves. Automatic flow limiters are used to create hydraulic balance in the system. This application should be avoided due to its high energy inefficiency.

### Explanation

#### Return of investment

- Many components are needed: a 3-way valve and an automatic flow limiter per terminal unit
- Fairly simple valve setup, no need for a balancing valve in by-pass or other valves for commissioning\*
- Extremely high operational cost, very energy inefficient
- The flow close to constant, no variable speed drive applied
- In partial loads very low  $\Delta T$  in the system, so boilers and chillers run at very low efficiency

#### Design

- Kv calculation is required, as well as an authority\* calculation for the 3-way valve in case of modulation.
- Sizing and presetting of the flow limiters is based on the nominal flow of terminal unit
- For the Pump head calculation partial load needs to be considered if overflows on the by-pass are expected.

#### Operation/Maintenance

- Commissioning of the system is required
- The hydraulic balance at full- and partial load is acceptable
- Huge pump energy consumption due to constant operation
- High energy consumption (low  $\Delta T$ )

#### Control

- The water distribution and the available pressure on the terminal units are more or less constant under all loads
- The room temperature control is satisfactory
- An oversized control valve will result in low rangeability and oscillation\* with modulation

### Performance

#### Return of investment

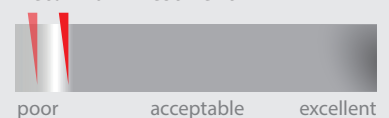

#### Design

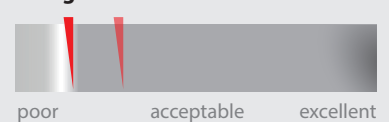

#### Operation/Maintenance

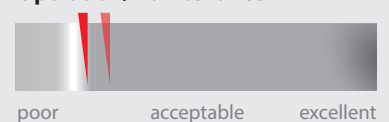

#### Control



ON/OFF control Modulation control

\*see page 54-55



Recommended

## 1.2.1.1

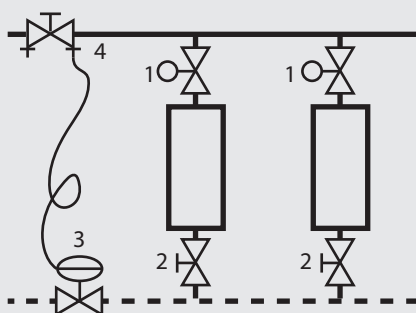

1. Thermostatic Radiator Valve (TRV)
2. Return Locking Valve (RLV)
3.  $\Delta p$  controller (DPCV)
4. Partner valve\*

In this application we ensure variable flow\* on risers with thermostatic radiator valves. In case of presetting available on TRV,  $\Delta P$  controller used without flow limitation on the riser.

## Performance

## Return of investment

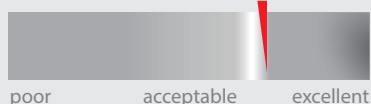

## Design

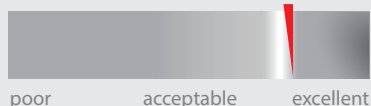

## Operation/Maintenance

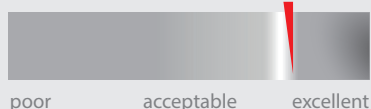

## Control

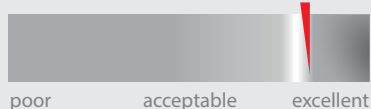
Heating  Cooling 

## Two-pipe radiator heating system – risers with, thermostatic radiator valves (with presetting)

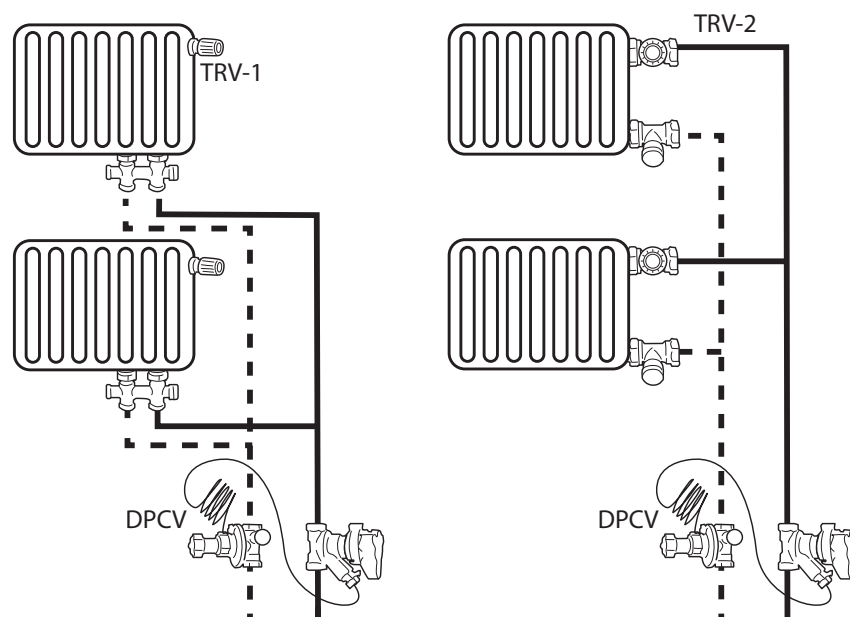

## Danfoss products:



TRV-1: RA build in + RA

TRV-2: RA-N + RA

DPCV: ASV-PV+ASV-BD

## Explanation

## Return of investment

- $\Delta p$  controller is more expensive compared to manual balancing
- Commissioning is not needed only  $\Delta p$  setting on  $\Delta p$  controller and flow pre-setting on TRVs
- Variable speed pump is recommended

## Design

- Simple calculation method,  $\Delta p$  controlled risers can be calculated as independent loops (you can split the system by risers)
- The presetting calculation of radiators is needed,
- Kv calculation needed for  $\Delta p$  controller and control valve. Authority calculation also needed for proper TRV operation
- The  $\Delta p$  demand of loop should be calculated and set according nominal flow and system resistance

## Operation/Maintenance

- Hydraulic regulation is in the bottom of risers and radiator presetting
- No hydronic interference among the risers
- Balancing at full and partial load – good – with TRV presetting
- Good efficiency: increased  $\Delta T$  on riser and variable speed pump ensures energy saving

## Control

- The efficiency of system good with individual presetting on radiators
- Low pumping costs – the flow rate of risers are limited.
- Maximum  $\Delta T$  on risers

Heating  Cooling

## Two pipe radiator heating system – risers with, thermostatic radiator valves (without presetting)

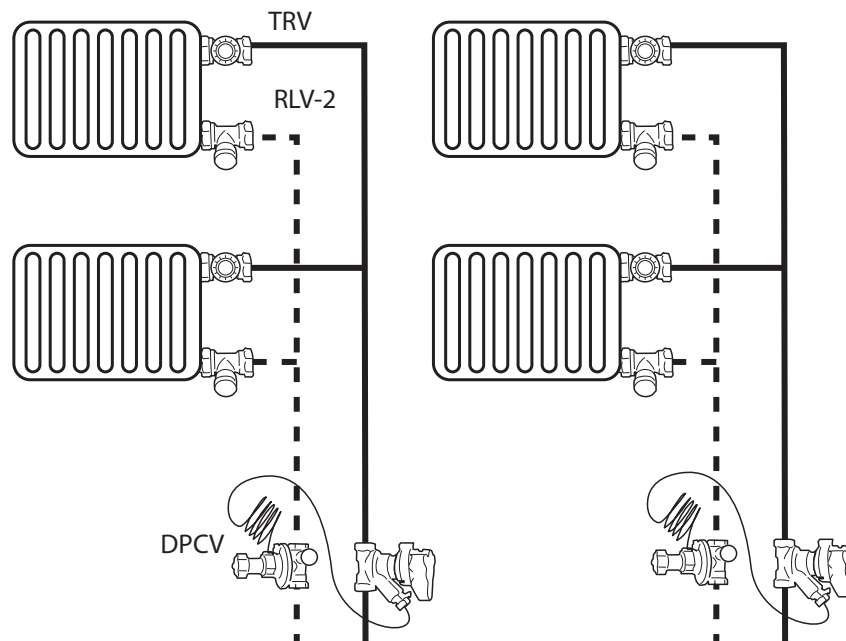

Danfoss products:

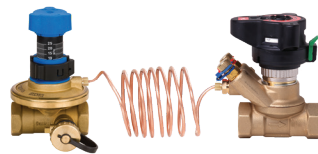

DPCV: ASV-PV+ASV-BD

Acceptable



## 1.2.1.2

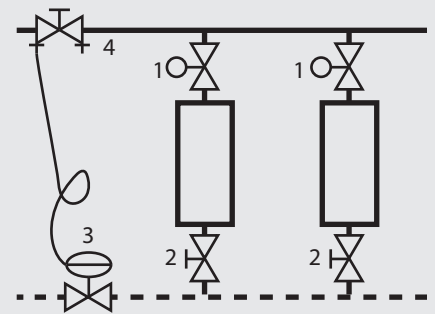

1. Thermostatic Radiator Valve (TRV)
2. Return Locking Valve (RLV)
3.  $\Delta p$  controller (DPCV)
4. Partner valve\*

In this application we ensure variable\* flow on risers with thermostatic radiator valves. No possibility of presetting on TRV,  $\Delta P$  controller used with flow limitation on the riser with partner valve\*.

### Explanation

#### Return of investment

- $\Delta p$  controller plus flow limitation is more expensive than manual balancing
- Commissioning\* is needed for flow limitation on the bottom of riser plus  $\Delta p$  setting on  $\Delta p$  controller
- Variable speed pump is recommended

#### Design

- Simple calculation method,  $\Delta p$  controlled risers can be calculated as independent loops (you can split the system by risers)
- The presetting calculation of partner valve\* for flow limitation is required
- Kv calculation needed for  $\Delta p$  controller and control valve. Authority \*checking is also essential to know the control performance of TRV
- The  $\Delta p$  demand of loop should be calculated and set according to nominal flow and system resistance

#### Operation/Maintenance

- Hydronic regulation is at the bottom of risers only
- No hydronic interference among the risers
- Balancing at full and partial load is acceptable
- Acceptable efficiency and variable speed pump ensures energy saving\*

#### Control

- The flow limitation at the bottom of riser causes extra pressure drop within the  $\Delta p$  controlled loop therefore higher overflow appears during partial load (compared to presetting on TRV)
- Higher pumping costs\* – however the flow rate of risers is limited slight overflow occurs within the riser during partial load condition
- Acceptable  $\Delta T$  on risers (lower compared to presetting on TRV)

### Performance

#### Return of investment



#### Design



#### Operation/Maintenance

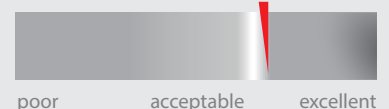

#### Control



\*see page 54-55



Recommended

## 1.2.1.3

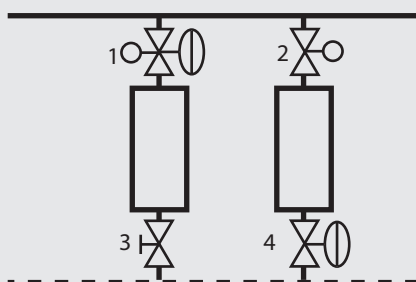

1. Radiator Dynamic Valve (RDV)
2. Thermostatic Radiator Valve (TRV)
3. Return Locking Valve (RLV)
4. Return Locking Dynamic Valve (RLDV)

In this application Pressure Independent Control Valves used in smaller radiator heating system combined with thermostatic sensor (self-acting proportional room temperature control), give us a guarantee that regardless of the pressure oscillation inside the system, we will secure the right flow, allowing the right amount of heat to be delivered to the room. (Traditional radiator or „H“ piece connection available).

## Performance

## Return of investment



## Design

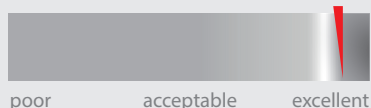

## Operation/Maintenance

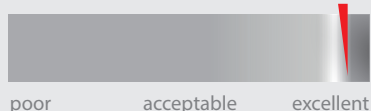

## Control



## Explanation

## Return of investment

- A minimal number of components is needed which means less installation costs
- Low complaint costs because of perfect balance and perfect control at all loads
- Highly energy efficiency because of precise flow limitation at all loads
- High efficiency of boilers and pumping because of high  $\Delta T$  in the system

## Design

- Easy selection of valves based only on flow requirement
- No Kv or authority\* calculation is needed, presetting calculation is based on flow demand
- Perfect balance and control at all loads
- Proportional pump control is recommended, pump speed can be optimized easily
- This solution applicable up to max. 135 l/h flow rate on terminal unit and max 60 kPa pressure difference across the valve
- Min available  $\Delta p$  on the valve 10 kPa

## Operation/Maintenance

- Simplified construction because of reduction of components
- Set and forget, no complicated balancing procedures are needed
- Changes of flow setting do not influence the other users
- Flow verification is possible on the valve with special tool

## Control

- Perfect control because of full authority\*
- No overflows\*
- Fix 2K proportional Xp band
- Fully pressure independent so no interference from pressure fluctuations and therefore stable room temperatures\*

Heating  Cooling 

## Pressure Independent Control for radiator heating system

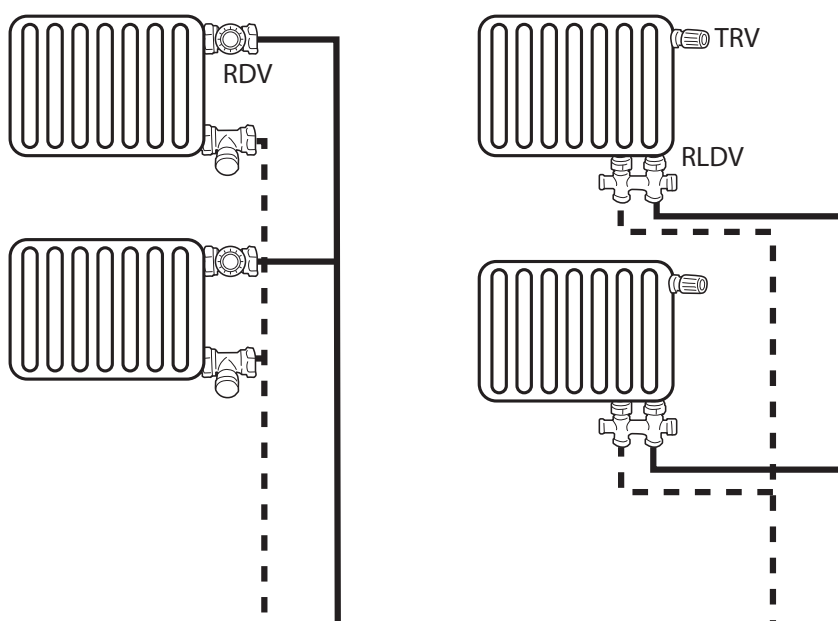

## Danfoss products:

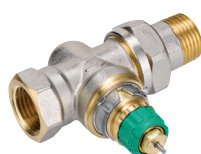

RDV: RA-DV + RA



TRV-1: RA build in + RA



RLDV: RLV-KDV

Heating  Cooling

## Subordinated risers (staircase, bathroom, etc.) in two- or one-pipe radiator heating system without thermostatic valve

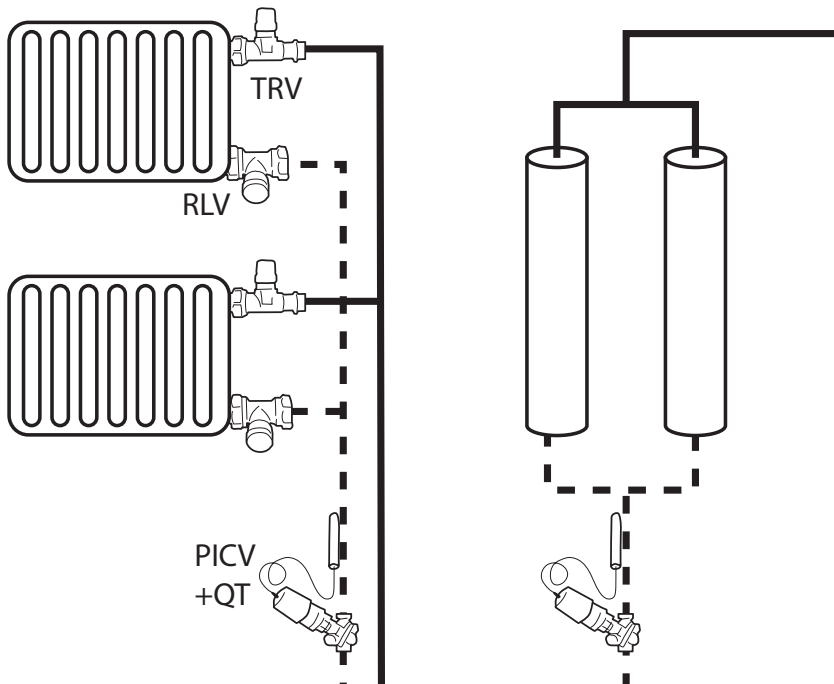

Danfoss products:



TRV: RA-N+RA

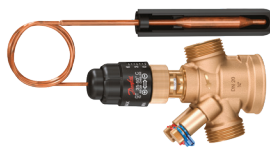

PICV+QT: AB-QT

### Explanation

#### Return of investment

- QT (temperature limiter sensor) is an extra cost (flow limiter is recommended in any case)
- Commissioning of the system is not required only setting of flow on PICV and temperature on QT
- VSD pump is recommended

#### Design

- Simple calculation is required for riser flow, based on heat demand and  $\Delta T$ , the size of radiator, convector has to be designed accordingly
- The flow is controlled by return temperature signal
- The presetting calculation of radiator is crucial due to no room temperature controller, the heat emission will depend on flow rate and size of radiator. The presetting calculation is based on flow rate among radiators and pressure drop of pipeline
- Simplified hydraulic calculation (you can split the system by risers)

#### Operation/Maintenance

- No overheating on riser during partial load condition (strongly recommended for renovation)
- Good balancing at full and partial load - additional energy saving\*
- Higher efficiency, limited return temperature and variable speed pump ensures energy saving\*

#### Control

- Inner rooms (typically bathrooms) have constant heat demand, to keep constant heat output, with increasing flow temperature, QT reduces the flow rate.
- Less overheating of risers – energy saving\*
- $\Delta T$  increase ensures lower heat loss and better heat production efficiency
- LOW pumping costs\* – the flow rate of subordinated risers are limited and reduced even more with temperature limitation by QT
- Limited efficiency of QT control when flow temperature drops. Electronic controller (CCR3+) increases efficiency at higher outdoor temperature.

Recommended



## 1.2.1.4

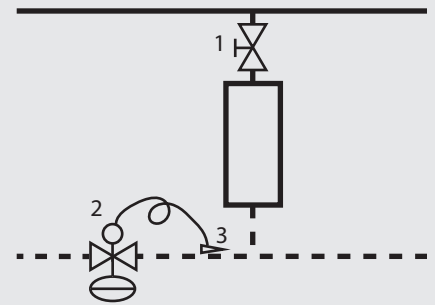

1. Radiator Valve (without sensor) (RV)
2. Pressure Independent Control Valve (PICV)
3. Temperature Sensor (QT)

In this application we have theoretical constant flow\* on subordinated risers and no thermostatic sensor on radiator valve (like staircase, bathroom etc.) For better efficiency we ensure variable flow\* in case of partial load condition when the return temperature is increasing, with return flow temperature limitation.

### Performance

#### Return of investment

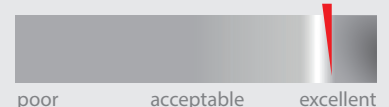

#### Design



#### Operation/Maintenance

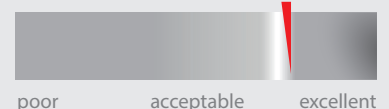

#### Control

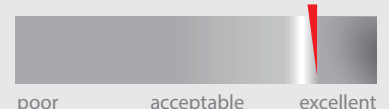

\*see page 54-55



Recommended

## 1.2.1.5

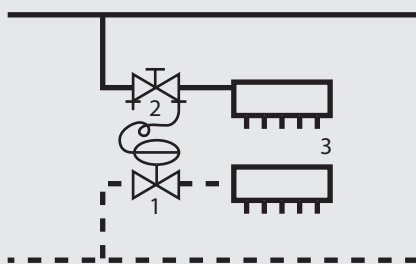

1.  $\Delta p$  controller (DPCV)
2. Partner valve\*
3. Manifold with presettable valves

In this application we ensure variable flow\* in the distribution pipeline and constant differential pressure on each manifold independently from temporal load and pressure fluctuation in the system. Applicable for both radiator and floor heating systems.

## Performance

## Return of investment



## Design

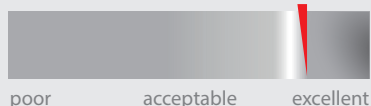

## Operation/Maintenance

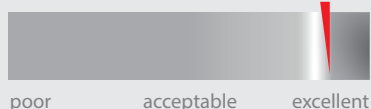

## Control

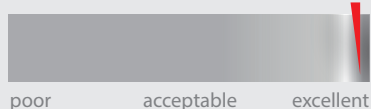
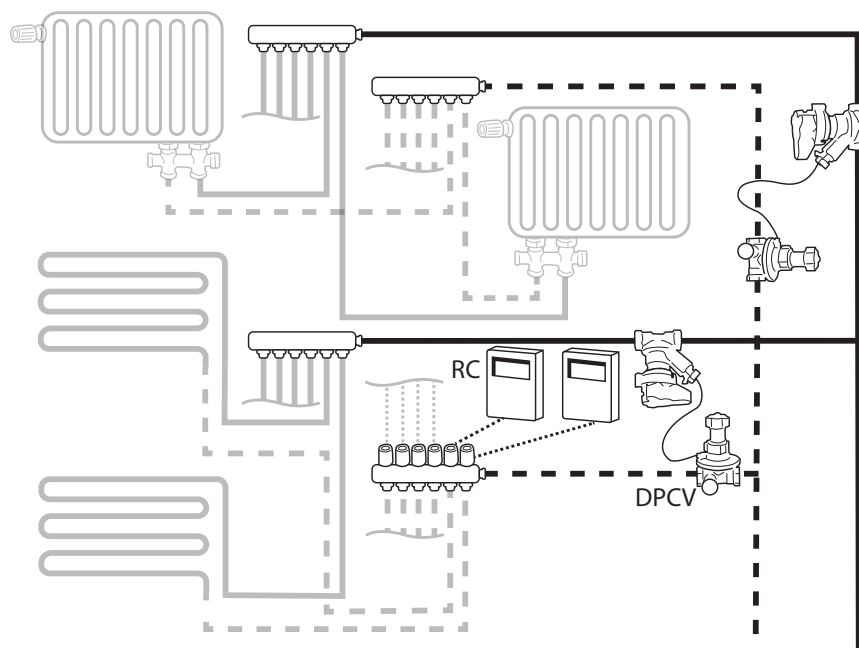
Heating  Cooling  $\Delta p$  control for manifold with individual zone/loop control

## Danfoss products:



Manifold: FHF + TWA-A



DPCV: ASV-PV + ASV-BD

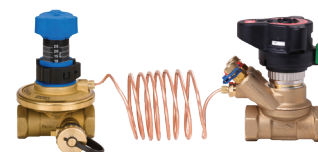

## Explanation

## Return of investment

- Beside manifold we need DPCV with partner valve\*. Heat meter is often used for individual flat connections
- Thermal actuator for zone control (floor heating) or thermostatic sensor (radiator)
- Commissioning is not needed,  $\Delta p$  setting and flow setting on manifold loops only
- With additional investment, the users' comfort can be increased with individual, time based wired or wireless room temperature control
- Variable speed pump is recommended

## Design

- Simple DPCV sizing according kvs calculation and total flow demand of manifold
- Presetting calculation is needed for built in zone valves only
- The presetting of loops, limiting the flow to be ensured no under/overflow on connections

## Operation/Maintenance

- Reliable, pressure independent solution for individual flat/manifold connection
- Partner valve\* can have different functions like, impulse tube connection, shut off, etc.
- Flow setting can be done accurately via  $\Delta p$  setting on DPCV with heat meter most often used
- NO noise risk thanks for  $\Delta p$  controlled manifolds
- High efficiency, especially with individual programmable room control

## Control

- Stable pressure difference for manifolds
- Flow limitation is solved, no overflow\* or underflow per connections
- Thermal actuators (floor heating) ensure manifold or individual time based room temperature zone control (ON/OFF) with suitable room controller
- Thermostatic sensor (radiator) ensures proportional room control with proper Xp band



Heating  Cooling

## Δp control and flow limitation for manifold with central zone control

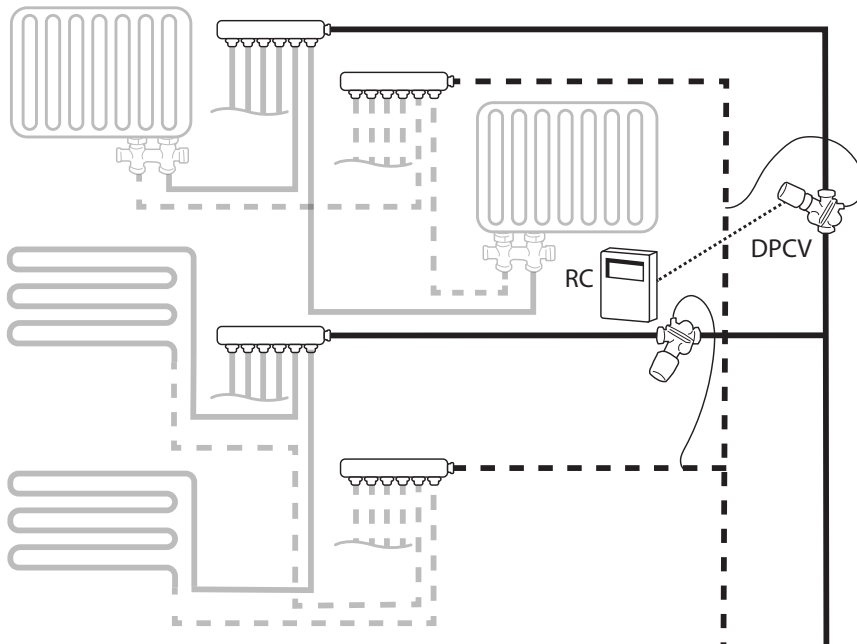

Danfoss products:



Manifold: FHF

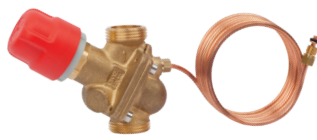

ABV: AB-PM +TWA-Q (optional)



Recommended



## 1.2.1.6

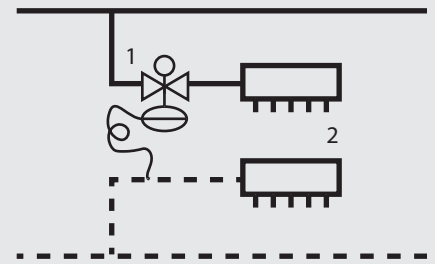

1. Δp controller (DPCV)
2. Manifold with presettable valves

In this application we ensure variable flow\* in the distribution pipeline and maximum pressure difference on each manifold independently from temporal load and pressure fluctuation in the system. Furthermore, we limit the flow for manifold and able to ensure zone control with adding thermal actuator on DPCV. Applicable for both radiator and floor heating systems.

### Explanation

#### Return of investment

- DPCV and impulse tube connection needed only. Heat meter often used for individual flat connection
- Thermal actuator for zone control as option (installed on DPCV)
- Individual zone control (floor heating) or thermostatic sensor (radiator) also possible
- Installation time can be reduced with usage of set solution
- Commissioning is not needed, flow setting on DPCV only and presetting of each loop
- Variable speed pump is recommended

#### Design

- Simple, no kvs and authority\* calculation, valve selection based on flow rate and Δp demand of loop
- Presetting calculation is needed for built-in zone valves (if there are)
- The presetting of flow limitation ensures no under/overflow on manifold
- Pump head calculation is very simple, min available pressure difference for DPCV (included the loop Δp) is given

#### Operation/Maintenance

- Reliable, pressure independent solution for individual flat connection
- Partner valve\* – if applied – can have different functions like, impulse tube connection, shut off, etc.
- No noise risk thanks to Δp controlled manifold
- High efficiency, especially with individual programmable room control

#### Control

- Maximized pressure difference for manifold
- Flow limitation is solved, no overflow\* or underflow per connections
- ...but slight overflow within the loop during partial load
- Thermal actuator ensures zone control (ON/OFF) with suitable room controller

### Performance

#### Return of investment

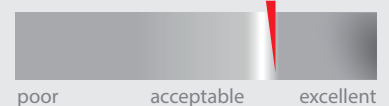

#### Design

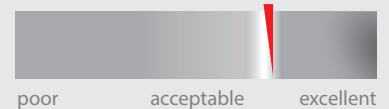

#### Operation/Maintenance



#### Control

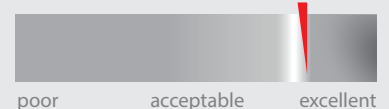

\*see page 54-55



Recommended

## 1.2.2.1

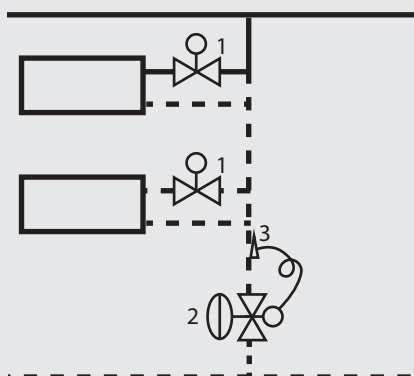

1. Radiator Valve (TRV)
2. Pressure Independent Control Valve (PICV)
3. Optional - Temperature Sensor (QT)

This application is suitable for renovating of vertical one-pipe radiator heating system. We recommend high capacity thermostatic radiator valve and flow limiter installation on riser. For better efficiency we optionally recommend to use return temperature control with QT (Thermostatic Sensor)

## Performance

## Return of investment



## Design



## Operation/Maintenance

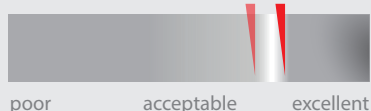

## Control



With QT      Without QT

Heating  Cooling 

## One-pipe radiator heating system renovation with automatic flow limitation and possible self-acting return temperature limitation

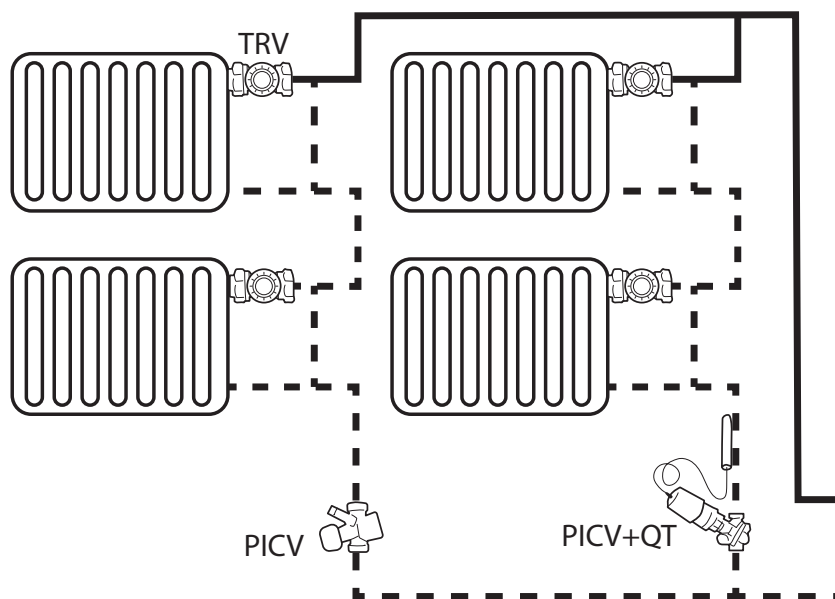

## Danfoss products:



TRV: RA-G + RA



PICV: AB-QM

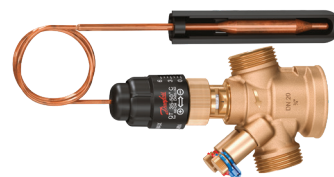

PICV+QT: AB-QT

## Explanation

## Return of investment

- Investment cost are higher (thermostatic radiator valve + flow limiter + QT on risers) compared to manual balancing
- Simple QT installation with low extra cost
- No commissioning\* demand only flow setting
- Variable speed pump is recommended (without QT the pump control is not needed)

## Design

- „ $\alpha$ “ (radiator share) calculation with iteration
- Big capacity TRV is needed to increase the „ $\alpha$ “
- Radiator size depends on flow temperature changes
- Gravitation effect should be taken into account
- Simple hydronic calculation regarding riser controller, selection based on flow rate but we need to ensure the minimum available pressure on it
- QT setting depends on system conditions

## Operation/Maintenance

- System less sensitive for gravitation effect due to flow limitation
- „ $\alpha$ “ (radiator share) sensitive for installation punctuality
- Real constant flow\* without QT, variable flow\* with QT
- QT contributes to energy saving\* on pumping
- QT ensures more accurate heat cost allocation

## Control

- Accurate and simple water distribution among risers
- Improved room temperature control
- The radiator heat emission depends on varying flow temperature
- Heat gain from pipe in the rooms affects the room temperature
- QT effect is limited in case of higher outdoor temperature

Heating  Cooling

# One-pipe radiator heating system renovation with electronic flow limitation and return temperature control

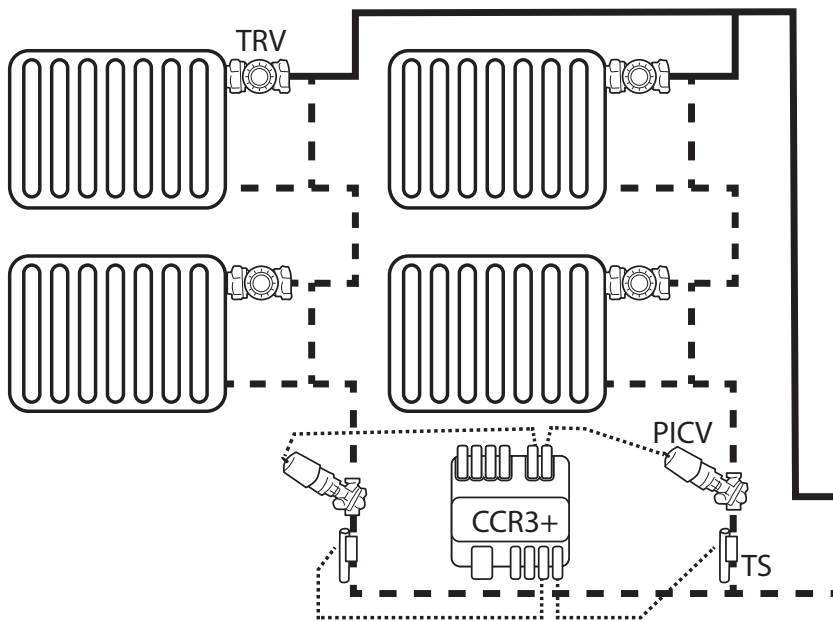

Danfoss products:



TRV: RA-G + RA



PICV: AB-QM+TWA-Q



CCR3+

Recommended



## 1.2.2.2

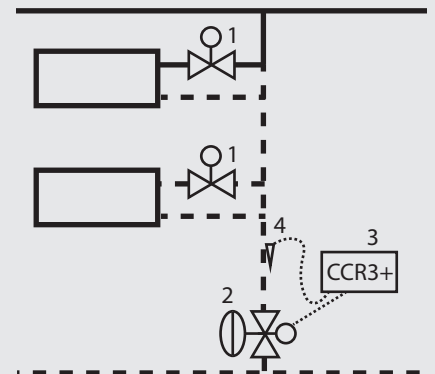

1. Radiator Valve (TRV)
2. Pressure Independent Control Valve (PICV)
3. Electronic Controller (CCR3+)
4. Temperature sensor (TS)

This application is suitable for renovating of vertical one-pipe radiator heating system. We recommend high capacity thermostatic radiator valve and flow limiter installation on riser. For best efficiency we recommend to use CCR3+ (Electronic Controller)

### Explanation

#### Return of investment

- High investment cost (thermostatic radiator valve + flow limiter with thermal actuator, sensor on risers + CCR3+)
- Electronic wiring is needed, programming CCR3+
- No commissioning\* demand only flow setting
- Variable speed pump is recommended

#### Design

- „ $\alpha$ “ (radiator share) calculation with iteration
- Big capacity TRV is needed to increase the „ $\alpha$ “
- Radiator size depends on flow temperature changes
- Gravitation effect should be taken into account
- Simple hydronic calculation regarding riser controller, selection based on flow rate but we need to ensure the minimum available pressure on it
- Defining of needed return characteristic

#### Operation/Maintenance

- The system less sensitive for gravitation effect due to flow limitation
- „ $\alpha$ “ (radiator share) sensitive for installation punctuality
- Programming CCR3+, data logging, remote maintenance and access
- Higher efficiency due to improved  $\Delta T$ , and reduced pipe heat loss

#### Control

- Accurate and simple water distribution among risers
- Improved room temperature control
- The radiator heat emission depends on varying flow temperature
- Heat gain from pipe in the rooms affects the room temperature
- CCR3+ Weather compensation on return temperature on all individual risers

### Performance

#### Return of investment

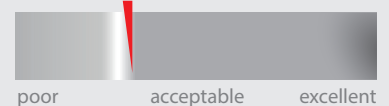

#### Design

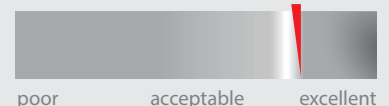

#### Operation/Maintenance

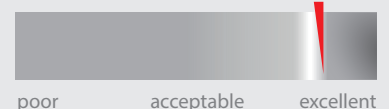

#### Control

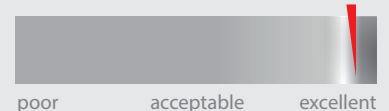

\*see page 54-55

**Not Recommended**Heating  Cooling 

## 1.2.2.3

### One-pipe radiator heating system renovation with manual balancing

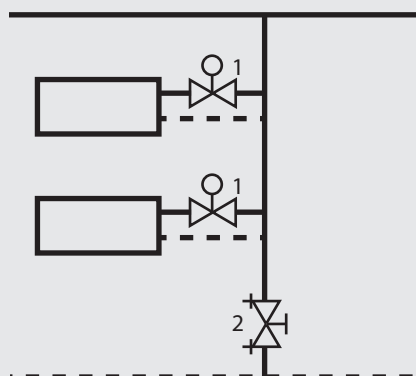

1. Radiator Valve (TRV)
2. Manual Balancing Valve (MBV)

This application is suitable for renovating of vertical one-pipe radiator heating system. Many one-pipe system are renovated based on thermostatic radiator valves and manual balancing valves. It is not recommended due to its low efficiency.

#### Performance

##### Return of investment



##### Design

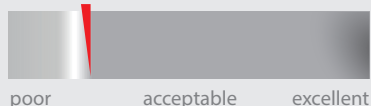

##### Operation/Maintenance

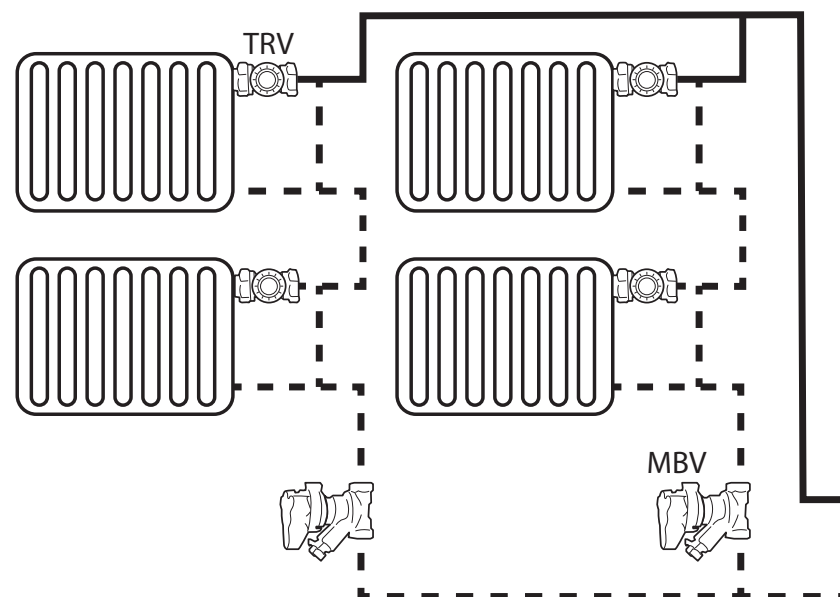

##### Control

**Danfoss products:**

TRV: RA-G +RA



MBV: MSV-BD

#### Explanation

##### Return of investment

- Medium investment cost (thermostatic radiator valve + manual balancing)
- Commissioning\* is needed
- Complaints can occur when not proper commissioning
- Traditional constant speed pump is acceptable

##### Design

- Difficult sizing of hydronic, presetting calculation of MBV is important
- „ $\alpha$ “ (radiator share) calculation with iteration
- Big capacity TRV is needed to increase the „ $\alpha$ “
- Radiator size depends on flow temperature changes
- Gravitation effect should be taken into account

##### Operation/Maintenance

- System sensitive for gravitation effect (over/under pumping) during operation
- „ $\alpha$ “ (radiator share) sensitive for installation accuracy
- Not real constant flow\*, the flow rate can vary 70-100% according to the radiator valve operation
- High pumping energy consumption due to „constant“ flow
- Inefficient system, during partial load (when TRVs are closing) too high inlet temperature into radiators and overall return temperature

##### Control

- Inaccurate room temperature control
- The radiator heat emission depends on varying flow temperature
- Heat gain from pipe in the rooms affects the room temperature
- Inaccurate heat cost allocation

Heating  Cooling

# One-pipe horizontal heating systems with thermostatic radiator valves, flow limitation and return temperature self-acting control

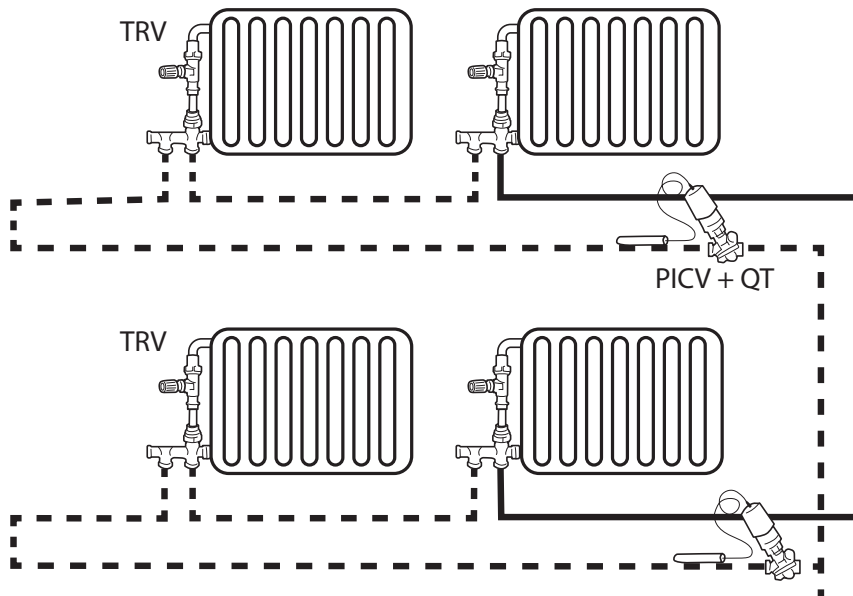

Danfoss products:

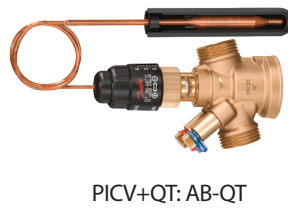

Acceptable



## 1.2.2.4

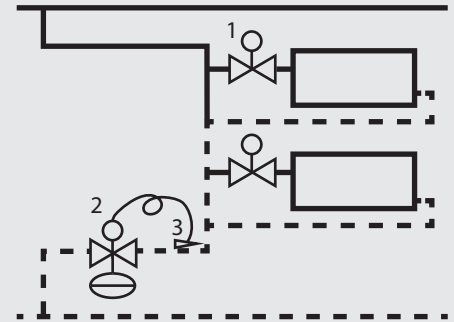

1. Radiator Valve (TRV)
2. Pressure Independent Control Valve (PICV)
3. Temperature Sensor (QT)

In this application we ensure automatic flow limitation for all heating circuits and limit the return temperature with QT (Thermostatic Sensor) to avoid small  $\Delta T$  in the loops during partial load. (More efficient in case of lower outdoor temperature.)

### Explanation

#### Return of investment

- Investment cost – good (thermostatic radiator valve + flow limiter + QT on risers)
- Less valves than in case of manual balancing, lower installation costs
- Simple QT installation and setting. (Re-set recommended based on operational experience)
- Commissioning\* of the system not required (only flow and temperature setting)
- Variable speed pump is recommended

#### Design

- Traditional radiator connection „a“ (radiator share) effect on radiator selection
- Simplified hydraulic calculation, the loops are pressure independent
- No TRV presetting
- Return temperature setting on sensor of flow limiter according to system features
- Pump head calculation according to nominal flow and dp demand of flow limiter
- Heat metering applicable

#### Operation/Maintenance

- Minimal length of pipeline
- Higher pump head demand (vs. two pipe), due to minimum  $\Delta p$  on flow limiter, higher pressure loss on pipeline, big  $\Delta p$  on radiator valve if no big Kvs selected
- The heat output of radiator depending on partial load condition due to varying inlet temperature
- Optimization\* of pump head is recommended (if variable pump control is available)

#### Control

- Thermostatic radiator valve has small  $X_p$  value
- Flow restriction in loop via QT when return temperature is increasing
- Loop flow demand is varying according to partial load condition
- Hydraulic regulation only at the end of loop, balancing at full and partial load – good
- Room temperature oscillation\* occurs

### Performance

#### Return of investment



#### Design

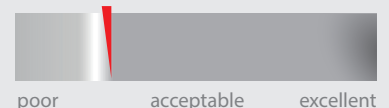

#### Operation/Maintenance

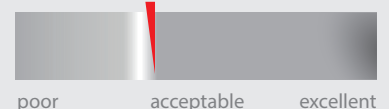

#### Control



\*see page 54-55

**Recommended**

## 1.2.3.1

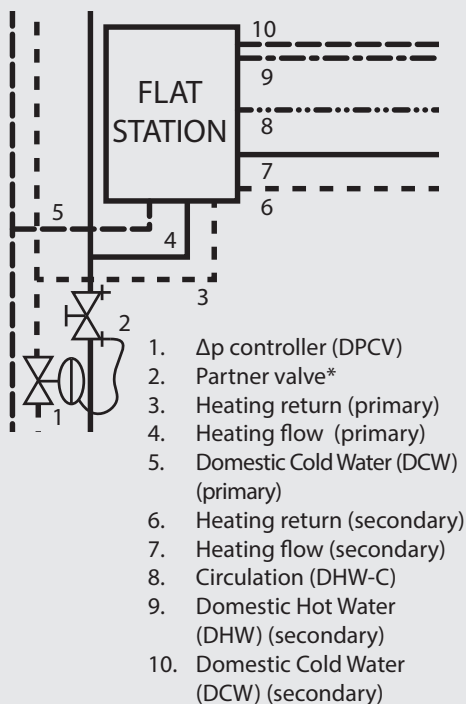

In this application we use 3 pipes only (heating flow / return and cold water), for heating of the flats and instantaneous DHW\* preparation locally (at the flat). We ensure variable flow\*,  $\Delta p$  control for heating system and flow limitation on riser taking into consideration the simultaneous effect

### Performance

#### Return of investment

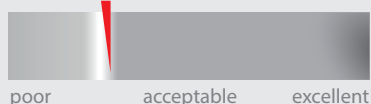

#### Design

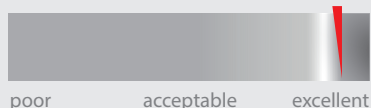

#### Operation/Maintenance

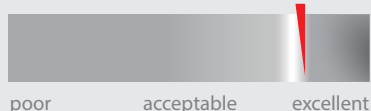

#### Control

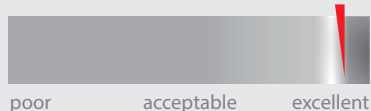
Heating  Cooling  Water supply 

## Three-pipe, flat station system; $\Delta p$ controlled heating and local DHW\* preparation

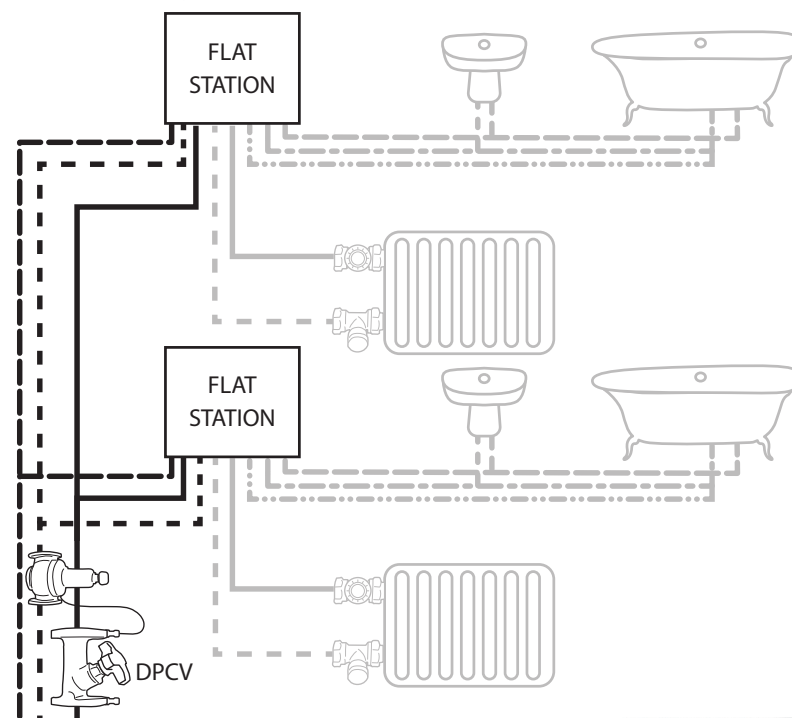
**Danfoss products:**

DPCV: ASV-PV + MSV-F2

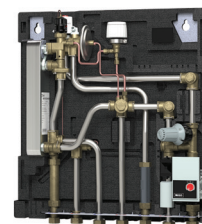

Flat Station: Evoflat

### Explanation

#### Return of investment

- Investment cost are significant (flat stations, MBV in front of flats +  $\Delta p$  control in risers) but they are worth to be considered taking into account the full investment cost
- Less pipeline and additional equipment (no primary DHW\*system), less installation cost
- Commissioning \*of MBV and setting of DPCV with flow limitation is needed
- Variable speed pump is recommended (constant pump characteristic)

#### Design

- Special hydraulic calculation is needed for pipeline: the size of pipeline depends on simultaneous factor
- Presetting calculation for TRVs is needed
- Riser  $\Delta p$  controller:  $\Delta p$  setting (flat station + pipeline) + flow limitation according simultaneous effect
- The flat station is equipped with  $\Delta p$  controller for heating
- Flat pump characteristic is advantage, fast reaction VSD\* needed (due to very fast load changes in the system based on DHW\* fluctuation)

#### Operation/Maintenance

- $\Delta p$  controlled TRV ensures good room temperature control
- Heat losses on primary pipe are low (one hot pipe instead of two)
- Higher pump head demand – high  $\Delta p$  demand on flat station and extra pressure loss on  $\Delta p$  controller + flow limiter required
- Simple system setup, easy energy metering
- No legionella problem

#### Control

- Balancing at full and partial load very good
- Energy efficient solution, low heat loss in the system
- High comfort; TRV and/or time control possible
- Pressure independent DHW\* preparation,  $\Delta p$  controlled heating, flow limitation on riser

Heating  Cooling

## Mixing with PICV – manifold with pressure difference

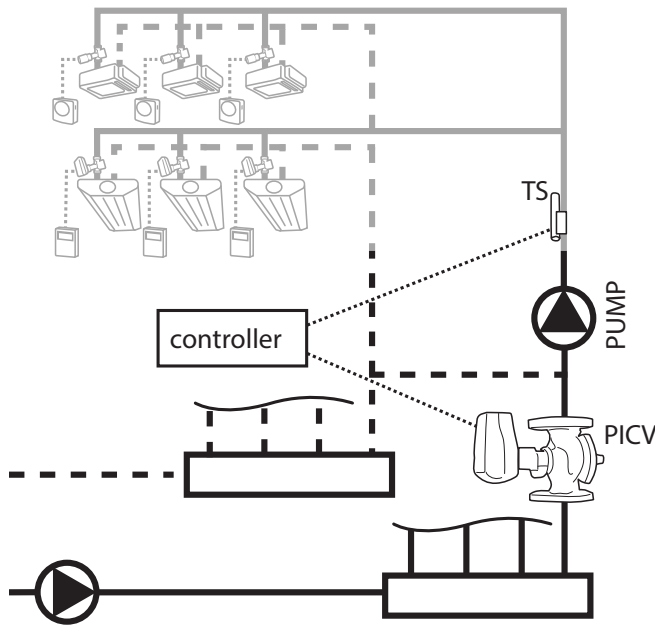

Danfoss products:



PICV: AB-QM + AME435QM

### Explanation

#### Return of investment

- Minimum number of components - no MBV needed
- Low installation cost
- Primary pumps needed to cover the  $\Delta p$  demand up to mixing points
- MBV is needed on the secondary side if there is no VSD\* or pressure stabilization
- Balancing on secondary side is required
- VSD on primary side is recommended

#### Design

- Easy PICV selection based on flow requirement
- The PICV valve size can be smaller if the secondary temperature is lower than the primary temperature
- Perfect hydronic balance and control at all loads,
- Min available  $\Delta p$  demand on the valve should be taken for primary pump selection
- Proportional primary pump control can be used

#### Operation/Maintenance

- Simplified construction due to a reduction of components
- No balancing needed, just setting the flow on the PICV
- Non-return valve is recommended in the by-pass line to prevent back-flow if the secondary pump stops
- Flexible solution; the flow rate setting does not influence the other mixing loops
- Low operational and upkeep cost

#### Control

- Full authority\* of control valve, precise control of secondary water temperature
- No overflows\*
- Pressure independent solution, no interference from pressure fluctuations in the system
- Linear system response matches with linear PICV characteristic
- Room temperature oscillation\* occurs

Recommended



2.1

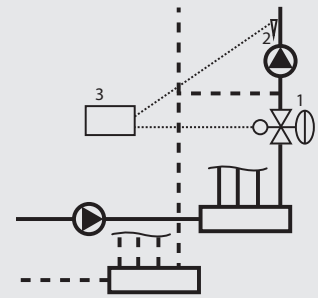

1. Pressure Independent Control Valve (PICV)
2. Temperature sensor (TS)
3. Controller

Regardless of pressure fluctuations in the system, we have the right flow for the temperature control of the secondary side. The PICV valve ensures the mixed/controlled flow temperature circulated by the secondary pump. The primary pump ensures the needed pressure difference up to the mixing points including the  $\Delta p$  demand of PICV.

The individual terminal unit should be controlled according to applications is chapter 1 or 2. One possibility is shown in the drawing.

### Performance

#### Return of investment

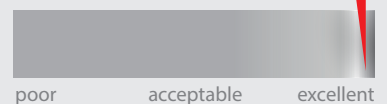

#### Design

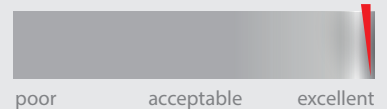

#### Operation/Maintenance

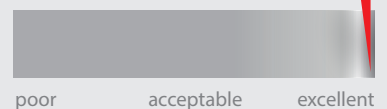

#### Control

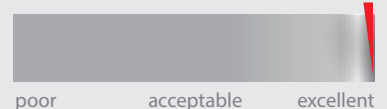

\*see page 54-55



Acceptable

## 2.2

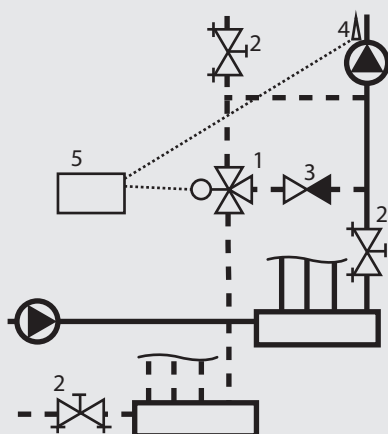

1. 3 - way Control Valve (CV)
2. Manual Balancing Valve (MBV)
3. Non-Return Valve (N-RV)
4. Temperature Sensor (TS)
5. Controller

The 3-way valve controls the flow to ensure the required temperature on the secondary side. The circulation pump and the MBV on the secondary side are needed to ensure mixing and (usually) a constant flow\* through the loop (for example with radiant heating). A 3-way valve and MBV are used in the primary circuit to ensure proper temperature control for the loop and balancing the circuits. It should only be used in case of big temperature differences between primary and secondary.

## Performance

## Return of investment

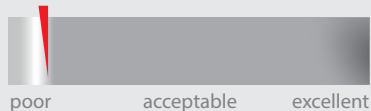

## Design

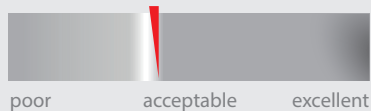

## Operation/Maintenance

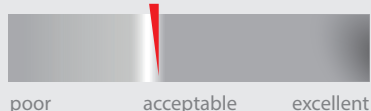

## Control

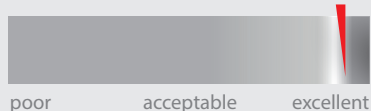
Heating Cooling 

## Injection (constant flow) control with 3-way valve

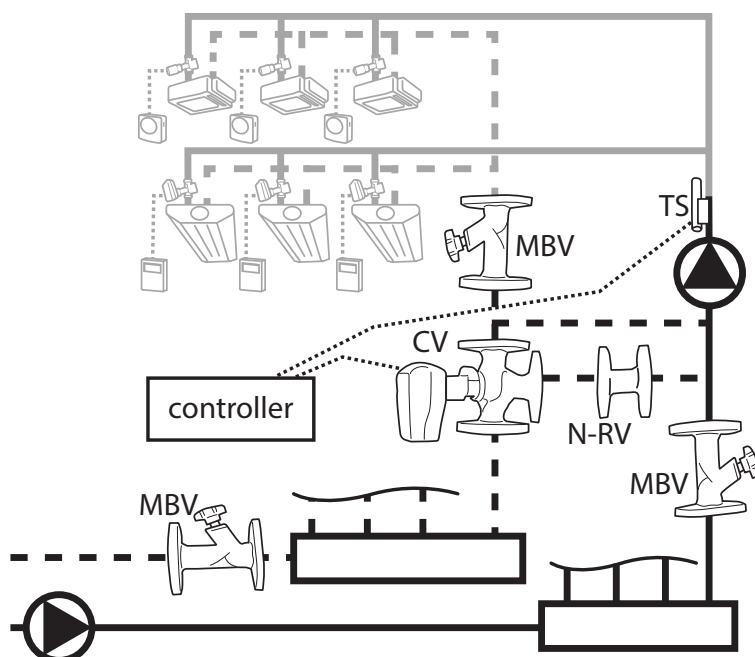

Danfoss products:



CV: VF3 + AME435



MBV: MSV-F2

## Explanation

## Return of investment

- Very high: 3-way valve + 2xMBV for balancing and control (partner valve\* for the pump is needed for the pump head setting)
- More valves result in higher installation cost
- Both MBVs have to be balanced
- No VSD\* required on the primary side because of constant flow\*

## Design

- The 3-way valve has good authority\* because of the small pressure drop on the primary network
- The 3-way valve should be sized accordingly to the flow rate of the primary side
- Kv and flow pre-setting calculation of the MBV is essential for the flow setting
- MBV is calculated based on the nominal condition and is valid for all system loads

## Operation/Maintenance

- Complicated system setup with many valves and a lot of balancing
- Slight flow changes during partial load due to ideal authority\* of the 3-way valve
- Simple balancing of the secondary MBV but complex balancing is needed on the primary side
- A non-return valve is recommended in the by-pass line to prevent back-flow if the secondary pump stops
- In case of a low secondary energy demand the  $\Delta T$  of the primary circuit will drop
- No possibility of energy saving\* on the pump because of constant flow\*

## Control

- Good control thanks to high authority\* of the control valve
- Constant flow, so no pressure oscillation. Therefore there is no interference among loops
- Low  $\Delta T$  syndrome\* in cooling
- Recommended only if the secondary flow temperature is significantly lower than the primary



Heating  Cooling

## Mixing with 3-way valve – manifold without pressure difference

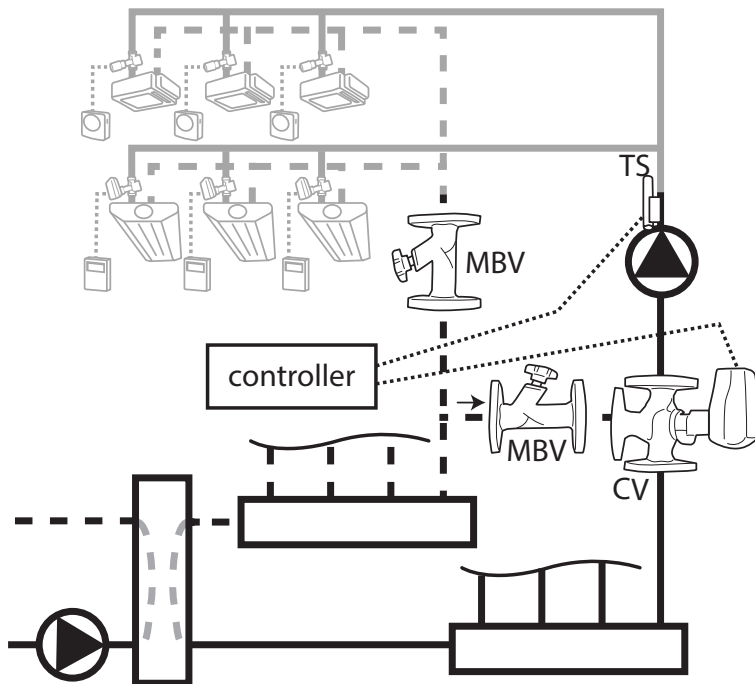

Danfoss products:



CV: VF3 + AME435

MBV: MSV-F2

### Explanation

#### Return of investment

- 3-way valve and MBV are needed, more valves results in higher installation cost
- The balancing of the MBV is important
- The secondary side should be equipped with a variable speed drive (variable flow)
- Balancing of the secondary side is needed
- Primary pump control should be done by return temperature if possible, which results in additional controller cost

#### Design

- Simple 3-way valve sizing (50% of the pump head should drop on the control valve)
- Linear 3-valve and actuator characteristic is needed
- Kv and pre-setting calculation for MBV are essential for compensating  $\Delta p$  differences between the by-pass line and the manifold loop towards de-coupler
- Secondary pump needs to cover the  $\Delta p$  demand from and to the de-coupler

#### Operation/Maintenance

- Complicated system setup with several valves and balancing of the MBVs is required
- For stable operation of the 3-way valve the authority\* and rangeability need to be taken into consideration
- If the primary pump is not controlled water will be circulated back needlessly during partial load
- Low energy efficiency due to low  $\Delta T$  and high pump head demand on the primary pump

#### Control

- Good control if the authority\* is 50% or higher \*
- Very low overflows\* on the secondary side
- The mixing loops are pressure independent
- Low  $\Delta T$  syndrome \* primary pump is not properly controlled
- The linear system response is combined with a linear 3-way valve characteristic, so temperature is stable control

Not Recommended



2.3

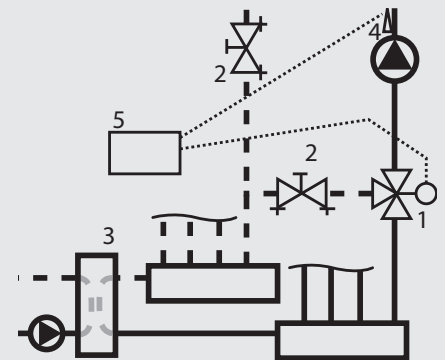

1. 3 - way Control Valve (CV)
2. Manual Balancing Valve (MBV)
3. De-coupler
4. Temperature Sensor (TS)
5. Controller

The 3-way valve controls the flow temperature on the secondary side. This setup allows different flow rates in the primary- and secondary loops. The secondary pump circulates the water through the system included manifolds and de-coupler. Primary pump is located before de-coupler, there is no pressure difference between manifolds.

The individual terminal unit should be controlled according to applications in chapter 1 or 2. One possibility is shown in the drawing.

### Performance

#### Return of investment

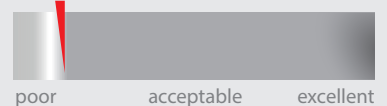

#### Design

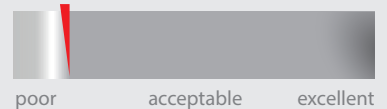

#### Operation/Maintenance

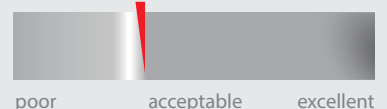

#### Control

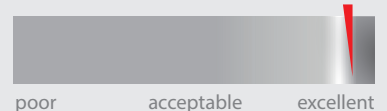

\*see page 54-55

**Recommended**

## 3.1.1

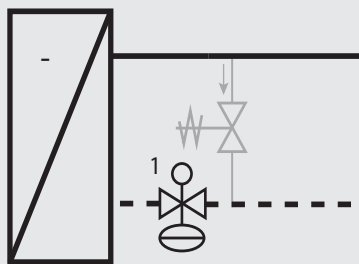

1. Pressure Independent Control Valve (PICV)

A PICV is used to control the AHU so that regardless of pressure fluctuations in the system we secure the right flow. It is applicable if  $\Delta p$  is available for PICV. A by-pass is recommended to be used in front of the PICV (light gray) to ensure proper flow temperature in partial load also, when there is no circulation in AHU at all. Different types of by-pass control can be used. (see page 38).

### Performance

#### Return of investment

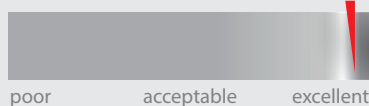

#### Design

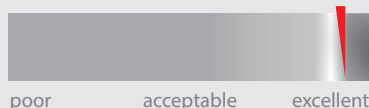

#### Operation/Maintenance

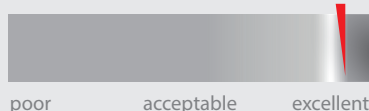

#### Control

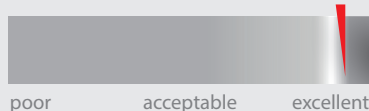
Heating  Cooling 

## Pressure Independent Control (PICV) for cooling

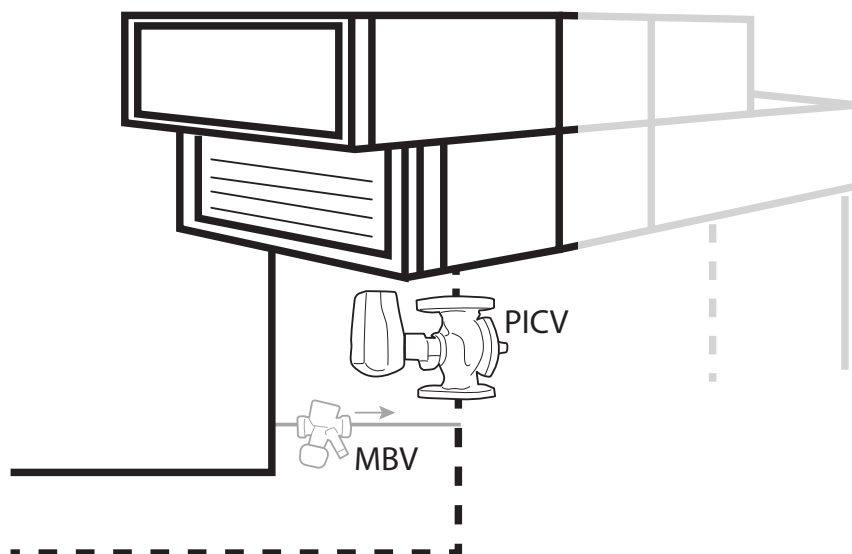
*Danfoss products:*

PICV: AB-QM + AME345QM

### Explanation

#### Return of investment

- A minimal number of components because there is no MBV on primary side and/or partner valves\* are needed. Consequently, there is a low installation cost
- Minimal complaint costs because of perfect balance at all loads
- No balancing\* needed
- Energy efficient because of proper  $\Delta T$  in the system

#### Design

- Easy selection of valves based only on the flow requirement
- No Kv or authority\* calculation is needed. The flow pre-setting calculation is based on the flow demand
- Perfect balance at all loads
- Proportional pump control is recommended.
- Minimum available  $\Delta p$  demand on the valve should be used to select the primary pump

#### Operation/Maintenance

- Simplified construction because of a reduced number of components
- Set and forget, no complicated balancing procedures are needed for the primary side
- Low operational and upkeep cost

#### Control

- Perfect control thanks to full authority \*
- No overflows\*
- Pressure independent solution, no interference from pressure fluctuations anywhere in the system
- No low  $\Delta T$  syndrome \*
- Stable temperature control without hunting of the valve

Heating  Cooling

## 3-way valve control for cooling

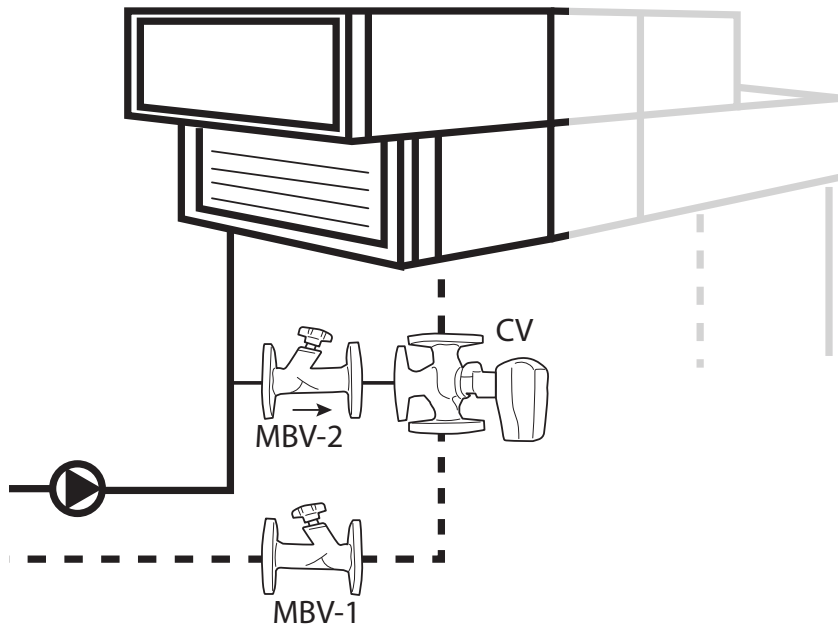

Danfoss products:



MBV-1: MSV-F2

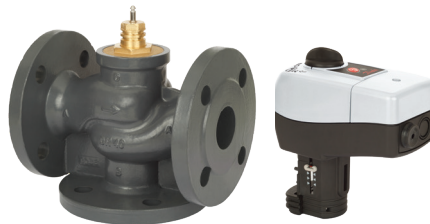

CV: VF3 + AME435

### Explanation

#### Return of investment

- Many components are needed: a 3-way valve and 2\*MBV, and additional partner valves for commissioning\* in bigger system
- Extremely high operational cost, very energy inefficient
- The flow is close to constant, no VSD applied
- In partial loads very low  $\Delta T$  in the system, so chillers run at very low efficiency

#### Design

- Kvs calculation is required, as well as an authority calculation\* for the 3-way valve
- Presetting of MBVs crucial for proper system operation and control
- The by-pass MBV needs to be calculated to compensate the pressure drop of terminal unit, otherwise big overflows occur in partial loads causing terminal unit starvation and energy inefficiency
- High (min. 1:100) control ratio is needed for proper low flow control on 3-way valve

#### Operation/Maintenance

- Commissioning of the system is required
- The hydraulic balance at full and partial load is acceptable
- Huge pump energy consumption due to constant flow operation
- High energy consumption (low  $\Delta T$ )

#### Control

- Good control in case of ~50% authority\* on 3-way valve
- Constant flow, no pressure oscillation, consequently no interference among AHUs
- Low DT syndrome \*
- The room temperature control is satisfactory...
- ... but high energy consumption because of low  $\Delta T$  reduces chiller efficiency and constant pumping consumes more electricity

Not Recommended



## 3.1.2

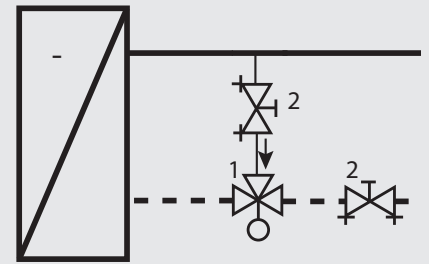

1. 3 - way Control Valve (CV)
2. Manual Balancing Valve (MBV)

Controlling the room temperature based on controlling the supply air to the room is common. This can be done with a 3-way valve. An MBV is needed in the by-pass to compensate for the difference between the pressure drop of the AHU and the by-pass. Additionally, an MBV is needed in the primary circuit to be able to balance the AHUs. The flow rate on primary side nearly constant all the time

### Performance

#### Return of investment

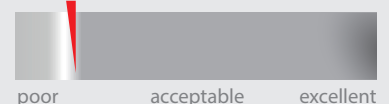

#### Design

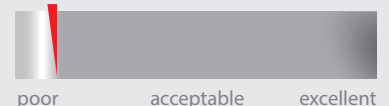

#### Operation/Maintenance

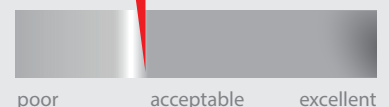

#### Control

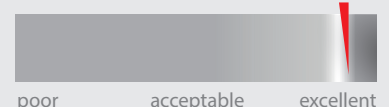

\*see page 54-55



Recommended

## 3.2.1

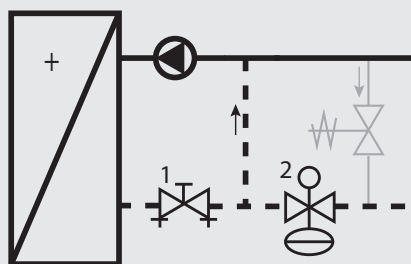

1. Pressure Independent Control Valve (PICV)
2. Manual Balancing Valve (MBV)

A PICV is used to control the AHU so that regardless of pressure fluctuations in the system we secure the right flow. It is applicable if  $\Delta p$  is available for PICV. A circulation pump and an MBV are needed to ensure constant flow\* through the coil, therefore freezing of the coil can be avoided. A by-pass is recommended (at last AHU in the circuit) to be used in front of the PICV (light gray) to ensure proper flow temperature in partial load also, when there is no circulation in AHU at all.

Different types of by-pass control can be used. (see page 38).

## Performance

## Return of investment

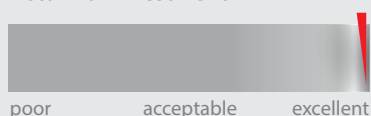

## Design



## Operation/Maintenance

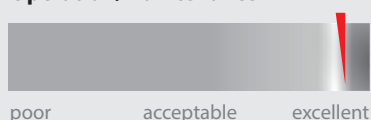

## Control

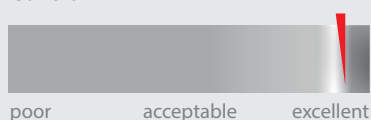
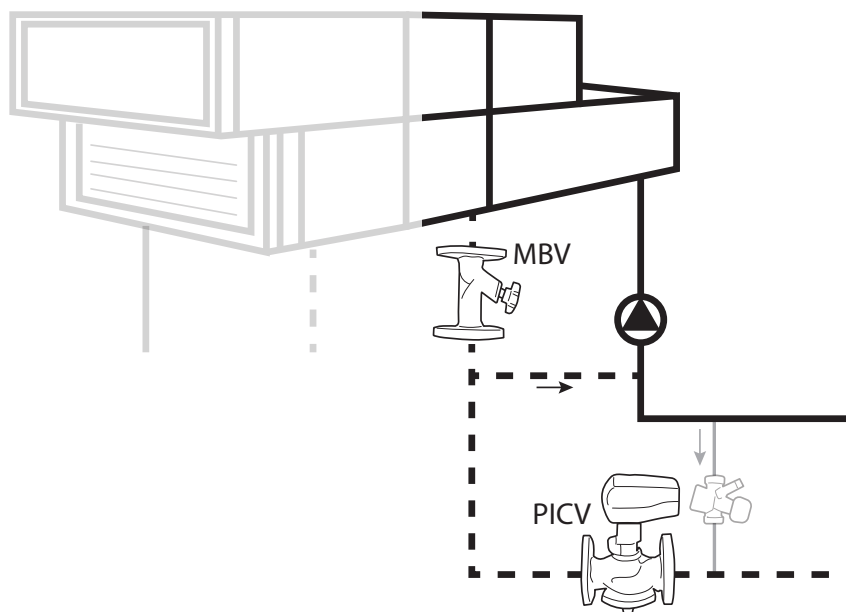
Heating  Cooling Pressure Independent Control (PICV)  
for heating

Danfoss products:



MBV: MSV-F2



PICV: AB-QM + AME345QM

## Explanation

## Return of investment

- Minimal number of components (no MBV on primary side and partner valves\* are needed. Consequently, installation cost is low)
- Minimal complaint costs because of perfect balance at all loads
- No commissioning\* needed (MBV setting only for nominal flow setting on the pump)
- Efficient boiler usage because of proper  $\Delta T$  in the system

## Design

- Easy selection of valves based only on flow requirement
- No Kv or authority\* calculation is needed, flow presetting calculation is based on flow demand
- Proportional primary pump control is applicable. Pump without control in secondary side
- Min available  $\Delta p$  demand on the valve should be taken for primary pump selection
- The PICV valve size can be smaller if secondary flow temperature is lower than the primary
- Usage of SMART actuator\* ensures peripheral device connection, energy allocation, energy management, etc.

## Operation/Maintenance

- Simplified construction thanks to reduction of components
- Set and forget, no complicated balancing procedures are needed for primary side
- Simple setting of MBV on secondary side
- Low operational and upkeep cost
- Secondary pump contributes to frost protection (easily manageable with SMART actuator\*)

## Control

- Perfect control because of full authority \*, no overflows\*
- Pressure independent solution, no interference from pressure\* fluctuations anywhere in the system
- Stable\* air temperature control in AHU without oscillation
- I/O connections to SMART actuator\* can be used for additional control features of AHU

Heating  Cooling

## 3-way valve control for heating

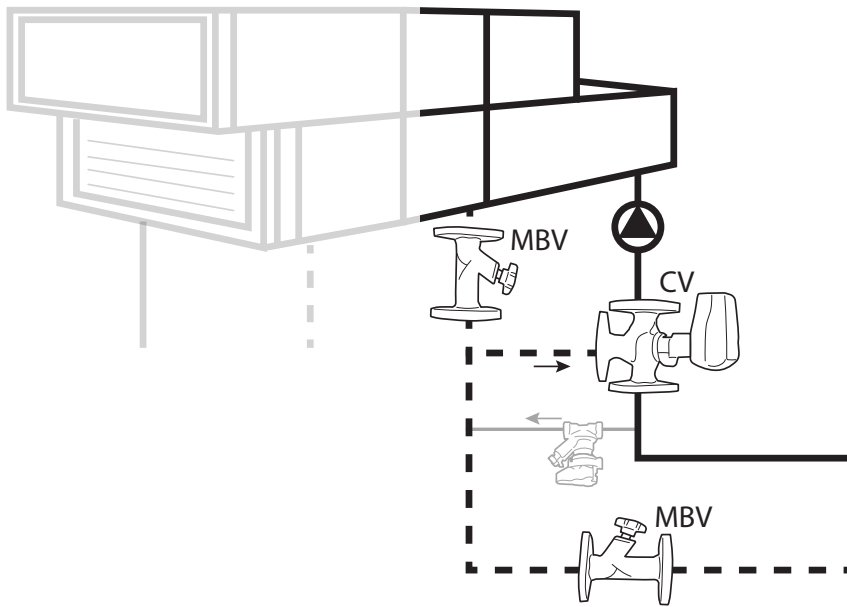

Danfoss products:

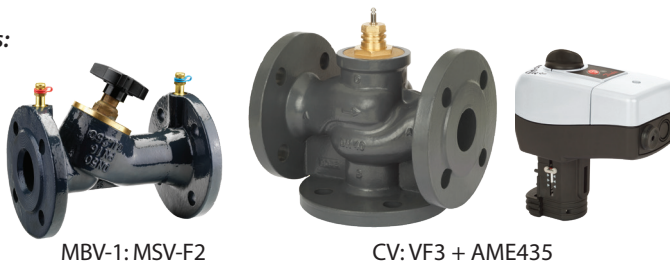

### Explanation

#### Return of investment

- 3-way valve and 2 MBVs for balancing and control are needed as well as branch valves in bigger system for balancing
- More valves result in higher installation costs
- Both MBVs have to be balanced
- Complaint cost expected due to low authority\* of 3-way valve

#### Design

- Sizing of the 3-way valve should be done according to the flow rate in the secondary side in case of lower  $\Delta T$
- Kv and flow pre-setting calculation of the MBVs is essential
- Pre-setting of the primary side MBV is valid at full load only, overflows will occur during partial loads
- The secondary pumps do not need a VSD\* as they run on full load at all loads

#### Operation/Maintenance

- Complicated system setup with several valves and a lot of balancing
- Hunting of the 3-way valve can occur, shortening the valve's lifespan
- Simple setting of the MBV on the secondary side
- Overflows reduce the energy efficiency
- Commissioning of primary side is crucial

#### Control

- Bad control ability at low loads
- Overflows\* can occur depending on the authority\* of the 3-way valve
- Not a pressure independent solution, therefore the available pressure widely oscillates on the 3-way valve on the primary side
- Unacceptable temperature control at low loads

\*see page 54-55

Not Recommended



## 3.2.2

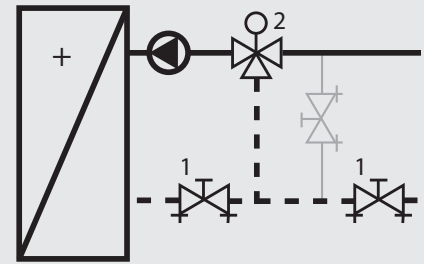

1. 3 - way Control Valve (CV)
2. Manual Balancing Valve (MBV)

Controlling the room temperature based on controlling the air supplied to the room is common. This can be done with a 3-way valve. A circulation pump and an MBV are needed to ensure constant flow\* through the coil, so freezing of the coil can be avoided. Additionally, an MBV is needed in the primary circuit to be able to balance the AHUs.

A by-pass at the furthest unit is recommended to prevent the cooling down of the pipe in low loads.

Different types of by-pass control can be used, see application 2.3.1

### Performance

#### Return of investment



#### Design



#### Operation/Maintenance



#### Control

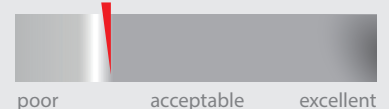

**Recommended**

## 3.3

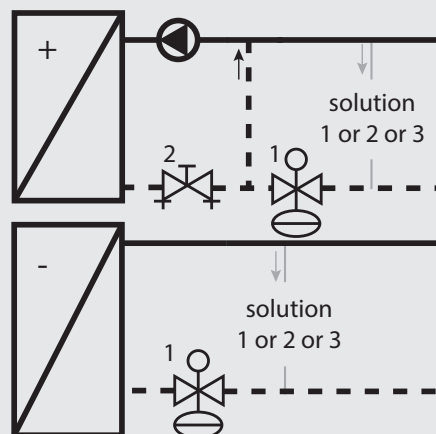

1. Pressure Independent Control Valve (PICV)
2. Manual balancing valve (MBV)



### Performance

#### Return of investment



#### Design

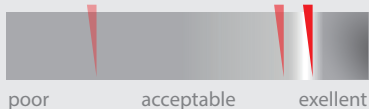

#### Operation/Maintenance



#### Control

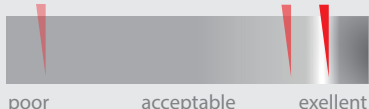

PICV with BMS connectivity  
 with QT  
 MBV

Heating  Cooling 

## Keep proper flow temperature in front of AHU in partial load condition

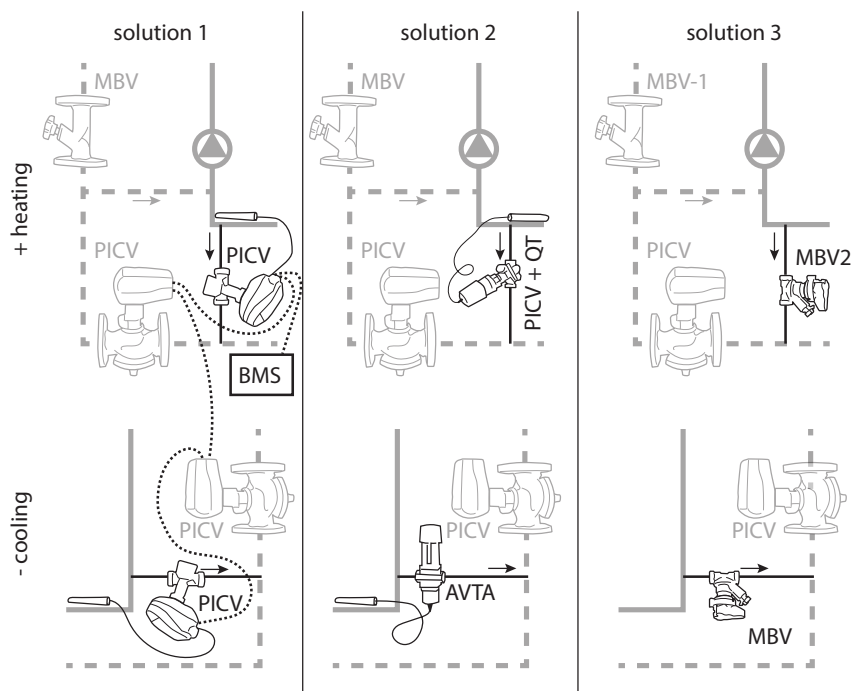

In variable flow\* installations it is possible that the water in the system has such a low flow speed that it warms up (cooling) or cools down (heating) and it will take a while for the AHU to be able to start cooling or heating. In such cases it is recommended to install a bypass at the furthest unit to maintain the temperature in the system. Different types\* of by-pass control can be used. The options are:

- 1) A PICV connected to the BMS system – optional SMART actuator\* to reduce hardware demand,
- 2) Self-acting controls, either a PICV and QT sensor (heating) or an AVTA (cooling),
- 3) An MBV with a constant flow\* setting

### Explanation

#### Return of investment

- Only small valve sizes needed
- Lowering the complexity (going from solution 1-3) reduces cost but also reduces energy efficiency
- Balancing\* is needed in option 3, for 1 and 2 only setting of the flow or temperature is needed
- Solution 1 requires additional cabling and additional programming in the BMS

#### Design

- Flow demand calculation is based on heat loss/gain on the related pipe network
- For 1 and 2 a simple valve is selected based on flow rate. For option 3 a full Kv and pre-setting calculation is needed
- For 1 and 2 flow/temperature setting only. For option 3 balancing is needed
- Option 1 and 2 will only allow the minimum flow needed to maintain the temperature. Option 3 will always have flow, independent of the system load.
- The available pressure is defined by the demand for the PICV of the AHU

#### Operation/Maintenance

- Accurate flow temperature can be controlled independently from the system load
- Some temperature inaccuracy is expected due to the Xp band of the self/acting controller
- Always open by-pass and the flow is changing – in spite of balancing – according to the  $\Delta p$  fluctuations caused by partial loads
- Option 1 and 2 are more energy efficient than option 3 due to minimal flow

#### Control

- 1 and 2 have perfect hydronic balance and control due to pressure independency
- 3 has an unnecessarily high flow through the by-pass during most system loads
- Limited low  $\Delta T$  syndrome\* in appl. 1-2, the  $\Delta T$  on system 3 is significantly smaller
- BMS connectivity ensures a stable flow temperature control and the Smart actuator is able to add further functions like a  $\Delta p$  signal for pump optimization\*
- Lowest energy consumption

Heating  Cooling

## Variable primary flow

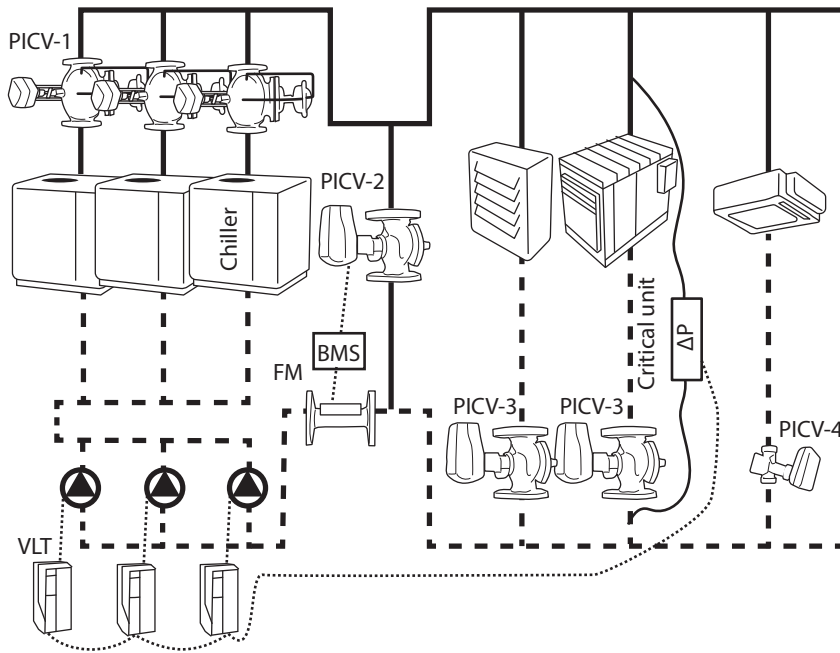

For a variable flow\* system this is considered the most efficient system for a building's thermal operation. The chillers can have multiple variable speed compressors.

This system has a variable primary (and secondary) circuit, where there are no secondary pumps. The by-pass is used to control the minimum flow for the chillers in a partial load operation.

The chillers can be staged according to the optimal efficiency of chillers at certain load. The appropriate flow through on chillers controlled by dedicated PICVs in chiller loop.

### Explanation

#### Return of investment

- More expensive variable speed chillers are required
- Best return on investment if used in combination with PIBC on secondary side as well
- By-pass with PICV and flow meter needed for by-pass control
- PICV for flow setting, isolation and control in line with the chillers. An MBV + isolation valve is an alternative solution in such case that chillers are the same size

#### Design

- PICV selection and flow setting according to the maximum flow demand of the chillers
- By-pass valve is sized according to the chiller's minimum flow requirement
- A PICV installed in each terminal unit on the secondary side is recommended to maximize efficiency
- A VSD\* with a  $\Delta p$  sensor on the critical point is mandatory
- Additional pumps can be added to provide operational reliability

#### Operation/Maintenance

- Simple and transparent construction
- Simple commissioning based only on flow setting. Optimization\* of the pump head is recommended
- Isolation (with PICV) is important for the chillers that are not in operation

#### Control

- Primary pump control based on the  $\Delta p$  signal of the critical unit is recommended to minimize energy use
- The by-pass control ensures the minimum flow needed for chiller operation based on signal of the flow meter
- Small chance on low  $\Delta T$  syndrome\*. Variable speed chillers can handle low flows and therefore the by-pass rarely opens
- Highest efficiency compared to other chilled water systems
- Advanced chiller control logic required to maximize the efficiency

\*see page 54-55

Recommended



4.1

Danfoss products:



PICV-1: AB-QM 4.0 + AME 655



PICV-2,3: AB-QM + AME345QM



PICV-4: AB-QM 4.0 + AME 110

PICV - Pressure Independent Control Valve



VLT\*HVAC Drive FC102



Flow meter FM: SonoMeterS

### Performance

#### Return of investment

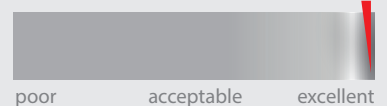

#### Design

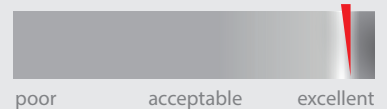

#### Operation/Maintenance

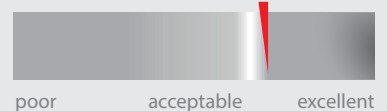

#### Control

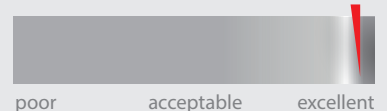



Recommended

## 4.2

Heating  Cooling Constant primary variable secondary  
(Step Primary)

Danfoss products:

PICV - Pressure Independent Control Valve



PICV-1,2: AB-QM + AME345QM



PICV-3: AB-QM 4.0 + AME 110

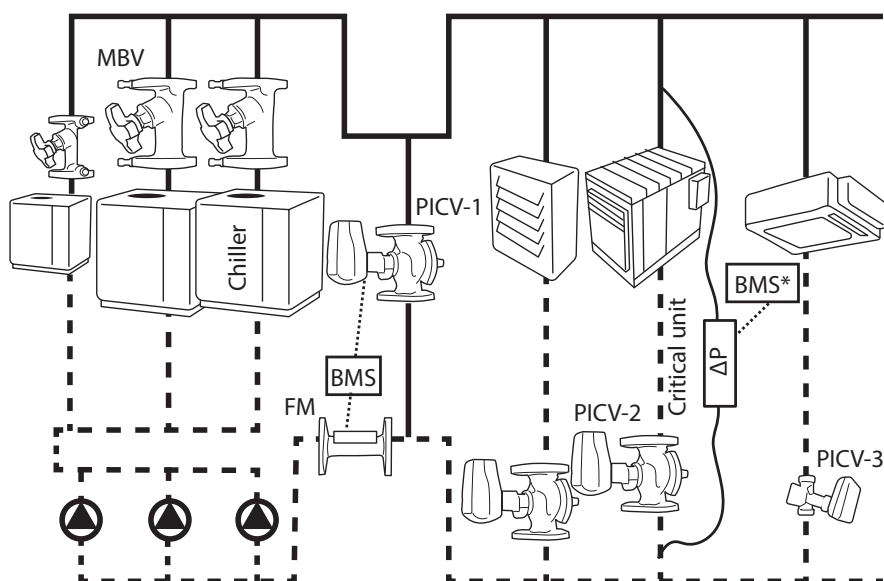

MBV: MSV-F2

Flow meter  
FM: SonoMeterS

\*BMS - only for monitoring, no pump control (optional)

This system has a constant primary circuit, a variable secondary circuit and no secondary pumps. The by-pass is used to control the minimum flow for the chillers. For optimal efficiency a swing chiller is recommended. The chillers can be staged according to the load variation and constant flow\* through the chiller can be maintained by dedicated pump capacity. The appropriate flow through chillers can be ensured by flow meter measurement and control of by-pass. (Secondary side description see applications: 1.1.1.1-1.1.1.3)

## Performance

## Return of investment



## Design

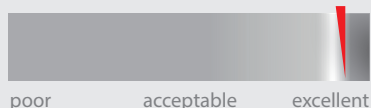

## Operation/Maintenance



## Control

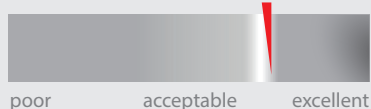

## Explanation

## Return of investment

- Medium investment cost – No secondary pumps needed but the dimension of the by-pass and the control valve is large
- A flow meter is needed for by-pass control
- Motorized isolation valves and MBVs are needed for chiller staging (PICV is an alternative solution for flow limitation and isolation)
- Dedicated pumps for each individual chiller are required

## Design

- Kvs calculation of isolation and manual balancing valve is required and the pre-setting of the MBVs is important
- The by-pass and valve should be sized according to the flow of the biggest chiller
- The flow meter sizing is based on the nominal flow in the system
- The pump head needs to cover the  $\Delta p$  demand of the entire system
- Pump head adjustment is needed with different sizes of chillers
- Pumps can be added based for operational security

## Operation/Maintenance

- Installation of the by-pass is needed between the supply and return
- Constant flow\* on the chiller is essential for their proper operation
- Balancing of the system is needed
- Isolation of idle chillers is important
- Pumps work at constant speed but due to better chiller staging the energy efficiency is better compared with application 4.3

## Control

- Chiller and pump operation have to be harmonized
- By-pass control ensures the exact flow demand for the active chillers based on the signal of the flow meter
- Advanced chiller control logic is required to maximize efficiency
- Low  $\Delta T$  syndrome\* is possible in partial load due to the by-pass

\*see page 54-55



Heating  Cooling

## Constant primary and variable secondary (Primary Secondary)

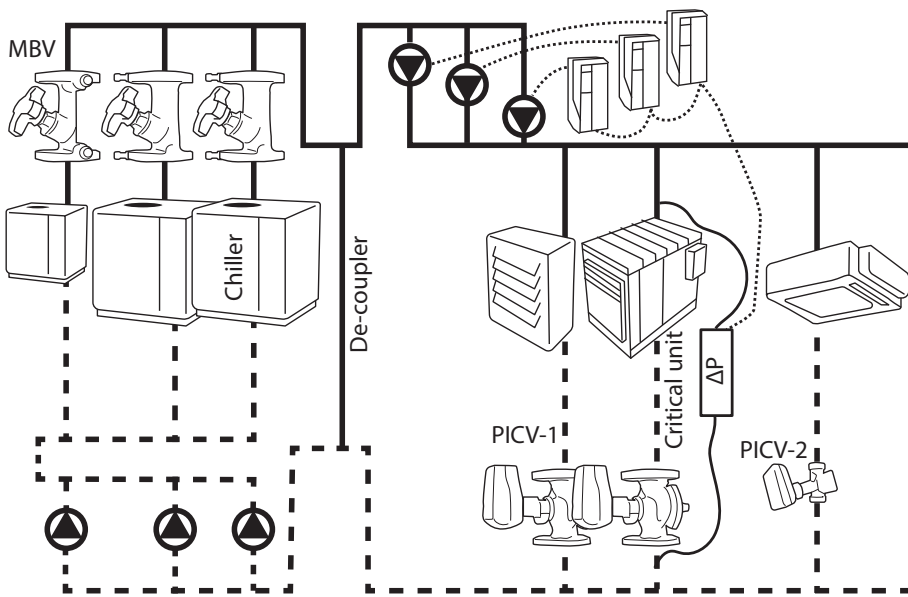

This system is a variation of a constant primary (constant flow\*) system. Variable speed drives are used to control the pumps on the secondary side. By de-coupling the primary and the secondary circuits, the chillers can be staged according to the load variation while keeping a constant flow\* on the chillers. (Secondary side description see applications: 1.1.1.1-1.1.1.3)

### Explanation

#### Return of investment

- High investments cost - primary and secondary pumps are required
- Motorized isolation valves and MBVs are needed for the chiller staging (PICV is an alternative solution for flow limitation and isolation)
- Balancing is required
- Constant speed pumps on the primary side and speed-controlled pumps on the secondary side

#### Design

- Kvs calculation of the isolation and manual balancing valves, pre-setting of the MBVs is important (a low pressure drop on the isolation valve is recommended)
- The pressure drop on the de-coupler should not be more than 10-30 kPa to minimize hydraulic interdependency
- Pump capacities have to correlate to the individual chiller flow demand
- The secondary pump head is often bigger than the primary side one

#### Operation/Maintenance

- Additional space is required for the pumps on the secondary side
- Commissioning of the system is complex
- Isolation is important for idle chillers

#### Control

- A hydronic de-coupler prevents interactivity between the primary and secondary circuits
- Secondary pumps should be controlled based on a  $\Delta p$  signal of the critical circuit, to optimize the energy efficiency
- Simple chiller control logic
- Low  $\Delta T$  syndrome\* in partial loads due to the de-coupler
- Primary pumps work at a constant speed so no energy saving\* is possible

\*see page 54-55

Acceptable



4.3

Danfoss products:

Pressure Independent PICV - Control Valve



PICV-1: AB-QM + AME345QM

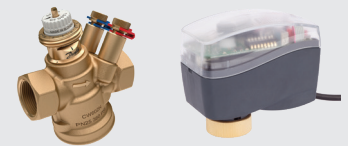

PICV-2: AB-QM 4.0 + AME 110



VLT®HVAC Drive FC102



Manual Balancing Valve MBV: MSV-F2

### Performance

#### Return of investment



#### Design



#### Operation/Maintenance



#### Control



**Not Recommended**

# 4.4

Heating  Cooling 

## Constant primary & secondary (Constant Flow System)

**Danfoss products:**

Manual Balancing Valve



MBV-1: MSV-BD



MBV-2: MSV-F2

3 - way Control Valve



CV-1: VRB + AME435



CV-2: VF3 + AME435

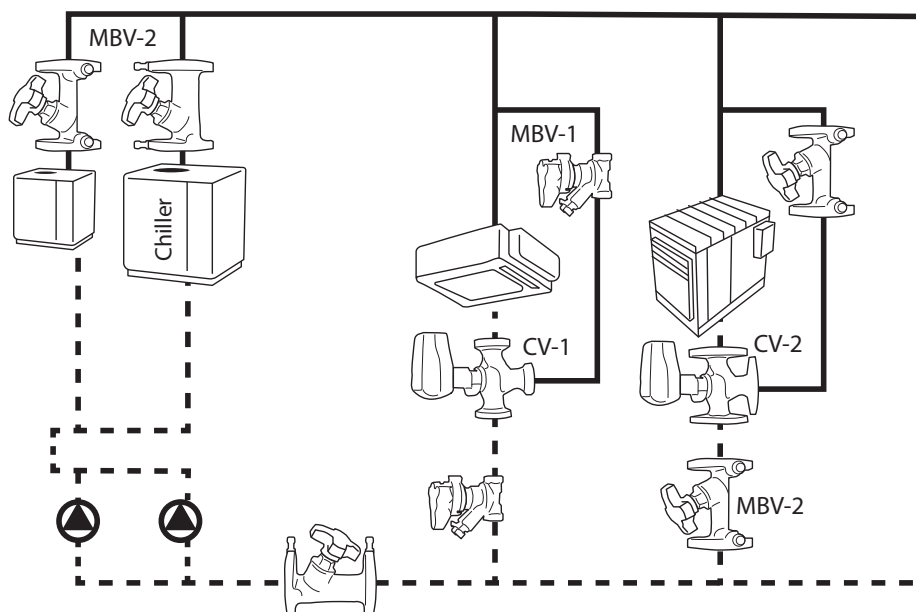

This is one of the oldest chiller applications with no variable speed drives for pumps and chillers. The chillers can only handle fixed flows, so there are 3-way control valves in the secondary side of the system to maintain a constant flow\*. They are controlling the flow through the terminal units to maintain a constant room temperature. (Secondary side description see applications: 1.1.2.1, 2.2 and 3.2.1)

### Performance

#### Return of investment

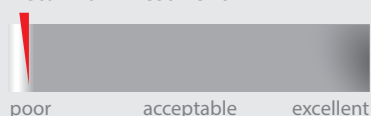

#### Design

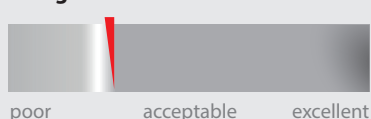

#### Operation/Maintenance

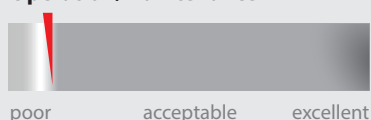

#### Control



### Explanation

#### Return of investment

- Constant flow\* chillers are used
- MBVs are needed\* for proper water distribution among the chillers. Alternatively, but only if the chillers are the same size, a Tichelman system can be used
- The flow is constant in the manifolded pump station, so there is no option for saving energy by applying VSDs\*

#### Design

- Kv and pre-setting calculation for the chiller MBVs are needed
- Chiller staging is not possible
- The pump selection and operation should be adjusted to the chiller capacity
- The real flow in the system is usually 40-50% bigger than the nominal flow demand in partial load condition
- Pump head calculation according to the entire pressure drop of the system

#### Operation/Maintenance

- The flow through the chillers must be constant at all times. If not, the chiller's low flow alarm trips and the chiller ceases operation
- Balancing of the MBVs is crucial to set the flow rate according to the pump operation
- It's a rigid system. It is not possible to take out or add terminal units during operation
- High pump head demand and high energy consumption

#### Control

- For chiller operation we need to ensure constant flow\*
- The chiller and pump operation must be harmonized
- There is no by-pass in the system therefore we need to keep the nominal flow through the system all the time
- High risk for low  $\Delta T$  syndrome \*
- Low  $\Delta T$  in the system and constant pump operation result in poor efficiency of the chiller

\*see page 54-55

Heating  Cooling

## District cooling system

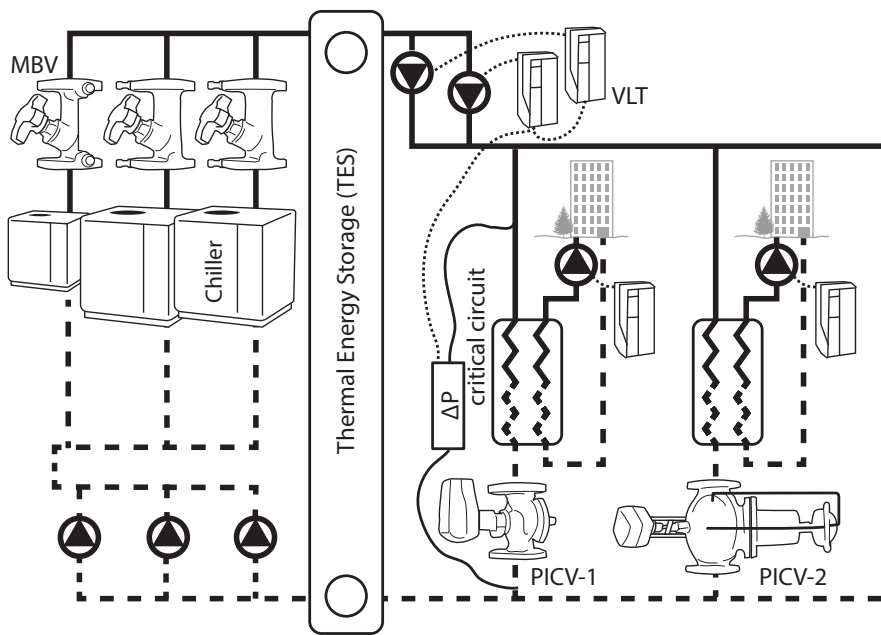

A district cooling system is a large-scale cooling network suitable for feeding several buildings. It contains a Thermal Energy Storage (TES) capable of storing the thermal energy like a rechargeable battery. This application should be used above 35MW cooling capacity. The goal is to increase the power plant's efficiency by flattening peak loads. The additional function of the TES is hydronic separation of the primary and secondary side (Secondary side applications similar to applications: 1.1.1.1-1.1.1.3)

### Explanation

#### Return of investment

- Expensive but environmentally friendly solution for providing cooling to complete districts of many buildings
- TES cost needs to be included.
- Huge chillers are usually required. Min. 3.5MW per chiller.
- Advanced chiller control logic is required to maximize plant efficiency
- Constant speed pump for the primary side and VSD\* on the secondary loop

#### Design

- Kvs calculation of isolation and MBVs, pre-setting of the MBVs is important (a low pressure drop on the isolation valve is recommended)
- The TES also functions as a hydronic de-coupler, it will store flow surplus from the constant primary loop.
- PICVs installed in each energy transfer station are highly recommended to maximize efficiency
- A  $\Delta p$  sensor located on critical points to secure proper pump control is recommended
- Chiller and pump operation have to be harmonized

#### Operation/Maintenance

- Simple and transparent construction
- Constant flow\* through the chillers is essential for their proper operation
- Commissioning\* is needed to analyze the load pattern over time.
- Isolation is important for idle chillers

#### Control

- Secondary and tertiary pumps can be connected to critical units with proportional pump control to save energy
- Control of feeding and emptying the TES is important for ensuring the proper cooling energy in peak load and to achieve better efficiency
- There is no low  $\Delta T$  syndrome\* while TES is not overcharging
- The primary pumps work at constant speed but due to chiller staging the energy the efficiency is good

\*see page 54-55

Recommended



4.5

Danfoss products:

Pressure Independent Control Valve



PICV-1: AB-QM + AME345QM

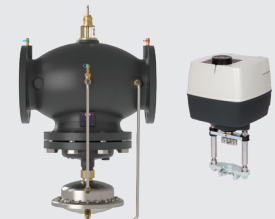

PICV-2: AB-QM 4.0 + AME 655

Manual Balancing Valve



MBV: MSV-F2



Drive

VLT®HVAC Drive FC102

### Performance

#### Return of investment

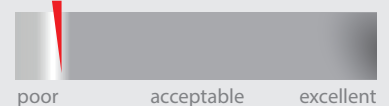

#### Design

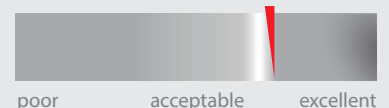

#### Operation/Maintenance

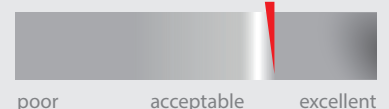

#### Control

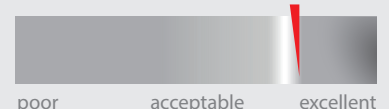

**Recommended**

# 5.1

1. Pressure Independent Control Valve (PICV)
2. Building Management System (BMS)
3. Temperature Sensor
4. VSD\* Pump

**Danfoss products:**

PICV: AB-QM + AME345QM or Novocon M

Heating  Cooling 

## Condensing boiler, variable primary flow

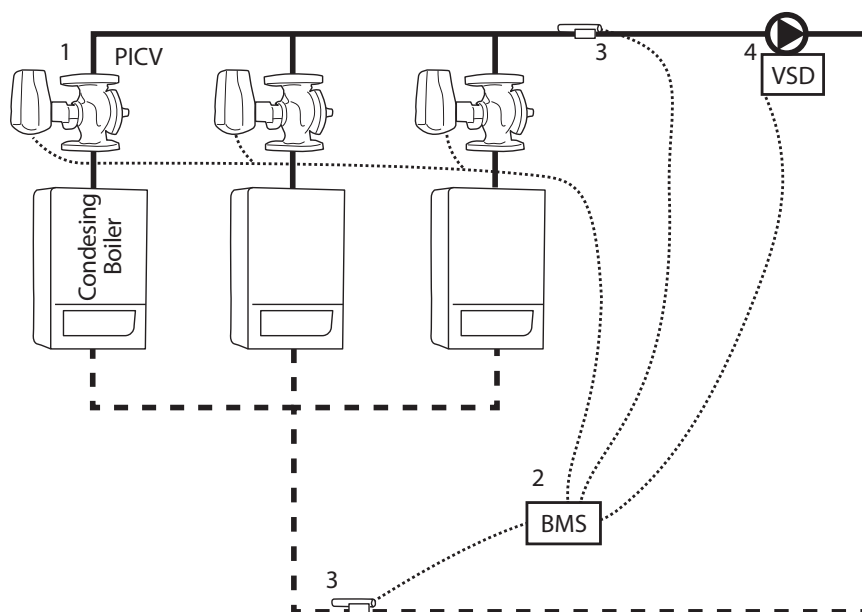

This application uses a varied number of condensing boilers. All boiler circuits are equipped with PICV valves that are connected to the BMS system. They ensure proper balancing, staging and control in full- and partial load conditions. Variable speed drives are used for minimizing the pumping cost\*. PICV or  $\Delta p$  control on the secondary side is also strongly recommended to minimize energy consumption.

### Performance

#### Return of investment

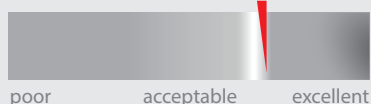

#### Design

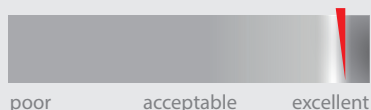

#### Operation/Maintenance

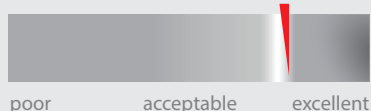

#### Control

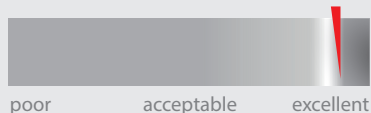

### Explanation

#### Return of investment

- Low - one set of pumps and dedicated PICVs with modulating actuators for control and isolation of the boilers
- Valves need to be connected to the BMS which controls the flow through each boiler to optimize the energy efficiency
- A variable speed drive on the pump is required

#### Design

- Simple PICV selection based on the flow demand of single boilers
- The pump head also needs to cover the pressure drop of the entire system
- Pump head optimization\* by using  $\Delta p$  sensors on the critical unit is recommended

#### Operation/Maintenance

- Optimization of the return temperature is possible with proportional PICV or  $\Delta p$  control on the secondary side
- Increased  $\Delta T$  ensures optimal condensing boiler efficiency
- Minimized flow through the system so the pumping costs\* are low
- The control system should be aligned with internal boiler logic

#### Control

- Perfect flow control through each boiler to achieve optimum boiler efficiency
- Good control of the return temperature due to the lack of a by-pass in the system
- Maximum efficiency of the boilers at design and partial load
- Expected variable flow\* on secondary side with PICV or  $\Delta p$  control so a VSD\* is required

Heating  Cooling

## Traditional boilers, variable primary flow

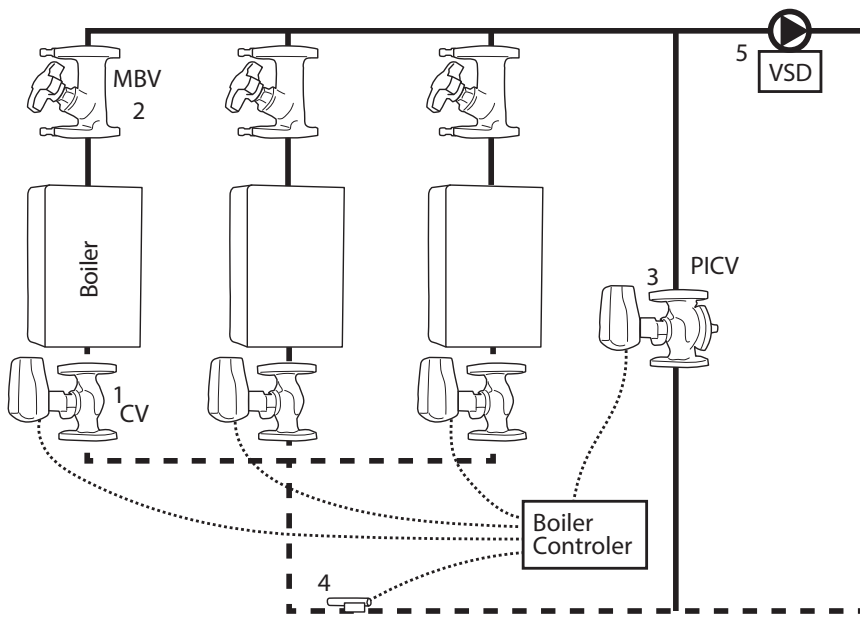

This application is used for traditional (non-condensing) boilers. In order to avoid low inlet temperature to the boilers a controlled by-pass (with a PICV) is needed. In this application we use only one set of pumps to circulate flow through both the primary and the secondary system

### Explanation

#### Return of investment

- Medium - one set of pumps, MBVs and isolation valves are required
- Additional by-pass with a PICV is needed to ensure minimum inlet boiler temperature
- Temperature sensor for the control of the by-pass
- Commissioning of the manual balancing valve is required. Alternatively, but only if the boilers are the same size, a Tichelman system can be used
- A variable speed drive for the pump is required to save energy

#### Design

- Presetting calculation of the MBVs is needed to ensure the nominal flow through all the boilers
- The by-pass valve is sized according to the flow demand of the biggest boiler
- The pump head also needs to cover the pressure drop of the secondary system
- Idle boilers need to be isolated.
- A pressure relief valve is recommended at the end of the system to ensure the minimum flow for the pump

#### Operation/Maintenance

- Boilers work with variable flow\* depending on the system load. Therefore, it's difficult to maintain stable boiler control
- The plant controller must control the by-pass valve based on the temperature of the return
- Moderate pumping costs\*

#### Control

- Simple control logic based on the expected return flow temperature
- Boiler staging according to the flow temperature and based on the energy demand in the system
- The return temperature can not be optimized which has negative effects, especially on condensing boilers, and reduces the system's efficiency
- With variable flow\* on the secondary side with PICV or  $\Delta p$  control, a VSD\* is required

Acceptable



5.2

1. Isolation Valve (CV)
2. Manula Balancing Valve (MBV)
3. By pass Valve (PICV)
4. Temperature Sensor
5. VSD\* Pump

#### Danfoss products:



CV: VF2 + AME345



MBV: MSV-F2



PICV: AB-QM + AME345QM

### Performance

#### Return of investment



#### Design



#### Operation/Maintenance



#### Control

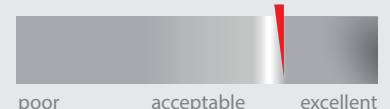

\*see page 54-55

**Not Recommended**

## 5.3

Heating  Cooling 

### System with manifolds de-couplers

1. Isolation Valve (CV)
2. Manula Balancing Valve (MBV)
3. Pump
4.  $\Delta P=0$  Manifold
5. De-coupler

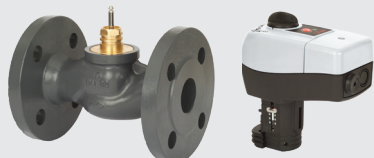
**Danfoss products:**

CV: VF2 + AME435



MBV: MSV-F2

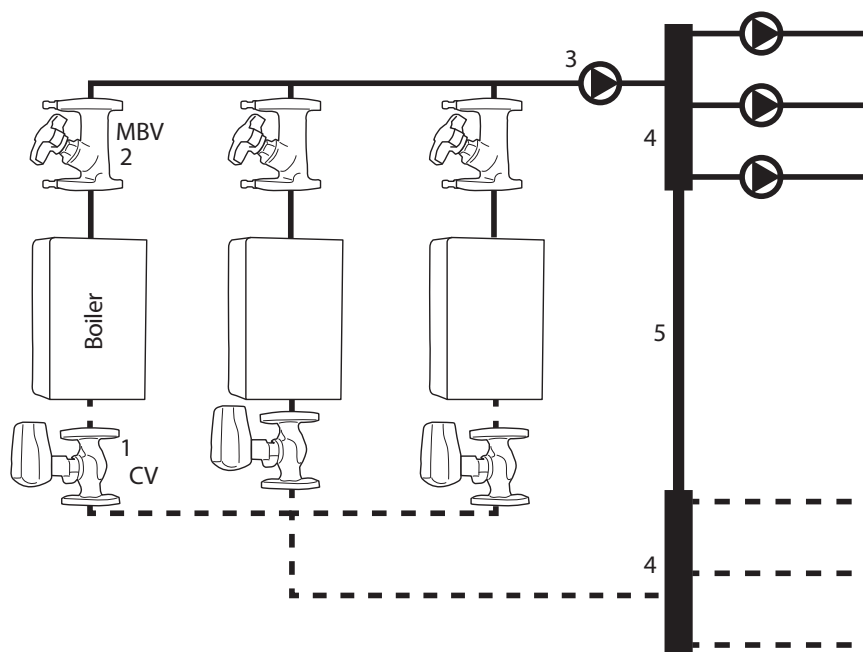

This is the most common constant primary flow boiler plant arrangement (cascade). The primary and secondary systems are hydraulically independent. The manifolds are connected with a by-pass that allows water circulation between them.

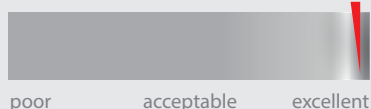
**Performance****Return of investment****Design****Operation/Maintenance****Control****Explanation****Return of investment**

- Pumps are needed both on the primary and the secondary side
- A large by-pass between the manifolds is required
- Commissioning\* of the MBVs is required. Alternatively, but only if the boilers are the same size, a Tichelman system can be used
- Motorized isolation valves and MBVs are needed for each boiler. Alternatively, a PICV for flow limitation and isolation can be used

**Design**

- A pre-setting calculation of the MBVs is needed to ensure the nominal flow for each boiler
- The manifold and by-pass need to be sized properly to prevent interference between the primary and secondary pumps
- Proper sizing of the primary and secondary pumps is crucial to minimize the flow through the by-pass
- Proportional pump control is recommended with a variable flow\* on the secondary side

**Operation/Maintenance**

- Primary pumps don't require minimum flow protection
- Boiler operation is independent from the secondary system
- Boiler staging should be done according to the heat demand of the secondary system
- In case of non-condensing boilers, an additional by-pass is needed before each boiler to ensure a minimum inlet temperature for the boiler

**Control**

- Staging of the boilers should be based on the return temperature of the secondary side
- The return temperature could be high which negatively affects condensing boilers and reduces the system's efficiency
- Individual boiler logic according to supply temperature

\*see page 54-55

# Thermal balancing in DHW circulation (vertical arrangement)

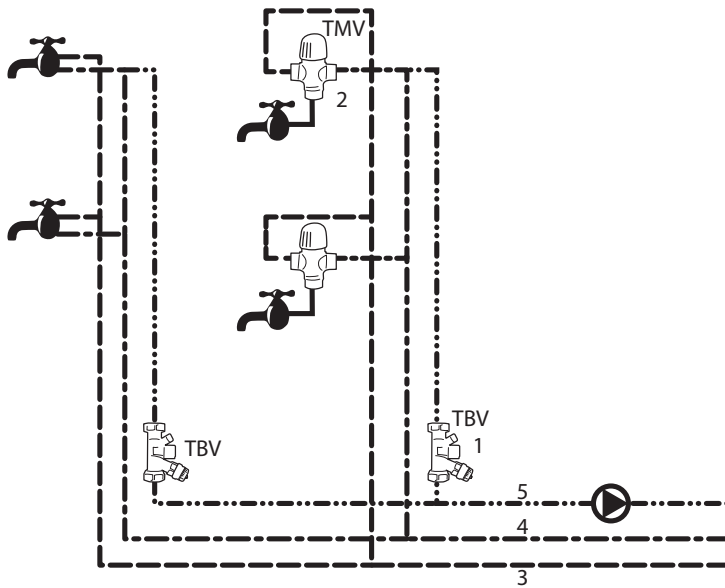

In this application we ensure variable flow\* in the DHW\* circulation pipeline and constant tapping temperature\* on either tap independently from the distance from storage tank and temporary hot water usage. Thanks to this we reduce the quantity of circulation water during all periods. Thermal disinfection\* is possible with additional equipment. TMV (as optional) ensures maximum tapping temperature preventing scalding.

## Explanation

### Return of investment

- Low investment MTCV valves only, further hydraulic elements are not needed
- Low installation cost
- No commissioning – temperature setting only
- Variable Speed Drive recommended

### Design

- Flow – according to heat losses in pipeline and temperature drops in branches when taps are closed, no kvs and flow presetting calculation is needed
- Temperature setting on valve is based on temperature drop from the last tap to the valve
- Pump head calculation according to nominal flow when no DHW\* consumption

### Operation/Maintenance

- Minimum temperature losses on pipeline – high energy saving\*
- Re-commissioning\* is not needed – self-acting temperature control
- Lower maintenance costs due to constant/optimal temperatures in the system (less scalding, corrosion etc.)
- Thermometer can be connected to the valve for inspection and proper thermal commissioning

### Control

- Stable tapping temperature\* on all risers
- Perfect balancing at full and partial load
- Access to hot water immediately
- Circulated flow quantity minimized, no overflow
- Lime scale deposit has no effect control accuracy

\*see page 54-55

# 6.1

1. Termostatic Balancing Valve (TBV)
2. Termostatic Mixing Valve (TMV) (optional)
3. Domestic Cold Water (DCW)
4. Domestic Hot Water (DHW)
5. Circulation (DHW-C)

### Danfoss products:



TBV: MTCV-A



TMV: TMV-W

## Performance

### Return of investment

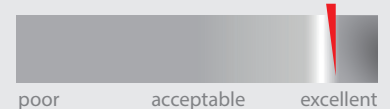

### Design

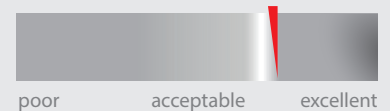

### Operation/Maintenance

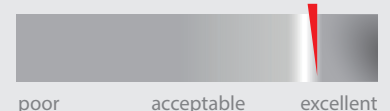

### Control

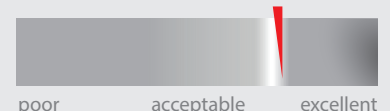

**Recommended**

## 6.2

**Hot & Cold Water Supply** ✓

### Thermal balancing in DHW circulation (horizontal loop)

#### 1. Thermostatic Balancin Valve (TBV)

**Danfoss products:**

TBV: MTCV-A

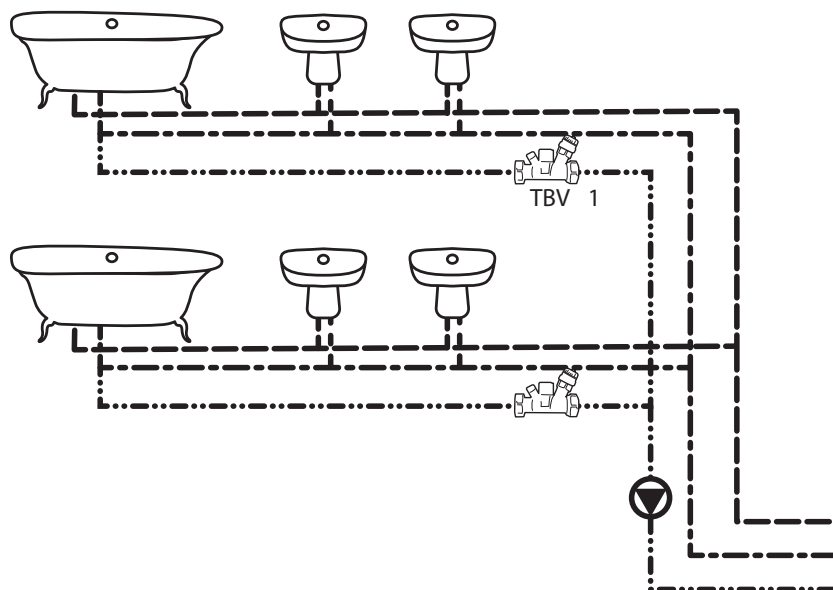

In this application we ensure variable\* flow in the DHW\* circulation pipeline and constant tapping temperature on either tap independently from the distance from storage tank and temporary hot water usage. Thanks to this we reduce the quantity of circulation water during all periods. Thermal disinfection\* is possible with additional equipment

#### Performance

##### Return of investment

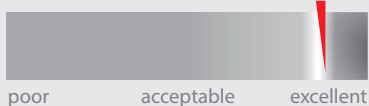

##### Design

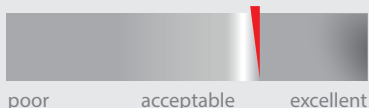

##### Operation/Maintenance

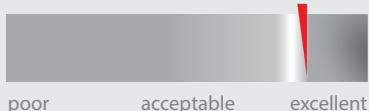

##### Control

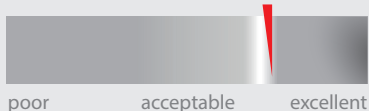

#### Explanation

##### Return of investment

- Low investment MTCV valves only, further hydraulic elements are not needed,
- Low installation cost
- No commissioning – temperature setting only
- Variable Speed Drive (VSD\*) is recommended

##### Design

- Flow – according to heat losses in pipeline and temperature drops in branches when taps are closed, no kvs and flow presetting calculation needed
- Temperature setting on valve based on temperature drop from the last tap to the valve
- Pump head calculation according to nominal flow when there is no DHW\* consumption
- If MTCV is used in horizontal loops rule of 3l water volume must be applied

##### Operation/Maintenance

- Minimal temperature losses on a pipeline – high energy saving\*
- Re-commissioning\* is not needed – self-acting temperature control
- Lower maintenance costs due to constant/optimal temperatures in the system (less scalding, corrosion etc.)
- Thermometre can be connected to a valve for inspection and proper thermal commissioning

##### Control

- Stable tapping temperature\* on all horizontal loops
- Perfect balancing at full and partial load
- Access to hot water immediately
- Circulated flow quantity minimized, no overflow\*
- Lime scale deposit has no effect on control accuracy



# Thermal balancing in DHW circulation with self-acting disinfection

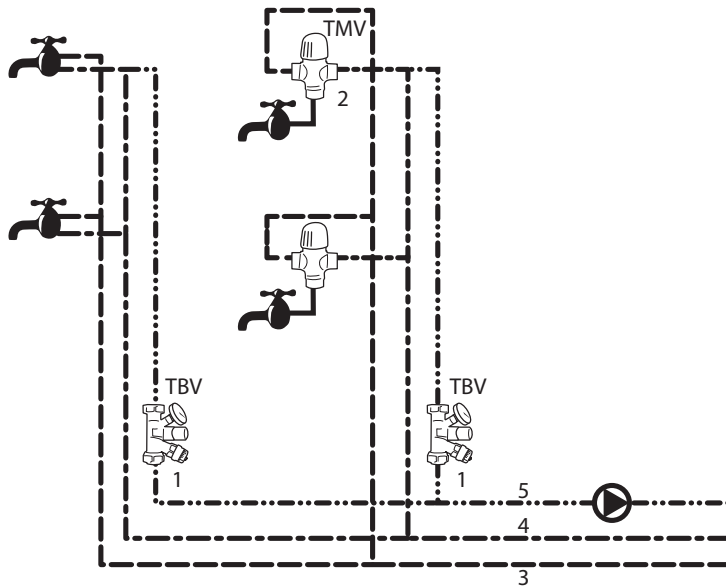

In this application we ensure variable flow\* in the DHW\* circulation pipeline and constant tapping temperature\* on either tap independently from the distance from storage tank and temporary hot water usage. Thanks of this we reduce the quantity of circulation water during all periods. Thermal self-acting disinfection is possible based on special module in MTCV valves. TMV (as optional) ensures maximum tapping temperature preventing scalding.

## Explanation

### Return of investment

- Low investment MTCV with self-acting disinfection module, further hydraulic elements are not needed
- Low installation cost
- No commissioning\* – temperature setting only
- Variable Speed Drive (VSD\*) is recommended

### Design

- Like application 6.1; 6.2
- Pump head verification for disinfection process needed
- During thermal disinfection higher flow temperature is needed (65-70°C)

### Operation/Maintenance

- Composite MTCV valve cone ensures longer lifetime
- Thermal disinfection\* of the system cannot be guaranteed (pump capacity, heat losses etc) and optimized
- TMV valves are able to limit the tapping temperature\* during thermal disinfection\*
- Thermometer can be connected to valve for inspection and proper thermal commissioning

### Control

- Stable tapping temperature\* on all risers/loops
- Acceptable solution for small residential buildings if their own heat source is available
- Perfect balancing at full and partial load
- Circulated flow quantity minimized, no overflow\*

\*see page 54-55

Recommended



# 6.3

1. Termostatic Balancing Valve (TBV)
2. Termostatic Mixing Valve (TMV) ( optional )
3. Domestic Cold Water (DCW)
4. Domestic Hot Water (DHW)
5. Circulation (DHW-C)

Danfoss products:



TBV: MTCV-B



TMV: TMV-W

## Performance

### Return of investment

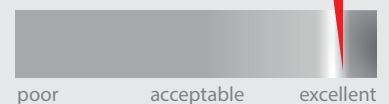

### Design



### Operation/Maintenance

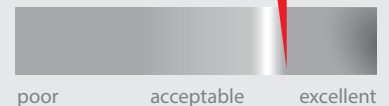

### Control

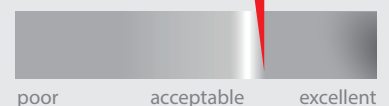

**Recommended**

# 6.4

1. Thermostatic Balancing Valve (TBV)
2. Thermostatic Mixing Valve (TMV) ( optional )
3. Electronic Controller (CCR2+)
4. Temperature Sensor

**Danfoss products:**

TBV: MTCV-C



TMV: TMV-W



CCR2+

## Thermal balancing in DHW circulation with electronic disinfection

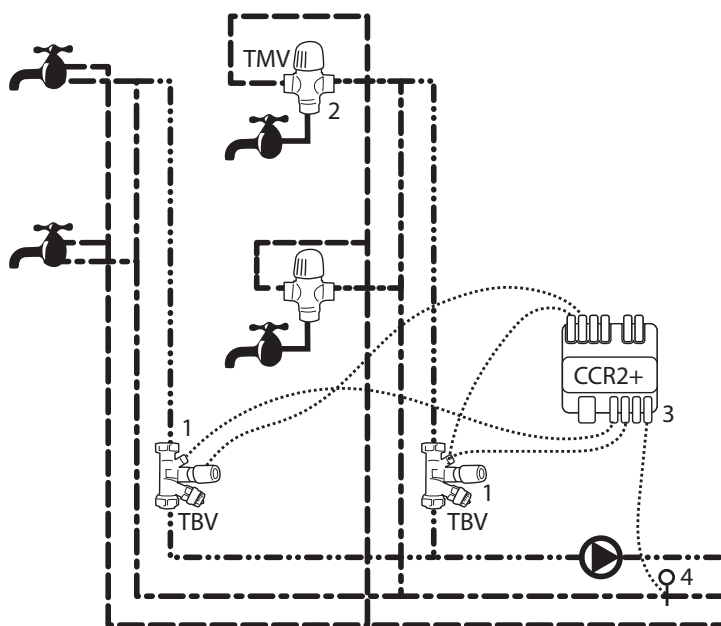
**Hot & Cold Water Supply** ✓

In this application we ensure variable flow\* in the DHW\* circulation pipeline and constant tapping temperature\* on either tap independently from the distance from storage tank and temporary hot water usage. Thanks to this we reduce the quantity of circulation water in all periods. TMV valves ensure constant tapping temperature\* in term of thermal disinfection period too. Thermal disinfection\* is controlled by CCR2+ electronic device.

### Performance

#### Return of investment



#### Design

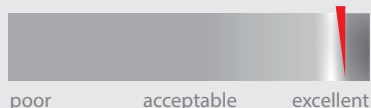

#### Operation/Maintenance

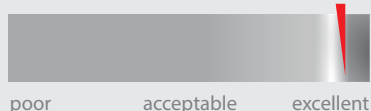

#### Control



### Explanation

#### Return of investment

- High, control equipment required -MTCV with actuator and CCR2+ for disinfection control, furthermore (as option) temperature mixing valve
- Higher installation costs – included with wiring cost
- Commissioning of hydronic system is not required
- CCR2+ programming is needed
- Variable Speed Drive (VSD\*) is recommended

#### Design

- Like application 6.1; 6.2
- Excellent engineering – minimal energy consumption
- Thermal disinfection\* is solved
- No need for pump verification for disinfection capacity

#### Operation/Maintenance

- Composite MTCV valve cone ensures longer life time
- Excellent thermal disinfection\* of the system –programmable and optimized
- TMV valves are able to limit the tapping temperature\* during thermal disinfection\*
- Temperature registration is managed by CCR2+
- Automatized disinfection process can be programmed
- All data and settings available remotely

#### Control

- No overflow\*, flow rate is according to temporary demand
- Minimum required time for disinfection
- Variable speed pump and good boiler efficiency ensure energy saving\*
- Connectivity with BMS and DHW\* automatization modules

# DHW\* circulation control with manual balancing

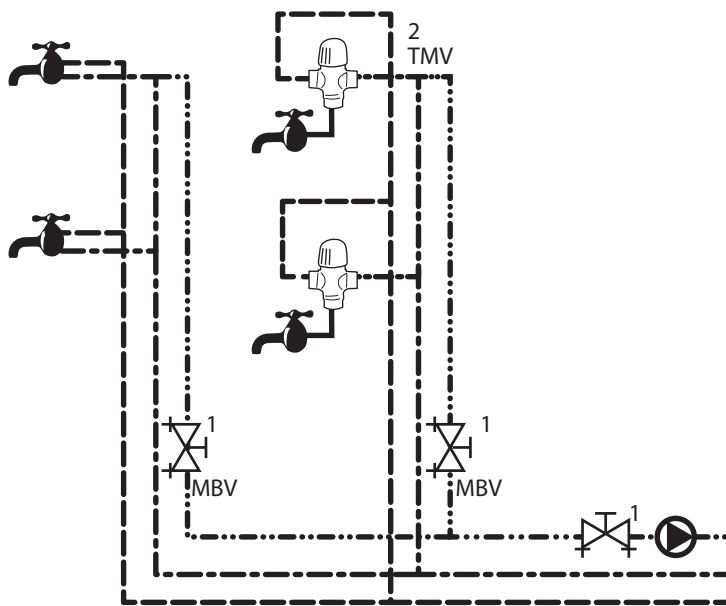

In this application we ensure constant flow\* in the domestic hot water circulation pipeline independently on temporary hot water usage and demand. TMV (as optional) ensures maximum tapping temperature preventing scalding.

## Explanation

### Return of investment

- Low investment –MBVs , constant speed pump, partner valve\* (rarely used)
- Higher installation cost – if partner valves\* are used
- Commissioning of the system is required
- No Variable Speed Drive (VSD\*) demand

### Design

- Traditional calculation: kvs of the manual balancing valve
- Presetting calculation of the valves is needed
- Complicated circulation flow demand is calculated according to heat loss on supply hot water and circulation pipeline
- Pump head calculation according to nominal flow when there is no DHW\* consumption
- Circulation pump and MBVs is often oversized

### Operation/Maintenance

- High energy losses on pipeline, high energy consumption
- Re-commissioning\* of the system is required from time to time
- Lower efficiency of boiler due to high return temperature
- Higher service cost due to more lime scale deposit (higher circulation temperature)
- Legionella growth risk
- Big water consumption

### Control

- Variable tapping temperature\* (depends on distance from DHW\* tank)
- Static control doesn't follow dynamic behaviour of water usage
- Circulated flow quantity independent from real demand, overflow most of the time

Not Recommended



6.5

1. Manual Balancing Valve (MBV)
2. Termostatic Mixing Valve (TMV) ( optional )

Danfoss products:



TMV: TMV-W

## Performance

### Return of investment

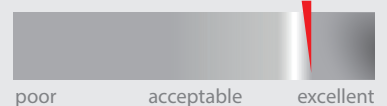

### Design

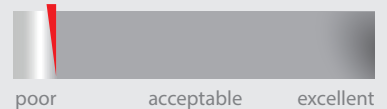

### Operation/Maintenance

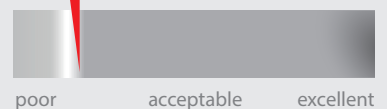

### Control

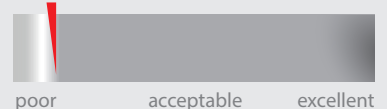

\*see page 54-55

# Notes

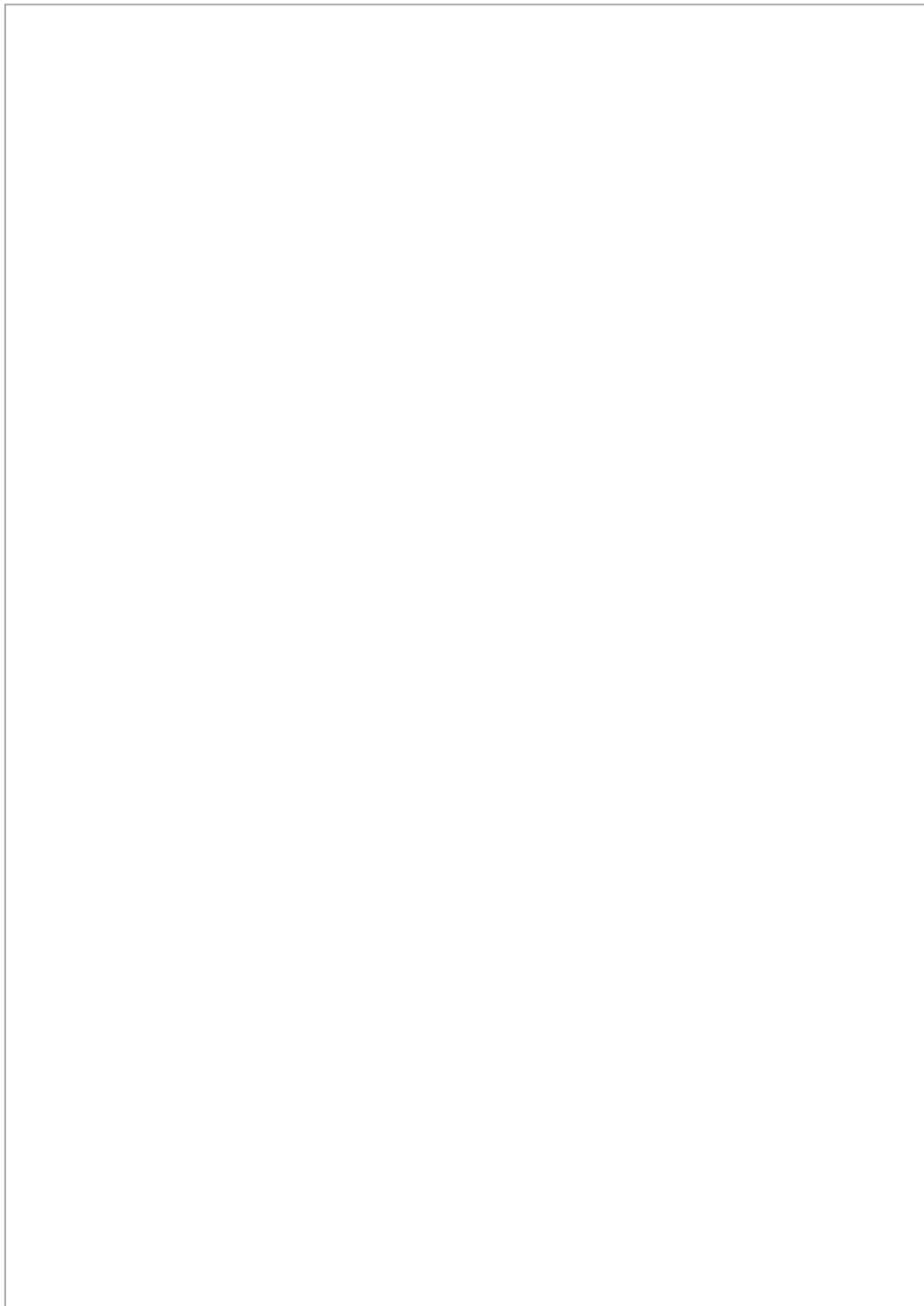

**Glossary and abbreviations**

**Control and valve theory**

**Energy efficiency analyses**



## 7.1

## Glossary and abbreviations

**Traditional calculation:** For good control, we have to take two most important control features into consideration; the authority of the control valve and the pressure equivalence before each terminal unit. For this requirement we have to calculate the required kvs value of the control valves and treat the whole hydraulic system like one unit.

**Balancing** – Flow regulation by means of balancing valves in order to achieve right flow in each circuit of heating or cooling system.

**Commissioning:** However, we have to calculate the required settings of the manual or automatic balancing valve during the traditional calculation, before we hand the building over to the user. We have to be sure that the flow is according to the required value all over. Therefore, (due to installation imprecision), we have to check the flow on the measuring points and correct this if necessary.

**Re-commissioning:** From time to time commissioning must be redone. (e.g. in the case of changing the function and size of the room, regulating heat loss and heat gain).

**SMART actuator:** Digital, high precision stepper actuator with direct connectivity with BMS system, extended with additional special functions to make the installation and operation easier.

**Good authority:** The authority is a differential pressure rate which shows the pressure loss of the control valve and is compared to the available differential pressure ensured by pump or  $\Delta p$  controller (if exists)

$$a = \frac{\Delta p_{CV}}{\Delta p_{CV} + \Delta p_{pipes+units}}$$

Control is better in case of higher authority. The minimum recommended authority is 0,5.

**Pumping cost:** The expense that we have to pay for pump energy consumption.

**Constant flow:** The flow in the system or the unit does not change during the whole operational term.

**Low  $\Delta T$  syndrome:** This is more significant for cooling systems. If the required  $\Delta T$  in the system cannot be ensured, the efficiency of the cooling machine declines dramatically. This symptom can also occur in heating systems.

**Return of investment:** How fast based on exploitation savings we will have back the whole amount that we have to pay for a certain part of installation.

**Pump optimization:** In the case of electronic controlled pump usage, the pump head can be reduced to the point where the required flow in the whole system is still ensured, bringing the energy consumption to the minimum.

**Room temperature oscillation:** The real room temperature deviates constantly from the set temperature all the time. The oscillation means the size of this deviation.

**No overflow:** The constant flow through a terminal unit according to the desired flow.

**Partner valve:** An additional manual balancing valve is required for all branches to achieve commissioning properly. As a partner valve we can describe a valve which allows to connect impulse tube from differential pressure controller valve (DPCV)

**Variable flow:** The flow in the system varies continuously according to temporal partial load. It is dependent on external circumstances such as sunshine, internal heat gains, room occupation, etc.

**Thermal disinfection:** In DHW systems the number of Legionella bacteria increases dramatically around tapping temperature. It causes diseases and from time to time it can lead to death. To avoid this, disinfection is needed periodically. The simplest way to do this is to increase the temperature of the DHW above ~60-65 °C. In this temperature the bacteria will be destroyed.

**Variable speed drive (VSD):** Circulation pump is equipped with a built-in or external electronic controller, ensuring constant, proportional (or parallel) differential pressure in the system.

**Energy saving:** Electrical and /or heat cost reduction.

**Change over:** In systems where cooling and heating do not function in parallel, the system must be changed between these operational modes.

**Building classification:** The rooms are classified according to comfort capability (EU norm). "A" means the highest rank with smallest room temperature oscillation and better comfort.

**Stable room temperature:** Achievable with proportional self acting or electronic controller. This application avoids any undesirable fluctuations of room temperature because of hysteresis of on/off room thermostat.

**Tapping temperature:** The temperature that appears immediately when the tap is opened.

**Partial load:** Any load during system operation time that is less than designing load.

**DHW:** Domestic Hot Water system.

**FL:** Flow Limiter

**AHU:** Air Handling Unit

**DPCV:**  $\Delta p$  Control Valve

**BMS:** Building Management System

**MBV:** Manual Balancing Valve

**PICV:** Pressure Independent Balancing Valve

**CO6:** Change Over 6-way valve

**CV:** Control Valve

**TRV:** Thermostatic Radiator Valve

**RC:** Room temperature Control

**RLV:** Return Locking Valve

**FCU:** Fan Coil Unit

**TES:** Thermal Energy Storage

## 8

## Control and valve theory

## 8.1

## Valve authority

The authority of the valve is a measure of how well the control valve (CV) can impose its characteristic on the circuit it is controlling. The higher the resistance in the valve, and therefore the pressure drop across the valve, the better the control valve will be able to control the energy emission of the circuit.

The authority ( $a_{cv}$ ) is usually expressed as the relationship between the differential pressure across the control valve at 100% load and fully open valve (the minimum value  $\Delta P_{min}$ ), and the differential pressure across the control valves when it is fully closed ( $\Delta P_{max}$ ). When the valve is closed, the pressure drops in other parts of the system (pipes, chillers and boilers for example) disappear and the total available differential pressure is applied to control valves. That is the maximum value ( $\Delta P_{max}$ ).

Formula:  $a_{cv} = \Delta P_{min} / \Delta P_{max}$

The pressure drops across installation are illustrated in Fig 1

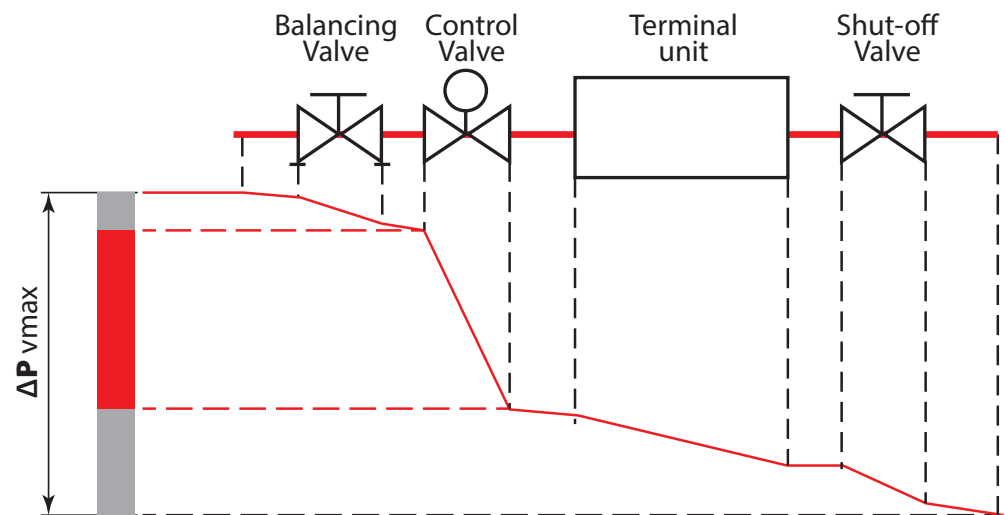

Fig 1



## Valve characteristics

Each control valve has its own characteristic, defined by the relation between the lift (stroke) of the valve and the corresponding water flow. This characteristic is defined at a constant differential pressure across the valve, so with an authority of 100% (see formula). During practical application in an installation, the differential pressure is however not constant which means that the effective characteristic of the control valve changes. The lower the authority of the valve, the more the characteristic of the valve is distorted. During the design process we have to ensure that the authority of the control valve is as high as possible to minimize deformation of the characteristic.

The most common characteristics are presented below in the graphs:

1. Logarithmic/Equal percentage control valve characteristic (Fig 2)
2. Linear control valve characteristic (Fig 3)

The line designated with 1.0 is the characteristic at an authority of 1 and the other lines represent progressively smaller authorities.

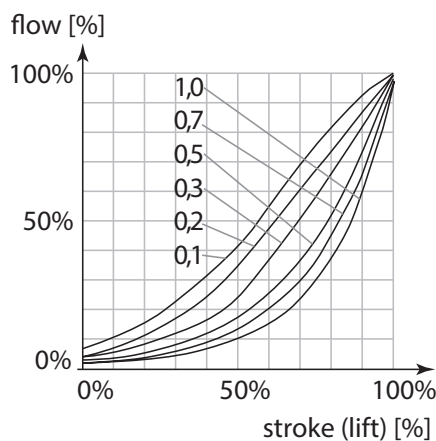

Fig 2

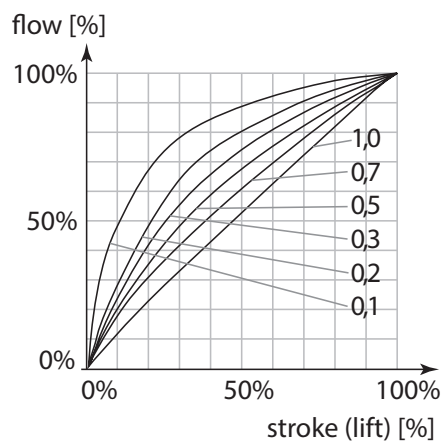

Fig 3

## Closed loop control in HVAC system

The word "control" is used in many different contexts. We talk of quality control, financial control, command and control, production control, and so on – terms which cover an enormous range of activities. However all these types of control, if they are to be successful, have certain features in common. One is that they all presuppose the existence of a system whose behavior we wish to influence, and the freedom to take actions which will force it to behave in some desirable way.

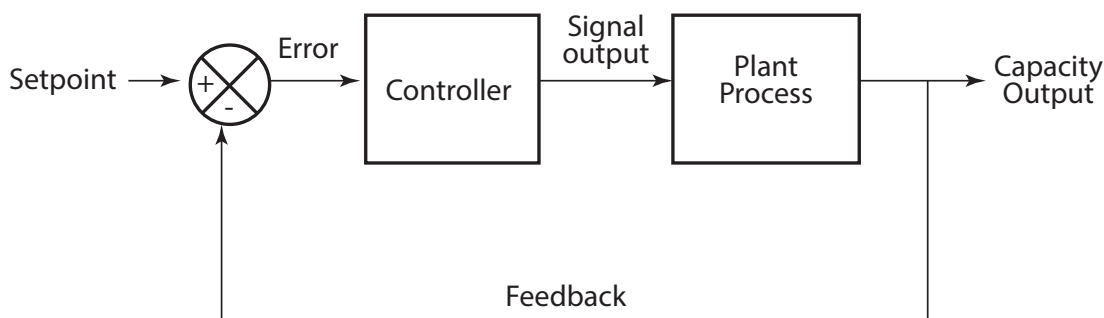

Fig 4

The block diagram above (Fig 4) is a model of continuously modulated control, a feedback controller is used to automatically control a process or operation. The control system compares the value or status of the process variable being controlled with the desired value or setpoint (SP) and applies the difference as a control signal to bring the process variable output of the plant to the same value as the setpoint.

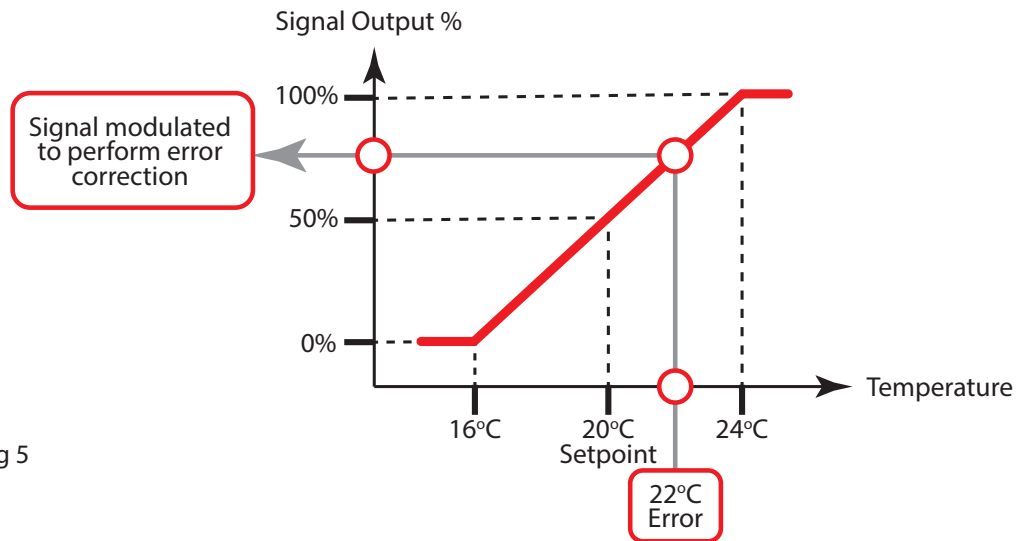

Fig 5

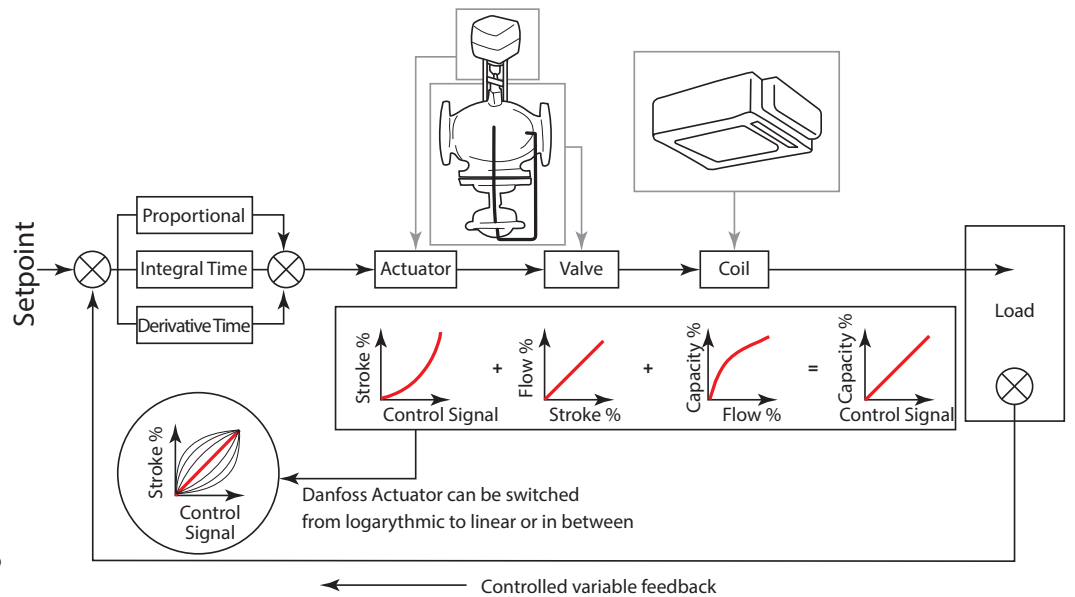

Fig 6

Each individual component in the system has its own characteristic. Combining each components correctly with a properly set and tuned controller makes a good control response and efficiency of HVAC system.

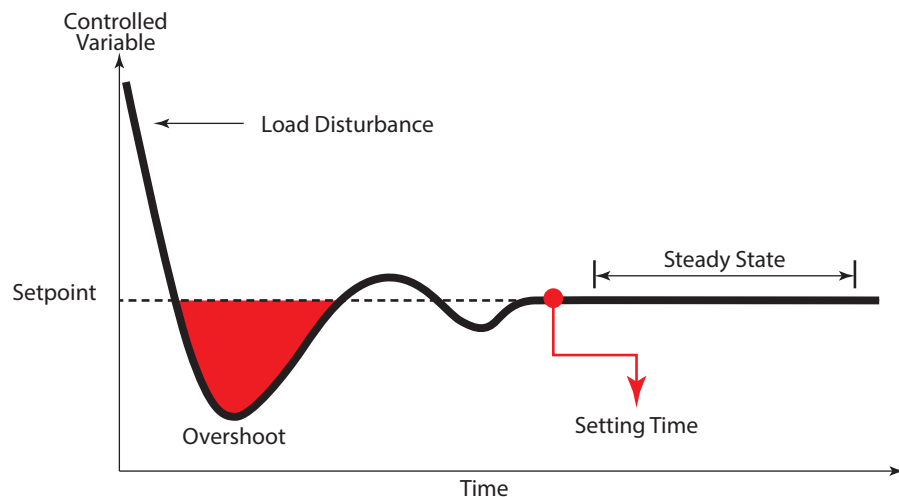

Fig 7

\*see page 54-55

The example above is a typical cooling application control response. The load disturbance is considered a significant change either in load or setpoint. (Fig 6)

The goal of a good control system is characterized to achieve the settling time the soonest possible with the lowest maximum deviation during steady state.

## Process control demand – Matching the system characteristic

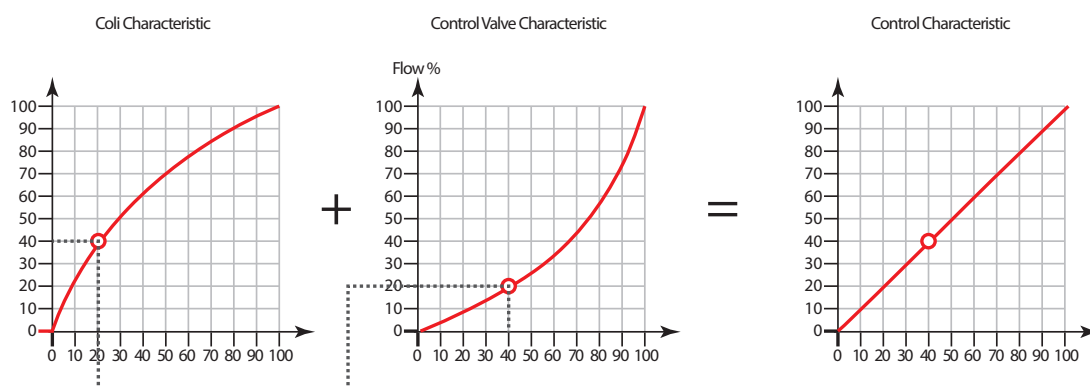

Fig 8

Every process system has different mix of characteristic. The control valve manufacturer has to always meet the design of the coil characteristic. As we can observe in the graphs above, the coil characteristic is logarithmic, hence, it requires an exact opposite characteristic to meet the linear control demand. We expect the control signal of 40% will be attribute an output of 40% capacity. The above control valve authority is equal to 1, which is unrealistic scenario in practice. A conventional control valve will always be changing when differential pressure changes within the hydronic system. Differential changes because of load is always varying within the system.

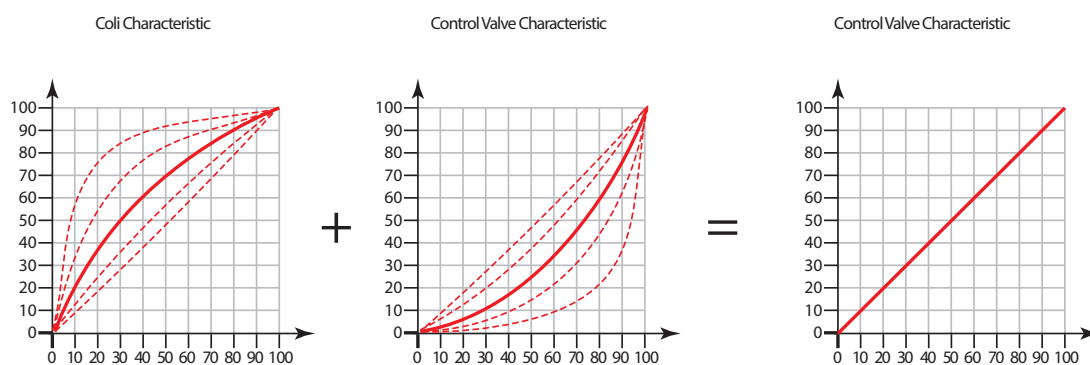

Fig 9

In reality, the coil can have different characteristic. This is very dependent on the thermal energy magnitude in the liquid. For instance in the cooling application, the colder the water, the steeper the coil characteristics. Certainly there are also many factors like the energy transfer surface and the speed of the air velocity. Ultimately to meet the exact opposite character, Danfoss has added a adjustable actuator characteristic. The actuator allows flexibility to switch from linear to logarithmic characteristic or in between. The feature is called Alpha Value setting. (Fig 9)

## The “low $\Delta T$ syndrome”

Chillers are sized for certain extreme conditions which depend on the climate relevant for that installation. It is important to realize that, in general, that means that the chillers are oversized since these extreme circumstances occur during less than 1% of the operational time. Effectively we can say that the installation is running in partial load for 99% of the time. When the installation is running in partial load, we can experience a phenomenon low  $\Delta T$  syndrome which can cause very low chiller efficiencies and fast on-off switching of the chiller. Additionally the low  $\Delta T$  syndrome prevents the chillers from running in the so-called Max-Cap mode. During Max-Cap the chiller can put out more than its rated capacity at very high efficiencies.

Low  $\Delta T$  syndrome occurs when the return supply temperature to the chiller is lower than designed. If the installation is designed for a differential temperature of 6K but the water fed into the chiller is only 3K lower than the chilled water supply setpoint, it is easy to understand the chiller can supply maximally only 50% of its rated capacity. If that is insufficient for the situation either the installation will not have enough capacity, or an extra chiller needs to be brought online.

Take this example: when the secondary circuit return water temperature is lower than the design temperature (due to overflow problems etc.), chillers cannot be loaded at their maximum capacity. If the chillers in the chilled water plant, designed to cool 13°C chilled water return to 7°C, we receiving a design flow rate at 11°C rather than a design temperature of 13°C, the chiller will be loaded at the ratio of:

$$\text{CHL}(\%) = \left[ \frac{\text{CWRTR} - \text{CWSTD}}{\text{CWRTR} - \text{CWSTD}} \right] \times 100\% = \left[ \frac{11-7}{13-7} \right] \times 100\% = 66,6\%$$

### Where:

- CHL (%) – Percent chiller loading
- CWRTR – Real chilled water return temperature (in our case, 11°C)
- CWSTD – Design chilled water supply temperature (in our case, 7°C)
- CWRTD – Design chilled water return temperature (in our case, 13°C)

In this case, where the low  $\Delta T$  in the plant (the difference between return and supply chilled water temperature) has been lowered from 6°C (13°C-7°C) design condition to 4°C (11°C-7°C), the capacity of the chiller has been reduced by 33,4 %.

In many cases the operating efficiency of the chiller can drop 30 to 40 percent when the returning chilled water temperature is lower than the designed. Contrarily when the  $\Delta T$  is increased, the efficiency of the chiller can increase up to 40%.

### How to solve

**There are several potential causes of low  $\Delta T$  syndrome:**

#### Using 3-way control valves:

3-way valves by their nature bypass the supply chilled water into the return line during part load conditions, causing the chilled water temperature to be lower than designed. This exacerbates low  $\Delta T$  problem (presented in application 1.1.12.1; 3.1.2).

The remedy: Do not use 3-way control valves but use a variable flow system with modulating control. If 3-way control valves are unavoidable, application 1.1.2.2. is recommended to limit overflows in partial load conditions.

#### Poor 2-way control valve selection with improper system balance:

An improperly sized 2-way control valve may allow a higher water flow than necessary. The low  $\Delta T$  syndrome is worse in partial load due to pressure changes in the system, which results in a high overflow through the control valves. This phenomenon occurs in particular in systems with faulty hydraulic balance as presented in application 1.1.1.7.

The remedy: 2-way control valves with built in pressure controllers. The pressure control function on the control valves eliminates the overflow problem and therefore eliminates low  $\Delta T$  syndrome.

#### Other such as:

Improper set-point, control calibration or reduced coil effectiveness.

\*see page 54-55

## The “overflow phenomenon”

One of the sources of the well-known problems in chilled water systems such as low  $\Delta T$  syndrome is the overflow phenomenon. In this chapter, we will shortly try to explain what it is and what it is caused by.

All systems are designed for nominal conditions (100% load). Designers calculate pump heads based on the combined pressure drop in pipes, terminal units, balancing valves, control valves and other elements in the installation (strainers, water meters etc), assuming the installation is operating at maximum capacity.

Consider a traditional system as presented below, Fig 10.1, based on application 1.1.1.7. It is obvious that the coil and control valve located closer to the pump will have a higher available pressure as compared to the one last in the installation. In this application, unnecessary pressure has to be reduced by manual balancing valves, so the manual balancing valves closer to the pump will be more throttled. The system operates properly only with 100% load.

In Fig 10.2 we see a so-called reverse return system (Tichelman). The idea behind this system is that because the total pipe length for every terminal unit is equal, no balancing is necessary because the available pressure for all units is the same. Please note that if the terminal units require different flows you still need to balance the system with balancing valves. In general, we can say that the only proper application of a reverse return system is when we’re talking about a constant flow system (3-way valves) and when all the terminal units are of the same size.

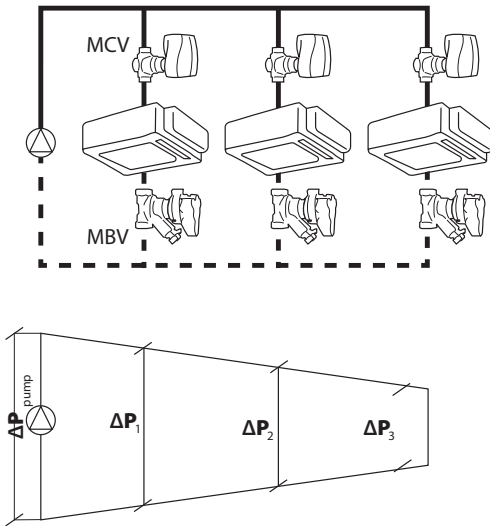

Fig 10.1 Direct return system (not recommended system)

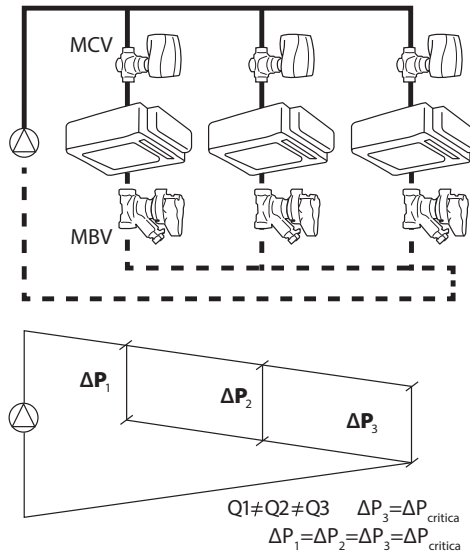

Fig 10.2 Variable flow static FCU control (not recommended system)

To control flow across each coil, two-way control valves are used. Consider the situation in partial load (i.e. coils 2 is closed).

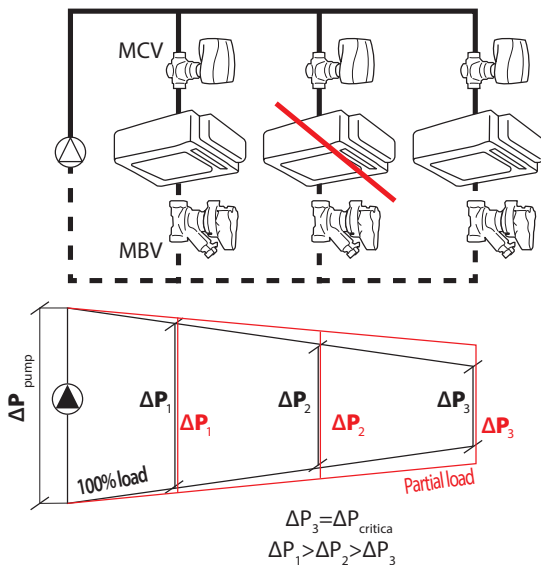

Fig 11.1 Partial load - direct return system

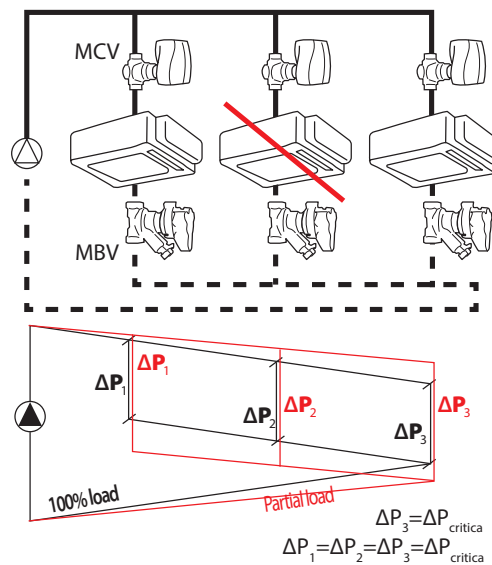

Fig 11.2 Partial load - reverse return system

\*see page 54-55

Due to a lower flow in the system, the pressure drop in the pipe system decreases, providing a higher available pressure in the still open circuits. Since manual balancing valves (MBV) with fixed, static, settings were used to balance the system, the system becomes unbalanced. Consequently a higher differential pressure across the 2-way control valves causes overflows across the coils. This phenomenon appears in direct return systems as well as in reverse return systems. This is the reason why these applications are not recommended, as the circuits are pressure dependent.

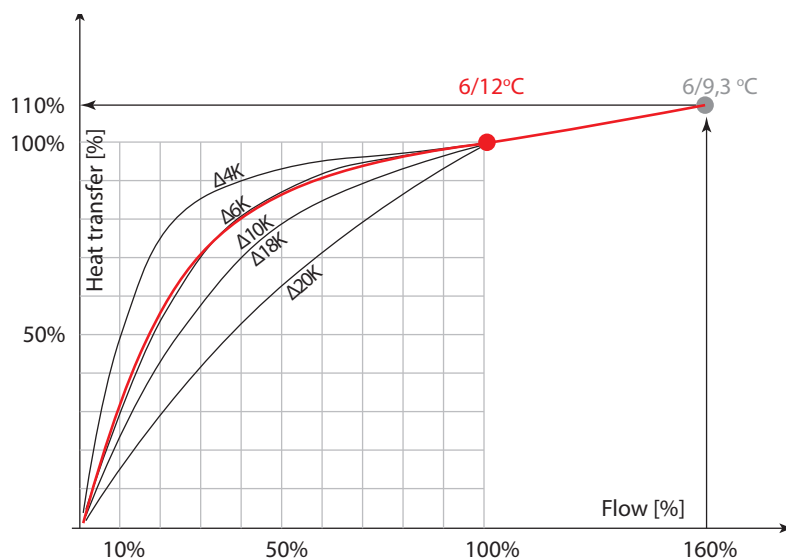

Fig 12  
Terminal unit emission characteristic

The traditional FCU is usually designed for a  $\Delta T$  of 6 K. The 100% emission is achieved at 100% flow across the unit at a supply temperature of 6°C and a return 12°C. The overflow across the unit has little influence on the emission. However, another phenomenon is more critical for proper chilled water system functionality. Higher flow across the units has an incredible influence on heat/cool transfer which means that the return temperature never achieves the designed temperature. Instead of the design temperature of 12°C, the real temperature is much lower, for example 9,3°C. The consequence of a lower return temperature from the FCU can be low  $\Delta T$  syndrome.

For variable flow systems it is not recommended to use fixed speed pumps as they worsen the overflow problem. In Fig 13 this can be seen clearly. The figure represents the pump curve and the differently colored areas represent the pressure drops in the system. The red area represents the pressure drop across the control valve. If we let the pump follow its natural curve, we see that with a decreasing flow, the differential pressure will rise. If you compare the differential pressure at 50% of the load you can see that the available pump head is much higher ( $P_1$ ) than the pump head at full load ( $P_{nom}$ ). All the extra pressure will have to be absorbed by the control valve. This will cause overflows in the system, as well as a serious deformation of the characteristic of the valve.

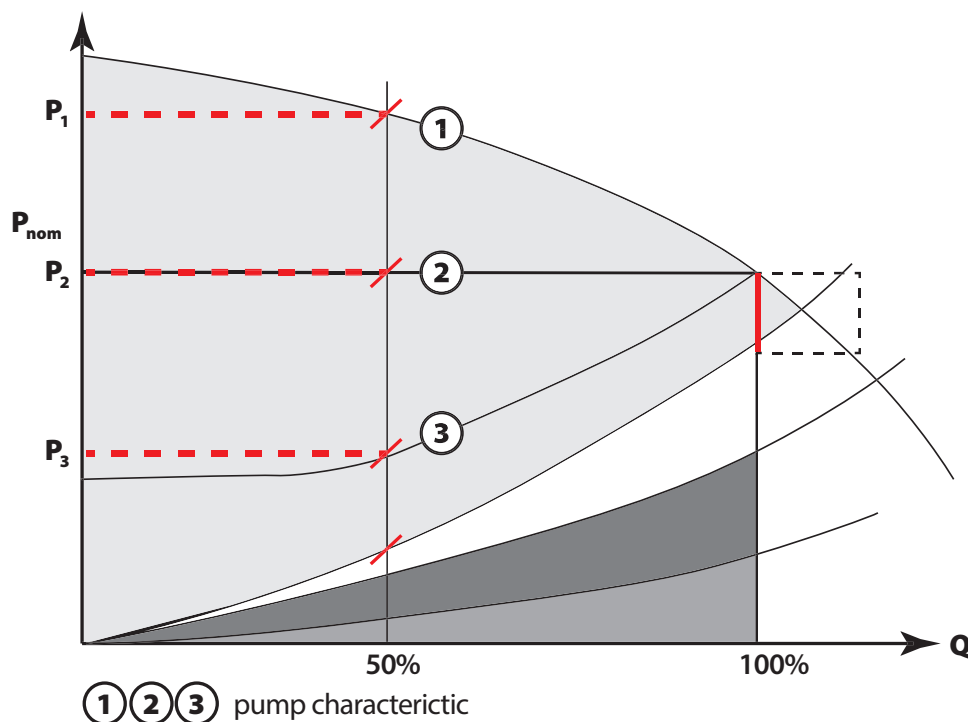

Fig 13 Different pump characteristic

Today commonly used Variable Speed Drives (VSD\*) with pressure transmitters can modify the pump characteristic in accordance with flow and pressure changes in the water system. The nominal flow at 100% load and the above-mentioned pressure drop in the system determine the pump head which is equal to the nominal pressure,  $P_{nom}$ . We can see that a constant differential pressure results in a much better situation at partial load, the differential pressure across the control valve will increase much less than when the natural curve of the pump is followed. Please note however, that the pressure across the control valve will still rise considerably.

Modern pumps come equipped with speed controllers that can modify the pump not only based on the pressure but also on the flow, the so-called proportional control. If the flow is reduced, the differential pressure is reduced. Theoretically this gives the best results as can be seen at  $P_3$  in Fig. 13. Unfortunately, it is unpredictable where in the installation the flow will be reduced so there is no guarantee that the pressure can be reduced as much as can be seen in Fig. 13. It is therefore strongly recommended to limit the difference pressure on  $P_2$  level to prevent parts of the installation from starving in certain situations.

The inescapable conclusion is that over- and underflow problems cannot be solved by the pump alone. It is therefore strongly recommended to use pressure independent solutions. Pressure independent Balancing and Control Valves (AB-QM) can take care of pressure fluctuations in the system and will provide the terminal units always with the right flow, under all loads of the system. We definitely recommend using VSDs\* on the pump since that will result in very big savings. As for the control method we recommend to use fixed differential pressure control which will guarantee enough pressure under all circumstances. If proportional control is wanted than the AB-QM can operate under such conditions but we recommend keeping the pressure difference on  $P_3$  level as to a minimum to prevent starving of certain parts of the installation during partial load.

\*see page 54-55

## The “underflow phenomenon”

As can be seen from Fig 10.1, the available pressure for the first circuit is much higher than the pressure of the last circuit. In this application the MBVs should take care of this by throttling the excess flow. So, the last MBV should be opened as much as possible and the other MBVs should be more and more throttled the closer they are to the pump.

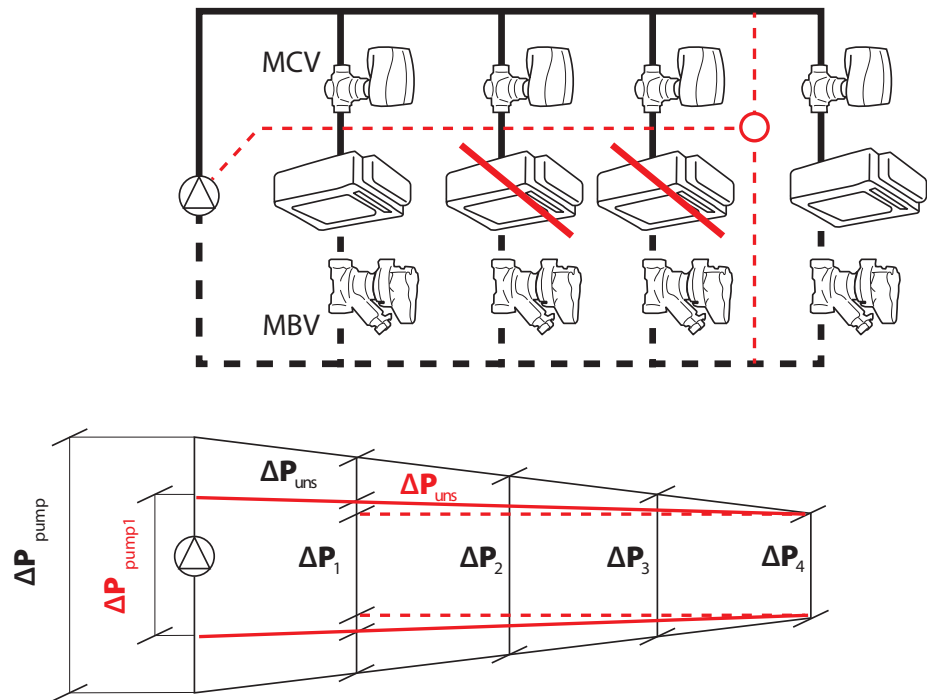

Fig 14 Direct system with proportional pump control

A very standard application places the differential pressure sensor controlling the pump at the last terminal unit to minimize pump consumption. We can see what happens when the two middle terminal units are closed. Because the flow in the piping is considerably reduced also the resistance in the system goes down which means that most of the pump head ends up at the end of the installation where the sensor is. This is represented by the red lines in Fig 14. If you look at the first unit you can see that, even though the pressure on the loop should be the same, it actually gets a much lower differential pressure and therefore too little flow. This can lead to the confusing situation where the installation is operating without problems on full load and when the load is reduced there are capacity problems close to the pump. Needless to say, putting the pump on proportional control will enhance the problems considerably. The pump senses a 50% drop in the flow and will drop the differential pressure, accordingly, creating even lower flows in the first terminal unit and a capacity problem at the last terminal unit as well.

An often-suggested compromise between creating underflows and minimizing the pump consumption is to put the sensor at a length of two-thirds of the system. This is however still a compromise and there is no guarantee for having the right flow under all circumstances. An easy solution is to mount Pressure Independent Balancing and Control Valves (AB-QM) on every terminal unit and control the pump on constant differential pressure. That way you will maximize the savings on the pump without any under- or overflow problems.



# Energy efficiency analyses

## Goal:

In this chapter we describe in detail the differences between 4 hydronic balancing and control solutions for an imaginary hotel building.

For the comparison purpose the HVAC system in our hotel building is equipped with a 4-pipe heating/cooling system.

For each of the 4 solutions we analyze the energy consumption/efficiency. By adding the investment and operational costs, the payback time for each of the solutions is calculated.

- MBV\_ON/OFF - 2 way control valve with ON/OFF actuator on Terminal Unit and Manual Balancing Valves on distribution pipe, risers, branches and TU-s.
- DPCV\_ON/OFF - 2 way control valve with ON/OFF actuator on Terminal Unit and Differential Pressure Control Valves on branches
- DPCV\_modulation - 2 way control valve with modulating actuator on Terminal Unit and Differential Pressure Control Valves on branches
- PICV\_modulation – Danfoss recommendation -Pressure Independent Control Valve (PICV) with Modulating actuator on (TU). Optional MBV for flow verification on branches

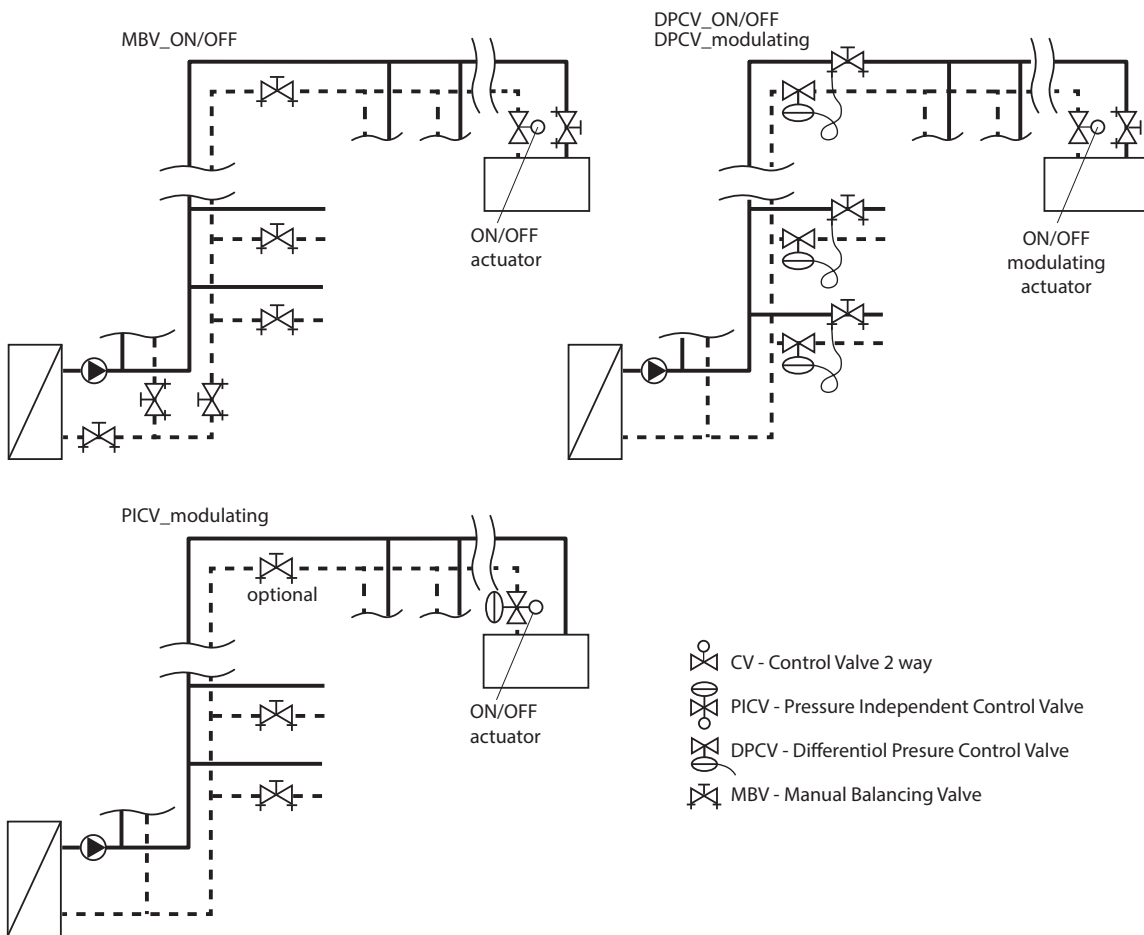

Fig 15

\*see page 54-55

## 9.2

## Data:

Building data		
Volume	57600	m <sup>3</sup> /h
Area total	18000	m <sup>2</sup>
Nr. Floors	15	
Area/Floor	1200	m <sup>2</sup>

Cooling demand		
Capacity	900	kW
Regime	7/12	°C
Cooling demand / m <sup>2</sup>	50	W/m <sup>2</sup>
Cooling demand / m <sup>3</sup>	15,6	W/m <sup>3</sup>

COOLING SYSTEM DATA		
Nr risers	2	
Nr branches/riser	15	
Nr unit/branch	20	
Nr unit total	600	
Capacity/unit	1,5	kW
Capacity/branch	30	kW
Flow/unit	258	l/h
Flow/branch	5160	l/h
Flow/riser	77400	l/h
Flow/building	154800	l/h
Cost of electricity	0,15	EUR/kWh
Cooling season	150	days
Chiller COP	3,5	

Heating demand		
Capacity	630	kW
Regime	50/40	°C
Cooling demand / m <sup>2</sup>	35	W/m <sup>2</sup>
Cooling demand / m <sup>3</sup>	11	W/m <sup>3</sup>

HEATING SYSTEM DATA		
Nr risers	2	
Nr branches/riser	15	
Nr unit/branch	20	
Nr unit total	600	
Capacity/unit	1,05	kW
Capacity/branch	21,0	kW
Flow/unit	91	l/h
Flow/branch	1820	l/h
Flow/riser	27300	l/h
Flow/building	54600	l/h
Cost of electricity	0,008	EUR/kWh
Cooling season	180	days
Chiller COP	Condensing	

## 9.3

## System scheme:

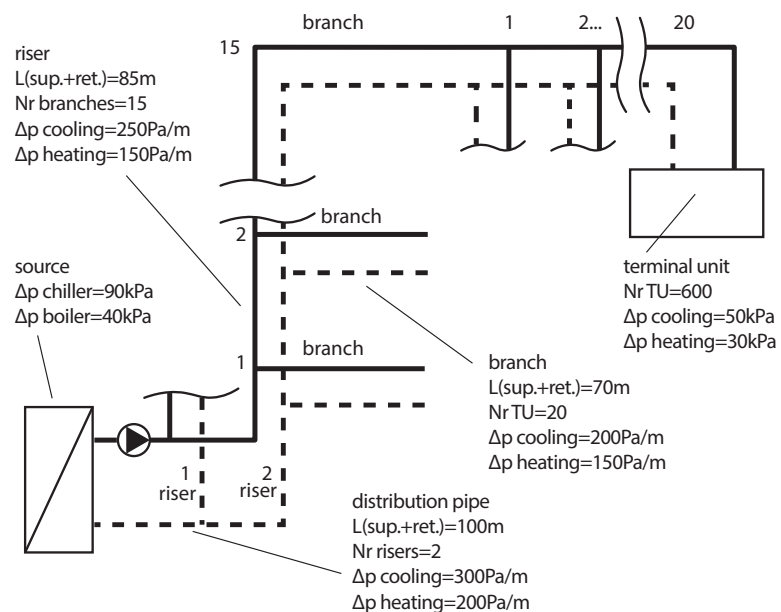

Fig 16

Load profile:

Cooling load profile:

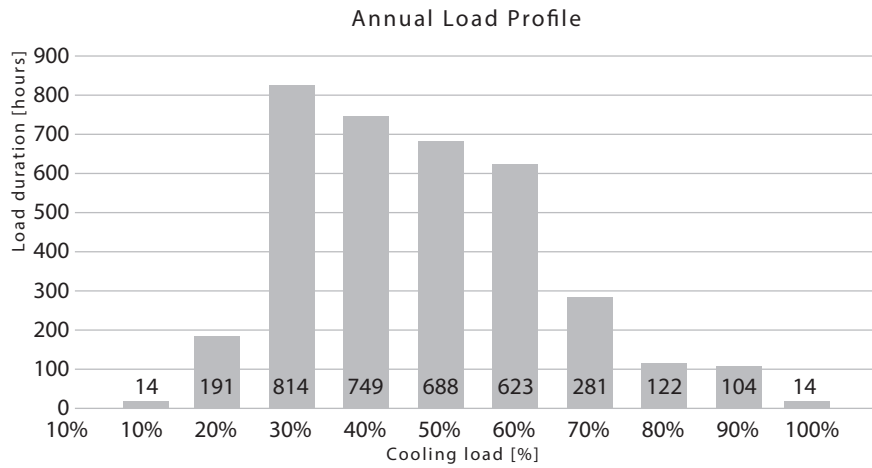

Fig 17

Load [%]	10%	20%	30%	40%	50%	60%	70%	80%	90%	100%
Time [%]	0,40%	5,30%	22,60%	20,80%	19,10%	17,30%	7,80%	3,40%	2,90%	0,40%
Capacity [kW]	90	180	270	360	450	540	630	720	810	900
Time [hours]	14	191	814	749	688	623	281	122	104	14
Energy consumpt. [kWh]	1296	34344	219672	269568	309420	336312	176904	88128	84564	12960

Expected cooling energy consump. [kWh/a] 1 533 168,0  
 Expected electrical energy consumption (COP=3,5) [kWh/a] 438 048,0  
 Expected energy cost [EUR/a] 65 707,20

Heating load profile:

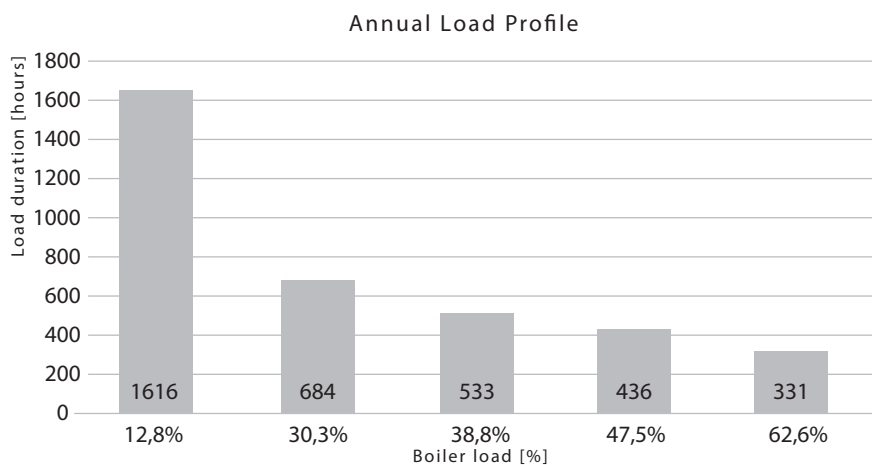

Fig 18

Load [%]	12,8%	30,3%	38,8%	47,5%	62,6%
Time [%]	44,9%	19,0%	14,8%	12,1%	9,2%
Capacity [kW]	115,2	272,7	349,2	427,5	563,4
Time [hours]	1616	684	533	436	331
Energy consumpt. [kWh]	186209	186527	186054	186219	186598

Expected heating energy consump. [kWh/a] 931 606,9  
 Expected energy cost [EUR/a] 26 830,28

# 9.5

## Energy consumption

### Cooling:

#### Pump energy consumption

Most suitable pump control will be combined with matching balancing & control solution.

MBV_ON/OFF	constant differential pressure pump control
DPCV_ON/OFF	proportional pressure, calculated pump control
DPCV_modulation	proportional pressure, calculated control
PICV_modulation	proportional pressure, measured control

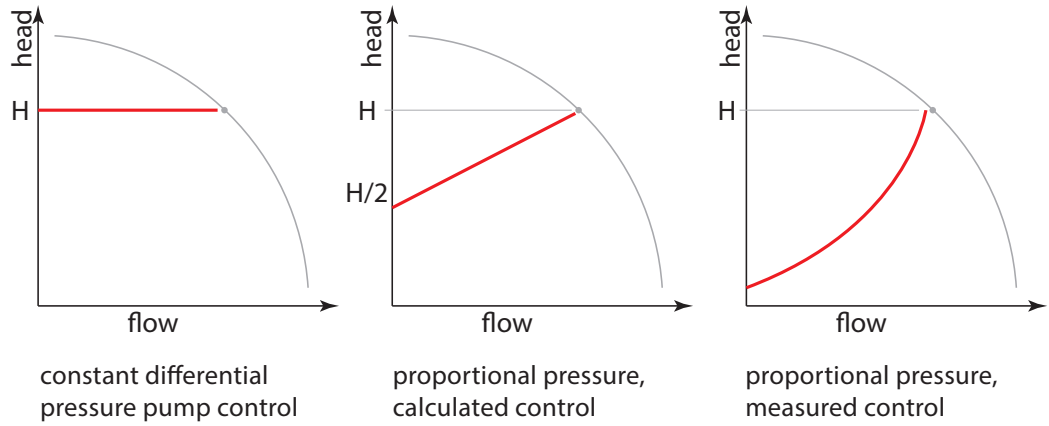

Fig 19

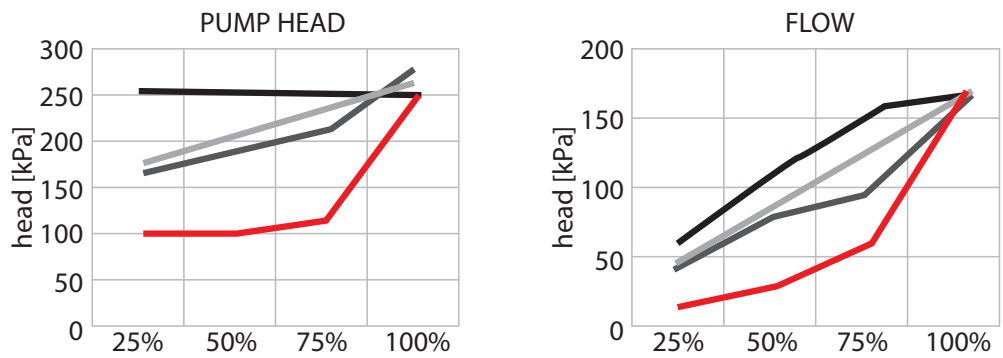

Fig 20

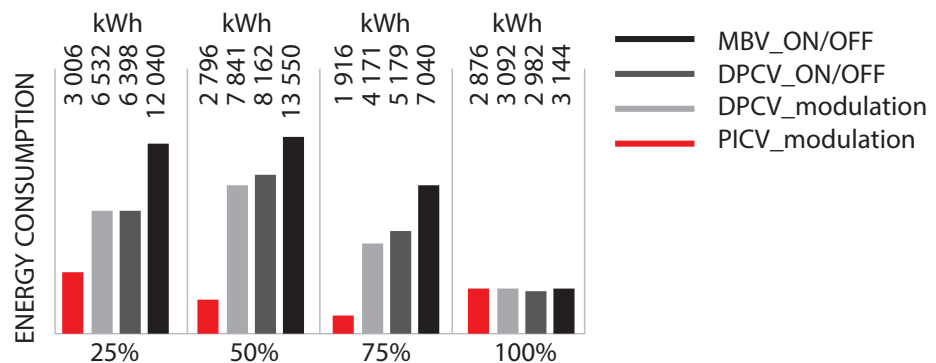

Fig 21

## Chiller energy consumption comparison:

### Design conditions:

Chiller plant:

COP:

Chilled water Supply temperature (constant):

Chilled water Return temperature (variable):

Design

### Assumption:

If  $\Delta T_{chw} < 5K \Rightarrow T_{chw,return} < 12^{\circ}C$ , COP will drop

if  $\Delta T_{chw} > 5K \Rightarrow T_{chw,return} > 12^{\circ}C$ , COP will increase

Variable primary  
3.5 kW/kW (100% load)

$T_{chw,supply} = 7^{\circ}C$

$T_{chw,return} = 12^{\circ}C$

$\Delta T_{chw} = 5K$

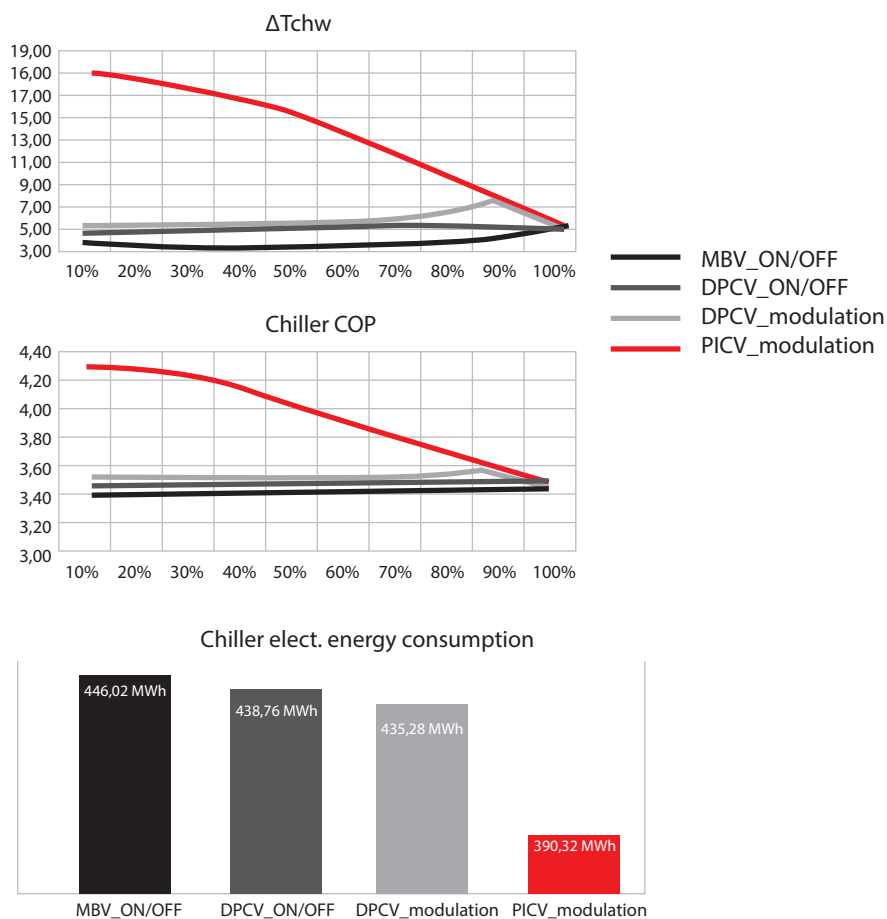

Fig 22

## Temperature control energy consumption comparison:

Expected room temperature deviation:

MBV_ON/OFF	±1.5°C	=	22,5%
DPCV_ON/OFF	±1.0°C	=	15%
DPCV_modulation	±0.5°C	=	8%
PICV_modulation	±0.0°C	=	0%

Each 1°C deviation causes, from 12% up to 18% more energy consumption per the whole cooling system. For calculation 15% per 1°C deviation is taken.

**Break-up HVAC energy consumption**

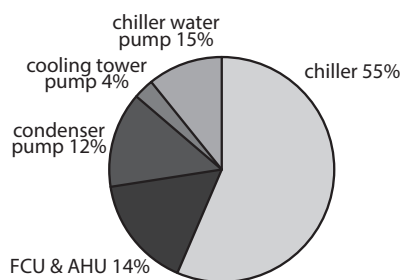

Chiller energy consumption presents approx. 55% of whole cooling system energy consumption. Let's take energy consumption of chiller 390MWh as a reference. Then whole cooling system consumes 710MWh of electrical energy per season.

Fig 23

**Additional energy consumption due to room temperature control**

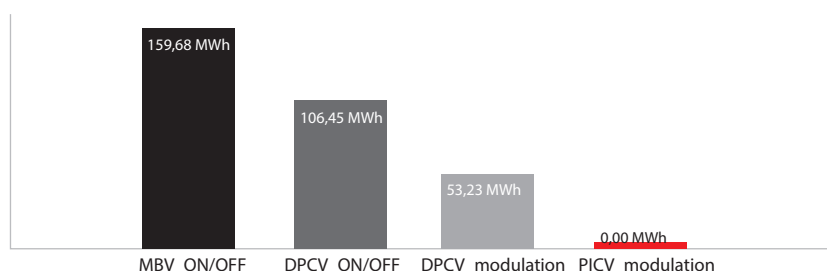

Fig 24

### Comparison:

	MBV_ON/OFF	DPCV_ON/OFF	DPCV_MODULATION	PICV_MODULATION
<b>Energy consumption</b>				
Pumping	35 774,0 kWh	22 721,0 kWh	21 636,0 kWh	10 594,0 kWh
Chiller energy consumption	446 022,2 kWh	438 761,6 kWh	435 275,7 kWh	390 322,6 kWh
Add. en. usage temp control	159 676 kWh	106 450,9 kWh	53 225,5 kWh	0,0 kWh
<b>SUM</b>	<b>641 472,6 kWh</b>	<b>567 933,5 kWh</b>	<b>510 137,1 kWh</b>	<b>400 916,6 kWh</b>
<b>Energy consumption cost</b>				
Pumping	5 366,10 kWh	3 408,15 kWh	3 245 kWh	1 589,1 kWh
Chiller energy consumption	66 903,33 kWh	65 814,24 kWh	65 291,35 kWh	58 548,4 kWh
Room temp control energy consumption	23 951,45 kWh	15 967,64 kWh	7 983,82 kWh	- kWh
<b>SUM</b>	<b>96 220,89 kWh</b>	<b>85 190,02 kWh</b>	<b>76 520,57 kWh</b>	<b>60 137,50 kWh</b>
<b>Investment</b>				
Distribution pipe balancing	2 239,2 €	- €	- €	- €
Riser balancing	3 141,8 €	- €	- €	- €
Branch balancing/flow verification	6 522,0 €	27 894,0 €	26 874,0 €	6 522,0 €
Terminal unit	34 800,0 €	34 800,0 €	53 100,0 €	85 140,0 €
Room thermostat	15 000,0 €	15 000,0 €	21 000,0 €	21 000,0 €
Remote dp sensor	- €	- €	- €	2 000,0 €
<b>SUM</b>	<b>61 703,0 €</b>	<b>77 694,0 €</b>	<b>100 974,0 €</b>	<b>114 662,0 €</b>
<b>Payback time</b>				
Energy cost	96 220,89 €	85 190,02 €	76 520,57 €	60 137,50 €
Investment	61 7703,00 €	77 694,00 €	100 974,00 €	114 662,00 €
Payback time vs MBV_on/off		1,45 year	1,99 year	1,47 year
Payback time vs DPCV_on/off			2,69 year	1,48 year
Payback time vs DPCV_modulation				0,8 year

# Heating:

## Pump energy consumption

MBV\_ON/OFF constant differential pressure pump control  
 DPCV\_ON/OFF proportional pressure, calculated control  
 DPCV\_modulation proportional pressure, calculated control-  
 PICV\_modulation proportional pressure, measured control

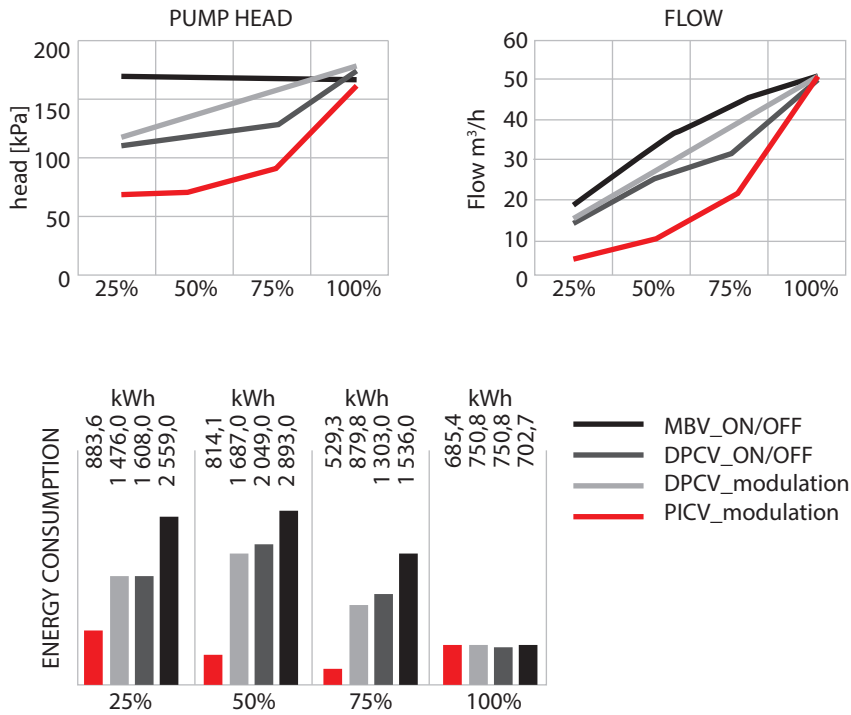
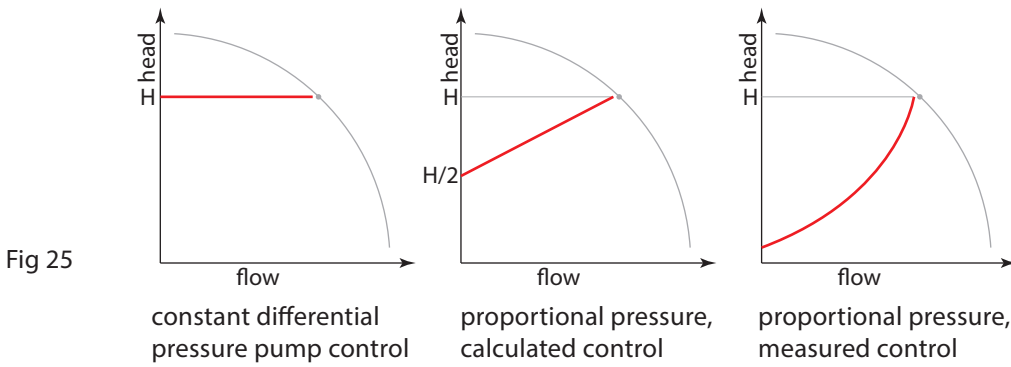

Fig 26

## Boiler energy consumption comparison:

### Design conditions:

Heating water Supply temperature (constant):  $T_{chw,supply} = 50^{\circ}\text{C}$

Heating water Return temperature (variable):  $T_{chw,return} = 40^{\circ}\text{C}$

Design  $\Delta T_{hw} = 10\text{K}$

### Assumption:

If  $\Delta T_{hw} < 10\text{K} \Rightarrow T_{hw,return} > 40^{\circ}\text{C}$ , Boiler efficiency will drop

if  $\Delta T_{chw} > 10\text{K} \Rightarrow T_{hw,return} < 40^{\circ}\text{C}$ , Boiler efficiency will increase

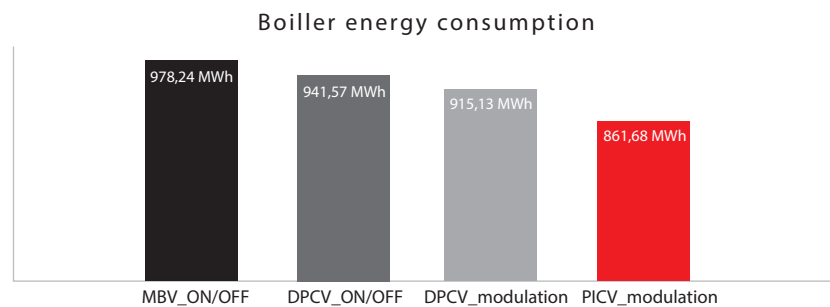

Fig 27

## Temperature control energy consumption comparison:

Expected room temperature deviation:

MBV_ON/OFF	$\pm 1.5^{\circ}\text{C}$	=	9,75%
DPCV_ON/OFF	$\pm 1.0^{\circ}\text{C}$	=	6,5%
DPCV_modulation	$\pm 0.5^{\circ}\text{C}$	=	3,25%
PICV_modulation	$\pm 0.0^{\circ}\text{C}$	=	0%

Each  $1^{\circ}\text{C}$  deviation causes, from 5% up to 8% more energy consumption per whole heating system. For calculation 6,5% is taken.

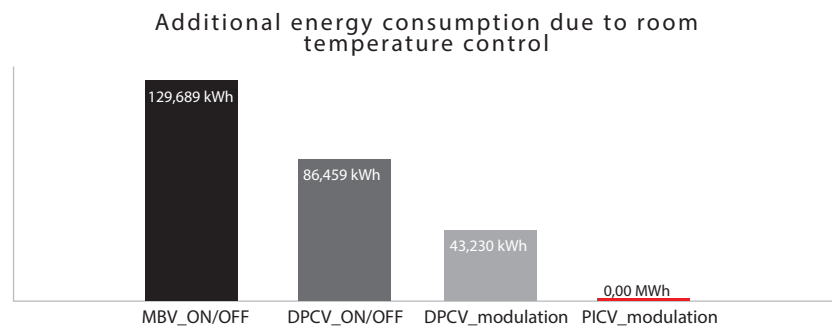

Fig 28



# Comparison table - 4 pipe (cooling and heating) system:

	MBV_ON/OFF	DPCV_ON/OFF	DPCV_MODULATION	PICV_MODULATION
<b>Energy consumption heating</b>				
Pumping	7 689,0 kWh	5 711,0 kWh	4 797,0 kWh	2 912,0 kWh
Boiler energy consumption	978 240,0 kWh	941 570,0 kWh	915 130,0 kWh	861 680,0 kWh
Energy usage due to room temp deviation	172 918,4 kWh	129 688,8 kWh	86 459,2 kWh	43 229,6 kWh
<b>SUM</b>	<b>1 158 847,4 kWh</b>	<b>1 076 969,8 kWh</b>	<b>1 006 386,2 kWh</b>	<b>907 821,6 kWh</b>

<b>Energy cost heating</b>				
Pumping	1 153,35 €	856,65 €	719,55 €	436,80 €
Boiler energy consumption	28 171,06 €	27 115,05 €	26 353,64 €	24 814,40 €
Room temp control energy consumption	4 979,65 €	3 734,74 €	2 489,83 €	1 244,91 €
<b>SUM</b>	<b>34 304,06 €</b>	<b>31 706,44 €</b>	<b>29 563,01 €</b>	<b>26 496,11 €</b>

<b>Energy consumption cooling</b>				
Pumping	35 774,0 kWh	22 721,0 kWh	21 636,0 kWh	10 594,0 kWh
Chiller energy consumption	446 022,2 kWh	438 761,6 kWh	435 275,7 kWh	390 322,6 kWh
Energy usage due to room temp deviation	6 522,0 kWh	106 450,9 kWh	53 225,5 kWh	0,0 kWh
<b>SUM</b>	<b>61 703,0 kWh</b>	<b>567 933,5 kWh</b>	<b>510 137,1 kWh</b>	<b>400 916,6 kWh</b>

<b>Energy cost cooling</b>				
Pump	5 366,10 €	3 408,15 €	3 245,40 €	1 589,10 €
Chiller energy consumption	66 903,33 €	65 814 €	65 291,35 €	58 548,40 €
Room temp control energy consumption	23 951,45 €	15 967,64 €	7 983,82 €	- €
<b>SUM</b>	<b>96 220,89 €</b>	<b>85 190 €</b>	<b>76 520 €</b>	<b>60 137,50 €</b>

<b>Investment heating</b>				
Distribution pipe balancing	919,20 €	- €	- €	- €
Riserbalancing	971,80 €	- €	- €	- €
Branch balancing/flow verification	2 997,00 €	8 019,00 €	8 019,00 €	2 997,00 €
Terminal unit	34 800 €	34 800,00 €	53 100,00 €	85 140,00 €
Room thermostat	1 for cooling & heating	1 for cooling & heating	1 for cooling & heating	1 for cooling & heating
Remote Δp sensors	- €	- €	- €	2 000,00 €
<b>SUM</b>	<b>39 688,00 €</b>	<b>42 819,00 €</b>	<b>61 119,00 €</b>	<b>90 137,00 €</b>

<b>Investment cooling</b>				
Distribution pipe balancing	2 239,20 €	- €	- €	- €
Riserbalancing	3 141,80 €	- €	- €	- €
Branch balancing/flow verification	6 522,00 €	27 894,00 €	26 874,00 €	6 522,00 €
Terminal unit	34 800,00 €	34 800,00 €	53 100,00 €	85 140,00 €
Room thermostat	15 000,00 €	15 00,00 €	21 000,00 €	21 00,00 €
Remote Δp sensors	- €	- €	- €	2 000,00 €
<b>SUM</b>	<b>661 703,00 €</b>	<b>77 694,00 €</b>	<b>100 974,00 €</b>	<b>114 662,00 €</b>

<b>Payback time</b>				
Energy cost HEATING	34 304,06 €	31 706,44 €	29 563,01 €	26 496,11 €
Energy cost COOLING	96 220,89 €	85 190,02 €	76 520,57 €	60 137,50 €
Investment HEATING	39 688,00 €	42 819,00 €	61 119,00 €	90 137,00 €
Investment COOLING	61 703,00 €	77 694,00 €	100 974,00 €	114 662,00 €
<b>total</b>	<b>231 915,95 €</b>	<b>237 409,46 €</b>	<b>268 176,58 €</b>	<b>291 432,661 €</b>

Payback time vs MBV_on/off	1,40 year	2,48 year	2,36 year
Payback time vs DPCV_on/off		3,85 year	2,79 year
Payback time vs DPCV_modulation			2,2 year

## Notes

## Product overview











Here you find a short overview of all the Danfoss products as used in the HVAC applications described.









PICV: Pressure Independent Control Valves

PICV without actuators: Automatic Flow Limiter

PICV with actuators: Pressure Independent Control Valves with balancing function





Picture	Name	Description	Size (mm)	Flow (m <sup>3</sup> /h)	Datasheet active link	Comments
	AB-QM	Pressure independent control valve, with or without test plug; size small, combinations for thermal units	15... 32	0.02...4		Combined with actuator ensures high end flow control – logarithmic or linear characteristic
	AB-QM	Pressure independent control valve, with or without test plug; size medium, combinations for air handling units	40... 100	3...59		Combined with actuator ensures high end flow control – logarithmic characteristic
	AB-QM	Pressure independent control valve, with or without test plug; size large, combinations for chillers	125... 150	36...190		Combined with actuator ensures high end flow control – logarithmic characteristic
	AB-QM	Pressure independent control valve, with or without test plug; size x-large, combinations for district cooling	200...250	80...370		Combined with actuator ensures high end flow control – logarithmic characteristic

Actuators for AB-QM valves



Picture	Name	Description	usage with	control signal	Datasheet active link	Comments
	TWA-Q	Thermal actuator with 24V and 230V AC/DC power supply, visual positioning indicator. Speed 30s/mm	AB-QM valves size S; dn 10-32	on/off; (PWM)		IP54, cable length 1.2/2/5 m
	AMI 140	Gear actuator with 24V and 230V AC power supply, positioning indicator. Speed 12s/mm	AB-QM valves size S; dn 15-32	on-off		IP42, cable length 1.5/5 m
	ABNM	Thermal actuator with 24V AC/DC power supply, visual positioning indicator. Speed 30s/mm	AB-QM valves size S; dn 15-32	0-10V		IP54, cable length 1/5/10 m; logarithmic or linear characteristic
	AMV 110/120 NL	Gear actuator with 24V AC power supply, positioning indicator. Speed 24/12s/mm	AB-QM valves size S; dn 15-32	3-point		IP42, cable length 1.5/5/10 m logarithmic or linear characteristic

	AME 110/120 NL (X)	Gear actuator with 24V AC power supply, positioning indicator. Speed 24/12 s/mm	AB-QM valves size S; dn 15-32	0-10V; 4-20mA		IP42, cable length 1.5/5/10 m x-signal, logarithmic or linear characteristic
	NovoCon S	Digital step motor 24V AC/DC power supply, possible BMS integration. Speed 24/12/6/3 s/mm	AB-QM valves size S; dn 15-32	BACnet; Modbus; 0-10V; 4-20mA		IP 54, cable length 1.5/5/10 m, Daisy-chain cable length 0.5/1.5/5/10 m, logarithmic or linear characteristic
	AMV 435	Gear push-pull actuator with 24V and 230V AC power supply, hand operation, LED indication. Speed 15/7,5 s/mm	AB-QM valves size M; dn 40-100	3-point		IP 54, push/pull
	AME 435 QM	Gear push-pull actuator with 24V AC/DC power supply, hand operation, LED indication. Speed 15/7,5 s/mm	AB-QM valves size M; dn 40-100	0-10V; 4-20mA		IP 54, push/pull, x-signal, logarithmic or linear characteristic
	NOVOCON M	Digital step motor 24V AC/DC power supply, possible BMS integration. Speed 24/12/6/3 s/mm	AB-QM valves size M; dn 40-100	BACnet; Modbus; 0-10V; 4-20mA		IP 54, push/pull, logarithmic or linear characteristic, 3x Temperature sensors; 1x Analog Input; 1x Analog Output
	AME 655/658*	Gear actuator with 24V AC/DC power supply, UL certification. Speed 6/2(4*)	AB-QM valves size L; dn 125-150	0-10V; 4-20mA; 3-point		IP 54, push/pull, x-signal, logarithmic or linear characteristic, safety functions spring up / spring down
	AME 55 QM	Gear actuator with 24V AC power supply, positioning indicator. Speed 8 s/mm	AB-QM valves size L; dn 125-150	0-10V; 4-20mA; 3-point		IP 54, push/pull, x-signal, logarithmic or linear characteristic
	NOVOCON L	Digital step motor 24V AC/DC power supply, possible BMS integration. Speed 24/12/6/3 mm	AB-QM valves size L; dn 125-150	BACnet; Modbus; 0-10V; 4-20mA		IP 54, push/pull, logarithmic or linear characteristic, 3x Temperature sensors; 1x Analog Input; 1x Analog Output; Spring up / Spring down
	AME 685	Gear actuator with 24V AC/DC power supply, UL certification. Speed 6/3 s/mm	AB-QM NovoCon valves size XL; dn 200-250	0-10V; 4-20mA; 3-point		IP 54, push/pull, x-signal, logarithmic or linear characteristic
	NOVOCON XL	Digital step motor 24V AC/DC power supply, possible BMS integration. Speed 24/12/6/3 s/mm	AB-QM NovoCon valves size XL; dn 200-250	BACnet; Modbus; 0-10V; 4-20mA		IP 54, push/pull, logarithmic or linear characteristic, 3x Temperature sensors; 1x Analog Input; 1x Analog Output;









Electronic and selfacting controller for AB-QM; One pipe system accessories

Picture	Name	Description	Size (mm)	setting range	Datasheet active link	Comments
	CCR3+	Return temperature controller, temperature registration. Electronic control	-	-		Programmable temperature control, data storage, TPC/IP, Wi-Fi, BMS
	QT	Self-acting actuator, return temperature controller. Proportional control	DN 15-32	35-50°C, 45-60°C 65-85°C		Sensor holder and heat conductivity pasta included- Sensor holder and heat conductivity pasta included

Change over solution  
Change over valve

Picture	Name	Description	Size (mm)	Kvs (m3/h)	Datasheet active link	Comments
	ChangeOver valve 6	Motorized 6-port Ball Valves for local change over between heating and cooling	15...20	2,4...4,0		Change over valve for heating/cooling mode changes in 4 pipe system with 2 pipe terminal unit. Not suitable for control

Change over actuators

Picture	Name	Description	usage with	control signal	Datasheet active link	Comments
	Actuator Change Over 6	Rotating actuator, 2-point control, 24V AC power supply . Speed 80 s/mm	Change-Over valve 6	0-10V		Connected to control system to ensure change over between heating and cooling
	Actuator NovoCon Change Over 6	Rotating actuator, 2-point control, power supply via NovoCon. Speed 120 s/mm	Change Over valve 6	0-10V by NovoCon®		Connected to NovoCon with plug in cable
	Actuator NovoCon Change Over 6 Energy	Rotating actuator, 2-point control, power supply via NovoCon, 2 temperature sensor. Speed 120 s/mm	Change Over valve 6	0-10V by NovoCon®		Connected to NovoCon with plug in cable, with built in 2*PT1000 temperature sensors
	Actuator NovoCon Change Over 6 Flexible	Rotating actuator, 2-point control, power supply via NovoCon, I/O cable. Speed 120 s/mm	Change Over valve 6	0-10V by NovoCon®		Connected to NovoCon with plug in cable, with built in I/O cable for peripheral device connections







DBV - Dynamic Balancing Valves  
DPCV - Differential Pressure Controller

Picture	Name	Description	Size (mm)	Kvs (m <sup>3</sup> /h)	Datasheet active link	Comments
	ASV-P	Differential pressure controller in the return pipe with fix 10 kPa pressure setting	15... 40	1,6... 10		Integrated shut off and draining possibility
	ASV-PV	Differential pressure controller in the return pipe with adjustable 5-25 or 20-60 kPa pressure setting	15... 50	1,6... 16		Integrated shut off and draining possibility, upgradeable $\Delta p$ range
	ASV-M	Flow pipe mounting valve, impuls tube connection, shut off function,	15... 50	1,6... 16		Used with ASV-P or PV together mainly for shut of function
	ASV-I	Flow pipe mounting valve impuls tube connection, presetting, measuring possibility, shut off function	15... 50	1,6... 16		Used with ASV-PV valve together mainly for flow limitation function
	ASV-BD	Flow pipe mounting valve impuls tube connection, presetting, measuring possibility, shut off function	15...50	3...40		Used with ASV/P or PV together, big capacity, measurement, shut of function
	ASV-PV	Differential pressure controller with adjustable 20-40, 35-75 or 60-100 kPa pressure setting	50... 100	20... 76		Used with MSV-F2 in the flw pipe for shut off flow limiting and impulse tube connection
	AB-PM	Pressure Independent Balancing and Zone Valve	10... 32	0,02...2,4 $\Delta p=10/20Pa$		Max. flw capacity depends on $\Delta p$ demand of controlled loop
	AB-PM	Differential pressure controller with adjustable $\Delta p$ range and Zone Valve	40...100	3...14 $\Delta p=42/60 kPa$		Max. flow capacity depends on $\Delta p$ demand of controlled loop, $\Delta p$ setting range 40-100 kPa







MBV: Manual Balancing Valves

Picture	Name	Description	Size (mm)	Kvs (m <sup>3</sup> /h)	Datasheet active link	Comments
	USV-I	Impulse tube connection, presetting, draining, measuring possibility, shut off function	15...50	1,6...16		Used with ASV-PV valve together mainly for flow limitation function
	USV-M	Return pipe mounting valve, shut off function with drain possibility, normal brass valve body, upgradeable for Δp controller with membrane kit	15...50	1,6...16		Upgradeable to differential pressure controller (for DN15- DN40)
	MSV-BD	Presetting, with test plug, DZR valve body, closing and drain function	15...50	2,5...40		Extra large Kvs valve, unidirectional construction, high accuracy rotary measuring station
	MSV-B	Presetting, with test plug, DZR valve body, closing function	15...50	2,5...40		Extra large Kvs valve, unidirectional construction, high accuracy
	MSV-O	Presetting, with test plug, DZR, valve body, closing function and fixed orifice	15...50	0,63...38		Extra large Kvs valve, high accuracy rotary measuring station
	MSV-S	Closing valve, DZR body	15...50	3...40		Extra large Kvs valve, shut off function, high draining capacity
	MSV-F2	Presetting, with test plug, GG-25 valve body, closing function	15...400	3,1...2585		PN 25 version is available
	PFM 1000	Measuring device for manual balancing valve and troubleshooting	-	-		Bluetooth communication via Danfoss smartphone app (iOS/Android)

MCV: Zone Valve, Motorised Control Valves

















Picture	Name	Description	Size (mm)	Kvs (m <sup>3</sup> /h)	Datasheet active link	Comments
	RA-HC	Presetting valve (14 sets) on zone control or self acting room temperature control with thermostatic head	15...25	2,8...5,5		Recommended application with central Δp controller
	VZL-2/3/4	Fan-coil valve on zone control with linear valve characteristic	15...20	0,25...3,5		Short stroke valve applicable with thermal or gear actuator
	VZ-2/3/4	Fan-coil valve on zone or 3-point, proportional control with logarithmic valve characteristic	15...20	0,25.....3,5 (A-AB) 0,25.....2,5 (B-AB)		Logarithmic stroke valve – accurate control













	AMZ 112/113	Zone controller ball valve with high kvs value	15...50 15...25	17...290, 3,8...11,6		With integrated gear actuator
	VRB-2/3	Traditional logarithmic-linear control valve	15...50	0,63...40		Internal and external thread connection, high control ratio, pressure relieved
	VF-2/3	Traditional logarithmic-linear control valve	15...150	0,63...320		High control ratio









## Actuators for MCV valves

Picture	Name	Description	usage with	control signal	Datasheet active link	Comments
	TWA-A TWA-ZL	Thermal actuator with 24V and 230V power supply, visual positioning indicator. Speed 30 s/mm	RA-N, RA-HC; VZL	on/off, (PWM)		Available both, NC and NO version, closing, force 90 N
	ABNM, ABNM-Z	Thermal actuator with 24V power supply, visual positioning indicator. Speed 30 s/mm	RA-N, RA-HC; VZL	0-10V		LOG or LIN stroke movement, only NC version is available closing force 100 N
	AMI 140	Gear actuator with 24V and 230V power supply, positioning indicator. Speed 12/24 s/mm	VZ; VZL	3-point, 0-10V		Closing force 200N, hand operation
	AMV/E-H 130, 140	Gear actuator with 24V and 230V power supply, hand operation. Speed 14/15 s/mm	VZ; VZL	3-point, 0-10V		Closing force 200 N, force switch-off at stem down position
	AMV/E 435	Gear push-pull actuator with 24V or 230V power supply. Speed 7/14 s/mm	VRB, VF	3-point, 0-10V		230V version only on 3-point actuator, built in antioscillation algorithm
	AMV/E 25 SD/SD	Gear push-pull actuator spring UP/DOWN with 24V and 230V power supply. Speed 11/15 s/mm	VRB, VF	3-point, 0-10V		Spring down: overheating protection, spring up: frost protection
	AMV/E 55/56	Gear push-pull actuator with 24V or 230V power supply. Speed 8/4 s/mm	VF	3-point, 0-10V		230V version only on 3-point actuator
	AMV/E 85/86	Gear push-pull actuator with 24V or 230V power supply. Speed 8/3 s/mm	VF	3-point, 0-10V		230V version only on 3-point actuator
	AMZ 112/113	2-point central heating actuator with 24V or 230V power supply. Speed 30 s/mm	AMZ	ON/OFF		90 rotation; AUX switch

Picture	Name	Description	size (mm)	Kvs (m <sup>3</sup> /h)	Datasheet active link	Comments
	RA-N	Presetting valve (14 sets) on zone control or self acting room temperature control with thermostatic head	10...25	0,65... 1,4		Recommended application with central Δp controller- Recommended application with central Δp controller
	RA-UN	Low Flow Presetting valve (14 sets) on zone control or self acting room temperature control with thermostatic head	10...20	0,57		Recommended application with central Δp controller
	RA-DV	Pressure Independent Presetting valve (14 sets) on zone control or self acting room temperature control with thermostatic head	10...20	Max flow 135 l/h		Recommended application with central Δp between 10-60 kPa Recommended application with central Δp between 10-60 kPa
	RA-G	High capacity valve for 1-pipe systems	10...25	2,3...4,58		Use Optimal 1 tool for best balancing results
	RA-FS	Special Bi-directional valve for UK market, where the spindle can be turned for opposite direction	15	0,73		RA-FS valves must only be used with RAS-C2 or RAS-D sensors. 15, 10 and 8 mm copper connections.
	RA-KE RA-KEW	Manifold assemblies for one pipe system	Radiator 15 system 20Radiator 15 system 20	2,5		Capacity of manifold assembly. Bypass through radiator: 35 %. Δp max = 30 - 35 kPa. Capacity of manifold assembly. Bypass through radiator: 35 %. Δp max = 30 - 35 kPa.
	RA-N	Integrated normal-flow built in valve wit 7 steps presetting	15, 20, M18, M22,	0,95		The integrated valve, type RA-N, is designed for incorporation into convectors from different radiator manufacturers
	RA-U	Integrated low-flow built in valve wit 7 steps presetting	15	0,74		The integrated valve, type RA-U, is designed for incorporation into convectors from different radiator manufacturers

	RLV-S	Standard lockshield valve, nickel-plated	10,15,20	1,5...2,2		To be placed at radiator return side. Presetting is possible to do at lockshield
	RLV	Lockshield Valve with drain-off feature	10,15,20	1,8...3		To be placed at radiator return side. Presetting is possible to do at lockshield
	RLV-K	Standard H-piece With drain-off feature, for 1 and 2-pipe systems	10...20	1,4		Presetting must be done at Built In Valve. Drain function at H-piece
	RLV-KS	Standard H-piece with shut-off. For radiators with Built In Valves	10...20	1,3		Presetting must be done at Built In Valve. Shut-off function at H-piece
	RLV-KDV	Dynamic H-piece valve, pressure independent. For radiators with Built In Valves	10...20	Max flow 159 l/h		Presetting must be done at Built In Valve. Drain function at H-piece



Sensors for TRV



Picture	Name	Description	Below type	Response time	Datasheet active link	Comments
	RA 2000	Click connection. Temp. range 7-28°C	Gas	With built in sensor=12 min. With remote sensor= 8 min.		Positive shut-off feature, Temperature limitation, Frost protection, Remote sensor available, Antitheft protection
	RA 2920	Tamperproof. For use in institutions etc. Temp. range 7-28°C	Gas	With built in sensor=12 min. With remote sensor= 8 min.		Temperature limitation, Frost protection, Version +16°C, Remote sensor available, Antitheft protection
	RAE	Click connection. White socket. Temp. range 8-28°C	Liquid	With built in sensor=22 min. With remote sensor= 18 min.		Positive shut-off feature, Temperature limitation, Frost protection, Version +16°C, Remote sensor available, Antitheft protection
	RAW	Click connection. White socket. Temp. range 8-28°C	Liquid	With built in sensor=22 min. With remote sensor= 18 min.		Positive shut-off feature, Temperature limitation, Frost protection, Version +16°C, Remote sensor available, Antitheft protection



DHWC: Domestic Hot Water Controllers



Picture	Name	Description	Size [mm]	Kvs (m3/h)	Function	Datasheet active link	Comments
	MTCV-A	Multifunctional thermostatic DHW circulation valve	15...20	1,5...1,8	Return temperature limitation		Temp. range 35-60°C, Valve body RG5, max. flow temperature 100°C
	MTCV-B	Multifunctional thermostatic DHW circulation valve with Self acting temperature disinfection module	15...20	1,5...1,8	Return temperature limitation and allow thermic disinfection		Built in by-pass for start of thermic disinfection process
	MTCV-C WITH CCR2+	Multifunctional thermostatic DHW circulation valve with disinfection process controller and temperature registration electronic, 24V DC power supply	15...20	1,5...1,8	Return temperature limitation, electronic control for disinfection		Programable disinfection process, data storage, TPC/IP, Wi-Fi, BMS
							
	TWA-A	Thermal actuator with 24V power supply, visual positioning indicator	-	-	ON/OFF control of disinfection		Available both, NC and NO version, closing force 90 N
	ESMB, ESM-11	Temperature sensors	-	-	Temperature registration, start disinfection		PT 1000, more different shape sensors are available
	TVM-W	Temperature mixing valve	20...25	2,1...3,3	Tapping temperature limitation		Built in temperature sensor, external thread
	TVM-H	Temperature mixing valve for heating application	20...25	1,9...3,0	Temperature mixing		Built in temperature sensor, external thread



## Additional equipment

Picture	Name	Description	Outlets (pcs)	Pmax (bar)	Datasheet active link	Comments
	FHF	Manifolds for water floor heating system, with individual shut-off on supply and with integrated Danfoss pre-setting valves on return	from 2+2 to 12+12	10 (without flowmeter) 16 (with flowmeter)		Airvent on end pieces; Flow T <sub>MAX</sub> - 900C;

Picture	Name	Description	Heat source	Datasheet active link	Comments
	EvoFlat	EvoFlat systems are compatible with virtually any kind of heat supply infrastructure, and are independent of the type of energy used.	Condensing boiler; Substation; Biomass; Heat pumps (all heating source)		DHW preparation; Independence on heat source;

Picture	Name	Description	Size (mm)	Kvs m <sup>3</sup> /h	Datasheet active link	Comments
	AVTA	Thermo-operated water valves used for proportional regulation of flow quantity, depending on the setting and the sensor temperature.	10-25	1,4 ... 5,5		Self acting; vMax Δp = 10 bar; Media temperature range: -25 – 130 °C Ethylene glycol up to 40%

Picture	Name	Description	Outlets [pcs] Size (mm)	Nominal flow (m <sup>3</sup> /h)	Datasheet active link	Comments
	Sono MeterS	ultrasonic, compact energy meters intended for measuring energy consumption in heating and cooling applications for billing purposes.	20 ... 100	0,6 ... 60		Temperature range 5 - 130 °C, PN 16 or 25 bar; IP65; M-Bus

Picture	Name	datasheet active link
	VLT®HVAC Drive FC102	

## Notes

## Notes

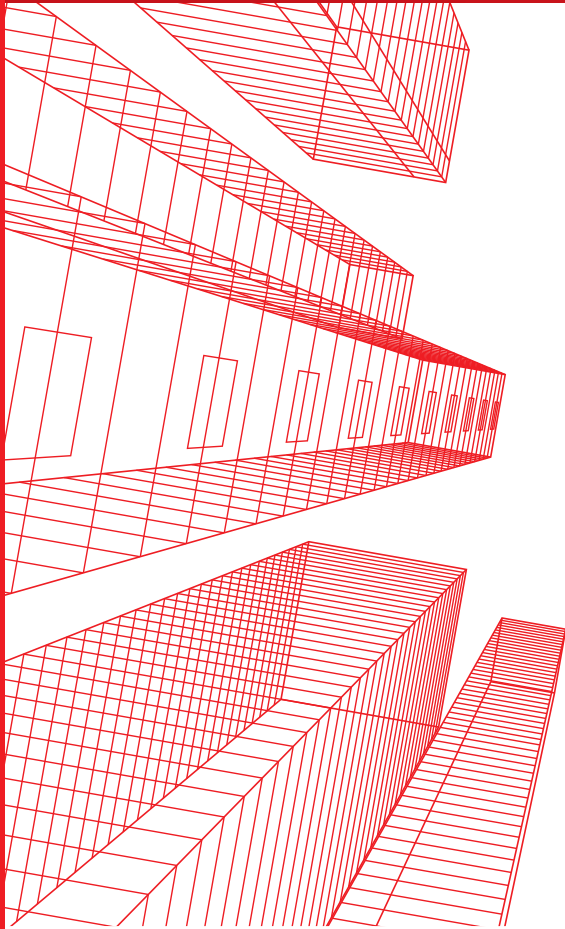

## Simplify your design work With Design Support Center

**Danfoss Design Support Center (DSC)  
offers full-service professional and  
personal support for HVAC designers.**

We help designers to specify projects with an optimal Danfoss solution from cost and energy efficiency aspects.

Type of Support	Explanation
ENERGY SAVING CALCULATION	calculation of energy saving potential on individual parts of the system (pumps, chillers etc..) or/and whole system
HYDRONIC ANALYSE	detailed hydronic calculations, pump head calculation, $\Delta p$ sensor allocation, pipe size analyses, domestic hot water system (circulation) calculation
ASSISTANCE	simple hydronic calculations and valve sizing, floor heating & flat station hydronic calculation
VERIFICATION	checking of sizing & appropriate usage of our equipment in designs

**Do you need our support? – please contact your local Danfoss Representative!**

**Danfoss A/S**

Heating Segment • [www.designcenter.danfoss.com](http://www.designcenter.danfoss.com) • +45 7488 2222 • E-Mail: [heating@danfoss.com](mailto:heating@danfoss.com)

Danfoss can accept no responsibility for possible errors in catalogues, brochures and other printed material. Danfoss reserves the right to alter its products without notice. This also applies to products already on order provided that such alterations can be made without subsequential changes being necessary in specifications already agreed. All trademarks in this material are property of the respective companies. Danfoss and all Danfoss logotypes are trademarks of Danfoss A/S. All rights reserved.