

## Data Sheet

# Programmable controller, 6 relays Type **MCX06D**

Electronic controller suitable for all HVAC/R software application needs.



MCX06D is fitted with graphic LCD display or without display. It is an electronic controller that holds all the typical functionalities of MCX controllers in the compact size of 4 DIN modules:







- programmability
- connection to the CANbus local network
- Modbus RS485 opto-insulated serial interface

**Features:**

- 4 analog and 8 digital inputs
- 3 analog and 6 digital outputs
- Power supply 20 / 60 V DC - 24 V AC
- Remote access to data through CANbus connection for additional display (LCD available) and keyboard
- RTC clock for managing weekly time programs and data logging information
- Modbus RS485 opto-insulated serial interface
- Available with graphic LCD display or without display for showing the desired information
- Dimensions 4 DIN modules

## Portfolio overview

Table 1: Portfolio overview

MCX family	MCX06C	MCX06D	MCX061V	MCX08M2	MCX152V	MCX15B2	MCX20B2
Product image							
Power supply	24 V	24 V	24 V or 110/230 V	24 V or 110/230 V	24 V or 110/230 V	24/110/230 V	24/110/230 V
Built-in display (optional)	LED	LCD	LCD	LCD	LCD	LCD	LCD
Analog Inputs	4	4	7	8	14	10	16
Digital Inputs	6	8	8	8	18	22	22
Analog Outputs	2	3	3	4	6	6	6
Digital Outputs	6	6	6	8	15	15	20
EXV driver embedded			1		2		
RS485	1	1	1	1	2	1	2
CANbus	•	•	•	•	•	•	•
Ethernet / Web server			optional		optional	•	•
USB/Memory Card			•		•	•	•
Dimensions (1 DIN module = 17,5 mm)	33 x 75 mm	4 DIN	8 DIN	8 DIN	16 DIN	16 DIN	16 DIN

## Product specification

### General features

**Table 2: General features**

Features	Description
Power supply	20 / 60 V DC and 24 V AC $\pm$ 15% 50/60 Hz SELV Maximum power consumption: 6 W, 9 VA Insulation between power supply and the extra-low voltage: functional
Plastic housing	DIN rail mounting complying with EN 60715 Self extinguishing V0 according to IEC 60695-11-10 and glowing / hot wire test at 960 °C according to IEC 60695-2-12
Ball test	125 °C according to IEC 60730-1 Leakage current: $\geq$ 250 V according to IEC 60112
Operating conditions	CE: -20T60 / UL: 0T55, 90% RH non-condensing
Storage conditions	-30T80, 90% RH non-condensing
Integration	In Class I and / or II appliances
Index of protection	IP40 only on the front cover
Period of electric stress across insulating parts	Long
Resistance to heat and fire	Category D
Immunity against voltage surges	Category II
Software class and structure	Class A

### Input/Output

**Table 3: Analog inputs**

Type	Num	Specifications
NTC 0 / 1 V 0 / 5 V	2	<b>AI1, AI2</b> Analog inputs selectable via software between: <ul style="list-style-type: none"> <li>• NTC temperature probes, default: 10 k<math>\Omega</math> at 25 °C</li> <li>• Pressure transducers with 0/5 V output</li> <li>• 0/5V type: impedance is 18 k<math>\Omega</math></li> </ul>
Universal	2	<b>AI3, AI4</b> Universal analog inputs selectable via software between: <ul style="list-style-type: none"> <li>• ON/OFF (current: 20 mA)</li> <li>• 0 / 1 V, 0 / 5 V, 0 / 10 V</li> <li>• 0 / 20 mA, 4 / 20 mA</li> <li>• NTC (10 k<math>\Omega</math> at 25 °C)</li> <li>• Pt1000</li> </ul> 12 V+ power supply 12 V DC, 50 mA max for 4 / 20 mA transmitter (total on all outputs) 5 V+ power supply 5 V DC, 80 mA max for 0 / 5 V transmitter (total on all outputs) 0/5V type: impedance is 18 k $\Omega$ 0/10V type: impedance is 2 k $\Omega$

**Table 4: Digital inputs**

Type	Num	Specifications
Voltage free contact	6	<b>DI1, DI2, DI3, DI4, DI5, DI6, DI7, DI8</b> Current consumption: 5 mA

Table 5: Analog outputs

Type	Num	Specifications
0 / 10 V PWM PPM	1	<p><b>AO1, AO2</b></p> <p>Analog outputs selectable via software between:</p> <ul style="list-style-type: none"> <li>pulsing output, synchronous with the line, at modulation of impulse position (PPM) or modulation of impulse width (PWM): <ul style="list-style-type: none"> <li>open circuit voltage: 6.8 V</li> <li>minimum load 1 k<math>\Omega</math> (10 mA)</li> </ul> </li> <li>pulsing output, at modulation of impulse width (PWM) with range 100 – 500 Hz: <ul style="list-style-type: none"> <li>open circuit voltage: 6.8 V</li> <li>minimum load 1 k<math>\Omega</math> (10 mA)</li> </ul> </li> <li>0 / 10 V DC non optoinsulated output, referred to the ground <ul style="list-style-type: none"> <li>minimum load 1 k<math>\Omega</math> (10 mA)</li> </ul> </li> </ul>
PWM PPM	1	<p><b>AO3</b></p> <p>Analog output selectable via software between:</p> <ul style="list-style-type: none"> <li>pulsing output, synchronous with the line, at modulation of impulse position (PPM) or modulation of impulse width (PWM): <ul style="list-style-type: none"> <li>open circuit voltage: 6.8 V</li> <li>minimum load 1 k<math>\Omega</math> (10 mA)</li> </ul> </li> <li>pulsing output, at modulation of impulse width (PWM) with range 100 – 500 Hz: <ul style="list-style-type: none"> <li>open circuit voltage: 6.8 V</li> <li>minimum load 1 k<math>\Omega</math> (10 mA)</li> </ul> </li> </ul>

Table 6: Digital outputs

Type	Num	Specifications
Relay	6	<p>Insulation between relays 1 to 5: functional</p> <p>Insulation between relay 6 and the other relays: reinforced</p> <p>Insulation between relays and the extra-low voltage parts: reinforced</p> <p>Total current load limit: 33 A</p> <p><b>C1-NO1, C2-NO2, C3-NO3, C4-NO4, C5-NO5</b></p> <p>Normally open contact relays 5 A</p> <p>Characteristics of each relay:</p> <ul style="list-style-type: none"> <li>5 A 30 V DC / 250 V AC for resistive loads - 100.000 cycles</li> <li>0.7 A 250 V AC for inductive load - 100.000 cycles with <math>\cos(\phi) = 0.5</math></li> <li>UL: 250 V AC - 3 A resistive - 1.5 FLA - 9.0 LRA - 144 V A pilot duty 30.000 cycles</li> </ul> <p><b>NC6-C6-NO6</b></p> <p>Changeover contacts relay 8 A</p> <p>Characteristics of each relay:</p> <ul style="list-style-type: none"> <li>8 A 250 V AC for resistive loads - 100.000 cycles</li> <li>4 A 250 V AC for inductive loads - 100.000 cycles with <math>\cos(\phi) = 0.6</math></li> <li>UL: 240 V AC - 6 A resistive - 4.9 FLA - 29.4 LRA - 470 V A pilot duty 30.000 cycles</li> </ul>

## Connection diagram

Figure 1: Connection diagram

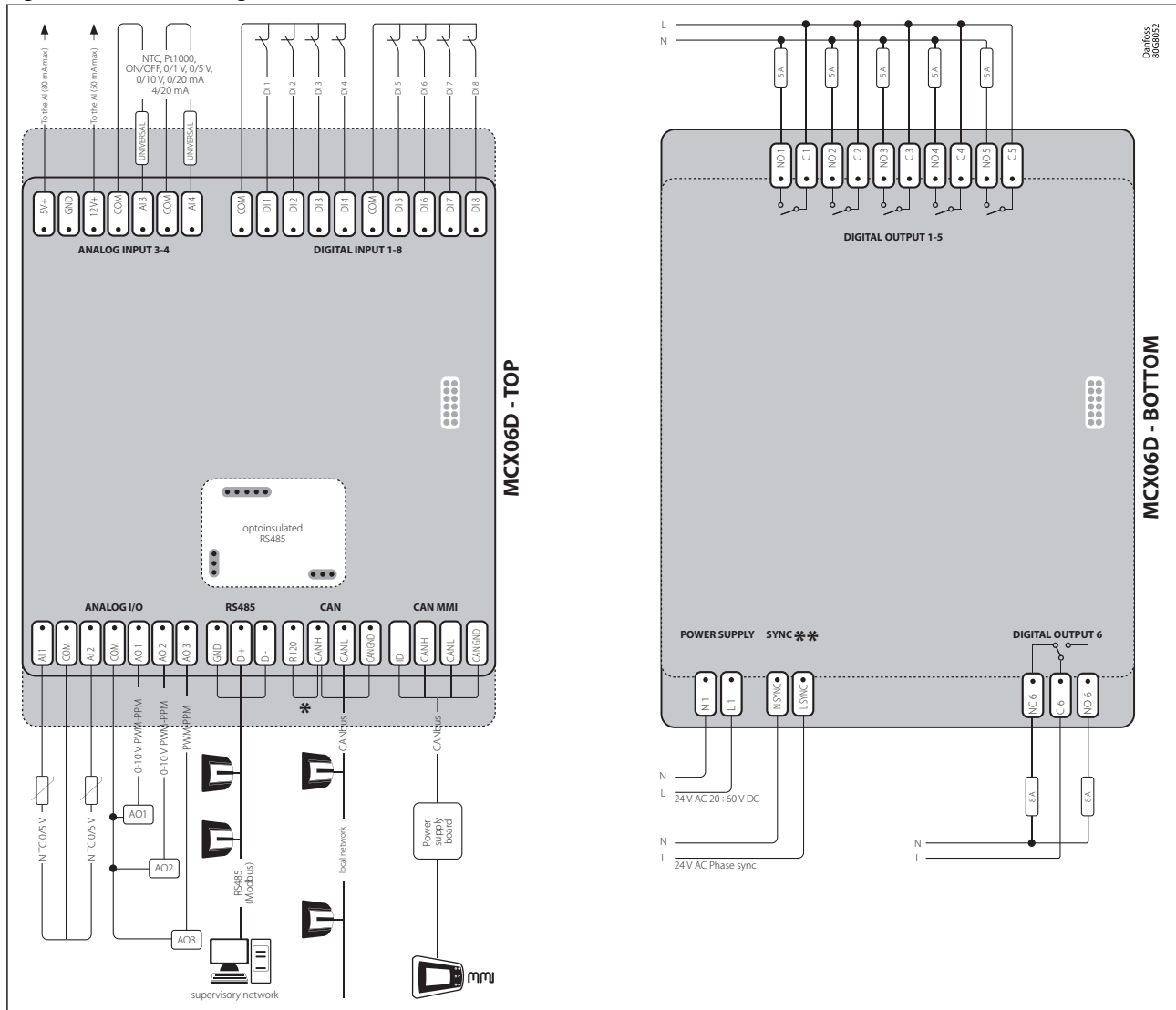

**NOTE:**

\*Connection has to be made on the first and last local network units, make the connection as close as possible to the connector.

\*\*When AO is used as synchronised output, the sync input must be in phase with the load on AO.

## Connection

Table 7: Top board

Connectors	Type	Dimensions
Analog input 3-4 connector	7 way screw plug-in connector type	<ul style="list-style-type: none"> <li>pitch 3.5 mm</li> <li>section cable 0.08 – 1.5 mm<sup>2</sup></li> </ul>
Digital input 1-8 connector	10 way screw plug-in connector type	<ul style="list-style-type: none"> <li>pitch 3.5 mm</li> <li>section cable 0.08 – 1.5 mm<sup>2</sup></li> </ul>
Analog I/O connector	7 way screw plug-in connector type	<ul style="list-style-type: none"> <li>pitch 3.5 mm</li> <li>section cable 0.08 – 1.5 mm<sup>2</sup></li> </ul>

## Programmable controller, 6 relays, type MCX06D

Connectors	Type	Dimensions
RS485 connector	3 way screw plug-in connector type	<ul style="list-style-type: none"> <li>pitch 3.5 mm</li> <li>section cable 0.08 – 1.5 mm<sup>2</sup></li> </ul>
CAN connector	4 way screw plug-in connector type	<ul style="list-style-type: none"> <li>pitch 3.5 mm</li> <li>section cable 0.08 – 1.5 mm<sup>2</sup></li> </ul>
CAN MMI connector	4 way Connection 2515 Series type (2515-2041) crimping contact type: Connection (2500-2001) instrument for the crimp type 1190-1298	<ul style="list-style-type: none"> <li>section cable AWG22-28 (0.32 – 0.08 mm<sup>2</sup>)</li> </ul>

**Table 8: Bottom board**

Connectors	Type	Dimensions
Digital output 1-5 connector	10 way screw plug-in connector type	<ul style="list-style-type: none"> <li>pitch 5 mm</li> <li>section cable 0.2 – 2.5 mm<sup>2</sup></li> </ul>
Power supply connector	2 way screw plug-in connector type	<ul style="list-style-type: none"> <li>pitch 3.5 mm</li> <li>section cable 0.08 – 1.5 mm<sup>2</sup></li> </ul>
Sync connector	2 way screw plug-in connector type	<ul style="list-style-type: none"> <li>pitch 3.5 mm</li> <li>section cable 0.08 – 1.5 mm<sup>2</sup></li> </ul>
Digital output 6 connector	3 way screw plug-in connector type	<ul style="list-style-type: none"> <li>pitch 5 mm</li> <li>section cable 0.2 – 2.5 mm<sup>2</sup></li> </ul>

## Dimensions

**Figure 2: Dimensions**

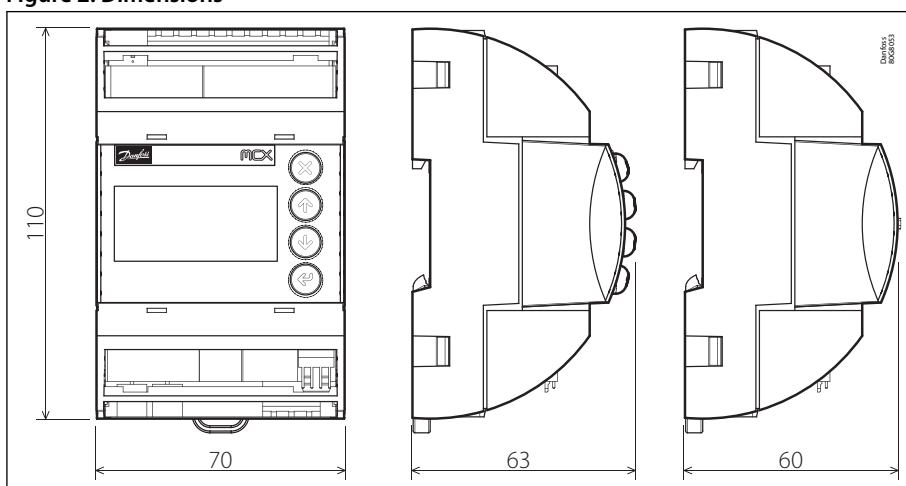

## User interface

**Table 9: User interface**

Type	Features	Description
LCD display	Display	STN blue transmissive
	Backlight	White LED backlight adjustable via software
	Contrast	Adjustable via software
	Format	98 x 64 dots
	Active visible area	29.4 x 19.2 mm
Keyboard	Number of keys	4
	Keys function	Set by the application software

## Ordering

### Product part numbers

Table 10: Product part numbers

Description	Code No.
MCX06D, 24 V, LCD, S	080G0111
MCX06D, 24 V, LCD, RS485, RTC, S	080G0112
MCX06D, 24 V, RS485, RTC, S	080G0115
MCX06D, 24 V, LCD, I (32 pieces)	080G0166
MCX06D, 24 V, LCD, RS485, RTC, I (32 pieces)	080G0167
MCX06D, 24 V, RS485, RTC, I (32 pieces)	080G0169

#### **i** NOTE:

Single pack codes (S) include standard kit connectors, industrial pack codes (I) don't include standard kit connectors.

### Accessories part numbers

Table 11: Accessories part numbers

Description	Code No.
MCX06D/EXC06D Connectors Kit	080G0179

## Certificates, declarations, and approvals

The list contains all certificates, declarations, and approvals for this product type. Individual code number may have some or all of these approvals, and certain local approvals may not appear on the list.

Some approvals may change over time. You can check the most current status at danfoss.com or contact your local Danfoss representative if you have any questions.

Table 12: Certificates, declarations, and approvals

File name	Document type	Document topic	Approval authority
080R1224.01	EU Declaration of conformity	<b>EMC directive 2014/30/EU:</b> EN61000-6-4: 2007 +A1:2011 EN61000-6-2: 2005 <b>LVD directive 2014/35/EU:</b> EN60730-1: 2011 EN60730-2-9: 2010 <b>RoHS directive 2011/65/EU and 2015/863/EU:</b> EN 50581: 2012	Danfoss
UL E31024	Electrical - Safety Certificate	-	UL

## Online support

Danfoss offers a wide range of support along with our products, including digital product information, software, mobile apps, and expert guidance. See the possibilities below.

### The Danfoss Product Store



The Danfoss Product Store is your one-stop shop for everything product related—no matter where you are in the world or what area of the cooling industry you work in. Get quick access to essential information like product specs, code numbers, technical documentation, certifications, accessories, and more.

Start browsing at [store.danfoss.com](https://store.danfoss.com).

### Find technical documentation



Find the technical documentation you need to get your project up and running. Get direct access to our official collection of data sheets, certificates and declarations, manuals and guides, 3D models and drawings, case stories, brochures, and much more.

Start searching now at [www.danfoss.com/en/service-and-support/documentation](https://www.danfoss.com/en/service-and-support/documentation).

### Danfoss Learning



Danfoss Learning is a free online learning platform. It features courses and materials specifically designed to help engineers, installers, service technicians, and wholesalers better understand the products, applications, industry topics, and trends that will help you do your job better.

Create your Danfoss Learning account for free at [www.danfoss.com/en/service-and-support/learning](https://www.danfoss.com/en/service-and-support/learning).

### Get local information and support



Local Danfoss websites are the main sources for help and information about our company and products. Find product availability, get the latest regional news, or connect with a nearby expert—all in your own language.

Find your local Danfoss website here: [www.danfoss.com/en/choose-region](https://www.danfoss.com/en/choose-region).