

Selection Guide | VLT® DriveMotor FCP 106 | 0.55 - 7.5 kW

VLT® DriveMotor FCP 106
delivers **space-saving efficiency**
to your choice of motor



Built-in DC Choke

reduces THDi to less than 46%. This results in extended drive lifetime and minimized harmonic load of mains.

Full flexibility.

For full flexibility in motor choice, system design and energy efficiency, choose your own induction motor (IM) or permanent magnet motor (PM) and attach the standalone VLT® DriveMotor FCP 106.

Easy to install

Installation is simple due to the integrated cooling system and an individually adjustable motor adapter plate.

Alternatively, mount the VLT® DriveMotor FCP 106 close to the motor using the wall mount adapter plate.

Premium efficiency

Built-in features for smooth and efficient pump, fan and conveyor operation make this drive easy to integrate and commission for these dedicated applications.

Cost savings

The need for cabinets and long motor cables are eliminated enabling you to save costs however your system design looks.



VLT® DriveMotor FCP 106



Higher reliability, lower costs

The VLT® DriveMotor FCP 106 has many features that increase its lifetime and reliable operation while saving installation and maintenance costs.

Flexible installation

With integrated cooling and an individually adjustable motor adapter plate, you can simply choose your preferred motor type and easily attach the FCP 106 to make it a compact DriveMotor packaged solution.

Reliable operation

VLT® DriveMotor FCP 106 operates reliably in wet, dirty and corrosive environments due to the IP66/Type 4X Outdoor enclosure and PCB protection.

Drive lifetime is extended and harmonic load on the mains is minimized thanks to the built-in DC choke which reduces THDi to less than 46%.

Drive lifetime is further extended thanks to the sleep mode, which also helps save energy.

Automatic Motor Adaptation

The standalone VLT® DriveMotor FCP 106 provides customers with a high level of flexibility, as the drive automatically sets the optimal parameters for the attached motor, providing stable, energy-efficient operation.

Service friendly

The VLT® Memory Module MCM 101 facilitates helpful implementation of factory settings for OEM and machine builders, speeds up commissioning and simplifies drive updates. Simply use your PC to copy the drive settings from one VLT® Memory Module to another.

Insert VLT® Memory Module MCM 101 into the Memory Module Programmer for easy transfer of settings.



Maximize system efficiency with EC+

Optimize PM motor performance

To make it possible for users to benefit from the high motor efficiency on the same level or above EC technology, Danfoss has refined its VVC+ control algorithm and optimized it for permanent magnet motors. After entering the relevant motor data, the drive automatically optimizes the performance of the application.

Free choice of technology

The EC+ concept allows manufacturers to choose their preferred motor, fan/pump from any supplier, as the same Danfoss VLT drive is equally efficient at controlling IM or PM motors.

By providing vendors with the freedom to choose the optimal combination of drive, motor and fan/pump it is possible to achieve the best possible system efficiency. This is a clear advantage compared to integrated systems, where it often is not possible to optimize the individual components.

Easy maintenance

Component replacement as a result of wear and tear is not always possible without installing a complete new, integrated system. The EC+ concept answers this by making service and maintenance easier, as only the affected component needs to be repaired/replaced in the event of malfunction.

Downtime is therefore reduced to a minimum, as are maintenance costs due to the fact that the EC+ concept is based on standardized components, which can be shipped at short notice and installed with little effort.

You can read more about Danfoss EC+ by scanning QR code or clicking EC+ logo (iPaper only)





**Constant
Torque**
at 160% overload in
industrial applica-
tions, e.g. conveyors

Industrial features

Built-in Smart Logic Controller

The Smart Logic Controller is a simple but clever way to keep your drive, motor and application working together without a PLC. The controller monitors a specified event. When an event occurs, the controller triggers a specified act and starts monitoring the next event, continuing for up to 20 steps before returning to step one.

Motor thermistor

If increased temperature monitoring of the motor is required, the motor thermistor can be monitored by connecting a thermistor input to the drive. This secures that the motor temperature does not exceed the specified temperature rating.

AC brake

Instead of a brake resistor the drive can ramp down induction motors by absorbing the energy.

Control a mechanical brake via a signal

The drive can provide an output signal for an externally mounted mechanical brake.

Technical overview

- Control IM and PM motors with the same drive
- Mount directly onto, or nearby, the motor
- Motor sizes 0.55 – 7.5 kW
- Enclosure with IP66 / UL Type 4X Outdoor protection
- VLT® Motion Control Tool MCT 10 for easy setup
- Embedded fieldbus via RS485: Modbus RTU, BACnet, FC Protocol
- PROFIBUS DP V1 (optional)

Cost-reducing advantages

- Eliminate cabinets for the drive
- Save motor cable costs
- Energy-efficient operation
- Automatic Motor Adaptation

Fan features

With basic air handling unit functions, the VLT® DriveMotor FCP 106 ensures safe and low noise operation and increases equipment reliability.

Belt monitoring

Based on the speed/current the drive can detect situations where the motor has lost contact with the fan and raise an alarm.

Flying start

This protective feature prevents violent starts and wear and tear on the equipment. By detecting the speed and direction of a freely spinning fan the drive can catch it at the correct frequency.

Resonance monitoring

Using only a few keystrokes on the local control panel (accessory) or via

VLT® Motion Control Tool MCT 10, the drive can be set to avoid frequency bands at which connected fans create resonances in the ventilation system. This reduces vibration, noise and equipment wear.

Fire override mode

This setting prevents the drive from stopping to protect itself and ensures that vital fan operation is maintained for as long as possible, regardless of control signals, warnings or alarms.

Stairwell pressurization

In the event of a fire, the FCP 106 can maintain a higher level of air pressure in stairwells than in other parts of the building. This helps ensure that fire escapes remain free of smoke.

Pump features

Sensorless Pump Control

The pump curve describes relations between frequency, flow, head and power. Measured or taken from the pump data sheet and loaded to drive, head or flow are controlled without using sensors. This saves costs for sensors and maintenance while increasing reliability.

Sleep mode

Sleep Mode keeps pump wear and power consumption to an absolute minimum. In low flow situations, the VLT® DriveMotor will ramp up the pump to boost the system pressure

and then stop. Monitoring the pressure, the VLT® DriveMotor will restart when the pressure falls below the required level.

Flow compensation

A pressure sensor mounted close to the fan or pump provides a reference point that enables pressure to be kept constant at the discharge end of the system. The drive constantly adjusts the pressure reference to follow the system curve. This method both saves energy and reduces installation costs.

Sleep mode

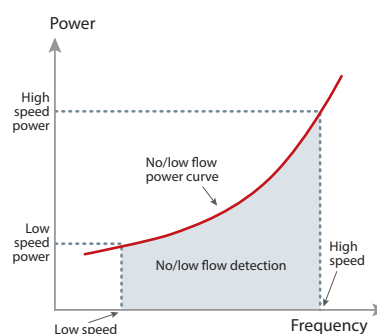

End of curve

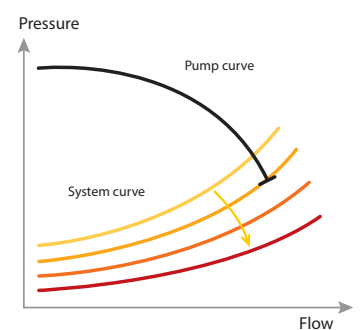

VLT® DriveMotor FCP 106

Dry Run Detection

Dry Run Detection helps protect the pump from cavitation. The VLT® DriveMotor constantly evaluates the condition of the pump based on internal frequency/power measurements. In case of too low power consumption -- indicating a no-or low-flow condition -- the VLT® DriveMotor will stop the pump.

End of Curve

This feature detects pipe breakage and high leakages to protect the pump from cavitation damages and reduce water losses. End-of-Curve triggers an alarm, shuts off the pump and performs other programmed actions whenever the pump is found running at full speed without creating the desired pressure.

Check valve ramp

This feature protects the check valve and helps prevent water hammering. When the pump ramps to stop, Check Valve Ramp slows down the ramp and closes the check valve softly. When the check valve is closed, the final ramp brings the pump to a fast stop to prevent pump cavitation.

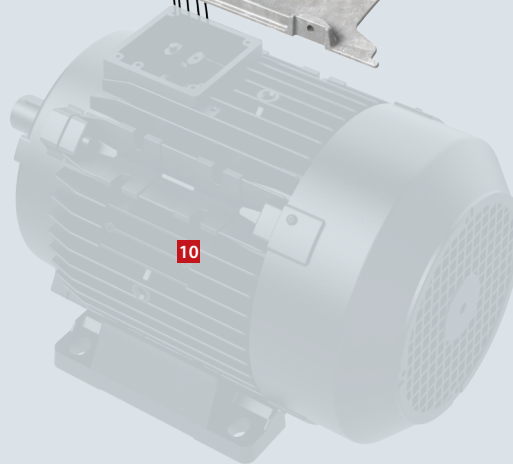
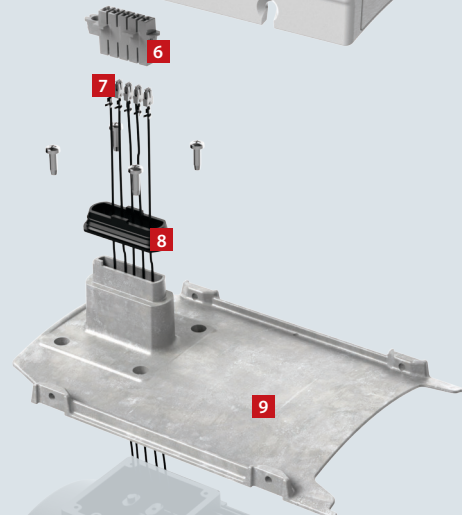

- 1 VLT® DriveMotor FCP 106 drive unit
- 2 Status LEDs for easy monitoring
- 3 Removable fan
- 4 LCP connector
- 5 Mains and Controls
- 6 Motor plug
- 7 Motor terminal contacts
- 8 Motor connector gasket
- 9 Motor adapter plate
- 10 Motor (not included in delivery)

Check Valve Ramp

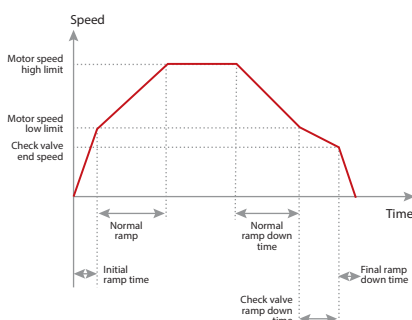

Local Control Panel

Connect the VLT® Control Panel LCP 102 for programming, commissioning and monitoring.



Removable fan

The built-in fan can be removed for easy access for cleaning or maintenance.

Connection examples

The numbers represent the terminals on the drive.

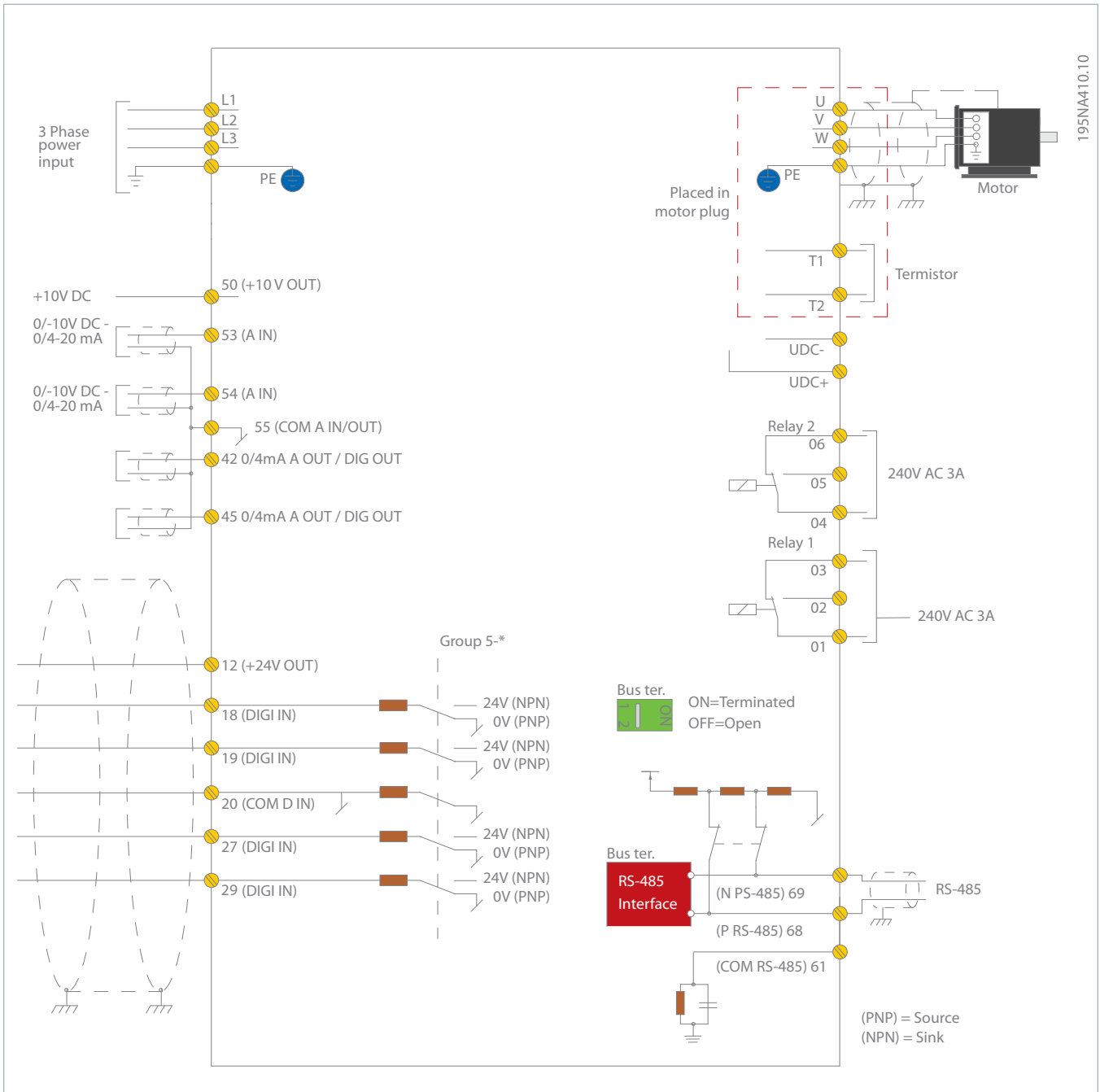

The diagram shows the terminals of the VLT® DriveMotor FCP 106.

Users can set the mode of the analog inputs 53 and 54. The FCP 106 has an RS485 interface as standard.

The RS485 terminations are integrated in the drive (S801). The drive can be equipped with a PROFIBUS option if necessary. To switch from NPN to PNP logic for the digital signals, use parameter Group 5-*

Electric data and dimensions

VLT® DriveMotor FCP 106

Mains Supply 3 x 380 – 480 VAC

Enclosure	IP66		MH1				MH2							
			NK75		N1K1		N1K5		N2K2		N3K0		N4K0	
	NO	HO	NO	HO	NO	HO	NO	HO	NO	HO	NO	HO	NO	HO
Typical Shaft Output [kW]	0.55		0.75		1.1		1.5		2.2		3.0		4.0	
Typical Shaft Output [HP] at 460 V	0.75		1.0		1.5		2.0		3.0		4.0		5.0	
Output current														
Continuous (3 x 380-440 V) [A]	1.7		2.2		3.0		3.7		5.3		7.2		9.0	
Intermittent (3 x 380-440 V) [A]	1.9	2.7	2.4	3.5	3.3	4.8	4.1	5.9	5.8	8.5	7.9	11.5	9.9	
Continuous (3 x 441-480 V) [A]	1.6		2.1		2.8		3.4		4.8		6.3		8.2	
Intermittent (3 x 441-480 V) [A]	1.8	2.6	2.3	3.4	3.1	4.5	3.7	5.4	5.3	7.7	6.9	10.1	9.0	
Max. cable cross-section in terminals (mains, motor) [mm ² / AWG]	4/10													
Max. input current														
Continuous (3 x 380-440 V) [A]	1.3		2.1		2.4		3.5		4.7		6.3		8.3	
Intermittent (3 x 380-440 V) [A]	1.4	2.0	2.3	2.6	2.6	3.7	3.9	4.6	5.2	7.0	6.9	9.6	9.1	
Continuous (3 x 441-480 V) [A]	1.2		1.8		2.2		2.9		3.9		5.3		6.8	
Intermittent (3 x 441-480 V) [A]	1.3	1.9	2.0	2.5	2.4	3.5	3.2	4.2	4.3	6.3	5.8	8.4	7.5	

Enclosure	IP66		MH3		
			N5K5		H7K5
	HO	NO	HO	NO	HO
Typical Shaft Output [kW]	4.0		5.5		7.5
Typical Shaft Output [HP] at 460 V	5.0		7.5		10
Output current					
Continuous (3 x 380-440 V) [A]	9.0		12		15.5
Intermittent (3 x 380-440 V) [A]	14.4	13.2	19.2	17.1	23.3
Continuous (3 x 441-480 V) [A]	8.2		11		14
Intermittent (3 x 441-480 V) [A]	17.6	12.1	22.4	15.4	21
Max. cable cross-section in terminals (mains, motor) [mm ² / AWG]	4/10				
Max. input current					
Continuous (3 x 380-440 V) [A]	8.3		11		15
Intermittent (3 x 380-440 V) [A]	12	12	17	17	23
Continuous (3 x 441-480 V) [A]	6.8		9.4		13
Intermittent (3 x 441-480 V) [A]	11	10	15	14	20

NO: Normal overload 110% for 60s
HO: High overload 160% for 60s

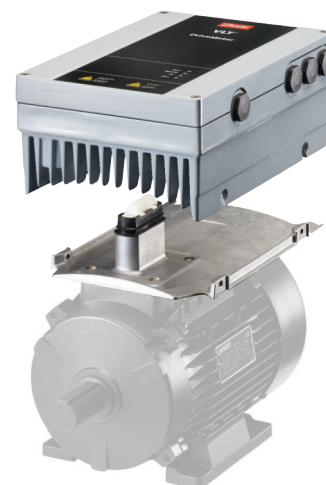

IEC standard motor frame sizes

PM 1500 rpm	PM 3000 rpm	IM 3000 rpm	IM 1500 rpm	Power kW (HP)	MH frame size	Length (A)	Width (B)	Height (C)
						mm (in)		
71	NA	NA	NA	0.55 (0.75)	MH1	231 (9.1)	162 (6.4)	107 (4.2)
71	71	71	80	0.75 (1.0)				
71	71	80	90	1.1 (1.5)				
71	71	80	90	1.5 (2.0)				
90	71	90	100	2.2 (3.0)	MH2	277 (10.9)	187 (7.4)	113 (4.5)
90	90	90	100	3 (4.0)				
90	90	100	112	4 (5.0)				
112	90	112	112	5.5 (7.5)	MH3	322 (12.7)	221 (8.7)	124 (4.8)
112	112	112	132	7.5 (10)				

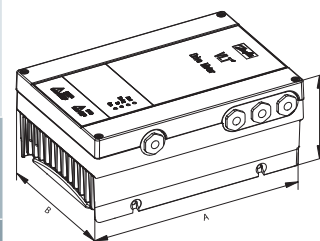

Ordering type code

VLT® DriveMotor FCP 106

Position	1	2	3	4	5	6	7	8	9	10	11	12	13	14	15	16	17	18	19	20	21	22	23	24	
Fixed	F	C	P	1	0	6					T	4	C	6	6	H	1	F	S	X	X				
Variants							N	K	5	5												A	X	O	
							N	K	7	5												A	O	O	
							N	1	K	1															
							N	1	K	5															
							N	2	K	2															
							N	3	K	0															
							N	4	K	0															
							N	5	K	5															
							N	7	K	5															
							H	7	K	5															

[01-03] Product group	FCP	VLT® DriveMotor FCP 106
[04-06] Frequency converter series	106	VLT® DriveMotor
[07-10] Power size	NK55	0.55 kW / 0.75 HP
	NK75	0.75 kW / 1.0 HP
	N1K1	1.1 kW / 1.5 HP
	N1K5	1.5 kW / 2.0 HP
	N2K2	2.2 kW / 3.0 HP
	N3K0	3.0 kW / 4.0 HP
	N4K0	4.0 kW / 5.0 HP
	N5K5	5.5 kW / 7.5 HP
	N7K5	7.5 kW / 10 HP
	H7K5	7.5 kW / 10 HP
[11-12] Mains voltage	T	Three phase
	4	380 – 480 V
[13-15] Enclosure	C66	IP66 – FCP 106
[16-17] RFI filter	H1	Integrated RFI filter C1
[18] Fan	F	Cooling fan
[19-21] Software	SXX	Standard software
[22-23] Options	AX	No option
	AO	PROFIBUS DP V1
[24] Memory module	O	Memory module

Specifications

Mains supply (L1, L2, L3)	
Supply voltage	380 – 480 V ±10%
Supply frequency	50/60 Hz
True Power Factor (λ)	≥ 0.9 nominal at rated load
Displacement Power Factor (cos φ)	(>0.98)
Switching on input supply	Max. 2 times/min.

Output data (U, V, W)	
Output voltage	0 – 100% of supply
Output frequency	0– 200 Hz (IM motor) 0 – 390 Hz (PM motor)
Switching on output	Unlimited
Ramp times	0.01 – 3600 sec.

Digital inputs	
Programmable digital inputs	4
Logic	PNP or NPN
Voltage level	0 – 24 V DC

Note: Two analog outputs can be programmed as digital outputs

Analog inputs	
Number of analog inputs	2
Modes	Voltage or current
Voltage level	0 – 10 V
Current level	0/4 – 20 mA (scalable)

Pulse inputs	
Programmable pulse inputs	2
Voltage level	0 – 24 V DC (PNP positive logic)

Digital output	
Programmable digital outputs	2
Voltage level at digital output	17 V

Analog output	
Programmable analog outputs	2
Current range	0/4 – 20 mA

Relay outputs	
Programmable relay outputs	2

Fieldbus	
Embedded via RS485	Modbus RTU BACnet FC Protocol
Optional	PROFIBUS DP V1

Accessories

- **VLT® Control Panel LCP 102 (Graphical LCP only)**
Ordering number: 130B1107
- **Remote Mounting Kit (LCP 102)**
3 m cable, panel mounting bracket, gasket and fastners
Ordering number: 134B0564
- **Local Operation Pad LOP**
Panel for start/stop and setting the reference
Ordering number: 175N0128
- **Potentiometer for cable gland**
Ordering number: 177N0011
- **Motor Adapter Plate FCP 106**
MH1 – Ordering number: 134B0340
MH2 – Ordering number: 134B0390
MH3 – Ordering number: 134B0440
- **Wall Mounting Plate FCP 106**
MH1 – Ordering number: 134B0341
MH2 – Ordering number: 134B0391
MH3 – Ordering number: 134B0441
- **Crimp terminals for mounting FCP on motor**
Crimp terminals
0.2 – 0.5 mm², 25 pcs.
Ordering number: 134B0495
Crimp terminals
0.5 – 1.0 mm², 25 pcs.
Ordering number: 134B0496
Crimp terminals
1.0 – 2.5 mm², 25 pcs.
Ordering number: 134B0497
Crimp terminals
2.5 – 4.0 mm², 25 pcs.
Ordering number: 134B0498
Crimp terminals
4.0 – 6.0 mm², 25 pcs.
Ordering number: 134B0499
- **VLT® Memory Module MCM 101**
Ordering number: 134B0791
- **Memory Module Programmer**
Ordering number: 134B0792



Danfoss Drives

Danfoss Drives is a world leader in variable speed control of electric motors. We aim to prove to you that a better tomorrow is driven by drives. It is as simple and as ambitious as that.

We offer you unparalleled competitive edge through quality, application-optimized products targeting your needs – and a comprehensive range of product lifecycle services.

You can rely on us to share your goals. Striving for the best possible performance in your applications is our focus. We achieve this by providing the innovative products and application know-how required to optimize efficiency, enhance usability, and reduce complexity.

From supplying individual drive components to planning and delivering complete drive systems; our experts are ready to support you all the way.

We draw on decades of experience within industries that include:

- Chemical
- Cranes and Hoists
- Food and Beverage
- HVAC
- Lifts and Escalators
- Marine and Offshore
- Material Handling
- Mining and Minerals
- Oil and Gas
- Packaging
- Pulp and Paper
- Refrigeration
- Water and Wastewater
- Wind

You will find it easy to do business with us. Online, and locally in more than 50 countries, our experts are never far away, reacting fast when you need them.

Since 1968, we have been pioneers in the drives business. In 2014, Vacon and Danfoss merged, forming one of the largest companies in the industry. Our AC drives can adapt to any motor technology and we supply products in a power range from 0.18 kW to 5.3 MW.