

Data sheet

Combined automatic balancing valve

AB-PM – valve DN 10-32, PN 16

Description



AB-PM is a combined automatic balancing valve. It features three function in compact valve body:

1. Differential pressure controller
2. Control valve with linear characteristic
3. Flow limiter

Benefits:

- Reliable heating system resulting in:
 - proper heat distribution even at partial loads
 - noise free operation based on stable low Δp over thermostatic radiator valves even in installation where higher pump head is needed
- Lower heating cost
- Better indoor temperature control
- Faster in simpler installation with less installation space needed

Ordering

AB-PM valve (including 1.5 m impulse tube and imp. tube adapter)

Picture	DN	Ext. thread (ISO 228/1)	Code No.
	10	G 1/2 A	003Z1401
	10 HP		003Z1411
	15	G 3/4 A	003Z1402
	15 HP		003Z1412
	20	G 1 A	003Z1403
	20 HP		003Z1413
	25	G 1 1/4 A	003Z1404
	25 HP		003Z1414
	32	G 1 1/2 A	003Z1405
	32 HP		003Z1415

Actuator

Type	Power supply	Cable length	Code No.
TWA-Q NO	24 V AC	1.2 m	082F1603
	230 V AC		082F1601
TWA-Q NC	24 V AC	1.2 m	082F1602
	230 V AC		082F1600

Accessories

Type	To pipe	To valve	Code No.
Tailpiece threaded (1 pcs.)	R 3/8	DN 10	003Z0231
	R 1/2	DN 15	003Z0232
	R 3/4	DN 20	003Z0233
	R 1	DN 25	003Z0234
Tailpiece welding (1 pcs.)	R 1 1/4	DN 32	003Z0235
		DN 15	003Z0226
		DN 20	003Z0227
		DN 25	003Z0228
Tailpiece for soldering (2 nuts, 2 gaskets, 2 soldering plugs)		DN 32	065Z7016
		DN 15	065Z7017
Stroke limiter - TWA (5 pcs. in a bag) ¹⁾			003Z1237

¹⁾ Stroke limiter ensures min. 5% opening of AB-PM when TWA-Q is closed.

Spare parts

Type	Remark	Code No.
Impulse tube adapter	3/8" - 1/16"	003L5042
	3/4" - 1/16"	003Z0109
	1/4" - 1/16"	003L8151
Impulse tube with O-rings	1.5 m	003L8152
	2.5 m	003Z0690
Shut-off knob (red)		003Z0250

AB-PM connection set ¹⁾

Type	Connection to heating system	Connection to heating distributor	Code No.	
			Standard	High pressure
AB-PM DN 15 Heat meter connection set vert.	Internal G 3/4	External G 1	003Z1470	003Z1471
AB-PM DN 20 Heat meter connection set vert.	Internal G 3/4		003Z1472	003Z1473
AB-PM DN 25 Heat meter connection set vert.	Internal G 1		003Z1474	003Z1475
AB-PM DN 15 Heat meter connection set horz.	Internal G 3/4		003Z1476	003Z1477
AB-PM DN 20 Heat meter connection set horz.	Internal G 3/4		003Z1478	003Z1479
AB-PM DN 25 Heat meter connection set horz.	Internal G 1		003Z1480	003Z1481

¹⁾ On-site assembly set

Ordering (continuous)

AB-PM connection set ²⁾

Type	Connection to heating system	Connection to heating distributor	Code No.	
			Standard	High pressure
AB-PM DN 15 Heat meter connection rack	IG ¾"	IG ¾"	003Z1490	003Z1492
AB-PM DN 20 Heat meter connection rack	IG ¾"		003Z1491	003Z1493

Accessories

Type	Size	Comment	Code No.
Connection threaded to under floor heating distributor (set of 2 connections)	1"	IG (Internal)	003Z3191
	1"	AG (External)	003Z3192
Replacement piece heat meter (steel)	¾"	110 mm	003Z1468
	1"	130 mm	003Z1469

²⁾ Pre-assembled and pressure tested

Technical data

Nominal diameter		DN	10	10 HP	15	15 HP	20	20 HP	25	25 HP	32	32 HP	
Q _{nom} (at 100% setting)		l/h	110		300		600		1200		2300		
Max. pressure at zero load		kPa	22	35	22	35	22	35	22	35	22	35	
Max. differential pressure (Δp _s)			400										
Min. differential pressure (Δp _s)			18	28	18	28	18	28	18	28	18	28	
Nominal maximal pressure		bar	16 (PN16)										
Control valves characteristic		Linear											
Shut-off leakage rate		Acc. to ISO 5208 class A - no visible leakage											
Medium temperature		°C	-10 ... +120										
CV stroke		mm	2.25					4.5					
Connection	Ext. thread ISO 228/1	G ½ A		G ¾ A		G 1 A		G 1¼ A		G 1½ A			
	Actuator	M 30 x 1.5											
Materials in water													
Valve body		DZR Brass (CuZn36Pb2As - CW 602N)											
Membrane and O-ring		EPDM											
Spring		W.Nr. 1.4568, W.Nr. 1.4310											
Cone (PC)		W.Nr. 1.4305											
Seat (PC)		EPDM											
Cone (CV)		CuZn40Pb3 - CW 614N											
Seat (CV)		DZR Brass (CuZn36Pb2As - CW 602N)											
Flat gasket		NBR											
Screw		Stainless Steel (A2)											
Sealing agent		Dimethacrylate Ester											
Materials out of the water													
Plastic parts		PA											
Insert parts and outer screws		CuZn39Pb3 - CW 614N; W.Nr. 1.4310; W.Nr. 1.4401											
Material connection sets													
Ball valve		Brass (CW614N)											
Pipe		Plastics											
Gasket		PTFE											
Sealing agent: Connection		AFM34											

Mounting

AB-PM should be mounted in flow in the direction of the arrow on the valve body. The impulse tube should be installed between AB-PM and ¼" - ⅜" adapter that is supplied together with AB-PM.

Alternatively, impulse tube can be connected to ASV partner valve, such as ASV-BD. With it, additional service functions such as flow verification, shut-off, etc are available.

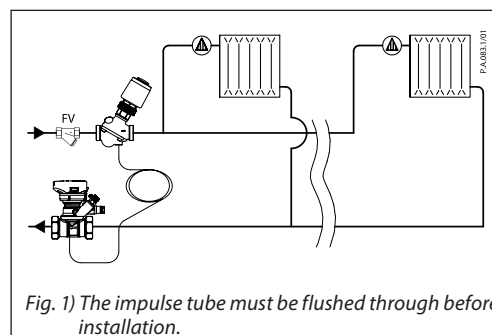

Applications

AB-PM is designed to be used in heating residential application. It can be used both in radiator or floor heating systems. The AB-PM offers 3 functions in one valve, and with its small valve body it is ideal for small spaces such as manifold cabinets etc.

The AB-PM HP high pressure version is designed to fit the higher requirement of Δp in larger floor heating installations.

AB-PM is focused to systems with horizontal piping loops and individual flat connections: AB-PM provides proper balance even at partial loads and limitation of maximal flow is simple and fast. In addition, programmable zone control (night setback or holiday mode) is available by using On/Off actuator, connected to a room controller ¹⁾.

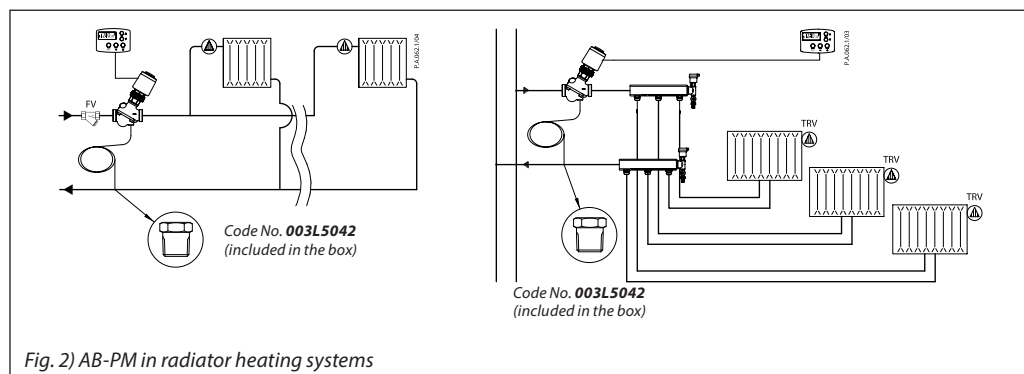

Fig. 2) AB-PM in radiator heating systems

¹⁾ For each room only one control element (TRV or room controller) is to be used in order to ensure best indoor temperature control performance.

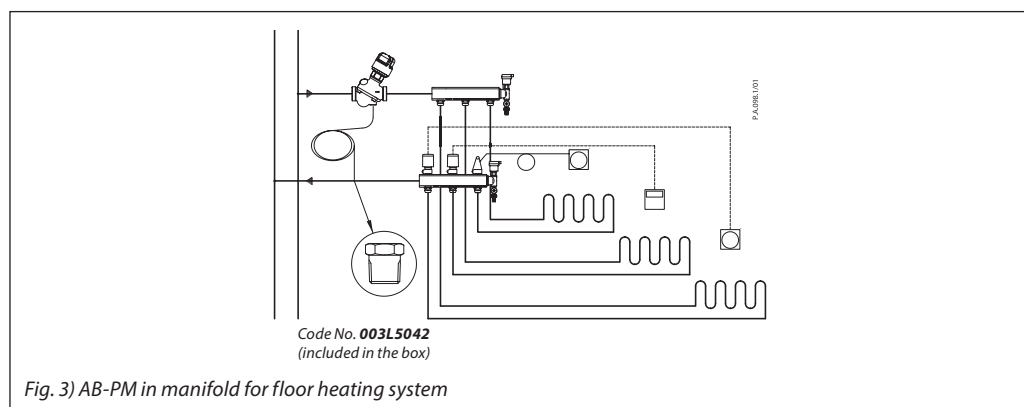

Fig. 3) AB-PM in manifold for floor heating system

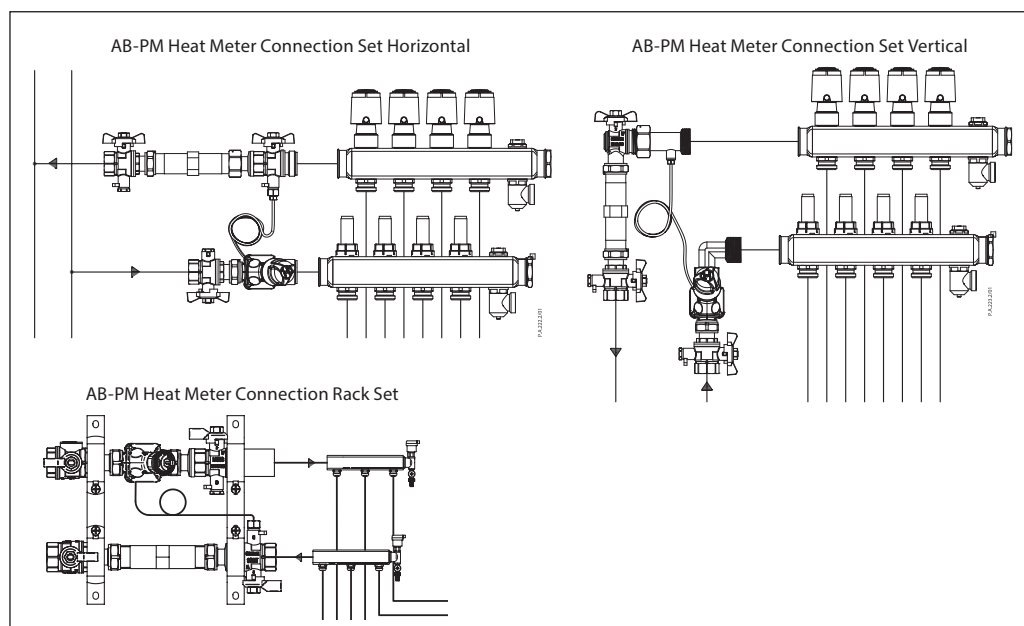

Fig.4) AB-PM connection set for manifold (horizontal or vertical connection)

Sizing

AB-PM is to be sized based on needed flow (Q) and needed differential pressure drop for the loop (Δp). Max flow data are presented in table 1.

For any other Q and Δp needed, AB-PM size and setting can be identified based on Fig. 5-14. Alternatively table 2-11 can be used for AB-PM sizing as well. Q is proportional to the setting on AB-PM while upper limit differential pressure (Δp) is kept the same.

Table 1

Type at 100% setting	DN	10		10 HP		15		15 HP		20		20 HP		25		25 HP		32		32 HP	
Q max.	l/h	110	135	110	155	300	400	300	490	600	780	600	915	1200	1600	1200	1800	2300	2700	2300	3350
Maximum pressure drop available for system at max flow		10	5	20	10	10	5	20	10	10	5	20	10	10	5	20	10	10	5	20	10
Max. pressure at zero load	kPa	22		35		22		35		22		35		22		35		22		35	
Min. differential pressure (Δp_s)		18		28		18		28		18		28		18		28		18		28	

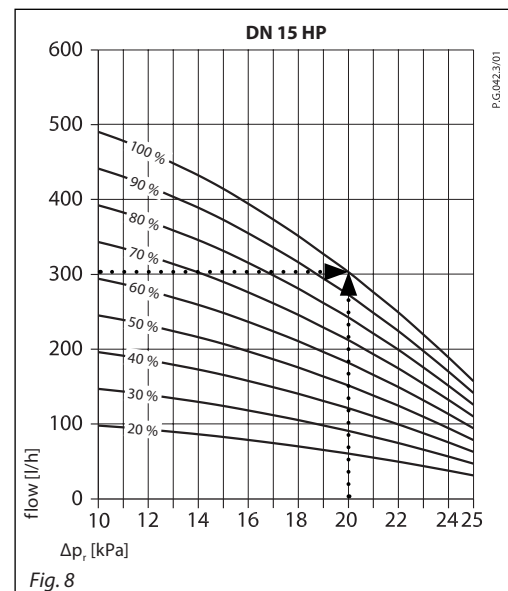
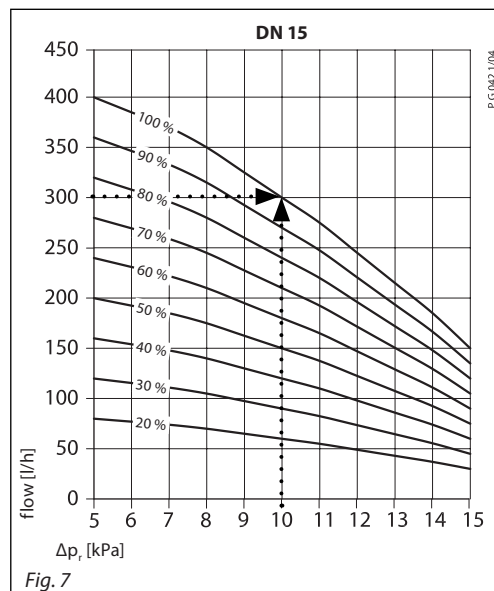
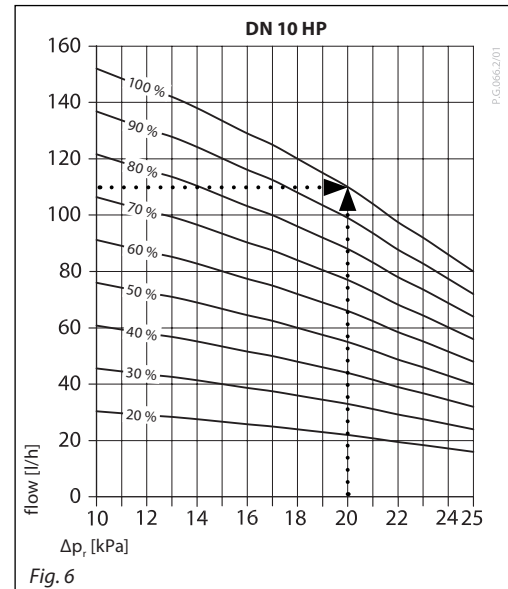
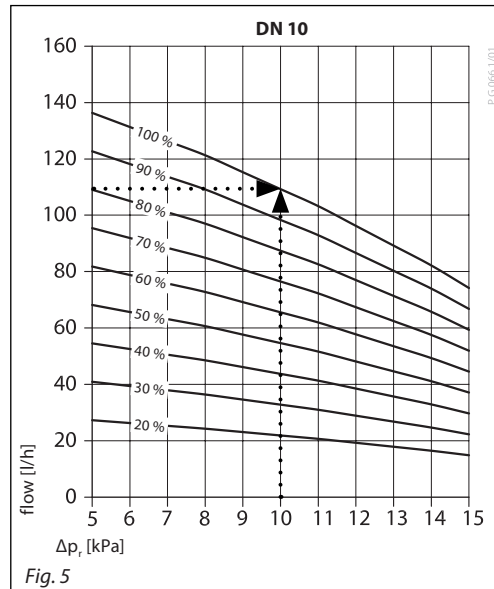

Sizing (continuous)

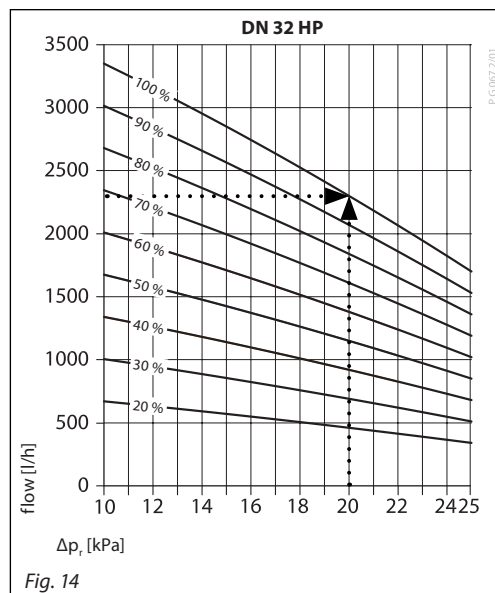
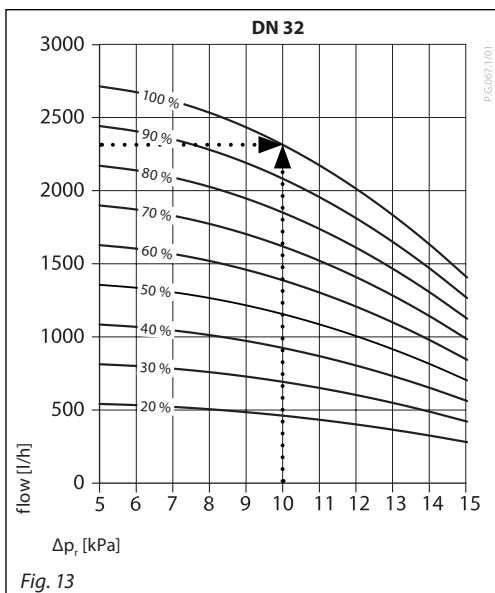
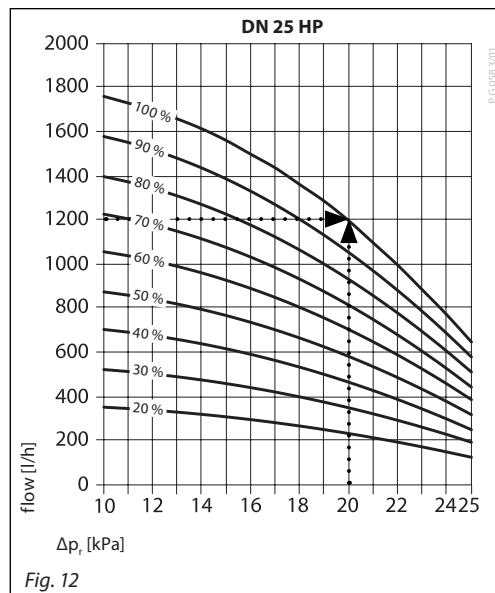
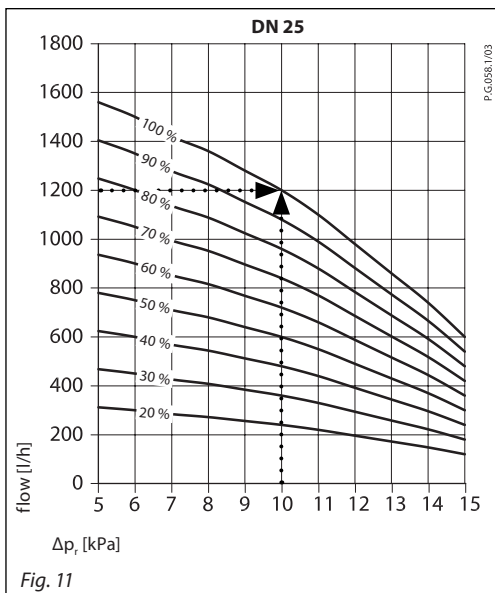
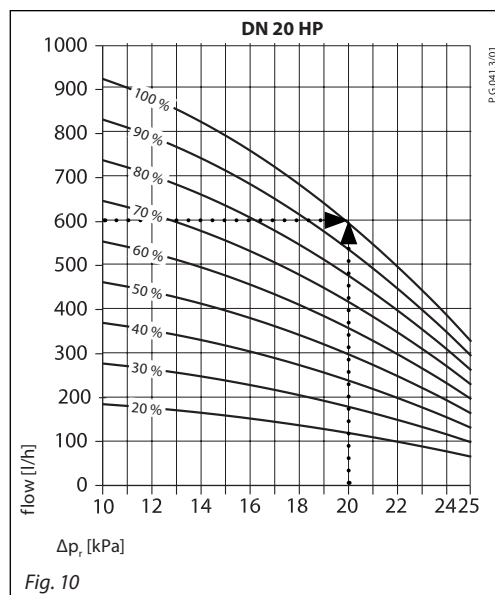
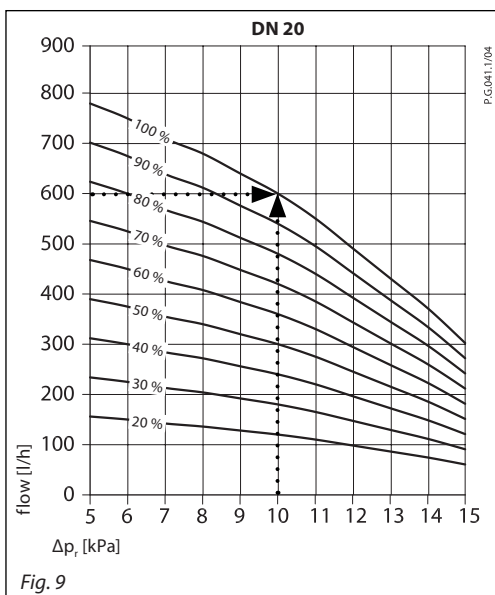

Sizing (continuous)

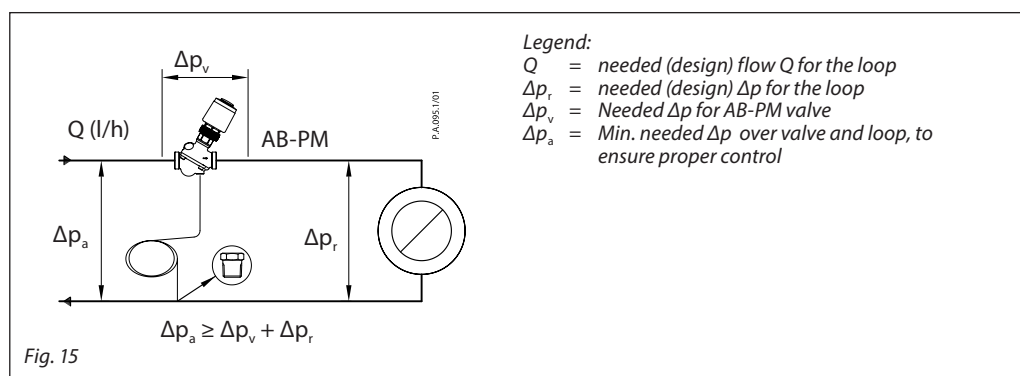

Example

Given:
 Design flow trough radiators loop: 420 l/h
 Pressure drop trough the loop at design flow: 10 kPa

Solution:
 AB-PM DN 20 is selected. Set to 70 % (= 420/600), AB-PM will control differential pressure of 10 kPa when design flow is achieved. It will at any loads including keep it under 22 kPa at zero load, while limiting the flow to radiator system to 420 l/h.

Table 2 AB-PM DN 10 setting

DN 10	flow [l/h] - average								
Δp _r [kPa]	20 %	30 %	40 %	50 %	60 %	70 %	80 %	90 %	100 %
5	25	40	55	70	80	95	110	120	135
6	25	40	50	65	80	90	105	115	130
7	25	40	50	65	75	90	100	115	125
8	25	35	50	60	70	85	95	110	120
9	25	35	45	60	70	80	90	105	115
10	20	35	45	55	65	75	90	100	110
Q _{max} at ΔT 20 °C	2.60 kW								
...									
13	20	25	35	45	55	65	70	80	90
14	15	25	30	40	50	55	65	70	80
15	15	25	30	40	45	55	60	70	75

Table 3 AB-PM DN 10 HP setting

DN 10 HP	flow [l/h] - average								
Δp _r [kPa]	20 %	30 %	40 %	50 %	60 %	70 %	80 %	90 %	100 %
10	30	45	60	80	95	110	125	140	155
...									
15	25	40	55	70	80	95	110	120	135
16	25	40	50	65	80	90	105	115	130
17	25	40	50	65	75	90	100	115	125
18	25	35	50	60	70	85	95	110	120
19	25	35	45	60	70	80	90	105	115
20	20	35	45	55	65	75	90	100	110
Q _{max} at ΔT 20 °C	2.60 kW								
21	20	30	40	55	65	75	85	95	105
22	20	30	40	50	60	70	80	90	100
23	20	25	35	45	55	65	70	80	90
24	15	25	35	45	50	60	70	75	85
25	15	25	30	40	50	55	65	70	80

Table 4 AB-PM DN 15 setting

DN 15	flow [l/h] - average								
Δp _r [kPa]	20 %	30 %	40 %	50 %	60 %	70 %	80 %	90 %	100 %
5	80	120	160	200	240	280	320	360	400
6	77	116	154	193	231	270	308	347	385
7	74	111	148	185	222	259	296	333	370
8	70	105	140	175	210	245	280	315	350
9	65	98	130	163	195	228	260	293	325
10	60	90	120	150	180	210	240	270	300
Q _{max} at ΔT 20 °C	7.0 kW								
...									
13	43	65	86	108	129	151	172	194	215
14	37	56	74	93	111	130	148	167	185
15	30	45	60	75	90	105	120	135	150

Sizing (continuous)

Table 5 AB-PM DN 15 HP setting

DN 15 HP	flow [l/h] - average								
Δp_v [kPa]	20 %	30 %	40 %	50 %	60 %	70 %	80 %	90 %	100 %
10	100	145	195	245	295	345	390	440	490
...									
15	85	125	165	210	250	290	330	375	415
16	80	120	160	200	235	275	315	355	395
17	75	115	150	190	225	265	300	340	375
18	70	105	140	175	210	245	280	315	350
19	65	100	130	165	195	225	260	295	325
20	60	90	120	150	180	210	240	270	300
Q_{max} at $\Delta T 20^\circ C$	7.0 kW								
21	55	85	110	140	165	195	220	250	275
22	50	75	100	125	150	175	200	225	250
23	45	65	90	110	130	155	175	200	220
24	40	55	75	95	115	135	150	170	190
25	30	50	65	80	95	110	130	145	160

Table 6 AB-PM DN 20 setting

DN 20	flow [l/h] - average								
Δp_v [kPa]	20 %	30 %	40 %	50 %	60 %	70 %	80 %	90 %	100 %
5	155	235	310	390	470	545	625	700	780
6	150	225	300	375	450	525	600	675	750
7	140	215	285	355	425	495	570	640	710
8	135	205	270	340	410	475	545	610	680
9	130	190	255	320	385	450	510	575	640
10	120	180	240	300	360	420	480	540	600
Q_{max} at $\Delta T 20^\circ C$	13.9 kW								
...									
13	85	130	170	215	260	300	345	385	430
14	75	110	150	185	220	260	295	335	370
15	60	90	120	150	180	210	240	270	300

Table 7 AB-PM DN 20 HP setting

DN 20 HP	flow [l/h] - average								
Δp_v [kPa]	20 %	30 %	40 %	50 %	60 %	70 %	80 %	90 %	100 %
10	185	275	370	460	550	645	735	830	920
...									
15	160	235	315	395	475	555	630	710	790
16	150	225	300	380	455	530	605	680	755
17	145	215	290	360	430	505	575	650	720
18	135	205	270	340	410	475	545	610	680
19	130	190	255	320	385	450	510	575	640
20	120	180	240	300	360	420	480	540	600
Q_{max} at $\Delta T 20^\circ C$	13.9 kW								
21	110	165	220	275	325	380	435	490	545
22	100	150	200	250	295	345	395	445	495
23	90	130	175	220	265	310	350	395	440
24	75	115	155	195	230	270	310	345	385
25	65	100	130	165	195	225	260	295	325

Table 8 AB-PM DN 25 setting

DN 25	flow [l/h] - average								
Δp_v [kPa]	20 %	30 %	40 %	50 %	60 %	70 %	80 %	90 %	100 %
5	310	470	625	780	935	1090	1250	1405	1560
6	300	450	600	750	900	1050	1200	1350	1500
7	285	425	570	710	850	995	1135	1280	1420
8	270	410	545	680	815	950	1090	1225	1360
9	255	385	510	640	770	895	1025	1150	1280
10	240	360	480	600	720	840	960	1080	1200
Q_{max} at $\Delta T 20^\circ C$	27.9 kW								
...									
13	170	260	345	430	515	600	690	775	860
14	150	220	295	370	445	520	590	665	740
15	120	180	240	300	360	420	480	540	600

Sizing (continuous)

Table 9 AB-PM DN 25 HP setting

DN 25 HP	flow [l/h] - average								
Δp_v [kPa]	20 %	30 %	40 %	50 %	60 %	70 %	80 %	90 %	100 %
10	350	525	700	875	1050	1225	1400	1575	1750
...									
15	305	460	615	770	920	1075	1230	1380	1535
16	295	445	590	740	885	1035	1180	1330	1475
17	280	420	560	705	845	985	1125	1265	1405
18	265	400	530	665	800	930	1065	1195	1330
19	250	375	500	625	750	875	1000	1125	1250
20	240	360	480	600	720	840	960	1080	1200
Q_{max} at ΔT 20 °C	27.9 kW								
21	215	320	430	535	640	750	855	965	1070
22	195	290	390	485	580	680	775	875	970
23	175	260	345	435	520	605	690	780	865
24	150	225	300	380	455	530	605	680	755
25	130	190	255	320	385	450	510	575	640

Table 10 AB-PM DN 32 setting

DN 32	flow [l/h] - average								
Δp_v [kPa]	20 %	30 %	40 %	50 %	60 %	70 %	80 %	90 %	100 %
5	540	810	1080	1350	1620	1890	2160	2430	2700
6	530	800	1065	1330	1595	1860	2130	2395	2660
7	520	780	1040	1300	1560	1820	2080	2340	2600
8	505	755	1010	1260	1510	1765	2015	2270	2520
9	485	725	970	1210	1450	1695	1935	2180	2420
10	460	690	920	1150	1380	1610	1840	2070	2300
Q_{max} at ΔT 20 °C	51.2 kW								
...									
13	365	545	730	910	1090	1275	1455	1640	1820
14	325	485	650	810	970	1135	1295	1460	1620
15	280	420	560	700	840	980	1120	1260	1400

Table 11 AB-PM DN 32 HP setting

DN 32 HP	flow [l/h] - average								
Δp_v [kPa]	20 %	30 %	40 %	50 %	60 %	70 %	80 %	90 %	100 %
10	670	1005	1340	1675	2010	2345	2680	3015	3350
...									
15	570	855	1140	1425	1710	1995	2280	2565	2850
16	550	825	1100	1370	1645	1920	2195	2470	2744
17	525	790	1055	1320	1580	1845	2110	2370	2635
18	505	760	1010	1265	1515	1770	2020	2275	2525
19	485	725	965	1210	1450	1690	1930	2175	2415
20	460	690	920	1150	1380	1610	1840	2070	2300
Q_{max} at ΔT 20 °C	51.2 kW								
21	435	655	875	1095	1310	1530	1750	1965	2185
22	415	620	825	1035	1240	1445	1650	1860	2065
23	390	585	780	975	1170	1365	1560	1755	1950
24	365	550	730	915	1095	1280	1460	1645	1825
25	340	510	680	850	1020	1190	1360	1530	1700

Design

1. Spindle
2. Stuffing box
3. Pointer
4. Control valve's cone
5. Membrane
6. Main spring
7. Hollow cone (pressure controller)
8. Vulcanized seat (pressure controller)
9. Impulse tube

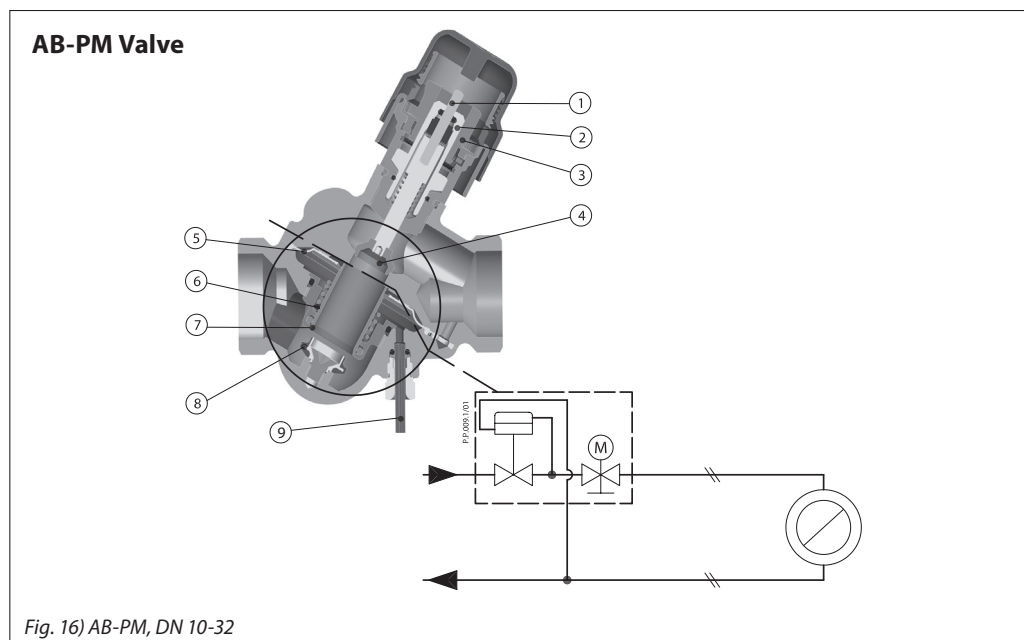

AB-PM is a combined automatic balancing valve. It is working as Δp controller, flow limiter and zone controller. Higher pressure acts on the upper side of the control diaphragm (5) while via an impulse tube (9) lower pressure in the return pipe acts on the lower side of the diaphragm. When available pressure increases at partial loads, the membrane closes and thus keeps stable Δp inside the controlled loop. Δp controller keeps constant differential pressure on the controlled loop including the control part of AB-PM (similar as if ASV-I would be integrated into ASV-P).

The control part of AB-PM is working as a flow limiter. This enables to set both the design flow as well as needed Δp . The flow rate is defined by presetting AB-PM, based on pressure demand of the loop.

With actuator mounted on the valve, AB-PM can be used as zone valve. When connected to the room controller with time programs, functions such as night setback, holiday mode, etc become available.

Connection Set

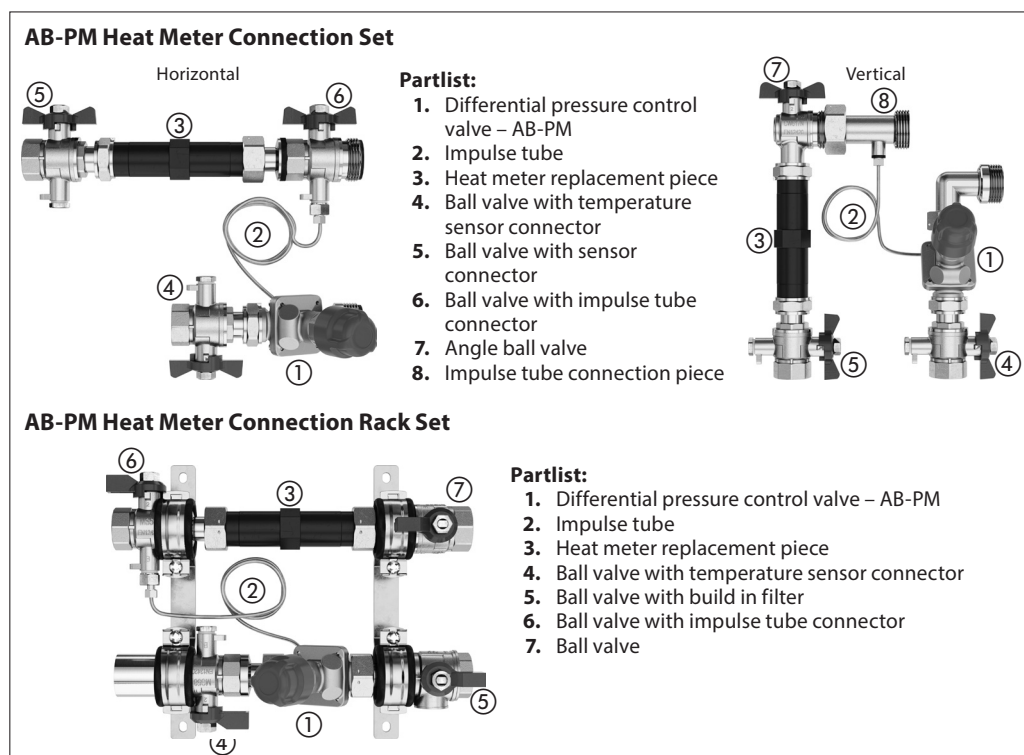

Dimensions

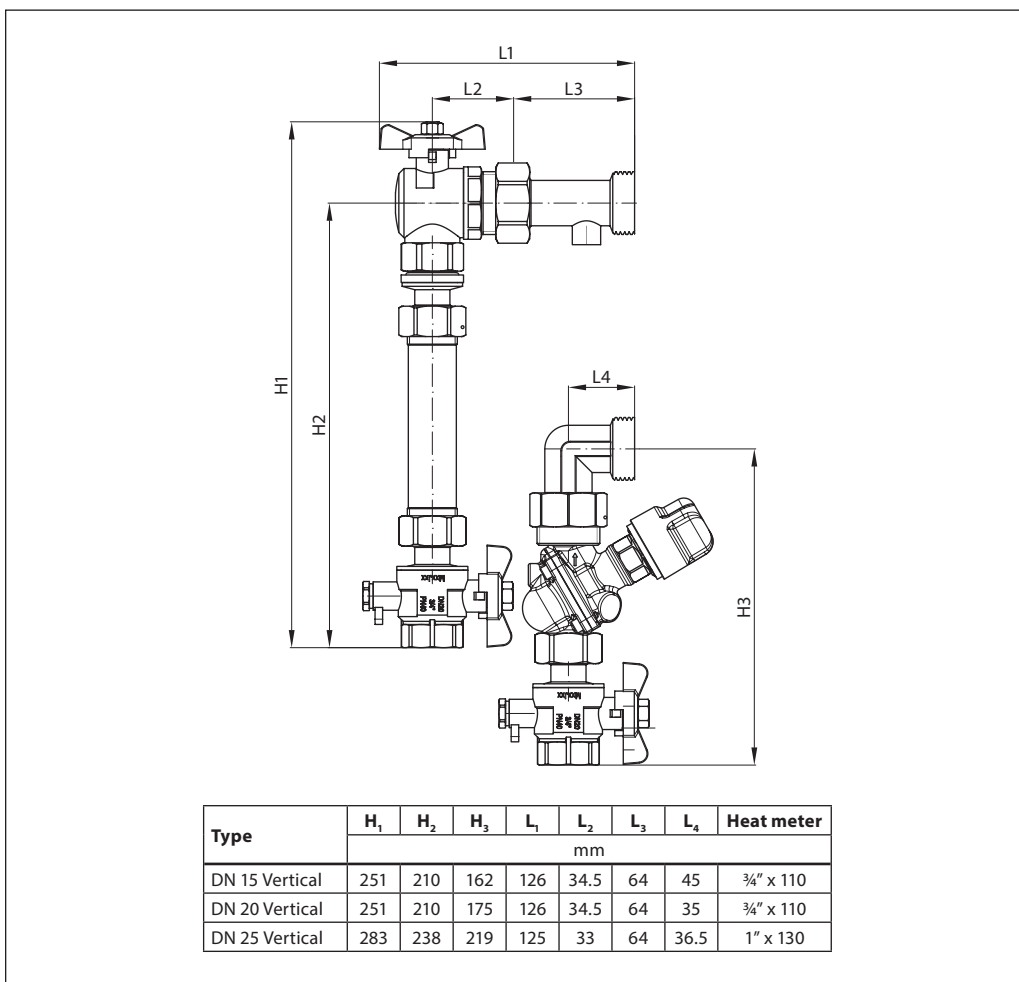
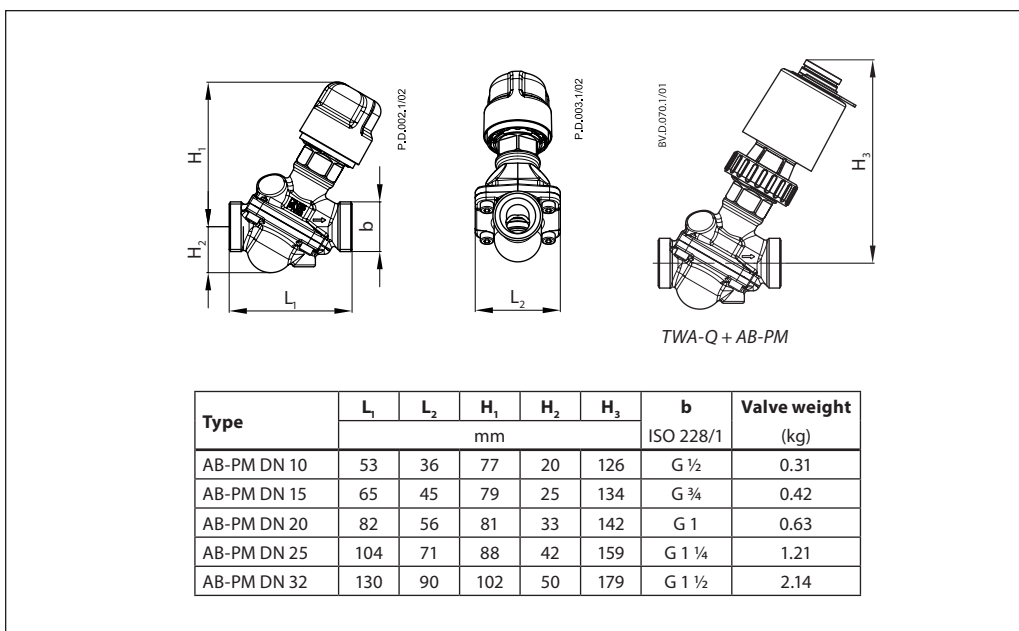

Dimensions (continuous)

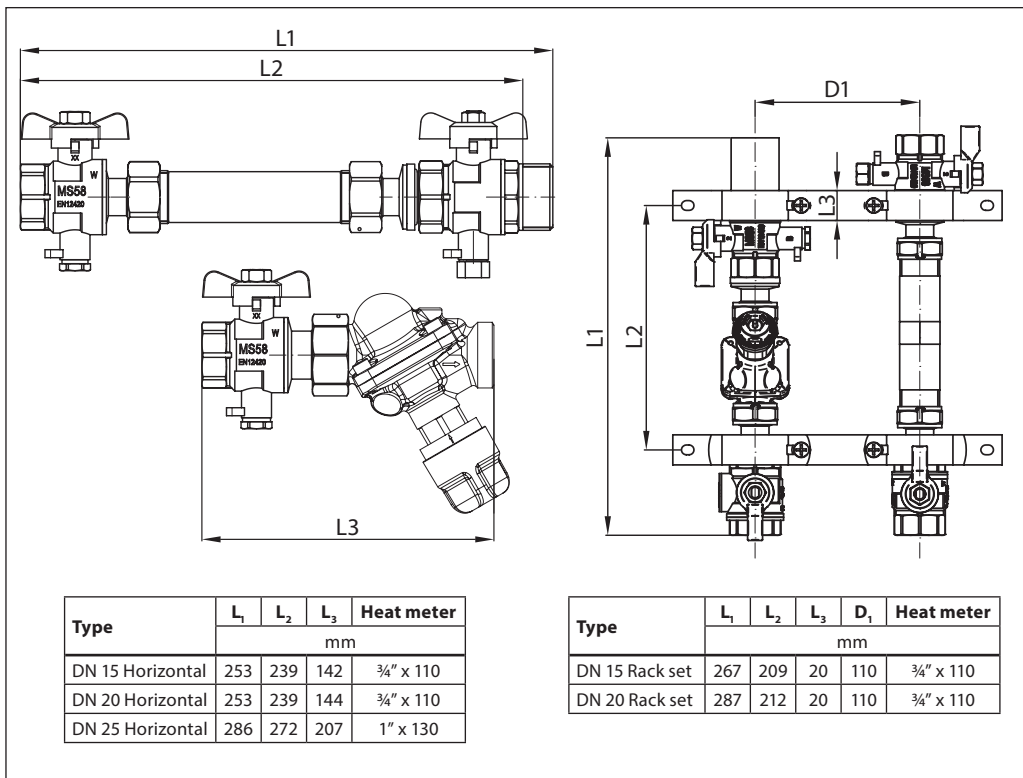

Fittings

For valves with external thread Danfoss offers threaded or welded tailpieces as accessory.

Materials:

- Nutbrass
- Tailpiece weldingsteel
- Tailpiece threadedbrass

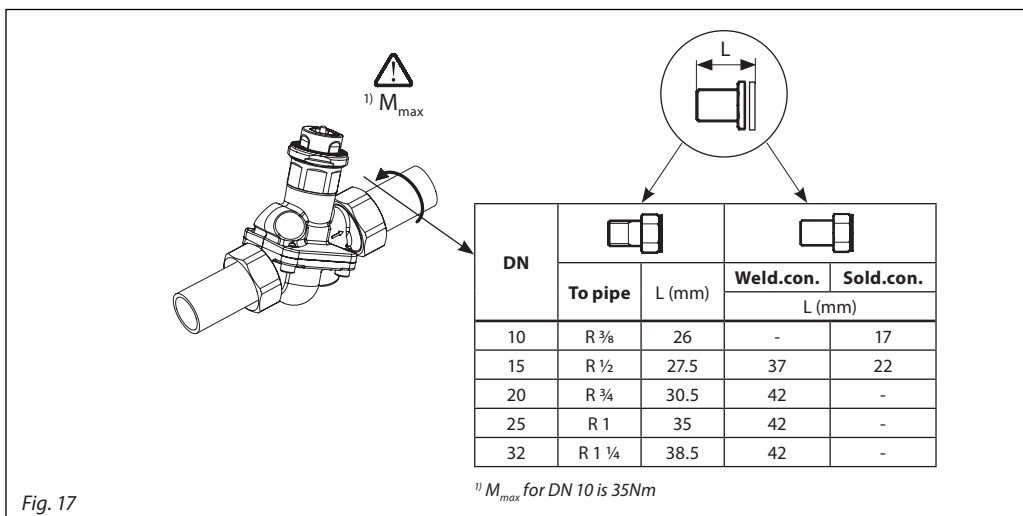
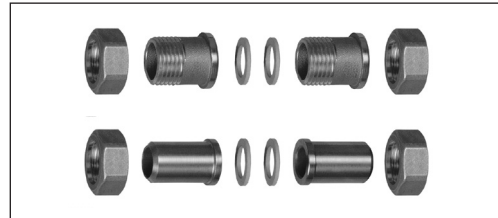

Fig. 17

Tender text

AB-PM - Combined Automatic Balancing Valve

Branch should be balanced with a differential pressure controller for dynamic hydronic balance, with following characteristics:

- Valve should keep differential pressure across the branch by membrane driven controller.
- Valve should have shut-off function.
- Valve should have possibility to mount actuator.
- Valve should have variable setting. Setting value should allow to set a combination of needed Δp and max flow limitation.
- Setting should be lockable to prevent unauthorized change.
- Valve should have metal to metal sealing to ensure sufficient performance of differential pressure control at low flows.
- Shut-off service function should be possible to do by hand / without a tool.
- Valve should be delivered with impulse tube. Diameter of impulse tube should not be bigger than 1.2 mm.
- Valve should be delivered in reliable packaging for safe transport and handling.

Product characteristics:

- a. Pressure class: PN 16
- b. Temperature range: $-10 \dots +120$ °C.
- c. Connection size: DN10-DN32
- d. Connection type: External thread ISO 228/1
- e. Valve body material: DZR brass
- f. Installation: on flow pipe with connection via impulse tube to return pipe.
- g. **DN10-32:**
 - Δp setting range: 5-15 kPa
 - Nom. flow at 10 kPa: 110 l/h (DN10), 300 l/h (DN15), 600 l/h (DN20), 1200 l/h (DN25) and 2300 l/h (DN32)
 - Minimum Δp across valve and loop 18 kPa to ensure proper control
 - Max Δp at zero flow: 22 kPa
 - Max Δp across the valve: 4 bar
- h. **DN10-32 HP:**
 - Δp setting range: 10-25 kPa
 - Nom flow at 20 kPa: 110 l/h (DN10), 300 l/h (DN15), 600 l/h (DN20), 1200 l/h (DN25) and 2300 l/h (DN32)
 - Minimum Δp across valve and loop 28 kPa to ensure proper control
 - Max Δp at zero flow: 35 kPa
 - Max Δp across the valve: 4 bar

Danfoss A/S

Climate Solutions • danfoss.com • +45 7488 2222

Any information, including, but not limited to information on selection of product, its application or use, product design, weight, dimensions, capacity or any other technical data in product manuals, catalogues descriptions, advertisements, etc. and whether made available in writing, orally, electronically, online or via download, shall be considered informative, and is only binding if and to the extent, explicit reference is made in a quotation or order confirmation. Danfoss cannot accept any responsibility for possible errors in catalogues, brochures, videos and other material. Danfoss reserves the right to alter its products without notice. This also applies to products ordered but not delivered provided that such alterations can be made without changes to form, fit or function of the product.

All trademarks in this material are property of Danfoss A/S or Danfoss group companies. Danfoss and the Danfoss logo are trademarks of Danfoss A/S. All rights reserved.