

## Data Sheet

Safety relief valve  
Type **SFV 20-25**

Designed for protection of vessels and other components against excessive pressure



SFV 20 - 25 are standard, back pressure dependent safety relief valves in angle-way execution, specially designed for protection of vessels and other components against excessive pressure.

The valve is designed to meet the strict quality demands and safety requirements for refrigeration installations, specified by the international classification societies.

The valve is recommended as an external and internal safety relief valve in refrigeration plants. The spring housing is closed tightly to avoid refrigerant leakage.

The inlet flow diameters of the valves are:

- 18 mm (¾ in.) for SFV 20
- 23 mm (1 in.) for SFV 25

The valves can be delivered with set pressures between 10 and 25 bar (145 and 363 psig).

Standard pressure setting valves having "TÜV Pressure Setting Certificate" with each valve, are also available.

**Features**

- Applicable for the refrigerants HCFC, HFC, R717 (Ammonia), R744 (CO<sub>2</sub>) within a temperature range of -30°C / +100°C (-22°F / +212°F).
- Classification: DNV, CRN, BV, EAC etc. To get an updated list of certification on the products please contact your local Danfoss Sales Company.

## Media

### **Refrigerants**

Applicable for the refrigerants HCFC, HFC, R717 (Ammonia), R744 (CO<sub>2</sub>) within a temperature range of -30 °C/+100 °C (-22 °F/+212 °F)

- Flammable hydrocarbons are not recommended.
- For further information please contact your local Danfoss Sales Company.

### **New refrigerants**

Danfoss products are continually evaluated for use with new refrigerants depending on market requirements.

When a refrigerant is approved for use by Danfoss, it is added to the relevant portfolio, and the R number of the refrigerant (e.g. R513A) will be added to the technical data of the code number. Therefore, products for specific refrigerants are best checked at [store.danfoss.com/en/](https://store.danfoss.com/en/), or by contacting your local Danfoss representative.

## Product specification

### Pressure and temperature data

- **Pressure**

Pressure setting range: 10 - 25 bar (145 - 363 psig). For further information please contact your local Danfoss Sales Company.

The valves are designed for: Strength test:

- 43 bar (624 psig)

- **Leakage safety**

Same as set pressure.

**!** **IMPORTANT:**

The SFV safety relief valve is dependent on the back pressure (if the back pressure is higher than the atmospheric pressure, the opening pressure will be higher than stated set pressure).

Special circumstances such as vibrations (which should be avoided) and oscillating pressure may require an increased difference between the operational pressure and the closing pressure.

- **Pressure setting**

The operating pressure of the plant should be at least 15% below the set pressure. This allows a perfect re-seating of the safety relief valve after having been activated.

- **Temperature range** : -30 °C/+100 °C (-22/+212 °F)

### Design

#### **Housing**

Made of special steel approved for low temperature operation. Spindle and seat are made of stainless steel, to ensure precise operation even during extraordinary conditions. The gasket of the valve cone is made of a special chloroprene (neoprene) rubber.

#### **Re-calibration/servicing**

In certain countries the authorities demand that the valves are checked at least once a year (see local rules).

#### **Control/Identification**

After adjustment of the set pressure at Danfoss, the valves are sealed. For that reason Danfoss can only guarantee correct operation, as long as the seal remains unbroken.

All valves are provided with a metal plate with the following information:

- Flow diameter
- Set pressure
- Date of production
- Production number
- Type approved code

#### **Transport/Handling**

The valves are fitted with special protection covers and packed into purpose made transportation cartons.

It is important the cover remains fitted around the valve until it is installed.

To ensure the exact and precise operation of the valve it must be handled with care.

### Pressure Equipment Directive (PED)

Table 1: Pressure Equipment Directive (PED)

	The SFV-valves are approved in accordance with the European standard specified in the Pressure Equipment Directive and are CE marked. For further details / restrictions - see Installation Instruction.
---	--

Table 2: SFV

SFV valves		
Nominal bore	18 mm (0.709 in.)	23 mm (0.906 in.)
Classified for	Fluid group I	
Category	IV	

Figure 1: SFV Graph

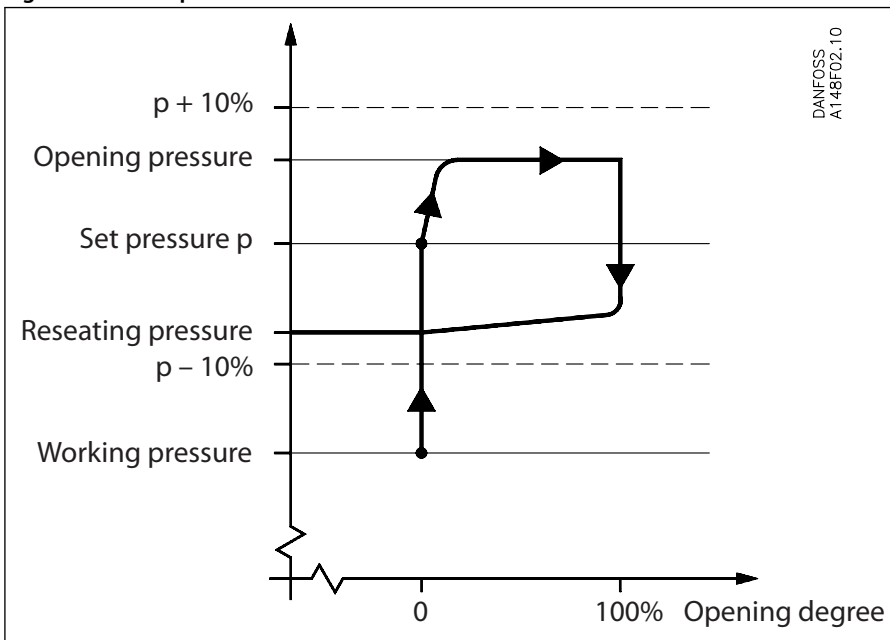

SFV is designed as a standard safety relief valve (DIN 3320), which are recommended for refrigeration plants. On a rise in pressure above the set pressure, the safety relief valve will initially start opening slightly, to minimise the outlet of refrigerant. If the pressure continues to increase, the valve will open fully. The safety relief valve will be fully open before the pressure is 10% higher than set pressure, and fully closed before the pressure is 10% below set pressure.

### Connections

Available with the following connections:

- Outside pipe thread T (ISO 228/1)
- Welding fittings (DIN 2448)

Figure 2: T

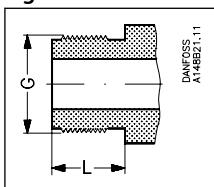

Table 3: T outside pipe thread, (ISO 228/1)

Size (mm)	Size (in.)	Inlet	Outlet	L (mm)	L (in.)
20	¾	G 1¼	G 1½	20	0.79
25	1	G 1¼	G 1½	20	0.79

Figure 3: DIN

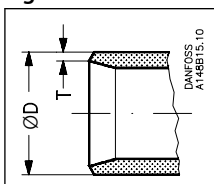

Table 4: Welding fittings DIN (2448)

Size (mm)	Size (in)	Inlet (mm)		Inlet (in.)		Outlet (mm)		Outlet (in.)	
		øD	T	øD	T	øD	T	øD	T
20	¾	26.9	2.3	1.059	0.091	33.7	2.6	1.337	0.102
25	1	26.6	2.5	1.327	0.102	42.4	2.6	1.669	0.102

## Installation

To ensure exact operation of the safety relief valve it should be installed with the spring housing upwards. If the valve is mounted as an internal safety relief valve without any demand for exact opening pressure, the valve may be fitted with the spring housing in other positions. When the valve is mounted, it is important to avoid the influence of static, dynamic and thermal stress.

A very precise technique has been applied for the production of the seal. However, this seal can still be damaged, if dirt is blown from the pipe system into the valve.

It is recommended that safety relief valves exhaust into the open air with a U-pipe filled with oil on the discharge branch, to prevent dirt from penetrating into the valve. It is also recommended that the valves be installed in pairs in conjunction with the double stop valve type DSV. For further information please see the DSV data sheet.

## Capacity

The design and construction of the safety relief valve has been tested and approved by TÜV. This test comprises control of the function of the valve as well as measuring of the capacity, which is the basis of the curves and tables on the following pages. The values in the table are based on saturated gas.

If e.g. back pressure or superheated gas have to be taken into consideration, the formulas or the Danfoss computation program (DIRcalc) can be used.

**Table 5: Capacity Values**

Valve	Nominal size		Flow diameter	Flow area	De-rated, certified coefficient of discharge
	Inlet	Outlet	$d_o$	$A_o$	$K_{dr}$
SFV 20	20 mm	25 mm	18 mm	254 mm <sup>2</sup>	0.54
	¾ in.	1 in.	0.709 in.	0.394 in <sup>2</sup>	
SFV 25	25 mm	32 mm	23 mm	415 mm <sup>2</sup>	0.48
	1 in.	1¼	0.906 in.	0.643 in <sup>2</sup>	

The discharge capacity of the safety relief valves are based on (ISO 4126-1 / prEN 1313 6 (1998)).

$$q_m = 0.2883 \times C \times A_o \times K_{dr} \times K_b \sqrt{\frac{p}{V}}$$

$q_m$	Discharge capacity (kg/h)
$C$	Discharge function depending of the actual refrigerant (k) see table 2 (-)
$A_o$	Flow area of the safety relief valve (mm <sup>2</sup> ).
$K_{dr}$	De-rated coefficient of discharge ( $K_{dr} = K_d \times 0.9$ ), (the $K_{dr}$ is certified by TÜV) see table 1 (-)
$K_b$	Correction factor for sub-critical flow. (-) $K_b = 1.0$ when the back pressure is lower than approx. $0.5 \times$ relieving pressure ( $P_b < 0.5 \times p$ ) For all SFV safety valves $K_b = 1.0$
$V$	Specific volume of the vapour at the relieving pressure $p$ . (m <sup>3</sup> /kg)
$p_{set}$	Set pressure, the predetermined pressure at which a pressure relief valve under operation starts to open ( $p_{set}$ is indicated on the metal plate on the safety relief valve). (bar gauge)
$p_{atm}$	Atmospheric pressure. (1 bar)
$p$	Relieving pressure, $p = p_{set} \times 1.1 + p_{atm}$ (bar absolute)

For further details see the above-mentioned ISO or EN standards.

**Table 6: Table 2. Properties of Refrigerants**

Refrigerant	Isentropic exponent $\kappa$	Discharge function $C$
R22	1.17	2.54
R134a	1.12	2.5
R404A	1.12	2.49

## Safety relief valve, Type SFV 20-25

Refrigerant	Isentropic exponent $\kappa$	Discharge function C
R410A	1.17	2.54
R717 (Ammonia)	1.31	2.64
R744 (CO <sub>2</sub> )	1.3	2.63
Air	1.4	2.7

**Table 7: Capacity : SFV 20**

Set pressure		R22	R134a	R404A	R717	Air (20 °C)
13 bar(g)	kg/h	3220	3430	3500	1415	1790
189 psig	lb/min	118	126	129	52	66
18 bar(g)	kg/h	4440	4800	4900	1925	2435
261 psig	lb/min	163	176	180	71	89
21 bar(g)	kg/h	5215	5680	5770	2235	2820
305 psig	lb/min	192	209	212	82	104
25 bar(g)	kg/h	6285	6980	7125	2660	3335
363 psig	lb/min	231	257	262	98	122

**Figure 4: SFV 20**

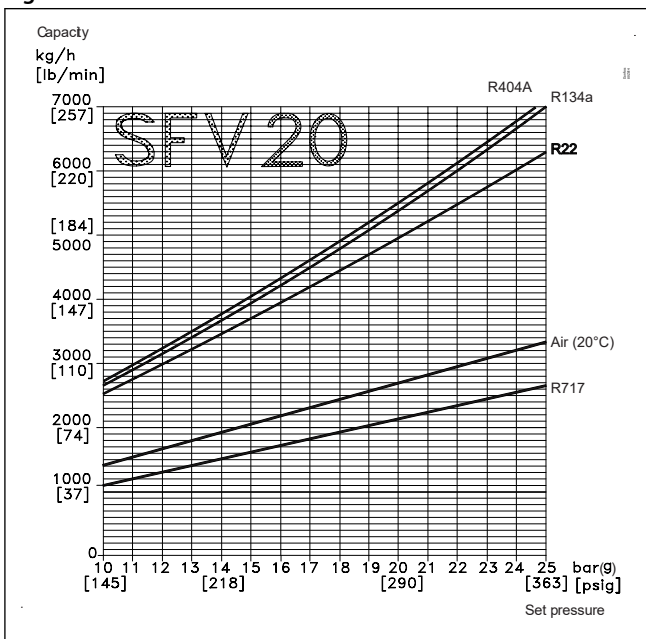

**Table 8: Capacity : SFV 25**

Set pressure		R22	R134a	R404A	R717	Air (20 °C)
13 bar(g)	kg/h	4670	4980	5075	2050	2600
189 psig	lb/min	172	183	186	75	96
18 bar(g)	kg/h	6445	6965	7115	2790	3530
261 psig	lb/min	237	256	261	103	130
21 bar(g)	kg/h	7565	8240	8370	3240	4090
305 psig	lb/min	278	303	308	119	150
25 bar(g)	kg/h	9120	10135	10340	3860	4835
363 psig	lb/min	335	372	380	142	178

Figure 5: SFV 25

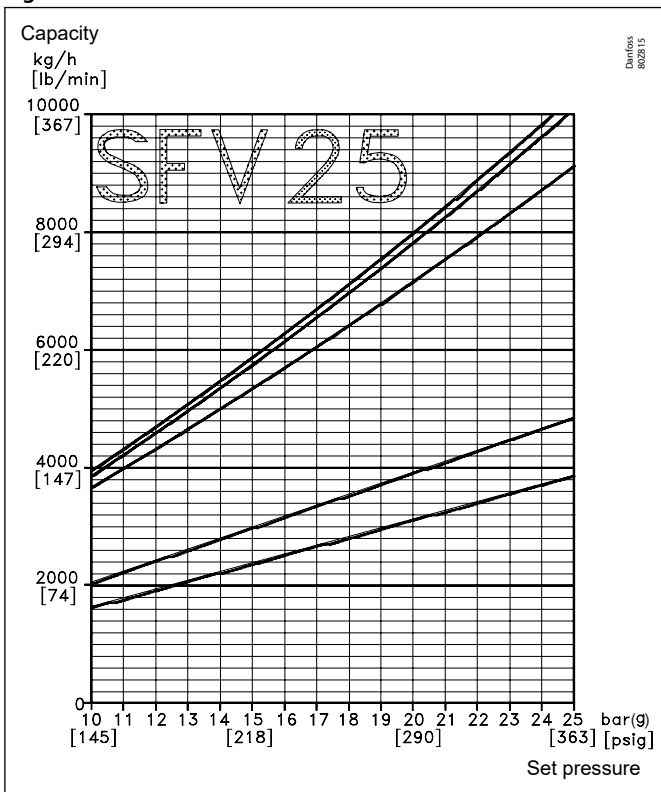

## Material specification

Figure 6: Material specification

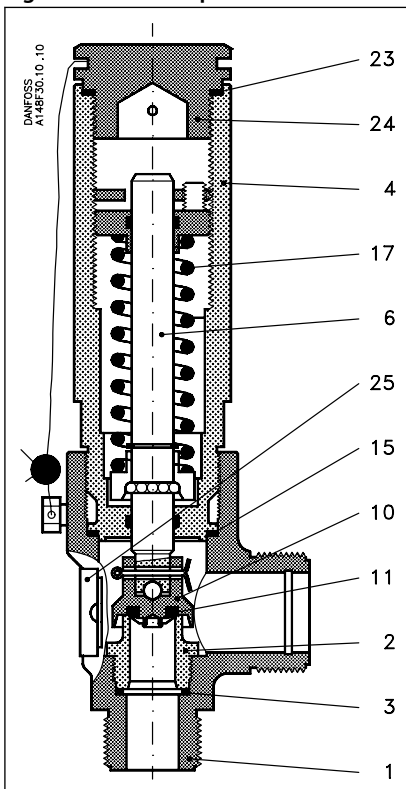

## Safety relief valve, Type SFV 20-25

**Table 9: Specifications**

No.	Part	Material	DIN	ISO	ASTM
1	Housing	Steel	G20Mn5 QT *P285QH *TTSt35N	TW 6, 2604/3-75	Grade 1, A333, A334 * A350 LF2
2	Valve seat	Stainless steel	X10CrNiS189, 17440	Type 17, 683/13	AISI 303
3	Packing washer	Aluminium *Non-asbestos gasket			
4	Valve top	Steel	St. 37.2, 1652	Fe 360 B, 660	Grade C, A 283
6	Valve spindle	Stainless steel	X10CrNiS189, 17440	Type 17, 683/13	AISI 303
10	Valve cone	Steel			
11	Valve cone seal	Chloroprene (Neoprene)			
15	Packing washer	Aluminium *Non-asbestos gasket			
17	Spring	Steel	Class C	A 679, 17223	
23	Packing washer	Aluminium *Non-asbestos gasket			
24	Plug	Steel	9S Mn28, 1651 *R St 37.2, 17100	Type 2, R 683 Fe 360 B, 630	Grade C, A 283
25	Marking label	Aluminium			

\*Alternative material

## Dimension and weight

**Table 10: Dimension and weight**

SFV 20 - 25 T	SFV 20 - 25 with welding fittings (flanges)

**Table 11: SFV 20 - 25 T, with threaded connections ISO 228/1 pipe threads**

Valve size		A	B	C	øD	AF	Weight
SFV 20 (¾ in.)	mm	15	270	40	60	60	4.2 kg
	in.	2.17	10.63	1.57	2.36	2.36	9.2 lb
SFV 25 (1 in.)	mm	55	270	40	60	60	4.2 kg
	in.	2.17	10.63	1.57	2.36	2.36	9.2 lb



## Safety relief valve, Type SFV 20-25

**Table 12: SFV with welding fittings, DIN 2448**

Valve size		A	B	G <sub>0</sub>	øD	G <sub>1</sub>	AF	Weight
SFV 20 (¾ in.)	mm	85	300	90	60	90	60	4.2 kg
	in.	3.35	11.81	3.54	2.36	3.54	2.36	9.2 lb
SFV 25 (1 in.)	mm	85	300	90	60	90	60	6.0 kg
	in.	3.35	11.81	3.54	2.36	3.54	2.36	13.2 lb

Specified weights are approximate values only.

## Ordering

### How to order

The table below is used to identify the valve required. Please note that the type codes only serve to identify the valves, some of which may not form part of the standard product range. For further information please contact your local Danfoss Sales Company.

### Example for type codes

Table 13: SFV 20 T 210

Valve type	SFV	Safety relief valve			
		Available connections			
			T	DIN welding fitting	
Nominal size in mm (valve size measured on the connection diameter)	20	DN 20	×	×	
	25	DN 25	×	×	
Connections	T	Outside threaded connections: ISO 228/1 Pipe thread - The welding fittings for single mounted safety relief valve must be ordered separately			
Pressure setting			Standard pressure setting: 2xx		
			SFV 20	SFV 25	
	210	10 bar (145 psig)	×	×	
	211	11 bar (160 psig)	×	×	
	212	12 bar (174 psig)	×	×	
	213	13 bar (188 psig)	×	×	
	214	14 bar (203 psig)	×	×	
	215	15 bar (218 psig)	×	×	
	216	16 bar (232 psig)	×	×	
	217	17 bar (247 psig)	×	×	
	218	18 bar (261 psig)	×	×	
	219	19 bar (276 psig)	×	×	
	220	20 bar (290 psig)	×	×	
	221	21 bar (305 psig)	×	×	
	222	22 bar (319 psig)	×	×	
	223	23 bar (334 psig)	×	×	
	224	24 bar (348 psig)	×	×	
	225	25 bar (363 psig)	×	×	
				Standard pressure setting with TÜV certificate: 3xx	
				SFV 20	SFV 25
	310	10 bar (145 psig)	×	×	×
	311	11 bar (160 psig)	×	×	×
	312	12 bar (174 psig)	×	×	×
	313	13 bar (188 psig)	×	×	×
	314	14 bar (203 psig)	×	×	×
	315	15 bar (218 psig)	×	×	×
	316	16 bar (232 psig)	×	×	×
	317	17 bar (247 psig)	×	×	×
	318	18 bar (261 psig)	×	×	×
	319	19 bar (276 psig)	×	×	×
	320	20 bar (290 psig)	×	×	×
	321	21 bar (304 psig)	×	×	×
322	22 bar (319 psig)	×	×	×	
323	23 bar (334 psig)	×	×	×	
324	24 bar (348 psig)	×	×	×	
325	25 bar (362 psig)	×	×	×	

### WARNING:

Where products need to be certified according to specific certification societies, the relevant information should be included at the time of order.

**Table 14: Certified SFV valves with standard set pressure**

Size		Construction and test facilities are approved by TUV		
mm	in.	Type	Bar (psig)	Part no.
20	¾	SFV20 T 210	10 (145)	2416+254
20	¾	SFV20 T 211	11 (160)	2416+255
20	¾	SFV20 T 212	12 (174)	2416+256
20	¾	SFV20 T 213	13 (189)	2416+150
20	¾	SFV20 T 214	14 (203)	2416+257
20	¾	SFV20 T 215	15 (218)	2416+258
20	¾	SFV20 T 216	16 (232)	2416+259
20	¾	SFV20 T 217	17 (247)	2416+260
20	¾	SFV20 T 218	18 (261)	2416+151
20	¾	SFV20 T 219	19 (276)	2416+261
20	¾	SFV20 T 220	20 (290)	2416+262
20	¾	SFV20 T 221	21 (305)	2416+152
20	¾	SFV20 T 222	22 (319)	2416+241
20	¾	SFV20 T 223	23 (334)	2416+263
20	¾	SFV20 T 224	24 (348)	2416+264
20	¾	SFV20 T 225	25 (363)	2416+183

**Table 15: Certified SFV valves with standard set pressure**

Size		Construction and test facilities are approved by TUV		
mm	in.	Type	Bar (psig)	Part no.
25	1	SFV25 T 210	10 (145)	2416+265
25	1	SFV25 T 211	11 (160)	2416+266
25	1	SFV25 T 212	12 (174)	2416+267
25	1	SFV25 T 213	13 (189)	2416+153
25	1	SFV25 T 214	14 (203)	2416+268
25	1	SFV25 T 215	15 (218)	2416+269
25	1	SFV25 T 216	16 (232)	2416+270
25	1	SFV25 T 217	17 (247)	2416+271
25	1	SFV25 T 218	18 (261)	2416+154
25	1	SFV25 T 219	19 (276)	2416+272
25	1	SFV25 T 220	20 (290)	2416+273
25	1	SFV25 T 221	21 (305)	2416+155
25	1	SFV25 T 222	22 (319)	2416+242
25	1	SFV25 T 223	23 (334)	2416+274
25	1	SFV25 T 224	24 (348)	2416+275
25	1	SFV25 T 225	25 (363)	2416+184

**Table 16: Certified SFV valves with standard set pressure and TUV pressure setting certificate with each valve**

Size		Each valve is certified by a representative from TUV		
mm	in.	Type	Bar (psig)	Part no.
20	¾	SFV20 T 310	10 (145)	2416+285
20	¾	SFV20 T 311	11 (160)	2416+286
20	¾	SFV20 T 312	12 (174)	2416+287
20	¾	SFV20 T 313	13 (189)	2416+160
20	¾	SFV20 T 314	14 (203)	2416+288
20	¾	SFV20 T 315	15 (218)	2416+289
20	¾	SFV20 T 316	16 (232)	2416+290
20	¾	SFV20 T 317	17 (247)	2416+291
20	¾	SFV20 T 318	18 (261)	2416+161
20	¾	SFV20 T 319	19 (276)	2416+292
20	¾	SFV20 T 320	20 (290)	2416+293
20	¾	SFV20 T 321	21 (305)	2416+162
20	¾	SFV20 T 322	22 (319)	2416+294
20	¾	SFV20 T 323	23 (334)	2416+295
20	¾	SFV20 T 324	24 (348)	2416+296
20	¾	SFV20 T 325	25 (363)	2416+186

**Table 17: Certified SFV valves with standard set pressure and TUV pressure setting certificate with each valve**

Size		Each valve is certified by a representative from TUV		
mm	in.	Type	Bar (psig)	Part no.
25	1	SFV25 T 310	10 (145)	2416+297
25	1	SFV25 T 311	11 (160)	2416+298
25	1	SFV25 T 312	12 (174)	2416+299
25	1	SFV25 T 313	13 (189)	2416+163
25	1	SFV25 T 314	14 (203)	2416+300
25	1	SFV25 T 315	15 (218)	2416+301
25	1	SFV25 T 316	16 (232)	2416+302
25	1	SFV25 T 317	17 (247)	2416+303
25	1	SFV25 T 318	18 (261)	2416+164
25	1	SFV25 T 319	19 (276)	2416+304
25	1	SFV25 T 320	20 (290)	2416+305
25	1	SFV25 T 321	21 (305)	2416+165
25	1	SFV25 T 322	22 (319)	2416+306
25	1	SFV25 T 323	23 (334)	2416+307
25	1	SFV25 T 324	24 (348)	2416+308
25	1	SFV25 T 325	25 (363)	2416+187

**Table 18: Flanges and gaskets**

Type	Code No.
Flanges + gaskets set for SFV 20	148F3020
Flanges + gaskets set for SFV 25	148F3021

**Table 19: Repair kit**

Type	Code No.
Repair kit for SFV 20 (gaskets and cone)	2453+082
Repair kit for SFV 25 (gaskets and cone)	2453+083

## Certificates, declarations and approvals

The list contains all certificates, declarations, and approvals for this product type. Individual code number may have some or all of these approvals, and certain local approvals may not appear on the list.

Some approvals may change over time. You can check the most current status at [danfoss.com](http://danfoss.com) or contact your local Danfoss representative if you have any questions.

### **Valid approvals**

**Table 20: Valid approvals**

File name	Document type	Document topic	Approval authority
BV 39409-B0 BV	Marine - Safety Certificate	BV	Kolding - Denmark; Tianjin - China
TUV 07 202 1321 Z 0018-13-D-01	Pressure - Safety Certificate	PED	TÜV
TUV SV 17-895	Pressure - Safety Certificate		TÜV
DNV GL TAP000000M	Marine - Safety Certificate		DNV GL
RMRS 19.10327.266	Marine - Safety Certificate		RMRS

## Online support

Danfoss offers a wide range of support along with our products, including digital product information, software, mobile apps, and expert guidance. See the possibilities below.

### The Danfoss Product Store



The Danfoss Product Store is your one-stop shop for everything product related—no matter where you are in the world or what area of the cooling industry you work in. Get quick access to essential information like product specs, code numbers, technical documentation, certifications, accessories, and more.

Start browsing at [store.danfoss.com](https://store.danfoss.com).

### Find technical documentation



Find the technical documentation you need to get your project up and running. Get direct access to our official collection of data sheets, certificates and declarations, manuals and guides, 3D models and drawings, case stories, brochures, and much more.

Start searching now at [www.danfoss.com/en/service-and-support/documentation](https://www.danfoss.com/en/service-and-support/documentation).

### Danfoss Learning



Danfoss Learning is a free online learning platform. It features courses and materials specifically designed to help engineers, installers, service technicians, and wholesalers better understand the products, applications, industry topics, and trends that will help you do your job better.

Create your Danfoss Learning account for free at [www.danfoss.com/en/service-and-support/learning](https://www.danfoss.com/en/service-and-support/learning).

### Get local information and support



Local Danfoss websites are the main sources for help and information about our company and products. Find product availability, get the latest regional news, or connect with a nearby expert—all in your own language.

Find your local Danfoss website here: [www.danfoss.com/en/choose-region](https://www.danfoss.com/en/choose-region).

### Spare Parts



Get access to the Danfoss spare parts and service kit catalog right from your smartphone. The app contains a wide range of components for air conditioning and refrigeration applications, such as valves, strainers, pressure switches, and sensors.

Download the Spare Parts app for free at [www.danfoss.com/en/service-and-support/downloads](https://www.danfoss.com/en/service-and-support/downloads).

### Coolselector®2 - find the best components for you HVAC/R system



Coolselector®2 makes it easy for engineers, consultants, and designers to find and order the best components for refrigeration and air conditioning systems. Run calculations based on your operating conditions and then choose the best setup for your system design.

Download Coolselector®2 for free at [coolselector.danfoss.com](https://coolselector.danfoss.com).

### Danfoss A/S

Climate Solutions • [danfoss.com](https://danfoss.com) • +45 7488 2222

Any information, including, but not limited to information on selection of product, its application or use, product design, weight, dimensions, capacity or any other technical data in product manuals, catalogues descriptions, advertisements, etc. and whether made available in writing, orally, electronically, online or via download, shall be considered informative, and is only binding if and to the extent, explicit reference is made in a quotation or order confirmation. Danfoss cannot accept any responsibility for possible errors in catalogues, brochures, videos and other material. Danfoss reserves the right to alter its products without notice. This also applies to products ordered but not delivered provided that such alterations can be made without changes to form, fit or function of the product.

All trademarks in this material are property of Danfoss A/S or Danfoss group companies. Danfoss and the Danfoss logo are trademarks of Danfoss A/S. All rights reserved.