

## Data Sheet

Check valve  
Type **NRVA**

Used in liquid, suction and hot gas lines in refrigeration

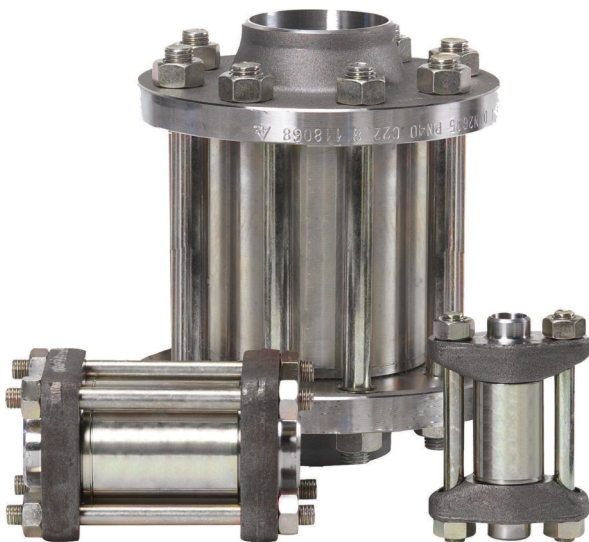

Check valve type NRVA can be used in liquid, suction and hot gas lines in refrigeration and air conditioning plant with ammonia.

NRVA can also be used in refrigerating systems with fluorinated refrigerants.

When the NRVA is used in liquid lines where cold, thick oil or impurities may be present, it is recommended that the standard spring be replaced by a special spring. See ordering table.

**Features:**

- Ensures correct direction of flow
- Valve housing made of steel
- Available for 40 bar / 580 psig working pressure
- Large range of flanges with connection dimensions in accordance with standards: DIN, ANSI, SOC, SA and FPT
- Fitted with damping piston that makes the valves suitable for installation in lines where pulsation can occur, e.g. in the discharge line from the compressor
- Classification: DNV, CRN, BV, EAC etc. To get an updated list of certification on the products please contact your local Danfoss Sales Company.

## Media

### **Refrigerants**

Applicable to HCFC, HFC and R717 (Ammonia). For further information please see installation instruction for NRVA.

Use with flammable hydrocarbons cannot be recommended; please contact Danfoss [www.danfoss.com/en/service-and-support/learning/](http://www.danfoss.com/en/service-and-support/learning/).

### **New refrigerants**

Danfoss products are continually evaluated for use with new refrigerants depending on market requirements.

When a refrigerant is approved for use by Danfoss, it is added to the relevant portfolio, and the R number of the refrigerant (e.g. R513A) will be added to the technical data of the code number. Therefore, products for specific refrigerants are best checked at [store.danfoss.com/en/](http://store.danfoss.com/en/), or by contacting your local Danfoss representative.

## Product specification

### Pressure and temperature

Table 1: Pressure and temperature data

Description	Values
Temperature range	-50 °C – 140 °C / -58 °F – 284 °F
Pressure range	Max. working pressure: 40 bar / 580 psig

### Design

**Gaskets:**

Do not contain asbestos.

**Valve cone:**

The valve cone has a teflon tightening ring. Teflon tightening ring renders perfect sealing at a minimum closing force.

### Material specification

Figure 1: Material specification for NRVA check valves

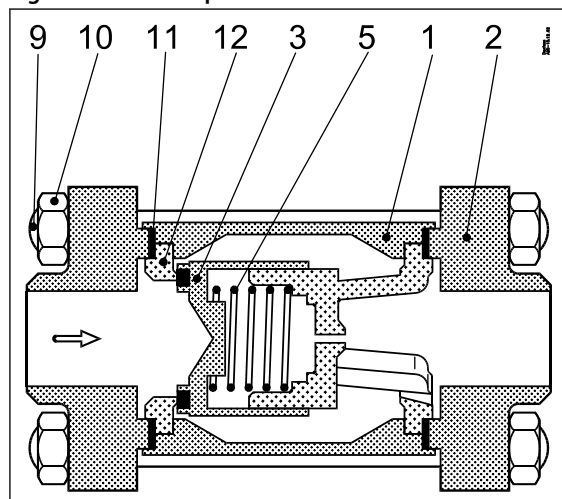

Table 2: Material specification for NRVA check valves

No.	Part	Material	DIN	ISO	ASTM
1	Housing	Steel	G20Mn5QT <sup>(1)</sup> EN10213-3 P285QH EN10222-4		LCC, A352 LF2, A350
2	Flanges	Steel	RSt. 37-2, 10025	Fe360 B, 630	Grade C, A 283
3	Valve cone	Stainless steel Teflon			
5	Spring	Steel			
9	Bolts	Stainless steel	A2-70		
10	Nut	Stainless steel			
11	Gasket	Non asbestos			
12	Valve seat	Steel			

<sup>(1)</sup> NRVA 40 / NRVA 50 housing material is TTSt 35N until January 2006

### Connections

**There is a wide range of connection possibilities with NRVA check valves:**

## Check valve, Type NRVA

- Welding, DIN (2448)
- Welding, ANSI (B 36.10)
- Welding socket, ANSI (B 16.11)
- Solder connection, DIN (2856)
- Solder connection, ANSI (B 16.22)
- FPT internal thread, NPT (ANSI/ASME B 1.20.1)

### Flange connections

Danfoss flange sets excluding gaskets, bolts and nuts, are specially made for the Danfoss product range and must only be used for the purpose described.

Select the valve based on capacity and then select the size of flanges most suitable for the application, which can be mounted on the valve.

Table 3: Flange connections

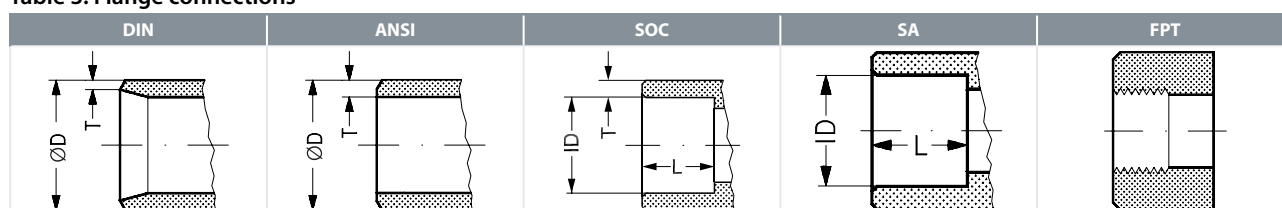

### Dimensions and weights

Figure 2: Dimensions and weights

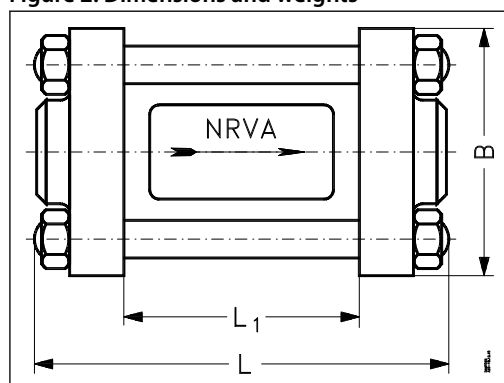

Table 4: Dimensions and weights

Type		L	L <sub>1</sub> <sup>(1)</sup>	B	Weight
NRVA 15 – 20	mm	115	50	80	1.4 kg
	in.	4.53	1.97	3.15	3.09 lb
NRVA 25 – 32	mm	138	74	Ø 83	3.0 kg
	in.	5.43	2.91	Ø 3.27	6.61 lb
NRVA 40 – 50	mm	172	94.5	Ø 103	5.0 kg
	in.	6.77	3.72	Ø 4.05	11.02 lb
NRVA 65	mm	226	124	Ø 185	13.0 kg
	in.	8.9	4.88	Ø 7.28	28.66 lb

<sup>(1)</sup> Without flanges

## Ordering

### Ordering Flange connections

Table 5: Butt welding DIN (2448)

For use with valve housing size	Size mm	Size in.	ØD mm	T mm	ØD in.	T in.	Flange type	Code no.
NRVA 15/20	10	3/8	18	2	0.71	0.079	1.3	027N1112
NRVA 15/20	15	1/2	22	2.5	0.866	0.098	1.3	027N1115
NRVA 15/20	20	3/4	26.9	2.3	1.059	0.091	1.3	027N1120
NRVA 25/32	25	1	33.7	2.6	1.327	0.103	4	027N1026
NRVA 25/32	32	1 1/4	42.4	2.6	1.669	0.102	4	027N1033
NRVA 40/50	40	1 1/2	48.3	2.6	1.902	0.103	6	027N1042
NRVA 40/50	50	2	60.3	2.9	2.37	0.11	6	027N1051
NRVA 65	65	2 1/2	76.1	2.9	3	0.11	8	027N1055

Table 6: Butt welding ANSI B 36.10

For use with valve housing size	Size mm	Size in.	ØD mm	T mm	ØD in.	T in.	Flange type	Code no.
NRVA 15/20	10	3/8	17.2	3.2	0.677	0.126	1.3	027N2020
NRVA 15/20	15	1/2	21.3	3.7	0.839	0.146	1.3	027N2021
NRVA 15/20	20	3/4	26.9	4	1.059	0.158	1.3	027N2022
NRVA 25/32	25	1	33.7	4.6	1.327	0.181	4	027N2023
NRVA 25/32	32	1 1/4	42.4	4.9	1.669	0.193	4	027N2024
NRVA 40/50	40	1 1/2	48.3	5.1	1.902	0.201	6	027N2025
NRVA 40/50	50	2	60.3	3.9	2.37	0.15	6	027N2026
NRVA 65	65	2 1/2	73	5.2	3	0.2	8	027N2027

Table 7: Socket welding ANSI (B 16.11)

For use with valve housing size	Size mm	Size in.	ID mm	T mm	ID in.	T in.	L mm	L in.	Flange type	Code no.
NRVA 15/20	10	3/8	17.8	4.1	0.701	0.161	10	0.394	1.3	027N2010
NRVA 15/20	15	1/2	22	4.8	0.866	0.189	10	0.394	1.3	027N2011
NRVA 25/32	20	3/4	27.4	5	1.079	0.197	13	0.512	4	027N2012
NRVA 25/32	25	1	34.1	5.8	1.343	0.228	13	0.512	4	027N2013
NRVA 25/32	32	1 1/4	42.9	6	1.689	0.236	13	0.512	4	027N2016
NRVA 40/50	40	1 1/2	49	6.5	1.929	0.254	13	0.512	6	027N2015

Table 8: Soldering DIN (2856)

For use with valve housing size	Size mm	ID mm	L mm	Flange type	Code no.
NRVA 15/20	16	16.07	15	1.3	027L1116
NRVA 15/20	22	22.08	22	1.3	027L1122
NRVA 25/32	35	35.07	25	4	027L2335
NRVA 40/50	54	54.09	33	4	027L2554

Table 9: Soldering (ANSI B 16.22)

For use with valve housing size	Size in.	ID in.	L in.	Flange type	Code no.
NRVA 15/20	5/8	0.628	0.807	1.3	027L1117
NRVA 15/20	7/8	0.878	0.866	1.3	027L1123
NRVA 25/32	1 3/8	1.375	0.984	4	027L2335
NRVA 40/50	2 1/8	2.125	1.3	4	027L2554

Table 10: FPT inside pipe thread, NPT (ANSI/ASME B 1.20.1)

For use with valve housing size	Size mm	Size in.	Inside pipe thread	Flange type	Code no.
NRVA 15/20	10	3/8	(3/8 × 18 NPT)	1.3	027G1005
NRVA 15/20	15	1/2	(1/2 × 14 NPT)	1.3	027G1006
NRVA 25/32	20	3/4	(3/4 × 14 NPT)	4	027G1007

**NOTE:**

The flanges sets are exclusive gaskets, bolts and nuts.

## Ordering complete Valves

Figure 3: Complete valves

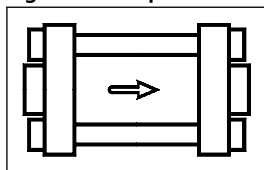

Table 11: Complete valves incl. DIN 2448 flange:

Type	Weld flange connection in.	Code no.		$\Delta p$ <sup>(1)</sup>				$k_v$ value <sup>(2)</sup> m <sup>3</sup> /h	$C_v$ value <sup>(3)</sup> gal/min
		Valve	Spec. spring <sup>(4)</sup>	With standard spring		With spec. spring <sup>(4)</sup>			
				bar	psig	bar	psig		
NRVA 15	1/2	020-2000	020-2307	0.12	1.7	0.3	4.4	5	6
NRVA 20	3/4	020-2001	020-2307	0.12	1.7	0.3	4.4	6	7
NRVA 25	1	020-2002	020-2317	0.12	1.7	0.3	4.4	19	22
NRVA 32	1 1/4	020-2003	020-2317	0.12	1.7	0.3	4.4	20	23
NRVA 40	1 1/2	020-2004	020-2327	0.07	1	0.4	5.8	44	51
NRVA 50	2	020-2005	020-2327	0.07	1	0.4	5.8	44	51
NRVA 65	2 1/2	020-2006	020-2337	0.07	1	0.4	5.8	75	87

<sup>(1)</sup>  $\Delta p$  = the minimum pressure differential at which the valve is completely open

<sup>(2)</sup> The  $k_v$  value is the flow of water in m<sup>3</sup>/h at a pressure drop across valve of 1 bar,  $\rho = 1000 \text{ kg/m}^3$ .

<sup>(3)</sup> The  $C_v$  value is the flow of water in gal/min at a pressure drop across valve of 1 psig,  $\rho = 10 \text{ lbs/gal}$ .

<sup>(4)</sup> A special type spring can be supplied to replace the standard valve spring

Figure 4: Valve body without flanges

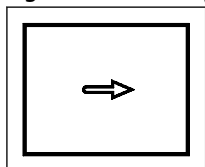

Table 12: Valve body without flanges

Type	Code no.
NRVA 15	020-2020
NRVA 20	020-2020
NRVA 25	020-2022
NRVA 32	020-2022
NRVA 40	020-2024
NRVA 50	020-2024
NRVA 65	020-2026

Figure 5: Staybolts and gaskets

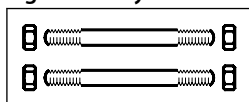

Table 13: Staybolts and gaskets

Type	Dimensions	Code no.
NRVA 15 / 20	M 12 x 115 mm	006-1107
NRVA 25 / 32	M 12 x 148 mm	006-1135
NRVA 40 / 50	M 12 x 167 mm	006-1137
NRVA 65	M 16 x 200 mm	006-1138

### Example:

NRVA 32 with 1 1/4" flanges for ANSI butt welding: NRVA 32 + bolts + flanges (set) = 020-2022 + 006-1135 + 027N2024

## Certificates, declarations, and approvals

The list contains all certificates, declarations, and approvals for this product type. Individual code number may have some or all of these approvals, and certain local approvals may not appear on the list.

Some approvals may change over time. You can check the most current status at [danfoss.com](http://danfoss.com) or contact your local Danfoss representative if you have any questions.

**Table 14: Valid approvals**

File name	Document type	Document topic	Approval authority
RU Д-ДК.БЛ08.В.03644	EAC Declaration	Machinery & Equipment	EAC
0045 202 1204 Z 00354 19 D 001(00)	Pressure - Safety Certificate	TÜV	
RU Д-ДК.РА01.В.72124_20	EAC Declaration	PED	EAC
EU 033F0685.AK	EU Declaration	EMCD/PED	Danfoss
AQSIQ TS271067J-2023	Manufacturing Permission	TSG	
MD 033F0691.AE	Manufacturers Declaration	RoHS	Danfoss
MD 033F0686.AH	Manufacturers Declaration	PED	Danfoss
033F0453.AD	Manufacturers Declaration	ATEX	Danfoss
CRN.0C21115.512346789YTN	Pressure - Safety Certificate	CRN	TSSA

## Online support

Danfoss offers a wide range of support along with our products, including digital product information, software, mobile apps, and expert guidance. See the possibilities below.

### The Danfoss Product Store



The Danfoss Product Store is your one-stop shop for everything product related—no matter where you are in the world or what area of the cooling industry you work in. Get quick access to essential information like product specs, code numbers, technical documentation, certifications, accessories, and more.

Start browsing at [store.danfoss.com](https://store.danfoss.com).

### Find technical documentation



Find the technical documentation you need to get your project up and running. Get direct access to our official collection of data sheets, certificates and declarations, manuals and guides, 3D models and drawings, case stories, brochures, and much more.

Start searching now at [www.danfoss.com/en/service-and-support/documentation](https://www.danfoss.com/en/service-and-support/documentation).

### Get local information and support



Local Danfoss websites are the main sources for help and information about our company and products. Find product availability, get the latest regional news, or connect with a nearby expert—all in your own language.

Find your local Danfoss website here: [www.danfoss.com/en/choose-region](https://www.danfoss.com/en/choose-region).

### Danfoss Learning



Danfoss Learning is a free online learning platform. It features courses and materials specifically designed to help engineers, installers, service technicians, and wholesalers better understand the products, applications, industry topics, and trends that will help you do your job better.

Create your Danfoss Learning account for free at [www.danfoss.com/en/service-and-support/learning](https://www.danfoss.com/en/service-and-support/learning).

### Spare Parts



Get access to the Danfoss spare parts and service kit catalog right from your smartphone. The app contains a wide range of components for air conditioning and refrigeration applications, such as valves, strainers, pressure switches, and sensors.

Download the Spare Parts app for free at [www.danfoss.com/en/service-and-support/downloads](https://www.danfoss.com/en/service-and-support/downloads).

### Coolselector®2 - find the best components for you HVAC/R system



Coolselector®2 makes it easy for engineers, consultants, and designers to find and order the best components for refrigeration and air conditioning systems. Run calculations based on your operating conditions and then choose the best setup for your system design.

Download Coolselector®2 for free at [coolselector.danfoss.com](https://coolselector.danfoss.com).

### Danfoss A/S

Climate Solutions • [danfoss.com](https://danfoss.com) • +45 7488 2222

Any information, including, but not limited to information on selection of product, its application or use, product design, weight, dimensions, capacity or any other technical data in product manuals, catalogues descriptions, advertisements, etc. and whether made available in writing, orally, electronically, online or via download, shall be considered informative, and is only binding if and to the extent, explicit reference is made in a quotation or order confirmation. Danfoss cannot accept any responsibility for possible errors in catalogues, brochures, videos and other material. Danfoss reserves the right to alter its products without notice. This also applies to products ordered but not delivered provided that such alterations can be made without changes to form, fit or function of the product.

All trademarks in this material are property of Danfoss A/S or Danfoss group companies. Danfoss and the Danfoss logo are trademarks of Danfoss A/S. All rights reserved.