



Danfoss

ENGINEERING
TOMORROW

Facts Worth Knowing about AC Drives

More than

50

years of
leadership
in drives

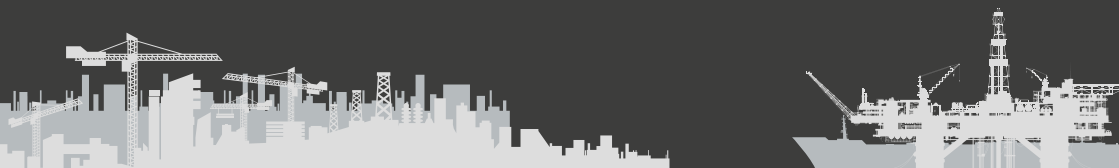
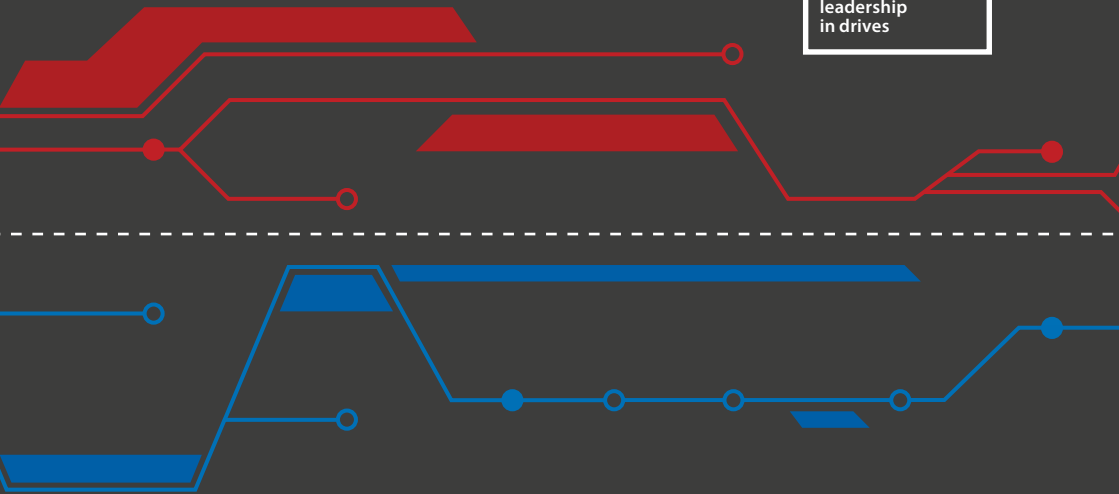

drives.danfoss.com

More than

50

years of leadership
in drives



Preface

In 1968, Danfoss was the first company in the world to commence mass production of AC drives, for variable speed control of three-phase induction motors.

Today AC drives are an increasingly important component for optimizing motor operation, and the system attached to the motor. AC drives are now used in an expanding range of applications, with the following main objectives in mind:

- Energy efficiency optimization: Converting from fixed to variable speed in applications with varying load, delivers significant energy savings. In fact, these days, modern motor technology always requires advanced control in order to run optimally at all speeds.
- Factory automation: Continuously escalating demand for factory throughput leading to a higher degree of automation implies a growing need for variable speed solutions.
- Process control and optimization: Improved process control often requires variable speed motor control and leads to more precise control, higher throughput, or comfort, depending on the application.
- Hybridization: Solving issues in power demand in the most cost effective and suitable manner by means of energy storage.



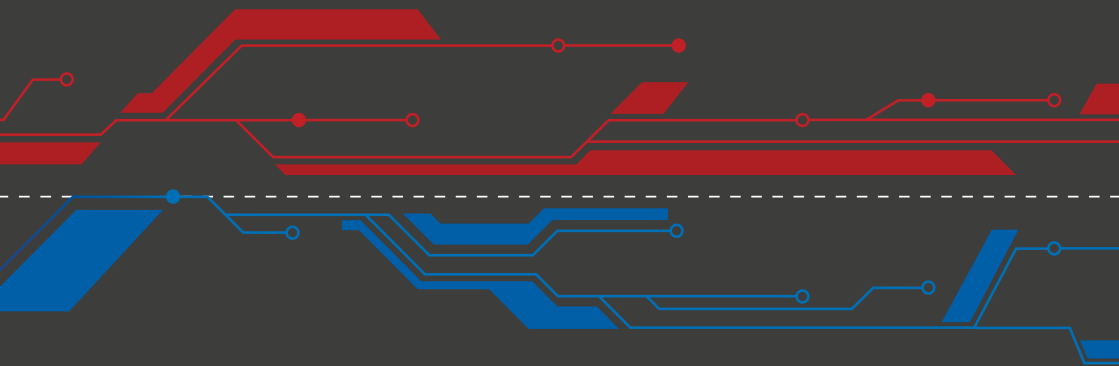

The fundamentals of AC drive technology persist, but many elements are also rapidly changing. Increasingly, software is embedded in today's products, offering new functionalities and enabling the AC drive to play a larger role in the system. New motor types are appearing, placing additional demands on motor control. This in turn means the AC drive must be able to control an expanding variety of motor types, without burdening the end user with more complexity. In addition, new energy efficiency requirements lead to more variable speed applications, eventually making all motors

variable speed and controlled by an AC drive. With this latest update of "Facts worth knowing about AC drives", we at Danfoss would like to continue the heritage from previous versions of this book. We are proud of what we do and are enthusiastic about AC drives. With this book we hope to convey some of this enthusiasm to you! If you would like to learn more, please feel free to contact Danfoss.



*Jakob Fredsted
Senior Vice President
Danfoss Drives Technology*

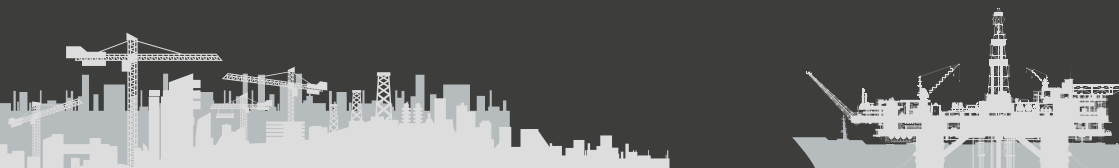

01

INTRODUCTION

PAGE 12-15

02

ELECTRIC
MOTORS

PAGE 16-45

03

AC DRIVES

PAGE 46-85

04

VARIABLE SPEED
MOTOR DRIVE
OPERATION

PAGE 86-121

05

SAVING ENERGY
WITH
AC DRIVES

PAGE 114-139



06

ELECTRO-
MAGNETIC
COMPATIBILITY

PAGE 132-151

07

PROTECTION
AGAINST
ELECTRIC SHOCK
AND ENERGY
HAZARDS

PAGE 152-163

08

MAINS
INTERFERENCE

PAGE 164-177

09

INTERFACES

PAGE 178-189

10

SIZING AND
SELECTION OF
AC DRIVES

PAGE 190-207



Content

1	Introduction.....	12
1.1	Terminology.....	13
1.2	Why use Speed Control?.....	13
1.3	How to Adjust the Motor Speed.....	14
1.4	AC Drives.....	14
1.5	System Optimization.....	15
2	Electric Motors.....	17
2.1	Overview.....	17
2.2	Fundamentals.....	18
2.2.1	Stator and Rotor.....	18
2.2.2	Power and Torque.....	18
2.2.3	AC and DC Motors.....	19
2.2.4	Electromagnetic Induction.....	20
2.2.5	Poles, Synchronous Speed and Asynchronous Speed.....	21
2.2.6	Efficiency and losses.....	22
2.3	Induction Motors.....	23
2.3.1	Rotating Field.....	23
2.3.2	Squirrel-cage Motor.....	25
2.3.3	Slip, Torque and Speed.....	26
2.3.4	Typical Operating Conditions.....	28
2.3.5	Changing Speed.....	30
2.3.6	Motor Nameplate and Star or Delta Configuration.....	32
2.4	Synchronous Motors.....	34
2.4.1	Permanent Magnet (PM) Motors.....	35
2.4.1.1	Back EMF.....	36
2.4.1.2	Torque and Speed Range.....	37
2.4.2	Brushless DC (BLDC) or Electronically Commutated (EC) Motors.....	38
2.4.3	Line Start PM Motor (LSPM Motor).....	39
2.4.4	Reluctance Motors.....	40
2.4.5	Synchronous Reluctance Motor with Squirrel Cage.....	41
2.4.6	Synchronous Reluctance Motor (SynRM).....	42
2.4.7	Permanent Magnet Assisted Synchronous Reluctance Motor (PMASynRM).....	43
2.4.8	Switched Reluctance Motor (SRM).....	44
2.5	Medium Voltage Motors.....	45

3 AC Drives	47
3.1 Direct Converters	47
3.2 AC Drives with an Intermediate Circuit.....	48
3.3 Rectifier.....	50
3.3.1 Uncontrolled Rectifiers	50
3.3.2 Semi-controlled Rectifiers.....	51
3.3.3 Fully-controlled Rectifiers.....	52
3.3.4 Active Front-End/Active Infeed	53
3.4 Intermediate Circuit	53
3.4.1 Variable Intermediate Circuit	53
3.4.2 Constant Intermediate Circuit.....	55
3.4.3 Capacitorless Intermediate Circuit	56
3.4.4. Common DC Bus.....	56
3.5 Inverter	57
3.6 Modulation Principles.....	60
3.6.1 Pulse Amplitude Modulation (PAM)	60
3.6.2 Pulse width Modulation (PWM)	60
3.6.3 Asynchronous PWM.....	62
3.6.3.1 SFAVM.....	63
3.6.3.2 60° AVM	63
3.7 Control Circuit and Methods.....	66
3.7.1 Simple Control Method.....	69
3.7.2 Scalar Control with Compensation	70
3.7.3 Space Vector with and without Feedback.....	71
3.7.3.1 Space Vector (Open Loop).....	71
3.7.3.2 Space Vector (Closed Loop).....	72
3.7.4 Open Loop and Closed Flux Vector Control	72
3.7.4.1 Flux Vector (Open Loop).....	72
3.7.4.2 Flux Vector (Closed Loop)	73
3.7.5 Servo Drive Control.....	74
3.7.6 Integrated Motion Controller	74
3.7.7 Control Conclusions	75
3.8 Danfoss Control Principles	75
3.8.1 Danfoss VVC+ Control Principle	76
3.8.2 Danfoss Flux Vector Control Principle.....	80
3.9 Medium Voltage Drives.....	80
3.9.1 MV Semiconductors.....	81
3.9.2 MV Drive Topologies.....	81
3.10 Standards and Legislation	84

4	Star and Delta Configuration in Field Weakening Operation	87
4.1	Basic Principles	87
4.1.1	U/f Operation and Field Weakening.....	87
4.1.2	Star and Delta Configuration in Field Weakening Operation	88
4.1.3	Running in Current Limit.....	90
4.2	Compensations.....	90
4.2.1	Load-independent Start Compensations	90
4.2.2	Load-dependent Start Compensations	91
4.2.3	Load Compensations.....	92
4.2.4	Slip Compensations.....	92
4.2.5	PM Motor and SynRM compensations	92
4.3	Danfoss Automatic Motor Adaption (AMA)	93
4.4	Operation.....	94
4.4.1	Motor Speed Control	94
4.4.2	Reversing.....	95
4.4.3	Acceleration and Deceleration Ramps (Ramp Up and Down).....	96
4.4.4	Motor Torque Control.....	98
4.4.5	Watchdog.....	98
4.4.6	Energy Efficient Motor Start.....	99
4.4.7	Energy Efficient Motor Control.....	101
4.5	Dynamic Brake Operation	103
4.5.1	Extending Deceleration Ramp.....	104
4.5.2	Motor as a Braking Resistor.....	104
4.5.3	Brake Chopper Circuit (Brake Module) and Resistor.....	104
4.5.4	Use of a Regenerative Braking Unit	105
4.6	Static Brake Operation	106
4.6.1	Coasting to Stop.....	106
4.6.2	DC Braking.....	106
4.6.3	DC Hold.....	106
4.6.4	Electromechanical Brake	107
4.7	Motor Heating and Thermal Monitoring	107
4.8	Functional Safety.....	109
5	Saving Energy with AC Drives	115
5.1	Potential.....	115
5.2	Motor + AC Drives Efficiency.....	115
5.3	Classification of Energy Efficiency Componenets.....	117
5.4	Load over Time	121
5.4.1	Applications with Variable Torque.....	121
5.4.2	Applications with Constant Torque.....	123
5.5	Life Cycle Costs.....	124
5.6	System Savings.....	124
5.7	Using Regenerated Power	126
5.8	Hybridization	128
5.8.1	Grid Converter.....	130
5.8.2	DC/DC Converter	130

6	Electromagnetic Compatibility	133
6.1	EMI and EMC.....	133
6.2	EMC and AC Drives.....	134
6.3	Grounding and Shielding.....	136
6.4	Installations with AC Drives.....	140
6.5	Output filters.....	141
6.1.1	dU/dt filters.....	142
6.1.2	Shine-wave filter.....	143
6.1.3	Common-mode Filter.....	144
6.6	Bearing electric stress.....	145
6.7	European EMC Directive and EMC Standards.....	149
7	Protection against Electric Shock and Energy Hazards.....	153
7.1	General.....	153
7.2	Mains Supply System.....	154
7.3	DC Supply Systems.....	157
7.4	Ground Fault Protection.....	158
7.5	Fuses and Circuit Breakers.....	160
7.6	DC Guard for Common DC Bus Systems.....	162
8	Harmonics.....	165
8.1	What are Harmonics?.....	165
8.1.1	Linear Loads.....	165
8.1.2	Non-linear Loads.....	166
8.1.3	The Effect of Harmonics in a Power Distribution System.....	168
8.1.4	The Effects of Harmonics on Motors.....	170
8.2	Harmonic Limitation Standards and Requirements.....	170
8.3	Harmonic Reduction Methods in AC Drives.....	171
8.3.1	Passive Harmonic Mitigation.....	173
8.3.2	Active Harmonic Mitigation.....	174
8.4	Harmonic Analysis Tools.....	175
8.4.1	VLT® Motion Control Tool MCT 31.....	176
8.4.2	Harmonic Calculation Software (HCS).....	176
9	Interfaces	179
9.1	Human Machine Interface (HMI).....	179
9.2	Operating Principles of Serial Interfaces.....	181
9.3	Standard Serial Interfaces in AC Drives.....	183
9.4	Fieldbus Interfaces in AC Drives.....	184
9.5	Fieldbuses Standardisation.....	185
9.6	Industrial Ethernet and the Internet of Things.....	187

10 Sizing and Selection of AC Drives	191
10.1 Get the Drive Rating Right.....	191
10.2 Rating of the Frequency Converters from Motor Specification.....	191
10.3 Overload Capacity.....	193
10.3.1 Energy Efficiency Concerns.....	194
10.4 Control Range.....	195
10.5 Heat Losses and Cooling the Drive.....	196
10.5.1 Air-Cooled Drives	197
10.5.2 Liquid-Cooled Drives	199
10.6 Derating of an AC Drive.....	200
10.7 Regenerative Energy.....	201
10.8 Motor Cables	201
10.9 Environment.....	202
10.10 Centralized versus Decentralized Installation.....	204
10.11 Examples	206



01

INTRODUCTION

1	Introduction.....	13
1.1	Terminology	13
1.2	Why use Speed Control?	13
1.3	How to Adjust the Motor Speed	14
1.4	AC Drives.....	14
1.5	System Optimization	15

1 Introduction

By definition, an AC drive (or drive) is an electronic device that converts alternating current (AC) of a fixed frequency to any frequency. Traditionally, these devices were electro-mechanical machines (motor-generator set). Those are sometimes referred to as “dynamic” drives. With the invention of solid state electronics, it has become possible to build 100% electronic drives, which are often referred to as “static” drives (no moving parts).

Whilst the principle of converting fixed mains voltage and frequency into variable quantities has always remained virtually the same, there have been many improvements from the first AC drives, which featured thyristors and analogue technology, to today’s microprocessor-controlled, digital units.

Because of the ever-increasing degree of automation in industry, there is a constant need for more automated control and a steady increase in production speeds, so better methods to further improve the efficiency of production plants are being developed all the time.

Today, the drive-controlled, three-phase motor is a standard element in all automated applications. High-efficiency induction motors, but especially motor designs such as permanent magnet motors, EC motors and synchronous reluctance motors, need regulation with AC drives, many motors cannot even be operated directly from the 3-phase standard power supply.

1.1 Terminology

Different terminologies are used for systems that can control or alter the speed of electrical motors. The most commonly used ones are:

- AC Drive
- Frequency Converter (FC)
- Variable Speed Drive (VSD)
- Adjustable Speed Drive (ASD)
- Adjustable Frequency Drive (AFD)
- Variable Frequency Drive (VFD)

While VSD and ASD refer to speed control in general, AFD, VFD and FC are directly connected to adjusting the feeding frequency of a motor. In this context, AC drive and the abbreviation “drive” are used as well. These two terms will be widely used throughout this book. This wording covers the power electronic part of the devices and the supporting components like current sensors, I/Os and Human Machine Interface (HMI).

1.2 Why Use Speed Control?

There are numerous reasons for adjusting the speed of an application:

- Save energy and improve efficiency of systems
- Match the speed of the drive to the process requirements

- Match the torque or power of a drive to the process requirements
- Improve the working environment
- Reduce mechanical stress on machines
- Lower noise levels, for example on fans and pumps

Depending on the application one or the other benefit is predominant. However, speed control is proven to bring significant advantages in many different applications.

1.3 How to Adjust the Motor Speed?

There are three main technologies to realize speed control used in industry. Each has its unique features:

Hydraulic

- Hydro-dynamic type
- Static types

They are often favored in conveyor applications especially for earth-moving and mining equipment. This is basically due to inherent “soft start” capability of the hydraulic unit.

Mechanical

- Belt and chain drives (with adjustable diameters).
- Friction drives (metallic)
- Variable speed gear

Mechanical solutions are still favored by many engineers – especially mechanical engineers – for some applications, mainly because of their simplicity and low purchase price.

Electrical

- AC drive with electrical motor
- Servo systems (for example servo amplifier and servo PM motor)
- DC motor with control electronics
- Slip-ring motor (slip control with wound-rotor induction motor)

Historically, electrical devices for speed control were complex to handle and expensive. They were used for the most challenging tasks where no alternatives were available.

The provided list of technical solutions for speed control of motors is not exhaustive and shall give an insight of the possibilities only. This book will focus on speed control of electrical motors by AC drives.

1.4 AC Drives

Modern AC drives can be applied to adjust and maintain the speed or torque of a driven machine with an accuracy of $\pm 0.5\%$. This is independent of the load when compared to fixed

speed operation of the induction motor, where the speed can vary by as much as 3 – 5% (slip) from no-load to full-load operation.

Motor manufacturers employ a variety of concepts to achieve high efficiency in electrical motors. For users it can be difficult to see the main benefit from one technology to another, but the user will surely observe that energy efficient motors need high technology controls.

In principle, nearly all motors can be operated with control algorithms specially adapted to each motor type. Some manufacturers of AC drives relate their design to a narrow group of motor technologies, but many manufacturers have the different algorithms built-in and selectable during commissioning.

For the commissioner it is important that the drive is easy to commission based on the data, which is normally available for the used motor type. After commissioning the user must be confident that the system is really set up as expected, thus online measurements of actual energy consumption and easy access to important data about the operation is essential.

1.5 System Optimization

To ease the selection of components and ensure the various Government aims to reduce energy consumption, there is a big motivation for a complete set of international regulations.

According to the German Association of Electrical and Electronics Manufacturers (ZVEI), approximately 10% of the savings can be achieved by using high-efficiency motors, 30% of the savings are achieved by variable speed, but as much as 60% of the potential savings are achieved by looking at the overall system and optimizing accordingly.

With that in mind, please read all chapters in this book and remember you cannot judge a system by looking at only one or few of the components involved.

We wish you an interesting read.

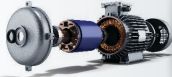

02

ELECTRIC MOTORS

2	Electric Motors.....	17
2.1	Overview.....	17
2.2	Fundamentals.....	18
2.2.1	Stator and Rotor.....	18
2.2.2	Power and Torque.....	18
2.2.3	AC and DC Motors.....	19
2.2.4	Electromagnetic Induction.....	20
2.2.5	Poles, Synchronous Speed and Asynchronous Speed.....	21
2.2.6	Efficiency and losses.....	22
2.3	Induction Motors.....	23
2.3.1	Rotating Field.....	23
2.3.2	Squirrel-cage Motor.....	25
2.3.3	Slip, Torque and Speed.....	26
2.3.4	Typical Operating Conditions.....	28
2.3.5	Changing Speed.....	30
2.3.6	Motor Nameplate and Star or Delta Configuration.....	32
2.4	Synchronous Motors.....	34
2.4.1	Permanent Magnet (PM) Motors.....	35
2.4.1.1	Back EMF.....	36
2.4.1.2	Torque and Speed Range.....	37
2.4.2	Brushless DC (BLDC) or Electronically Commutated (EC) Motors.....	38
2.4.3	Line Start PM Motor (LSPM Motor).....	39
2.4.4	Reluctance Motors.....	40
2.4.5	Synchronous Reluctance Motor with Squirrel Cage.....	41
2.4.6	Synchronous Reluctance Motor (SynRM).....	42
2.4.7	Permanent Magnet Assisted Synchronous Reluctance Motor (PMaSynRM).....	43
2.4.8	Switched Reluctance Motor (SRM).....	44
2.5	Medium Voltage Motors.....	45

2 Electric Motors

2.1. Overview

An electric motor is an electromechanical device that converts electrical energy into mechanical energy. The reverse process of producing electrical energy from mechanical energy is performed by a generator.

The operating demands of the electric motor, especially in industry, have been enormous. Robustness, reliability, size, energy efficiency, and price are only some of these criteria. The differing needs have resulted in the development of different types of electric motors. The following diagram gives a general overview of the most commonly used electric motor technologies.

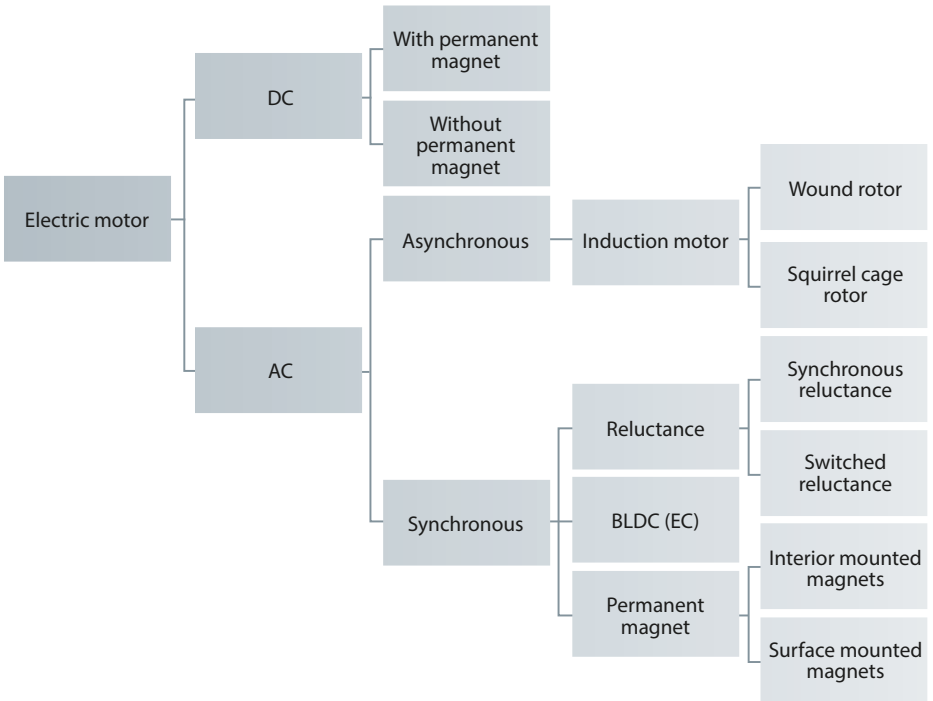

Fig. 2.1 Overview of the most common electric motor technologies

2.2 Fundamentals

2.2.1 Stator and Rotor

The construction of all rotating electric motors consists in principle of two main components.

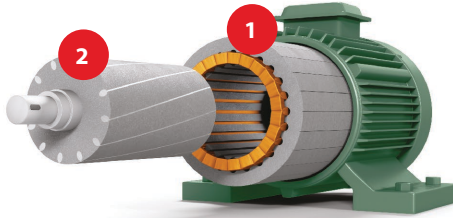

Fig. 2.2 Construction of the induction motor

Stator

The stator (1) is the stationary part of the motor which holds packages of laminations where the electrical windings are placed.

Rotor

The rotor (2) is the rotating part of the motor which is mounted on the motor shaft. Like the stator, the rotor is made of thin iron laminations which hold the rotor windings.

One variation is the outer rotor motor. Unlike the inner rotor design, the stator is placed in the middle of the motor and the rotor rotates around the stator. This construction is used in some fan applications where the fan blades are directly mounted on the rotor. Unless otherwise mentioned, all the following explanations are related to inner rotor design.

The connection dimensions of typical industrial motors are defined in IEC standards. However not all motors fulfill these requirements. For example, NEMA frame motor dimensions differ from IEC standards, due to the conversion from the metric to the imperial system.

2.2.2 Power and Torque

The rated output of electric motors is defined within a standard range. This standardization allows users to choose between different motor manufacturers for specific applications. The "standard" output range and its increments differ from country to country and region to region. It is recommended to find out what manufacturers define as standard in their catalogues. On average, motors with frame size up to 355 (ca. 400 kW) can be regarded as standard motors with standard dimensions.

Horsepower [hp] is the imperial unit used for motor power. If this unit is specified, it can be converted as follows: 1 hp = 0.736 kW or 1 kW = 1.341 hp.

Table 2.1 shows the typical industrial standard rated output power in [kW] and [hp].

kW	0.18	0.25	0.37	0.55	0.75	1.10	1.50	2.20	3.00	4.00	5.50	7.50	11.0
hp					1.00		2.00	3.00		5.00	7.00	10.00	15.0
kW	15.0	18.5	22.0	30.0	37.0	45.0	55.0	75.0	90.0	110.0	132.0	160.0	200.0
hp	20.0		30.0	40.0	50.0	60.0	75.0	100					

Table 2.1 Rated motor output power

Besides power, torque is an important characteristic of the motor. Torque indicates the strength of rotation of the motor shaft. Power has a direct relationship to torque and can be calculated when torque and speed are known.

$$P = T \times \frac{(2 \times \pi \times n)}{60 \times 1000} \approx \frac{(T \times n)}{9550}$$

P = Power [kW]

T = Torque [Nm]

n = Speed [RPM]

The factor 9550 used in the formula results from the conversion of units:

- Power from the base unit W (watt) to nameplate unit kW (kilowatt)
- Speed from the base unit rad/s (radians per second) to s⁻¹ (revolutions per second), and then to nameplate min⁻¹ (revolutions per minute)

2.2.3 AC and DC Motors

The first electric motor, a DC motor, was built around 1833. Speed control of this type of motor is simple and met the requirements of many different types of applications at the time. The DC motor is controlled by supplying a DC voltage whose magnitude influences the speed of the rotor. Voltage applied to stator and rotor windings results in magnetic fields which attract or repel each other, leading to rotor movement.

Energy supplied to the rotor is transmitted via brushes, typically made of graphite, to a commutator. The commutator ensures that the next winding is energized to achieve a continuous rotation. The brushes are subject to mechanical abrasion and require maintenance or periodic replacement. The importance of DC motors has decreased over time and they are rarely used in power ranges above a few hundred watts today.

Compared to DC motors, AC motors are much simpler and more robust. However, AC motors typically have a fixed speed and torque characteristic. Because of these fixed characteristics,

for many years AC motors could not be used for many diverse or special applications. They are nonetheless used in most applications to transform electrical energy into mechanical energy.

The functional principle of AC motors is based on the effects of a rotating magnetic field. The rotating field is generated either from a multi-phase fed AC source (typically three-phase) or from a single-phase source assisted by capacitors or inductances to achieve phase shift.

This book focuses on AC motors, particularly on induction motors, as the requirements for operation with AC drives in adjustable speed drive applications for various motor types can be derived from this motor technology. DC motors will not be addressed further.

2.2.4 Electromagnetic Induction

Most electric motors operate through the interaction of magnetic fields and current-carrying conductors to generate force. This is the reverse process of producing electrical energy from mechanical energy, performed by generators such as an alternator or a dynamo on a bicycle.

a) Generator principle, induction by motion

When a force (F) acts on a conductor and moves it across a magnetic field (B), a voltage is induced. If the conductor is part of a closed circuit, a current (I) flows, see Fig. 2.3 Principle for electromagnetic induction.

b) Motor principle

In motors, the induction principle is utilized in the reverse order: a force (F) is generated which will act on the current-carrying conductor, causing movement.

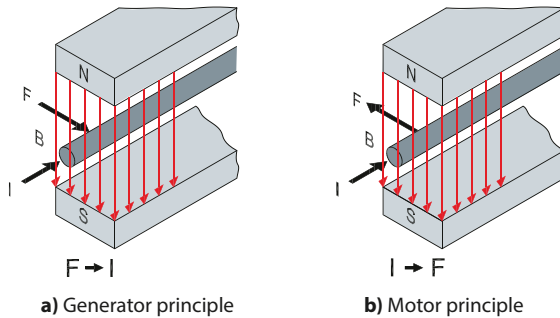

Fig. 2.3 Principle for electromagnetic induction

In both cases a magnetic field is required. In Fig. 2.3 Principle for electromagnetic induction the magnetic field originates from a permanent magnet, but in a motor the magnetic field is generated in the stator. Typically, this is achieved by applying voltage to the stator windings. The conductors affected by the electromagnetic force are located in the rotor.

2.2.5 Poles, Synchronous Speed and Asynchronous Speed

The synchronous speed of a motor can be calculated when the supply frequency and number of pole pairs are known.

$$n_0 = \frac{f \times 60}{p}$$

f = frequency [Hz]

n_0 = synchronous speed [min^{-1}]

p = pole pair number

While the frequency is determined by the grid or the AC drive, the number of poles is determined by the way the stator Inductors are connected.

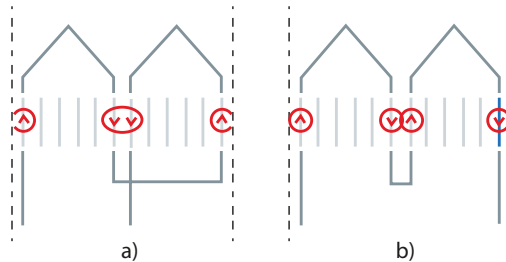

Fig. 2.4 Two Inductors in one phase connected in series to a) two poles b) four poles

Table 2.2 Pole pairs (p) or pole number and synchronous motor speed – lists the number of poles corresponding to synchronous speed (n_0) at 50 and 60 Hz supply. Higher pole numbers are possible but rarely used nowadays.

Pole pairs p	1	2	3	4	6
Pole number 2	2	4	6	8	12
n_0 [min^{-1}] (50 Hz supply)	3000	1500	1000	750	500
n_0 [min^{-1}] (60 Hz supply)	3600	1800	1200	900	600

Table 2.2 Pole pairs (p) or pole number and synchronous motor speed

Synchronous means “simultaneous” or “the same”. This means in synchronous motors the speed of the rotor is the same as the speed of the rotating field. If the rotor speed is affected by slip (see also section 2.3.3 Slip, Torque and Speed) and therefore lower than the speed of the rotating field, the motor is classified as asynchronous, meaning “not simultaneous” or “not the same”.

2.2.6 Efficiency and Losses

The motor draws electrical power from the mains. At a constant load, this power is greater than the mechanical power the motor can output to the shaft, due to various losses in the motor. The ratio between the output power P_2 and input power P_1 is the motor efficiency:

$$\eta = \frac{P_2}{P_1} = \frac{\text{output power}}{\text{input power}}$$

The efficiency depends on the motor principle, components (for example lamination quality), amount of active material (for example, due to lamination or use of magnets), size of the motor (rated power) and number of poles.

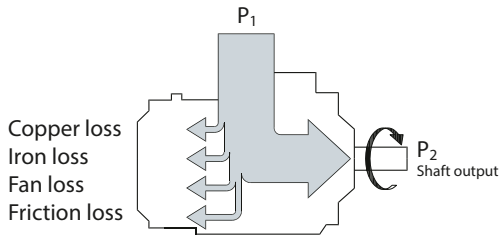

Fig. 2.5 Typical losses in the motor

The losses in the motor are illustrated in Fig. 2.5 Typical losses in the motor. The typical losses comprise:

- Copper losses because of the resistances of the stator and rotor windings
- Iron losses consisting of hysteresis losses and eddy-current losses

Hysteresis losses occur when iron is magnetized by an alternating current (AC).

The iron is magnetized and demagnetized repeatedly (that is, 100 times per second with a 50 Hz supply). Magnetizing and demagnetizing both require energy. The motor supplies power to cover the hysteresis losses, which increase with frequency and the strength of magnetic induction.

Eddy-current losses occur because the magnetic fields induce electric voltages in the iron core as in any other conductor (see Fig. 2.6 Eddy-currents are reduced by the laminated form of the motor core). These voltages produce currents that cause heat losses. The currents flow in circuits at right angles to the magnetic fields.

The eddy-current losses are dramatically reduced by dividing the iron core into thin laminations.

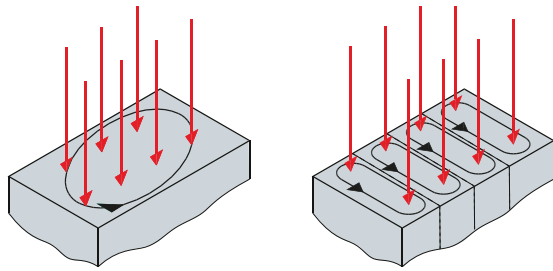

Fig. 2.6 Eddy-currents are reduced by the laminated form of the motor core

- Fan losses occur due to the air resistance of the motor fan
- Friction losses occur in the ball bearings holding the rotor

When determining the efficiency and motor output power, the losses in the motor are normally subtracted from the supplied power. The supplied power is measured, whereas the losses are often calculated or determined experimentally.

2.3 Induction Motors

To understand clearly how an adjustable speed drive system works, it is necessary to understand the principles of operation of this type of motor. Although the basic design has not changed much in the last decades, modern insulation materials, computer-based design optimization techniques as well as automated manufacturing methods have resulted in lower cost per kilowatt power and higher efficiency for a given motor frame size.

The information in this book will apply mainly to the so-called “squirrel-cage” three-phase induction motor, which is the type commonly used with AC drives.

2.3.1 Rotating Field

When applying a multi-phase AC source (typically three-phase) to a suitable winding system, a rotary magnetic field is generated which rotates in the air gap between the stator and the rotor. If one of the phase windings is connected to a supply phase, a magnetic field is induced.

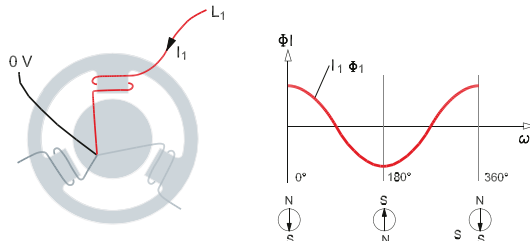

Fig. 2.7 One phase produces an alternating field

The magnetic field in the stator core has a fixed location, but its direction varies, as shown in Fig. 2.7 One phase produces an alternating field. The speed of rotation is determined by the supply frequency. At a frequency of 50 Hz, the field changes direction 100 times per second (two times per period).

If two phase windings are connected to the respective supply phases, two magnetic fields are induced in the stator core. In a two-pole motor, one field is displaced by 120 degrees relative to the other. The maximum field values are also displaced in time, as shown in Fig. 2.8 Two phases produce an asymmetrical rotating field.

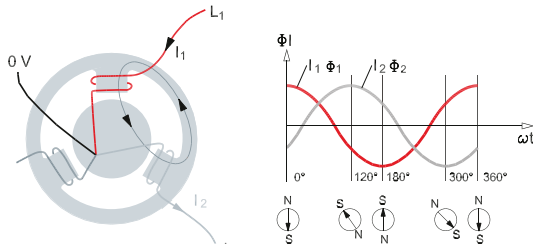

Fig. 2.8 Two phases produce an asymmetrical rotating field

This produces a rotating magnetic field in the stator which is highly asymmetrical until the third phase is connected. When the third phase is connected, there are three magnetic fields in the stator core. There is a 120° displacement between the three phases, as shown in Fig. 2.9 Three phases produce a symmetrical rotating field.

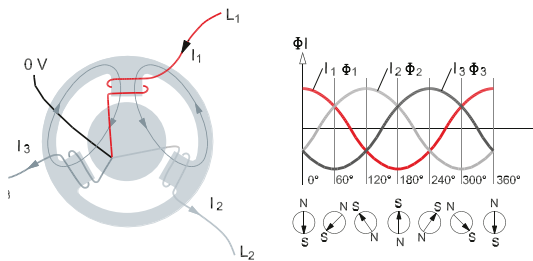

Fig. 2.9 Three phases produce a symmetrical rotating field

The stator is now connected to the three-phase supply. The magnetic fields of the individual phase windings form a symmetrical rotating magnetic field. This magnetic field is called the rotating field of the motor.

The amplitude of the rotating field (φ) is constant and 1.5 times the maximum value (φ_{max}) of the alternating fields. It rotates at the synchronous speed resulting from the pole pair number and supply frequency (see also section 2.3.3 Slip, Torque and Speed).

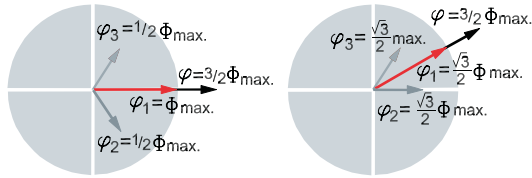

Fig. 2.10 Magnetic field components

The representation of the rotating field as a vector with a corresponding angular velocity describes a circle, shown in Fig. 2.10 Magnetic field components. The magnitude of the magnetic field ϕ as result of the components (ϕ_1 , ϕ_2 , ϕ_3) is constant also at different moments (a and b). Three sinusoidal fields with a 120-degree phase-shift make up a circular rotating magnetic field. The rotating field becomes elliptical if the amplitude changes during a rotation.

With single phase motors the phase shift which determines the rotation direction of the motor is created by a capacitor or an inductance which also results in an elliptical field.

2.3.2 Squirrel-cage Motor

The squirrel-cage rotor is the most frequently-used rotor type and is used in the squirrel-cage motor. Unlike the stator, where the inductors have many windings, in the squirrel-cage motor, only one winding is placed in the slots of the rotor lamination. This is typically done with aluminum or copper rods. The rods are short-circuited at each end of the rotor by a ring made of the same material. Copper has the advantage that it has a better conductivity than aluminum which results in lower losses and a higher efficiency. Drawbacks compared to aluminum are higher prices, lower starting torques and higher melting temperature which complicate the casting and leads to a higher tooling effort.

A variant of the squirrel-cage rotor is the slip-ring rotor which has wound inductors for each phase. The inductors are connected to slip-rings. Brushes sliding on the slip-ring allow the connection of external resistors which modifies the motor behavior (see also section 2.3.5 Changing Speed). If the slip-rings are short-circuited, the rotor acts as a squirrel-cage rotor.

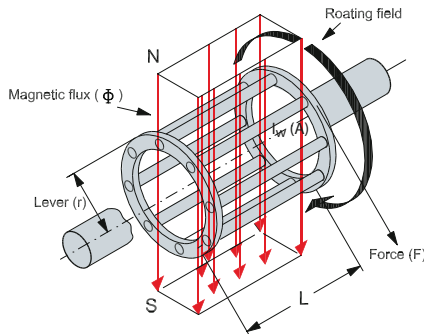

Fig. 2.11 Operational field and squirrel-cage rotor

The rotor movement of the squirrel-cage motor is created as follows:

A rotor rod placed in the rotating field is passed by a series of magnetic poles, as shown in Fig. 2.11. The magnetic field of each pole induces a current (I) in the rotor rod, which is influenced by a force (F). This force is determined by the flux density (B), the induced current (I), the length (L) of the rotor within the stator, and the angle (θ) between the force and the flux density. Assuming that $\theta = 90^\circ$, the force is:

$$F = B \times I \times L$$

The next pole passing the rod has an opposite polarity. It induces a current in the opposite direction to the previous one. Since the direction of the magnetic field has also changed, the force acts in the same direction as before as shown in Fig. 2.12b Induction in the rotor rods.

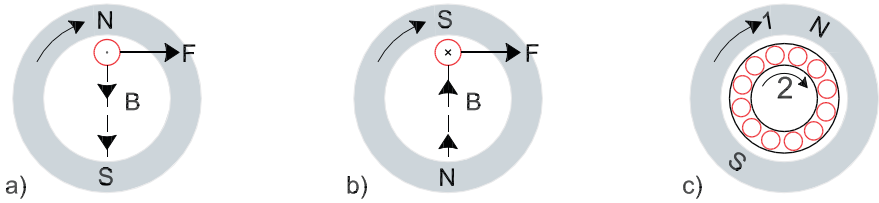

Fig. 2.12 Induction in the rotor rods

When the entire rotor is located in the rotating field, see Fig. 2.12c Induction in the rotor rods, the rotor rods are affected by forces that cause the rotor to rotate. The rotor speed (2) does not reach the speed of the rotating field (1) since no currents are induced in the cage bars when it is rotating at the same speed as the field.

2.3.3 Slip, Torque and Speed

As described in sections 2.2.5 Poles, Synchronous Speed and Asynchronous Speed and 2.3.2 Squirrel-cage Motor, under normal circumstances the rotor speed (n_n) of induction motors is slightly lower than the speed (n_0) of the rotating field. The difference between the speed of the rotating field and the rotor is called slip (s) where:

$$s_a = n_0 - n_n$$

The slip is often expressed as a percentage of the synchronous speed and is typically between 1 and 10 percent.

$$s = \frac{n_0 - n_n}{n_0} \times 100\%$$

The individual forces in the rotor rods combine to form the torque (T) on the motor shaft (see section 2.3.2 Squirrel-cage Motor). With a given value of force (F) and radius (r) the motor torque is: $T = F \times r$.

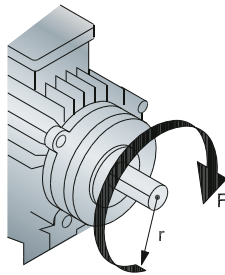

Fig. 2.13 Torque on the motor shaft is the force (F) x radius (r)

The relationship between motor torque, speed and current of induction motors has a characteristic curve, shown in Fig. 2.14 Principal motor current and torque characteristics. This curve depends on the rotor slot design and the rod material.

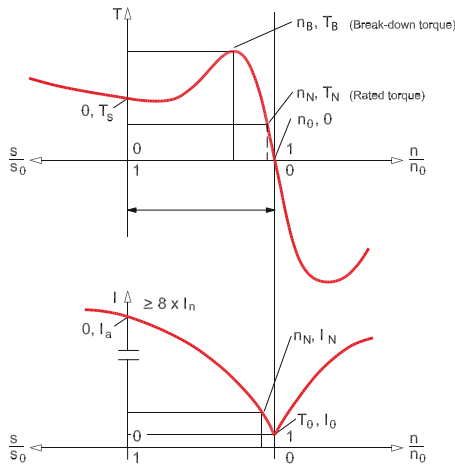

Fig. 2.14 Principal motor current and torque characteristics

The motor operating range ($0 < n/n_0 < 1$) can be split up into two ranges:

- Starting range ($0 < n/n_0 < n_B/n_0$)
- Operating range ($n_B/n_0 < n/n_0 < 1$)

These ranges have the following characteristics:

Starting torque T_S . This is the torque the motor produces with the rated voltage and rated frequency applied at standstill.

Stall torque T_B at stall speed n_B . This is the highest torque the motor can produce when the rated voltage and rated frequency are applied.

Rated motor torque T_n at nominal speed n_n .

The rated values of the motor are the mechanical and electrical values for which the motor was designed in accordance with the IEC 60034 standard. The rated values, also called motor specifications or motor ratings, are stated on the motor nameplate.

The rated values indicate the optimal operating point for the motor, when connected directly to the mains.

Apart from the normal motor operating range, there are two braking ranges.

- $n/n_0 > 1$: the motor is driven by the load above its synchronous speed (n_0) operating as a generator. In this region, the motor produces a counter torque and simultaneously returns power to the supply grid.
- $n/n_0 < 0$: braking is called regenerative braking or plugging.

If two phases of a motor are suddenly interchanged, the rotating field changes direction. Immediately afterwards, the speed ratio n/n_0 is 1. The motor, previously loaded with torque T , now brakes with its braking torque. If the motor is not disconnected at $n = 0$, it will continue to run in the new rotational direction of the magnetic field.

2.3.4 Typical Operating Conditions

In principle, induction motors have six inductors: three inductors in the stator and three inductors in the squirrel-cage rotor (which behaves magnetically as if it consisted of three inductors). A subset of these inductors can be used as the basis for generating an equivalent circuit that makes the operating principle of the motor easier to understand, especially when the frequency of the supply voltage changes.

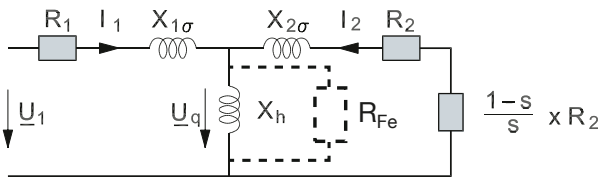

Fig. 2.15 Equivalent circuit diagram (one phase) for a motor operating under load

Applying a supply voltage (U_1) results in a current in the stator (I_1) and the rotor (I_2) which is limited by the resistance in stator (R_1) and rotor (R_2) and the reactance in stator ($X_1\sigma$) and rotor ($X_2\sigma$). While the resistance is independent of the supply frequency the reactance has an influence.

$$X_L = 2 \times \pi \times f \times L$$

X_L = reactance [Ω]

f = frequency [Hz]

L = inductance [H]

The inductors mutually influence each other by means of magnetic induction. The rotor inductor induces a current in the stator inductor and vice versa. This mutual effect means that the two electric circuits can be interconnected via a common element consisting of R_F and X_h , which are called the transverse resistance and reactance. The current the motor draws for magnetizing the stator and the rotor flows through this common element. The voltage drops across the "transverse link" is the induction voltage (U_q). As R_F is very small and is neglected in the following explanations.

Standard operation

When the motor operates in its normal operating range, the rotor frequency is, due to the slip, lower than the rotating field frequency. In the equivalent circuit diagram, the effect is described by a change in the rotor resistance R_2 by the factor $1/s$. R_2/s can be expressed as $R_2 + R_2 \times (1 - s)/s$ where $R_2 \times (1 - s)/s$ represent the mechanical motor load.

No-load situation

The slip s is small at no-load (idle) operation. This means that $R_2 \times (1 - s)/s$ is high. Consequently, almost no current can flow through the rotor. Ideally, this is comparable to removing the resistor that represents the mechanical load from the equivalent circuit.

The induced voltage (U_q) is often confused with the motor terminal voltage. This is due to the simplification of the equivalent circuit diagram to make it easier to understand various motor conditions. However, the induced voltage only approximately corresponds to the terminal voltage in no-load operation.

Locked rotor situation

The slip increases when the motor is operating under load. Therefore, $R_2 \times (1 - s)/s$ will decrease. When the rotor is locked the slip is 1 and hence the current which increases with the load reaches its maximum.

The equivalent circuit diagram thus corresponds to the conditions applicable to the induction motor in normal practice. It can be used in numerous cases for describing conditions in the motor.

2.3.5 Changing Speed

The motor speed n is dependent upon the rotational speed of the magnetic field and can be expressed as:

$$n = n_0 - n_s = \frac{(1 - s) \times f}{p}$$

The motor speed can therefore be changed by changing:

- The pole pair number p of the motor (for example, pole-changing motors)
- The motor slip s (for example, slip-ring motors)
- The motor supply frequency f (for the motor)

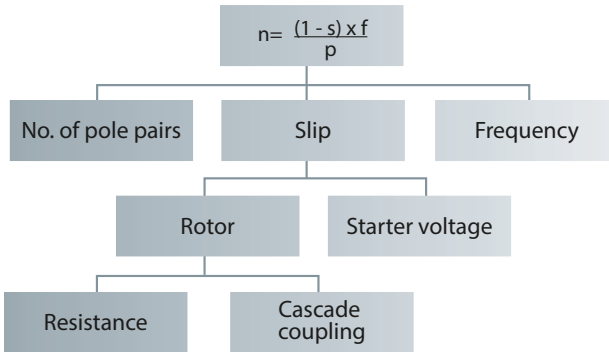

Fig. 2.16 Different options for changing the motor speed

Pole number control

The rotational speed of the magnetic field is determined by the number of pole pairs in the stator. In the case of a two-pole motor, the rotational speed of the magnetic field is 3000 RPM at a motor supply frequency of 50 Hz. For a four-pole motor the speed is 1500 RPM.

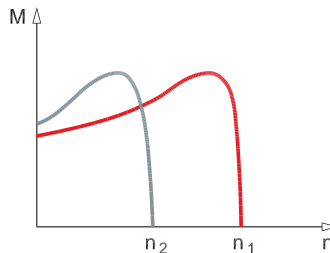

Fig. 2.17 Torque characteristics when changing pole number

Motors can be designed to have two or more different pole-pair numbers. This is done by using a special arrangement of the stator windings (Dahlander winding) in the slots and/or by using more separate and isolated windings in the slot.

The speed is changed by switching the stator windings to change the number of pole pairs in the stator. By switching from a small pole-pair number (high speed) to a high pole-pair number (low speed), the actual motor speed can be dramatically reduced, for example, from 1500 to 750 RPM. With rapid switching from higher to lower speed, the motor runs through the regenerative range. This places a considerable load on the motor and the mechanism of the driven machine which can cause damage to motor and machinery.

Slip control

Controlling the motor speed using slip can take place in two different ways: either by changing the stator supply voltage or by modifying the rotor. It should be mentioned that these methods involve considerable thermal losses. Please refer to other sources of information if more is needed.

Rotor control

Controlling the motor speed using the rotor can be made in two different ways:

- Resistors are inserted in the rotor circuit. These types of motors are called “slip-ring” motors. The trade-off using this method is higher power losses in the rotor circuit.
- Rotor circuits are cascaded with other electrical machines or rectifier circuits. The rotor circuit is then connected via slip rings to DC machines or to controlled rectifier circuits instead of resistors. The DC machine supplies the rotor circuit with additional variable voltage making it possible to change the rotor speed and magnetization.

Frequency regulation

With a variable frequency supply, it is possible to control the motor speed with minor additional losses. The rotational speed of the magnetic field and hence the rotor speed changes with the frequency. To maintain the motor torque, the motor voltage must change together with the frequency as shown in Fig. 2.18 Torque characteristics with voltage/frequency control.

With a constant ratio of motor supply voltage to frequency, the magnetization in the rated motor operating range is also constant.

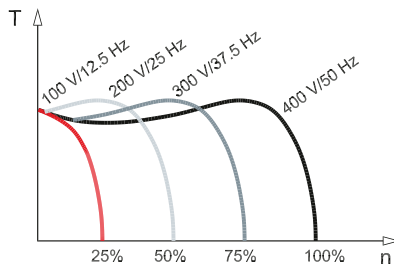

Fig. 2.18 Torque characteristics with voltage/frequency control

At low speed the ratio must be adjusted to compensate for the ohmic losses. Further forced cooling may be required in this speed range.

2.3.6 Motor Nameplate and Star or Delta Configuration

Normally the motor has a nameplate on it which has all essential motor data. Additional data are available in the motor catalogue or can be obtained from the manufacturer.

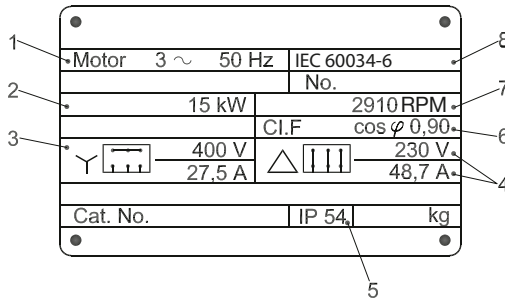

Fig. 2.19 Motor nameplate shows essential data

The nameplate shown has the following information:

1. It is a three-phase AC motor with a rated frequency of 50 Hz
2. Rated output (shaft) power is 15 kW
3. The stator windings can be connected in series (star) with a rated voltage of 400 V and rated (apparent) current of 27.5 A
4. Alternatively, the stator windings can be connected in parallel (delta) with a rated voltage of 230 V and rated (apparent) current of 48.7 A
5. It has an IP 54 protection
6. Insulation class F (155 °C) and a power factor (cos φ) of 0.90.
7. Rated speed 2910 RPM (a two-pole motor) is the motor speed at the rated voltage, rated frequency and rated load
8. Fulfills the IEC 60034-6 standards

Some motor data (torque, efficiency, etc.) can be calculated using the nameplate data. For example, the power factor can be used to calculate the active and reactive components of the motor current.

Pay special attention to the rated motor voltages in star and delta. If the supply voltage is higher than the rated voltage of the applied configuration, the motor will be damaged. The connection itself can be often changed by rearranging the jumpers at the motor terminal.

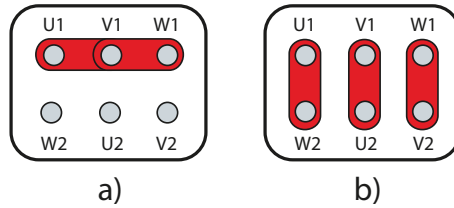

Fig. 2.20 Star (a) and delta (b) configuration of motors via jumpers on the terminal block

In delta connection the full supply voltage (phase-to-phase voltage, U_{pp}) is applied to each motor phase but the phase current (I_p) is reduced by the factor $\sqrt{3}$. In star connection the current is maintained, and the phase voltage (U_p) is reduced. Therefore, the power is the same regardless of the connection since the feeding voltages are different.

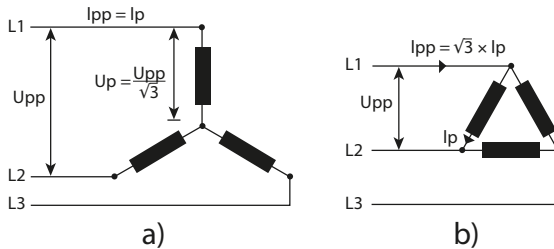

Fig. 2.21 Current and voltage distribution in star (a) and delta (b) configuration

In a delta connection $U_{pp} = U_p$, so the motor must suit the supplying mains. This means that on 400 V mains the motor must have a 690 V star and a 400 V delta rating. So-called star/delta starters utilize this behavior for reducing the starting current of a motor. At start the motor will be connected in a star, reducing current, power and torque to one-third. After the motor has been accelerated the connection will be changed to delta.

Motor voltages in catalogues are often expressed by mentioning the star and delta voltages together (example: 400/230 V Y/ Δ or 690/400 V Y/ Δ). The voltages are phase-to-phase voltages. Therefore, the lower voltage is always related to delta and the higher to the star connection.

The relation of the current is vice versa: the lower current relates to the star configuration and the higher current relates to the delta configuration.

2.4 Synchronous Motors

The synchronous motor is defined by the fact that the rotor rotates at the same speed as the magnetic field created by the stator windings. The design of the stator is in many cases similar to that of induction motors, with distributed windings. Some manufacturers use concentric windings (in slot) which enable a more compact motor design and require less copper. The energy savings achieved by the reduced use of copper are however often eaten up by additional losses, which result from harmonics in the air gap flux caused by the construction.

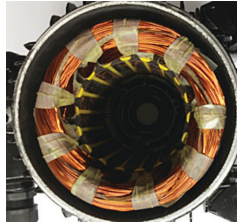

Fig. 2.22 Distributed windings

The torque produced by a synchronous motor has two different sources. One is the interaction between the rotor flux and the permanent magnet torque, the another is the design asymmetry/anisotropy in the motor (saliency torque).

An overview of the motor types may be provided by considering two indicators: Saliency, which expresses the effect of the asymmetry in the motor (anisotropy) on the inductances and is defined by the ratio of the highest to the lowest inductance.

T_{pm}/T_{total} , which expresses the contribution of the permanent magnet torque to the total torque.

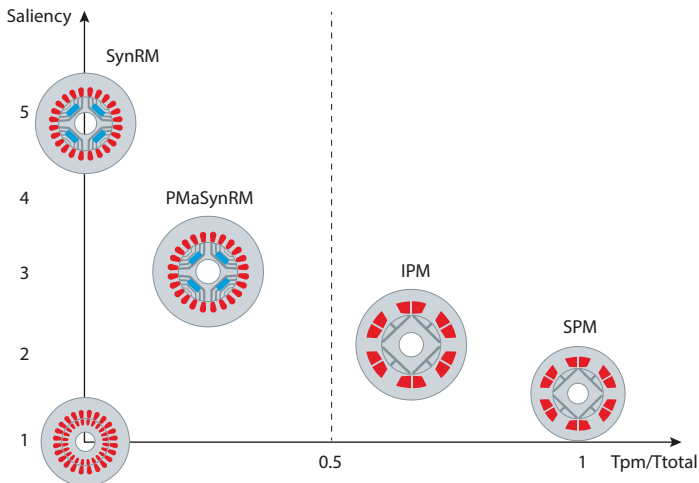

Fig. 2.23 In the IM there is no permanent magnet present, thus $T_{pm}/T_{total} = 0$. The geometry of IM provides no anisotropy, thus saliency = 1.

The main synchronous motors types (Surface mounted magnets SPM, Interior mounted magnets IPM, Synchronous reluctance motor SynRM and permanent magnet assisted Synchronous reluctance motor PMSynRM) are generic located with respect to saliency and to permanent magnet contribution to the total torque, T_{pm}/T_{total} , as illustrated:

- In SPM the amount of magnet is high, and the entire torque production is due to the rotor permanent magnet flux, thus $T_{pm}/T_{total} \approx 1$. The anisotropy is low, thus saliency ≈ 1 .
- In SynRM there is no magnet in the rotor, thus $T_{pm}/T_{total} = 0$ and the entire torque production is due to the reluctance torque. The anisotropy is high and so saliency is.
- Between SPM and SynRM any combination is theoretically possible. The IPM are generally achieved by design as illustrated and $T_{pm}/T_{total} > 0.5$ (pm torque dominates). The PMSynRM are generally achieved by designs as illustrated and $T_{pm}/T_{total} < 0.5$ (reluctance torque dominates). However, for control is not important to distinguished between IPM and PMSynRM.

2.4.1 Permanent Magnet (PM) Motors

The simplest way to build a permanent magnet motor (PM motor) is to replace the squirrel-cage rotor of an induction motor with a rotor which is equipped with permanent magnets. When applying a suitable voltage to the stator, a rotating magnetic field will be created in the air gap. The rotor will follow the field at synchronous speed because the magnets are attracted by the rotating field. If the difference between rotor speed and the speed of the magnetic field is too big the motor falls out of synchronicity and the motor will stop. Therefore, a suitable controller is required which ensures that speed changes are done by adjusting the feeding frequency continuously and not by switching from one speed to another.

In the past PM motors were often used in servo applications with focus on fast and precise operation. These servo motors are typically slim and long in order to have a low inertia for high dynamic applications. To utilize the high-efficiency characteristic of PM motors in other applications the principle has been transferred to motors in IEC frame sizes. Standard AC drives can be used in the majority of PM motor systems for operation if suitable control algorithms are implemented in the device.

To magnetize the motor in the best way the controller needs to know the rotor angle at any point in time. In many applications sensorless strategies for determining the rotor angle are sufficient. For example, see chapter 3.7.6 Integrated Motion Controller. If the controller is not capable of sensorless control or in high dynamic servo applications, external position feedback devices are used.

In the equivalent diagram the magnets are represented by a voltage source U_p because turning the rotor will result in a voltage induced in the stator. This voltage is called back EMF, see section 2.4.1.1 Back EMF. The absence of motor slip, rotor resistance and inductance indicate that no losses are created in the rotor, which results in the very good efficiency.

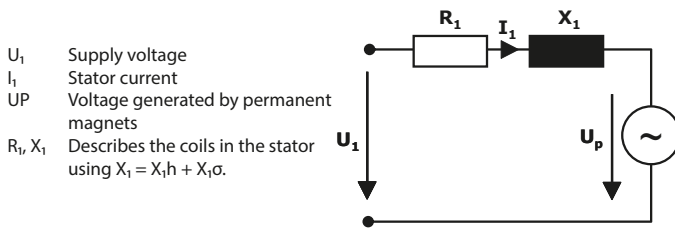

Fig. 2.24 Simplified PM motor equivalent circuit diagram

In general PM motors can be divided into motors with rotors where the magnets are placed on the surface (SPM motor) or internally (IPM motor). The placement of the magnet results in different shapes of the resulting magnetic field and is described by the inductances L_d and L_q .

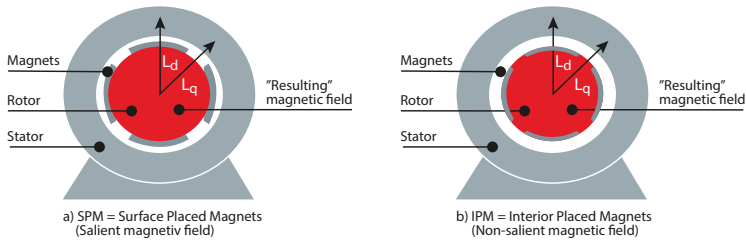

Fig. 2.25 Magnet placement a) SPM and b) IPM

As the magnets behave like air in relation to the resulting magnetic field, salient and non-salient fields are created. With SPM motors L_d and L_q have the same value resulting in a non-salient field while the different L_d and L_q of an IPM creates a salient field which produces an additional torque in field-weakening (see chapter 4.1.1).

2.4.1.1 Back EMF

When the shaft of a PM motor is turned, the motor produces a voltage at its terminals. This voltage is called back EMF (EMF = electromotive force) and describes an important characteristic of the motor. The higher the voltage, the better the motor efficiency. Depending on the connection and placement of the windings, the shape of the back EMF can be trapezoidal or sinusoidal. For trapezoidal voltage so-called block commutation is required which is easy to realize in the electronics but has drawbacks like noise and torque ripples. Typically, PM motors have sinusoidal back EMF and will be operated via sinusoidal commutation.

Given that the motor actively generates a voltage must be considered, not only during operation but also when the feeding AC drive is disconnected from mains (power loss, breakdown, switched off). The motor can potentially generate sufficient energy to power up the device while the shaft is rotating (for example, when coasting). The voltage needed for powering the drive depends on the mains voltage the drive is designed for.

Example: Required speed of a PM motor with 200Vrms back EMF to power on a 400 V mains AC drive (required DC-link voltage approx. 320 V).

$$n_{\text{power on}} = \frac{\frac{U_{\text{DC on}}}{\sqrt{2}}}{U_{\text{BackEMF}@1000\text{RPM}}} \times 1000 \text{ RPM} = \frac{\frac{320\text{V}}{\sqrt{2}}}{200\text{V}} \times 1000 \text{ RPM} = 1134 \text{ RPM}$$

If the voltage generated by the motor is too high the drive can be destroyed. Practically this can happen when the controlling drive is switched off while the motor is operating at very high speed. During operation the drive limits the voltage coming back from the motor. When the control is suddenly switched off the full back EMF voltage can be seen at the terminals immediately. This critical speed depends on the back EMF of the motor and the voltage the drive is designed for.

Example: 400 V mains, $U_{\text{BackEMF}@1000\text{RPM}} = 100\text{Vrms}$, $U_{\text{DC critical}} = 1000\text{V}$

$$n_{\text{critical}} = \frac{U_{\text{DC critical}}}{U_{\text{BackEMF}@1000\text{RPM} \cdot \sqrt{2}}} \times 1000 \text{ RPM} = \frac{1000\text{V}}{100\text{V} \times \sqrt{2}} \times 1000 \text{ RPM} = 5656 \text{ RPM}$$

A brake resistor can be used to overcome such critical situations.

Unfortunately, there is no standard used by motor manufacturers to provide information about the back EMF. Some manufacturers state back EMF related to 1000 RPM while others use nominal speed of the motor.

$$U_{\text{EMF}} = k_e \times \frac{1000}{60} \times 2\pi$$

Sometimes the value of factor k_e is given in radians and must be converted to RPM. Where peak values are provided the voltage must be divided by square root of two to get the RMS value.

Also, advanced motor data like motor resistance and inductances are stated in differing ways. Sometimes they are given as phase/phase values, and sometimes as phase/star values.

$$U_{\text{RMS}} = \frac{U_{\text{Peak}}}{\sqrt{2}}$$

2.4.1.2 Torque and Speed Range

The torque of a PM motor is proportional to the motor current, and its speed is proportional to the feeding frequency. At nominal torque and speed, a certain voltage is required. If the AC drive can deliver a higher voltage, the speed can be increased further. This results in a higher power at constant torque. When the voltage has reached an upper limit, the motor enters the field weakening area. Operation in field weakening is only possible with suitable AC drives. Motor mechanics and insulation must support the higher speed and withstand the higher voltage.

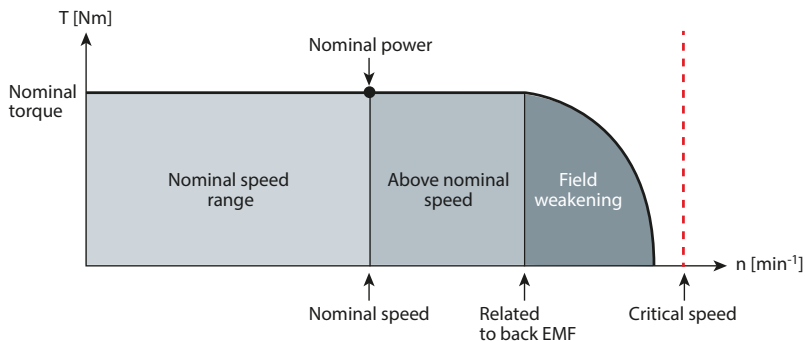

Fig. 2.26 Operation in field weakening area

The greatest risk in field weakening operation is switching off the motor control at too high speed, as the high back EMF can destroy the AC drive (see section 2.4.1.1 Back EMF).

Another possibility for extending the speed range is to change the star configuration of a motor to delta, if the motor provides this feature. Similar to induction motors, a delta connection results in a higher voltage on the windings, because it is not reduced by the factor $1.73\sqrt{3}$ as for a star configuration.

2.4.2. Brushless DC (BLDC) or Electronically Commutated (EC) Motors

EC (Electronically Commutated Motor) and BLDC (Brushless DC) are basically different names for the same technology. In the original BLDC concept only two phases were energized with a trapezoidal voltage. Compared to a distribution over three phases this result in 1.22-time higher current. For determining the rotor position Hall sensors have been used. Drawbacks of the concept were worse torque ripples and iron losses.

In practice there are many different types of EC motors, such as small servo motors with power ratings of a few watts or motors in building automation systems up to approximately 10 kW. In general BLDC/EC has a reputation for extremely high efficiency. This is fully deserved, in particular for very small devices – the original application area for these motors – where they are distinctly better than universal or split-pole motors (efficiency approximately 30%). Above a few hundred watts the efficiency is comparable to standard PM motors.

Modern EC/ECM utilize the same control principles as the PM motors. In building automation EC motors are often used as hubs in EC fans. This results in a very compact fan unit with a very efficient motor. Unfortunately, the placement of the motor in the middle of a centrifugal fan creates air turbulences which reduce the total fan efficiency. In comparison to the Danfoss EC+ solution, which allows highly efficient PM motors to be used with Danfoss VLT® drives, the difference in total system efficiency can be in the range of 5-7%.

2.4.3 Line Start PM Motor (LSPM motor)

A line start PM motor is a hybrid of a squirrel-cage induction motor and a PM motor where the magnets are placed internally to the rotor.

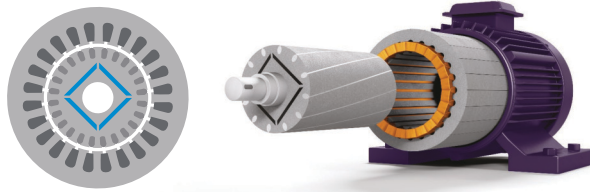

Fig. 2.27 The position of magnets in the rotor influences the motor characteristics

When connected to a three-phase grid the motor develops a torque and accelerates like a standard induction motor to near synchronous speed if the motor torque is greater than the load torque throughout acceleration. When the rotor has roughly reached the speed of the rotating field, a synchronizing torque (reaction torque) is produced due to magnetic coupling between the rotating stator field and the rotor poles, which pulls the rotor into synchronism.

After synchronization, the motor continues to run at synchronous speed. As there is no speed difference between the magnetic field and the rotor, no currents are induced in the cage. This results in a high efficiency with a good power factor. When load changes take place the squirrel cage is still working as a damper. This is also the case when the motor is operated by an AC drive where the additional damper can reduce the efficiency by approximately 5-10%.

If the motor is loaded with a torque that is greater than its synchronous stalling torque, it is pulled out of synchronism and continues to operate like an induction motor at a load-dependent speed. Depending on the design, the motor is more or less sensitive to under-voltage situations which can also result in falling out of synchronism. Renewed synchronization takes place automatically when the load torque is lower than the synchronizing torque. However, the rotor will stop if the motor is loaded with a torque that is greater than its induction stalling torque.

Drawbacks of the concept are the influence of the magnets while starting the motor. Torque oscillations and torque peaks, paired with noise, arise during the start up. Furthermore, the starting torque is lower compared to an induction motor as the magnets create a negative torque component^{*)}.

^{*)} Source – 2014. J Sorgdrage, A.J Grobler and R-J Wang, *Design procedure of a line-start permanent magnet synchronous machine.*

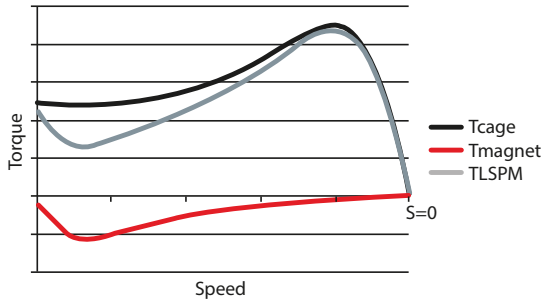

Fig. 2.28 Starting torque of LSPM is reduced compared to the pure squirrel cage torque

LSPM motors are typically used in fans and pumps, available in the power range up to approximately some 10 kW but can also be used in low inertia applications.

2.4.4 Reluctance Motors

For creating a motor movement these types of motors utilize magnetic reluctance, which is also called magnetic resistance. Similar to electric circuits the magnetic flux follows the path of the lowest resistance. As in induction motors, the magnetic field is created by applying a suitable voltage to the stator windings. The rotor rotates towards the position with minimum magnetic reluctance. If the rotor is now forced out of this position a torque is created in order to move it back to the position where the reluctance is minimized. The torque resulting from the magnetomotive force depends on the relationship between the inductances in the d-axis and q-axis, known as the saliency ratio.

The saliency ratio results directly from the rotor lamination design. Cut-offs in the lamination are utilized to shape the equivalent air gap of the machine by controlling the flux paths. They also influence how the d-axis and q-axis inductances vary with the magnetization current. As these cut-offs increase the equivalent air gap, a higher magnetizing current is required which leads to a worse $\cos \phi$. As illustrated in Fig. 2.29 Maximum power factor vs. saliency ratio, the maximum power factor depends on L_d/L_q ratio. The higher the ratio the better the $\cos \phi$ becomes. Modern rotor designs have a ratio in the range from 4 to 10.

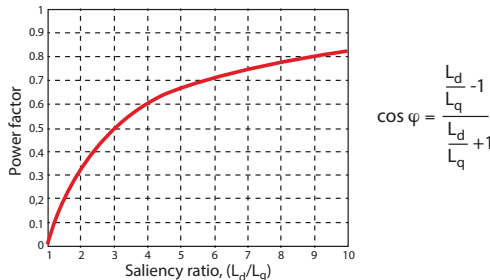

Fig. 2.29 Maximum power factor vs. saliency ratio

Reaching power factors as high as induction motors is difficult for reluctance motors (requires a very high saliency ratio), but the energy efficiency is reasonably high. Losses arise in the rotor mainly by harmonics in the air gap between stator and rotor.

The reluctance principle was first used around the year 1840. Over time various optimizations resulted in different motor principles and designs. In the next chapters the three most common types of reluctance machines are described.

2.4.5 Synchronous Reluctance Motor with Squirrel Cage

The stator of this three-phase reluctance motor is identical to that of a standard three-phase squirrel-cage motor. The rotor design is modified by removing the rotor bars and cutting pole gaps on the circumference of the laminated rotor core. The gaps are filled again with aluminum and the end windings are shorted.

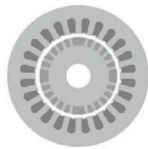

Fig. 2.30 Rotor with pole gaps on the circumference placed in the stator

Similar to a LSPM motor design, (see section 2.4.3 Line Start PM Motor (LSPM Motor)) the motor accelerates to near synchronous speed when connected to a three-phase grid, if the produced torque is sufficient for the load. When approaching the synchronous speed, the rotor is pulled into synchronism and runs at synchronous speed despite the absence of rotor excitation.

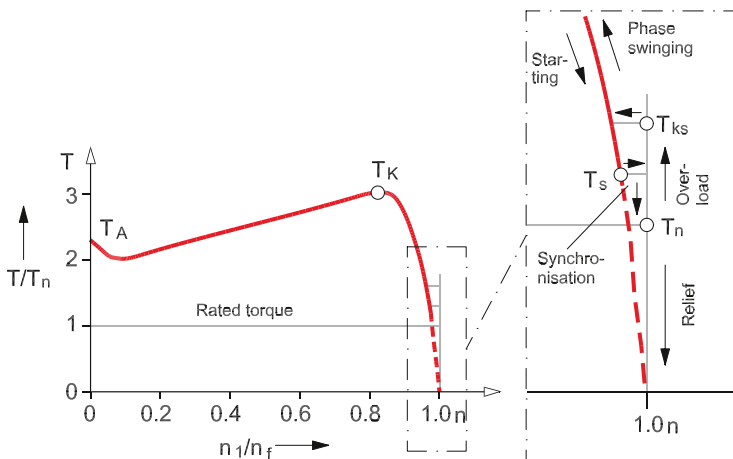

Fig. 2.31 Torque characteristic of a reluctance motor

Under load, the salient rotor poles lag behind the stator rotating field by the load angle. Again, the behavior is similar to LSPM when the load torque becomes too high. The motor is pulled out of synchronism, continues to operate like an induction motor and regains synchronization automatically when the load torque is lower than the synchronizing torque.

The possibility to start direct on line (DOL) and run at synchronous speed make the motor interesting for several applications. Power range ends often at approximately 10 kW. The drawback is a reduced efficiency, especially when operated by AC drives, as the rotor windings act as an additional damper.

2.4.6 Synchronous Reluctance Motor (SynRM)

The design of a new generation of reluctance motors focuses on energy efficiency. This highly efficient motor type is often meant when synchronous reluctance motors are addressed and should not be confused with reluctance motors which focus on high torque density or the possibility to start on mains. The key to the efficiency is the new rotor design.

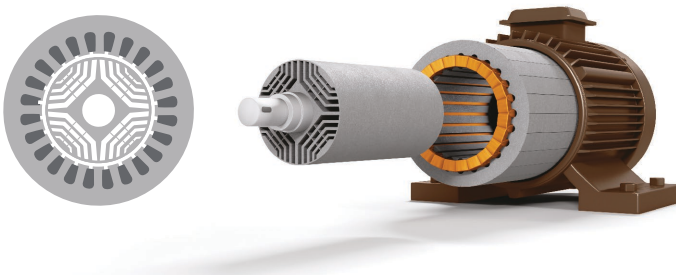

Fig. 2.32 Special rotor lamination design results in high efficiency at low torque ripples

The stator construction and the windings are similar to an induction motor. By applying a suitable voltage to the distributed windings, a harmonic field is created which creates low harmonic losses. Also, the design of the rotor is optimized to reduce harmonic losses and operate with low torque ripples.

As the motor cannot start directly on mains, an AC drive is required to control the motor. For magnetizing the cut-offs in the rotor lamination, higher apparent power is required than for an induction motor (see section 2.4.4 Reluctance Motors). If the converter and the capacitors in the intermediate circuit are suitably sized, they will deliver the additional apparent current. In this case the grid is not loaded with the higher apparent power and the low $\cos \varphi$.

For operating the motor, the AC drive needs to know the rotor angle. Depending on the angle, the drive will energize the different windings. The determination of the rotor angle is often done sensorless without an additional device. To achieve an energy efficient control, the converter must also take care of the L_d and L_q behavior in operation.

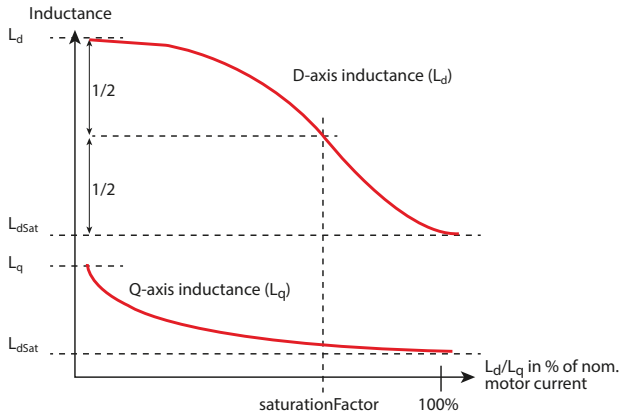

Fig. 2.33 Example of L_d/L_q relationship to I_d/I_q

The inductance components of the SynRM rotor change depending on the load because of saturation effects. Therefore the individual inductances L_d and L_q depend on I_d and I_q current ($L_d(I_d, I_q)$ and $L_q(I_d, I_q)$). The inductances are determined automatically by the frequency converter at commissioning. If this is considered, very high energy efficiency operation of the motor is possible. Over a certain power range, the part-load efficiency has advantages against other concepts.

2.4.7 Permanent Magnet Assisted Synchronous Reluctance Motor (PMA SynRM)

The PMA SynRM is built as a variation of SynRM, by adding weak magnets to the rotor geometry. Although, the location of the magnets may differ from design to design, their purpose is to saturates the rotor ribs, thus increasing the torque production and improving the power factor.

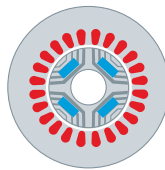

Fig. 2.34 The PM assisted SynRM motor has small magnets inserted in the lamination

In contrast to SynRM, where the entire electromagnetic torque is produced by the differences in the reluctance around the rotor (reluctance torque), in the PMA SynRM, the electromagnetic torque is produced by reluctance torque and by interaction of the permanent magnet flux with the magnetizing stator current (pm torque).

From the point of view of the control, the PMA SynRM is like an IPM. The difference between an IPM and a PMA SynRM consists in the fact that in an IPM the torque produced by the permanent magnet is higher than the reluctance torque, while in PMA SynRM the reluctance torque is dominant.

In practice are also motors, which are named IPM, but in the reality have properties similar to a PMSynRM.

The motor parameters required by control are as for IPM the line-to-line back emf at 1000rpm and the variation of L_d and L_q inductances with the current as described in Fig. 2.33.

2.4.8 Switched Reluctance Motor (SRM)

Construction of the stator is very similar to that of DC motors as concentric windings are used. This can result in a compact housing. The rotor lamination design has a very clear shape with low inertia where the number of poles can easily be counted. While on two pole motors the rotor, poles are aligned with the stator poles, the pole ratio is typically different. This principle is also applied on other motor types, but it is obvious on switched reluctance motors.

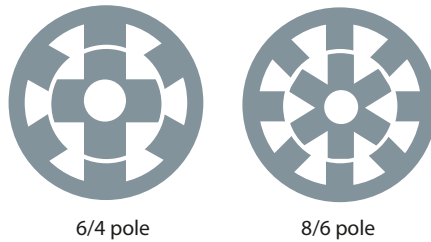

Fig. 2.35 Switched reluctance motor configuration examples

To run the motor a suitable controller is required, which energizes the stator inductors in a sophisticated way. The phases are energized one after the other. When the inductors of a phase are supplied with a voltage, a flux is established through the stator poles and the rotor, which results in rotor movement. After the rotor has started moving the voltage will be switched to the next phase and so on.

Starting the motor directly on mains is not possible. The design allows 100% torque at stall indefinitely and achieves high efficiency even in part-load operation. The double salient construction in rotor and stator is very robust but results typically in high torque ripples and low dynamics at higher noise.

For decades, induction motors were state of the art, while other technologies were only used in niches. The trend towards more energy efficient motors and the opportunities provided by AC drives has resulted in innovative technologies like the improved SynRM. More improvements and optimizations are in development.

It is, also, important to mention that these kinds of motors do not run on AC drives.

2.5 Medium Voltage Motors

When an application requires a high-power output, it can be beneficial to increase the voltage to keep the current lower. This means that smaller supply cables can be used, decreasing the cost of the cables. Lowering the current also limits the power losses in supply cables, where the magnitude of the loss is I^2R .

Medium voltage (MV) induction motors are somewhat less efficient and costlier than low voltage (LV) motors. However, the advantages of smaller sized input cables and switchgear, and better power conversion economy from the power source offset these negative factors. Due to the greater physical size and cost of cables and equipment needed to feed large LV motors, at some point it becomes more practical and cost efficient to use MV motors.

Main reasons for using MV motors:

- Smaller power cables
- Switchgear sized for smaller currents
- Less voltage drops from the utility to the motor
- More power output with less current

The IEC 60038 standard defines medium voltage as the voltage range from 1000 V to 35 kV.

The decision when to use LV or MV motors differs greatly depending on the country, industry and specific application. The switch from LV to MV is typically considered somewhere between 150-400 kW (200-500 hp), although MV motors are also available at lower powers and LV motors at higher powers. Medium voltage is especially relevant for applications, which require a motor with an output of 400 kW or more.

Mechanically, medium voltage motors do not differ significantly from a standard, asynchronous low voltage motor. There are however some important differences. The stator on a MV motor has improved insulation to rate it for medium voltage. This includes a vacuum impregnation system, whereby all recesses are filled with varnish together with corona protection materials to prevent electrical wear of the insulation material. In addition, there are greater creepage and air clearances from conductor to ground.

LV motors are usually wound with round enamel-covered wire. These are called random-wound or mush-wound inductors. MV motors are wound with rectangular cross-section copper wire with enamel or mica tape insulation, depending on the voltage level. These are known as form-wound inductors. Because form-wound inductors must be individually insulated and formed to precise dimensions, they are much more expensive to manufacture. Also, because of the thicker insulation required due to higher voltage levels, a MV motor will normally be larger and more expensive than a LV motor of the same rating.



03

AC DRIVES

3	AC Drives	47
3.1	Direct Converters.....	47
3.2	AC Drives with an Intermediate Circuit.....	48
3.3	Rectifier	50
3.3.1	Uncontrolled Rectifiers	50
3.3.2	Semi-controlled Rectifiers.....	51
3.3.3	Fully-controlled Rectifiers.....	52
3.3.4	Active Front-End/Active Infeed	53
3.4	Intermediate Circuit	53
3.4.1	Variable Intermediate Circuit	53
3.4.2	Constant Intermediate Circuit.....	55
3.4.3	Capacitorless Intermediate Circuit	56
3.4.4	Common DC Bus.....	56
3.5	Inverter.....	57
3.6	Modulation Principles.....	60
3.6.1	Pulse Amplitude Modulation (PAM)	60
3.6.2	Pulse width Modulation (PWM)	60
3.6.3	Asynchronous PWM	62
3.6.3.1	SFAVM.....	63
3.6.3.2	60° AVM.....	65
3.7	Control Circuit and Methods.....	66
3.7.1	Simple Control Method.....	69
3.7.2	Scalar Control with Compensation	70
3.7.3	Space Vector with and without Feedback.....	71
3.7.3.1	Space Vector (Open Loop).....	71
3.7.3.2	Space Vector (Closed Loop).....	72
3.7.4	Open Loop and Closed Flux Vector Control.....	72
3.7.4.1	Flux Vector (Open Loop).....	72
3.7.4.2	Flux Vector (Closed Loop)	73
3.7.5	Servo Drive Control.....	74
3.7.6	Integrated Motion Controller	74
3.7.7	Control Conclusions	75
3.8	Danfoss Control Principles	75
3.8.1	Danfoss VVC+ Control Principle	76
3.8.2	Danfoss Flux Vector Control Principle.....	80
3.9	Medium Voltage Drives.....	80
3.9.1	MV Semiconductors.....	81
3.9.2	MV Drive Topologies.....	81
3.10	Standards and Legislations	84

3 AC Drives

Since the late 1960s, the AC drive has developed at a tremendous rate. Major advances have been made thanks to developments within the fields of microprocessor and semiconductor technology and the associated price reduction. However, the basic principles of the AC drive remain the same.

As stated in the introduction, the main function of an AC drive is to generate a variable supply (for example, 0 to 400 V / 0 to 50 Hz) from a supply with “fixed” parameters (for example, 400 V and 50 Hz). There are two approaches to performing the conversion, defining two types of drives: Direct converters and AC drives with an intermediate circuit.

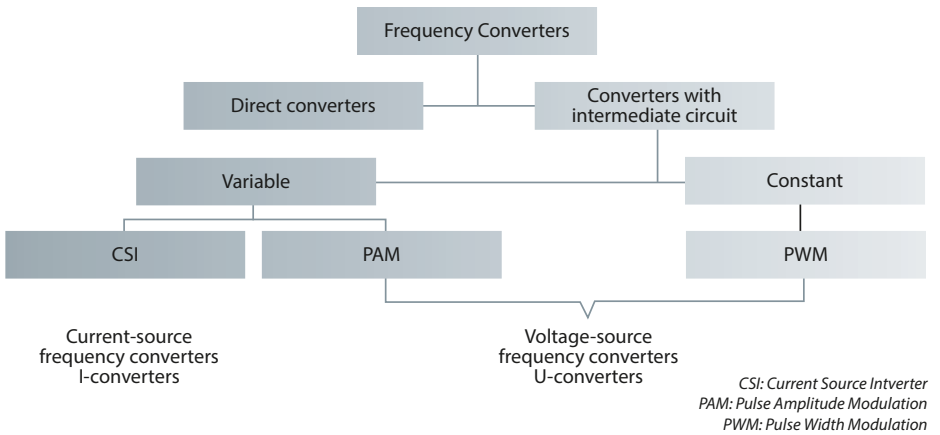

Fig. 2.1 Overview of AC drive types

3.1 Direct Converters

The direct converter performs the conversion with no intermediate storage.

Direct converters are generally only used in high-power applications (megawatt range). This book does not deal with this type of converter in detail, but several features are worth mentioning.

Direct converters are characterized by:

- Reduced frequency control range (approximately 25 to 30 Hz) with 50 Hz mains frequency
- Common use with synchronous motors
- Suitability for applications with stringent dynamic performance requirements

3.2 AC Drives with an Intermediate Circuit

In the vast majority of cases, the AC drive is equipped with an intermediate circuit. Another term for intermediate circuit is “DC-bus” or “DC-link”. Within the category of AC drives with an intermediate circuit, there are two subtypes:

- constant intermediate circuit
- variable intermediate circuit

AC drives with an intermediate circuit can be broken down into four main components as shown in Fig. 3.2 Block diagram of an AC drive with an intermediate circuit.

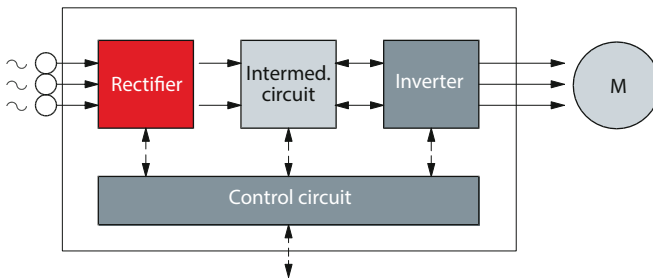

Fig. 3.2. Block diagram of an AC drive with an intermediate circuit

Rectifier

The rectifier is connected to a single-phase or three-phase AC mains supply and generates a pulsating DC voltage. There are four basic types of rectifier, as shown in Fig. 3.3 Main component topologies:

- uncontrolled
- semi-controlled
- fully controlled
- active front-end

Intermediate circuit

The intermediate circuit can function in two different ways, as shown in Fig. 3.3 Main component topologies Intermediate circuit:

- Conversion of the rectifier voltage into a DC voltage
- Stabilization or smoothing of the pulsating DC voltage to make it available to the inverter

Inverter

The inverter converts the constant DC voltage of the rectifier into a variable AC voltage and generates the frequency of the motor voltage. See Fig. 3.3 Main component topologies Inverter.

Control circuit

The control circuit transmits signals to – and receives signals from – the rectifier, the intermediate circuit and the inverter. The design of the individual AC drive determines specifically which parts are controlled.

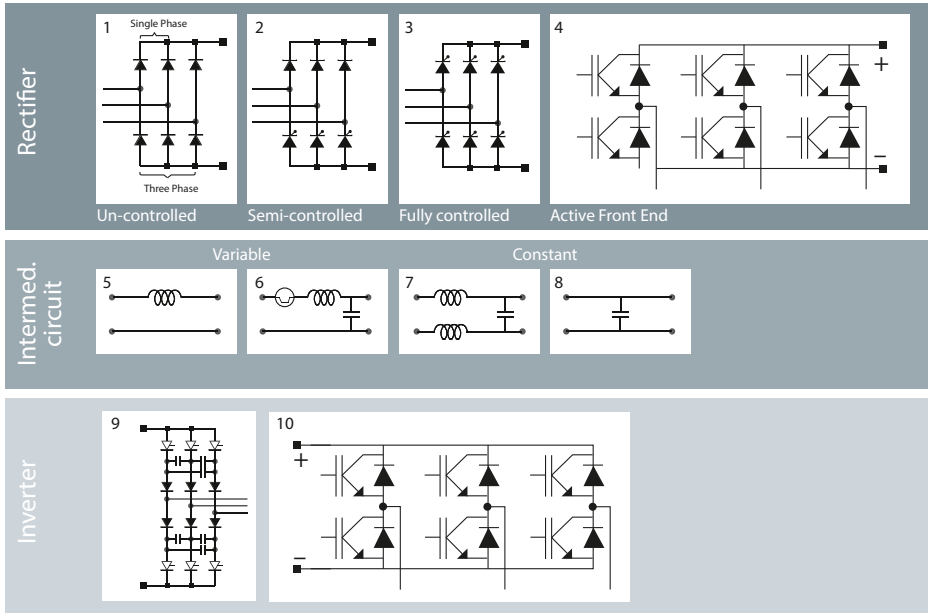

Fig. 3.3 Main component topologies

Configuration of the AC drive involves selection between different main components. See table 3.1 AC drive configuration examples.

Configuration example	Abbreviation	Configuration: Reference to components in Fig. 3.3
Pulse amplitude modulated converter	PAM	1 or 2 or 3 and 6 and 9 or 10
Pulse width modulated converter	PWM	1 or 2 or 3 or 4 and 7 or 8 and 9 or 19
Current-source converter	CSI	3, 5, and 9

Table 3.1 AC drive configuration examples

What all AC drives have in common is that the control circuit uses signals to switch the inverter semiconductors on and off. This switching pattern is based on a variety of principles. AC drives can further be broken down into types according to the switching pattern that controls the supply voltage to the motor.

3.3 Rectifier

Depending on the power involved, the power supply takes the form of a three-phase AC voltage or a single-phase AC voltage with a fixed frequency.

For example:

Three-phase AC voltage: 3 x 400 V/50 Hz

Single-phase AC voltage: 1 x 230 V/50 Hz

The rectifier of an AC drive consists of diodes or thyristors, a combination of both, or bipolar transistors (IGBTs).

Fig.3.3 Main component topologies shows the four different rectification approaches that are available today. In low-power applications (up to 30 kW, depending on the manufacturer), uncontrolled B6 bridge rectifiers are generally used. Half-controlled rectifiers are used in the power range 30 kW and above.

The rectifier circuits described above allow energy to flow in one direction, from the supply to the intermediate circuit.

3.3.1 Uncontrolled rectifiers

Uncontrolled rectifiers consist of diodes as shown in Fig. 3.4 How diodes work.

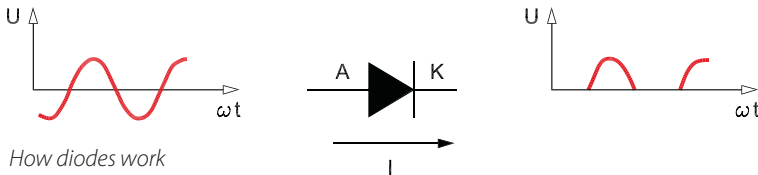

Fig. 3.4 How diodes work

A diode allows current to flow in one direction only: from the anode (A) to the cathode (K). The current is blocked if it attempts to flow from the cathode to the anode. It is not possible to control the current strength, as is the case with some other semiconductors. An AC voltage across a diode is converted into a pulsating DC voltage. If a three-phase AC voltage is supplied to an uncontrolled three-phase rectifier, the DC voltage will pulsate continuously.

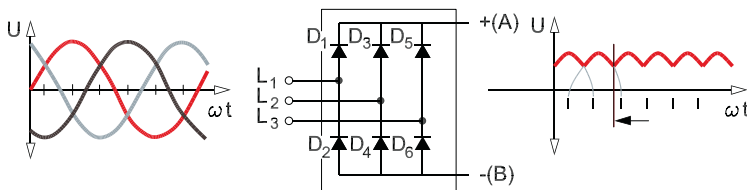

Fig. 3.5 Uncontrolled rectifier (B6-diode bridge)

Fig. 3.5 Uncontrolled rectifier (B6-diode bridge) shows an uncontrolled three-phase rectifier consisting of six diodes, also commonly referred to as a 6-pulse rectifier. The diodes can be divided in two groups. One group consists of diodes D_1 , D_3 and D_5 . The other group consists of diodes D_2 , D_4 and D_6 . Each diode conducts for one third of the period T (120°).

In both groups, the diodes conduct in sequence. Periods during which both groups conduct are offset in relation to each other by one sixth of the period T (60°).

Diode group $D_{1,3,5}$ conducts the positive voltage. When the voltage of phase L_1 reaches the positive peak value, terminal (A) takes on the value of phase L_1 . Reverse voltages of the magnitude U_{L1-2} and U_{L1-3} are present across the other two diodes.

The same principle applies to diode group $D_{4,6,2}$. Here terminal (B) takes on the negative phase voltage. If, at a given time, L_3 reaches the negative threshold value, diode D_6 conducts.

The other two diodes are subject to reverse voltages of the magnitude U_{L3-1} and U_{L3-2} .

The DC output voltage of the uncontrolled rectifier is constant and represents the difference between the voltages of the two diode groups. The average value of the pulsating DC voltage is approximately 1.31 to 1.41 times the mains voltage with a three-phase supply or approximately 0.9 to 1.2 times the AC voltage in the case of a single-phase supply.

The current consumption of the diodes is not sinusoidal. Consequently, uncontrolled rectifiers generate mains interference. To counteract this, AC drives with B12 rectifiers are increasingly used. B12 rectifiers comprise 12 diodes, organized in groups of 6. They are commonly referred to as 12-pulse rectifiers (see chapter 8.3.1).

3.3.2 Semi-controlled Rectifiers

In the case of semi-controlled rectifiers, a thyristor group takes the place of one of the diode groups (for example, $D_{4,6,2}$ as shown in Fig. 3.5 – Uncontrolled rectifier (B6-diode bridge)). The thyristors are also referred to as silicon-controlled rectifiers (SCR). SCRs are found in many applications in electronics, and in particular for power control.

By controlling the firing times of the thyristors, it is possible to limit the inrush current of the units and achieve soft-charging of the capacitors in the intermediate circuit.

The output voltage of these rectifiers is identical to that produced by uncontrolled rectifiers. Typically, semi-controlled rectifiers are found in AC drives of power size 37 kW and greater.

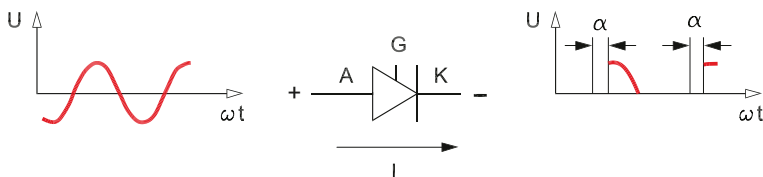

Fig. 3.6 How thyristors work

Referring to Fig. 3.6 How thyristors work, when α is between 0° and 90° , the thyristor circuit is used as a rectifier. When the α value is between 90° and 300° the thyristor circuit is used as an inverter.

3.3.3 Fully-controlled Rectifiers

Fully-controlled rectifiers involve the use of thyristors. As with a diode, a thyristor permits the current to flow from the anode (A) to the cathode (K) only. However, the difference is that the thyristor has a third terminal known as the gate (G). When the gate is triggered by a signal, the thyristor will conduct. Once current starts flowing through the thyristor, it will continue conducting until the current drops to zero. The current cannot be interrupted by sending a signal to the gate.

Thyristors are used in rectifiers. The signal sent to the gate is known as the α control signal of the thyristor. α is a time delay, which is specified in degrees. The degree value indicates the delay between the voltage zero crossing and the time when the thyristor is triggered.

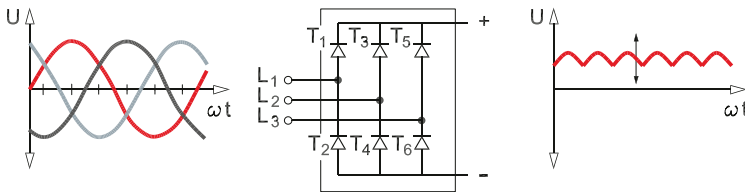

Fig. 3.7 Fully-controlled three-phase rectifier

Fully-controlled three-phase rectifiers can be broken down into two groups of thyristors: T1, T3 and T5, on the one hand, and T4, T6 and T2 on the other. With fully controlled rectifiers, α is calculated from the moment when the corresponding diode in an uncontrolled rectifier would normally begin to conduct, that is, 30° after the voltage zero crossing. In all other respects, controlled rectifiers behave like uncontrolled rectifiers.

The amplitude of the rectified voltage can be varied by controlling α . Fully-controlled rectifiers supply a DC voltage with an average value U , where

$$U = 1.35 \times U_{\text{mains}} \times \cos \alpha.$$

Compared to uncontrolled rectifiers, fully-controlled rectifiers result in major losses and disturbances in the supply network, because they draw a high reactive current when the thyristors conduct for short periods. However, the advantage of fully-controlled rectifiers is that they enable regenerative braking power in the intermediate circuit to be fed back to the supply network.

3.3.4 Active Front-End / Active Infeed

For certain AC drive applications, the motor sometimes works as a generator. In these cases, the energy balance can be improved by returning energy to the supply grid.

Such AC drives require a controlled (active) rectifier, which allows energy to flow backwards. Therefore, these devices are called Active Front-End (AFE) or Active Infeed Converters (AIC). Precondition for feeding back energy to the supply grid is that the voltage level in the intermediate circuit is higher than the grid voltage. This higher voltage must be maintained in all operating conditions. Various strategies are available to reduce the losses during standby and motor operation, but none can completely eliminate losses. Further additional filtering is required in generative mode as the generated voltage does not fit the sine-wave shape of the supply grid. One way to utilize the regenerated energy is by coupling the intermediate circuit of the drive (see chapter 5.9.1).

Another reason for using an AFE is, that they are also efficient at limiting harmonics (see chapter 8).

3.4 Intermediate Circuit

Depending on the design, the functions performed by the intermediate circuit include:

- Acting as an energy buffer so that the motor can draw energy from/return energy to the grid via the inverter and as a means of accommodating intermittent load surges
- Decoupling the rectifier from the inverter
- Reducing mains interference

The intermediate circuit is based on one of four different basic circuits, shown in Fig. 3.3 Main component topologies. The type of intermediate circuit used is determined by the nature of the rectifier and inverter with which it is to be combined.

The basic differences between the various types of intermediate circuit are explained in the following sections.

3.4.1 Variable DC Intermediate Circuit

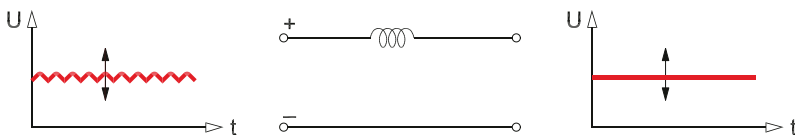

Fig. 3.8 Variable DC intermediate circuit

This type of intermediate circuit consists of a very large inductor, also known as a “choke” or “reactor” and is combined with a fully controlled rectifier as shown in Fig. 3.3 Main component topologies part 5, and Fig. 3.8 Variable DC intermediate circuit.

The inductor converts the pulsating DC voltage from the fully controlled rectifier into a constant DC voltage. The load determines the size of the motor voltage. The advantage of this kind of intermediate circuit is that braking energy from the motor can be fed back into the supply network without the need for additional components. The inductor is used in current-source AC drives (I-converters).

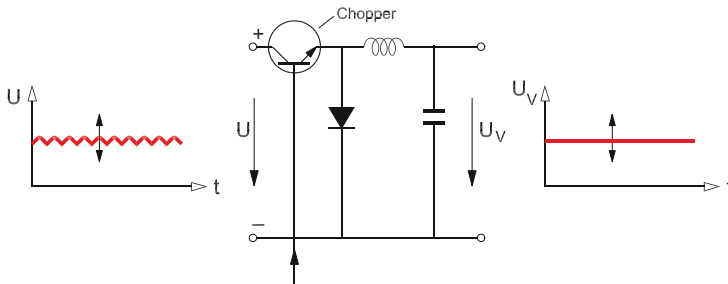

Fig. 3.9 Variable DC voltage intermediate circuit

Finally, a chopper can be inserted in front of a filter, as shown in Fig. 3.9 Variable DC voltage intermediate circuit. The chopper contains a transistor which acts as a switch for turning the rectified voltage on and off. The control circuit regulates the chopper by comparing the variable voltage after the filter (U_V) with the input signal.

If there is a difference between these values, then the ratio of the time t_{on} (when the transistor is conducting) to the time t_{off} (when the transistor is blocking) is adjusted.

This makes it possible to vary the effective value of the DC voltage depending on how long the transistor conducts. This can be expressed as:

$$U_V = U \times \frac{t_{off}}{t_{on} + t_{off}}$$

When the chopper transistor interrupts the current, the filter inductor (or “choke”) attempts to produce an infinitely high voltage across the transistor. To prevent this from happening, the chopper is protected by a freewheeling diode, as shown in Fig. 3.9 Variable DC voltage intermediate circuit.

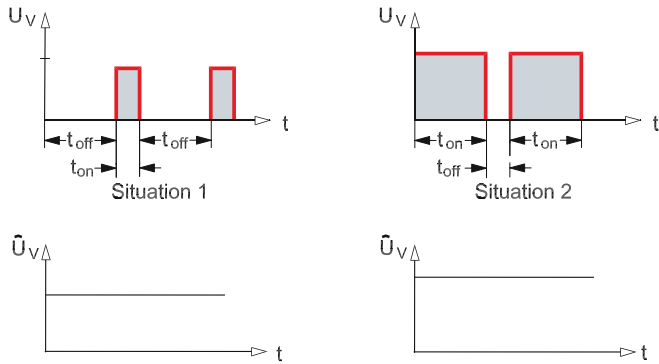

Fig. 3.10 Chopper transistor regulates the intermediate circuit voltage with corresponding effective value

The filter in the intermediate circuit smooths the square-wave voltage after the chopper, while keeping the voltage constant at a given frequency. The frequency associated with the voltage is generated in the inverter.

3.4.2 Constant Intermediate Circuit

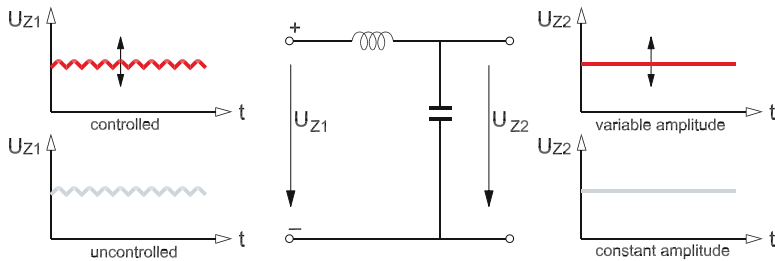

Fig. 3.11 Constant DC intermediate circuit

The intermediate circuit can consist of a filter comprising a capacitor and/or an inductor (choke). Typically, electrolytic capacitors are used due to their high energy density. Although capacitors have a limited service life, they offer the following benefits:

- Smoothing of pulsating DC voltage (U_{Z1})
- Availability as an energy reserve for supply voltage drops
- Availability for energy storage for load surges and generative operation of the motor

DC inductors offer the following advantages:

- Smoothing of current ripple, which in turn increases the service life of the intermediate circuit components, especially the capacitors
- Reduction of mains interference (harmonics) and the option of smaller supply conductor cross sections. This function can also be implemented by means of line inductors upstream of the AC drive

When planning an installation, it is important to note that the inductors are heavy and can get hot. Hot spots can arise.

This form of intermediate circuit can be combined with various types of rectifier. In the case of fully controlled rectifiers, the voltage is kept constant at a given frequency. Thus, the voltage that is supplied to the inverter is a pure DC voltage (U_{z2}) with variable amplitude.

With semi-controlled or uncontrolled rectifiers, the voltage at the inverter input is a DC voltage with constant amplitude (approximately $\sqrt{2}$ times the mains voltage). The anticipated voltage and frequency are both generated in the inverter.

3.4.3 Capacitorless Intermediate Circuit

In the last few years manufacturers have devised intermediate circuits without capacitors and inductors (chokes). This has been generally termed “capacitorless” or “slim” intermediate circuit. The control circuit controls the rectification of the supply voltage in a way that lower inrush currents can be achieved and so that mains interference can be limited to values of less than 40% (fifth harmonic). This results in the following characteristics:

- Lower building cost
- No charging circuit required
- More compact and lower weight construction
- Susceptibility to supply system voltage dips. That is, the AC drive is more likely to trip in the event of voltage dips, due to transients in the supply system
- Mains interference can occur in the high frequency spectrum
- The high ripple associated with the intermediate circuit reduces the output voltage by approximately 10% and results in higher motor power consumption
- The restart time for operation may be longer, due to three processes occurring:
 - Re-initialization of the AC drive
 - Magnetization of the motor
 - Ramping up to the required reference for the application

3.4.4 Common DC Bus

Intermediate circuits of AC drives can also be connected, and the DC voltage shared between several inverters. In applications with several parallel motors, instead of installing separate AC drives for each motor, it is possible to use a so-called common DC bus drive.

A common DC bus drive system consists of one or more front end units (rectifiers) that convert the mains AC voltage into DC voltage and current, providing power to the common DC bus. The common DC bus transfers the power to the inverter drives, and depending on the type of the front end, in some cases back to the mains network. A common DC bus drive system may also include a brake chopper unit, as a cost-effective solution for dissipating the braking energy in cases where regeneration of the power to the network is not feasible.

The common DC bus configuration can bring significant energy savings when the braking energy is used. This is the case when there is more than one drive connected to the DC bus, and at least one of them is braking. The braking power is directly fed to the other drives via the common DC bus.

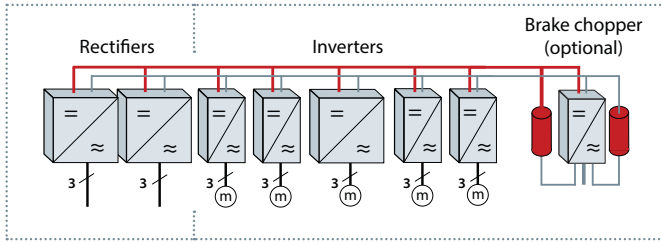

Fig. 3.12 Common DC Bus Drive System

3.5 Inverter

The inverter is the last of the main elements making up the AC drive. The inverter processes represent the final stage in terms of generating the output voltage and frequency. When the motor is connected directly to the mains, the ideal operating conditions apply at the rated operating point.

The AC drive guarantees good operating conditions throughout the whole speed range by adapting the output voltage to the load conditions. It is thus possible to maintain the magnetization of the motor at the optimal value.

From the intermediate circuit, the inverter obtains one of the following:

- Variable direct current
- Variable DC voltage
- Constant DC voltage

In each case, the inverter must ensure that the supply to the motor is an AC voltage. In other words, the frequency of the motor voltage must be generated in the inverter. The inverter control method depends on whether it receives a variable or a constant value. With a variable current or voltage, the inverter only needs to generate the corresponding frequency. With a constant voltage, the inverter generates both the frequency and amplitude of the voltage.

Even though inverters work in different ways, the basic design is always the same. The main components are controlled semiconductors, arranged in pairs in three branches, as shown in Fig. 3.3 Main component topologies.

Transistors are increasingly taking the place of thyristors in the inverter stage of AC drives for several good reasons. Firstly, transistors are now available for large currents, high voltages and

high switching frequencies. Furthermore, unlike thyristors and diodes, transistors are not affected by the current zero crossing. Transistors can enter the conducting or blocking state at any time simply by changing the polarity of the voltage applied to the control terminals. The advances made in the field of semiconductor technology over recent years have increased the switching frequency of transistors significantly. The upper switching limit is now several hundred kHz.

Thus, magnetic interference caused by pulse magnetization within the motor can be avoided. Another advantage of the high switching frequency is the fact that it allows variable modulation of the AC drive output voltage. This means that a sinusoidal motor current can be achieved, as shown in Fig. 3.13 Effect of switching frequency on motor current. The control circuit of the AC drive merely has to switch the inverter transistors on and off in accordance with a suitable pattern.

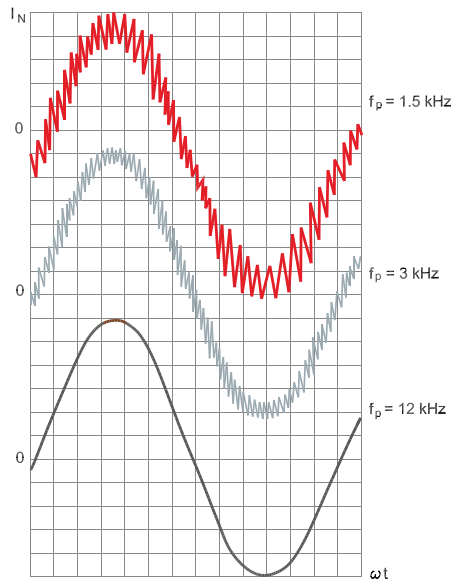

Fig. 3.13 Effect of switching frequency on motor current

The choice of the inverter switching frequency is a trade-off between losses in the motor (sine shape of motor current) and losses in the inverter. As the switching frequency increases, so do the losses in the inverter, in line with the number of semiconductor circuits.

High-frequency transistors can be divided into three main types:

- Bipolar (LTR)
- Unipolar (MOSFET)
- Insulated Gate Bipolar (IGBT)

Table 3.2 Comparison of power transistor characteristics shows the key differences between MOSFET, IGBT and LTR transistors.

Properties	Semi-conductor		
	MOSFET	IGBT	LTR
Symbol			
Design			
Conductivity Current conductivity Losses	Low High	High Insignificant	High Insignificant
Blocking conditions Upper limit	Low	High	Medium
Switching conditions Turn-on time Turn-off time Losses	Short Short Insignificant	Medium Medium Medium	Medium Low High
Control conditions Power Driver	Medium Voltage	Medium Voltage	High Current

Table 3.2 Comparison of power transistor characteristics.

IGBT transistors are a good choice for AC drives in terms of the power range, the high level of conductivity, the high switching frequency and ease of control. They combine the features of MOSFET transistors with the output properties of bipolar transistors. The actual switching components and inverter control are normally combined to create a single module called an “intelligent power module” (IPM).

A freewheeling diode is connected in parallel with each transistor, because high induced voltages can occur across the inductive output load. The diodes force the motor currents to continue flowing in their direction and protect the switching components against imposed voltages. The reactive power required by the motor is also handled by the freewheeling diodes.

3.6 Modulation Principles

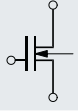
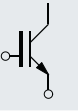
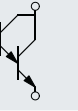
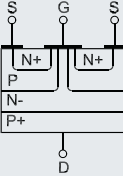
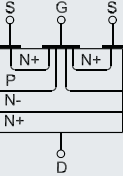
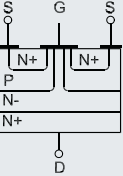
The semiconductors in the inverter either conduct or block according to the signals generated by the control circuit. The variable voltages and frequencies are generated using two basic principles (types of modulation):

- Pulse Amplitude Modulation (PAM) and
- Pulse Width Modulation (PWM)

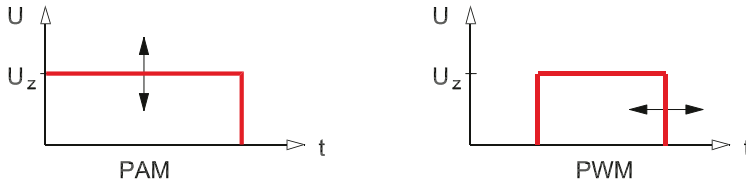

Fig. 3.14 Modulation of amplitude and pulse width

3.6.1. Pulse Amplitude Modulation (PAM)

PAM is used in AC drives with variable intermediate circuit voltage or current. In drives with uncontrolled or half-controlled rectifiers, the amplitude of the output voltage is generated by the intermediate circuit chopper, shown in Fig. 3.9 Variable DC voltage intermediate circuit. In a case where the rectifier is fully controlled, the amplitude is generated directly. This means that the output voltage for the motor is made available in the intermediate circuit.

The intervals during which the individual semiconductors should be on or off are stored in a pattern, and this pattern is read out at a rate dependent on the desired output frequency.

This semiconductor switching pattern is controlled by the magnitude of the intermediate circuit variable voltage or current. If a voltage-controlled oscillator is used, the frequency always follows the amplitude of the voltage.

Using PAM can result in lower motor noise and very minor efficiency advantages in special applications like high speed motors (10.000 – 100.000 RPM). However, this often does not overrule the drawbacks like higher costs for the more sophisticated hardware and control issues like higher torque ripples at low speed.

3.6.2 Pulse width Modulation (PWM)

PWM is used in AC drives with constant intermediate circuit voltage. This is the most widely-established and best developed method. Compared with PAM, the hardware requirements for this modulation method are lower, control performance at low speed is better and brake resistor operation is always possible.

The motor voltage can be varied by applying the intermediate circuit (DC) voltage to the motor windings for a certain length of time. The frequency can be varied by shifting the positive and negative voltage pulses for the two half periods along the time axis.

Because the technology varies the width of the voltage pulses, it is called "Pulse Width Modulation" or PWM. With conventional PWM techniques, the control circuit determines the on and off times of the semiconductors in a way which makes the motor voltage waveform as sinusoidal as possible. Thus, the losses in the motor winding can be reduced and a smooth motor operation, even at low speed is achieved.

The output frequency is varied by connecting the motor to half the intermediate circuit voltage for a specific period of time. The output voltage is varied by dividing the voltage pulses of the AC drive output terminals into a series of narrower individual pulses with pauses in between. The pulse-to-pause ratio can be modified depending on the required voltage level. This means that the amplitude of the negative and positive voltage pulses always corresponds to half the intermediate circuit voltage.

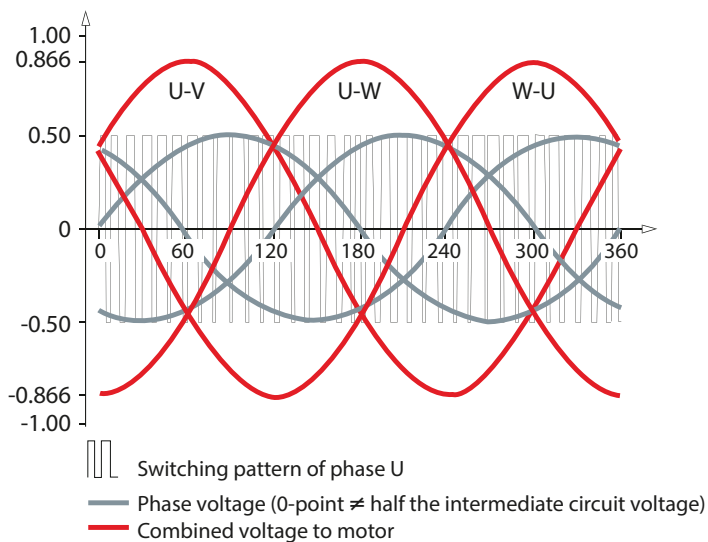

Fig. 3.15 Output voltage PWM

A low switching frequency leads to an increase in acoustic motor noise. To limit the amount of noise produced, the switching frequency can be increased. This has been made possible thanks to advances in the field of semiconductor technology, which mean that the generation of an approximately sinusoidal current is now achievable. A PWM AC drive that relies exclusively on sinusoidal reference modulation can provide up to 86.6% of the rated voltage (see Fig. 3.15 Output voltage PWM).

The phase voltage at the AC drive output terminals corresponds to half the intermediate circuit voltage divided by $\sqrt{2}$ and is thus equal to half the mains line voltage. The line voltage of the output terminals is equal to $\sqrt{3}$ times the phase voltage and is thus equal to 0.866 times the mains supply voltage.

The output voltage of the AC drive cannot equal the motor voltage if full sinusoidal wave form is needed, as the output voltage would be roughly 13 % too low. However, the extra voltage needed can be obtained by reducing the number of pulses when the frequency exceeds approximately 45 Hz. The disadvantage of using this method is that it makes the voltage alternate step-wise and the motor current becomes unstable. If the number of pulses is reduced, the harmonic content at the AC drive output increases. This results in higher losses in the motor.

For example, one common reference voltage uses the third harmonic of the sine reference. By increasing the amplitude of the sine reference by 15.5 % and adding the third harmonic, a switching pattern for the inverter semiconductors can be obtained which increases the output voltage of the AC drive. All control values of the inverter are transmitted from the control board, and the various reference signals for determining the switching times are stored in a table in memory and are then read out and processed according to the reference value.

There are other ways of determining and optimizing the on and off switching times of the semiconductors. The Danfoss VVC and VVC+ control principles are based on microprocessor calculations which identify the optimum switching times for the inverter semiconductors (see chapter 2.8).

The specifications for the software involved in calculating the switching times are manufacturer-specific and will not be covered here.

If more stringent requirements are imposed on the AC drive speed setting range and smooth-running characteristics, then the PWM switching times need to be determined by an additional digital IC rather than the microprocessor. For example, a DSP (Digital Signal Processor) or a FPGA (Field Programmable Gate Array) can determine the PWM switching times. This component incorporates the manufacturer's proven knowledge. Meanwhile, the microprocessors are responsible for handling other control tasks.

3.6.3 Asynchronous PWM

Two asynchronous PWM methods are described below:

- SFAVM (Stator Flux-oriented Asynchronous Vector Modulation)
- 60° AVM (Asynchronous Vector Modulation)

These enable the amplitude and angle of the inverter voltage to be changed in steps.

3.6.3.1 SFAVM

Stator Flux-oriented Asynchronous Vector Modulation (SFAVM) is a space-vector modulation method that makes it possible to change the inverter voltage arbitrarily, but step-wise within the switching time (in other words, asynchronously). The main purpose of this type of modulation is to maintain the stator flux at the optimum level throughout the stator voltage range, ensuring no torque ripple. Compared with the mains supply, a “standard” PWM supply will result in deviations in the stator flux vector amplitude and the flux angle. These deviations will affect the rotating field (torque) in the motor air gap and will cause torque ripple. The effect produced by the deviation in amplitude is negligible and can be reduced by increasing the switching frequency.

The deviation in the angle depends on the switching sequence and can result in higher levels of torque ripple. Consequently, the switching sequence must be calculated in such a way as to minimize the deviation in the vector angle.

Each inverter branch of a 3-phase PWM inverter can assume two switch states, ON or OFF, as shown in Fig. 3.16 Inverter switch states. The three switches result in eight possible switch combinations, leading in turn to eight discrete voltage vectors at the inverter output or at the stator winding of the connected motor. As shown below, these vectors (100, 110, 010, 011, 001, 101) mark the corners of a hexagon, where 000 and 111 are zero vectors.

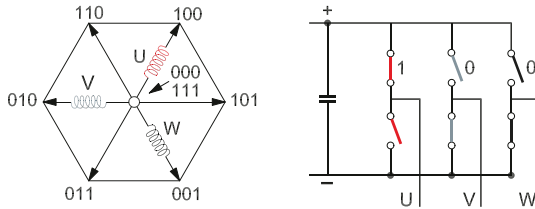

Fig. 3.16 Inverter switch states

With switch combinations 000 and 111, the same potential occurs at all three output terminals of the inverter. This will be either the positive or negative potential from the intermediate circuit, as shown in Fig. 3.16 Inverter switch states. As far as the motor is concerned, this is the equivalent to a terminal short circuit and so a voltage of 0 V is applied to the motor windings.

Generation of motor voltage

Steady-state operation involves controlling the machine voltage vector U_{wt} on a circular path. The length of the voltage vector is a measure of the value of the motor voltage and the speed of rotation corresponds to the operating frequency at a specific time. The motor voltage is generated by briefly pulsing adjacent vectors to produce an average value.

Some of the features of the Danfoss SFVM method are as follows:

- The amplitude and angle of the voltage vector can be controlled in relation to the preset reference without deviations occurring
- The starting point for a switching sequence is always 000 or 111. This enables each voltage vector generated to have three switch states
- The voltage vector is averaged by means of short pulses on adjacent vectors as well as the zero vectors 000 and 111

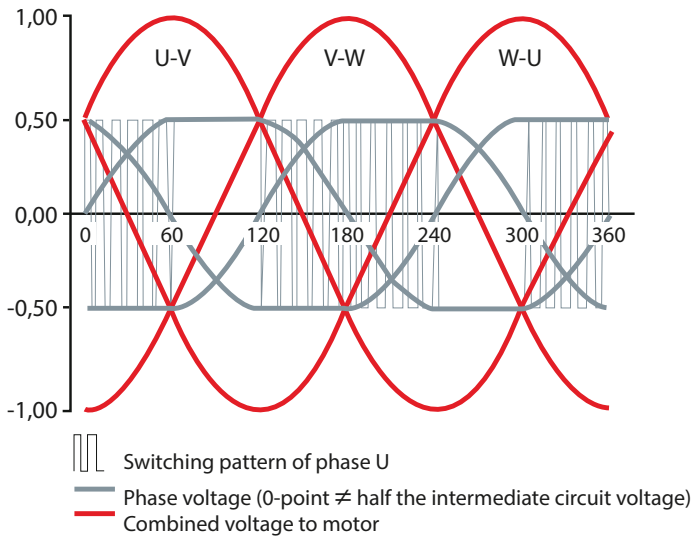

Fig. 3.17 With the synchronous 60° PWM principle the full output voltage is obtained directly

SFVM provides a link between the control system and the power circuit of the inverter. The modulation is synchronous to the control frequency of the controller and asynchronous to the fundamental frequency of the motor voltage. Synchronization between control and modulation is an advantage for high- power control (for example, voltage vector, or flux vector control), since the control system can control the voltage vector directly and without limitations. Amplitude, angle and angular speed are controllable.

In order to dramatically reduce the real-time calculation time, the voltage values for different angles are listed in a table. Fig. 3.18 Output voltage (motor) – (phase-phase) shows the motor voltage at full speed.

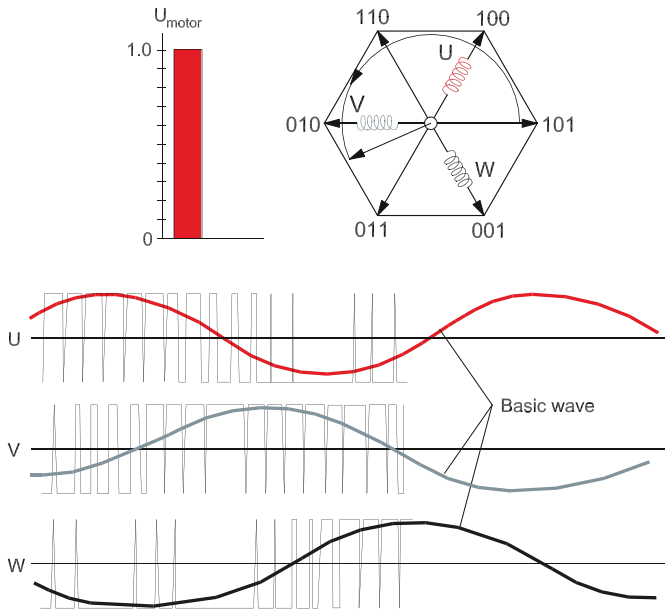

Fig. 3.18 Output voltage (motor) – (phase-phase)

Low Speed Performance

Continuously pulsing all six inverter IGBTs to simulate the required output sine wave is ideal for low speed operation. It ensures smooth motor operation and allows the drive to meet the demanding requirements of starting high friction or high inertia loads. However, this switching pattern is not suited for high speed operation. Continuously pulsing all six inverter IGBTs causes extra inverter switching losses, increased heat generation, and reduced drive efficiency. In addition, if a pure sine wave template is followed for each line-to-neutral voltage, the maximum output voltage is limited to 87% of the input voltage. This makes it impossible to produce rated motor power without exceeding rated motor current. To obtain higher full speed voltages, some conventional PWM drives add third and ninth harmonics to their reference AC wave. Without full voltage on the motor, conventional PWM waveforms use the motor's service factor to produce rated output from the motor. This reduces motor life.

3.6.3.2 60° AVM

If 60° AVM (Asynchronous Vector Modulation) is used – as opposed to the SFVM principle – the voltage vectors are determined as follows:

- Within one switching period, only one zero vector (000 or 111) is used
- A zero vector (000 or 111) is not always used as the starting point for a switching sequence
- One phase of the inverter is held constant for 1/6 of the period (60°). The switch state (0 or 1) remains the same during this interval. In the two other phases, switching is performed in the normal way

Fig. 3.19 Switching sequence of the 60° AVM and SFAVM methods for a number of 60° intervals and Fig. 3.20 Switching sequence of the 60° AVM and SFAVM methods for several periods compare the switching sequence of the 60° AVM method with that of the SFAVM method – for a short interval (Fig. 3.19) and for several periods (Fig. 3.20).

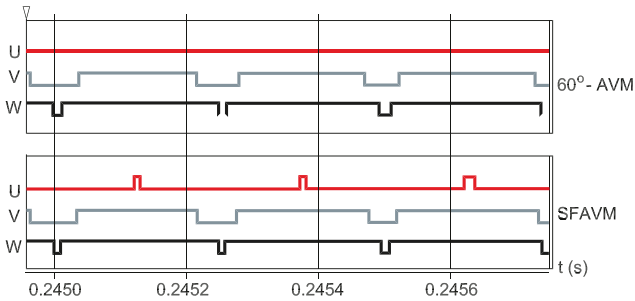

Fig. 3.19 Switching sequence of the 60° AVM and SFAVM methods for a number of 60° intervals

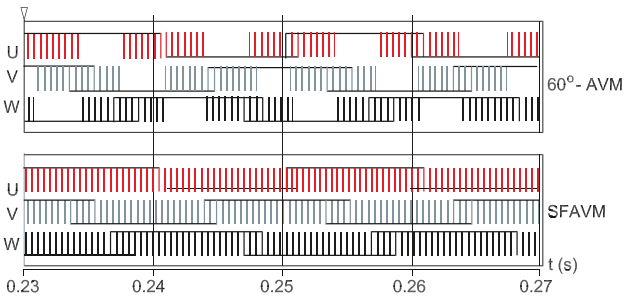

Fig. 3.20 Switching sequence of the 60° AVM and SFAVM methods for several periods

High Speed Efficiency and Full Motor Output

Because of the high-speed limitations of SFAVM, the 60° AVM is preferred above a predefined output frequency. Above this speed, the microprocessor control holds each IGBT on for 60° of the full cycle and off for another 60° of the full cycle. By doing no switching in each inverter IGBT during 120° of each output cycle, the drive minimizes switching losses. In addition, this unique switching pattern allows the drive to provide the motor with full rated voltage. This allows the motor to produce full rated torque at full speed without creating excessive motor heating.

3.7 Control Circuit and Methods

The control circuit, or control board, is the fourth main component of the AC drive. The three hardware components dealt with so far (rectifier, intermediate circuit and inverter) are nearly always based on the same principles and components regardless of the manufacturer. In most cases, these components are standard, nearly always purchased from the same external

manufacturers. The control circuit design stands in contrast to these, as the area where the AC drive manufacturer concentrates all its acquired knowledge.

In principle, the control circuit has four main tasks:

- Controlling the AC drive semiconductors. The semiconductors determine the anticipated dynamic characteristics or accuracy
- Exchanging data between the AC drive and peripherals (PLCs, encoders)
- Measuring, detecting and displaying faults, conditions and warnings
- Performing protective functions for the AC drive and motor

Using microprocessor technology, with single or dual processors, it is possible to increase control circuit speeds using ready-made pulse patterns that are stored in memory. As a result, there is a significant reduction in the number of calculations required.

With this type of control, the processor is integrated into the AC drive and is always able to determine the optimum pulse pattern for each operating stage. There are a variety of control methods available for determining the dynamic characteristics and response time in the event of a change in reference or torque as well as the positioning accuracy of the motor shaft.

In general, the basic functions of an AC drive can be summed up as follows:

- Rotating and positioning the rotor
- Open or closed-loop speed control of the AC motor
- Open or closed-loop torque control of the AC motor
- Monitoring and signaling operating states

Categorizing the various voltage-source AC drives available on the market (according to the form of control), at least six different types can be identified:

- Simple (scalar) without compensation control
- Scalar with compensation control
- Space vector control
- Open loop flux (field-oriented) control
- Closed loop flux (field-oriented) control
- Servo-controlled systems

This classification is illustrated in Fig. 3.21 Speed control performance control classification and Fig. 3.22 Torque performance control classification. Here, the reaction time refers to how long the AC drive needs to calculate a corresponding signal change to its output when there is a signal change at the input. The motor characteristics determine how long it takes to register a response on the motor shaft when an input signal is applied to the input of the AC drive.

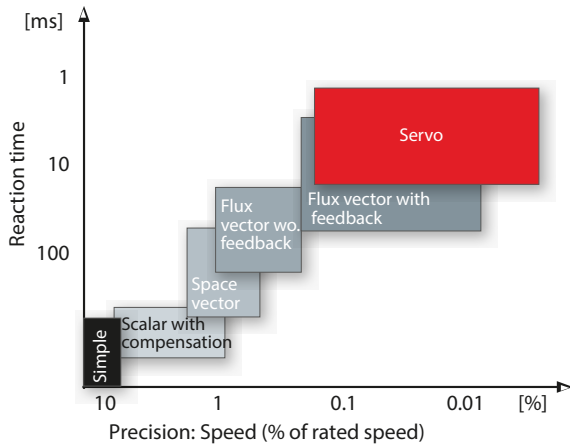

Fig. 3.21 Speed control performance control classification

The rated motor frequency is used as the basis for establishing the speed accuracy. The rated motor frequency is 50 Hz in most countries, and 60 Hz in the US. AC drives can be classified according to price/performance ratio. That is, an AC drive that uses a simple control method is better value for money for performing very simple tasks, than one featuring field-oriented control.

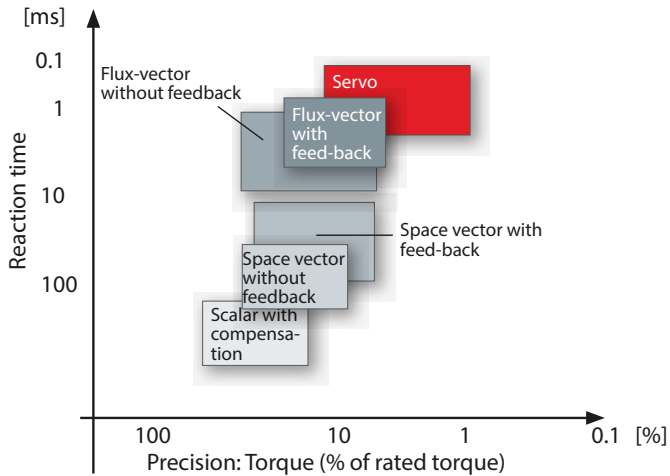

Fig. 3.22 Torque performance control classification

The speed setting ranges associated with the individual AC drive types are roughly as follows:

- Simple (scalar) without compensation 1:15
- Scalar with compensation 1:25
- Space vector 1:100(0)
- Flux (field-oriented) open loop 1:1000
- Flux (field-oriented) close loop 1:10.000
- Servo 1:10.000

The torque control performance can be classified as follows:

- The reaction time may be defined in the same way as for speed control
- The accuracy is determined in relation to the motor's rated torque

Please note that AC drives that rely on a simple control method cannot be used for either open-loop or closed-loop control of the motor torque.

3.7.1 Simple control method

This type of control is rarely used today. The control is in principle a fixed relationship between desired motor speed and a motor voltage. The model can be more or less refined, but the major disadvantages are:

- Unstable motor speed
- Difficult start of the motor
- No protection of the motor

The only advantage of simple control could be the low price, but since basic components for sensing motor characteristics are relatively low-cost, very few manufacturers now pursue this method.

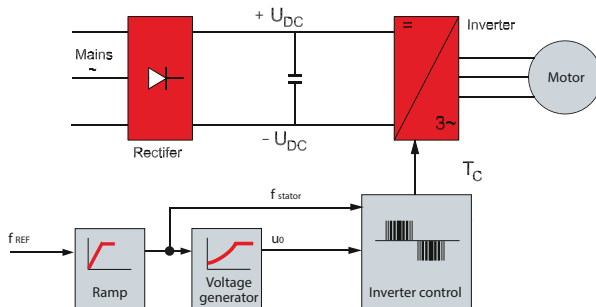

Fig. 3.23 Structure of an AC drive with Simple Control Method

3.7.2 Scalar Control with Compensation

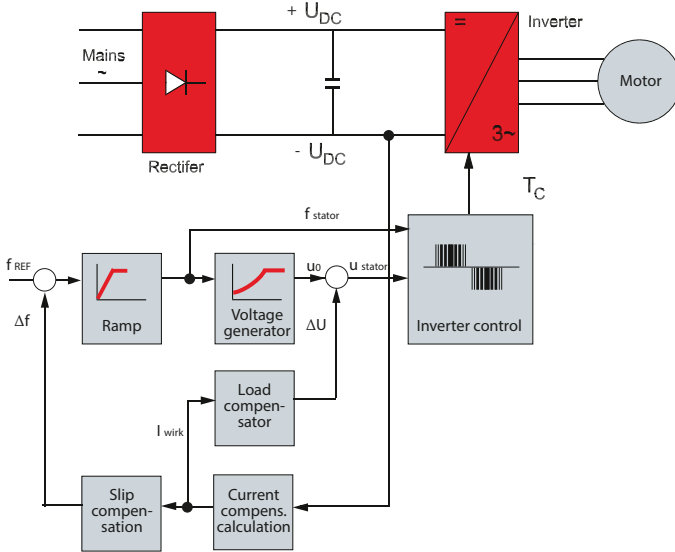

Fig. 3.24 Structure of a Scalar Type AC drive with compensation

When compared with simple control, an AC drive with compensations adds three new control function blocks as illustrated in Fig. 3.24 Structure of a Scalar Type AC drive with compensation.

The load compensator uses the current measurement to calculate the additional voltage (ΔU) required to compensate for the load on the motor shaft.

The current is typically measured by means of a resistor (shunt) in the intermediate circuit. It is assumed that the power in the intermediate circuit is equal to the power consumed by the motor. If several active switch positions are combined, these can be used to reconstruct all the phase current information.

Basic features:

- Voltage/frequency [U/f] control with load and slip compensation
- Control of voltage amplitude and frequency

Typical shaft output:

- Speed setting range 1:25
- Speed accuracy $\pm 1\%$ of rated frequency
- Acceleration torque 40-90% of rated torque
- Speed change response time 200-500 ms
- Torque control response time Not available

Typical features:

- Improved control properties compared with simple scalar control
- Able to withstand sudden changes in load
- No external feedback signal required
- Unable to solve resonance problems
- No torque control properties
- Problems occur when attempting to control high-power motors
- Problems in the event of load changes in the low speed range

3.7.3 Space Vector with and without Feedback

The space vector control method is available with (“closed loop”) or without (“open loop”) an external motor speed feedback. A feature allowing motor current polar transformation is added to the control (in the components responsible for magnetization and torque-generating current).

The voltage angle (θ) is regulated in addition to the voltage (U) and frequency (f).

Basic features:

- Voltage vector control in relation to steady-state characteristic values (static)

Typical features:

- Improved dynamic performance compared with scalar control
- Very good at withstanding sudden changes in load (compared with scalar plus compensation)
- Operation at the current limit
- Possibility of active resonance dampening
- Possibility of open-loop/closed-loop torque control
- High starting and holding torque
- Problems during rapid reversing compared with flux vector
- No “rapid” current control

3.7.3.1 Space Vector (Open Loop)

If the space vector is determined without external speed feedback then the speed and position will be calculated by the control software and is based on information about motor current and motor frequency which is measured (see example on page 77, Fig. 3.28 Basic principles of Danfoss VVC+ control).

Basic features:

- Voltage vector control in relation to steady-state characteristic values (static)

Typical shaft output:

- Speed setting range 1:100
- Speed accuracy (steady state) $\pm 0.5\%$ of rated frequency
- Acceleration torque 80-130% of rated torque
- Speed change response time 50-300 ms
- Torque change response time 20-50 ms

3.7.3.2 Space Vector (Closed Loop)

For the closed loop space vector method, an encoder or other device to detect the motor speed or position is required. It is the control software, the resolution on the feedback input and encoder's resolution that determines the accuracy of motor control.

Typical shaft output:

- Speed setting range 1:1000 – 10000
- Speed accuracy (steady state) Depends on resolution of feedback component used
- Acceleration torque 80 – 130% of rated torque
- Speed change response time 50 – 300 ms
- Torque change response time 20 – 50 ms

3.7.4 Open Loop and Closed Loop Flux Vector Control

Flux vector control is also referred to as field-oriented control. The control methods referred to above control the motor magnetic flux via the stator. With field-oriented control, the rotor flux is controlled directly. The following motor variables are controlled within this context:

- Speed
- Torque

Once the rated data for the motor has been entered, a magnetic flux model can be used to determine the necessary voltage and angle for ensuring optimum motor magnetization. The measured motor current is converted into a torque-generating current and a magnetizing current. An internal PID controller is responsible for controlling the speed, with the feedback value being estimated on the basis of the measured motor current.

3.7.4.1 Flux Vector (Open loop)

Flux control requires accurate information about the condition, temperature and rotor position of the motor. It is a challenge to run open loop while the motor condition is being simulated. Obtaining optimum performance can be difficult, especially at low motor speed.

Typical shaft output:

- Speed setting range 1:1000
- Speed accuracy (steady state) $\pm 0.5\%$ of rated frequency
- Acceleration torque 100-150% of rated torque
- Speed change response time 50-200 ms
- Torque change response time 0.5-5 ms

3.7.4.2 Flux Vector (Closed Loop)

For the closed loop flux vector control method, an encoder or similar sensor is required on the motor shaft. The control software and the feedback resolution determine the accuracy of motor control.

Control is performed in exactly the same way as with open loop methods. However, in this case the speed is calculated from the encoder signals rather than being estimated. Flux vector control is illustrated in Fig. 3.25 Structure of closed loop flux vector control.

Typical shaft output:

- Speed setting range 1:1000 – 10000
- Speed accuracy (steady state) Dependent on the feedback signal (encoder) used
- Acceleration torque 100 – 150% of rated torque
- Speed control response time 5.00 – 50 ms
- Torque control response time 0.50 – 5 ms

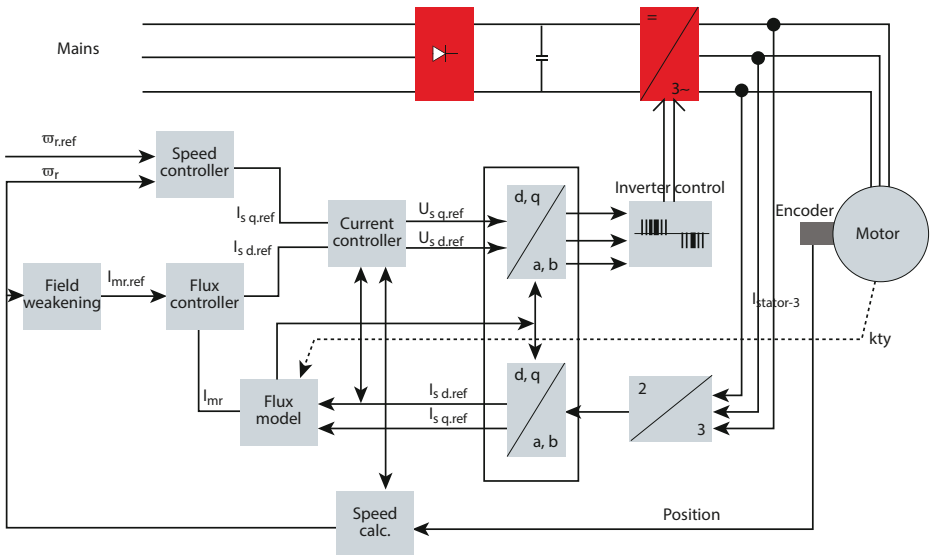

Fig. 3.25 Structure of closed loop flux vector control

3.7.5 Servo Drive Control

The servo converter control method will not be explored in depth here. One common method is very similar to closed loop flux control, but to ensure high dynamic response, the power components and hardware may be upgraded as much as two, three or four times the power components in an AC drive to ensure available current and torque.

3.7.6. Integrated Motion Controller

Positioning and synchronization operations are typically performed using a servo drive or a motion controller. However, many of these applications do not actually require the dynamic performance available from a servo drive.

High-precision positioning and synchronization can also be performed simply using an AC drive. To save time and cost, Danfoss has developed the Integrated Motion Controller (IMC) functionality, which can replace more complex positioning and synchronization controllers in single-axis positioning and synchronizing applications.

The IMC can be set to run in Positioning, Synchronizing or Homing mode.

Positioning

In positioning mode, the drive controls movement over a specific distance (relative positioning) or to a specific target (absolute positioning). The drive calculates the motion profile based on target position, speed reference and ramp settings. There are 3 positioning types using different references for defining the target position:

- Absolute positioning: Target position is relative to the defined zero point of the machine
- Relative positioning: Target position is relative to the actual position of the machine
- Touch probe positioning: Target position is relative to a signal on a digital input

Synchronizing

In synchronizing mode, the drive follows the position of a master. Multiple drives can follow the same master. The master signal can be an external signal e.g. from an encoder, a virtual master signal generated by a drive or master positions transferred by fieldbus. Gear ratio and position offset is adjustable by parameter.

Homing

With sensorless control and closed loop control with an incremental encoder homing is required to create a reference for the physical position of the machine after power up. There are several home functions with and without sensor to choose from. The home synchronizing function can be used to continuously realign the home position during operation when there is some sort of slip in the system. For example, in case of sensorless control with an induction motor or in case of slip in the mechanical transmission.

3.7.7. Control Conclusions

In conclusion, all control methods are primarily handled by the software. The more dynamic the motor control needs to be, the more complex the control algorithm required.

A similar principle applies for initial use of an AC drive. Initial use of a simple AC drive does not involve a great deal of programming. In most cases, all you have to do is enter the motor data. However, for applications that require a flux vector control or critical applications like hoists, more complex programming is required, right from initial use.

Because the control is mainly a software issue, many manufacturers have implemented several control methods in their units, for example U/f, space vector, or field-oriented control. Parameters are needed to switch from one control method to another, for example from space vector control to the flux vector method. Pop-up menus help the operator to set the parameters needed for each control method, in order to meet the application demands.

3.8 Danfoss Control Principles

A general overview of the standard current control principles for Danfoss AC drives is illustrated in Fig. 3.26 Basic principles of current standard AC drive from Danfoss.

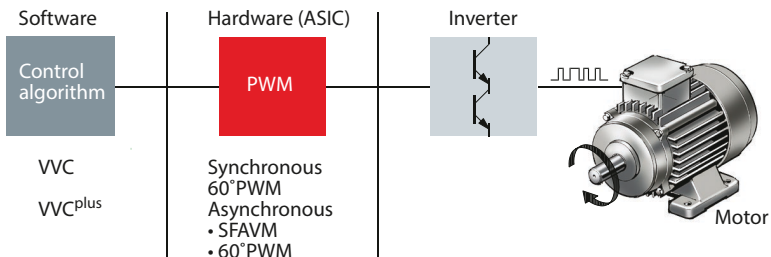

Fig 3.26 Basic principles of current standard AC drives from Danfoss

The PWM switching patterns are calculated for the inverter using the selected control algorithm. U/f control is suitable for applications involving

- Special motors
- Motors connected in parallel

In the case of the applications referred to above, no compensation of the motor is required. With the VVC+ control principle, the amplitude and angle of the voltage vector are controlled directly, as is the frequency. At the heart of this method lies a straightforward, yet robust, motor model. The type of control method involved is called Voltage Vector Control (VVC).

Some of the features offered include:

- Improved dynamic properties in the low speed range (0 - 10 Hz)
- Improved motor magnetization
- Speed control range: 1:100 open loop
- Speed accuracy: $\pm 0.5\%$ of the rated speed without feedback
- Active resonance dampening
- Torque control
- Operation at the motor current limit

3.8.1 Danfoss VVC+ Control Principle

The Danfoss VVC+ control principle uses a vector modulation method for constant voltage-source PWM inverters. Depending on the application control demands, the motor equivalent diagram can be simplified (that is, the iron, copper and air flow losses are ignored) or used in its full complexity.

Example:

A simple fan or pump application control uses a simplified motor diagram. However, a dynamic hoist application requiring flux vector control requires the complex motor equivalent diagram, accounting for all losses in the control algorithm.

The inverter switching pattern is calculated using either the SFAVM or 60° AVM principle, to keep the pulsating torque in the air gap very small. The user can select the preferred operating principle or allow the control to select one automatically on the basis of the heatsink temperature. When the temperature is below 75°C , the SFAVM principle is used for control. At temperatures above 75° , the 60° AVM principle is applied.

The control algorithm takes two operating conditions into consideration:

- No-load state (idle state), see Fig. 3.27a Motor equivalent circuit diagram under “no-load”. In the no-load state, there is no load on the motor shaft. For conveyors the no-load state literally means no products are being transported. It is simply assumed the current drawn by the motor is only needed for magnetization and compensation for losses. The active current is considered to be nearly zero. The no-load voltage (U_L) is determined based on the motor data (rated voltage, current, frequency, speed).

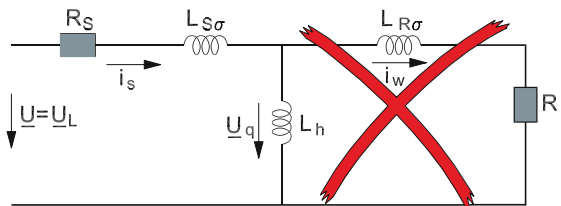

Fig.3.27a Motor equivalent circuit diagram under “no-load”

- Loaded state

The motor shaft is loaded, implying that products are being transported, as shown in Fig. 3.27b Motor equivalent circuit diagram under "load".

The motor draws more current when it is loaded. To produce the required torque, the active current (I_w) is needed. Losses in the motor (especially in lower speed range) need to be compensated for. A load-dependent additional voltage (U_{Comp}) is made available to the motor:

$$U = U_{LOAD} = U_L + U_{Comp}$$

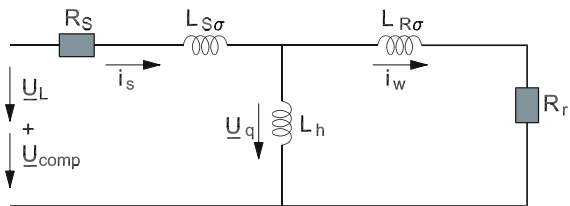

Fig. 3.27b Motor equivalent circuit diagram under "load"

The additional voltage U_{Comp} is determined using the currents measured under the two conditions mentioned above (loaded and no-load) as well as the speed range: low or high speed. The voltage value and the speed range are then determined based on the rated motor data.

The control principle is illustrated in the block diagram below:

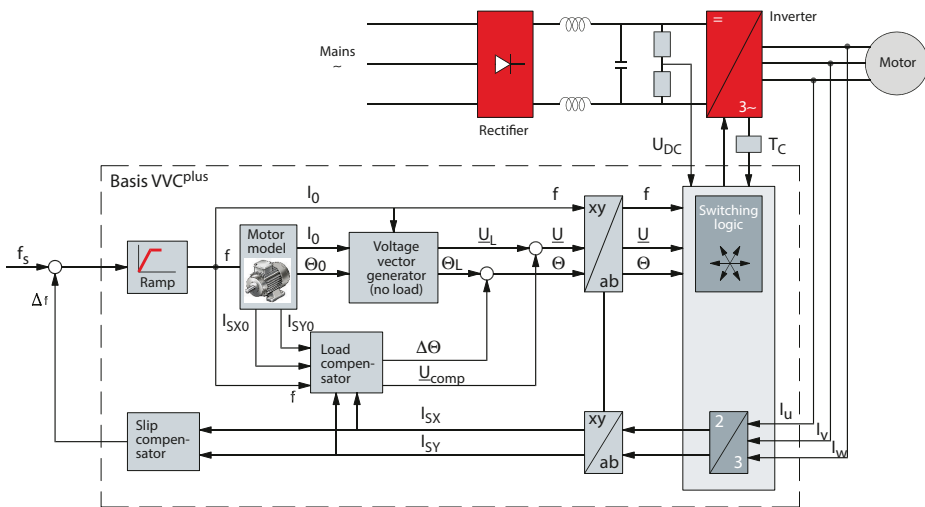

Fig. 3.28 Basic principles of Danfoss VVC+ control

As shown in Fig. 3.28 Basic principles of Danfoss VVC+ control, the motor model calculates the no-load references (currents and angles) for the load compensator (I_{SX} , I_{SY}) and the voltage vector generator (I_0 , θ_0).

The voltage vector generator calculates the no-load voltage (U_L) and the angle (θ_L) of the voltage vector on the basis of the no-load current, stator resistance and stator inductance.

The measured motor currents (I_u , I_v and I_w) are used to calculate the reactive current (I_{SX}) and active current (I_{SY}) components.

Based on the calculated currents (I_{SX0} , I_{SY0} , I_{SX} , I_{SY}) and the voltage vector actual values, the load compensator estimates the air-gap torque and calculates how much extra voltage (U_{Comp}) is required to maintain the magnetic field strength at the reference value. It then corrects the angle deviation ($\Delta\theta$) that is to be expected due to the load on the motor shaft. The output voltage vector is represented in polar form (ρ). This enables direct overmodulation and facilitates connection to the PWM.

Voltage vector control is particularly useful for low speeds, where the dynamic performance of the drive can be significantly improved (compared with U/f control) by means of appropriate control of the voltage vector angle. In addition, steady-state behavior improves, since the control system can make better estimates for the load torque on the basis of the vector values for both voltage and current than it would be able to on the basis of the scalar signals (amplitude values).

f	Internal frequency
f_s	Reference frequency set
Δf	Calculated slip frequency
I_{SX}	Reactive current (calculated)
I_{SY}	Active current (calculated)
I_{SX0}, I_{SY0}	No-load current of x/y axis (calculated)
I_U, I_V, I_W	Measured phase current (U, V, W)
R_S	Stator resistance
R_R	Rotor resistance
θ	Voltage vectors angle
θ_0	"No-load" theta value
$\Delta\theta$	Load-dependent angular compensation
T_C	Heat-sink temperature (measured)
U_{DC}	Intermediate circuit voltage
U_L	No-load voltage vector
U_S	Stator voltage vector
U_{Comp}	Load-dependent voltage compensation
U	Motor supply voltage
X_h	Reactance
X_1	Stator leakage reactance
X_2	Rotor leakage reactance
ω_s	Stator frequency
L_S	Stator inductance
L_{Ss}	Stator leakage inductance
L_{Rs}	Rotor leakage inductance

Table 3.3 explanations of symbols used in:

Fig. 3.24 Structure of simple control method

Fig. 3.25 Structure of closed loop flux vector control

Fig. 3.26 Basic principles of current standard AC drives from Danfoss

Fig. 3.27a Motor equivalent circuit diagram under "no-load"

Fig. 3.27b Motor equivalent circuit diagram under "load"

Fig. 3.28 Basic principles of Danfoss VVC+ control

3.8.2 Danfoss Flux Vector Control Principle

The principle of flux vector control assumes that a complete equivalent circuit diagram data is available. With this approach, all the relevant motor parameters are considered by the control algorithms. Considerably more motor data needs to be specified than is the case with the basic VVC+ control.

Changing a single parameter during commissioning switches the control algorithm from VVC+ control to flux vector control. Here more information needs to be fed in to the drive for smooth control of the motor. All parameters will not be explained here as they are fully explained in the operation manuals.

A brief description of the control strategy is shown in Fig. 3.29 Basic principles of Danfoss Flux Vector control. A flux database is stored in the AC drive. The currents measured in all 3 phases are transformed in to polar coordinates (x, y).

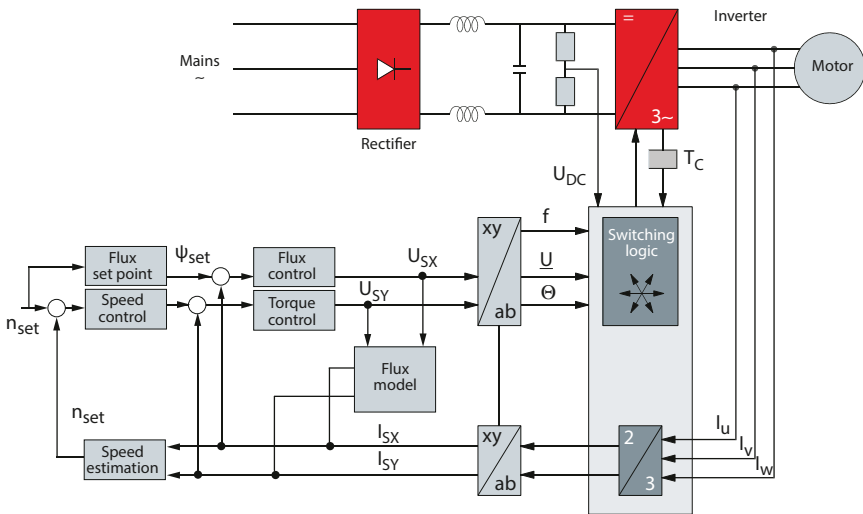

Fig. 3.29 Basic principles of Danfoss Flux Vector control

3.9 Medium Voltage Drives

With infrastructures around the world developing and heavy industries becoming more important, the need for higher power output is growing. Motors are getting bigger in many industries and in a wide range of driven equipment. Medium-voltage AC drives are needed to satisfy the customers' and users' needs for AC drives in the medium and high-power range. When the required power output increases, there comes a point when it makes sense to switch from LV drives to MV drives. It is not practical nor is it economical to use LV drives in the upper power range. Above a certain power requirement there is no other choice than MV drives. The higher voltage enables lower current, fewer losses and reduced system costs.

Due to technology advancements in semiconductor devices such as IGBTs, modern MV drives are increasingly used in petrochemical, mining, steel and metal, transportation industries among others to conserve electric energy, increase productivity and improve product quality. The development of MV drives is also motivated by the improvement in the efficiency, weight and volume of the motor and in the reduced installation costs related to transformers, cable sizes, cable trays etc.

MV drives are classified to cover a power range of 0.2 MW to almost 40 MW at the MV level of 2.3–13.8 kV. However, most of the installed MV drives in industrial settings are in the range of 1–4 MW, with voltage ratings of 3.3–6.6 kV.

3.9.1 MV Semiconductors

There are different types of semiconductors used in MV drives. These include the IGBT, the integrated gate-commutated thyristor (IGCT) and the injection enhanced gate transistor (IEGT). The most commonly used semiconductor device is the power diode, which is widely used for uncontrolled rectifiers and as a freewheeling diode in antiparallel connections with power switches.

The IGBT is the dominant technology in low-power and low-voltage applications. Nevertheless, there are drive topologies that can arrange them to reach MV operation. Recent developments have resulted in IGBTs with higher-voltage blocking capability closer to the IGCT, also known as MV-IGBT, HV-IGBT and IEGT. Currently, the IGBT and IGCT are the most commonly used semiconductors in the market.

3.9.2 MV Drive Topologies

Research and development in MV drives has been very active during the last decade. In fact, several new commercial MV drive topologies have been introduced. The main reason for the development has been an increase in industrial processes demanding higher power, MV operation, and variable speed capability. As a result, different drive topologies have been developed to meet the requirements of different applications.

The main components of MV drives are like those used in LV drives: rectifier, DC-link, inverter and optional grid and motor side filters. The rectifier can be either controlled or uncontrolled, regenerative or nonregenerative. In addition, MV drives can be classified into two-level and multilevel converters depending on the number of voltage levels generated at the output.

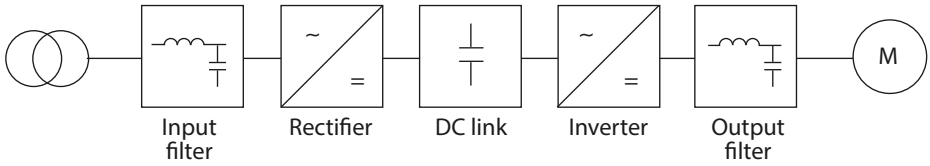

Fig. 3.30 Block Diagram of a Typical MV Drive

Some of the most common MV drive topologies are listed below.

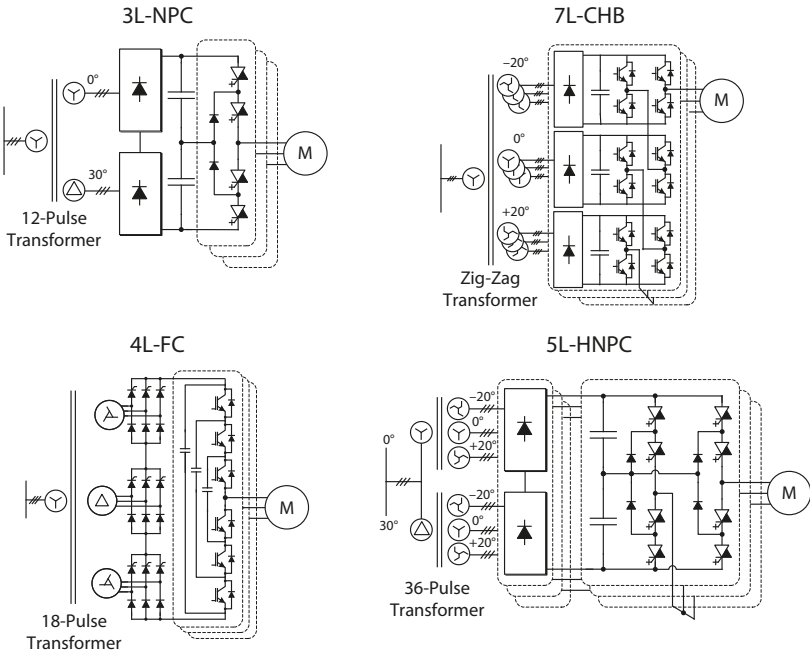

Fig. 3.31 Different MV Drive Topologies

Three-Level Neutral-Point-Clamped Converter (3L-NPC)

The 3L-NPC uses an arrangement of four power switches per leg, clamped with diodes to a midpoint of the DC-link. Each switch blocks half of the total DC-link voltage, enabling MV operation with IGCT and HV-IGBT devices. The converter clamps the phase output to the neutral point, generating an extra voltage level compared to two-level converters.

The 3L-NPC is a simple and proven topology. The main benefits include reduced dv/dt and THD in its AC output voltages. More importantly, the inverter can be used in the MV drive to reach a certain voltage level without switching devices in series. A disadvantage of this topology is, that it requires voltage balancing of the DC-link capacitor voltages.

Cascaded H-Bridge Converter (CHB)

The CHB multilevel inverter is one of the most popular converter topologies used in MV drives. It is composed of multiple units of single-phase three-level H-bridge power cells. The H-bridge cells are normally connected in cascade on their AC side to increase the converter voltage and to achieve MV operation. The number of output voltage levels is $2k+1$, where k is the number of cells.

Because of the high amount of output voltage levels, this converter does not require an output filter for most applications. The main drawback of this topology is the need of isolated DC sources to power each H-bridge, which requires a complicated phase-shifting transformer. However, this transformer together with diode rectifiers forms a multipulse configuration with very low input current distortion and eliminates the need to balance capacitor voltages. Because of the complicated front end, it is uncommon to see this converter in highly regenerative applications, and the great majority feature diode front ends.

In practice, the number of power cells in a CHB inverter is mainly determined by its operating voltage and manufacturing cost. The use of identical power cells leads to a modular structure, which is an effective means for cost reduction. Due to this, commercial CHBs can be found up to 17 levels and 13.8 kV with low voltage IGBT technology. The most common configurations are the seven-level CHB at 3.3 kV and 13-level CHB at 6.6 kV.

Four-Level Flying Capacitor Converter (4L-FLC)

This topology has evolved from the two-level inverter by adding DC capacitors to the cascaded switches. There are three complementary switch pairs in each of the inverters. Each pair of switches with one flying capacitor forms a power cell. Additional cells can be connected, increasing the number of voltage levels of the converter, and the topology is therefore considered a modular structure. The FLC can produce an inverter phase voltage with four voltage levels, while reducing the voltage stress on the power switches.

However, the practical use of the FLC inverter is limited due to the use of many capacitors and a complex control scheme.

Five-Level H-Bridge NPC Converter (5L-HNPC)

The 5L-HNPC bridge inverter is developed from the 3-L NPC and CHB topologies. It is composed of two 3L-NPC legs forming an H-bridge per phase. This generates a five-level voltage output waveform while significantly increasing the capacity of the converter. The inverter does not have any switching devices in series, which eliminates the device dynamic and static voltage sharing problems. Like the CHB, this topology requires isolated DC supplies for each H-bridge, which increases the complexity and cost of the DC supply system. However, like the CHB, this comes with significant improvement in the grid-side currents and leads to lower dv/dt and total harmonic distortion (THD).

All the different converter topologies have advantages and drawbacks. Although each one has some features in which they excel over the others, no topology outperforms the others in every technical requirement. They each cater to the needs of different applications.

3.10 Standards and Legislations

As for all other products, legislations and technical standards are available worldwide to ensure safe operation of AC drives.

Legislation is issued by the legislative branch of national or local government and can of course be different in the different countries around the globe. However, it is mandatory to comply with – it is law. It is a political document, typically free of specific technical details – these details can be found in standards.

Standards are written by experts in relevant standardization bodies (such as the International Electrotechnical Commission IEC or the European Committee for Electrotechnical Standardization CENELEC) and reflect the technical state of the art. Their role is to establish a technical common ground for cooperation between market players. Typically, IEC standards are accepted in the majority of countries and local standards (EN, NEMA) will be harmonized to fit them.

Manufacturers must demonstrate and document compliance with the local legislations by following the standards, otherwise they are not allowed to sell their product in the local market. On the product itself the compliance is indicated by symbols.



Fig. 3.32 CE-Marking and UL listing

Which standards have been applied and which legislative conformance has been stated is noted for example in Europe in the Declaration of Conformity. For a better understanding this book address several standards connected to AC drives and some relevant legislative measures (for example, see chapter 5.5).



04

VARIABLE SPEED MOTOR DRIVE OPERATION

4	Variable speed motor drive operation	87
4.1	Basic Principles	87
4.1.1	U/f Operation and Field Weakening.....	87
4.1.2	Star and Delta Configuration in Field Weakening Operation	88
4.1.3	Running in Current Limit.....	90
4.2	Compensations.....	90
4.2.1	Load-independent Start Compensations.....	90
4.2.2	Load-dependent Start Compensations	91
4.2.3	Load Compensations.....	92
4.2.4	Slip Compensations.....	92
4.2.5	PM Motor and SynRM compensations	92
4.3	Danfoss Automatic Motor Adaption (AMA)	93
4.4	Operation.....	94
4.4.1	Motor Speed Control	94
4.4.2	Reversing.....	95
4.4.3	Acceleration and Deceleration Ramps (Ramp Up and Down).....	96
4.4.4	Motor Torque Control.....	98
4.4.5	Watchdog.....	98
4.4.6	Energy Efficient Motor Start.....	99
4.4.7	Energy Efficient Motor Control	101
4.5	Dynamic Brake Operation	103
4.5.1	Extending Deceleration Ramp.....	104
4.5.2	Motor as a Braking Resistor.....	104
4.5.3	Brake Chopper Circuit (Brake Module) and Resistor.....	104
4.5.4	Use of a Regenerative Braking Unit	105
4.6	Static Brake Operation.....	106
4.6.1	Coasting to Stop.....	106
4.6.2	DC Braking.....	106
4.6.3	DC Hold.....	106
4.6.4	Electromechanical Brake	107
4.7	Motor Heating and Thermal Monitoring	107
4.8	Functional Safety.....	109

4 Variable speed motor drive operation

In the previous chapters, the motor and the AC drive were each presented in isolation. This chapter explains the interaction between the two components.

4.1 Basic Principles

4.1.1 U/f Operation and Field Weakening

The major technical characteristics of a motor are found on its nameplate. The information shown is very relevant for the electrical installer because values for voltage, frequency and full load current are given, but important information for the mechanical design is missing and can be found in the datasheet, catalogue, or by direct contact to the motor manufacturer. This mechanical design information includes data related to motor start and intermittent operation, and also the available torque at the motor shaft. The shaft torque is easy to calculate from the nameplate data.

For a given load, the following expression applies:

$$T = \frac{P \times 9550}{n} = \frac{n \times \sqrt{3} \times V \times I \times \cos\phi \times 9550}{f \times 60/p \times (1 - s)} = \frac{k \times V \times I}{f}$$

This results in the principle relation:

$$T \sim \frac{V}{f} \times I$$

This relation is utilized in voltage source AC drives which maintain a constant ratio between the voltage (U) and the frequency (f). This constant ratio (U/f) determines the magnetic flux density (Φ) of the motor and is determined by the motor nameplate data (for example, 400 V/50 Hz = 8 V/Hz). The constant flux density ensures optimum torque from the motor. Ideally the ratio 8 V/Hz means that each 1 Hz change in the output frequency will result in an 8 V change in the output voltage. This way of controlling the output values of the AC drive is called “U” to “f” characteristic control.

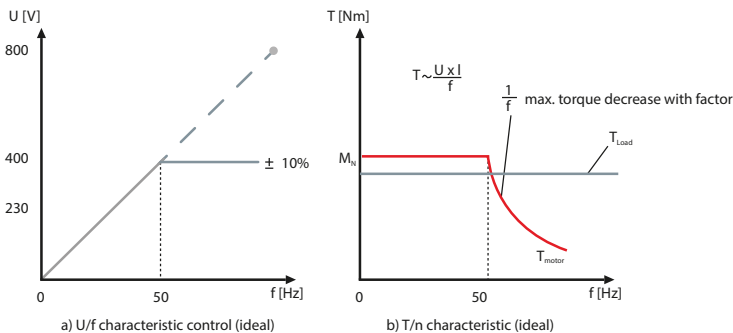

Fig. 4.1 Principle U/f characteristic and torque

The ideal curve of the U/f characteristic for a star connected 50 Hz motor is shown in Fig. 4.1 Principle U/f characteristic a) applied motor voltage b) resulting torque. Up to 50 Hz the AC drive applies a constant U/f ratio to the motor which result in the possibility to get a constant torque out of the motor.

For operating the motor at 100 Hz ideally the output voltage should be increased to 800 V to maintain a constant U/f ratio (dotted line in Fig. 4.1a Principle U/f characteristic and torque). As this high voltage is critical for the motor insulation this is not an applied strategy. Typically, the AC drive limit its output voltage to the value of the input (for example 400 V ±10%)

This means that the AC drive can maintain a constant U/f ratio to a certain frequency only. After this frequency it can continue to increase the frequency but not the voltage anymore. As this is affecting the U/f ration the magnetic flux density is reduced. Therefore, this speed range is also called field weakening area (Fig. 4.1 Principle U/f characteristic and torque). The reduced magnetic field results in a reduced maximum motor torque. While the nominal torque is reduced by 1/f the stall torque decreases by 1/f².

Please note that the shown curves are ideal and require some compensation which are described in the following sections.

4.1.2 Star and Delta Configuration in Field Weakening Operation

Typically, induction motors operated with AC drives are connected to the nominal voltage of the mains. This means that a 400 V/230 V motor will be configured in a star when operated by a 400 V drive. As described in the previous section a 50 Hz motor will enter field weakening when the voltage can't be increased any more. For extending the speed range the motor can be configured in delta.

Example

Motor: 15 kW, 400 V/230 V Y/Δ, 27.5 A/48.7 A, 50 Hz

At 50 Hz the power in star and delta configuration is 15 kW because of the different mains voltage which result in different motor currents.

$$P_Y (50 \text{ Hz}) = \sqrt{3} \times 400 \text{ V} \times 27.50 \text{ A} \times \cos \varphi \times \eta = 14.92 \text{ [kW]}$$

$$P_{\Delta} (50 \text{ Hz}) = \sqrt{3} \times 230 \text{ V} \times 48.70 \text{ A} \times \cos \varphi \times \eta = 15.19 \text{ [kW]}$$

With delta connection it can be seen in Fig. 4.2 87 Hz characteristic that in contradiction to the star configuration the motor runs with constant U/f ratio up to 230 V, but if the AC drive is powered from a 400 V supply, we are actually able to keep the constant U/f ratio up to 400 V and the high current, P_Δ (87 Hz) = $\sqrt{3} \times 400 \text{ V} \times 48.70 \text{ A} \times \cos \varphi \times \eta = 26.42 \text{ [kW]}$.

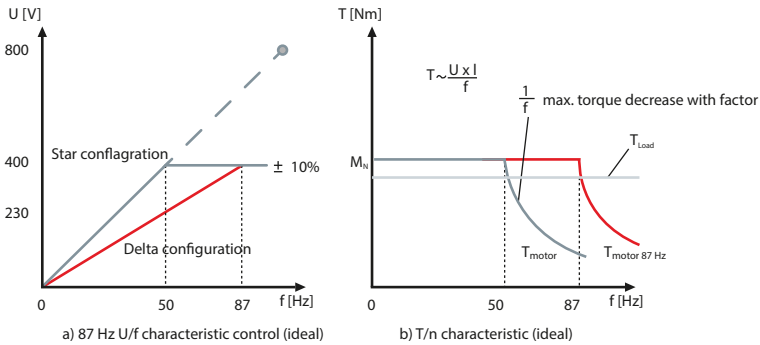

Fig. 4.2 87 Hz characteristic

This means we have the rated flux density (Φ) up to 400 V even when the motor is configured for 230 V. With this higher voltage we can increase the maximum frequency with rated flux to 87 Hz.

The use of this knowledge presupposes the following:

- The selected AC drive must easily be able to handle the higher delta current (48.70 A)
- The motor must be wound such that it can withstand the required operating voltage (typically higher in the star configuration) supplied by the AC drive (i.e. with a 690 V supply voltage and a 690 V drive, this application is only possible with a motor wound for 690 V / 400 V Y/ Δ)
- The torque on the motor shaft remains the same for both configurations up to 50 Hz. Above 50 Hz, a star-connected motor enters the field weakening range. When it is delta-connected, this does not happen until approximately 90 Hz. If the $\pm 10\%$ tolerance of the AC drive is used, the field weakening range begins at 55 Hz or 95 Hz respectively. The torque decreases because the motor voltage is not increased

The benefits of this increased motor capacity utilization are:

- An existing AC drive can be operated with a greater speed control range
- A lower-power rating motor can be used. Such a motor can have lower moment of inertia which allows higher dynamics. This improves the dynamic characteristics of the system

The disadvantages of this increased motor capacity utilization are:

- The higher speed will shorten the lifetime of the bearings or will require bearing lubrication at shorter intervals
- A lower-power rating motor means that the bearings are smaller and less mechanical load is allowed

Please note that operation of a 400V/230V Y/ Δ motor in delta at 400 V is only possible on an AC drive because of the higher feeding frequency of 87 Hz. Operation direct on 400 V / 50 Hz mains will destroy the motor.

4.1.3 Running in Current Limit

As seen, the relationship between motor shaft torque and motor current indicates that if motor current can be controlled, then the torque is also under control. If an application temporarily needs torque up to maximum it is essential that the AC drive is designed for continuous operation current up to the current limit, and not exceed it or trip.

There are different strategies for designing the AC drive to run in current limit situations. The most typical strategy is the fact that torque will be reduced when the speed is reduced. But as we shall see later there can be applications where this strategy cannot be utilized and can even cause bigger problems.

4.2 Compensations

It used to be difficult to tune an AC drive to a motor because some of the compensation functions, such as “start voltage”, “start compensation” and “slip compensation”, are difficult to relate to practice.

These compensations are required because motor characteristics are not linear. For example, an induction motor requires a greater current at low speed to accomplish both magnetizing current and torque-producing current for the motor. The built-in compensation parameters ensure optimum magnetization and hence maximum torque:

- During start
- At low speeds
- In the range up to the rated speed of the motor

In the latest generation of AC drives, the device automatically sets the necessary compensation parameters once the motor rating details of the motor have been programmed into the AC drive. These details include voltage, frequency, current and speed. This applies to approximately 80% of standard applications such as conveyors and centrifugal pumps. Normally, these compensation settings can also be changed manually for fine tuning applications such as hoisting or positive displacement pumps if required.

4.2.1 Load-independent Start Compensations

Increase, if necessary, the output voltage in the lower speed range by manually setting an additional voltage, often called start voltage.

Example

A motor which is much smaller than the recommended motor frame size of an AC drive may require an additional, manually adjustable voltage boost in order to overcome static friction or ensure optimum magnetization in the low speed range.

If several motors are controlled by one AC drive (parallel operation), it is recommended to deactivate the load-independent compensation.

The load-independent supplement (start voltage) ensures an optimum torque during start.

4.2.2 Load-dependent Start Compensations

The load-dependent voltage supplement (start and slip compensation) is determined via the current measurement (active current).

This compensation is normally called the $I \times R$ compensation, boost, torque increase, or, at Danfoss, start compensation.

This type of control reaches its limits when the disturbances are difficult to measure, and the load is highly variable (for example in motors with operational change in the winding resistance of up to 25 % between the hot and cold states).

The voltage increase may have different results. Under no-load operation, it may lead to saturation of the stator and rotor material. In the event of saturation, a high reactive current will flow that leads to heating of the motor. If the motor is operating with a load, it will develop little torque because of the weak main flux and may stop running. The real U/f and T/n characteristics are generally as shown in Fig. 4.3 Real U/f and T/n characteristic.

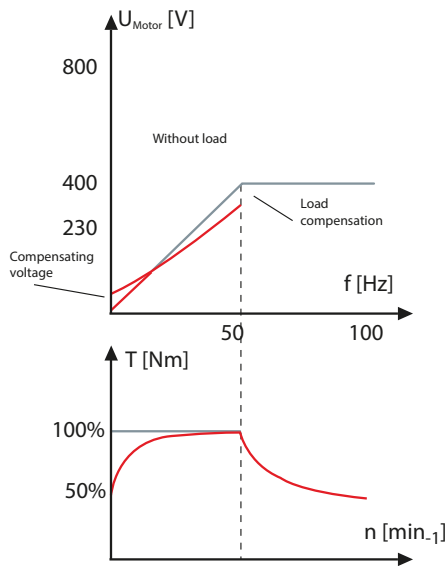

Fig. 4.3 Real U/f and T/n characteristic

In Fig. 4.3, additional voltage is supplied to the motor at low speeds for the purpose of compensation.

4.2.3 Load Compensations

The motor voltage is increased under load ascertained from the measured motor current. The output voltage receives a voltage boost which effectively overcomes the influence of the DC resistance of the motor windings at low frequencies and during start.

An increase in output voltage which is too high compared to the U/f characteristic leads to over-magnetization of the motor. This increases the thermal load on the motor such that a reduction in torque is to be expected. The motor voltage is reduced in no-load operation.

4.2.4. Slip compensation

The slip of an induction motor is load-dependent and typically amounts to some 5% of the rated speed (less than 1% for larger motors). For a two-pole motor, this means that the slip will be around 150 RPM.

However, the slip will be approximately 50% of the required speed if the AC drive is controlling a motor at 300 RPM (10 % of the rated synchronous speed of 3000 RPM).

If the AC drive has to control the motor at 5 % of the rated speed, the motor will stall if it is loaded. This load dependence is undesirable, and the drive can fully compensate for this slip by effectively measuring the active current to the motor.

The AC drive then compensates for the slip by increasing the frequency according to the actual measured current. This is called active slip compensation.

The AC drive calculates the slip frequency (f_{slip}) and the magnetization or no-load current (I_{ϕ}) from the motor data. The slip frequency is scaled linearly to the active current (difference between no-load and measured current).

Example

A 4-pole motor with a rated speed of 1455 RPM has a slip frequency of 1.5 Hz and a magnetization current of approximately 12 A.

With a load current of 27.5 A and 50 Hz, the AC drive will output a frequency of about 51.5 Hz. At a load current between I_{ϕ} (12 A) and I_N (27.5 A), the frequency will be adjusted accordingly between zero and 1.5 Hz.

As demonstrated in the example, factory setting of slip compensation is often scaled such that the motor runs at the theoretical synchronous speed. In this case, $51.5 \text{ Hz} - 1.5 \text{ Hz} = 50 \text{ Hz}$.

4.2.5 PM Motor and SynRM Compensations

For Permanent Magnet motors the start and slip compensations are irrelevant, but other parameters are essential.

The magnetizing profile differs of course from the induction motor, but other important data and compensations are:

- Nominal motor speed and frequency
- Back EMF
- Max speed before back EMF damages the AC drive
- Field weakening
- Dynamic details relevant for the control

For SynRM motors other parameters are essential, for instance:

- Stator resistance
- d and q axis inductances
- Saturation inductances and
- Saturation point

4.3 Danfoss Automatic Motor Adaptation (AMA)

Motor data on the motor nameplate or from the motor manufacturer's datasheet are given for a specific range of motors, or a specific design, but those values rarely refer to the individual motor. Due to variations in the production of motors and the installation, those motor data are not always accurate enough to ensure optimal operation.

Also, as seen previously there are several compensations which require setting.

For modern AC drives, fine-tuning to the actual motor and installation can be a complicated and troublesome task.

To make installation and initial commissioning easier, automatic configuration functions like the Automatic Motor Adaption (AMA) from Danfoss are becoming increasingly common. These functions measure for example the stator resistance and inductance. The effect of the cable length between AC drive and motor is also taken into account.

The parameters required for different motor types differ in important details. For instance, the back-EMF value is essential for PM motors and saturation point level is important for SynRM motors. Therefore, different types of AMA are required. Note that not all AC drives support the motor identification function for all motor types.

In principle two strategies are used to measure relevant motor parameters:

Dynamic

The function accelerates the motor to a certain speed to perform the measurements. Typically, the motor must be disconnected from the load/machine for an "identification run".

Static

The motor is measured at standstill. This means there is no requirement to disconnect the motor shaft from the machine. It is important, however, that the motor shaft is not rotated by external influences during measurement.

4.4 Operation

4.4.1 Motor Speed Control

The output frequency of the AC drive, and thus the motor speed, is controlled by one or more signals (0-10 V; 4-20 mA, or voltage pulses) as a speed reference. If the speed reference increases, the motor speed goes up and the vertical part of the motor torque characteristics is shifted to the right (Fig. 4.4 Reference signal and motor torque relation).

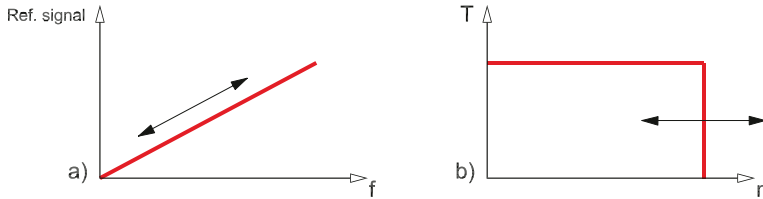

Fig. 4.4 Reference signal and motor torque relation

If the load torque is less than the motor torque, the speed will reach the required value. As shown in Fig. 4.5 Relation current limit and overcurrent limit, the load torque curve intersects the motor torque curve in the vertical part (at point A). If the intersection is in the horizontal part (point B), the motor speed cannot continuously exceed the corresponding value. The AC drive allows brief current limit overshoots without tripping (point C), but it is necessary to limit the duration of the overshoot.

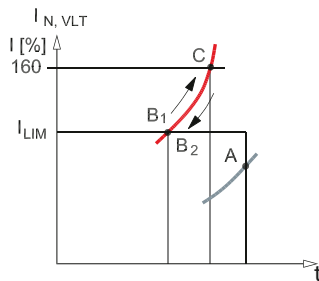

Fig. 4.5 Relation current limit and overcurrent limit

4.4.2 Reversing

The direction of rotation of asynchronous and many synchronous motors is determined by the phase sequence of the supply voltage. If two phases are swapped, the direction of rotation of the motor changes (the motor reverses).

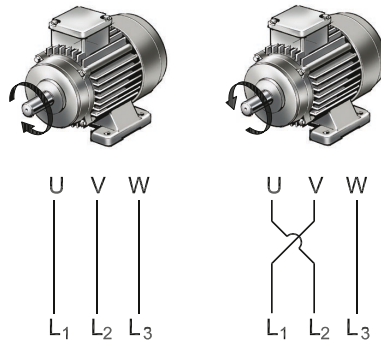

Fig. 4.6 The rotation direction of the motor reverses when the phase sequence is changed

An AC drive can reverse the motor by electronically changing the phase sequence. Reversing is accomplished by either using a negative speed reference or a digital input signal.

If the motor must have a specific direction of rotation when first put into service, it is important to know the factory default setting of the AC drive. In some cases, reversing can even damage the motor, so typically reversing is disabled by default.

Since an AC drive limits the motor current to the rated value, a motor controlled by a drive can be reversed more frequently than a motor connected directly to the mains.

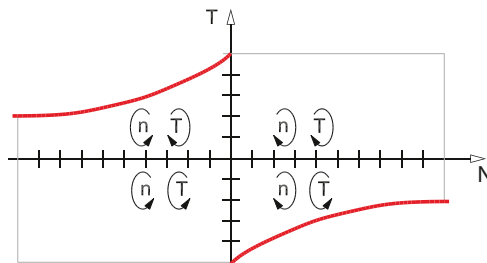

Fig. 4.7 Braking torque of the AC drive during reversing

4.4.3. Acceleration and Deceleration Ramps (Ramp Up and Down)

For many applications there are various reasons why the speed must not change too quickly but instead must be changed slowly or with smooth transitions. All modern AC drives have ramp functions to facilitate this. These ramps are adjustable and ensure that the speed reference is able to increase or decrease only at a preset rate.

The acceleration ramp (ramp up) indicates how quickly the speed is increased. It is stated in the form of an acceleration time t_{acc} and indicates how quickly the motor should reach the new speed. These ramps are mostly based on the rated motor frequency, e.g. an acceleration ramp of 5 seconds means that the AC drive will take 5 seconds to go from standstill to the rated motor frequency ($f_n = 50$ Hz).

However, there are some manufacturers who relate the acceleration and deceleration to the values between the minimum and maximum frequency.

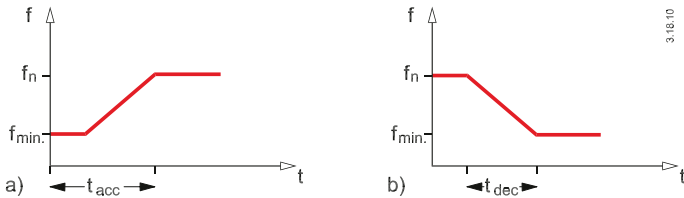

Fig. 4.8 Acceleration and deceleration times

The deceleration ramp (ramp down) indicates how quickly the speed is decreased. It is stated in the form of a deceleration time t_{dec} and indicates how quickly the motor should reach the new reduced speed.

It is possible to go directly from acceleration to deceleration since the motor always follows the output frequency of the inverter.

Ramp times can be set to such low values that in some situations the motor cannot follow the preset speed.

This leads to an increase in the motor current until the current limit is reached. In the case of short ramp-down times, the voltage in the intermediate circuit may increase to such a level that the protective circuit will stop the AC drive.

If the inertia of the motor shaft and the referred inertia of the load are known, the optimum acceleration (t_{acc}) and deceleration (t_{dec}) times can be calculated.

$$t_{acc} = J \times \frac{n_2 - n_1}{(T_{acc} - T_{fric}) \times 9.55}$$

$$t_{dec} = J \times \frac{n_2 - n_1}{(T_{acc} - T_{fric}) \times 9.55}$$

- J is the moment of inertia of the motor shaft and load [kgm²].
- T_{fric} is the friction torque of the system [Nm].
- T_{acc} is the overshoot torque used for acceleration [Nm].
- T_{dec} is the braking torque that occurs when speed reference is reduced [Nm].
- n₁ and n₂ are the speeds at frequencies f₁ and f₂ [min⁻¹].

If the AC drive allows an overload torque for a brief time, the acceleration and deceleration torques are set to the rated motor torque T. In practice, the acceleration and deceleration times are normally identical.

Example

A machine has the following specifications:

- J = 0.42 kgm²
- n₁ = 500 min⁻¹
- n₂ = 1000 min⁻¹
- T_{fric} = 0.05 × T_N
- T_N = 27 Nm

Theoretical acceleration time can be calculated as follows:

$$t_{acc} = J \times \frac{n_2 - n_1}{(T_{acc} - T_{fric}) \times 9.55} = \frac{0.42 \times (1000 - 500)}{[27.0 - (0.05 \times 27.0)] \times 9.55} \approx 0.5 \text{ s}$$

The ramp functions ensure that there is no abrupt change of speed, provided the AC drive is set to the calculated acceleration. This is essential for many applications like:

- Ensuring bottles do not topple over on bottle transporting conveyors
- Preventing water hammer in pump systems
- Ensuring comfort in escalators or lifts

Most often linear ramps are used. However different characteristics are possible for different applications, for example, an “S” or “S2” ramp. With the “S” ramp, the transitions to and from standstill are particularly gentle.

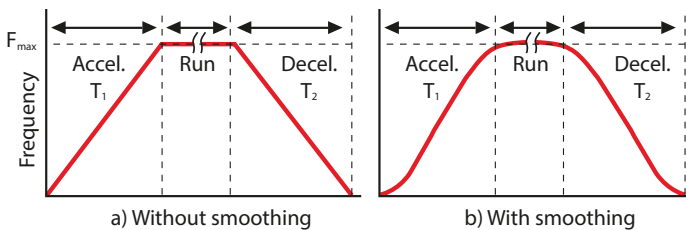

Fig. 4.9 Linear ramp (a) and S-ramp (b)

4.4.4 Motor Torque Control

Motor torque is another parameter which is important for the application, as shown in Fig. 4.5. The motor current can overshoot the current limit briefly. Torque is the basis for the rotation or movement of a load. Reasons for controlling the torque include:

- Limiting the torque to prevent damage on machine etc.
- Control the torque to make more motors share the load.

If an application is suddenly overloaded, and the AC drive is sized for overload, the machine can work for a given time in the overload mode. However, this excessive torque can be fatal for the machine or reduce the lifetime. Therefore, many AC drives can be programmed to send a warning in case of overload, but also limit the torque under specific conditions.

As described in section 4.1 Basic Principles there is a relationship between current and torque. This relationship is not direct, but depends on slip, $\cos \phi$ and temperature in the motor. The limitation based on measuring the current is not accurate. If the AC drive is the Space Vector type or the flux type (see chapter 3 AC drives) the current is measured vectorially in all three motor phases, and the distribution of the current components is easy. With this information the AC drive can calculate the torque precisely enough to make sure the machine is protected.

In situations where more motors are on a common mechanical system, it is essential that the motors share the load equally. If the slip compensation factor is reduced, the motors will automatically balance their torque, but not necessarily maintain the desired speed.

Another function in some AC drives is called the Droop function. Droop function means that one motor is controlling the speed and additional drives follow the same speed and automatically share the load.

Example

A 100-meter-long conveyor belt has numerous drive stations distributed along the belt. If one of the motors tends to run a bit faster than the other, this motor will have to give more torque. The result can be:

- The motor can be overloaded and overheated
- The belt can be damaged because of the partially higher torque
- Pulleys and drive drums may slip with excessive wear as result

In such situations, torque and torque sharing is important.

4.4.5 Watchdog

AC drives can monitor the process being controlled and intervene in case of operational disturbance. This monitoring can be divided into three areas: machinery, motor and AC drive.

The machinery is monitored by

- Output frequency
- Output current
- Motor torque

Based on these values, a number of limits can be set which intervene in the control function if they are exceeded. These limits could be the lowest permissible motor speed (minimum frequency), the highest permissible motor current (current limit) or the highest permissible motor torque (torque limit). If the limits are exceeded, the AC drive can, for example, be programmed to:

- give a warning signal,
- decrease the motor speed or
- stop the motor as fast as possible

Monitoring a drive can be used to predict possible problems before they occur and plan preventive maintenance accordingly. This enhances the availability of the drive, reduces the risk of failure and lowers costs.

Example

In an installation using a V-belt as a connection between the motor and the rest of the installation, the AC drive can be programmed to monitor the V-belt.

If the V-belt were to slip or brake, the AC drive would detect the sudden decrease in the motor torque and can be programmed to either give a warning or stop the motor.

4.4.6 Energy Efficient Motor Start

The energy for starting a motor can be split into 3 major parts:

- Energy required for operating the load
- Energy required for accelerating the load and the motor
- Losses in motors and control

The simplest way for starting a motor is to connect the motor direct on line (DOL) but this is also an inefficient solution. The motor will have high losses when starting due to the huge slip when applying the voltage. While accelerating the motor, the slip and hence the losses are reduced.

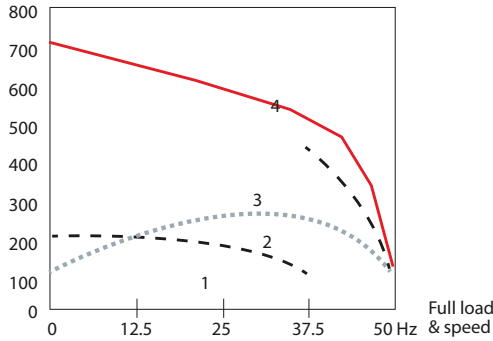

Fig. 4.10 Typical motor current curves started by (1): AC drive at VT load (2): star-delta starter (3): Softstarter (4): direct on line (DOL)

Softstarters can be used which adjust the motor voltage like Star/Delta starters, but linearly. The device increases the voltage until a programmed current limit is hit. The limit is application-dependent, typically in the range of 300-500% FLC. While the motor is accelerating the current drops and the device increases the voltage further. This sequence continues until the mains voltage level is applied to the motor.

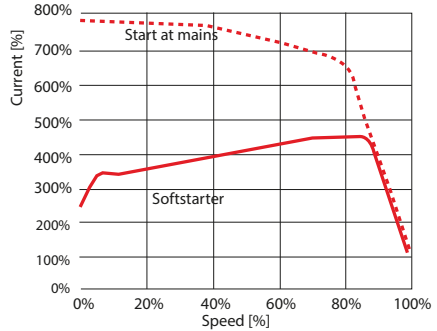
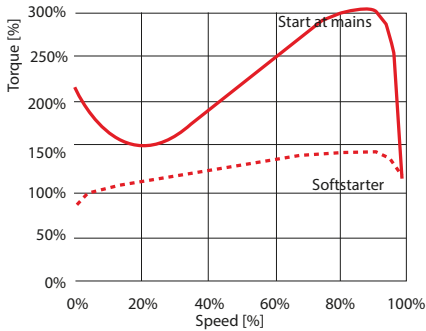

Fig. 4.11 Comparison of motor start direct on mains with motor started by a softstarter (400% current limit)

For minimizing the losses Softstarters are typically operated in by-pass after the motor has been started. During the starting phase the losses are approximately 4.5 W per A.

The most efficient way for starting a motor is the use of AC drives. As voltage and frequency are controlled the slip and hence the losses are reduced. Using a by-pass like on Softstarters is possible but seldom used.

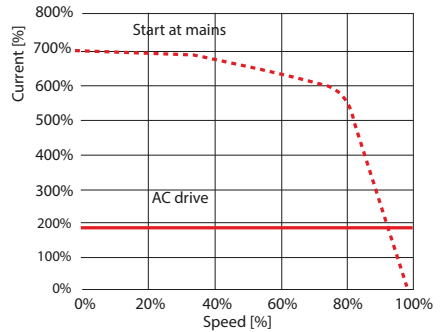
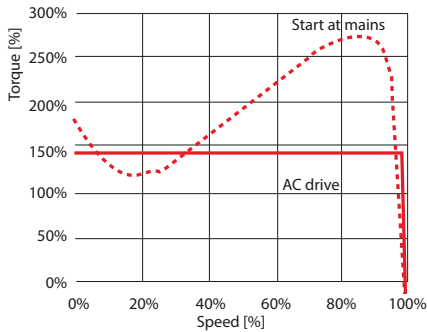

Fig. 4.12 Comparison of motor start direct on mains with a motor started by an AC drive at 160% overload

Principle torque and current curves for starting a motor with constant load direct on mains, by a softstarter and by an AC drive are shown in Fig. 4.11 Comparison of motor start direct on mains with motor started by a softstarter and Fig. 4.12 Comparison of motor start direct on mains with a motor started by an AC drive at 160% overload. The curves will look different with different loads.

4.4.7 Energy Efficient Motor Control

All motors operate by applying the correct voltage at a given frequency. A rotating shaft does not mean, however, that the motor is operating efficiently. For controlling a motor, a control algorithm (U/f, voltage vector, flux vector...) and a control strategy are required. That both components must suit a motor type can easily be seen with motors using permanent magnets. For energy-optimum operation the controller must match the supply voltage waveform as closely as possible to the waveform of the back EMF. Block commutation is used for trapezoidal back EMF and sine commutation for sinusoidal.

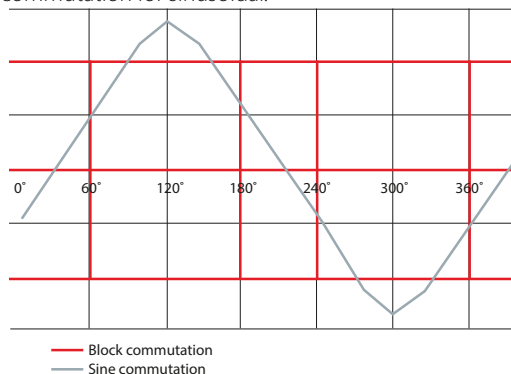

Fig. 4.13 Block vs. Sine-wave commutation

Block commutation is known to have some disadvantages like torque ripple and excessive noise. However, both technologies are comparable when it comes to efficiency.

Control strategies which are often used in different control algorithms are:

Constant Torque angle

Maximum torque is created when the torque angle is kept constant at 90° . The constant Torque angle strategy keeps the angle constant by controlling the rotor d-axis current to zero while leaving the current vector on the y-axis.

Maximum Torque Per Ampere

This strategy minimizes stator current magnitude for a required torque while considering reluctance torques. Variations in inductances during operation must be considered to obtain best results.

Constant Unity Power Factor control

The angle between current and voltage vector is kept constant under this strategy so the apparent power rating of the inverter can be reduced.

In addition, AC drives provide extra functionalities for reducing the magnetic field strength at reduced load. This can be done by special U/f characteristics or by Automatic Energy Optimization (AEO) functions.

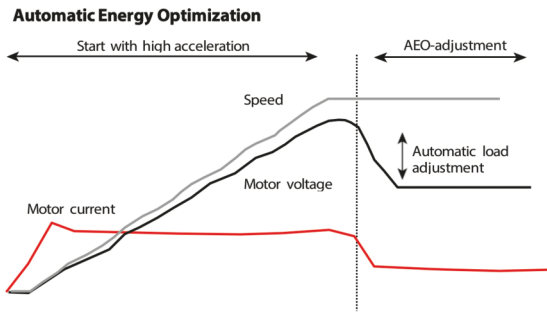

Fig. 4.14 Automatic Energy Optimization

Automatic adjustments take place after the application reaches a steady state. The applied control strategy reduces the magnetization level and thus the energy consumption. An optimized balance between energy saving and having enough magnetization for sudden load peaks must be given to ensure reliable operation. See fig 4.14 Automatic Energy Optimization.

The average energy saving potential for small to medium-sized drives is 3 to 5 % of the rated motor power during operation at low loads. As a very important side-effect, the motor runs almost noiselessly at low loads – even at low to medium switching frequencies.

4.5 Dynamic Brake Operation

Machines can create potential or kinetic energy which we want to remove from the machine.

- Potential energy is caused by gravity, for example when a load is hoisted to a position and is being held in position.
- Kinetic energy is caused by movement, for example a centrifuge running at a given speed which we want to reduce or a trolley to be stopped.

The dynamic characteristics of some loads require 4-quadrant operation. A reduction in the stator frequency (and voltage) by the AC drive allows the motor to act as a generator and convert mechanical energy into electrical energy.

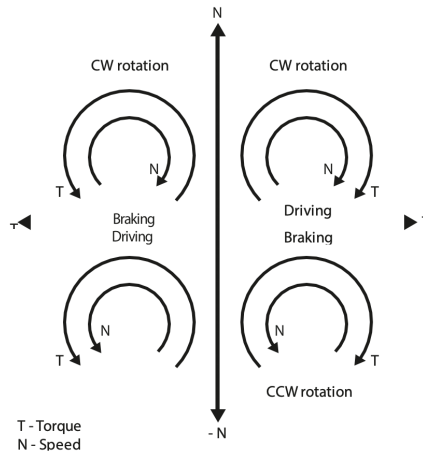

Fig. 4.15 Four Quadrant operation: Clockwise (CW) and Counter Clockwise (CCW)

Motors connected directly to the mains deliver the braking energy straight back to the mains.

If a motor is controlled by an AC drive, the braking energy is stored in the intermediate circuit of the drive. If the braking energy exceeds the power loss of the AC drive, the voltage in the intermediate circuit increases dramatically (in some cases exceeding 1000 V DC).

If the voltage exceeds the internal voltage limit, the AC drive is then switched off for self-protection and usually issues an alarm message or error code "over voltage." Measures must be taken to prevent the AC drive being tripped if the motor feeds back excessive braking energy.

The following measures are typically used:

- Extend the deceleration ramp time
- Dissipate the energy in the motor. That is, the motor is used as a braking resistor
- The AC drive is fitted with a "brake chopper" electronic circuit and appropriate braking resistors

- Use of a regenerative braking unit to feed energy back to mains
- Use of AC drives with an active rectifier to feed energy back to mains
- The energy is fed to other drives through a common DC bus
- The energy is fed to an energy storage (e.g. battery)

The first two measures require no additional hardware components. All the other measures do require additional components and must be considered at the design stage of the machinery.

4.5.1 Extending Deceleration Ramp

The deceleration ramp time can be extended by the operator by changing the relevant parameter setting. However, the operator must judge the load ratios himself.

Example

An attempt to brake a 22 kW motor operated by an AC drive from 50 Hz to 10 Hz within one second will end up with the drive tripping because the motor, acting as a generator, will feed back too much energy. The user can prevent the drive from tripping by changing the ramp-down time (for example, to 10 seconds).

Alternatively, the modern AC drive has control functions such as overvoltage control (OVC) that must be enabled to prevent the drive tripping or to automatically extend the ramps. The AC drive itself determines then the appropriate ramp time. This type of ramp extension automatically takes account of varying load inertias. Care must be taken when this kind of function is used on machines with vertical or horizontal movement (such as hoists, lifts, and portal cranes) as extending the ramp time does also mean that the traveling distance will be prolonged.

4.5.2 Motor as a Braking Resistor

Manufacturers use various methods for using the motor as a braking resistor. The basic principle is based on re-magnetizing the motor. Every manufacturer gives its method a different name, such as AC brake, flux brake, or compound braking. This type of braking is not recommended for highly dynamic applications (such as hoists or lifts) because the more frequent the braking, the hotter the motor becomes and consequently it can fail to perform as expected.

4.5.3 Brake Chopper Circuit (Brake Module) and Resistor

AC drives can be fitted with a brake chopper and a brake resistor. The circuit essentially consists of a transistor (for example, IGBT) that eliminates the excess voltage by “chopping” it and sending it to the connected resistor. The control circuit must be fed with the appropriate information during commissioning that a braking resistor is connected. The control circuit can also check whether the resistor is still in working order. Typically, it must be specified if an AC drive is equipped with a brake chopper or not, at the point of ordering.

Above a certain power level, the use of a braking module and resistor will cause heat, space and weight problems.

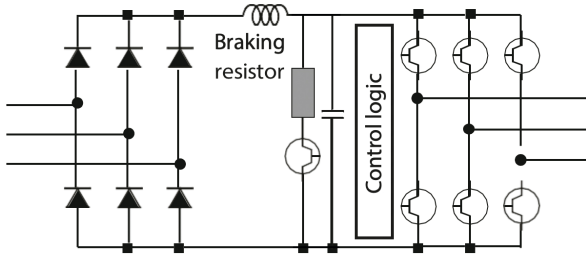

Fig. 4.16 Brake chopper and resistor

4.5.4 Use of a Regenerative Braking Unit

If the load often generates a great deal of regenerative energy, it may be useful to use a fully-regenerative braking unit.

If the voltage in the intermediate circuit rises to a given level, the DC voltage in the circuit is fed back to the mains, synchronously in both amplitude and phase, by an inverter.

This feedback of energy can be accomplished by:

- AC drives with an active rectifier. In this drive type, the rectifier can transmit energy from the intermediate DC circuit to the power supply
- External regenerative braking units integrally connected to the intermediate circuit of one or more AC drives, monitor the voltage in the intermediate circuit.

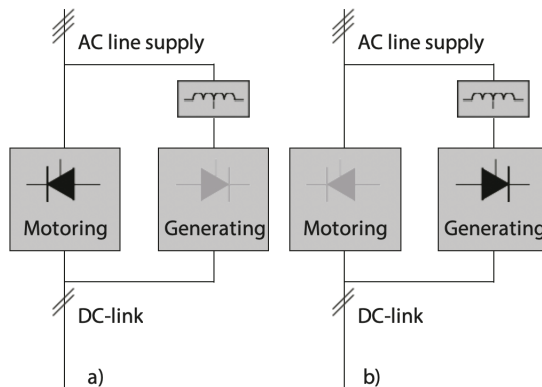

Fig. 4.17 Regenerative braking unit shows a simplified version of the operating principle.

For evaluation when it makes economic sense to use these kinds of devices please refer to chapter 5 Saving Energy with AC drives.

4.6 Static Brake Operation

The AC drive has several functionalities for locking or coasting the motor shaft, such as:

- Coasting to stop
- DC brake
- DC hold
- Electromechanical brake

The last three of these functions can typically only be performed after a stop command has been issued. This is often misunderstood in practice. It is important to note that a reference value of 0 Hz does not function as a stop command.

In general, do not use these functions when the direction of rotation is reversed.

4.6.1 Coasting to Stop

With the motor coasting, the voltage and frequency are immediately interrupted (0 V/0 Hz) and the motor is “released”. As the motor is no longer energized, it will typically spin down to zero speed. Depending on the speed and inertia of the load this can take from seconds to hours (for example, for huge separators).

4.6.2 DC Braking

A DC voltage across any two of the three motor phases is used to generate a stationary magnetic field in the stator. This field cannot generate high braking torque at the rated frequency. The braking power remains in the motor and may cause overheating.

Three parameters are required for DC braking:

- The frequency at which the brake should be activated. A frequency value below 10 Hz is recommended. Use the motor slip frequency as a guide. A frequency of 0 Hz means that the function is disabled
- The braking current used for holding the motor shaft. The recommendation is not to exceed the rated current of the motor in order to prevent possible thermal overload
- The duration of DC braking. This setting depends on the application

4.6.3 DC Hold

Unlike the DC brake, the DC hold has no time limit. Otherwise the above recommendations for the DC brake apply. This function can also be used when “auxiliary heating” is implemented for a motor placed in a very cold environment. As constant current flows through the motor, do not exceed the rated motor current. This minimizes the thermal load on the motor.

4.6.4 Electromechanical Brake

The electromechanical brake is an aid for bringing the motor shaft to a standstill. This can be controlled from the AC drive by means of a relay and there are various possible control options.

It is important to establish when the brake can be released, as well as hold the motor shaft.

Some of the points to consider are:

- Motor pre-magnetization, meaning a minimum amount of current is needed
- The frequency at which activation or deactivation occur
- Reaction times (delay times) of the relay inductors

For critical applications such as hoists or lifts, once the start command has been given the brake may only be released after ensuring optimum pre-magnetization of the motor; otherwise the load could fall. A minimum current, usually the magnetizing current, should flow first to ensure that the motor cannot drop the load. For more information refer to chapter 4.10.

4.7 Motor Heating and Thermal Monitoring

Energy lost in motors during operation will warm up the motor. If the motor is heavily loaded, some cooling is needed. Depending on the system, motors can be cooled in different ways:

- Self-ventilation
- Forced air cooling
- Liquid cooling

To maintain the motor lifetime, keep the motor within the specified temperature range. The most common cooling method is self-ventilation, where the motor is cooled by a fan mounted on the shaft.

The temperature conditions of the motor are subject to two influences:

- When the speed decreases, the cooling air volume also decreases.
- When a non-sinusoidal motor current is present, more heat is generated in the motor.

At low speeds the motor fan is not able to supply enough air for cooling. This problem arises when the load torque is constant throughout the control range. This lower ventilation determines the permissible level of torque during continuous loading.

When the motor runs continuously at 100% rated torque, at a speed which is less than half the rated speed, the motor requires extra air for cooling. This extra air cooling is indicated by the shaded areas in Fig. 4.18 T/n characteristics with and without external cooling.

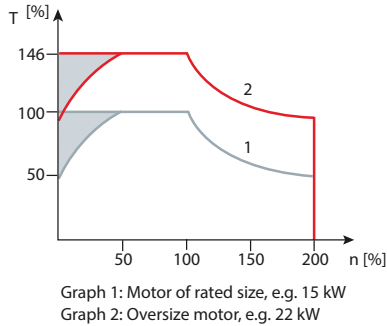

Fig. 4.18 *T/n characteristics with and without external cooling*

Alternatively, instead of providing extra cooling, it is possible to reduce the motor load ratio. To reduce the motor load ratio, select a larger motor. However, the AC drive specification imposes limits on the size of motor that can be connected.

When the motor current is non-sinusoidal, the motor receives harmonic currents that increase the motor temperature, as shown in Fig. 4.19 Maximum continuous torque and current shape relation. The magnitude of the harmonic currents determines the amount of heat increase. Therefore, it is advised to check the temperature rise class of the motor before operating it continuously at 100% load when the current is non-sinusoidal.

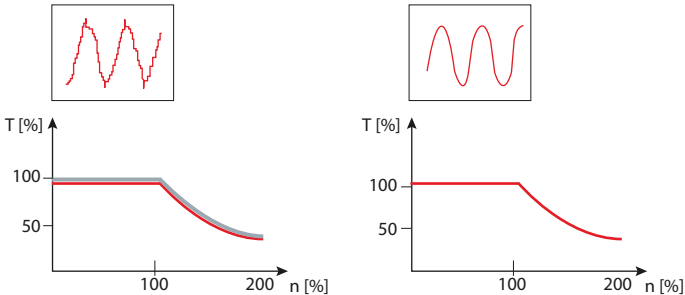

Fig. 4.19 *Maximum continuous torque and current shape relation*

When the application predominantly requires low speeds, an additional fan to cool the motor is recommended to ensure full torque. However, the fan should be powered from a separate supply and should not be connected to the output of the AC drive.

As an alternative to air, liquid can be used for cooling the motor. Liquid cooling is typically implemented in special motor designs.

Two temperature monitoring methods are implemented in the AC drive, in order to protect the motor:

Calculation:

The motor temperature is calculated based on a mathematical motor model.

Measurement:

Thermistors or PTCs placed inside the motor can be connected to the drive to monitor temperature

If motor overheating occurs, the remedial action required is programmed to fit the application needs.

4.8 Functional Safety

Machinery must be safe to operate. It is the responsibility of the machine builder to try to eliminate all risks by careful and efficient design. However, there is no such thing as totally risk-free machinery. Functional safety defines protection against hazards caused by incorrect functioning of components or systems. An AC drive is not a safety system as such, but it can be used as a part of a safety system. The role of a drive in a safety system is to be an actuator. It contains functions that can be certified for use in safety related systems or applications.

In Europe, functional safety falls under the Machinery Directive 2006/42/EC. The Machinery Directive describes the purpose of functional safety as follows: “Machinery must be designed and constructed so that it is fitted for its function, and can be operated, adjusted and maintained without putting persons at risk when these operations are carried out under the conditions foreseen but also taking into account any reasonably foreseeable misuse thereof.”

Depending on which application standard must be fulfilled, the system must reach a defined safety level. The required safety level is defined through a risk analysis. The risk analysis consists of finding out how severe accidents could happen, what is the likelihood that they could happen and how often the risk situations occur. The Machinery Directive refers to different standards, according to the safety level required.

Safety Level	Abbreviation	Standard
Category	Cat	EN 954-1
Performance Level	PL	EN ISO 13849-1
Safety Integrity Level	SIL	IEC 61508 / IEC 62061

Table 4.1

In addition to the required safety level, it is important to recognize the type of the risk, and thus the required safety function. To be able to define this, it is necessary to understand how the machine behaves, what sort of a process it is used in, and what is the safest way, for example, to stop the machine if a risk has actualized.

The European functional safety regulations are comparable to many others around the globe. For example, in North America the OSHA (Occupational Safety and Health Act) applies, and in Canada the CCOHS (Canadian Centre for Occupational Health and Safety) provide the framework for applying safety measures. Although the relevant standards differ between the various regions, the safety principles are closely related. In general, it is common to use abbreviations in the different legislative frameworks and the standards to describe the safety function and the safety level.

Function	Description	Illustration
Safe Torque Off STO	The motor does not get energy to produce torque/ rotation. This function complies to stop category 0 according to IEC 60204-1.	
Safe Stop 1 SS1	A controlled stop, in which the drive elements of the machine are kept energised in order to stop it. The power is only disconnected when standstill has been reached. This function complies to stop category 1 according to IEC 60204-1.	
Safe Limited Speed SLS	A safe state of speed is called Safe Limited Speed. This ensures that a machine runs at a constant safe speed. If it runs faster a Stop function will be activated	
Safe Maximum Speed SMS	Ensures that the machine does not run at a higher level than a defined maximum speed. It prevents machine damage and reduces hazards. Function-wise it is the same principle as SLS	
Safe Speed Monitor SSM	SSM monitors for zero speed and sets an output signal high if zero speed is reached. This function can be used to unlock doors or simply to display that the machine is in standstill.	

Table 4.2 General AC drive safety functions and their functionality

The product standard EN/IEC 61800-5-2 defines several additional functional safety functions for AC drives:

- SOS Safe Operating Stop
- SS2 Safe Stop 2
- SDI Safe Direction
- SBC Safe Brake Control
- SMA Safely-Monitored Acceleration
- SLP Safely-Limited Position
- SCA Safe Cam
- SLI Safely-Limited Increment
- SSR Safe Speed Range
- SBT Safe Break Test
- SQS Safe Quick Stop
- SLA Safely-Limited Acceleration
- SAR Safe Acceleration Range
- SLT Safely-Limited Torque
- STR Safe Torque Range
- SMT Safe Motor Temperature

SISTEMA

Independent Software tools such as SISTEMA (Safety Integrity Software Tool for the Evaluation of Machine Applications) help the machine builder to make all the calculations of the safety application.

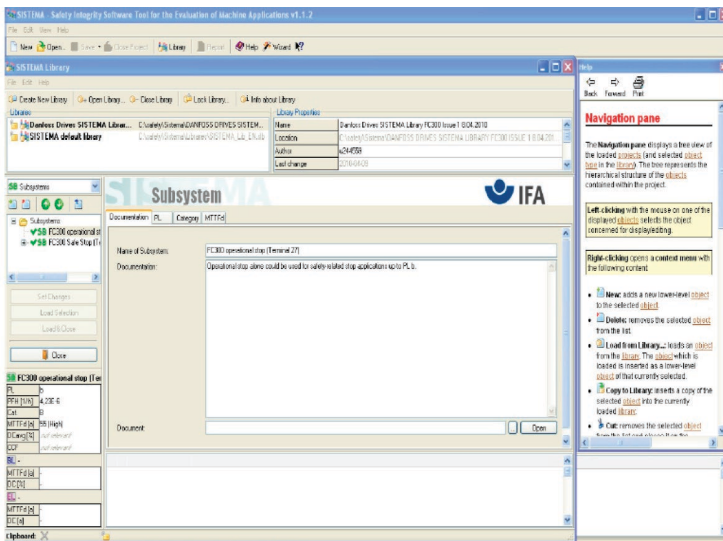

Fig. 4.20 Screenshot of the SISTEMA start page

The SISTEMA software utility provides support to developers and testers of safety-related machine controls, in evaluation of safety in the context of ISO 13849-1. The tool enables modelling of the structure of the safety-related control components based upon the designated architectures. This modelling enables automated calculation of the reliability values with various levels of detail, including that of the attained Performance Level (PL).

Relevant parameters are entered step-by-step in input dialogs, for example:

- risk parameters for determining the required performance level (PLr)
- the category of the SRP/CS
- measures against common-cause failures (CCF) on multi-channel systems
- average component quality (MTTFd)
- average test quality (DCavg) of components and blocks

The impact of each parameter change upon the entire system is reflected immediately in the user interface. The final results are printable in a summary document.



05

SAVING ENERGY WITH AC DRIVES

5	Saving Energy with AC Drives	115
5.1	Potential.....	115
5.2	Motor + AC Drives Efficiency.....	115
5.3	Classification of Energy Efficiency Componenets.....	117
5.4	Load over Time.....	121
5.4.1	Applications with Variable Torque.....	121
5.4.2	Applications with Constant Torque.....	123
5.5	Life Cycle Costs.....	124
5.6	System Savings.....	124
5.7	Using Regenerated Power.....	126
5.8	Hybridization	128
5.8.1	Grid Converter.....	130
5.8.2	DC/DC Converter.....	130

5. Saving Energy with AC Drives

5.1 Potential

Electric motors account about 50% of global electrical energy consumption ^{*)}. In Industrial applications the ratio is even higher. Depending on the region and the industrial area, 65-75% of electrical energy in industry is used for electric motors. Therefore, electrical drive technology holds a great deal of potential for reducing the worldwide energy consumption.

AC drives enable the development and improvement of more energy-efficient motor technologies. Even more beneficial is applying the main reason why AC drives were developed: adjustable speed control. Speed control helps to optimize processes and operate motors at optimal speed and torque.

When total potential savings that could be made in a system are defined as 100%, roughly 10% of that potential could be obtained by using more efficient components, such as motors. Operation with adjustable speed control offers potential energy savings of approx. 30%. However, the greatest savings (approx. 60%) are to be made by optimizing the entire system. Increased efficiency

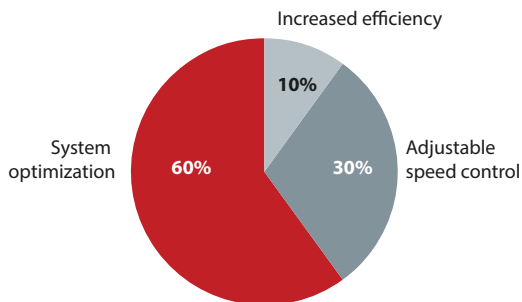

Fig. 5.1 Potential energy savings

If a few key points are taken into consideration, AC drives can lead to high energy savings being quickly and easily realized as the majority of applications (approx. 60-70%) are suitable for speed control. In particular, fans and pumps - which cover almost 50% of the applications - are obvious targets because of their huge saving potential.

^{*)} Source: 2016 – International Energy Agency

5.2 Motor + AC Drive Efficiency

The efficiency of a system consisting of a motor operated by an AC drive can be calculated by multiplying the single efficiencies.

$$\eta_{\text{System}} = \eta_{\text{Motor}} \times \eta_{\text{AC drive}}$$

Typically, AC drive efficiency curves at two different loads are shown in Fig. 5.2 Efficiency example of AC drives (A = 100% load / B = 25% load). The efficiency of the AC drive is high throughout the control range, both at high and at low load levels.

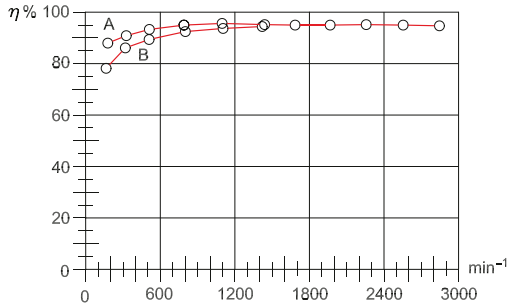

Fig. 5.2 Efficiency example of AC drives

Beside the economical aspect that high efficiencies of AC drives result in lower energy consumption, the dissipated power that has to be removed from the installation is reduced. This is important if the AC drive is integrated into a cabinet. If the losses are too high separate cooling devices are required which consume energy as well.

Normal and part load efficiencies of motors are compared to the AC drive as illustrated in Fig. 5.3 Efficiency example of a 2-pole motor (A = 100% load / B = 25% load).

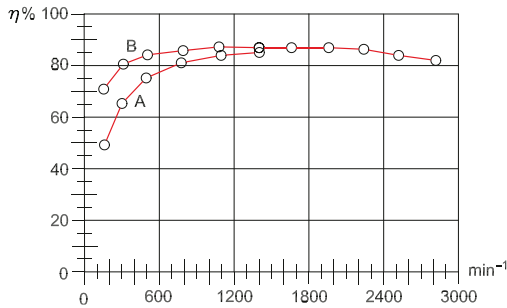

Fig. 5.3 Efficiency example of a 2-pole motor

Consequently, the motor has a major influence on the system efficiency (Fig. 5.4 Efficiency example of a AC drive and motor combination (A = 100% load / B = 25% load)).

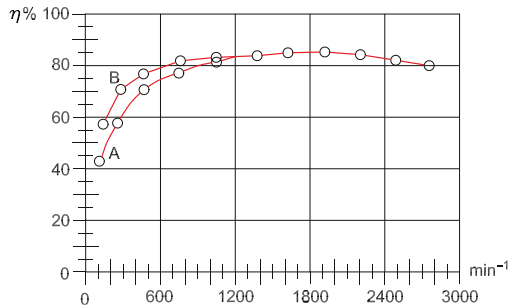

Fig. 5.4 Efficiency example of an AC drive and motor combination

Matching individual components to a particular drive system has several advantages over pre-configured systems because this allows the engineer to optimize the system to his requirements. Pre-configured systems are always optimized for general applications and can never fit all. If available, an indicator for the efficiency of components is the efficiency class.

5.3 Classification of Energy Efficient Components

AC Drive

The standard IEC61800-9-2 defines efficiency classes for AC drives. As power electronics can have several configurations the classes IE0-IE2 are defined for Complete Drive Modules (CDM) consisting of rectifier, intermediate circuit and inverter (see Fig. 5.5 Definition of CDM and PDS). CDM with ability to feedback (e.g. braking energy to the mains) are addressed but not covered because they have typically higher losses, and their suitability for a particular application can be evaluated using a system level calculation and considering the particular load cycle.

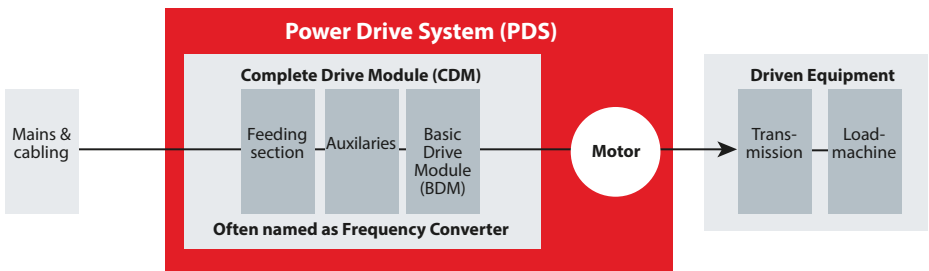

Fig. 5.5 Definition of CDM and PDS

The IE classes are defined in relation to a reference CDM (RCDM). By having the same scale for all power sizes, the classes are defined by relative losses. CDM with relative losses in the range of $\pm 25\%$ of the RCDM is classified as IE1. CDM with higher losses are grouped in IE0 while CDM with lower losses are in class IE2 (see Fig. 5.5 Definition of CDM and PDS efficiency classes).

The rating does not reflect the CDM efficiency at lower speed / torque as it's determined at 90% relative speed and 100% relative torque-producing current.

For verification the CDM is tested with all included components at a defined test load. Fine tuning or a special test mode is not allowed.

Transmission

Even though the kind of transmission can have a huge impact on the system efficiency, no efficiency classes are defined. The following table gives an indication of typical efficiencies:

Direct driven	100%	Flat belt	96...98%
Spur gear	98%	V-belt	92...94%
Bevel gear	98%	Tooth belt	96...98%
Worm gear	95%	Chain	96...98%

Table 5.1 Typical transmission efficiencies.

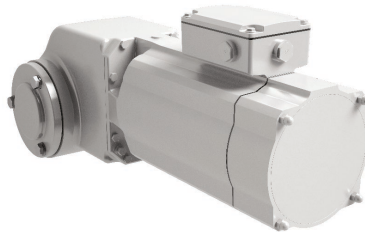

Fig. 5.6 The VLT® OneGearDrive® is a highly efficient, permanent magnet, three-phase synchronous motor coupled with an optimized bevel gear box

Motors

For the power range 0,12-1000 kW, efficiency classes IE1-IE4 for electric motors are defined in the standard IEC/EN 60034-30-1. Although the standard is valid for all motor types some motor constructions (e.g. brake motors) are excluded from the standard.

Several countries and regions use the IE class limits to define Minimum Efficiency Performance Standards (MEPS) to restrict the use of low efficiency motors. The efficiency class is related to the nominal operating point of the motor. Efficiencies at full speed but reduced torque must be stated on the nameplate or in the documentation. Limits are different for supply frequencies (50/60Hz) and the number of motor poles (2, 4 or 6 poles).

Classes for motors operated with AC drives are defined in IEC/ EN 60034-30-2.

AC Drive + Motor Combination

Efficiency classes for AC Drive and Motor combinations are defined in the standard IEC 61800-9-2 via an IES rating. Similar to the CDM, the classes of the so-called Power Drive System (PDS), which is the motor + AC drive combination (see Fig. 5.8b Energy efficiency classifications for motors, drives and power drive systems (PDS)), are related to a reference system (see Fig. 5.8b Energy efficiency classifications for motors, drives and power drive systems (PDS)). PDS with 20% higher losses than the reference is in class IES0 while systems with 20% lower losses are in class IES2.

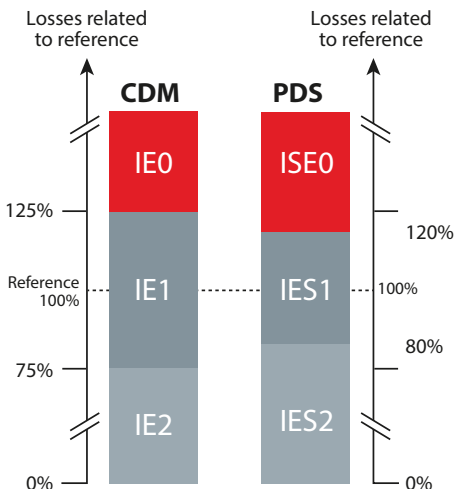

Fig. 5.7 Definition of CDM and PDS efficiency classes

The classification is made for 100% relative speed and 100% relative torque. If the AC drive is designed for a shorter cable or it's directly mounted on the motor where shorter cable can be used this must be stated in the documentation. In general, all kind of optimizations are possible as long they are noted in the documentation. Consequently, comparing two PDS ratings is difficult because they will most likely have different bases.

The IES class for AC drive and motor combinations illustrates the difficulty in optimizing a system and that all components must be carefully selected to optimize the application. The difference between pre-configured and non-optimized free combined systems will most often be minor, but matching different components generally allows finer adjustment to the machine, giving the machine builder a competitive advantage.

Tools for energy efficiency calculations

For helping users to deal with energy efficiency related aspects, Danfoss has developed the MyDrive® ecoSmart™ tool. This can be used to calculate the efficiency class and part load efficiency of a Danfoss drive, either as standalone product (CDM) or in combination with a motor (PDS).

This tool makes it easy to combine a Danfoss drive with any motor, as the resulting system efficiency will be calculated by the tool, based on the motor data and drive selection. MyDrive® ecoSmart™ is available as web application (see ecoSmart.danfoss.com) and as iOS or Android app.

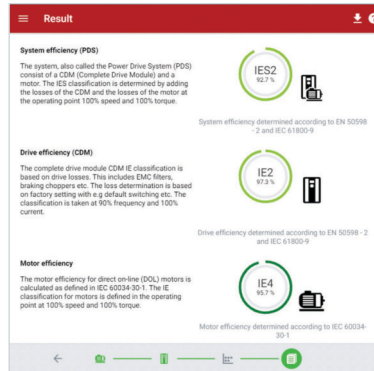

Fig. 5.8a Result page example from the web-based ecoSmart tool

Motors, drives, and power drive systems (PDS) are classified in energy efficiency classes. The standards used for classifications are different, as is the number of efficiency classes.

Equipment type	Standard defining classification
Motors for sinusoidal power supply	International standard IEC 60034-30-1, harmonized in Europe as EN 60034-30-1
Motors supplied from a drive	IE technical specification: IEC TS 60034-30-2
Drives and power drive systems	IEC EN 61800-9-2, based on and replacing EN 50598-2

Table 5.2

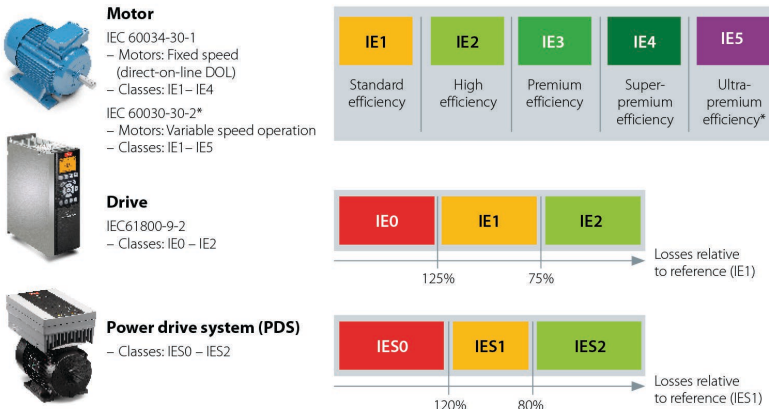

Fig. 5.8b Energy efficiency classifications for motors, drives and power drive systems (PDS)

5.4 Load over Time

Every component in a system has some losses, so adding components to a system should be avoided if possible. This applies also to AC drives. Adding a unit to a motor which has to run all day at full load and full speed will only result in additional losses. But as soon as reducing speed and torque make sense to the application, the use of an AC drive will reduce the energy consumption. The achievable savings depend on the load profile over time, the torque characteristics and the efficiency of the motor and drive system at the given part load points.

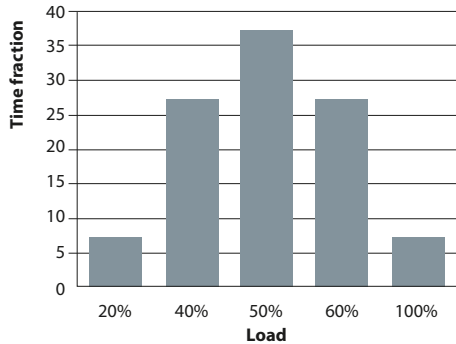

Fig. 5.8 Load over Time fraction diagram indicates how long a load is operated at part load

Part load is used in two different contexts. When a motor is operated from the mains, the feeding motor frequency is fixed, and the speed only varies with load. When the motor is operated by an AC drive, part load describes torque at a certain speed where the torque characteristic is given by the application. Actually, the majority of applications are operated at part load. This is also true for mains driven motors as they are typically oversized.

5.4.1 Applications with Variable Torque

Variable torque applications often involve pumps and fans. However, a distinction has to be made in the case of pumps. Although the most popular types of centrifugal pump have a quadratic torque characteristic, eccentric, vacuum or positive displacement pumps have a constant torque characteristic.

The energy saving potential of centrifugal pumps and fans is very high as these machines follow the affinity laws.

$$\frac{Q_1}{Q_2} \sim \frac{n_1}{n_2} \quad \text{Flow is proportional to speed}$$

$$\frac{H_1}{H_2} \sim \left(\frac{n_1}{n_2}\right)^2 \quad \text{Pressure or head is proportional to square of speed}$$

$$\frac{P_1}{P_2} \sim \left(\frac{n_1}{n_2}\right)^3 \quad \text{Power is proportional to cube of speed}$$

The flow Q increases linearly with increasing speed (RPM), while the pressure/head H increases quadratically and the power consumption P increases cubically. In theory a reduction in speed of 20% results in an energy reduction of 50%.

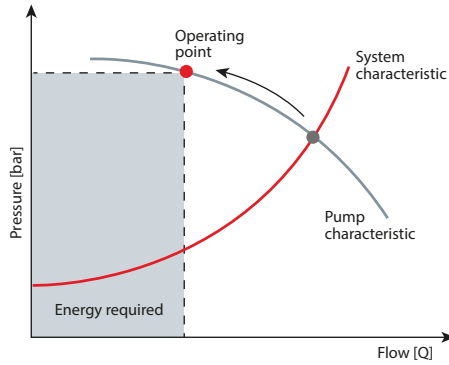

Fig. 5.10 Energy required in a variable torque pump application for throttle control

In many fan and pump's systems, swirl flaps, dampers or throttles are used for controlling the flow of the system. If a centrifugal pump is controlled using a throttle valve, throttling moves the machine's working point along the pump characteristic. The reduction in energy requirement achieved is minimal compared with the pump's nominal operating point.

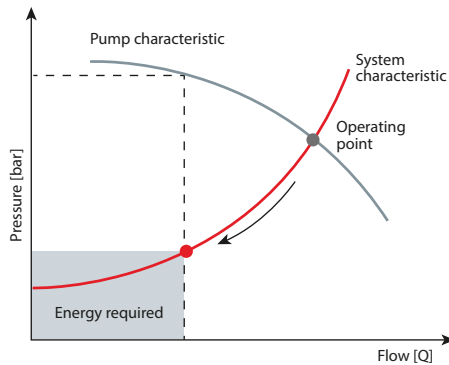

Fig. 5.11 Energy required in a variable torque pump application for speed control

If a fan/pump is speed-controlled, the operating point moves along the system characteristic. This moves the unit out of its best efficiency point and efficiency will typically decrease slightly but the energy saving due to the reduced speed is still much higher compared to throttle or other mechanical controls. In real applications, the achieved energy savings will differ from the theoretical because losses in piping and duct-work result in a basic load and thus additional losses.

In pump applications, often a minimum speed (application and pump type/make- related) is required for avoiding sedimentation of solids and ensuring sufficient lubrication of the pump. If the range between minimum speed and speed for the maximum required power is too big the system can be cascaded. When pumps are cascaded, one speed-controlled pump covers the base load. If consumption increases, the AC drive will switch in more pumps sequentially. The pumps accordingly operate at maximum efficiency whenever possible. Pump control ensures that the system is always as energy-efficient as possible. In some applications more than one pump is speed controlled. Cascades can be used in a similar way for other applications like fans or compressors.

5.4.2 Applications with Constant Torque

Applications with constant torque are applications for which the load is typically not significantly altered by the speed. This includes conveyor belts, hoists and mixers.

If, for example, an engine block is positioned on a horizontal conveyor belt, the weight of that engine block will not change, regardless of the conveyor belt speed. The torque required to move this engine block is always the same. Of course, the friction and acceleration torque would change according to the operating conditions, but the torque needed to move the load remains constant.

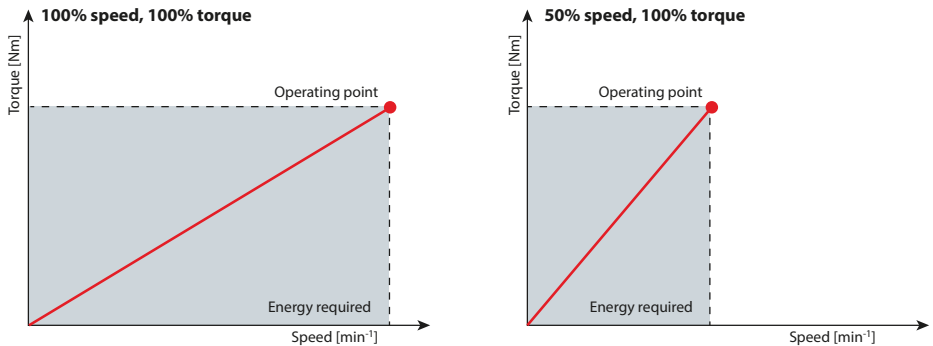

Fig. 5.12 Energy required at different speed and loads

The energy required by such a system is proportional to the required torque and the speed of the motor.

$$P \sim T \times n$$

If the speed can be reduced with a constant load as is the case in refrigeration cycles, one of the direct results will be energy savings. In other constant load applications, reduced speed will not have a huge impact. If, for example, the speed of a conveyor belt is reduced, the energy required to transport the goods from A to B stays approximately the same as the distance

stays the same. Small savings are achieved through such factors as reduced frictional loss or optimized acceleration. Nevertheless, the use of speed control in constant torque applications is continuously increasing because of the benefits to the process itself.

5.5 Life Cycle Costs

Potential ways to save energy can be found in almost all sectors, like building services, conveyor belt systems or chemical processes.

The life cycle costs of an application can be roughly divided into four parts: the initial investment cost, the cost for the operation and maintenance of the application, the cost of the energy required by the application and the disposal cost at the end of the life cycle of the application. The different components are shown in Fig. 5.13.

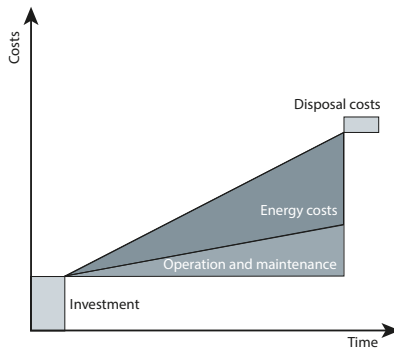

Fig. 5.13 Example of the life cycle costs of an application

The initial investment costs usually account for only approximately 10% of the overall life cycle costs, whereas the energy costs can be the largest part of the whole life cycle cost, especially in applications with a high energy consumption. Therefore, the higher initial costs of an energy-saving device often pay for themselves in next to no time.

5.6 System Savings

Successful drive system implementation is based on thorough planning and accurate dimensioning of the drive system. The actual savings are generated during the years of use – when the drive system dimensioning and configuration are optimal for the purpose. Each customer has a unique process, which means that each drive system is equally unique and must be designed in accordance with the requirements of the customer's process.

Regardless of whether the energy efficiency of a new or existing process/machine shall be improved, the whole system must always be considered. Existing installations have the advantage that measurements can be made to determine the losses, creating a benchmark as to whether improvements to the system are working as expected.

Fig. 5.14 – illustrates a drive system operating a conveyor showing most of the components which can be found in a drive system. Some of the components are optional.

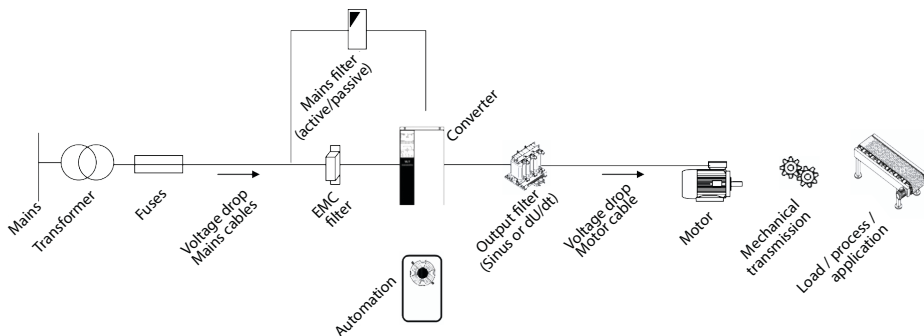

Fig. 5.14 Overview of motor drive system with various accessories

The setup and the whole dimensioning of the system depend on the application (transmission, motor, output filter and motor cable) and its environment (EMC filter, output filters, cables, mains, climate, etc.). Therefore, the engineering and the energy saving assessment should always start with the application assessment. It makes no sense to select one or two highly efficient components if they have a negative impact on the system efficiency. This is illustrated in the following example.

Example:

Fan 1 in Fig. 5.15 is a direct-driven type and the system efficiency increases when more efficient motors (better IE class) are used. Fan 2 is an EC fan with a high-efficiency motor. However, as the motor is placed as the hub in the EC fan the air flow is disturbed and the system efficiency decreases. In this case, the fan design leads to lower system efficiency.

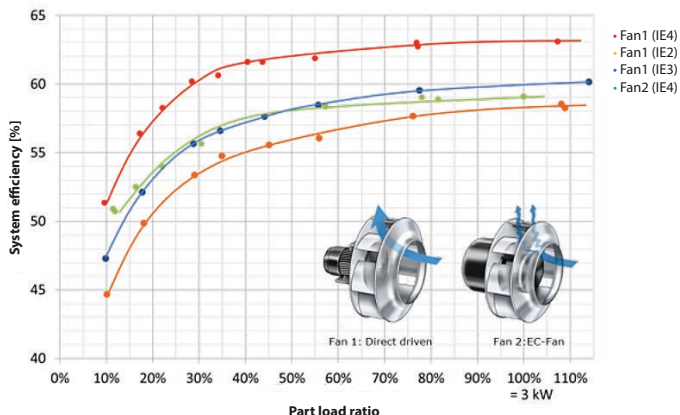

Fig. 5.15 Measurement of different ventilator fan systems with 3 kW acc. DIN EN ISO 5801 in same ventilation unit

Before deciding to make an investment, it is necessary to examine not only the technical, but also the commercial and logistical aspects, so that measures which are not cost-effective, or which are counter-productive, can be avoided or minimized. TCO (Total Cost of Ownership = total costs within a certain timeframe) and LCC (Life Cycle Costs = costs incurred within a lifecycle) are methods used for such an evaluation.

A life cycle cost analysis includes not only the procurement and installation costs, but also the costs of energy, operation, maintenance, downtime, the environment and disposal. Two factors, energy cost and maintenance cost, have a decisive effect on the life cycle cost.

$$LCC = C_{ic} + C_{in} + C_e + C_o + C_m + C_s + C_{env} + C_d$$

C_{ic} = initial capital cost (procurement cost)

C_{in} = installation and commissioning costs

C_e = energy cost

C_o = operating cost

C_m = maintenance cost

C_s = downtime and lost production costs

C_{env} = environmental cost

C_d = decommissioning and disposal costs

One of the biggest factors in the life cycle cost formula is the energy cost. Higher investments which bring the energy consumption down will, in many applications, have a major impact on energy costs in the long run.

5.7 Using Regenerated Power

Electric motors can be operated in generative mode when the torque is in opposite direction than the speed (II and IV quadrant operation – see Chapter 4.5). This can happen when decelerating the motor from one speed to another. In such a situation, the energy will flow from the motor to the drive. This energy needs to be somehow dissipated. In practice this can be done in three ways:

- injecting the energy back to the electricity grid (regenerating)
- using the energy in other drives connected together in the DC circuit (load sharing)
- burning the energy in a brake resistor

The choice of the right solution depends on several factors. The cheapest solution is load sharing, but its applicability depends on the application, if there are multiple drives in the application where some are motoring while others are generating. Using brake resistors is a bit more expensive and the energy is wasted. In many situations, especially for lower powers, this is acceptable. Regenerative drives (also known as Active Front End – AFE, Active Infeed Converters – AIC or Four Quadrant Converters, are more expensive.

Whether the use of regenerative drives is economic depends on 3 factors:

1. Available energy

Most applications generate energy during deceleration processes. This energy decreases continuously during the speed change. Theoretically, the regenerated energy is 100% of the difference between the energy which is in the system when starting and stopping the deceleration, but in reality, this figure lies somewhere between 10 and 20%. Exceptions to this are seen in lifts, cranes and hoists – in general in vertical movement operation. Furthermore, the nominal motor performance is not equal to the regenerated energy as oversizing of motors is common practice. Only very rarely does the nominal motor power hit exactly the required application power.

2. Losses

Motor, cables, gears and even the AFE itself create losses that reduce the energy which can be fed back into the grid.

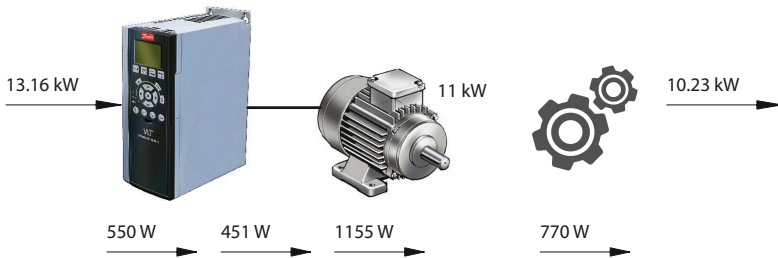

Fig. 5.16 System losses during motor operation

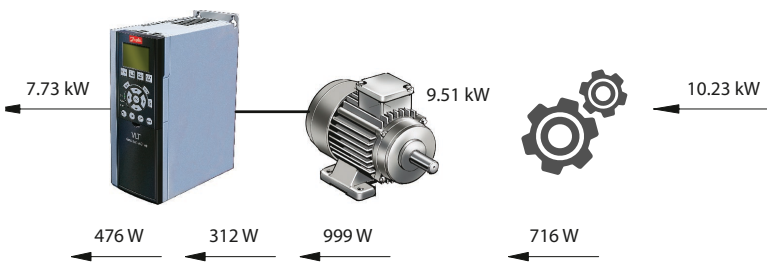

Fig. 5.17 System losses at regenerative operation

The losses caused by the AFE itself are higher than for a standard AC drive due to the active rectifier whose losses can be twice as high in operation but also in standby. Also, to prevent higher losses in the grid due to switching noise, an AFE requires a filter on the input side.

3. Occurrence

The more often the motor is operated in regenerative mode the more energy is fed back to the grid. Therefore, situations during a load cycle where energy is generated must be considered. As well as the load cycle itself, the number of load cycles defines the resulting amount of energy for a given time.

5.8 Hybridization

Hybridization refers to the combining and using of multiple energy sources to deliver power while maximizing efficiency. The idea behind hybridization is to solve issues in power demand in the most cost effective and suitable manner. This is done by introducing a means of energy storage into the system, such as batteries, super capacitors, flywheels, pumped hydro or compressed air.

The most commonly used of these are lithium-based batteries, such as lithium-ion or lithium-polymer batteries. Battery storage is often chosen in applications like back-up power due to the ability to store and deliver a charge for a fairly long period of time. Battery prices are falling quickly, driven by the growth of the hybrid and full-electric automotive industries, and followed closely by the renewable energy market. This means that, in a relatively short time, batteries will be made more viable and cost effective for customers looking to migrate to hybrid systems in their applications.

Energy storage is often described as a key enabler for integrating renewable energy into power generation. However, by equipping both machines and entire processes with energy storage systems, it is also possible to significantly improve power quality and upgrade performance and overall efficiency. Energy storage provides greater stability in power production systems by applying peak shaving to the incoming power, time shift for production and back-up power in emergency situations.

Time shifting

Time shifting involves storing energy during times when energy costs from the grid are low and supplying energy from the storage medium when energy costs from the grid are high.

Peak shaving

Peak shaving involves optimizing the energy flow between the incoming supply and local storage to meet spikes in demand. Excess energy can be stored when demand and costs are low.

Back-up power

Energy storage can be used to provide back-up power during outages maintaining the ability to operate for a period of time.

Typical applications where hybridization solutions are used:

- Solar and wind power
- Energy production
- Grid and substation
- Marine and offshore industry
- Harbors
- Process industry
- Commercial buildings
- Transportation
- Land construction & Mining

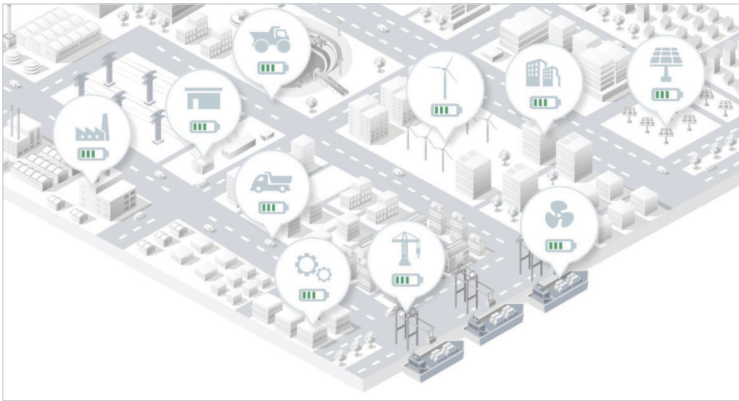

Fig. 5.18

AC/DC grid converters and DC/DC converters are used to connect energy storages into AC or DC grids. In a centralized energy storage, the energy storage is connected to the AC grid using a grid converter. The energy storage can then be used by all the loads connected to the AC grid. The grid converter is used to convert the DC voltage of the energy storage to match the voltage and frequency of the AC grid.

In an integrated energy storage, the energy storage is brought closer to the load and used to supply a single application. The energy storage can be connected straight to the DC-link or common DC bus through a DC/DC converter. The DC/DC converter is needed to convert the DC voltage from the energy storage to the DC voltage of the DC-link.

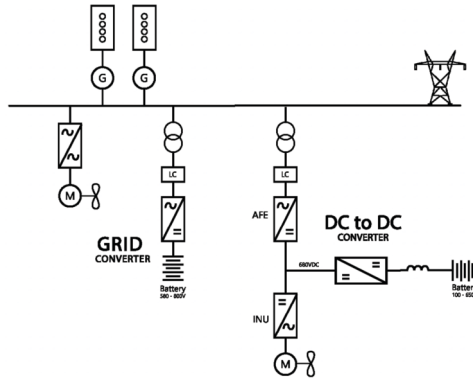

Fig. 5.19 Energy Storages Connected to the AC Grid through a Grid Converter and to the DC-Link through a DC/DC Converter

5.8.1 Grid Converter

The grid converter enables bidirectional transformation between DC and AC voltage. The converter can supply power to the AC grid from the battery or charge the battery from the AC grid.

The main components of the grid converter are an inverter unit, an LC filter and a transformer. The filter and transformer are required on the AC grid side to ensure AC power quality when supplying power to the AC grid and to have an optimal voltage for charging the battery. The transformer is also required to ensure that there is no common-mode voltage supplied to the battery.

The grid converter has a floating DC voltage on the battery side. The voltage is defined by the state of charge and load on the battery. The battery voltage can vary, but it does need to be between the minimum and maximum DC voltages which the DC-link of the drive can handle.

5.8.2 DC/DC Converter

The DC/DC converter works as a bidirectional voltage controller between the battery and the DC-link or common DC bus. Power can be supplied from the battery to the DC-link or the battery can be charged from the DC-link.

The voltage of the used battery does not need to match the DC-link voltage. The voltage can vary greatly depending on the charge of the battery and the load on the battery, but the maximum voltage of the battery must be slightly lower than the DC-link voltage.

The DC/DC converter includes an inverter unit and individual chokes for each phase on the battery side. The chokes minimize the ripple on the DC current supplied from the drive to the battery. The chokes are also used to enable the feeding of current from the lower battery voltage to the higher DC-link voltage (through DC boosting).

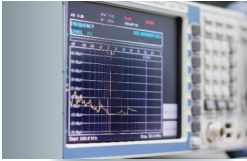

06

ELECTROMAGNETIC COMPATIBILITY

6	Electromagnetic Compatibility	133
6.1	EMI and EMC.....	133
6.2	EMC and AC Drives	134
6.3	Grounding and Shielding	136
6.4	Installations with AC Drives	140
6.5	Output filters.....	141
6.1.1	dU/dt filters	141
6.1.2	Shine-wave filter	143
6.1.3	Common-mode Filter.....	144
6.6	Bearing electric stress.....	145
6.7	European EMC Directive and EMC Standards.....	149

6 Electromagnetic Compatibility

6.1 EMI and EMC

Electromagnetic interference (EMI) is the degradation of the performance of equipment caused by electromagnetic disturbance. An example of EMI, is the noise on a microphone, if there is a cell phone next to it doing a handshake with a communication tower to process a call. In this example the cell phone is the source of the interference and the microphone is the victim equipment.

Electromagnetic noise can be propagated through conductors (conducted interference) or through electromagnetic waves (radiated interference). There are four interference coupling mechanisms:

- Galvanic coupling occurs when two circuits (noise source and victim) share a common electrically conductive connection
- Capacitive coupling (also known as electric coupling) occurs when two electric circuits have a common reference and the noise couples between two conductors through parasitic capacitances
- Inductive coupling (also known as magnetic coupling) occurs when the magnetic field around a current carrying conductor is induced in another conductor
- Electromagnetic coupling occurs when the noise source radiates electromagnetic energy through a conductor that acts as a transmitting antenna. The victim circuit receives the disturbance through a conductor that acts like a receiving antenna

There can be various sources of electromagnetic interference, such as:

- Natural sources such as lightning
- Electrical equipment which is not intended to produce electromagnetic radiation: for example, an AC drive or power supply
- Electrical equipment intended to produce electromagnetic radiation: for example, a portable radio transmitter

The art of EMI troubleshooting consists of identifying the noise source, coupling mechanism and reducing the interference coupling to an acceptable level.

When a piece of equipment or system can function satisfactorily in its electromagnetic environment without introducing intolerable disturbances in that environment, it is called electromagnetic compatibility (EMC). It is important to note that the definition of EMC contains two aspects:

- Immunity: the ability of equipment to function in the presence of some level of electromagnetic interference
- Emission: the unintended emissions from equipment need to be limited to a tolerable level

The difference between the emission margin and the immunity margin is called compatibility gap.

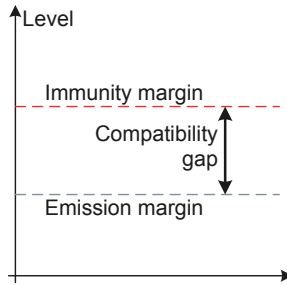

Fig. 6.1 Explanation of compatibility gap

RFI or EMI?

The term radio frequency interference (RFI) is often used interchangeably with EMI. RFI is an older term and refers to the interference of the reception of radio signals (radio, TV, wireless communication). EMI is a newer term which refers broadly to interference of any electrical equipment, including AC drives.

Common-mode and differential mode

When referring to conducted interference the terms common-mode (CM) and differential-mode (DM) are often used.

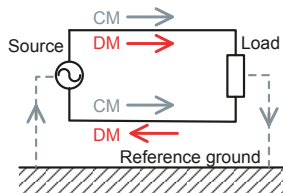

Fig. 6.2 Common-mode and differential-mode

The differential mode (DM) noise is conducted on both lines of the current loop in opposite directions, in series with the desired signal. The common-mode (CM) noise is conducted on both lines in the same direction and its return path is through a common reference ground.

6.2 EMC and AC Drives

Emission

AC drives involve fast switching of voltages (high du/dt rates) in the thousands of $V/\mu s$ range with amplitudes in the 500 V – 1000 V range (depending on supply voltage) and high current levels. This makes an AC drive a potential source of EMI and their EMC-correct installation needs to be carefully followed.

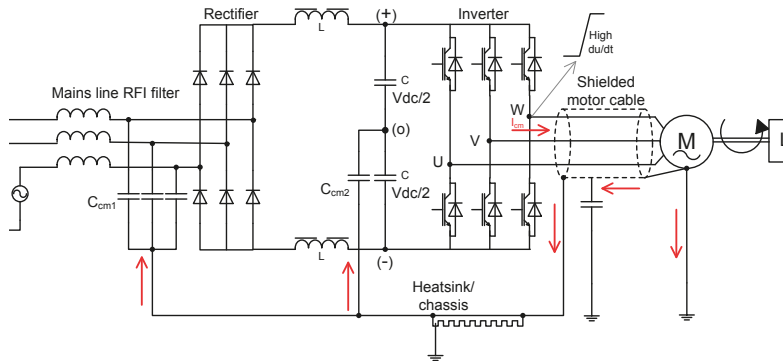

Fig. 6.3 Propagation of interference in an AC drive

The noise source is the voltage source inverter that produces a pulse-shaped output voltage with very short rise- and fall times (also expressed as high du/dt). This voltage is applied across parasitic capacitances to ground in the motor cable and motor, which results in a common-mode current:

$$I_{cm} = C_{cm} \times \frac{du}{dt}$$

where C_{cm} is the parasitic capacitance to ground.

The common-mode current needs to close the loop and return to its source, the DC-link. Controlling the return path of the common-mode current is a key element of keeping electromagnetic interference under control. Inside the AC drive there are common-mode capacitors – that means capacitors between the AC drive circuit and ground.

The common-mode capacitors can be found in the RFI circuit (C_{cm1}) or as decoupling capacitors in the DC-link (C_{cm2}). If a shielded motor cable is used and the motor end of the cable is connected to the motor chassis and the AC drive end is connected to the drive chassis then, ideally, the common-mode current will return to the DC-link via the common-mode capacitors. The common-mode current returning through the mains supply is unwanted because it can cause interference in other equipment connected to the mains. Therefore, this current must be minimized, for example by using RFI filters. When unshielded motor cables are used, then only a part of the common-mode current returns through the AC drive's chassis and common-mode capacitors thus causing more interference on the mains grid.

Immunity

Immunity, as well as noise emission need be considered in an AC drive application. The control signals connected to an AC drive can be quite susceptible to noise. In general, analogue signals are more susceptible than digital signals. Therefore, it is better to use digital bus communication instead of analogue reference signals. If analogue signals cannot be avoided, a 4 – 20 mA current reference signal is preferred to a 0 – 10 V voltage reference signal because it is less susceptible to noise.

6.3 Grounding and Shielding

Grounding

Grounding means connecting electrical equipment to a common reference ground. The two main reasons for doing this are:

- Electrical safety: Safety grounding ensures that in the case of the degradation of electrical isolation no live voltage is present on conductive parts that can be touched by a person – thus avoiding the risk of electric shock.
- Reduced interference: Signal grounding reduces voltage differences that might cause noise emission or susceptibility problems.

It is very important to note that electrical safety always has the highest priority – higher than EMC.

Various types of grounding are common.

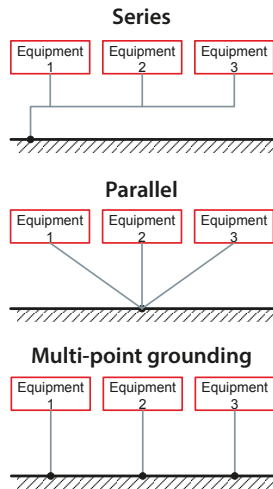

Fig. 6.4 Single point grounding in series or parallel and multi-point grounding is possible

The different types of grounding have advantages and disadvantages, but what matters at the end of the day is that the impedance of the grounding connection is as low as possible in order to provide potential equalization of the connected equipment.

Shielding

Shielding is used both for immunity (protecting against external interference) and emission (preventing interference to be radiated). In AC drive applications, shielded cables are used both for power (motor cable and brake resistor cable) and for signals (analogue reference signals, bus communication).

The shielding performance of a cable is indicated by its transfer impedance Z_T . The transfer impedance relates a current on the surface of the shield to the voltage drop generated by this current on the opposite surface of the shield:

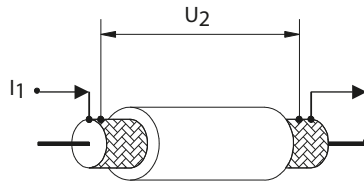

Fig. 6.5 Illustration of transfer impedance

$$Z_T = \frac{U_2}{I_1 \times L}, \text{ where } L \text{ is the cable length}$$

The lower the transfer impedance value the better the shielding performance. The figure below shows typical values of transfer impedance for different kinds of motor cable. The most common type of motor cable is the single layer braided copper wire as it offers a good shielding performance at a reasonable price.

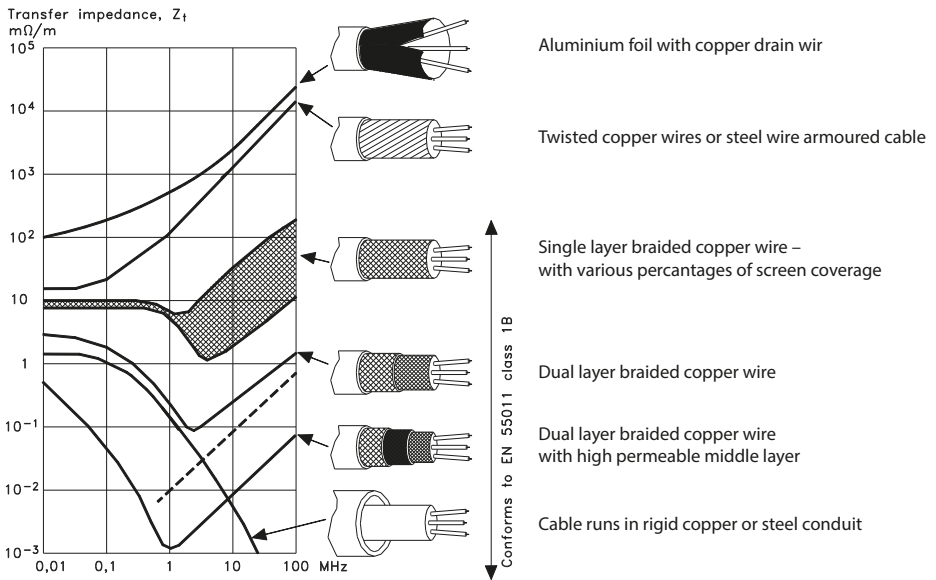

Fig. 6.6 Shielding performance of different cable types

Transfer impedance can be drastically increased by incorrect shield termination. The shield of a cable needs to be connected to the chassis of the equipment through a 360-degree connection. Using “pigtailed” to connect the shield increases transfer impedance and ruins the shielding effect of the cable.

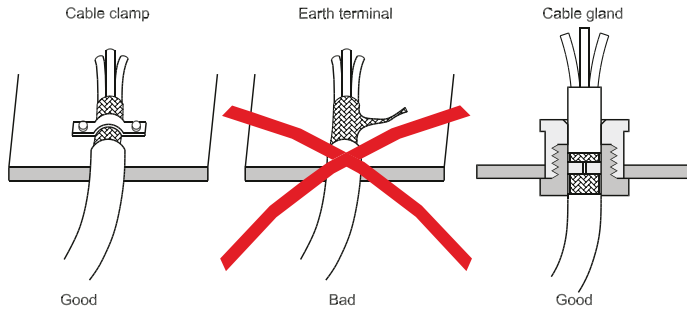
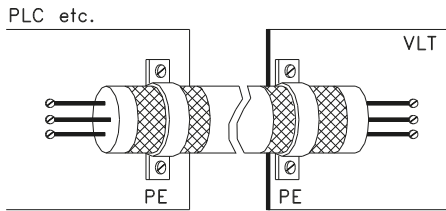

Fig. 6.7 Installation of cable shield

The question about terminating both ends or only one end of a shielded cable often occurs. It is important to realize that the effect of a shielded cable is reduced when only one end is terminated. It is very important to terminate correctly both ends of the motor cable, otherwise interference problems may occur.

The reason why in some situations only one end is terminated has to do with ground loops in signal cables. This means that there is a voltage potential difference between the chassis of the two pieces of equipment that are connected (for example AC drive and PLC) and if the shield connects the two chassis a ground current will occur (with the frequency of 50 Hz/60 Hz). This current then couples into the useful signal disturbing it – in audio applications this is commonly known as “hum”. The best solution is to use an equalizing connection in parallel with the shielded cable. If this is not possible then one end of the shielded cable can be terminated via a 100 nF capacitor. This breaks the ground loop at low frequency (50 Hz) while maintaining the shield connection in the high frequency range. In some equipment this capacitor is already built in.



Control cables and serial communication cables should normally be grounded at both ends.

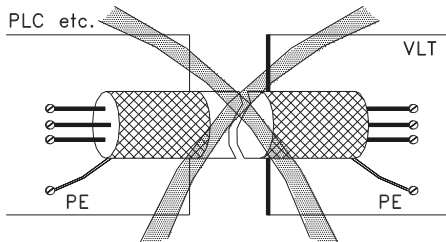

Never terminate shield through pigtail.

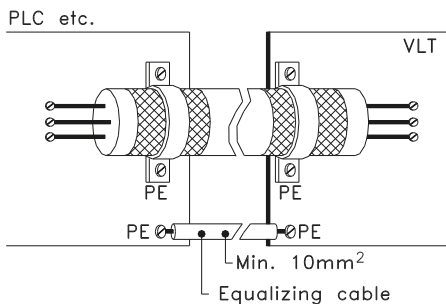

Ground potential between PLC and drive:
Disconnect cables and measure voltage with voltmeter to check.
Use equalizing cable or make sure units are bolted together.

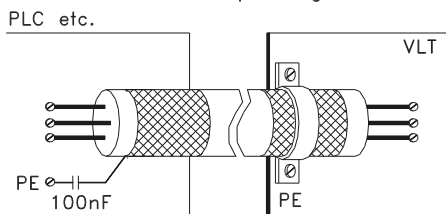

50/60 Hz ground loop: Use current clamp meter to check.
=> Ground one end through 100 nF capacitor with short leads.

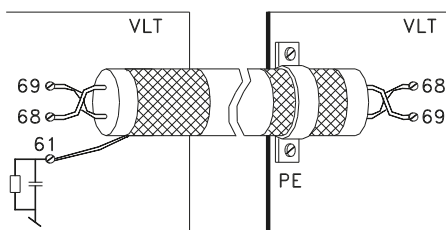

Potential equalizing currents in serial communication cable shield between two drives:
=> Connect one end of the shield to the special shield connection terminal with RC decoupling. Remember "correct" pigtail installation!

Fig. 6.8 Grounding of the cable shield

6.4 Installations with AC Drives

It is important to follow good engineering practice when installing AC drives for ensuring electromagnetic compatibility. When designing an installation, an EMC plan can be made following these steps:

- List components, equipment and areas
- Divide into potential noise sources and potentially sensitive equipment
- Classify the cables connecting the equipment (potentially noisy or potentially sensitive)
- Set requirements and select the equipment
- Separate potential noise sources from potentially sensitive equipment
- Control interfaces between noise sources and sensitive equipment
- Route cables according to the classification

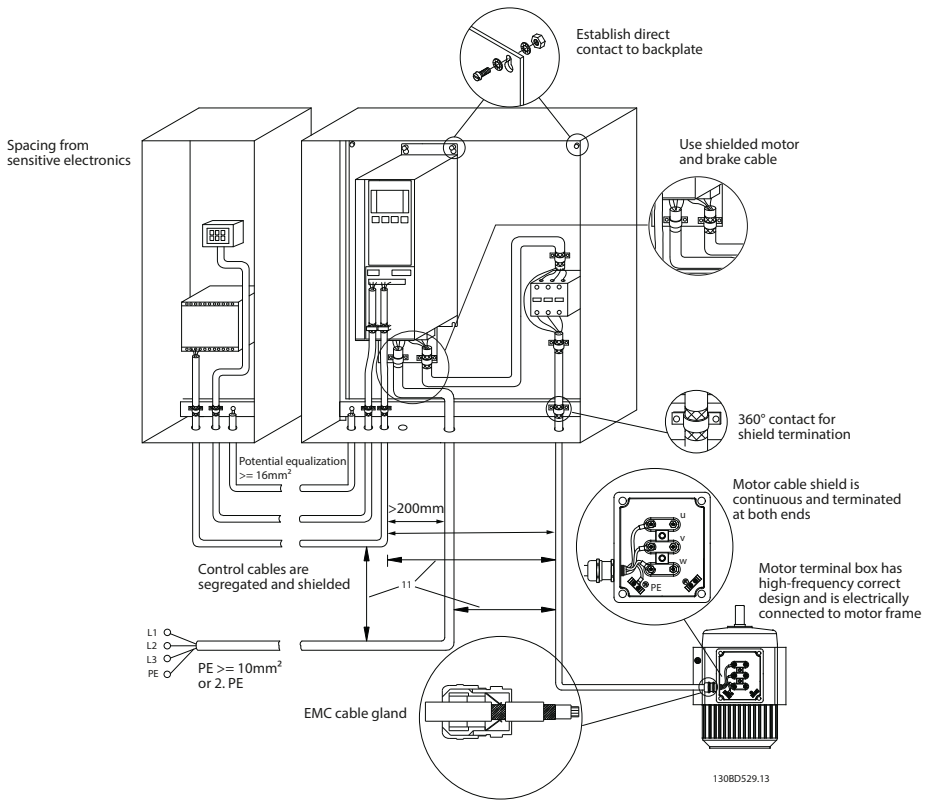

Fig. 6.9 Typical measures in practice in a simple AC drive installation

6.5 Output filters

Variable speed drives, due to their operating principle, produce a series of unwanted secondary effects, such as: motor winding isolation stress, bearing stress, acoustic switching noise in the motor and electromagnetic interference. In most applications these effects are at an acceptable level – but in some cases these effects need to be mitigated. For the mitigation of these effects, filters are installed at the output of the drives. The most commonly known filters are dU/dt filters, sine-wave filters and common-mode filters.

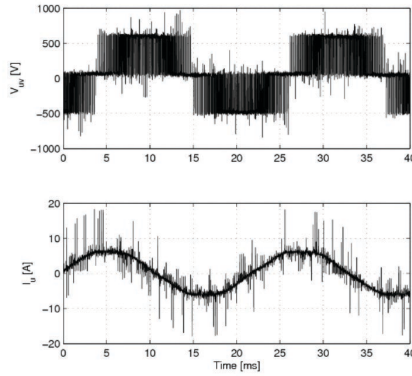

Fig. 6.10 Motor terminal voltage and current without output filters

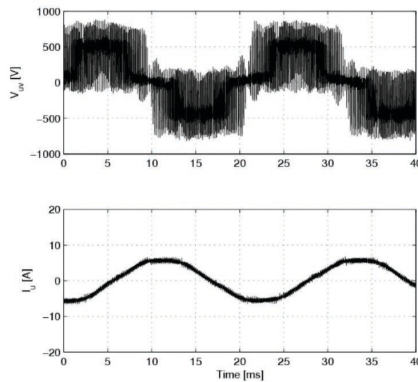

Fig. 6.11 Motor terminal voltage and current with dU/dt filters

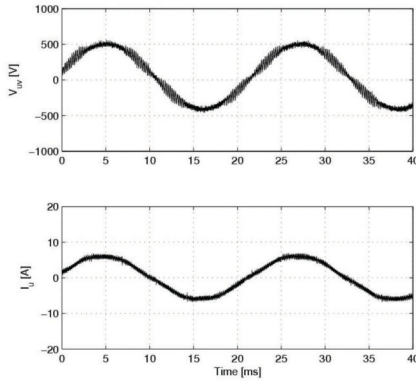

Fig. 6.12 Motor terminal voltage and current with sine-wave filters

6.1.1 dU/dt filters

dU/dt filters can have various circuit configurations, but are typically LC filters (sometimes also with damping resistors) with a cut-off frequency tuned above the switching frequency of the drive.

As their name suggests, dU/dt filters reduce the slew rate of the voltage pulses at the drive output to rates which are typically below 500 V/ μ s. This will reduce the stress of the motor winding isolation. The voltage shape remains pulse-width modulated.

There are various standards setting limits for the rise-time and peak voltage values at the motor terminals. The definition of rise-time is slightly different between international IEC standards and the American NEMA recommendation, as shown in the picture below.

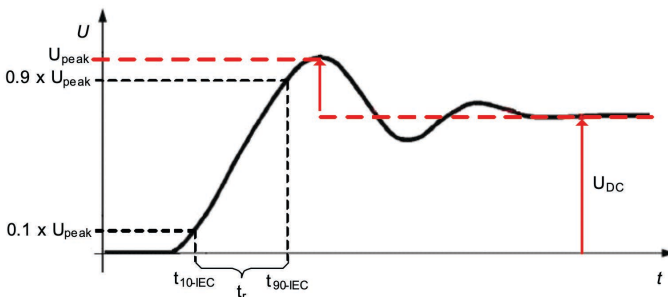

Fig. 6.13 International IEC definition of rise-time and peak voltage

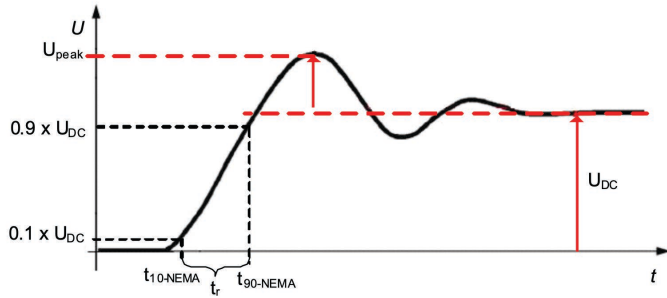

Fig. 6.14 NEMA definition of rise-time and peak voltage

The dU/dt filters increase the rise-time and help complying with the relevant standard. An example can be seen in the graph below:

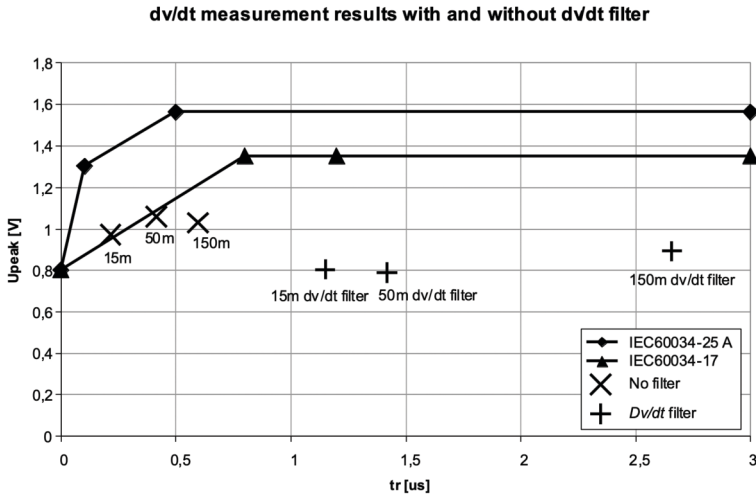

Fig. 6.15

dU/dt filters are recommended in applications with old motors with poor isolation, or in applications where the supply voltage is 690 V. In applications with short motor cables, dU/dt filters can be used for reducing the dU/dt. But in applications with long motor cables, dU/dt filters no longer make sense, because the cable itself will act as a filter and reduce the dU/dt rate at the motor terminals.

6.1.2 Sine-wave Filter

A sine-wave filter is a LC low-pass filter, whose cut-off frequency, unlike that of a du/dt filter, is set to eliminate all the high frequency components of the AC drive's output voltage. It produces a near perfect sinusoidal voltage waveform.

With a sine-wave filter, the voltage stresses on the motor correspond to those existing in normal direct-on-line (DOL) use with a power source of the same voltage. A sine-wave filter is suitable especially for old motors not designed to be used with AC drives.

A sine-wave filter eliminates bearing currents and voltage reflections, and it also reduces a motor's noise levels. If an output transformer is used, the sine-wave filter eliminates high-frequency components that could stress the transformer. The sine-wave filter also allows the use of considerably longer motor cables.

Sine-wave filters are much more expensive than du/dt-filters. This is because the desired frequency characteristics require the use of larger inductance and capacitance.

The sine-wave filter typically causes a 7-10% voltage drop. This may require boosting the output voltage of the AC drive. Also, when used in the field weakening range, the pull-out torque drops faster (than without a sine-wave filter).

6.1.3 Common-mode Filter

Common-mode filters are used to reduce bearing and ground currents, but it does not provide any significant du/dt filtering.

High-frequency common-mode filtering can be achieved using toroidal cores of nanocrystalline material to provide a higher inductance. A cable carrying a current has a magnetic field around it. The effect of the ferrite is to concentrate this field and, hence, to increase the cable's inductance by several hundred times.

If a ferrite is put on to a cable which includes all three phases, it will have no effect on the differential-mode current, but it will increase the impedance of common-mode currents. This is because the differential currents, by definition, sum to zero and therefore there is no net magnetic field. The common-mode currents produce a net magnetic flux and this flux is concentrated in the bulk of the ferrite, resulting in an increased impedance for common-mode currents only.

This is also why only phase conductors are slipped through the rings. The PE conductor must be separated. All ferrites are conductive, so it is important that cables passing through them are sufficiently well insulated. Also, the common-mode filter should be installed directly after the drive output before any other output filters.

6.6 Bearing electric stress

When the motor is rotating at normal speed, the bearings isolate the stator from the rotor. This happens because a thin film of lubricant comes in between the bearing races and the bearing balls. The thickness of the isolating lubricant film is in the range of 0,5 μm , therefore a voltage as low as 10 V can cause a breakdown of the isolation and an electrical discharge. When a discharge occurs, the metal of the bearing races and bearing balls is melted, causing a microscopic pit. The accumulation of pits in time is called pitting, and the process of deteriorating the metal of the bearings is called electrical discharge machining, shortly EDM.

While EDM has been known for almost a century (scientific papers report on this phenomenon already in the 1920'es), with the increased use of variable speed drive the occurrence of EDM seems to increase. While some of the causes can be attributed to mechanical factors (motor not designed for variable speed operation, insufficient cooling at lower speeds, prolonged operation at low speeds, etc.), the main cause leading to the increase of EDM is the increase of motor shaft voltage when a variable speed drive is used.

The root cause of shaft voltage is the steep switching rate of the drive output voltage (commonly known as dU/dt) combined with the inherent common-mode voltage produced by the output stage of the drive (inverter). Other factors leading to shaft voltage are independent of the use of drives, such as motor asymmetries or the use of asymmetric motor cables – especially in high-power applications where the motor current exceeds 100 – 200 A.

There are various mechanisms of coupling voltage to the motor shaft:

- Capacitive coupling – Caused by capacitive coupling of the common-mode voltage with high dU/dt between stator winding and rotor
- Inductive coupling – Caused by magnetic coupling of circulating currents between stator circulating currents and rotor circulating currents

What to do in the case of bearing failures?

When bearing failures occur, the appearance of a “fluting” pattern on the bearing often indicates the presence of electrical bearing stress. If the bearing is analyzed with an electron scanning microscope, the pits produced by electric discharges become visible.

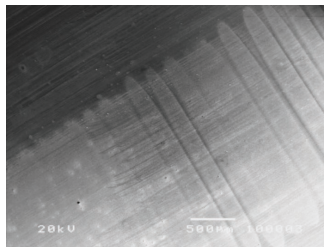

Fig. 6.16 Fluting pattern on the bearing race often indicates the presence of electrical bearing stress

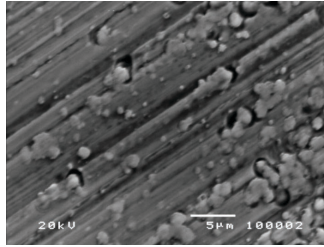
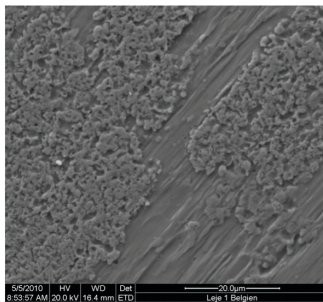

Fig. 6.17 Electron scanning microscope picture of the bearing pitting

Before taking corrective actions, it is important to determine the root cause of the bearing failure. Bearing analysis consists of visual inspection, electron microscope imaging and a chemical analysis of the lubricant.

Bearing failures can have mechanical root causes and electrical root causes. Mechanical root causes are the most frequent, but they are often handled incorrectly by interpreting them as electrical faults. Indeed, when the root cause is mechanical, the electric discharges will accelerate the wear-out. In such cases, mitigating the electric stress will extend the life time but not fix the root cause. Mechanical root causes need to be mitigated mechanically first.

The following pictures (taken with electron microscope) show examples of bearings which have suffered damage. The first picture shows a bearing that has suffered electric stress – in this case an electric measure is needed. The second picture shows a bearing that has suffered mechanical stress through incorrect axial loading. The parallel trenches in the metal have been caused by the incorrect load. But near the trenches, pitting can be seen – a sign that the damage started mechanically but was accelerated by electric stress.



ig. 6.18 Bearing which has suffered electric stress

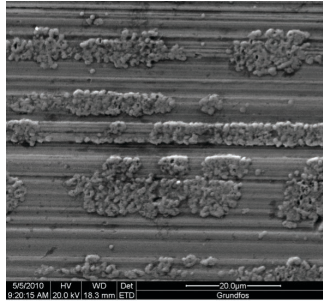

Fig. 6.19 Bearing which has suffered mechanic stress through axial loading and subsequent electric stress

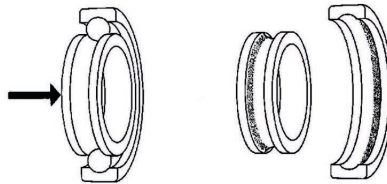

Fig. 6.20 Axial loading of a bearing

Mechanical mitigation measures

- Make sure that the motor and the load are properly aligned
- Make sure that the mechanical loading of the bearing (radial and axial) is within specifications
- Check the vibration level
- Check the grease of the bearing and make sure the bearing is correctly lubricated for the given operating conditions

Electric mitigation measures

- Provide a low-impedance return path to the high-frequency currents
- Follow EMC installation rules strictly, for example by using a shielded cable between drive and motor, and connecting the shield at both ends with a proper high-frequency connection
- Make sure the motor is properly grounded and the grounding has a low impedance for high frequency currents
- Provide a good high-frequency grounding between motor chassis and load
- It is possible to use shaft grounding brushes for eliminating the shaft voltage
- Use symmetrical motor cables, especially in high power applications where the motor current exceeds 100 – 200 A
- Use common-mode filters for reducing the high frequency currents between drive and motors

High frequency common-mode filters are a good solution for reducing electric bearing stress, but the use of such filters does not eliminate the need of an EMC-correct installation.

High-frequency common-mode filters consist of magnetic cores built using highly permeable magnetic material (nanocrystalline core). The three motor phases pass through the cores – it is absolutely necessary to follow the correct mounting instructions. Not passing all motor phases through the cores will lead to core saturation, or passing also the shield of the cable will deem the cores ineffective.

The high frequency cores can be installed either at the drive terminals or in the motor terminal box. When installed at the drive terminals, the cores will also reduce high frequency noise in the motor cable. The disadvantage of installing at the drive terminals is that the capacitive currents through the long motor cable can saturate the cores. The mounting of the cores in the motor terminal box eliminates the risk of core saturation. But in this case there will be no reduction of the electromagnetic noise from the motor cable.

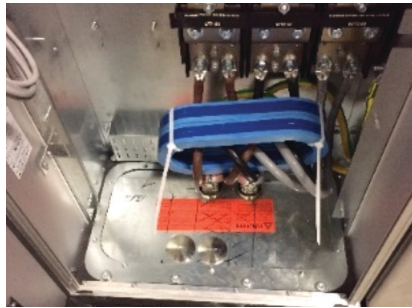

Fig. 6.21 Common-mode cores installed at the drive terminals

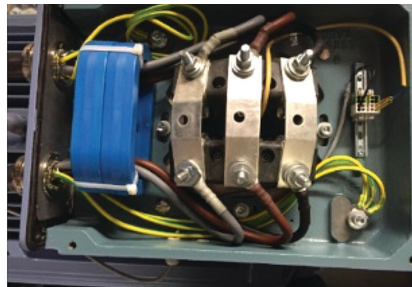

Fig. 6.22 Common-mode cores installed in the motor terminal box

6.7 European EMC Directive and EMC Standards

European EMC Directive

The latest EMC Directive is 2014/30/EU, which came into force on the 20th of April 2016 replacing the previous directive 2004/108/EC. This directive is a legal requirement in the European Union. In essence the requirements are simple:

- Products must not emit unwanted electromagnetic interference (limits emission)
- Products must be immune to a reasonable amount of interference (sets immunity requirements)

The directive itself is a political document and gives no specific technical requirements. A producer has the possibility of using harmonized standards to demonstrate compliance with the directive. Compliance with the EMC Directive (and also with other relevant directives such as the Low Voltage Directive – LVD) is stated in the product's Declaration of Conformity and the "CE" mark is affixed to the product.

The scope of the EMC Directive consists of the following two categories:

- Apparatus: a finished appliance made commercially available as a single-function unit and intended for the end user. Apparatus complying with the requirements of the Directive are marked with the CE mark
- Fixed installations: a combination of apparatus or other devices which is permanently installed at a predefined location. Fixed installations are built following "good engineering practices" and respecting the information on the intended use of its components. Fixed installations are not CE marked

EMC Standards

There are different categories of standards, as follows:

- Basic standards deal with general aspects such as test set-up, measurement technique and emission lines. For adjustable speed drives the emission limits specified in EN55011 are commonly used
- Generic standards deal with specific environments and have been mainly developed to fill in the lack of specific product standards. For residential, commercial and light industry environments the generic immunity standard is EN61000-6-1 and the generic emission standard is EN61000-6-3. For industrial environments the generic immunity standard is EN61000-6-2 and the generic emission standard is EN61000-6-4
- Product standards apply for a specific product family. For AC drives the standard is EN/IEC61800-3

The product standard for AC drives sets both immunity and emission limits depending on the environment where the drive is used: residential environment (more strict emission limits, not so high immunity levels) or industrial environment (less strict emission limits, higher immunity levels).

Environment	EN/IEC 61800-3	EN 55011	EN 61000
	Product standard	Environmental standard	Generic standard
1. Environment Residential, commercial and light industrial	Cat. C1	Class B	EN 61000-6-3
	or Cat. C2 (restricted use)	-	-
2. Environment Industrial	Cat C2	Class A, group 1	EN 61000-6-4
	Cat. C3	- (<20 kVA)	-
	Cat. C3 (I > 100 A)	Class A, group 1, 20-75 kVA high power electronic equipment	-
	Cat. C3 (I > 100 A)	Class A, group 1, >75 kVA high power electronic equipment	-
	Cat. C4 No emission limits (prepare EMC plan)	-	-

Table 6.1 EMC emission standards for drives.



07

PROTECTION AGAINST ELECTRIC SHOCK AND ENERGY HAZARDS

7	Protection against Electric Shock and Energy Hazards.....	153
7.1	General.....	153
7.2	Mains Supply System.....	154
7.3	DC Supply Systems.....	157
7.4	Ground Fault Protection.....	158
7.5	Fuses and Circuit Breakers.....	160
7.6	DC Guard for Common DC Bus Systems.....	162

7 Protection against Electric Shock and Energy Hazards

7.1 General

Electrical products are often operated with voltages and currents that are potentially hazardous to people, animals and systems. These hazards can result from physical contact, overloading, short-circuiting, destruction of components or the influence of heat or moisture.

The resulting potential hazards must be avoided, or at least reduced to an acceptable minimum, by means of precautionary planning and design combined with fault analysis and estimation of the residual risk.

Considerations to ensure the safety of AC drives during installation, normal operating conditions and maintenance needs to be addressed during the design and construction of the AC drive. Also, consideration shall be given to minimize hazards resulting from reasonably foreseeable misuse of the AC drive which might occur during its lifetime.

The protection against electrical shock is basically obtained by two levels of protection.

- Basic protection which protects the user against electrical shock under normal operating conditions. The basic protection is normally obtained by physical enclosure or barriers, or clearance /creepage distances
- Fault protection which protects the user against electrical shock under a single fault condition. The fault protection in AC drives is normally obtained by use of plastic enclosures or appropriate protective earth connection

Additionally, a protective galvanic isolation is provided between the accessible control components/circuits and power components of AC drives. This is to ensure that no dangerous voltage (e.g. mains voltage, DC-voltage and motor voltage) can appear on the control lines. This would make contact with the control lines potentially lethal, as well as creating a risk of damage to the equipment.

The international/European standard IEC/EN61800-5-1 describes in detail the requirement for protection against electrical shock as well as protection against other hazards applicable to AC drives.

The enclosure of the AC drive provides protection against injury or damage from contact. A protection rating better than IP 21 prevents personal injury due to contact. Compliance with national accident prevention regulations (such as BGV-A3, which is mandatory for electrical equipment in Germany) is also necessary to ensure protection against contact hazards.

Temperature and fire hazards

AC drives can pose a fire hazard as a result of overheating. For this reason, they should be provided with a built-in temperature sensor that stops the operation of the AC drive if the cooling arrangement fails.

Under certain conditions, a motor connected to an AC drive can restart unexpectedly. For example, this can occur if timers are enabled in the AC drive or temperature limits are monitored.

Emergency stop

Depending on system-specific regulations, it may be necessary to fit an emergency stop switch near the motor. This switch can be incorporated in the mains supply line or the motor cable without damaging the AC drive or the motor.

7.2 Mains Supply Systems

There are different ways of grounding mains supply systems, each with advantages and disadvantages. The choice can affect the safety and electromagnetic compatibility of the installation. There are three main ground arrangements, as defined in IEC 60364:

TN, TT and IT

The first letter indicates the connection between the power supply equipment and ground:

T – Terra (lat.) = direct connection to ground

I – Isolated = no ground connection/floating

The second letter indicates the connection between the supplied device and ground/network:

T – Terra (lat.) = direct connection to ground

N – Neutral = direct connection to the neutral/PE

TN-S system

The TN-S system has the best EMC performance because the neutral and PE conductors are separated. Thus, a current through the N conductor does not produce any effects on the voltage potential of the PE conductor. This is the preferred system for AC drive applications.

The advantage of TN systems is that the low impedance ground path allows easy automatic disconnection in the case of a line to PE short circuit as the same breaker or fuse will operate for either L-N or L-PE faults, and an RCD is not needed to detect ground faults.

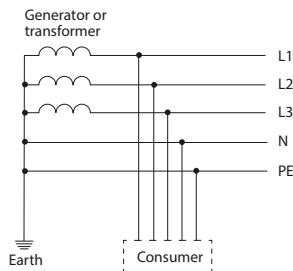

Fig. 7.1 TN-S system: Separate neutral and PE conductors.

TN-C system

In the TN-C system the PE and N conductors are combined in a PEN conductor. The disadvantage is that a current through the N conductor is also a current through the PE, thus a voltage potential between ground and the chassis of the connected equipment occurs. In a 50 Hz/60 Hz world, with linear loads, this system does not pose any special issues. But when electronic loads are present, including AC drives, the high frequency currents that occur can cause malfunctions. Although this system is compatible with AC drives, it should be avoided because of the associated risks. From an EMC perspective the TN-C system is not optimal.

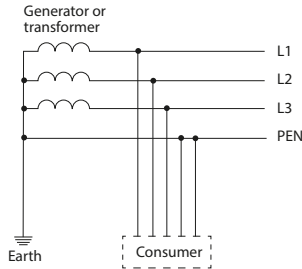

Fig. 7.2 TN-C system: In the entire system, the neutral conductor and the PE conductor are combined in the PEN conductor.

TN-C-S system

The TN-C-S system is a hybrid between TN-C and TN-S. From the transformer to the building distribution point the PE and N are common (PEN) – just like in the TN-C system. In the building the PE and N are separated, like in the TN-S. As the impedance of the PEN conductor between the transformer and the building distribution point is typically low, it reduces the negative effects that occur on the TN-C mains.

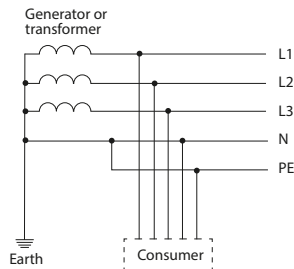

Fig. 7.3 TN-C system: In the entire system, the neutral conductor and the PE conductor are combined in the PEN conductor

TT system

In the TT system the PE at the consumer is provided by a local ground electrode. The main advantage of the TT system is that the high frequency currents in the PE circuit of the consumer are separated from the low frequency currents in the N conductor, and the grounding system is free from high and low frequency noise. From an EMC perspective this is the ideal system. Therefore, TT has always been preferable for special applications like telecommunication sites that benefit from the interference-free earthing. Also, the TT system does not have the risk of a broken neutral.

However, because of the unknown impedance of the ground connection between the ground of the transformer and the ground of the consumer, it cannot be guaranteed that a line to PE short circuit at the consumer will blow the fuses quickly enough and protect against electrical shock. This disadvantage can be mitigated by using residual current devices (RCD).

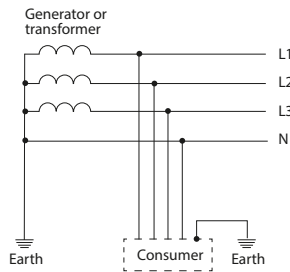

Fig. 7.4 TT system: Grounded neutral conductor and individual equipment/installation grounding

IT system

The IT network is a specific type of network encountered in industry and special environments like ships and hospitals. In the IT mains the transformer is ungrounded, and the three phases are floating. The rationale for such a system is the ability of continuing operation after a line to ground fault occurs. Isolation monitoring devices are used for observing the integrity of the isolation between phases and ground. If the isolation is degraded, maintenance can be carried out.

The disadvantage of this system is its poor EMC performance. Indeed, any ground noise current will cause the entire system to float with the noise, possibly causing malfunction of electronic equipment. When AC drives are used on IT mains special considerations must be taken, for example by disconnecting all capacitors to ground (such as the common-mode capacitors in the RFI filter) to prevent ground currents which would interfere with the ground fault monitoring systems of the network. Consequently, conducted emissions will be unfiltered and a lot of high frequency noise can be found on IT mains.

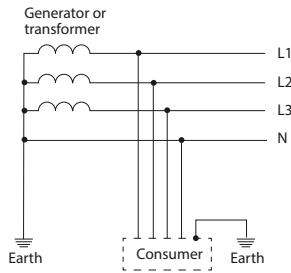

Fig. 7.5 IT system: Isolated mains; the neutral conductor may be grounded via an impedance or ungrounded

Corner-grounded network

A corner-grounded network is a system in which one corner of the transformer's delta-connected secondary is grounded. The usage of this network has decreased and is rarely used in modern installations. One of the reasons for the decline is the popularity of delta-wye transformers instead of delta-delta transformers in power transmission systems.

Grounding of one phase stabilizes the voltages of the other phases in regard to ground. The phase-to-phase voltage in the system is the same as the phase-to-ground voltages of the ungrounded phases.

When operating in a corner-grounded system, it should always be ensured that the drive is suitable for use in the particular network, as corner-grounded networks have different voltage levels.

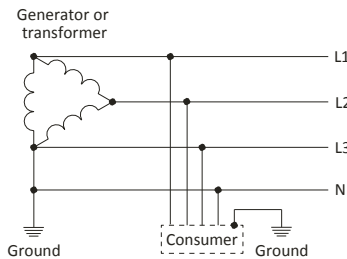

Fig. 7.6 Corner-grounded system

7.3 DC Supply Systems

The Standard IEC 60364-1 defines the DC distribution systems analogously to the AC ones:

TN-S System

Polarity or the middle point of the supply, is directly grounded. The exposed conductive parts are connected to the same grounded point. A separate protective conductor is used throughout the system. The grounded line conductor or the grounded mid-wire conductor are separated from the protective conductor.

TN-C System

Polarity or the middle point of the supply, is directly grounded. The exposed conductive parts are connected to the same grounded point. The functions of the grounded line conductor (or the grounded mid-wire conductor) and protective conductor are combined in one single PEN conductor throughout the system.

TN-C-S System

Polarity or the middle point of the supply, is directly grounded. The exposed conductive parts are connected to the same grounded point. The functions of the grounded line conductor (or the grounded mid-wire conductor) and protective conductor are combined in one single PEN conductor in parts of the system.

TT System

A polarity of the system and the exposed conductive-parts are connected to two electrically independent grounded arrangements. If necessary, the middle point of the supply can be connected to ground.

IT System

The supply source is not grounded. The exposed-conductive-parts are connected to the same grounding point.

7.4 Ground Fault Protection

The degradation of the isolation between live parts and chassis leads to ground leakage currents and can compromise both personal safety (risk of electric shock) and equipment safety (the risk of over-heating components that can eventually lead to a fire). The use of additional protective devices depends on local, industry-specific or statutory regulations.

There are two types of protection relays for additional protection. One type uses a fault voltage relay, while the other uses a residual current relay. Additional protection with a fault voltage relay (FU relay) can be provided in most installations. Protection is achieved by connecting the relay inductor between the grounding terminal of the AC drive and the system grounding point. A fault voltage trips the relay and disconnects the AC drive from the mains.

In practice, FU relays are advantageous in situations where grounding is not allowed. Whether or not they are allowed to be used depends on the regulations of the electricity supply company. This form of protection is very rarely used.

Ground Leakage protection with a residual current operated circuit breaker (RCCB) is allowable under certain conditions. Residual current operated circuit breakers contain a sum-current transformer. All the supply conductors for the AC drive pass through this transformer. The sum-current transformer senses the sum of the currents through these conductors.

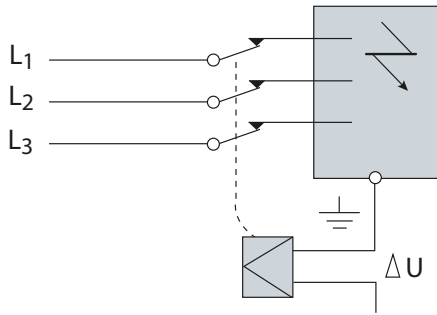

Fig. 7.7 Fault voltage relay

The sum is zero if there is no leakage current in the installation. If there is a leakage current, the sum is not zero and a current is induced in the secondary winding of the transformer. These current switches off the relay and disconnects the AC drive from the mains. Conventional RCCBs use inductive sensing and are therefore only suitable for sensing AC currents.

AC drives with B6 input bridge rectifiers can cause a pure DC current to flow in the supply cable in the event of a fault. It is recommended to check whether DC current can be present at the input to the AC drive. If it can, a Type B RCD (sensitive to both AC and DC) must be used to obtain reliable protection. This type of RCD has additional integrated circuitry that allows it to detect both AC and DC residual current.

These devices are commonly known as residual current operated circuit breakers (RCCBs). The higher-level term is "residual current operated device" (RCD) in accordance with EN 61008-1.

Filters and components for RFI suppression (common-mode capacitors) always cause a certain amount of leakage current. The leakage current produced by a single RFI suppression filter is usually just a few milliamperes. However, if several filters or large filters are used, the resulting leakage current may reach the trip level of the RCD.

The interference suppression components used with AC drives generate leakage currents. For this reason, the ground connection must be made as follows:

- If the leakage current is greater than 3.5 mA, the cross-section of the PE conductor must be at least 10 mm²
- Otherwise, the equipment must be grounded using two separate PE conductors. This is often called "reinforced grounding"



	Alternating fault currents
	Pulsating DCs (pos. and neg. half-wave)
	Sloping half-wave currents Angle of slope 90° el. 135° el.
	Half-wave current with overlay of smooth fault DCs of 6 mA
	Smooth fault DCs

Fig. 7.8 Waveforms and designations of residual currents

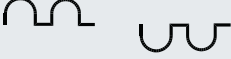
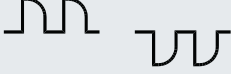
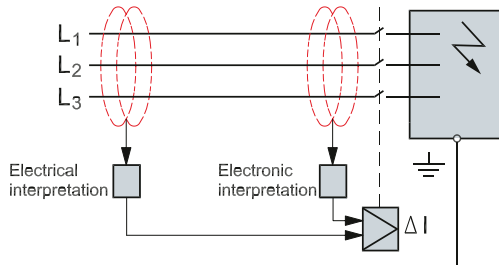

Fig. 7.9 Universal RCCB

7.5 Fuses and Circuit Breakers

For protecting AC drives and the installation against electrical and fire hazard they need to be protected against short-circuit and over-current by means of an over-current protective device (e.g. fuse or circuit breaker). The protection needs to comply with relevant local, national and international regulations.

Fuses

A fuse interrupts excessive current, to prevent further damage to the protected equipment. It is characterized by a rated current (the current that a fuse can continuously conduct) and speed (which means how long it takes to blow the fuse at a given overcurrent). The higher the current the shorter time it takes to blow the fuse. This is expressed by time current characteristics, as shown in Fig. 7.10 Time-current characteristics of fuses:

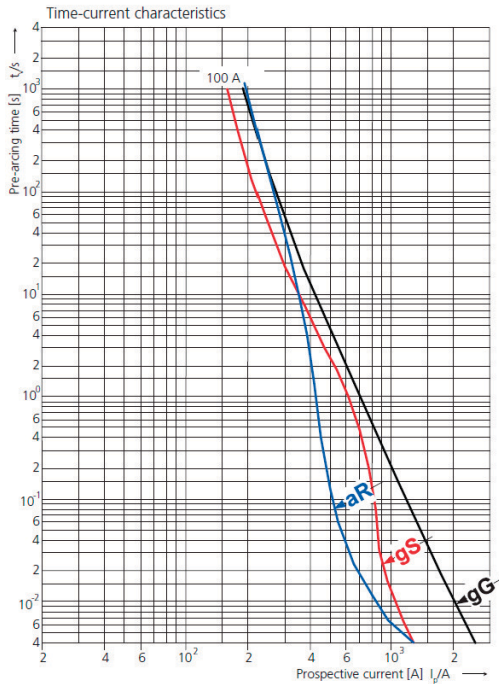

Fig. 7.10 Time-current characteristics of fuses

There are different standardized time-current characteristics depending on the intended application. For protecting AC drives typically aR fuses for semiconductor protection are used to limit the damage in case of a short-circuit or internal component breakdown. In some situations, gG type general purpose fuses can be used. For the specific fuse selection, it is important to consult the documentation of the AC drive and strictly follow those recommendations, since the recommended fuses are tested together with the drive.

Circuit breakers

Unlike fuses which are sacrificial devices that need to be exchanged after being blown, circuit breakers are electromechanical devices that can be simply reset after being activated. Because the speed of circuit breakers can be slower than fuses, their use needs to be carefully considered. The slow speed can lead to extensive damage in the protected device, subsequent overheating and even a risk of fire. Not all AC drives are suitably designed to be protected with circuit breakers. Special considerations are taken in the design phase of AC drives to limit the damage in the case of a component breakdown inside the drive. Such measures are, for example, special internal mechanical features in the enclosure, use of shields, use of deflecting foils, etc. to limit the consequences of internal failures.

Several different types of circuit breakers can be used in the main power circuit and the auxiliary circuit of an AC drive:

- Air circuit breakers (ACB) can break high voltages and currents (typically up to 6 kA). A typical application for an air circuit breaker is the main breaker of a switchgear because it has high short circuit breaking capacity. The dimensioning is based on the capacity of the busbars and thus the power of the whole switchgear. When an ACB is used with an AC drive, the drive system must include a device that quickly cuts each drive's power off in case of a short circuit. Usually an ultrafast fuse is used for that purpose since an ACB is not fast enough.
- Molded-case circuit breakers (MCCB) can break only lower voltages and currents (typically up to 1 kA) and are used in smaller applications. Also, the short circuit capacity may be a limiting factor if the MCCB is used as a switchgear's main switch. Typical applications include overload and short circuit protection of AC drives, or main switch of a compact size switchgear. Some MCCB's operate fast and thus ultrafast fuses may not be needed, if only one drive is fed by the MCCB.
- Miniature circuit breakers (MCB) can be used to protect low power electric circuits (current ratings up to 100 A). In general, the breakers can be used for overload and short-circuit protection, and mainly in low power main circuits and auxiliary and control circuits. The trip level of an MCB is usually not adjustable but fixed for each breaker. Typical short circuit breaking capacity is up to 6 kA.

It is essential to consult and strictly follow the recommendations found in the documentation of the specific AC drive regarding the use of circuit breakers, including the type and manufacturer of circuit breaker to be used, since the recommended devices have been tested with that drive.

7.6 DC Guard for Common DC Bus Systems

The main challenge in common DC bus systems, where several inverters are connected to the same DC bus, is selectivity. In case of a short circuit in the DC bus, fuses to the fault should burn, but often also fuses feeding other vital equipment in the same system will burn even though these fuses are not connected directly (nearest) to the short circuit.

During the first 100-200 μs after a short circuit occurs the capacitors inside each inverter will supply current to the fault. Since capacitors can feed out current extremely fast, selectivity will be difficult to achieve by only using fuses. One way to improve the total selectivity in a common DC bus system is to split the system in two separate DC buses, by using a fast-current cutter/DC bus tie device.

Danfoss Drives has developed the VACON® DCGuard, which can be used to connect two different DC buses if they can operate at the same DC voltage level. Power can be transferred between the two DC buses. During a short circuit situation, the DC Guard disconnects the healthy side from the faulty side before the short circuit affects the healthy side. This ensures that the healthy side can continue to operate as normal, also after the short circuit situation.

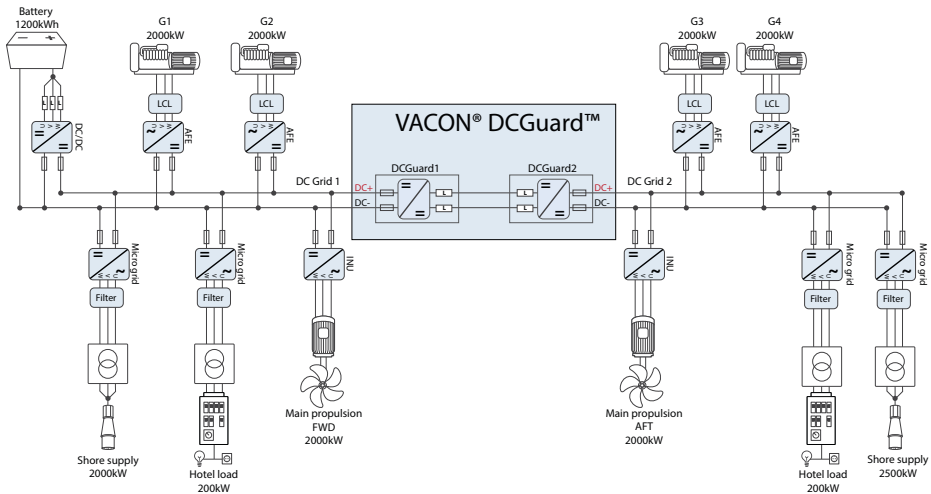
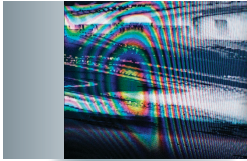

Fig. 7.11 Example of a hybrid system where VACON® DCGuard ensures the required system selectivity



08

MAINS INTERFERENCE

8	Harmonics	165
8.1	What are Harmonics?	165
8.1.1	Linear Loads.....	165
8.1.2	Non-linear Loads.....	166
8.1.3	The Effect of Harmonics in a Power Distribution System.....	168
8.1.4	The Effects of Harmonics on Motors.....	170
8.2	Harmonic Limitation Standards and Requirements	170
8.3	Harmonic Reduction Methods in AC Drives.....	171
8.3.1	Passive Harmonic Mitigation.....	173
8.3.2	Active Harmonic Mitigation	174
8.4	Harmonic Analysis Tools.....	175
8.4.1	VLT® Motion Control Tool MCT 31.....	176
8.4.2	Harmonic Calculation Software (HCS)	176

8 Harmonics

8.1 What are Harmonics?

8.1.1 Linear Loads

On a sinusoidal AC supply a purely resistive load (for example an incandescent light bulb) will draw a sinusoidal current, in phase with the supply voltage.

The power dissipated by the load is: $P = U \times I$

For reactive loads (such as an induction motor) the current will no longer be in phase with the voltage but will lag the voltage creating a lagging true power factor with a value less than 1. In the case of capacitive loads, the current is in advance of the voltage, creating a leading true power factor with a value less than 1.

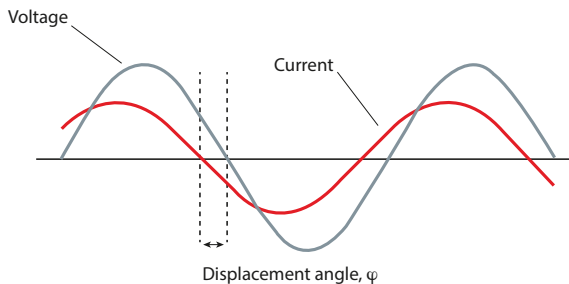

Fig. 8.1 Linear Load

In this case, the AC power has three components: real power (P), reactive power (Q) and apparent power (S).

The apparent power is: $S = U \times I$

In the case of a perfectly sinusoidal waveform P, Q and S can be expressed as vectors that form a triangle:

$$S^2 = P^2 + Q^2$$

Units: S in kVA, P in kW and Q in kVAR.

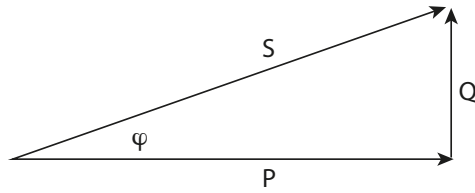

Fig. 8.2 Components of AC Power: Real Power (P), Reactive Power (Q) and Apparent Power (S)

The displacement angle between current and voltage is ϕ .

The displacement power factor is the ratio between the real power (P) and apparent power (S):

$$\text{DPF} = \frac{P}{S} = \cos\phi$$

8.1.2 Non-linear Loads

Non-linear loads (such as diode rectifiers) draw a non-sinusoidal current. Fig. 8.3 shows the current drawn by a 6-pulse rectifier on a three-phase supply.

A non-sinusoidal waveform can be decomposed in a sum of sinusoidal waveforms with frequencies equal to integer multiples of the fundamental frequency.

$$f(t) = \sum_{h=1}^{\infty} A_h \sin h\omega t$$

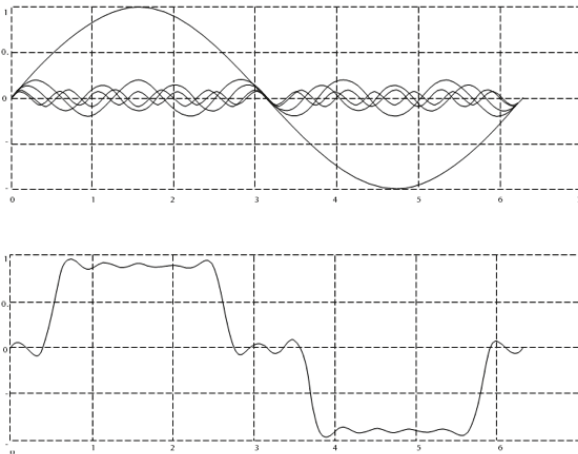

Fig. 8.3 Non-linear Load: Current drawn by a 6-pulse rectifier on a 3-phase supply

The integer multiples of the fundamental frequency ω_1 are called harmonics. The RMS value of a non-sinusoidal waveform (current or voltage) is expressed as:

$$I_{\text{RMS}} = \sqrt{\sum_{h_1}^{h_{\text{max}}} I_1^2(h)}$$

For normal rectifiers, the amplitude of the harmonic decreases with increasing frequency. Theoretically (for a square wave), the amplitude of the harmonic h is:

$$I_h = \frac{I_1}{h}$$

where I_1 is the fundamental current and h is the number of the harmonic.

Power electronics generate only odd harmonics. Even harmonics are excluded as long as the positive and negative halves of the current cycle are identical.

In three-phase systems only harmonics with the order $v = k \times p \pm 1$ exist. For a 6-pulse system these are the 5th, 7th, 11th, 13th etc.

h = multiple of the basic frequency

$k = 1, 2, 3, \dots$

p = pulse number of the rectifier bridge (6, 12, 18, etc.)

In single phase systems all odd harmonics may exist.

The amount of harmonics in a waveform gives the distortion factor, or total harmonic distortion (THD), represented by the ratio of RMS of the harmonic content to the RMS value of the fundamental quantity, expressed as a percentage of the fundamental:

$$\text{THD} = \sqrt{\sum_{h_2}^{h_{\text{max}}} \left(\frac{I_h}{I_1}\right)^2} \times 100 \%$$

Using the THD, the relationship between the RMS current I_{RMS} and the fundamental current I_1 can be expressed as:

$$I_{\text{RMS}} = I_1 \times \sqrt{1 + \text{THD}^2}$$

The same applies for voltage.

The true power factor PF (λ) is:

$$\text{PF} = \frac{P}{S}$$

In a linear system the true power factor is equal to the displacement power factor:

$$PF = DPF = \cos(\varphi)$$

In non-linear systems the relationship between true power factor and displacement power factor is:

$$PF = \frac{DPF}{\sqrt{1 + THD^2}}$$

The power factor is decreased by reactive power and harmonic loads. Low power factor results in a high RMS current that produces higher losses in the supply cables and transformers. Note that as long as the voltage is not considerably distorted, only the basic frequency transmits power. Currents at other frequencies just flow, technically forming a kind of reactive current. For rectifiers the fundamental power factor is approximately 0.95 or higher.

In the power quality context, the total demand distortion (TDD) term is often encountered. The TDD does not characterize the load, but it is a system parameter.

TDD expresses the current harmonic distortion in percentage of the maximum demand current I_L .

$$THD = \sqrt{\sum_{h=2}^{h_{\max}} \left(\frac{I_h}{I_L}\right)^2} \times 100 \%$$

Another term often encountered in literature is the partial weighted harmonic distortion (PWHD). PWHD represents a weighted harmonic distortion that contains only the harmonics between the 14th and the 40th, as shown in the following definition.

$$PWHD = \sum_{h=14}^{40} h \left(\frac{I_h}{I_1}\right)^2 \times 100 \%$$

8.1.3 The Effect of Harmonics in a Power Distribution System

The picture below shows an example of a small distribution system. A transformer is connected on the primary side to a point of common coupling PCC1, on the medium voltage supply. The transformer has impedance Z_{xf} and feeds a number of loads. The point of common coupling where all loads are connected is PCC2. Each load is connected through cables that have respective impedance Z_1, Z_2, Z_3 .

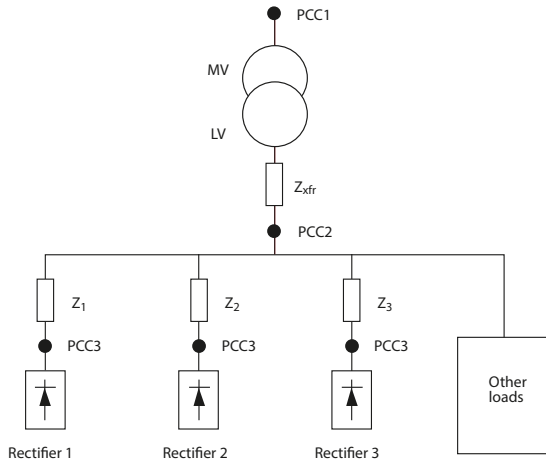

Fig. 8.4 Example of Distribution System

Harmonic currents drawn by non-linear loads cause distortion of the voltage, due to the voltage drop on the impedances of the distribution system. Higher impedances result in higher levels of voltage distortion.

Current distortion relates to apparatus performance and it relates to the individual load. Voltage distortion relates to system performance. It is not possible to determine the voltage distortion in the PCC knowing only the harmonic performance of the load. To predict the distortion in the PCC the configuration of the distribution system and relevant impedances must be known.

A commonly used term for describing the impedance of a grid is the short circuit ratio R_{SCE} , defined as the ratio between the short circuit apparent power of the supply at the PCC (S_{SC}) and the rated apparent power of the load (S_{equ}).

$$R_{SCE} = \frac{S_{SC}}{S_{equ}}$$

where $S_{SC} = U \times I_{SC}$ and $S_{equ} = U \times I_{equ}$

The negative effect of harmonics is twofold:

- Harmonic currents contribute to system losses (in cabling, transformer)
- Harmonic voltage distortion causes disturbance to other loads and increase losses in other loads

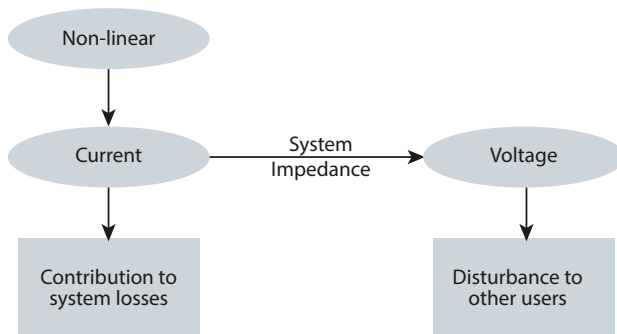

Fig. 8.5 Negative Effects of Harmonics: System Losses and Disturbance

8.1.4 The Effects of Harmonics on Motors

Generators and motors are negatively affected by harmonics generated by non-linear loads, although direct-on-line motors are not affected by them. Typical effects are:

- Increased heating due to iron and copper losses at the harmonic frequencies
- Higher audible noise emissions
- Harmonic currents in the rotor

Harmonic currents in the rotor are caused by harmonics in the stator winding, e.g., 5th- and 7th-order stator harmonics will produce 6th-order rotor harmonics, while 11th- and 13th-order stator harmonics will produce 12th-order rotor harmonics. These rotor harmonic currents will result in increased rotor heating and pulsating or reduced torque.

It should also be noted that system unbalance (standing unbalance or ground faults), expressed as negative-sequence currents, can also reflect into the rotor as harmonic currents, which add to those noted above.

8.2 Harmonic Limitation Standards and Requirements

The requirements for harmonic limitation can arise from:

- Application-specific requirements
- Requirements for compliance with standards

The application-specific requirements are related to a specific installation where there are technical reasons for limiting the harmonics.

Example: 250 kVA transformer with two 110 kW motors connected.

Motor A is connected directly to mains supply, and Motor B is supplied through AC drive B. There is a need to retrofit AC drive A, so that Motor A is supplied through its own drive, but the transformer will, in this case, be undersized. Solution: In order to retrofit without changing the transformer, mitigate the harmonic distortion from AC drives A and B using harmonic filters.

There are various harmonic mitigation standards, regulations and recommendations. Different standards apply in different geographical areas and industries. The most common are the following:

- IEC/EN 61000-3-2, Limits for harmonic current emissions (≤ 16 A per phase)
- IEC/EN 61000-3-12, Limits for harmonic currents (> 16 A and ≤ 75 A)
- IEC/EN 61000-3-4, Limitation of emission of harmonic currents (> 16 A)
- IEC/EN 61000-2-2 and IEC/EN 61000-2-4 Compatibility levels for low frequency conducted disturbances
- IEEE519, IEEE recommended practices and requirements for harmonic control in electrical power systems
- G5/4, Engineering recommendation, planning levels for harmonic voltage distortion and the connection of nonlinear equipment to transmission systems and distribution networks in the United Kingdom

8.3 Harmonic Reduction Methods in AC Drives

The line current of unmitigated diode rectifiers has a total harmonic distortion (THDi) of at least 80%. This high distortion value is unacceptable in most applications with AC drives. Therefore, it is necessary to have some harmonic mitigation. The level of harmonic mitigation depends, as explained earlier, on the specific installation and the harmonic standards the installation needs to comply with.

An overview of the various harmonic mitigation methods is shown in Table 8.1 – Harmonic Mitigation Methods.

Mitigation method	Circuit diagram	Typical current waveform
No mitigation THD > 80%		
DC inductors THD < 40%		
AC inductors THD < 40%		
Passive harmonic filter THD < 10%		
Multi-pulse rectifier (12/18) THD < 10%		
Active front end THD < 5%		
Active filter THD < 5%		Waveform similar to AFE

Table 8.1 Harmonic Mitigation Methods

Harmonic mitigation can be achieved by using either passive or active circuits.

8.3.1 Passive Harmonic Mitigation

DC inductors

DC inductors are placed in the DC-link between the rectifier and the bulk DC capacitor. It is possible to use a single inductor in either the plus or the minus side or use two inductors. This solution reduces THDi to values between 35 and 45%.

AC inductors

AC inductors are placed on the line side of the rectifier. Their harmonic performance is similar to DC inductors and reduce THDi to typical values of between 35 and 45%, depending on the size of the inductor.

DC vs. AC inductors

Since DC and AC inductors have similar harmonic performance levels the question about the differences between the two solutions often arises. First of all, even if the THD value is similar, the effect of the two solutions on the components of the harmonic spectrum is different. DC inductors attenuate more the low frequency components (5th, 7th, 11th harmonic) while the AC inductors have a better performance for higher harmonic orders.

Across inductors an AC voltage drop occurs. In the case of AC inductors, a voltage drop will occur, typically around 4%. In the case of DC inductors, the DC current does not cause a voltage drop. The only voltage drop across DC inductors results from the current ripple of the rectifier. Consequently, using DC inductors will result in a higher DC-link voltage, thus the ability to provide more torque at the motor shaft. This is the major advantage of DC inductors. The main advantage of AC inductors is that they protect the rectifier against transients from the mains.

Passive harmonic filters

Passive harmonic filters are connected in series with the mains supply. They can be realized with various circuit topologies that typically consist of combinations of inductors (L) and capacitors (C), sometimes also damping resistors R. The filter circuit can be a low-pass circuit, tuned to specific harmonics (5th, 7th, etc.) or slightly de-tuned, to avoid the risk of resonances. The performance of passive filters depends on the specific AC drive's DC-link configuration (with/without DC inductors, value of capacitance) and a performance level can be assured for a specific configuration.

Passive filters have the disadvantage of being quite bulky (comparable in size with the AC drive). They have a capacitive power factor that needs to be considered during system level design for avoiding resonances.

Multi-pulse rectifiers

Multi-pulse rectifiers are fed from phase-shift transformers. The most common solutions are with 12 pulses (2 x 3 phases) or 18 pulses (3 x 3 phases). Through phase-shifting, low order harmonics are in 180° opposition, cancelling each other. For example, in the case of 12-pulse rectification the phases of the secondary windings of the transformer have a 30° phase offset (the offset between the D and Y windings). In this configuration the 5th and 7th harmonics are cancelled, and the largest harmonics will be the 11th and 13th. Multi-pulse harmonic mitigation requires large transformers – larger than the AC drive. Also, the performance is reduced in non-ideal conditions such as voltage imbalance.

8.3.2 Active Harmonic Mitigation

Active Front End (AFE)

The diode rectifier can be replaced with an inverter with active switches (usually IGBT transistors), similar to the inverter at the motor side. The grid-side inverter is pulse-width modulated and the input current is nearly sinusoidal. The harmonics of the mains frequency are not present. On the other hand, the switching frequency components are injected to the mains grid. In order to reduce the switching noise a passive filter is used, usually in a low-pass L-C-L topology (two inductors and capacitors between the inductors).

The main advantage of the AFE is that it allows four-quadrant operation: that means that the energy flow is bi-directional and in the case of regenerative braking the energy can be injected back to the grid. This is advantageous in applications with frequent braking or long-time braking such as cranes or centrifuges.

The disadvantage of the AFE solution is a relatively low efficiency and a high complexity. When the application does not require bi-directional energy flow the energy efficiency of the AFE is inferior to an active filter solution.

Active filters

Active filters (AF) consist of an inverter that generates harmonic currents in anti-phase with the harmonic distortions on the grid thus achieving a 180° cancellation effect. The operation principle is illustrated in the illustration below, where the AF cancels the harmonic currents from a diode rectifier.

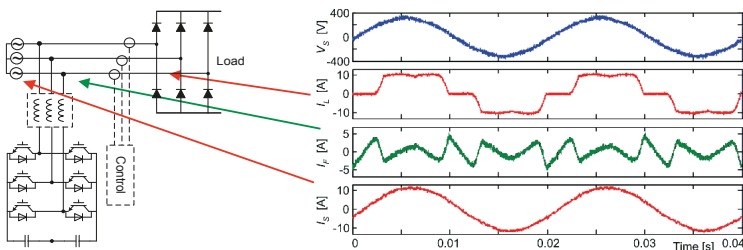

Fig. 8.6 Operation Principle of an Active Filter

As in the case of AFE, an LCL filter is needed to eliminate the noise at the switching frequency.

Active filters are connected in parallel with the non-linear (harmonic generating) load. This allows for several harmonic mitigation possibilities:

- Individual compensation of non-linear loads: an active filter compensates harmonics from a single load. Danfoss offers an optimized filter + AC drive package called “Low Harmonic Drive (LHD)”
- Group compensation: harmonics from a group of several loads (for example AC drives) are compensated by a single filter
- Central compensation: harmonics are compensated directly at the point of common-coupling of the main transformer

The filter can be sized for the harmonics only, as it is connected in parallel with the load and does not need to handle the full load current.

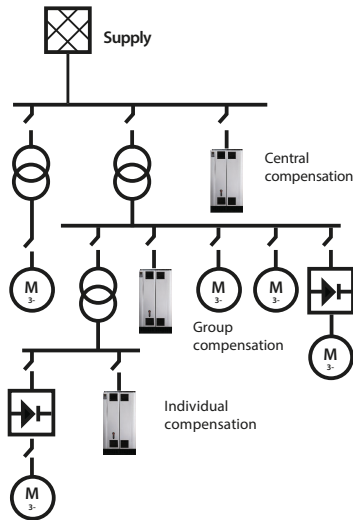

Fig. 8.7 Harmonic compensation can take place in different areas of the network

8.4 Harmonic Analysis Tools

Harmonic analysis tools can be used to calculate harmonics in a system and design the optimal harmonic mitigation solution to meet specific requirements. The advantage of software tools is that different solutions can be compared, allowing the selection of the best solution.

There are a variety of commercially available software tools ranging from simple calculation tools for a non-linear load to complex software packages that allow the design of an entire power system.

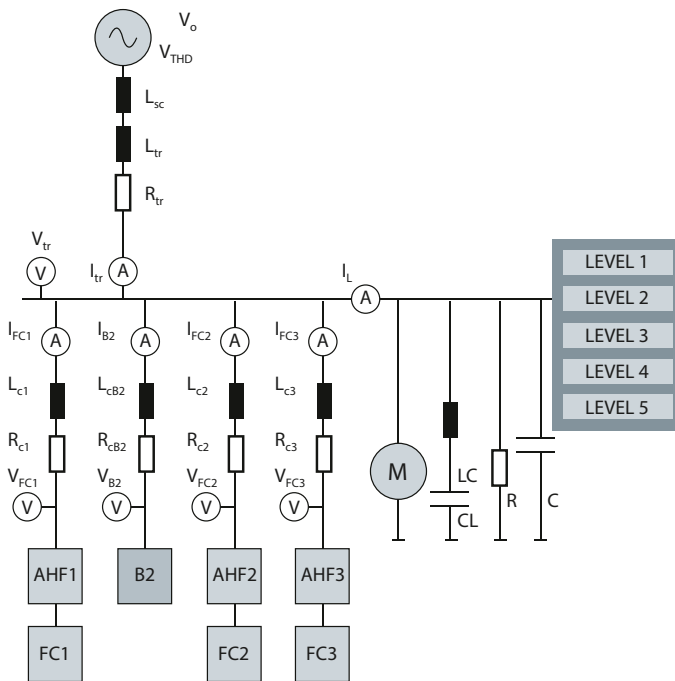

Fig. 8.8 Calculation model with current and voltage measurement points

Danfoss offers two software tools:

- the offline tool VLT® Motion Control Tool MCT 31 and
- the on-line tool HCS (Harmonic Calculation Software)

8.4.1 VLT® Motion Control Tool MCT 31

MCT 31 is an off-line software package used to calculate harmonics based on polynomial interpolation between pre-defined simulation results. The advantage of this method is speed and the disadvantage is that it is less precise compared to a full simulation.

MCT 31 enables simulations with all Danfoss products, including mitigation solutions such as AHF passive filters and AAF active filters. Generic, non-Danfoss AC drives can be simulated as well. MCT 31 can generate harmonic reports.

8.4.2 Harmonic Calculation Software (HCS)

The HCS tool can be accessed on-line at www.danfoss-hcs.com. It is available in two levels: basic for simple calculations and expert for more complex system level calculations.

Behind the web interface of the HCS tool is a powerful circuit simulator that performs a simulation of the specific system designed by the user. Therefore, it is more precise than the interpolation-based MCT 31.

HCS has a vast library containing Danfoss AC drives and AHF passive filters. The simulator creates time-domain and frequency-domain graphs of the voltages and currents in a system and compares the harmonics to different norm limits. HCS can also generate reports in HTML or PDF format.

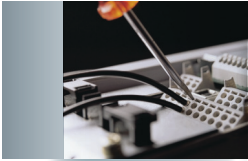

09

INTERFACES

9	Interfaces	179
9.1	Human Machine Interface (HMI).....	179
9.2	Operating Principles of Serial Interfaces	181
9.3	Standard Serial Interfaces in AC Drives	183
9.4	Fieldbus Interfaces in AC Drives	184
9.5	Fieldbuses Standardisation.....	185
9.6	Industrial Ethernet and the Internet of Things.....	187

9 Interfaces

9.1 Human Machine Interface (HMI)

The Human Machine Interface (HMI) is an important and vital part of AC drives today. The HMI interface can vary from a basic LED status indicator to a sophisticated fieldbus system with detailed AC drive information. The HMI will set up an interface between a human and an application that allows the user to control, monitor and diagnose the application.

Modern AC drives today often have these HMI interfaces:

LED



Fig. 9.1 LED indication

LED indicators show when:

- power is applied to the AC drive
- a warning is active on the AC drive
- an alarm is active on the AC drive

Control panel



Fig. 9.2 Numerical and alphanumerical control panels

A control panel provides an easy possibility to control the AC drive, monitor its actual status and for easy commissioning of the application. Control panels vary from ones with a simple numerical display to ones with more graphic alphanumerical displays.

The new VLT® Wireless Communication Panel LCP 103 has a Wi-Fi connection and communicates with the MyDrive® Connect application. The app can be downloaded on a smart device, which can then be used for easy commissioning, operation and maintenance of the drive.



Fig 9.3 VLT® Wireless Communication Panel LCP 103 connecting the AC Drive and Mobile Device

Input and output terminals

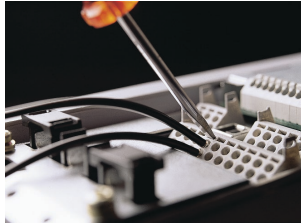

Fig. 9.4 Input and output terminals

Dedicated input and output control terminals are available to build an interface between a PLC control and the AC drive.

Input control signals like start/stop, coast or reverse control will ensure that the user has functions to control the AC drive according to the application. For controlling the speed, and feedback signals from the application analogue input signals like 0-10 V or 0/4-20 mA can be applied. Feedback signals from the AC drive to the PLC are digital output or relay output which can be configured to indicate status like "motor running" or "alarm". Also, analogue output signals from the AC drive can be configured to monitor, for instance, the actual load conditions.

Software tools

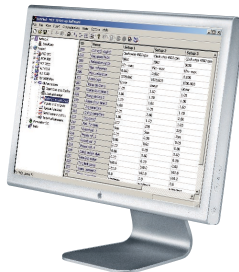

Fig. 9.5 Software tools

Integration of the AC drive into PC software gives the user full system configuration and control. With PC Software it is possible to monitor the entire system more effectively for faster diagnosis, and better preventive maintenance.

A modern PC Software tool can be used as follows:

- For planning a new communication network offline. PC Software tools contain a complete database with supported AC drive products
- For commissioning AC drives online
- For easy replacement of an AC drive, in the event of failure
- For easy expansion of the network with more AC drives
- For back-up of parameter settings of AC drives in a communication network
- Software supports fieldbus protocol. This will eliminate the need for an extra communication network

Fieldbus

Use a standardized fieldbus interface between the PLC and AC drive for commissioning, control and monitoring of the application.

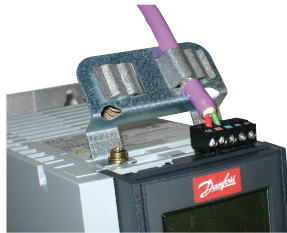

Fig. 9.6 Fieldbus connection

9.2 Operating Principles of Serial Interfaces

In serial data transmission, the bits (with a state of 0 or 1) are transmitted individually, sequentially. A logical 0 or a logical 1 is defined by specified voltage levels. Various methods and standards have been developed to ensure fast, error-free data transfer. The method used depends on the specification of the interface. If we look at the lowest level of data transfer, a distinction can be made between how the bits are transmitted electrically (current or voltage signal) and the system used (line coding). If the bits are transmitted via a voltage signal, the focus is less on the voltage level than the reference potential of the level.

Principle	Standard (application)	Devices connected per trunk circuit	Max. distance in mm	Number of lines	Signal level
	RS 232 (point to point)	1 sender 1 receiver	15	Duplex min. 3+ various status signals	$\pm 5\text{ V min.}$ $\pm 15\text{ V max.}$
	RS422 (point to point)	1 sender 10 receivers	1200	Duplex: 4	$\pm 2\text{ V min.}$
	RS485 (Bus)	32 senders 32 receivers	1200	Semi duplex: 2	$\pm 1.5\text{ V min.}$

Table 9.1 3 fieldbus principles and typical specifications

RS-232/ EIA-232 interface

The RS-232 interface, launched as early as 1962, was for a long time the serial interface par excellence. When a serial interface was mentioned in relation to PCs, it referred to RS-232. RS-232 was conceived for communication between two devices (point-to-point connection) at low transmission speeds.

RS-422/ EIA-422 interface

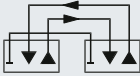
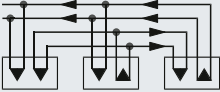
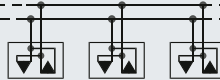
RS-422 allows both point-to-point and multi-drop networks to be built. In multi-drop networks, it is possible to connect multiple receivers to one transmitter.

The data is transmitted differentially via twisted data cables. One pair of lines is needed for each transmission direction for full duplex operation.

RS-485/ EIA-485 interface

RS-485 is regarded as a higher-level version of the RS-422 standard and accordingly has similar electrical properties.

In contrast to RS-422, however, RS-485 is designed as a multi-point (bus-capable) interface over which up to 32 devices can communicate. There are now also transceiver modules (combined transmitter and receiver module) with which networks of up to 256 devices can be implemented. The actual maximum possible network size depends on both the transmission rate (line length) and the structure of the network (network topology).

USB interface

The Universal Serial Bus (USB) standard was developed in 1995 by Intel in conjunction with companies in the IT industry. The USB 2.0 extension of the standard in 2000 increased the transmission speed from 12 Mbps to 480 Mbps. Additionally, in 2008 USB 3.0 was introduced, allowing transmission speeds of up to 5 Gbps. The data is transmitted differentially via a twisted pair. The maximum cable length between two devices must not exceed 5 m.

Despite its name, USB is not a physical data bus, but rather a point-to-point interface. The term “bus” in the name USB refers only to the structure with which a network can be built. The USB specification provides for a central host (master) to which up to 127 different devices can be connected. Only one device can be connected directly to a port. An additional hub is required to connect more than one device to a port.

Ethernet interface

The Ethernet standard was developed back in the early 1970’s. Since then Ethernet has become more and more present in all kinds of products. In the 90’s Ethernet found its way to the automation field via protocols like: MAP, Modbus TCP and EtherNet/IP™.

Ethernet typically runs on 100 Mbps, over STP cables (Shielded Twisted Pair), but is also available in wireless, fiber optic and other media. The benefit of using Ethernet is not only the fast speed and standardized cables & connectors, but the ability to access data inside automation equipment from the office network. This allows status to be read from all over the plant, even from another continent.

Despite the fact that all Ethernet protocols runs on Ethernet, it does not mean that it is possible to run different Ethernet technologies in the same network. Technologies that change the arbitration or have strict demands towards timing make a mix of technologies impossible. The mainstream Ethernet technologies today are PROFINET®, EtherNet/IP™, Modbus TCP, POWER-LINK and EtherCAT®. Today, these technologies have more than 90% of the market share in new installations.

9.3 Standard Serial Interfaces in AC Drives

Today, most AC drives are fitted as standard with a serial system interface that can be used for connection to a network.

Various standardized protocols are generally supported, in addition to unpublished, manufacturer-specific (proprietary) protocols. Physically, the interfaces are very often based on the specifications of the Ethernet or RS-485 interfaces.

Since older AC drives might only have a serial RS-485 interface available, interface converters are required for implementation. Manufacturer-specific solutions in which a particular AC drive is required are widespread. If the interface specification is published, simple industry-standard converters (such as USB to RS-485) can be used.

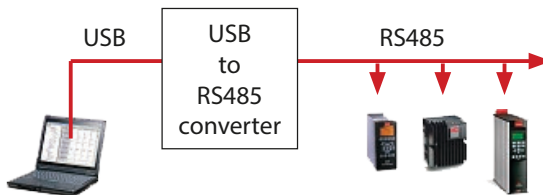

Fig. 9.7 USB to RS 485 communication

AC drives are increasingly being fitted with USB interfaces for simple data exchange with a PC. Since many PCs have USB interfaces, the use of interface converters is becoming obsolete.

9.4 Fieldbus Interfaces in AC Drives

The use of modern AC drives without a serial communication interface is almost inconceivable today. In the simplest case, the interface consists of two data lines through which the AC drive can be controlled, monitored, configured and documented. Almost all bus systems enable multiple devices to be on the same network.

Compared with conventional AC drive control via digital and analogue inputs and outputs, there is less cabling involved in serial bus systems, which reduces installation cost. On the other hand, costs are incurred for the interfaces and additional components are required to control the bus system. Depending on the bus system used, only a few networked devices are necessary to generate considerable cost benefits compared with conventional control.

Traditional wiring. No fieldbus.

In this type of network, communication between the drive and PLC requires one cable for each parameter that needs to be controlled. The advantage of such a system is that the individual components themselves are relatively cheap, and the system itself is not among the most complex.

This, however, comes at a price, as such systems are relatively expensive both to install and extend, as each additional parameter or drive requires new cabling, PLC programming and often more I/O hardware. For owners this means higher capital costs and restricted flexibility. At the same time the risk of error is high, as the risk of a faulty connection to the PLC increases with the number of cables.

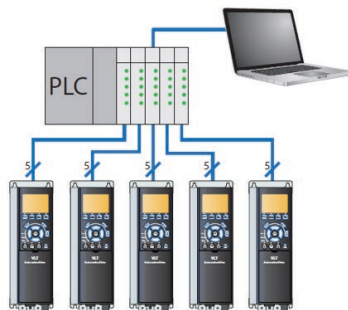

Fig. 9.8 Traditional wiring. No fieldbus

Fieldbus wiring

A typical fieldbus system only uses twisted pair cables to connect the drive to the PLC. Despite the higher cost of components, fieldbus systems offer several advantages over older, hardwired systems: fewer cables, faster commissioning and a reduced risk of faults.

Additional drives are connected in a serial Ethernet-based network that can be extended easily. New parameters only need to be coded into the PLC, which is both faster, safer and at significantly lower cost than a hardwired system.

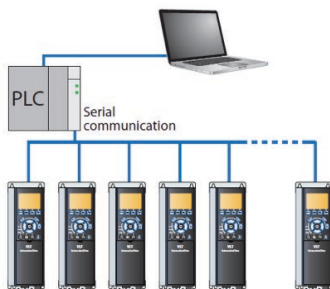

Fig. 9.9 Fieldbus wiring

Fieldbus over Ethernet

The Ethernet interface enables the possibility to access drive parameters and information from locations outside the production facility. This method bypasses the traditional control hierarchy, as communication with the fieldbus-fitted drives and other equipment does not necessarily need to pass through the PLC.

External access is routed through a firewall, enabling communication with the fieldbus option's built-in webserver.

Not only does this provide a high degree of flexibility during commissioning, it also provides advantages such as external monitoring and application support.

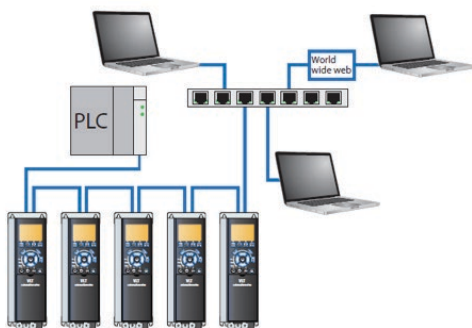

Fig. 9.10 Fieldbus over Ethernet

9.5 Fieldbus Standardization

The development of fieldbuses began in the 1980s so that the benefits of serial communication could also be used in the field. The driving force for the development included not only the potential to save cost and time during planning and installation but also the ease of expansion and increased interference immunity when transmitting analogue signals.

In the years that followed, it became clear that the success of a system depends not only on industrial capability in a demanding environment but also on “openness”.

In open-bus systems, the installation and control are the same, irrespective of the manufacturer of the bus components. The end user can therefore replace a (defective) device from one manufacturer with a device from another manufacturer without having to make major changes to the system.

The principal difference between the interfaces and bus systems available on the market are the physical design and the protocols used. Which system is used depends on the requirements of the application in question.

Fast processes such as packaging machines may need bus cycle times of just a few milliseconds, whilst response times of seconds may suffice for climate control systems.

For the purposes of better classification, communication systems can be considered in terms of data volume, transfer time and transmission frequency. The diagram below shows the basic division into three different levels.

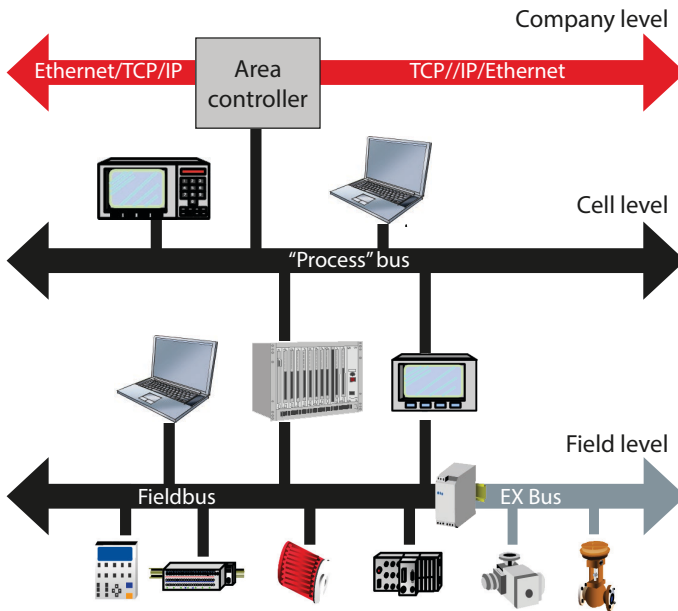

Fig. 9.11 Production pyramid

- At the company level, large data volumes in the megabyte range are exchanged. The transfer times can extend to hours.
- At the cell level, the data volume decreases to the kilobyte range. At the same time, the transfer time shortens (seconds) and frequency of data exchange (minutes/hours) rises.
- At the field level, very small data volumes of a few bytes or even bits are exchanged. The transfer time and transmission frequency are a matter of milliseconds.

The world's most important fieldbuses have been standardized since 1999 in IEC 61158.



Fig. 9.12 Typical fieldbuses

Different Bus systems have more or less significance depending on the region and application. If you look at drive technology, Profibus® and its Ethernet based successor (PROFINET®) can be considered to have a larger market share in Europe. In contrast, DeviceNet™ and EtherNet/IP™ are frequently used in North and South America as well as in Asia. This defines the precondition for the high market acceptance of the respective Ethernet based successors PROFINET® in Europe and EtherNet/IP™ in North America.

9.6 Industrial Ethernet and the Internet of Things

An AC drive is equally a device, which can be connected to internet, but due to available high amount of data and potentially sensitive data, this cannot be done without considering cyber security related to data transfer. Some protocols, like MQTT are possibly popular, but not necessarily suitable for delivering data from AC drive. In MQTT there is always broker party in data transfer and it is difficult to secure the data transfer when there is "middle-man" in every message. It is important to consider security of the data transfer, when planning the architecture of data highway from AC drive to end user – nowadays to end user's cloud.

Services like real-time remote monitoring (e.g. DrivePro® Remote Monitoring) of AC drives from any location can bring high value to end user. When combining information from two or more AC drives into one view, can bring base for analytics and very valuable information for trouble shooting.

Using Gateway, part of the security related challenges can be better handled. Connecting AC Drive into Internet by using just Ethernet connection is not a good idea from security point of

view, due then it is highly exposed for any kind of attacks. Using Gateway, where also several drives can be connected, will create a barrier, which protects sub-net behind Gateway.

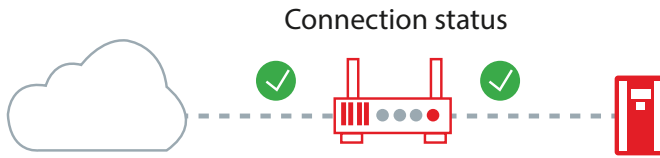

Fig. 9.13

When data sources are delivering notable amount of data, it is very important to have a proper management of the data. There essential is that somewhere in the system is function handling device management. This is one of the key components, which also means that device management needs to be adapted with devices is takes care of.

Technology:	Data & Analysis:	System & Process:
<ul style="list-style-type: none">• Device management• Gateway management• User management• Data security• Gateway• Connectivity<ul style="list-style-type: none">• To drives• To internet• UI-Data, dashboards• Cloud to cloud data	<ul style="list-style-type: none">• Analyzes• Trends (history data)• Dataloggers• Failure history• Parameters• Drive info• Realtime view• Lifetime evaluations	<ul style="list-style-type: none">• Data for actual process• Verification of set-up in commissioning vs. best setup from reference drives

Combining analytics capabilities to IoT solution brings additional benefits. It is important to understand what kind of analytics is required and what are the limitations related. On analytics made in drive – EDGE Analytics – will require some capacity available in AC drive. Sometimes that simply is not applicable, if requirements and expectations about analytics are not in par with capabilities available. Having data available in an environment where capabilities are not limited, will give much freedom for data treatment. Even then, analytics is always a matter of tuning it to facts that are intended to be found. In lower level of analytics scale, identifying clear failures and highly extra ordinary deviation from norm - anomaly – can be done in edge or cloud. In more advanced methods like using machine learning implementing needed algorithms may not be possible thus leaving that needs to be performed in cloud.

VLT FC302



Open Manuals

Live Metrics - drive

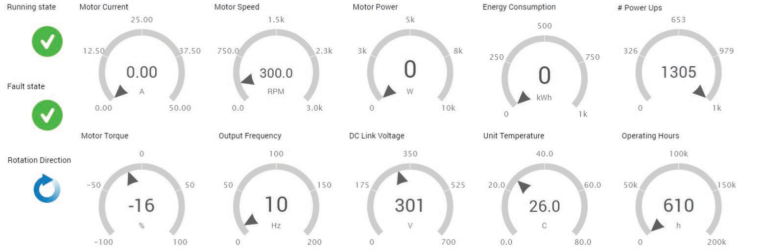

Drive Status History

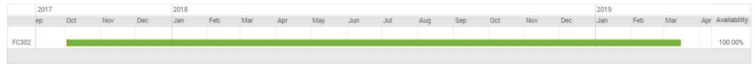

VACON 100



Show drive info

Open Manuals

Live Metrics

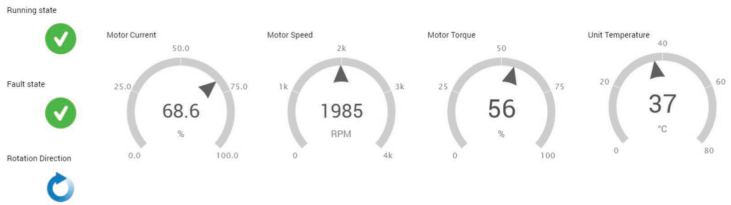

Drive Status History

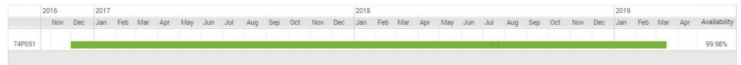



10

SIZING AND SELECTION OF FREQUENCY CONVERTERS

10 Sizing and Selection of AC Drives	191
10.1 Get the Drive Rating Right	191
10.2 Rating of the Frequency Converters from Motor Specification	191
10.3 Overload Capacity	193
10.3.1 Energy Efficiency Concerns	194
10.4 Control Range	195
10.5 Heat Losses and Cooling the Drive	196
10.5.1 Air-Cooled Drives	197
10.5.2 Liquid-Cooled Drives	199
10.6 Derating of an AC Drive	200
10.7 Regenerative Energy	201
10.8 Motor Cables	201
10.9 Environment	202
10.10 Centralized versus Decentralized Installation	204
10.11 Examples	206

10 Sizing and Selection of AC Drives

10.1 Get the Drive Rating Right

Selecting the right AC drive is a key aspect of designing a variable speed drive system. If the selected unit is too small, it will not be able to control the connected motor optimally at all necessary operating points. If, on the other hand it is too large, there is a risk that the motor will not always be controlled properly, and the design may not be cost-effective.

For the design of most AC drives, knowledge of the following basic parameters is sufficient:

- Rating of AC drive from motor specifications
- Current distribution in the AC drive ($\cos \phi$ of the motor)
- Overload capacity
- Control range and field weakening
- Derating of the AC drive
- Regenerative energy
- Motor cable length
- Environmental factors (temperature, altitude, etc.)
- Central versus de-centralized installation

After clarification of the basic design parameters for an application, design and analysis of the mechanical components is carried out. The motor to be used must be determined before a suitable AC drive can be selected. In facility service systems, for example, final selection often takes place only shortly before the building is completed.

Only at this time are most of the components to be used defined, so that an optimized analysis of flow conditions can be carried out reliably.

The more dynamic and challenging the application, the greater the number of factors that must be considered in the design. Since AC drive manufacturers can save costs by restricting the technical features, for each particular case it is necessary to confirm that the features needed for the drive are actually available.

The most important factor when defining a drive system configuration is the process where the drive system will be used. Finding the optimal drive system type and configuration in each case requires knowledge of the process requirements: torque, speed and load cycle.

10.2 Rating of the AC Drive from Motor Specifications

A widely used method for selecting AC drives is simply based on the rated power of the motor to be used. Although manufacturers specify the power ratings of their drives, this data normally relates to standard four-pole motors. Since the rated currents of motors differ significantly at the same power depending on the construction of the motor (e.g. standard motor and geared motor) and its number of pole pairs, this method is only suitable for providing a rough estimate

of the proper drive size. Fig. 10.1 – Nominal current for 1.5 kW motors of different poles and manufacturer – shows examples of the rated currents of various 1.5 kW motors.

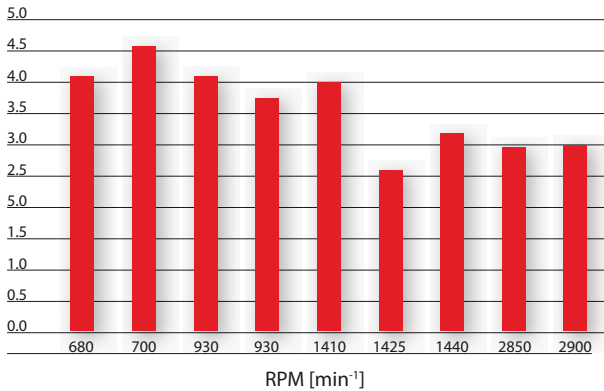

Fig. 10.1 Nominal current for 1.5 kW motors of different poles and manufacturer

Furthermore, it should be noted that the current drawn by a motor depends on whether it is connected in star or delta configuration. For this reason, AC drives should be selected based on the rated current for the type of configuration selected (star or delta).

In addition to the motor current, the required motor voltage must be considered. Many AC drives can operate over a wide mains supply voltage range (e.g. 3 x 380 – 500 V) and thus provide a wide output voltage range. Be aware that a drive running at reduced voltage will not be able to deliver the specified kVA, as the reduction in voltage will not be offset by an increase in current.



Fig. 10.2 Identification data of a Danfoss AC drive

The nameplate in Fig. 10.2 Identification data of a Danfoss AC drive comes from a 0.75 kW drive. The specified current values apply to two different voltage ranges. The AC drive can deliver 2.4 A with a mains voltage of 380 – 440 V. If the unit is supplied with a mains voltage of 441 – 500 V, it can only deliver 2.1 A. The apparent power available with both voltage ranges is 1.70 kVA.

10.3 Overload Capacity

When selecting an AC drive, the load conditions of the application should always be considered first. A fundamental distinction is made between quadratic and constant load characteristics, which are the most common in practice.

When an AC drive controls a motor, torque limits can be set for that motor. Selecting an AC drive with an apparent power rating that matches the rated current or power of the motor ensures that the required load can be driven reliably. However, an additional reserve is necessary to enable smooth acceleration of the load and also cater for occasional peak loads.

Below are examples of a constant-torque characteristic. If a load is placed on a conveyor belt, the torque that must be applied to transport the load is constant over the entire speed range.

Application	Excess load
Lifting equipment	160%
Conveyor belt	160%
Stirrer / Mixer / centrifuge	160%
Rotary piston compressor / piston compressor	150%
Spiral pump (thick sludge)	150%
Sludge dehydration press	150%
Piston pump	150%
Rotary gate valve	150%
Rotary piston blower	110%
Surface aerator	110%
Metering pump	110%
Booster pumps (2-stage)	110%
Recirculation pump	110%
Side channel blower for pool aeration	110%

Table 10.1 Typical overloads in constant torque applications

With a constant-torque load, an over-load reserve of approximately 50 to 60% for 60 seconds is typically used. If the maximum over-load limit is reached, the response depends on the AC drive used. Some types switch off their output and lose control of the load. Others are able to control the motor at the maximum over-load limit until they trip for thermal reasons.

A variable-torque load characteristic usually occurs in applications where increasing speed leads to an increasing quadratic load torque. Fans and centrifugal pumps are amongst the types of equipment that display behavior of this kind. Furthermore, most applications with a quadratic torque characteristic, such as centrifugal pumps or fans, do not require rapid acceleration phases. For this reason, excess load reserves of 10 % are usually chosen for quadratic torques.

Application	Excess load
Fan	110%
Well pump	110%
Booster pump / centrifugal pump	110%
Filter infeed pump	110%
Groundwater pump	110%
Hot water pump	110%
Non-clogging pump (solid materials)	110%
Centrifugal pump / fan	110%
Primary and secondary heating pump	110%
Primary and secondary cooling water pump	110%
Rainwater basin evacuation pump	110%
Recycling sludge pump	110%
Spiral pump (thin sludge)	110%
Submerged motor pump	110%
Excess sludge pump	110%

Table 10.2 Typical overloads in variable-torque applications

Even with variable-torque load and an over-load capacity of 10% modern AC drives can be set up to have a higher break-away torque at start to ensure the proper start of the application. Remember to consider whether the application will always require a quadratic torque. For example, a mixer has a quadratic torque requirement when it is used to mix a very fluid medium, but if the medium becomes highly viscous during processing, the torque requirement changes to constant.

10.3.1 Energy Efficiency Concerns

In chapter 5 Saving Energy with AC drives we have seen different considerations to be taken to save energy. It is important to remember, that the most energy efficient solution is where the machine, the motor and the AC drive are selected for the best system efficiency. For example, fans speed will typically differ from nominal speed, and so the motor, but many motors have their highest efficiency at a speed between 75 and 100% of nominal speed.

Some brands of AC drive have a built-in software function, which secure the best motor shaft power related to the drive input power.

10.4 Control Range

The advantage of an AC drive lies in its ability to regulate smoothly the speed of the motor. However, a wide variety of limits are set for the available controlling range.

On the one hand the possible controlling range (speed range) depends on the control algorithms available of the unit. With the simple U/f control, control ranges that can vary within 1:15 can usually be achieved. If a control algorithm with a voltage vector control is used, a range of 1:100 is possible. If the actual motor speed is fed back to the AC drive by an encoder, adjustment ranges from 1:1000 to 1:10000 can be realized. For more details about the different control methods, see chapter 3.7.

In addition to the limits of the control algorithms used, the field-weakening range around the rated frequency of the motor and also low speed running must be taken into account. At low speeds, the motor's self-cooling capacity is reduced. Therefore, in the event of continuous operation in this speed range, either a separately powered external fan must be used to cool the motor, or the shaft load must be reduced. The speed below which the torque must be reduced can be found in the manufacturer's data sheets.

If the motor is operated in the field-weakening range, the reduction in the available torque with $1/f$ and the breakdown torque with $1/f^2$ must also to be considered. The field-weakening range begins when the AC drive can no longer hold the U/f ratio constant. In Europe this point typically lies at 400 V/50 Hz and in North America at 460 V / 60 Hz. For more information, see chapter 4.1.1.

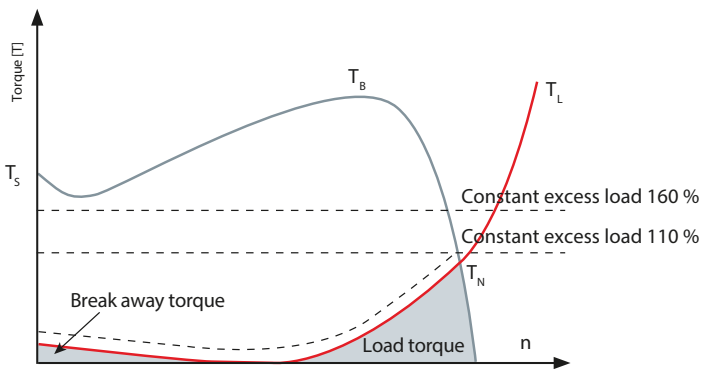

Fig. 10.3 AC drive with an optimized characteristic for quadratic loads and an over-load of 110%. In order to achieve higher breakaway torque, the drive is sometimes started with a constant torque before the quadratic characteristic is used

Sometimes motor manufacturers specify higher available torque at a lower duty cycle. A design optimized for intermittent operation can be economical, but it requires a more complex design as shown in Fig. 10.4 Obtaining a good match in speed selection.

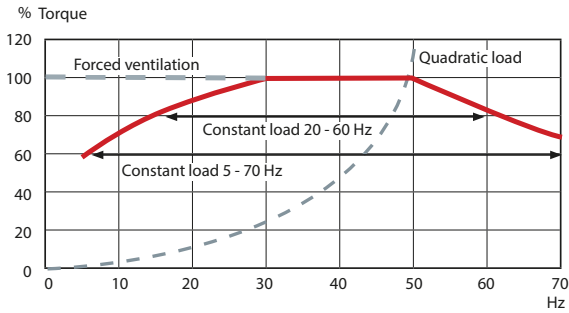

Fig. 10.4 Obtaining a good match in speed selection

10.5 Heat Losses and Cooling the Drive

The efficiency of AC drives is very high, but there are still conduction and switching losses, which cause heating of the drive. This heat must be removed to prevent further heating and possible damage to the drive components. Repeated overheating will compromise the operation and shorten the lifetime of the drive. The need for cooling the drive varies greatly with the load and output frequency of the drive as well as the used switching frequency.

One of the most critical components that need to be cooled are the semiconductor modules. The heat dissipation ability of the modules itself is insufficient to moderate their temperature. Therefore, the modules are mounted on a metal heatsink which conducts the heat away from the modules. Aluminum heatsinks are often used due to their light weight, low cost and good thermal conductivity.

From the heatsink the heat is transferred to a fluid, either air or a cooling liquid, through convection. The basic relationship for heat transfer by convection is:

$$Q' = h \times A \times (T_a - T_b)$$

where Q' is the heat transferred per unit time, A is the surface area of the object, h is the heat transfer coefficient, T_a is the object's surface temperature and T_b is the fluid temperature.

As can be seen from the above formula, the transferred heat is directly related to the surface area (A) of the object, in this case, the heatsink. Thus, heatsinks are designed to maximize their surface area in contact with the cooling medium surrounding it. The surface area is maximized by adding fins to the heatsink. The fins can also be used to direct the flow of the cooling fluid to maximize the cooling effect.

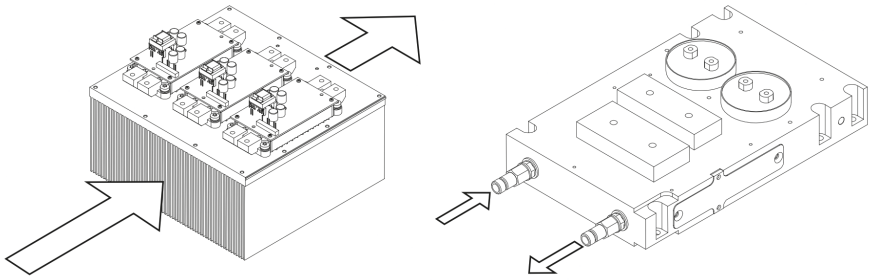

Fig. 10.5 Examples of an Air-Cooled Heatsink and a Liquid-Cooled Heatsink

The cooling fluid has a significant effect on the heat transfer. The convective heat transfer coefficient (h) is dependent upon the type of fluid, flow properties and temperature properties. For example, the heat transfer coefficients for air and water are:

- Air: $h = 10$ to $100 \text{ W/m}^2\text{K}$
- Water: $h = 500$ to $10,000 \text{ W/m}^2\text{K}$

It is clear from the above heat transfer coefficients, that liquid cooling is much more efficient than air cooling. Air cooling solutions are simpler and much cheaper. Therefore, air cooling is more commonly used and liquid cooling is mainly used in more demanding applications, such as high-power applications with space restrictions.

10.5.1 Air-Cooled Drives

Air-cooled AC drives use a fan to circulate the air inside the drive enclosure and remove the heat produced by the drive. Drives usually have a main fan which cools down the heatsink, but sometimes also smaller fans to remove the heat generated from the other components inside the enclosure.

Ventilation and air flow are important both within and outside the drive enclosure. Sufficient free space around the drive needs to be ensured, so that the drive has an adequate source of cooling air and that the outgoing warm air does not mix with the incoming cooling air. This is especially important when more than one drive is installed close to each other. Ducts or air barriers can be used to direct the airflow.

When an AC drive is installed inside a cabinet, the ventilation and cooling of the drive must be considered carefully. The drive as well as the auxiliary components heat up the space they are installed in. In the cabinet sections containing drive modules, the module's own fan is usually enough to provide sufficient cooling air flow within that cabinet section when the openings for air inlet and outlet are designed in accordance with the requirements. In sections that do not contain a drive module, but for example an inductor or an output filter, a door fan or other separate ventilation system is usually needed.

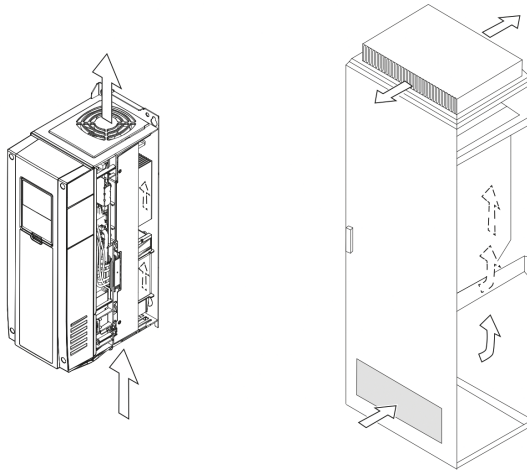

Fig. 10.6 Air Cooling in a Wall-Mounted AC Drive and an Enclosed AC Drive

The load on the air conditioning system of the control room due to the heat losses from AC drives normally results in a relatively high power consumption of the air conditioning system. Also, the electronics inside the drive are quite sensitive to dust and other pollution in the air. If the power consumption of the air conditioning or the poor quality of cooling air are a problem, one option is to use liquid cooling, which is discussed in section 10.5.2 Another option is the unique back-channel cooling feature developed by Danfoss.

The intelligent heat management of the back-channel cooling feature removes up to 90% of the heat losses of the drive. Air from outside the control room is drawn into a vent at the bottom of the drive. The air rises up through a channel at the back of the cabinet to the top where it absorbs heat from the finned heat sink, and the hot air is expelled through a vent at the top of the drive. The back-channel is separated from the electronics area by an IP 54 seal, which results in minimal air passing through the electronics area. This method of cooling greatly reduces contamination of the control electronics area, resulting in longer life and higher reliability.

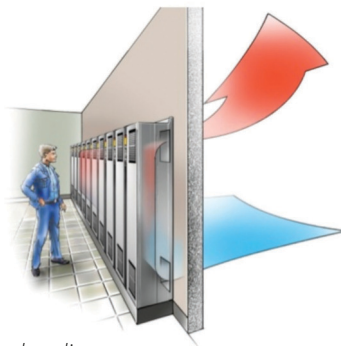

Fig. 10.7 Drives with back-channel cooling

10.5.2 Liquid-Cooled Drives

In liquid-cooled AC drives, the semiconductor modules and DC-link capacitors are installed on a solid heatsink. The heatsink is cooled by a cooling liquid circulating in pipes inside the heatsink. The liquid is usually water or a mixture of water and glycol. Inductors or micro channels are used in the pipes to create a turbulent flow, which can increase the efficiency of the cooling by up to 20%. This method does, however, increase the risk of blockage in the pipes if there are dirt particles in the cooling liquid.

The liquid-cooling systems for AC drives all have a closed cooling circuit (primary circuit), which uses the flowing liquid to transport the heat from the drives to a heat exchanger. The heat exchanger then transports the heat out from the primary circuit. There are three types of heat exchangers used to cool AC drives:

- Liquid-to-liquid heat exchangers are connected to a secondary cooling circuit. The liquid in the secondary circuit transports the heat from the heat exchanger to an external condenser.
- Liquid-to-air heat exchangers have a radiator, which uses air to cool down the cooling liquid in the primary circuit.
- A chiller uses a refrigerant unit to cool down the cooling liquid in the primary circuit.

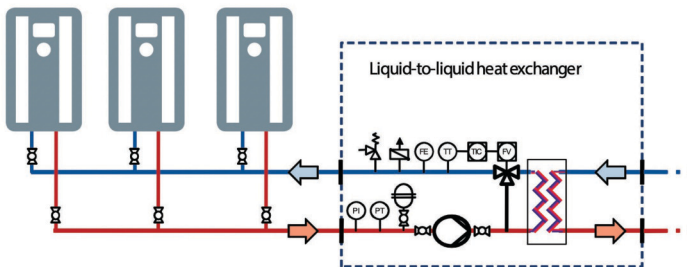

Fig. 10.8 Example of an AC Drive Cooling System with a Liquid-to-Liquid Heat Exchanger

In liquid-cooled drives, most of the excess heat is cooled by the liquid cooling system. However, there are always some heat losses to the air inside the drive as well. The heat losses originate from the busbars, filters, inductors and other auxiliary components. An additional fan or other separate ventilation system might be needed to keep the temperature of the drive within limits. A completely air-tight enclosure is also possible if a radiator (liquid to air heat exchanger) is installed inside the drive enclosure.

With a liquid-cooled drive system, special care must be taken that there is no condensation inside the drive enclosure. As the piping is located inside the drive enclosure, it is vital that the temperature of the cooling liquid stays above the dew-point. The most secure way of preventing condensation is to keep the cooling liquid temperature higher than the ambient temperature inside the drive enclosure.

10.6 Derating of an AC Drive

Maximum ambient temperatures are defined for AC drives, as for all electronic units. If the maximum ambient temperature is exceeded, it could lead to failure of the drive, but it also reduces the life-time of the electronics. According to Arrhenius' law, the life-time of an electronic component is reduced by 50% for each 10°C that it is operated above its specified temperature. If AC drives have to be operated continuously near the maximum rated operating temperature and the specified life-time of the drive still must be maintained, one option is to derate the power. The derating coefficient for the current rating of a drive is typically 1.5%/1°C.

Higher switching frequencies result in less irritating motor noise levels. However, the power dissipation in the inverter increases with the switching frequency, leading to additional heating of the unit. Reducing the switching frequency allows the switching losses to be reduced. If the switching frequency is too low, the motor tends to run less smoothly. The switching frequency is thus always a compromise between noise generation, smooth running, and losses.

If, for example a unit is operated at an ambient temperature of 45°C, it can continuously deliver 100% of its rated output current at a switching frequency of 4 kHz. If the ambient temperature increases to 55°C, a current of only around 75% is possible in continuous operation without a reduction of life-time. If the reduction of life-time is not acceptable, a larger AC drive with sufficient power reserve must be used.

In the diagram 10.9 Power reduction diagram for switching frequency, the switching frequency of the inverter is plotted on the X-axis. The output current (in %) of the unit is plotted on the Y-axis.

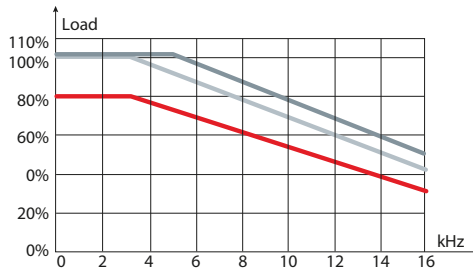

Fig. 10.9 Power reduction diagram for switching frequency

Power derating curves must be observed not only at elevated temperatures, but also at reduced air pressures, such as when AC drives are used at elevations above 1000 meters.

In higher altitudes air is thinner. Thin air has poor thermal capacity, i.e. temperature rise per absorbed energy at fixed volume. When the installation altitude is above 1000 meters, the maximum load current must be decreased by 1% for each 100 m. For example, at the altitude of 2500 m the load current must be limited down to 85% of the rated output current. The installation altitude has no effect on the thermal performance of liquid-cooled AC drives.

10.7 Regenerative Energy

If a motor is driven by an AC drive that during deceleration of the rotor will run faster than the rotating magnetic field causing the motor to act as a generator. Depending on how much energy is fed back from the motor and how often, various measures must be taken. If the power exceeds the total power losses of the motor and the AC drive, the intermediate circuit voltage will increase until, at a defined voltage, the drive disables its output and consequently loses the control of the motor.

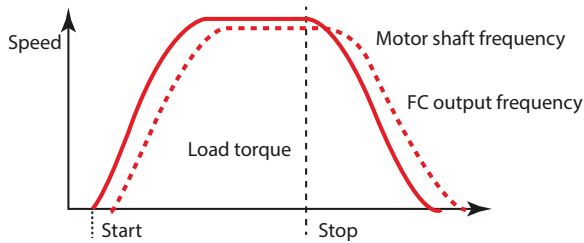

Fig. 10.10 Start/Stop illustrations for regenerative principle

A simple way to avoid such an overvoltage situation is to oversize the AC drive. The higher capacitance of the DC-link would then be able to absorb more regenerative energy and hence reduce the risk of over-voltage. However, this is often a more expensive solution compared to dynamic braking methods, including the possibility of feeding back the energy to the supply grid. For details please refer to the corresponding subsections in chapter 4 Star and Delta Configuration in Field Weakening Operation.

10.8 Motor Cables

The power components of AC drives are designed for specific motor cable lengths. If the specified cable length is exceeded, malfunctions can occur, and the AC drive could trip with an error/alarm message. The capacitance of the cable used is partly responsible for this behavior. If the capacitance at the AC drive output exceeds a specified value, transients can occur on the cables that can lead to a malfunction of the drive.

Most manufacturers prescribe shielded cables for their AC drives to prevent potential EMC problems. If the user decides on other suitable measures for compliance with EMC requirements, then unshielded cables can be used. Since the unshielded cable places a lower capacitive load on the AC drive, a longer cable length is possible in this case. Typically cable lengths that can be used are 50 m / 75 m (shielded) or 150 m / 300 m (unshielded).

Not using shielded motor cables can only be recommended if other measures are taken. Even if an installation operates properly during its acceptance test without shielded motor cables, EMC problems can occur sporadically, or because of modifications or extensions to the installation. The financial expenditure then required to eliminate such problems is usually greater than the money saved by using unshielded cables.

When installing cables, care must be taken to avoid additional inductance resulting from routing cables in the form of an air-core inductor and additional capacitance resulting from parallel conductors.

If several motors are connected in parallel to the output of an AC drive, the allowed lengths of the individual motor cables are considerably shorter. It should be noted that some manufacturers specify geometrical addition of the individual cable lengths. In such cases, daisy-chaining the motor cable is advisable (Fig. 10.11 Daisy-chain connected motors). In a daisy-chain connection, the lengths of the individual motor cables must be added together to determine the connected cable length.

A star formation, on the other hand, can cause problems due to the additional capacitance between the individual conductors.

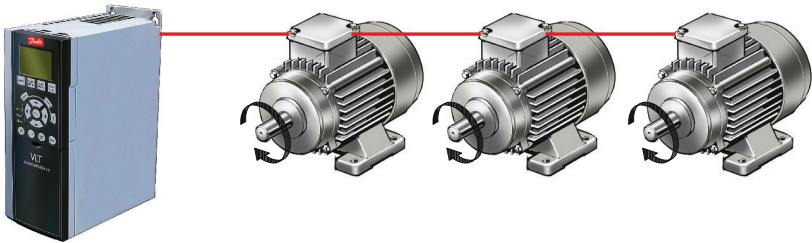

Fig. 10.11 Daisy-chain connected motors

10.9 Environment

Several considerations to the environment should be taken before installing an AC drive. The following factors should be checked:

- Ambient temperature
- Humidity
- Air quality (dust, pollution)
- Altitude
- EMC
- Harmonic distortion
- Vibration

Minimum and maximum ambient temperature limits are specified for all AC drives. Avoiding extreme ambient temperatures prolongs the life of the equipment and maximizes overall system reliability. If the AC drive is installed in an environment where the ambient temperature is higher than specified, derating of the power is needed, see chapter 10.6 Derating of an AC drive. The cooling capability of air is decreased at lower air pressure. Above 1000 m derating of AC drives should be considered.

Electronic equipment is sensitive to the environment. For instance, moisture, dust and temperature can all influence the reliability of electronics. Reduced reliability causes downtime in the application with reduced productivity as a result. Therefore, it is important to choose the right solution for the actual application.

Basically, it is important to protect the electronics from a harsh environment. The best way to do that is to avoid the harsh environment by placing the electronics outside the harsh environment.

In most cases, it cannot be seen directly how critical the environment is. It depends mainly on 4 factors, the concentration of pollutants present, dirt, the relative humidity and temperature. Most AC drive manufacturers offer these solutions to minimize the effect of the environment:

- Mount the AC drives in a central cabinet with long motor cables. In this way the drives are remote from the critical environment
- Install air-conditioning in the control cabinet that ensures critical environment does not contact the AC drives and other electronics (Positive-pressure)
- Some AC drives are fitted with a cold plate. With this solution, the drive can be placed inside a cabinet and via the cold plate the heat is transmitted to the outside. Then the drive's electronics are kept away from the critical environment
- Back-channel cooling is a closed and controlled cooling system, which cools the drive in the cabinet while keeping the drive away from the critical environment
- Use an AC drive which is fitted with a sealed enclosure. AC drive manufacturers today offer an enclosure ingress protection up to IP66/Nema 4X which will protect the electronics from the outside environment and eliminates the cost of a separate enclosure
- Order the AC drive with conformal coating which will significantly improve protection against chlorine, hydrogen sulphide, ammonia and other corrosive environments

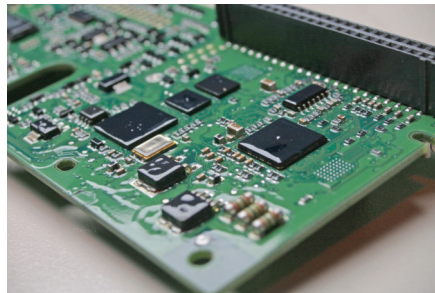

Fig. 10.12 Printed circuit board with conformal coating

EMC and harmonic distortion need to be considered in all AC drive installations. For example, the control signals connected to an AC drive can be quite susceptible to electromagnetic interference, and at the same time, a drive can be a significant source of EMI and harmonic distortion.

The AC drive is used by professionals of the trade as a component forming part of a complex

larger appliance, system, or installation. It must be noted that to maintain the EMC properties of the AC drive, it is the obligation of the installer to follow the installation instructions given by the manufacturer.

For details about EMC and harmonics please refer to chapter 6 Electromagnetic Compatibility and chapter 8 Mains Interference.

10.10 Centralized versus Decentralized Installation

The most common form of installation is beyond doubt centralized installation of AC drives in control cabinets. The advantages of centralized control cabinet technology lie, above all, in the protected installation of the units and centralized access to them for power, control, maintenance, and fault analyses.

With installation in the control cabinet, the primary aspect that must be considered is heat management, not only of the units but also of the whole installation. Because of the heat dissipation in the control cabinet, additional cooling of the control cabinet may be necessary.

Depending on the AC drive manufacturer's mounting regulations, minimum distances must be maintained above and below the unit and between the unit and adjacent components. For better heat removal, direct mounting on the rear wall of the control cabinet is recommended. Some manufacturers also specify minimum distances between the individual units. It is however, preferable to mount the units side-by-side if possible to utilize mounting surface area effectively.

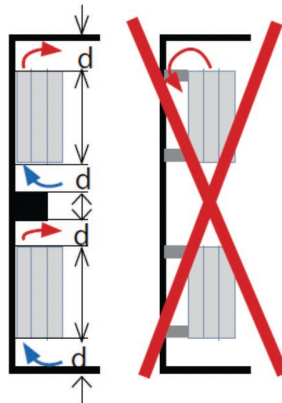

Fig. 10.13 Recommendations for mounting of converters (centralized solution)

A disadvantage of centralized installation in some cases is the long cable lengths to the motors. While the use of shielded cables reduces the RFI effects of the motor cable, these effects are not completely eliminated.

As an alternative to centralized installation, a decentralized approach to the lay-out of a facility can also be chosen. Here the AC drive is located very close to the motor. The drives can be stand-alone cabinets, wall-mounted or even mounted directly on the motor.

Motor cable lengths are thereby reduced to a minimum. In addition, decentralized installation offers advantages in fault detection since the relationship between the controllers and their associated motors is easy to see. In decentralized configurations, a field-bus is usually used to control the drives.

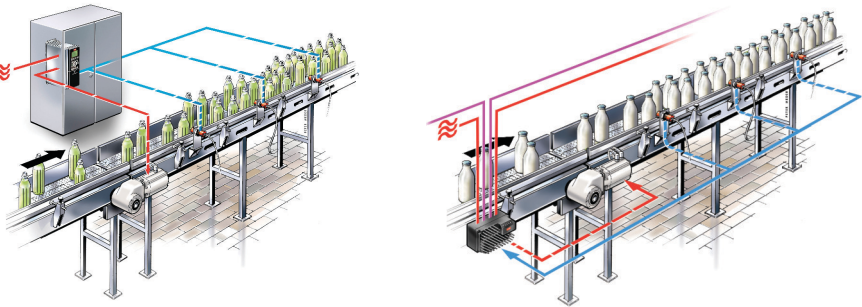

Fig. 10.14 Two concepts – different sets of benefits

When planning a decentralized installation, factors such as ambient temperatures, mains voltage drops, the limited motor cable lengths, etc. must be considered. Important factors such as these are often overlooked in the high-level design of engineering projects.

For example, not only the decentralized units but also the supply cables must be suitable for the installation environment. For instance, the fieldbus cable must be suitable for a harsher environment and sometimes also of the flexible type. In addition, installation of units in inaccessible locations should be avoided to ensure quick access for servicing.

Another major consideration is the subdivision of a decentralized network. For economic reasons it is beneficial to combine units into groups. Careful consideration must be given to determining which groups require other groups for their operation, and which groups can, must, may, or should continue to operate autonomously. For example, if certain chemical processes cannot be interrupted, the failure of a lower-level group must not be allowed to disrupt more important groups.

Finally, the expertise that is necessary for the installation of a decentralized network should not be underestimated. In addition to knowledge of the field-bus systems used, the technician must be aware of the structure (what happens to the total system if an individual unit fails) and the ambient conditions of a decentralized network and must be able to estimate these effects.

Although decentralized units are always more expensive than centralized units, well-conceived decentralization concepts can achieve savings of around 25% compared to centralized systems. The potential for savings in the installation arise from reduced cable lengths and from using equipment modules that have already been built and tested by the machine manufacturer or supplier.

10.11 Examples

The following examples illustrate the basic procedure for selecting an AC drive in the design process. Here the data sheet reproduced below is used for the selection process. The VLT® AutomationDrive FC 302 is selected as an AC drive that can operate with a 150 m shielded cable.

		P11K		P15K		P18K		P22K	
		HO	NO	HO	NO	HO	NO	HO	NO
Output Current									
Continuous (380-440 V)	[A]	24	32	32	37.5	37.5	44	44	61
Intermittent (380-440V)	[A]	38.4	35.2	51.2	41.3	60	48.4	70.4	67.1
Continuous (441-500 V)	[A]	21	27	27	34	34	40	40	52
Intermittent (441-500 V)	[A]	33.6	29.7	43.2	37.4	54.4	44	64	57.2
Output Power									
Continuous (400 V)	[KVA]	16.6	22.2		26		30.5		42.3
Continuous (460 V)	[KVA]	21.5		27.1		31.9		41.4	
Typical shaft output	[kW]	11	15		18.5		22.0		30.0
Max. Input Current									
Continuous (380-440 V)	[A]	22	29		34		40		55
Intermittent (380-440V)	[A]	35.2	31.9	46.4	37.4	54.4	44	64	60.5
Continuous (441-500 V)	[A]	19	25		31		36		47
Intermittent (441-500 V)	[A]	30.4	27.5	40	34.1	49.6	39.6	57.6	51.7
Estimated power loss at rated max. load	[W]	291	392	379	465	444	525	547	739
Efficiency	0.98								
Max. cable size (mm ²)	([AWG ²])	16 (6)				35 (2)			
Max. pre-fuses	[A]	63				80			

Table 10.3 Data for the VLT® AutomationDrive

Example 1

A 15.0 kW, 3 x 400 V motor (4-pole) is installed together with a transport system (a screw conveyor with a break-away torque of approximately 160%). The current consumption of the motor is 30.0 A in continuous operation.

Recommended solution 1

A VLT® AutomationDrive P15K (typical for a 15kW motor with a high constant load torque) can supply 32 A in continuous operation and has sufficient excess load reserve (160 % / 60 s) to enable it to be used in this application.

Example 2

A 15.0 kW, 3 x 400 V motor (4-pole) is installed together with a centrifugal pump (break- away torque of approximately 60 %).

The current consumption of the motor is 30.0 A at its rated speed.

Recommended solution 2

A VLT® AutomationDrive P11K (typical for an 11kW motor with a high constant load torque) can nevertheless supply 32 A with a nominal excess load torque of 110 % / 60 s (max.) and can therefore be used in this application. The unit also has tailored functions for additional energy savings.



Danfoss

ENGINEERING
TOMORROW

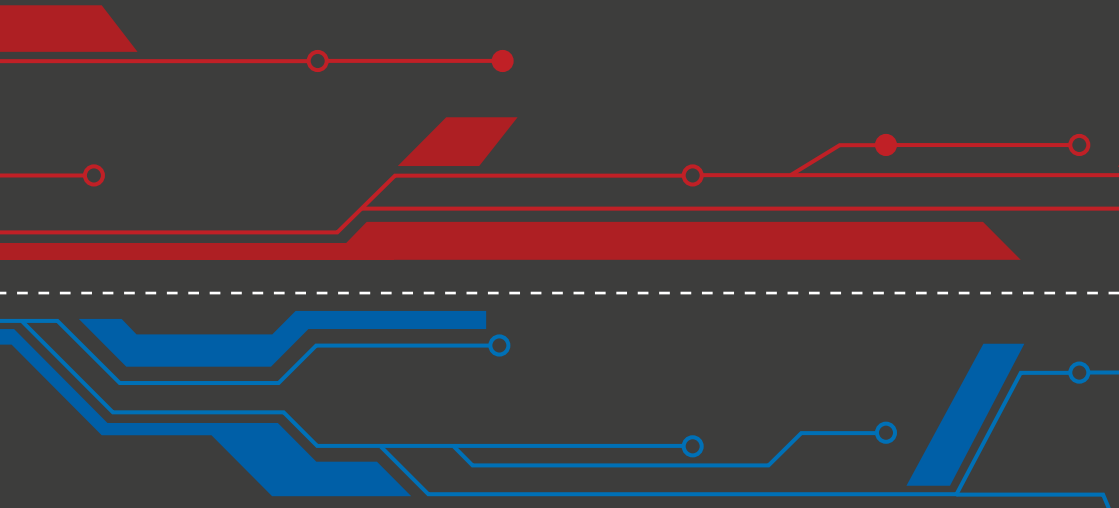

Danfoss can accept no responsibility for possible errors in catalogues, brochures and other printed material. Danfoss reserves the right to alter its products without notice. This also applies to products already on order provided that such alterations can be made without consequential changes being necessary in specifications already agreed. All trademarks in this material are property of the respective companies. Danfoss and the Danfoss logotype are trademarks of Danfoss A/S. All rights reserved.