

VACON[®] 20
AC DRIVES

QUICK GUIDE

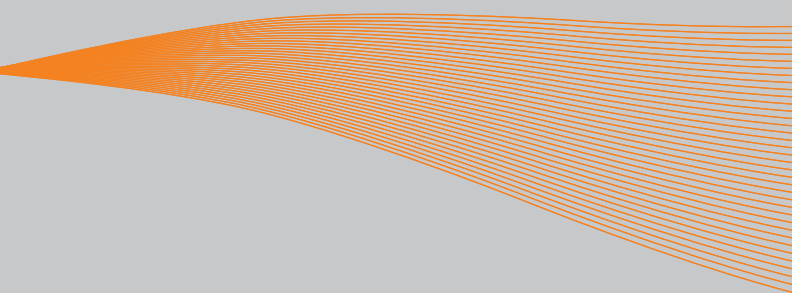

This quick guide includes the steps that will enable you to easily install and setup your Vacon 20 frequency converter.

Before putting your drive into operation, download and read the complete Vacon 20 user manual from

www.vacon.com -> Downloads

1. SAFETY



THE ELECTRICAL INSTALLATION MAY ONLY BE CARRIED OUT BY A COMPETENT ELECTRICIAN!

This quick guide contains clearly marked warnings that are intended for your personal safety and to prevent any unintentional damage to the product or connected appliances.

Please read these warnings carefully:



The components of the frequency converter's power unit are live when Vacon 20 is connected to the mains. Coming into contact with this voltage is extremely dangerous and may cause death or severe injury.



The motor terminals U, V, W (T1, T2, T3) and the optional brake resistor terminals - / + are live when Vacon 20 is connected to the mains even if the motor is not running.



The control I/O terminals are isolated from the mains potential. However, the relay output terminals may have a dangerous control voltage even when Vacon 20 is disconnected from the mains.



The earth leakage current of Vacon 20 frequency converters exceeds 3.5 mA AC. A reinforced protective ground connection must be available in accordance with standard EN61800-5-1. **See Chapter 7!**



If the frequency converter is used as part of a machine, the machine manufacturer is responsible for providing the machine with a main switch (EN 60204-1).



If Vacon 20 is disconnected from the mains while the motor is running, Vacon 20 will remain live if the motor is fed by the process. In this case, the motor functions as a generator that feeds energy to the frequency converter.



After disconnecting the frequency converter from the mains, wait until the fan stops and the display segments or status LEDs on the front panel switch off. Wait 5 more minutes before doing any work on Vacon 20 connections.



The motor can start automatically after a fault if the autoreset function is active.

NOTE! English and French product manuals with applicable information on safety, warnings, and cautions can be downloaded from www.vacon.com/downloads.

REMARQUE Vous pouvez télécharger les versions anglaise et française des manuels produit contenant l'ensemble des informations de sécurité, avertissements et mises en garde applicables sur le site www.vacon.com/downloads.

2. INSTALLATION

2.1 Mechanical installation

There are two possible ways to mount Vacon 20 on the wall. For MI1 - MI3, either screw or DIN rail mounting; for MI4 - MI5, either screw or flange mounting.

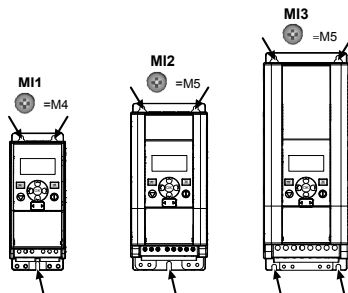

Figure 1: Screw mounting, MI1 - MI3

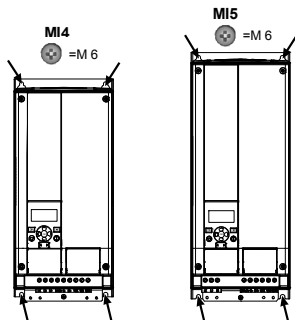

Figure 2: Screw mounting, MI4 - MI5

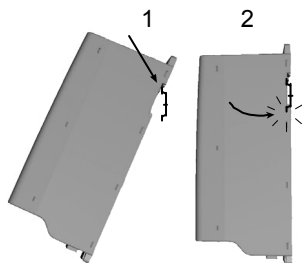

Figure 3: DIN rail mounting, MI1 - MI3

Note! See the mounting dimensions on the back of the drive. Leave **free space** for cooling above (**100 mm**), below (**50 mm**), and on the sides (**20 mm**) of Vacon 20! (For MI1 - MI3, side-by-side installation is only allowed if the ambient temperature is below 40°C; for MI4 - MI5, side-by-side installation is not allowed.)

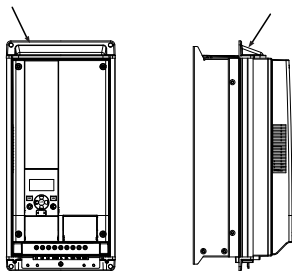

Figure 4: flange mounting, MI4 - MI5

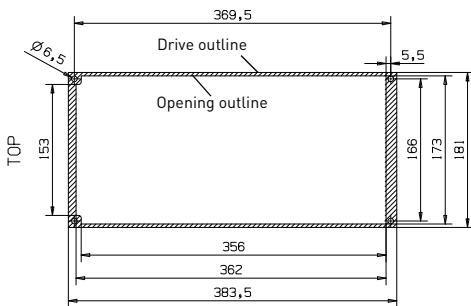

Figure 5: Flange mounting cutout dimensions for MI4 (unit of measure: mm)

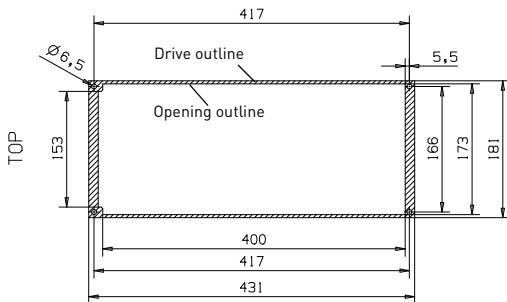

Figure 6: Flange mounting cutout dimensions for MI5 (unit of measure: mm)

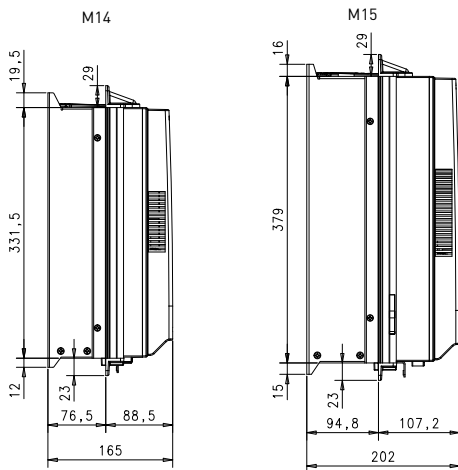

Figure 7: Flange mounting depth dimensions for M14 and M15
(unit of measure: mm)

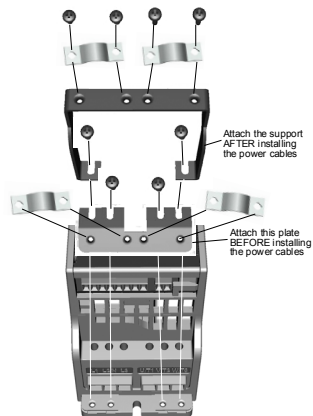

Figure 8: Attaching the PE plate and API cable support, MI1 - MI3

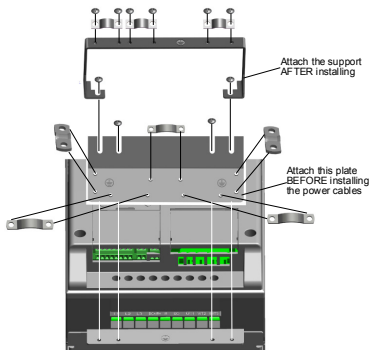

Figure 9: Attaching the PE plate and API cable support, MI4 - MI5

2.2 Cabling and connections

2.2.1 Power cabling

Note: The tightening torque for power cables is 0.5 - 0.6 Nm [4-5 In-Lbs].

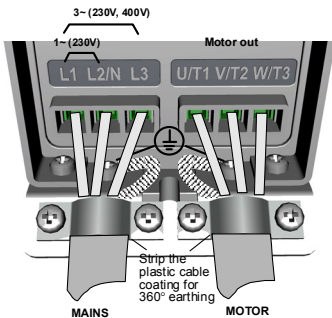

Figure 10: Vacon 20 power connections, MI1

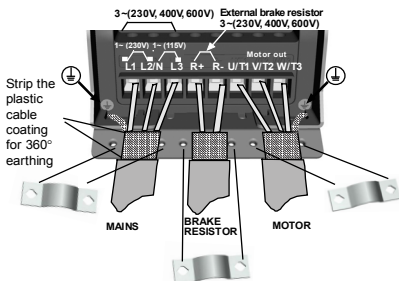

Figure 11: Vacon 20 power connections, MI2 - MI3

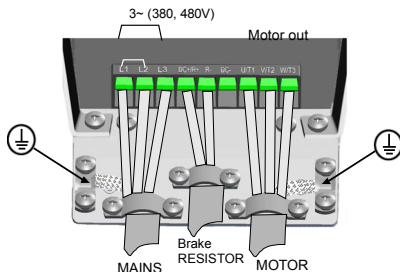

Figure 12: Vacon 20 power connections, MI4

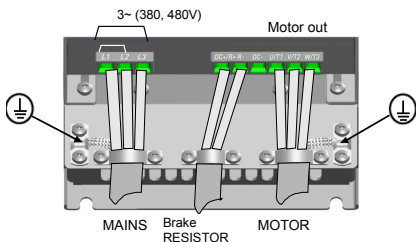

Figure 13: Vacon 20 power connections, MI5

2.2.2 Control cabling



Figure 14: Open the lid (MI1 - MI3)

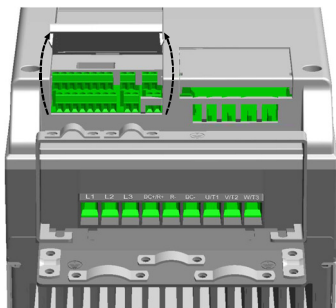

Figure 15: Open the lid (MI4 - MI5)

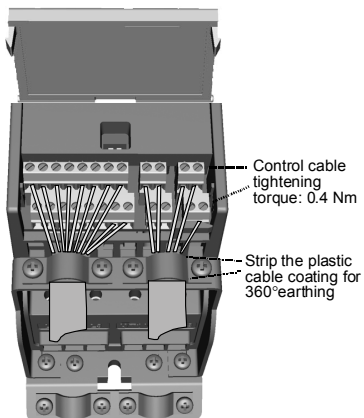

Figure 16: Install the control cables (MI1 - MI3)

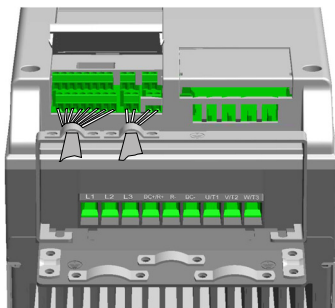

Figure 17: Install the control cables (MI4 - MI5)

2.2.3 Allowed option boards in Vacon20

See below for the allowed option board slots:

SLOT	EC	E3	E5	E6	E7	B1	B2	B4	B5	B9	BH	BF
------	----	----	----	----	----	----	----	----	----	----	----	----

Note! When OPT-B1 / OPT-B4 used in Vacon20, +24VDC ($\pm 10\%$, min.300mA) power should be supplied to Terminal 6 (+24_out) and Terminal 3 (GND) in control panel.

Option boards (all boards are varnished)	
OPT-EC-V	EtherCat
OPT-E3-V	Profibus DPV1 [Screw connector]
OPT-E5-V	Profibus DPV1 [D9 connector]
OPT-E6-V	CANopen
OPT-E7-V	DeviceNet
OPT-B1-V	6 x DI/DO, each I/O can be individually
OPT-B2-V	2 x Relay output + Thermistor
OPT-B4-V	1 x AI, 2 x AO [isolated]
OPT-B5-V	3 x Relay output
OPT-B9-V	1 x RO, 5 x DI (42-240 VAC)
OPT-BH-V	3 x Temperature measurement (support for PT100, PT1000, NI1000, KTY84-130, KTY84-150, KTY84-131 sensors)
OPT-BF-V	1 x AO, 1 x DO, 1 x RO

Option board assembly structure:

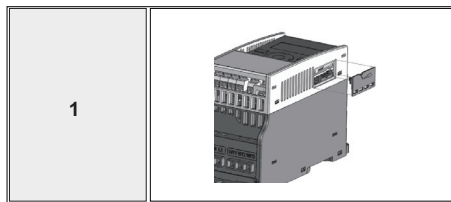

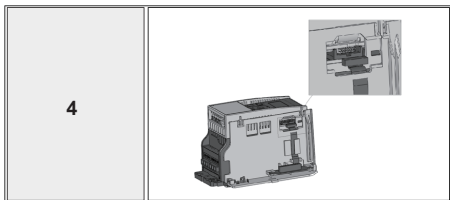
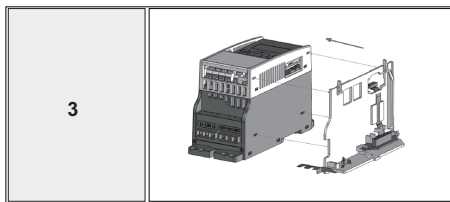
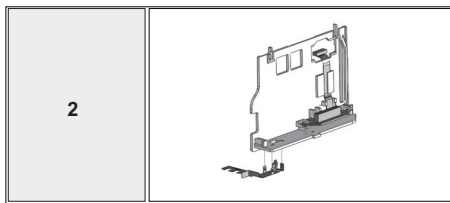

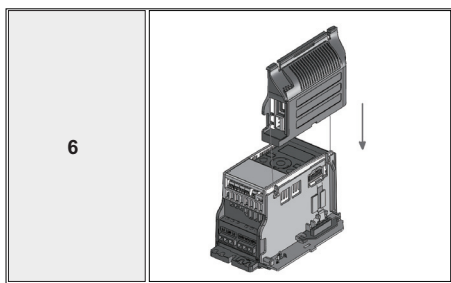
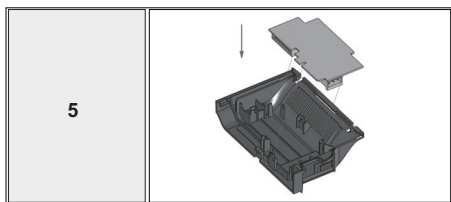

3. CONTROL I/O AND TERMINALS

Vacon 20

Terminal	Signal	Factory preset	Description
1	+10 Vref		Ref voltage out
2	AI1	Freq reference ^{P1}	Maximum load 10 mA
3	GND		I/O signal ground
6	24 Vout		24 V output for DIs
7	DI_C		Digital Input Common
8	DI1	Start forward ^{P1}	Digital Input for DI1 - DI6, refer to Table 2 for DI sink type
9	DI2	Start reverse ^{P1}	Positive, Logic1: 18...30V, Logic0: 0...5V; Negative, Logic1: 0...10V, Logic0: 18...30V; Ri = 10KΩ (floating)
10	DI3	Fault reset ^{P1}	
A	A	RS485 signal A	FB Communication
B	B	RS485 signal B	FB Communication
4	AI2	PID actual value and Freq reference ^{P1}	Negative
5	GND		Default: 0(4) - 20 mA, Ri ≤ 250 Ω Other: 0 - 10 V, Ri = 250 kΩ Selectable through microswitch
13	DO-		Digital Output Common
14	DI4	Preset speed B0 ^{P1}	Digital Output Common
15	DI5	Preset speed B1 ^{P1}	Digital input 4
16	DI6	External fault ^{P1}	Digital input 5
18	AO	Output frequency ^{P1}	Digital input 6
20	DO	Active = READY ^{P1}	As DI1, Other: Encoder Input A (frequency up to 10 kHz) Selectable through microswitch
22	R01 NO		0 - 10 V, RL ≥ 1 kΩ 0(4) - 20 mA, RL ≤ 500 Ω Selectable through microswitch
23	R01 CM		Open collector, max load 35 V / 50 mA
24	R02 NC		Active = RUN ^{P1}
25	R02 CM		Switching load: 250 Vac / 3 A, 24V DC 3A
26	R02 NO		Active = FAULT ^{P1}
			Switching load: 250 Vac / 3 A, 24V DC 3A

Table 1: Vacon 20 general purpose application default I/O configuration and connections for control board

^{P1}) = Programmable function, see User Manual: parameter lists and descriptions for detail

Terminal	Signal	Factory preset	Description
3	GND	I/O signal ground	
6	24 Vout	24 V output for DI's	±20 %, max load 50 mA
7	DI_C	Digital Input Common	Digital Input Common for DI1-DI6
8	DI1	Digital input 1	Start forward ^{PI} Positive, Logic1:18...30V, Logic0: 0...5V; Negative, Logic1:0...10V, Logic0: 18...30V; Ri = 10KΩ (floating)
9	DI2	Digital input 2	Start reverse ^{PI}
10	DI3	Digital input 3	Fault reset ^{PI}
14	DI4	Digital input 4	Preset speed B0 ^{PI} Positive, Logic1:18...30V, Logic0: 0...5V; Negative, Logic1:0...10V, Logic0: 18...30V; Ri = 10KΩ (floating)
15	DI5	Digital input 5	Preset speed B1 ^{PI} Only for DI.
16	DI6	Digital input 6	External fault ^{PI} Only for DI.

Table 2: DI Sink Type, remove jumper J500 and connect the wire using table 2

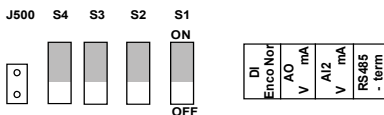
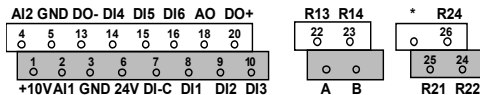

Figure 18: Microswitches

Vacon 20 I/O terminals:



4. NAVIGATION AND STARTUP

4.1 The main menus of Vacon 20

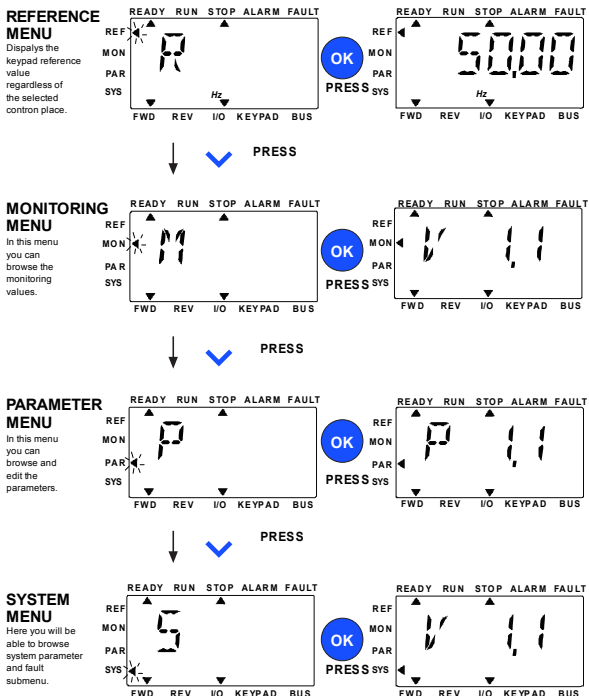

Figure 19: The main menu of Vacon 20

4.2 Putting into operation and startup wizard

4.2.1 Steps to put the drive into operation:

1. Read the safety instructions on page 1	7. Perform the test run without the motor ; see the User Manual at www.vacon.com
2. Secure the grounding and check that cables comply with requirements	8. Run no-load tests without the motor connected to the process
3. Check the quality and quantity of the cooling air	9. Perform an identification run [Par. ID631]
4. Check that all start/stop switches are in the STOP position	10. Connect the motor to the process and perform the test run again
5. Connect the drive to the mains	11. Vacon 20 is now ready for use
6. Run the startup wizard and set all necessary parameters	

Table 1: Steps to put the drive into operation

4.2.2 Startup wizard

Vacon 20 runs the startup wizard when the machine is powered up for the first time. The wizard is run by setting SYS Par.4.2 =1. The following figures show the procedure.

NOTE: Running the startup wizard always returns all parameters to their factory default settings.

NOTE! StartUp-Wizard can be skipped after pressing the STOP button continuously for 30 seconds

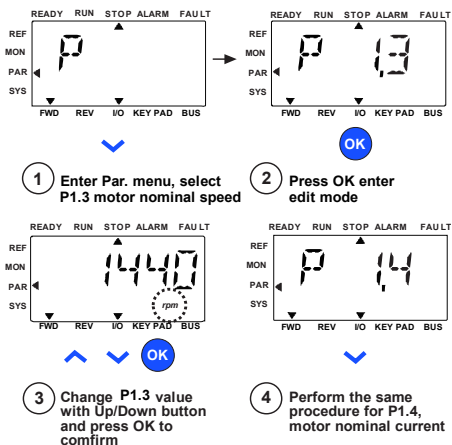
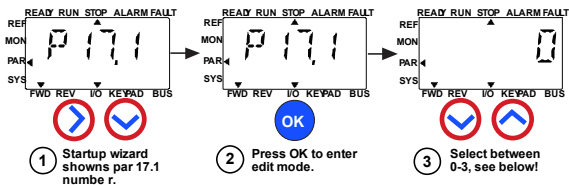

Figure 20: Vacon 20 startup wizard (standard application)



Selections:

	P1.7	P1.8	P1.15	P2.2	P2.3	P3.1	P4.2	P4.3
0 = Basic	1.5 x INMOT	0= Frequency control	0= Not used	0= Ramp	0= Coast	0 Hz	3s	3s
1 = Pump drive	1.1 x INMOT	0= Frequency control	0= Not used	0= Ramp	1= Ramp	20 Hz	5s	5s
2 = Fan drive	1.1 x INMOT	0= Frequency control	0= Not used	1= Flying	0= Coast	20 Hz	20s	20s
3 = High Torque drive	1.5 x INMOT	1=Open loop speed control	1= used	0= Ramp	0= Coast	0 Hz	1s	1s

Parameters affected:

P1.7	Current limit (A)	P2.3	Stop function
P1.8	Motor control mode	P3.1	Min frequency
P1.15	Torque boost	P4.2	Acc. time (s)
P2.2	Start function	P4.3	Dec time (s)

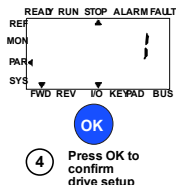

Figure 21: Drive setup

5. MONITORING AND PARAMETERS

NOTE! This guide is for the standard application of Vacon 20. If you need detailed parameter descriptions, please download the user manual from www.vacon.com -> Support & downloads.

5.1 Monitoring values

Code	Monitoring signal	Unit	ID	Description
V1.1	Output frequency	Hz	1	Output frequency to motor
V1.2	Frequency reference	Hz	25	Frequency reference to motor control
V1.3	Motor speed	rpm	2	Calculated motor speed
V1.4	Motor current	A	3	Measured motor current
V1.5	Motor torque	%	4	Calculated actual/nominal motor torque
V1.6	Motor shaft power	%	5	Calculated actual/nominal motor power
V1.7	Motor voltage	V	6	Motor voltage
V1.8	DC link voltage	V	7	Measured DC link voltage
V1.9	Unit temperature	°C	8	Heatsink temperature
V1.10	Motor temperature	%	9	Calculated motor temperature
V1.11	Output power	KW	79	Output power from drive to motor
V2.1	Analog input 1	%	59	AI1 signal range as percent of used range
V2.2	Analog input 2	%	60	AI2 signal range as percent of used range
V2.3	Analog output	%	81	AO signal range as percent of used range
V2.4	Digital input status DI1, DI2, DI3		15	Digital input status
V2.5	Digital input status DI4, DI5, DI6		16	Digital input status
V2.6	RO1, RO2, DO		17	Relay/digital output status
V2.7	Pulse train/encoder input	%	1234	0 - 100% scale value
V2.8	Encoder rpm	rpm	1235	Scaled according to encoder pulses/revolution parameter

Table 1: Monitoring values

Code	Monitoring signal	Unit	ID	Description
V2.11	Analog input E1	%	61	Analog input signal 1 in % from option board; hidden until an option board is connected
V2.12	Analog output E1	%	31	Analog output signal 1 in % from option board; hidden until an option board is connected
V2.13	Analog output E2	%	32	Analog output signal 2 in % from option board; hidden until an option board is connected
V2.14	DIE1, DIE2, DIE3		33	This monitor value shows the status of the digital inputs 1-3 from the option board; hidden until an option board is connected
V2.15	DIE4, DIE5, DIE6		34	This monitor value shows the status of the digital inputs 4-6 from the option board; hidden until an option board is connected
V2.16	DOE1,DOE2,DOE3		35	This monitor value shows the status of the relay outputs 1-3 from the option board; hidden until an option board is connected
V2.17	DOE4,DOE5,DOE6		36	This monitor value shows the status of the relay outputs 4-6 from the option board; hidden until an option board is connected
V2.18	Temperature input 1		50	Measured value of Temperature input 1 in temperature unit (Celsius or Kelvin) by parameter setting, hidden until an option board is connected
V2.19	Temperature input 2		51	Measured value of Temperature input 2 in temperature unit (Celsius or Kelvin) by parameter setting, hidden until an option board is connected
V2.20	Temperature input 3		52	Measured value of Temperature input 3 in temperature unit (Celsius or Kelvin) by parameter setting, hidden until an option board is connected

Table 1: Monitoring values

Code	Monitoring signal	Unit	ID	Description
V3.1	Drive status word		43	Bit-code status of drive B0 = Ready B1 = Run B2 = Reverse B3 = Fault B6 = RunEnable B7 = AlarmActive B12 = RunRequest B13 = MotorRegulatorActive
V3.2	Application status word		89	Bit-code status of application: B3 = Ramp 2 Active B5 = Remote CTRL Place 1 active B6 = Remote CTRL Place 2 active B7 = Fieldbus Control Active B8 = Local Control Active B9 = PC Control Active B10 = Preset Frequencies Active
V3.3	DIN status word		56	B0 = DI1 B1 = DI2 B2 = DI3 B3 = DI4 B4 = DI5 B5 = DI6 B6 = DIE1 B7 = DIE2 B8 = DIE3 B9 = DIE4 B10 = DIE5 B11 = DIE6
V4.1	PID set point	%	20	Regulator setpoint
V4.2	PID feedback value	%	21	Regulator actual value
V4.3	PID error	%	22	Regulator error
V4.4	PID output	%	23	Regulator output
V4.5	Process		29	Scaled process variable see par. 15.18

Table 1: Monitoring values

5.2 Quick setup parameters (virtual menu; displays when par. 17.2 = 1)

Code	Parameter	Min	Max	Unit	Default	ID	Note
P1.1	Motor nominal voltage	180	690	V	Varies	110	Check rating plate on motor.
P1.2	Motor nominal frequency	30.00	320.00	Hz	50.00 / 60.00	111	Check rating plate on motor.
P1.3	Motor nominal speed	30	20000	rpm	1440 / 1720	112	Default applies to 4-pole motor.
P1.4	Motor nominal current	0.2 x I _{Nunit}	2.0 x I _{Nunit}	A	I _{Nunit}	113	Check rating plate on motor.
P1.5	Motor cos ϕ	0.30	1.00		0.85	120	Check rating plate on motor.
P1.7	Current limit	0.2 x I _{Nunit}	2.0 x I _{Nunit}	A	1.5 x I _{Nunit}	107	Maximum motor current
P1.15	Torque boost	0	1		0	109	0 = Not used 1 = Used
P2.1	Remote control place 1 selection	0	2		0	172	0 = I/O terminal 1 = Fieldbus 2 = Keypad
P2.2	Start function	0	1		0	505	0 = Ramp 1 = Flying start
P2.3	Stop function	0	1		0	506	0 = Coasting 1 = Ramp
P3.1	Min frequency	0.00	P3.2	Hz	0.00	101	Minimum frequency reference
P3.2	Max frequency	P3.1	320.00	Hz	50.00 / 60.00	102	Maximum frequency reference
P3.3	Remote Control Place 1 frequency reference selection	1	Varies		7	117	1 = Preset speed 0 2 = Keypad 3 = Fieldbus 4 = AI1 5 = AI2 6 = PID 7 = AI1 + AI2 8 = Motor potentiometer 9 = Pulse train/Encoder 10 = AIE1 11 = Temperature input 1 12 = Temperature input 2 13 = Temperature input 3 Note: Pay attention to DI/Encoder switch position when set with 9=Pulse train / Encoder

Table 2: Quick setup parameters

Code	Parameter	Min	Max	Unit	Default	ID	Note
P3.4	Preset speed 0	P3.1	P3.2	Hz	5.00	180	Preset speed 0 is used as frequency reference when P3.3 = 1
P3.5	Preset speed 1	P3.1	P3.2	Hz	10.00	105	Activated by digital inputs
P3.6	Preset speed 2	P3.1	P3.2	Hz	15.00	106	Activated by digital inputs
P3.7	Preset speed 3	P3.1	P3.2	Hz	20.00	126	Activated by digital inputs
P4.2	Acceleration time 1	0.1	3000.0	s	3.0	103	Acceleration time from 0 Hz to maximum frequency.
P4.3	Deceleration time 1	0.1	3000.0	s	3.0	104	Deceleration time from maximum frequency to 0 Hz.
P6.1	AI1 Signal range	0	1		0	379	0 = 0 - 100% 1 = 20% - 100% 20% is the same as 2 V minimum signal level.
P6.5	AI2 Signal range	0	1		0	390	0 = 0 - 100% 1 = 20% - 100% 20% is the same as 2 V or 4 mA minimum signal level.
P14.1	Automatic reset	0	1		0	731	0 = Disable 1 = Enable
P17.2	Parameter conceal	0	1		1	115	0 = All parameters visible 1 = Only quick setup parameter group visible

Table 2: Quick setup parameters

5.3 Motor settings (Control panel: Menu PAR -> P1)

Code	Parameter	Min	Max	Unit	Default	ID	Note
P1.1	Motor nominal voltage	180	690	V	Varies	110	Check rating plate on motor
P1.2	Motor nominal frequency	30.0 0	320.0 0	Hz	50.00 / 60.00	111	Check rating plate on motor
P1.3	Motor nominal speed	30	20000	rpm	1440 / 1720	112	Default applies to 4-pole motor.
P1.4	Motor nominal current	0.2 x I_{Nunit}	2.0 x I_{Nunit}	A	I_{Nunit}	113	Check rating plate on motor
P1.5	Motor cos φ (Power Factor)	0.30	1.00		0.85	120	Check rating plate on motor
P1.6	Motor type	0	1		0	650	0 = Induction 1 = Permanent magnet
P1.7	Current limit	0.2 x I_{Nunit}	2.0 x I_{Nunit}	A	1.5 x I_{Nunit}	107	Maximum motor current
P1.8	Motor control mode	0	1		0	600	0 = Frequency control 1 = Open loop speed control
P1.9	U/f ratio	0	2		0	108	0 = Linear 1 = Square 2 = Programmable
P1.10	Field weakening point	8.00	320.0 0	Hz	50.00 / 60.00	602	Field weakening point frequency
P1.11	Field weakening point voltage	10.0 0	200.0 0	%	100.00	603	Voltage at field weakening point as % of U_{nmot}
P1.12	U/f midpoint frequency	0.00	P1.10	Hz	50.00 / 60.00	604	Midpoint frequency for programmable U/f
P1.13	U/f midpoint voltage	0.00	P1.11	%	100.00	605	Midpoint voltage for programmable U/f as % of U_{nmot}
P1.14	Zero freq. voltage	0.00	40.00	%	Varies	606	Voltage at 0 Hz as % of U_{nmot}
P1.15	Torque Boost	0	1		0	109	0 = Disabled 1 = Enabled
P1.16	Switching frequency	1.5	16.0	kHz	4.0/2.0	601	PWM frequency. If values are higher than default, reduce current capacity

Table 3: Motor settings

Code	Parameter	Min	Max	Unit	Default	ID	Note
P1.17	Brake Chopper	0	2		0	504	0 = Disabled 1 = Enabled: Always 2 = Run state
P1.18	Brake chopper level	0	911	V	Varies	1267	Brake chopper control activation level in volt. For 240 V supply: $240 * 1.35 * 1.18 = 382$ V For 400V supply: $400 * 1.35 * 1.18 = 638$ V Please note that when the brake chopper is used the overvoltage controller can be switched off or the overvoltage reference level can be set higher than the brake chopper level.
P1.19	Motor identification	0	2		0	631	0 = Not active 1 = Standstill identification (need run command within 20 s to activate) 2 = Identification with run (need run command within 20 s to activate). Only available in power SW V026 included in FW01070V010 or later version)
P1.20	Rs voltage drop	0.00	100.00	%	0.00	662	Voltage drop over motor windings as % of U_{nmot} at nominal current.
P1.21	Overvoltage controller	0	2		1	607	0 = Disabled 1 = Enabled, Standard mode 2 = Enabled, Shock load mode
P1.22	Undervoltage controller	0	1		1	608	0 = Disable 1 = Enable
P1.23	Sine filter	0	1		0	522	0 = Not in use 1 = In use

Table 3: Motor settings

Code	Parameter	Min	Max	Unit	Default	ID	Note
P1.24	Modulator type	0	65535		28928	648	Modulator configuration word: B1 = Discontinuous modulation (DPWMMIN) B2 = Pulse dropping in overmodulation B6 = Under modulation B8 = Instantaneous DC voltage compensation * B11 = Low noise B12 = Dead time compensation * B13 = Flux error compensation * * Enabled by default
P1.25	Efficiency optimization*	0	1		0	666	Energy optimization, the frequency converter searches for the minimum current in order to save energy and lower motor noise 0 = disabled 1 = enable
P1.26	I/f start enable*	0	1		0	534	0 = disabled 1 = enable
P1.27	I/f start frequency reference limit*	1	100	%	10	535	Output frequency limit below which the defined I/f start current is fed to the motor.
P1.28	I/f start current reference*	0	100.0	%	80.0	536	Current reference in percent of motor nominal current [1 = 0.1%]
P1.29	Voltage limiter enable*	0	1		1	1079	Select voltage limiter mode: 0 = Disabled 1 = Enabled

Table 3: Motor settings

NOTE:

* These parameters are only available in power SW FWP00001V026 included in FW01070V010 or later version.

NOTE: These parameters display when P17.2 = 0.

5.4 Start/stop setup (Control panel: Menu PAR -> P2)

Code	Parameter	Min	Max	Unit	Default	ID	Note
P2.1	Remote Control Place Selection	0	2		0	172	0 = I/O terminals 1 = Fieldbus 2 = Keypad
P2.2	Start function	0	1		0	505	0 = Ramp 1 = Flying start
P2.3	Stop function	0	1		0	506	0 = Coasting 1 = Ramp
P2.4	I/O Start/Stop logic	0	4		2	300	I / O control signal 1 I / O control signal 2 0 Forward Reverse 1 Fwd(edge) Inverted Stop 2 Fwd(edge) Rev(edge) 3 Start Reverse
P2.5	Local / Remote	0	1		0	211	0 = Remote control 1 = Local control
P2.6	Keypad control direction	0	1		0	123	0 = Forward 1 = Reverse
P2.7	Keypad stop button	0	1		1	114	0 = Keypad control only 1 = Always
P2.8	Remote Control Place 2 Selection	0	2		0	173	0 = I/O terminals 1 = Fieldbus 2 = Keypad
P2.9	keypad button lock	0	1		0	15520	0 = Unlock all keypad button 1 = Loc/Rem button locked

Table 4: Start/stop setup

5.5 Frequency references (Control panel: Menu PAR -> P3)

Code	Parameter	Min	Max	Unit	Default	ID	Note
P3.1	Min frequency	0.00	P3.2	Hz	0.00	101	Minimum allowed frequency reference
P3.2	Max frequency	P3.1	320.00	Hz	50.00 / 60.00	102	Maximum allowed frequency reference
P3.3	Remote Control Place 1 frequency reference selection	1	Varies		7	117	1 = Preset speed 0 2 = Keypad 3 = Fieldbus 4 = AI1 5 = AI2 6 = PID 7 = AI1 + AI2 8 = Motor potentiometer 9 = Pulse train/Encoder 10 = AIE1 11 = Temperature input 1 12 = Temperature input 2 13 = Temperature input 3 Note: Pay attention to DI/Encoder switch position when set with 9=Pulse train / Encoder
P3.4	Preset speed 0	P3.1	P3.2	Hz	5.00	180	Preset speed 0 is used as frequency reference when P3.3 = 1
P3.5	Preset speed 1	P3.1	P3.2	Hz	10.00	105	Activated by digital inputs
P3.6	Preset speed 2	P3.1	P3.2	Hz	15.00	106	Activated by digital inputs
P3.7	Preset speed 3	P3.1	P3.2	Hz	20.00	126	Activated by digital inputs
P3.8	Preset speed 4	P3.1	P3.2	Hz	25.00	127	Activated by digital inputs
P3.9	Preset speed 5	P3.1	P3.2	Hz	30.00	128	Activated by digital inputs
P3.10	Preset speed 6	P3.1	P3.2	Hz	40.00	129	Activated by digital inputs
P3.11	Preset speed 7	P3.1	P3.2	Hz	50.00	130	Activated by digital inputs
P3.12	Remote Control Place 2 frequency reference selection	1	Varies		5	131	See P3.3
P3.13	Motor Potentiometer Ramp	1	50	Hz/s	5	331	Speed variation rate
P3.14	Motor Potentiometer Reset	0	2		2	367	0 = No Reset 1 = Reset if stopped 2 = Reset if powered down

Table 5: Frequency references

NOTE: These parameters display when P17.2 = 0.

5.6 Ramp and brake setup (Control panel: Menu PAR -> P4)

Code	Parameter	Min	Max	Unit	Default	ID	Note
P4.1	Ramp S-shape 1	0.0	10.0	s	0.0	500	0 = Linear >0 = S-curve ramp time
P4.2	Acceleration time 1	0.1	3000.0	s	3.0	103	Defines the time required for the output frequency to increase from zero frequency to maximum frequency.
P4.3	Deceleration time 1	0.1	3000.0	s	3.0	104	Defines the time required for the output frequency to decrease from maximum frequency to zero frequency.
P4.4	Ramp S-shape 2	0.0	10.0	s	0.0	501	See P4.1
P4.5	Acceleration time 2	0.1	3000.0	s	10.0	502	See P4.2
P4.6	Deceleration time 2	0.1	3000.0	s	10.0	503	See P4.3
P4.7	Flux Braking	0	3		0	520	0 = Off 1 = Deceleration 2 = Chopper 3 = Full Mode
P4.8	Flux Braking Current	0.5 x I_{Nunit}	2.0 x I_{Nunit}	A	I_{Nunit}	519	Defines the current level for flux braking.
P4.9	DC Braking Current	0.3 x I_{Nunit}	2.0 x I_{Nunit}	A	I_{Nunit}	507	Defines the current injected into the motor during DC braking.
P4.10	Stop DC current time	0.00	600.00	s	0.00	508	Determines if braking is ON or OFF and the braking time of the DC-brake when the motor is stopping. 0.00 = Not active
P4.11	Stop DC current frequency	0.10	10.00	Hz	1.50	515	The output frequency at which DC-braking is applied.
P4.12	Start DC current time	0.00	600.00	s	0.00	516	0.00 = Not active

Table 6: Ramp and brake setup

Code	Parameter	Min	Max	Unit	Default	ID	Note
P4.13	Accel2 Frequency Threshold	0.00	P3.2	Hz	0.00	527	0.00 = disabled
P4.14	Decel2 Frequency Threshold	0.00	P3.2	Hz	0.00	528	0.00 = disabled
P4.15	External Brake: Open Delay	0.00	320.00	s	0.20	1544	Delay to open brake after Open frequency limit is reached.
P4.16	External Brake: Open Frequency limit	0.00	P3.2	Hz	1.50	1535	Open frequency from forward and reverse direction.
P4.17	External Brake: Close Frequency limit	0.00	P3.2	Hz	1.00	1539	Close frequency from positive direction if no run command active.
P4.18	External Brake: Close Frequency limit in reverse	0.00	P3.2	Hz	1.50	1540	Close frequency from negative direction if no run command active.
P4.19	External Brake: Open/Close Current limit	0.0	200.0	%	20.0	1585	The brake does not open if the current does not exceed this value, and closes immediately if current falls below this value This parameter is set as a percentage of Motor nominal current.

Table 6: Ramp and brake setup

5.7 Digital inputs (Control panel: Menu PAR -> P5)

Code	Parameter	Min	Max	Unit	Default	ID	Note
P5.1	I/O control signal 1	0	Varies		1	403	0 = Not used 1 = DI1 2 = DI2 3 = DI3 4 = DI4 5 = DI5 6 = DI6 7 = DIE1 8 = DIE2 9 = DIE3 10 = DIE4 11 = DIE5 12 = DIE6
P5.2	I/O control signal 2	0	Varies		2	404	See 5.1
P5.3	Reverse	0	Varies		0	412	See 5.1
P5.4	Ext. fault Close	0	Varies		6	405	See 5.1
P5.5	Ext. fault Open	0	Varies		0	406	See 5.1
P5.6	Fault reset	0	Varies		3	414	See 5.1
P5.7	Run enable	0	Varies		0	407	See 5.1
P5.8	Preset speed B0	0	Varies		4	419	See 5.1
P5.9	Preset speed B1	0	Varies		5	420	See 5.1
P5.10	Preset speed B2	0	Varies		0	421	See 5.1
P5.11	Ramp time 2 selection	0	Varies		0	408	See 5.1
P5.12	Motor potentiometer up	0	Varies		0	418	See 5.1
P5.13	Motor potentiometer down	0	Varies		0	417	See 5.1
P5.14	Remote control place 2	0	Varies		0	425	Activates control place 2 See 5.1
P5.15	Remote control place freq reference 2	0	Varies		0	343	Activates control place 2 See P5.1
P5.16	PID setpoint 2	0	Varies		0	1047	Activates reference 2 See 5.1
P5.17	Motor Preheat Active	0	Varies		0	1044	Activates the Motor Preheat [DC-Current] in stop state when the parameter Motor Preheat function is set at 2 See 5.1

Table 7: Digital inputs

5.8 Analog inputs (Control panel: Menu PAR -> P6)

Code	Parameter	Min	Max	Unit	Default	ID	Note
P6.1	AI1 Signal range	0	1		0	379	0 = 0 - 100% (0 - 10 V) 1 = 20% - 100% (2 - 10 V)
P6.2	AI1 Custom min	-100.00	100.00	%	0.00	380	0.00 = No min scaling
P6.3	AI1 Custom max	-100.00	300.00	%	100.00	381	100.00 = No max scaling
P6.4	AI1 filter time	0.0	10.0	s	0.1	378	0 = no filtering
P6.5	AI2 signal range	0	1		0	390	See P6.1
P6.6	AI2 Custom min	-100.00	100.00	%	0.00	391	See P6.2
P6.7	AI2 Custom max	-100.00	300.00	%	100.00	392	See P6.3
P6.8	AI2 filter time	0.0	10.0	s	0.1	389	See P6.4
P6.9	AIE1 Signal range	0	1		0	143	See P6.1, hidden until an option board is connected
P6.10	AIE1 Custom Min	-100.00	100.00	%	0.00	144	See P6.2, hidden until an option board is connected
P6.11	AIE1 Custom Max	-100.00	300.00	%	100.00	145	See P6.3, hidden until an option board is connected
P6.12	AIE1 Filter time	0.0	10.0	s	0.1	142	See P6.4, hidden until an option board is connected

Table 8: Analog inputs

5.9 Pulse train/Encoder (Control panel: Menu PAR -> P7)

Code	Parameter	Min	Max	Unit	Default	ID	Note
P7.1	Min pulse frequency	0	10000	Hz	0	1229	Pulse frequency to be interpreted as a 0% signal.
P7.2	Max pulse frequency	0.0	10000	Hz	10000	1230	Pulse frequency to be interpreted as a 100% signal.
P7.3	Freq ref at min pulse freq	0.00	P3.2	Hz	0.00	1231	Frequency corresponds to 0% if used as frequency reference.
P7.4	Freq ref at max pulse freq	0.00	P3.2	Hz	50.00 / 60.00	1232	Frequency corresponds to 100% if used as frequency reference.
P7.5	Encoder direction	0	2		0	1233	0 = Disable 1 = Enable/Normal 2 = Enable/Inverted
P7.6	Encoder pulses / revolution	1	65535	ppr	256	629	Pulse count of encoder per round. Used to scale encoder rpm monitor value only.
P7.7	Config DI5 and DI6	0	2		0	1165	0 = DI5 and DI6 are for normal digital input 1 = DI6 is for pulse train 2 = DI5 and DI6 are for encoder frequency mode

Table 9: Pulse train/Encoder

5.10 Digital outputs (Control panel: Menu PAR -> P8)

Code	Parameter	Min	Max	Unit	Default	ID	Selections
P8.1	RO1 signal selection	0	Varies		2	313	0 = Not used 1 = Ready 2 = Run 3 = Fault 4 = Fault Inverted 5 = Warning 6 = Reversed 7 = At Speed 8 = Motor regulator active 9 = FB Control Word B13 10 = FB Control Word B14 11 = FB Control Word B15 12 = Output freq superv 13 = Output torque superv 14 = Unit temperature superv 15 = Analog input superv 16 = Preset Speed Active 17 = External Brake Ctrl 18 = Keypad control active 19 = I/O control active 20 = Temperature supervision
P8.2	RO2 signal selection	0	Varies		3	314	See 8.1
P8.3	DO1 signal selection	0	Varies		1	312	See 8.1
P8.4	RO2 inversion	0	1		0	1588	0 = No inversion 1 = Inverted
P8.5	RO2 ON delay	0.00	320.00	s	0.00	460	0.00 = No delay
P8.6	RO2 OFF delay	0.00	320.00	s	0.00	461	0.00 = No delay
P8.7	RO1 inversion	0	1		0	1587	0 = No inversion 1 = Inverted
P8.8	RO1 ON delay	0.00	320.00	s	0.00	458	0.00 = No delay
P8.9	RO1 OFF delay	0.00	320.00	s	0.00	459	0.00 = No delay
P8.10	DOE1 signal selection	0	Varies		0	317	See 8.1, hidden until an option board is connected
P8.11	DOE2 signal selection	0	Varies		0	318	See 8.1, hidden until an option board is connected
P8.12	DOE3 signal selection	0	Varies		0	1386	See 8.1, hidden until an option board is connected

Table 10: Digital outputs

Code	Parameter	Min	Max	Unit	Default	ID	Selections
P8.13	DOE4 signal selection	0	Varies		0	1390	See 8.1, hidden until an option board is connected
P8.14	DOE5 signal selection	0	Varies		0	1391	See 8.1, hidden until an option board is connected
P8.15	DOE6 signal selection	0	Varies		0	139	See 8.1, hidden until an option board is connected

Table 10: Digital outputs

5.11 Analog outputs (Control panel: Menu PAR -> P9)

Code	Parameter	Min	Max	Unit	Default	ID	Selections
P9.1	Analog output signal selection	0	14		1	307	0 = Not used 1 = Output freq ($0-f_{max}$) 2 = Output current ($0-I_{nMotor}$) 3 = Motor torque ($0-T_{nMotor}$) 4 = PID output (0 - 100%) 5 = Freq refer. ($0-f_{max}$) 6 = Motor speed ($0-n_{max}$) 7 = Motor power ($0-P_{nMotor}$) 8 = Motor voltage ($0-U_{nMotor}$) 9 = DC link voltage (0 - 1000 V) 10 = Process Data In1 (0 - 10000) 11 = Process Data In2 (0 - 10000) 12 = Process Data In3 (0 - 10000) 13 = Process Data In4 (0 - 10000) 14 = Test 100%
P9.2	Analog output minimum	0	1		0	310	0 = 0 V/0 mA 1 = 2 V/4 mA
P9.3	Analog output scaling	0.0	1000.0	%	100.0	311	Scaling factor
P9.4	Analog output filter time	0.00	10.00	s	0.10	308	Filter time
P9.5	Analog output E1 signal selection	0	14		0	472	See P9.1, hidden until an option board is connected
P9.6	Analog output E1 minimum	0	1		0	475	See P9.2, hidden until an option board is connected

Table 11: Analog outputs

Code	Parameter	Min	Max	Unit	Default	ID	Selections
P9.7	Analog output E1 scaling	0.0	1000.0	%	100.0	476	See P9.3, hidden until an option board is connected
P9.8	Analog output E1 filter time	0.00	10.00	s	0.10	473	See P9.4, hidden until an option board is connected
P9.9	Analog output E2 signal selection	0	14		0	479	See P9.1, hidden until an option board is connected
P9.10	Analog output E2 minimum	0	1		0	482	See P9.2, hidden until an option board is connected
P9.11	Analog output E2 scaling	0.0	1000.0	%	100.0	483	See P9.3, hidden until an option board is connected
P9.12	Analog output E2 filter time	0.00	10.00	s	0.10	480	See P9.4, hidden until an option board is connected

Table 11: Analog outputs

5.12 Fieldbus Data-Mapping (Control panel: Menu PAR -> P10)

Code	Parameter	Min	Max	Unit	Default	ID	Note
P10.1	FB Data Output 1 selection	0	Varies		0	852	0 = Frequency reference 1 = Output reference 2 = Motor speed 3 = Motor current 4 = Motor voltage 5 = Motor torque 6 = Motor power 7 = DC link voltage 8 = Active fault code 9 = Analog AI1 10 = Analog AI2 11 = Digital input state 12 = PID feedback value 13 = PID setpoint 14 = Pulse train/encoder input(%) 15 = Pulse train/encoder pulse() 16 = AIE1
P10.2	FB Data Output 2 selection	0	Varies		1	853	Variable mapped on PD2
P10.3	FB Data Output 3 selection	0	Varies		2	854	Variable mapped on PD3
P10.4	FB Data Output 4 selection	0	Varies		4	855	Variable mapped on PD4
P10.5	FB Data Output 5 selection	0	Varies		5	856	Variable mapped on PD5
P10.6	FB Data Output 6 selection	0	Varies		3	857	Variable mapped on PD6
P10.7	FB Data Output 7 selection	0	Varies		6	858	Variable mapped on PD7
P10.8	FB Data Output 8 selection	0	Varies		7	859	Variable mapped on PD8
P10.9	Aux CW Data In selection	0	5		0	1167	PDI for Aux CW 0 = Not used 1 = PDI1 2 = PDI2 3 = PDI3 4 = PDI4 5 = PDI5

Table 12: Fieldbus Data-Mapping

5.13 Prohibited Frequencies (Control panel: Menu PAR -> P11)

Code	Parameter	Min	Max	Unit	Default	ID	Note
P11.1	Prohibit Frequency Range 1 Low Limit	0.00	P3.2	Hz	0.00	509	Low Limit 0.00 = Not used
P11.2	Prohibit Frequency Range 1 High Limit	0.00	P3.2	Hz	0.00	510	High Limit 0.00 = Not used
P11.3	Prohibit Frequency Range 2 Low Limit	0.00	P3.2	Hz	0.00	511	Low Limit 0.00 = Not used
P11.4	Prohibit Frequency Range 2 High Limit	0.00	P3.2	Hz	0.00	512	High Limit 0.00 = Not used

Table 13: Prohibited Frequencies

5.14 Limit Supervisions (Control panel: Menu PAR -> P12)

Code	Parameter	Min	Max	Unit	Default	ID	Note
P12.1	Output freq supervision function	0	2		0	315	0 = Not used 1 = Low limit 2 = High limit
P12.2	Output freq supervision limit	0.00	P3.2	Hz	0.00	316	Output frequency supervision threshold
P12.3	Torque supervision function	0	2		0	348	0 = Not used 1 = Low limit 2 = High limit
P12.4	Torque supervision limit	0.0	300.0	%	0.0	349	Torque supervision threshold
P12.5	Unit Temperature Supervision	0	2		0	354	0 = Not used 1 = Low limit 2 = High limit
P12.6	Unit Temperature Supervision Limit	-10	100	°C	40	355	Unit temperature supervision threshold
P12.7	Analog input superv signal	0	Varies		0	356	0 = AI1 1 = AI2 2 = AIE1
P12.8	AI superv ON level	0.00	100.00	%	80.00	357	ON threshold AI superv.
P12.9	AI superv OFF level	0.00	100.00	%	40.00	358	OFF threshold AI superv.

Table 14: Limit Supervisions

Code	Parameter	Min	Max	Unit	Default	ID	Note
P12.10	Temperature supervision input	1	7		1	1431	Binary-code selection of signals to use for temperature supervision B0 = Temperature input 1 B1 = Temperature input 2 B2 = Temperature input 3 NOTE: Hidden until an option board is connected
P12.11	Temperature supervision function	0	2		2	1432	See 12.1, hidden until an option board is connected
P12.12	Temperature supervision limit	-50.0/ 223.2	200.0/ 473.2		80.0	1433	Temperature supervision threshold; hidden until an option board is connected

Table 14: Limit Supervisions

5.15 Protections (Control panel: Menu PAR -> P13)

Code	Parameter	Min	Max	Unit	Default	ID	Note
P13.1	Analog Input low fault	0	4		1	700	0 = No action 1 = Alarm 2 = Alarm, preset alarm frequency 3 = Fault: Stop function 4 = Fault: Coast
P13.2	Undervoltage fault	1	2		2	727	1 = No response (no fault generated but drive still stops modulation) 2 = Fault:Coast
P13.3	Earth fault	0	3		2	703	0 = No action 1 = Alarm 2 = Fault: Stop function 3 = Fault: Coast
P13.4	Output Phase Fault	0	3		2	702	See 13.3
P13.5	Stall protection	0	3		0	709	See 13.3
P13.6	Under load protection	0	3		0	713	See 13.3
P13.7	Motor thermal protection	0	3		2	704	See 13.3

Table 15: Protections

Code	Parameter	Min	Max	Unit	Default	ID	Note
P13.8	Mtp: Ambient temperature	-20	100	°C	40	705	Environment temperature
P13.9	Mtp: Zero speed cooling	0.0	150.0	%	40.0	706	Cooling as % at 0 speed
P13.10	Mtp: Thermal time constant	1	200	min	Varies	707	Motor thermal time constant
P13.11	Stall Current	0.00	2.0 x I _{Nunit}	A	I _{Nunit}	710	For a stall stage to occur, the current must have exceeded this limit
P13.12	Stall time	0.00	300.00	s	15.00	711	Stall time limited
P13.13	Stall frequency	0.10	320.00	Hz	25.00	712	Stall min frequency
P13.14	UL:Field weakening load	10.0	150.0	%	50.0	714	Minimum torque at field weakening
P13.15	UL:Zero freq load	5.0	150.0	%	10.0	715	Minimum torque at f0
P13.16	UL:Time limit	1.0	300.0	s	20.0	716	This is the maximum time allowed for an underload state to exist
P13.17	Analog Input low fault delay	0.0	10.0	s	0.5	1430	Delay time for analog input low fault
P13.18	External fault	0	3		2	701	0 = No action 1 = Alarm 2 = Fault: Stop function 3 = Fault: Coast
P13.19	Fieldbus fault	0	4		3	733	See 13.1
P13.20	Preset alarm frequency	P3.1	P3.2	Hz	25.00	183	Frequency used when fault response is Alarm + preset Frequency
P13.21	Parameters edit lock	0	1		0	819	0 = Edit enabled 1 = Edit disabled
P13.22	Thermistor Fault	0	3		2	732	0 = No action 1 = Alarm 2 = Fault: Stop function 3 = Fault: Coast Hidden until an option board is connected
P13.23	FWD/REV conflict supervision	0	3		1	1463	See P13.3
P13.24	Temperature fault	0	3		0	740	See P13.3, hidden until an OPTBH board is connected

Table 15: Protections

Code	Parameter	Min	Max	Unit	Default	ID	Note
P13.25	Temperature fault input	1	7		1	739	Binary code selection of signals to use for alarm and fault triggering B0 = Temperature input 1 B1 = Temperature input 2 B2 = Temperature input 3 NOTE: Hidden until an OPTBH board is connected
P13.26	Temperature fault mode	0	2		2	743	0 = Not used 1 = Low limit 2 = High limit
P13.27	Temperature fault limit	-50.0/ 223.2	200.0/ 473.2		100.0	742	Temperature fault threshold; hidden until an OPTBH board is connected
P13.28	Input phase fault*	0	3		3	730	As parameter P13.3
P13.29	Motor temperature memory mode*	0	2		2	15521	0 = disabled 1 = constant mode 2 = last value mode

Table 15: Protections

NOTE:

* These parameters are only available in power SW FWP00001V026 included in FW01070V010 or later version.

NOTE: These parameters are shown when **P17.2 = 0**.

5.16 Fault autoreset parameters (Control panel: Menu PAR -> P14)

Code	Parameter	Min	Max	Unit	Default	ID	Note
P14.1	Automatic Reset	0	1		0	731	0 = Disabled 1 = Enable
P14.2	Wait time	0.10	10.00	s	0.50	717	Waiting time after fault
P14.3	Trial time	0.00	60.00	s	30.00	718	Maximum time for trials
P14.4	Trials number	1	10		3	759	Maximum trials
P14.5	Restart Function	0	2		2	719	0 = Ramping 1 = Flying 2 = From Start Function

Table 16: Fault autoreset parameters

NOTE: These parameters are shown when **P17.2 = 0**.

5.17 PID control parameters (Control panel: Menu PAR -> P15)

Code	Parameter	Min	Max	Unit	Default	ID	Note
P15.1	Setpoint source selection	0	Varies		0	332	0 = Fixed setpoint % 1 = AI1 2 = AI2 3 = ProcessDataIn1 (0 - 100%) 4 = ProcessDataIn2 (0 - 100%) 5 = ProcessDataIn3 (0 - 100%) 6 = ProcessDataIn4 (0 - 100%) 7 = Pulse train/encoder 8 = AIE1 9 = Temperature input 1 10 = Temperature input 2 11 = Temperature input 3
P15.2	Fixed setpoint	0.0	100.0	%	50.0	167	Fixed setpoint
P15.3	Fixed setpoint 2	0.0	100.0	%	50.0	168	Alternative fixed setpoint, selectable with DI
P15.4	Feedback source selection	0	Varies		1	334	0 = AI1 1 = AI2 2 = ProcessDataIn1 (0 - 100%) 3 = ProcessDataIn2 (0 - 100%) 4 = ProcessDataIn3 (0 - 100%) 5 = ProcessDataIn4 (0 - 100%) 6 = AI2-AI1 7 = Pulse train/encoder 8 = AIE1 9 = Temperature input 1 10 = Temperature input 2 11 = Temperature input 3
P15.5	Feedback value minimum	0.0	50.0	%	0.0	336	Value at minimum signal
P15.6	Feedback value maximum	10.0	300.0	%	100.0	337	Value at maximum signal
P15.7	P gain	0.0	1000.0	%	100.0	118	Proportional gain
P15.8	I time	0.00	320.00	s	10.00	119	Integrative time

Table 17: PID control parameters

Code	Parameter	Min	Max	Unit	Default	ID	Note
P15.9	D time	0.00	10.00	s	0.00	132	Derivative time
P15.10	Error inversion	0	1		0	340	0 = Direct (Feedback < Setpoint -> Increase PID output) 1 = Inverted (Feedback > Setpoint -> Decrease PID output)
P15.11	Sleep minimum frequency	0.00	P3.2	Hz	25.00	1016	Drive goes into sleep mode when the output frequency remains below this limit for a time greater than that defined by parameter Sleep delay
P15.12	Sleep delay	0	3600	s	30	1017	Delay to enter sleep mode
P15.13	Wake-up error	0.0	100.0	%	5.0	1018	Threshold to exit sleep mode
P15.14	Sleep setpoint boost	0.0	50.0	%	10.0	1071	Referred to setpoint
P15.15	Setpoint boost time	0	60	s	10	1072	Boost time after P15.12
P15.16	Sleep maximum loss	0.0	50.0	%	5.0	1509	Referred to feedback value after boost
P15.17	Sleep loss check time	1	300	s	30	1510	After boost time P15.15
P15.18	Process unit source select	0	6		0	1513	0 = PID feedback value 1 = Output frequency 2 = Motor speed 3 = Motor torque 4 = Motor power 5 = Motor current 6 = Pulse train/encoder
P15.19	Process unit decimal digits	0	3		1	1035	Decimals on display
P15.20	Process unit minimum value	0.0	P15.21		0.0	1033	Process min value
P15.21	Process unit maximum value	P15.20	3200.0		100.0	1034	Process max value

Table 17: PID control parameters

Code	Parameter	Min	Max	Unit	Default	ID	Note
P15.22	Temperature min value	-50.0/ 223.2	P15.23		0.0	1706	Temperature min value for PID and frequency reference scale; hidden until an OPTBH board is connected
P15.23	Temperature max value	P15.22	200.0/ 473.2		100.0	1707	Temperature max value for PID and frequency reference scale; hidden until an OPTBH board is connected

Table 17: PID control parameters

NOTE: These parameters are shown when **P17.2 = 0**.

5.18 Motor c (Control panel: Menu PAR -> P16)

Code	Parameter	Min	Max	Unit	Default	ID	Note
P16.1	Motor Preheat Function	0	2		0	1225	0 = Not used 1 = Always in stop state 2 = Controlled by digital input
P16.2	Motor Preheat Current	0	0.5 x I _{Nunit}	A	0	1227	DC current for preheating motor and drive in stop state. Active in stop state or by digital input while in stop state.

Table 18: Motor Preheat

5.19 Easy usage menu (Control panel: Menu PAR -> P17)

Code	Parameter	Min	Max	Unit	Default	ID	Note
P17.1	Application Type	0	3		0	540	0 = Basic 1 = Pump 2 = Fan drive 3 = High Torque NOTE: Visible only when the startup wizard is active.
P17.2	Parameter conceal	0	1		1	115	0 = All parameters visible 1 = Only quick setup parameter group visible
P17.3	Temperature unit	0	1		0	1197	0 = Celsius 1 = Kelvin NOTE: Hidden until an OPTBH board is connected

Table 19: Easy usage menu parameters

Code	Parameter	Min	Max	Unit	Default	ID	Note
P17.4	Application access password*	0	30000		0	2362	Input the right password could review parameter group 18.

Table 19: Easy usage menu parameters

NOTE:

* These parameters are only available in power SW FWP00001V026 included in FW01070V010 or later version.

5.20 System parameters

Code	Parameter	Min	Max	Default	ID	Note
Software information (MENU SYS -> V1)						
V1.1	API SW ID				2314	
V1.2	API SW version				835	
V1.3	Power SW ID				2315	
V1.4	Power SW version				834	
V1.5	Application ID				837	
V1.6	Application revision				838	
V1.7	System load				839	
When no fieldbus Option Board or no OPT-BH Board is installed, the Modbus comm. parameters are as follows						
V2.1	Communication status				808	Status of Modbus communication. Format: xx.yyy where xx = 0 - 64 (number of error messages) yyy = 0 - 999 (number of good messages)
P2.2	Fieldbus protocol	0	1	0	809	0 = Not used 1 = Modbus used
P2.3	Slave address	1	255	1	810	Default setting: None parity, 1 stop bit
P2.4	Baud rate	0	8	5	811	0 = 300 1 = 600 2 = 1200 3 = 2400 4 = 4800 5 = 9600 6 = 19200 7 = 38400 8 = 57600

Table 20: System parameters

Code	Parameter	Min	Max	Default	ID	Note
P2.6	Parity type	0	2	0	813	0 = None 1 = Even 2 = Odd The Stop Bit is 2-bit when Parity type is 0 = None; The Stop Bit is 1-bit when Parity type is 1 = Even or 2 = Odd
P2.7	Communication timeout	0	255	10	814	0 = Not used 1 = 1 sec 2 = 2 sec, etc.
P2.8	Reset communication status	0	1	0	815	
When the Canopen E6 board is installed, the comm. parameters are as follows						
V2.1	Canopen communication status				14004	0 = Initializing 4 = Stopped 5 = Operational 6 = Pre_Operational 7 = Reset_Application 8 = Reset_Comm 9 = Unknow
P2.2	Canopen operation mode	1	2	1	14003	1 = Driver Profile 2 = Bypass
P2.3	Canopen Node ID	1	127	1	14001	
P2.4	Canopen baud rate	3	8	6	14002	3 = 50 kbaud 4 = 100 kbaud 5 = 125 kbaud 6 = 250 kbaud 7 = 500 kbaud 8 = 1000 kbaud
When the DeviceNet E7 board is installed, the comm. parameters are as follows						

Table 20: System parameters

Code	Parameter	Min	Max	Default	ID	Note
V2.1	Communication status				14014	Status of Modbus communication. Format: XXXX.Y, X = DeviceNet msg counter Y = DeviceNet status 0 = Non-existent or no bus power 1 = Configuring state 2 = Established 3 = Timeout
P2.2	Output assembly type	20	111	21	14012	20, 21, 23, 25, 101, 111
P2.3	MAC ID	0	63	63	14010	
P2.4	Baud rate	1	3	1	14011	1 = 125 kbit/s 2 = 250 kbit/s 3 = 500 kbit/s
P2.5	Input assembly type	70	117	71	14013	70, 71, 73, 75, 107, 117
When the ProfidBus E3/E5 board is installed, the comm. parameters are as follows						
V2.1	Communication status				14022	
V2.2	Fieldbus protocol status				14023	
V2.3	Active protocol				14024	
V2.4	Active baud rate				14025	
V2.5	Telegram type				14027	
P2.6	Operate mode	1	3	1	14021	1 = Profidrive 2 = Bypass 3 = Echo
P2.7	Slave address	2	126	126	14020	
When the OPT-BH board is installed, the comm. parameters are as follows						
P2.1	Sensor 1 type	0	6	0	14072	0 = No Sensor 1 = PT100 2 = PT1000 3 = Ni1000 4 = KTY84 5 = 2 x PT100 6 = 3 x PT100

Table 20: System parameters

Code	Parameter	Min	Max	Default	ID	Note
P2.2	Sensor 2 type	0	6	0	14073	0 = No Sensor 1 = PT100 2 = PT1000 3 = Ni1000 4 = KTY84 5 = 2 x PT100 6 = 3 x PT100
P2.3	Sensor 3 type	0	6	0	14074	0 = No Sensor 1 = PT100 2 = PT1000 3 = Ni1000 4 = KTY84 5 = 2 x PT100 6 = 3 x PT100
When OPT-EC panel has been installed ,the comm. Parameters are as follows						
V2.1	version No.			0		Version No. of the panel software
V2.2	Panel status			0		State of the OPT-EC panel application
Other information						
V3.1	MWh counter				827	Million watt hour
V3.2	Power on days				828	
V3.3	Power on hours				829	
V3.4	Run counter: Days				840	
V3.5	Run counter: Hours				841	
V3.6	Fault counter				842	
V3.7	Panel parameter set status monitor					Hidden when connected to PC.
P4.2	Restore factory defaults	0	1	0	831	1 = Restores factory defaults for all parameters
P4.3	Password	0000	9999	0000	832	
P4.4	Time for panel and LCD backlight active	0	99	5	833	

Table 20: System parameters

Code	Parameter	Min	Max	Default	ID	Note
P4.5	Save parameter set to panel	0	1	0		Hidden when connected to PC.
P4.6	Restore parameter set from panel	0	1	0		Hidden when connected to PC.
F5.x	Active Fault menu					
F6.x	Fault History menu					

Table 20: System parameters

6. FAULT TRACING

Fault code	Fault name	Fault code	Fault name
1	Overcurrent	27	Back EMF protection
2	Overvoltage	29	Thermistor fault
3	Earth fault	34	Internal bus communication
8	System fault	35	Application fault
9	Undervoltage	41	IGBT Overtemperature
11	Output phase fault	50	Analog input select 20% - 100% (selected signal range 4 to 20 mA or 2 to 10 V)
13	Frequency converter undertemperature	51	External fault
14	Frequency converter overtemperature	52	Door panel fault
15	Motor stalled	53	Fieldbus fault
16	Motor overtemperature	54	Slot fault
17	Motor underload	55	Wrong run fault (FWD/REV conflict)
22	EEPROM checksum fault	57	Identification fault
25	Microcontroller watchdog fault	111	Temperature fault

Table 1: Fault codes. See the User Manual for detailed fault descriptions.

7. GENERAL DATA

Dimensions and weight	Frame	Height (mm)		Width (mm)		Depth (mm)		Weight (kg)	
		mm	inch	mm	inch	mm	inch	kg	lb.
	MI1	157	6.2	66	2.6	98	3.9	0.5	1.1
	MI2	195	7.7	90	3.5	102	4	0.7	1.5
	MI3	262	10.3	100	3.9	109	4.3	1	2.2
	MI4	370	14.6	165	6.5	165	6.5	8	17.6
	MI5	414	16.3	165	6.5	202	8	10	22
Supply network	Networks	Vacon 20 units cannot be used on delta power networks (corner grounded) with any other filter combination than EMC4							
	Short circuit current	The maximum short circuit current must be < 50 kA. For MI4 without DC-choke, the maximum short circuit current must be < 2.3 kA. For MI5 without DC-choke, the maximum short circuit current must be < 3.8 kA							
Motor connection	Output voltage	0 - U_{in}							
	Output current	Continuous rated current I_N at ambient temperature max +50°C (depends on the unit size), overload 1.5 x I_N max 1 min / 10 min							
Control connection	Digital input	Positive, Logic1: 18...+30V, Logic0: 0...5V; Negative, Logic1: 0...10V, Logic0: 18...30V; $R_i = 10K\Omega$ (floating)							
	Analog input voltage	0...+10V, $R_i = 250K\Omega$							
	Analog input current	0(4)...20mA, $R_i \leq 250\Omega$							
	Analog output	0...10V, $R_L \geq 1K\Omega$; 0(4)...20mA, $R_L \leq 500\Omega$, Selectable via micro-switch							
	Digital output	Open collector, max. load 35V/50mA (floating)							
	Relay output	Switching load: 250Vac/3A, 24V DC 3A							
	Auxiliary voltage	$\pm 20\%$, max. load 50mA							
Ambient conditions	Ambient operating temperature	-10 °C (no frost)...+40/50 °C (depends on the unit size): rated load-ability I_N When the MI1-3 is installed side-by-side, the ambient operating temperature is always 40 °C. This also applies to the IP21/Nema1 option in MI1-3.							
	Storage temperature	-40 °C...+70 °C							
	Relative humidity	0...95% RH, non-condensing, non-corrosive, no dripping water							
	Altitude	100% load capacity (no derating) up to 1000 m; 1% derating for each 100 m above 1000 m; max 2000 m							
	Enclosure class	IP20/IP21/Nema1 for MI1-3, IP21/Nema1 for MI4-5							
	Pollution degree	PD2							

EMC	Immunity	Complies with EN50082-1, -2, EN61800-3
	Emissions [see detailed descriptions in Vacon 20 User Manual at www.vacon.com]	230 V: complies with EMC category C2; with internal RFI filter. MI4 and 5 comply with C2; with optional DC choke and CM choke. 400V: Complies with EMC category C2; with internal RFI filter. MI4 and 5 comply with C2; with optional DC choke and CM choke. Both: No EMC emission protection (Vacon level N); without RFI filter.
Standards		For EMC: EN61800-3, For safety: UL508C, EN61800-5
Certificates and manufacturer's declarations of conformity		For safety: CE, UL, cUL, KC For EMC: CE, KC (see unit nameplate for more detailed approvals)

	Frame	Fuse (A)	Mains cable Cu (mm ²)	Terminal cable min-max [mm ²]			
				Main	Earth	Control and relay	
Cable and fuse requirements (see detailed data in Vacon 20 User Manual at www.vacon.com) 380 - 480 V, 3~ 208 - 240 V, 3~	MI1	6	3*1.5+1.5	1.5-4			
	MI2	10					
	MI3	20	3*2.5+2.5	1.5-6			
	MI4	20 25 40 (20 and 40 is only for 208 - 240 V, 3~)	3*6+6	1-10 Cu	1-10	0.5-1.5	
	MI5	40	3*10+10	2.5-50 Cu/Al	2.5-35		
115 V, 1~	MI2	20	2*2.5+2.5	1.5-4			
	MI3	32	2*6+6				
208 - 240, 1~	MI1	10	2*1.5+1.5				1.5-6
	MI2	20	2*2.5+2.5				
	MI3	32	2*6+6				
600 V	MI3	6	3*1.5+1.5	1.5-4			
	MI3	10					
	MI3	20	3*2.5+2.5	1.5-6			

- The drive can be connected to the power supply with the above-mentioned fuses.
The short circuit current of the power supply cannot exceed 50 kA
- Use cables with heat resistance of at least +70 °C.
- The fuses also function as cable overload protection.
- These instructions only apply to cases with one motor and one cable connection from the frequency converter to the motor.
- In order to comply with standard EN61800-5-1, the protective conductor should be **at least 10 mm² Cu or 16 mm² Al**. Another option is to use an additional protective conductor of at least the same size as the original one.

Vacon 20 power ratings

Mains voltage 208 - 240 V, 50/60 Hz, 1~ series							
Frequency converter type	Rated loadability		Motor shaft power		Nominal input current [A]	Mechanical size	Weight [kg]
	100% continuous current I _N [A]	150% over-load current [A]	P [HP]	P [KW]			
0001	1.7	2.6	0.33	0.25	4.2	M11	0.55
0002	2.4	3.6	0.5	0.37	5.7	M11	0.55
0003	2.8	4.2	0.75	0.55	6.6	M11	0.55
0004	3.7	5.6	1	0.75	8.3	M12	0.7
0005	4.8	7.2	1.5	1.1	11.2	M12	0.7
0007	7	10.5	2	1.5	14.1	M12	0.7
0009*	9.6	14.4	3	2.2	22.1	M13	0.99

Table 1: Vacon 20 power ratings, 208 - 240 V

* The maximum ambient operating temperature of this drive is 40 °C!

Mains voltage 208 - 240 V, 50/60 Hz, 3~ series							
Frequency converter type	Rated loadability		Motor shaft power		Nominal input current [A]	Mechanical size	Weight [kg]
	100% continuous current I _N [A]	150% over-load current [A]	P [HP]	P [KW]			
0001	1.7	2.6	0.33	0.25	2.7	M11	0.55
0002	2.4	3.6	0.5	0.37	3.5	M11	0.55
0003	2.8	4.2	0.75	0.55	3.8	M11	0.55
0004	3.7	5.6	1	0.75	4.3	M12	0.7
0005	4.8	7.2	1.5	1.1	6.8	M12	0.7
0007*	7	10.5	2	1.5	8.4	M12	0.7
0011*	11	16.5	3	2.2	13.4	M13	0.99
0012	12.5	18.8	4	3	14.2	M14	9
0017	17.5	26.3	5	4	20.6	M14	9
0025	25	37.5	7.5	5.5	30.3	M14	9
0031	31	46.5	10	7.5	36.6	M15	11
0038	38	57	15	11	44.6	M15	11

Table 2: Vacon 20 power ratings, 208 - 240 V, 3~

*The maximum ambient operating temperature for this drive is +40°C !

Mains voltage 115 V, 50/60 Hz, 1~ series							
Fre- quency converter type	Rated loadability		Motor shaft power		Nominal input cur- rent [A]	Mechanical size	Weight [Kg]
	100% contin- uous current I_N [A]	150% over- load current [A]	P [HP]	P [KW]			
0001	1.7	2.6	0.33	0.25	9.2	MI2	0.7
0002	2.4	3.6	0.5	0.37	11.6	MI2	0.7
0003	2.8	4.2	0.75	0.55	12.4	MI2	0.7
0004	3.7	5.6	1	0.75	15	MI2	0.7
0005	4.8	7.2	1.5	1.1	16.5	MI3	0.99

Table 3: Vacon 20 power ratings, 115 V, 1~

Mains voltage 380 - 480 V, 50/60 Hz, 3~ series							
Fre- quency converter type	Rated loadability		Motor shaft power		Nominal input cur- rent [A]	Mechanical size	Weight [kg]
	100% contin- uous current I_N [A]	150% over- load current [A]	P [HP]	P [KW]			
0001	1.3	2	0.5	0.37	2.2	MI1	0.55
0002	1.9	2.9	0.75	0.55	2.8	MI1	0.55
0003	2.4	3.6	1	0.75	3.2	MI1	0.55
0004	3.3	5	1.5	1.1	4	MI2	0.7
0005	4.3	6.5	2	1.5	5.6	MI2	0.7
0006	5.6	8.4	3	2.2	7.3	MI2	0.7
0008	7.6	11.4	4	3	9.6	MI3	0.99
0009	9	13.5	5	4	11.5	MI3	0.99
0012	12	18	7.5	5.5	14.9	MI3	0.99
0016	16	24	10	7.5	17.1	MI4	9
0023	23	34.5	15	11	25.5	MI4	9
0031	31	46.5	20	15	33	MI5	11
0038	38	57	25	18.5	41.7	MI5	11

Table 4: Vacon 20 power ratings, 380 - 480 V

Mains voltage 600 V, 50/60 Hz, 3~ series							
Fre- quency converter type	Rated loadability		Motor shaft power		Nominal input cur- rent [A]	Mechanical size	Weight (kg)
	100% continu- ous current I_N [A]	150% over- load current [A]	P [HP]	P [KW]			
0002	1.7	2.6	1	0.75	2	MI3	0.99
0003	2.7	4.2	2	1.5	3.6	MI3	0.99
0004	3.9	5.9	3	2.2	5	MI3	0.99
0006	6.1	9.2	5	4	7.6	MI3	0.99
0009	9	13.5	7.5	5.5	10.4	MI3	0.99

Table 5: Vacon 20 power ratings, 600 V

Note 1: The input currents are calculated values with 100 kVA line transformer supply.

Note 2: For PM engine, please select the drive power rating according to engine shaft power, not rated current.

Quick Modbus setup

1	A: Select Fieldbus as remote control place: P2.1 to 1 – Fieldbus B: Set Modbus RTU protocol to "ON:" SYS P2.2 to 1 – Modbus
2	A. Set Control Word to "0" (2001) B. Set Control Word to "1" (2001) C. Frequency converter status is RUN D. Set Reference value to "5000" (50.00%) (2003) E. Actual Speed is 5000 (25.00 Hz if MinFreq is 0.00 Hz and MaxFreq is 50.00 Hz) F. Set Control Word to "0" (2001) G. Frequency converter status is STOP

VACON[®]

DRIVEN BY DRIVES

Find your nearest Vacon office
on the Internet at:

www.vacon.com

Manual authoring:
documentation@vacon.com

Vacon Plc.
Runsorintie 7
65380 Vaasa
Finland

Subject to change without prior notice
© 2013 Vacon Plc.

Document ID:



Rev. F1